

IBM® TotalStorage® LTO Ultrium Tape Drive



# SCSI Reference

**Note**

Before using this manual and the product it supports, read the information under Annex F. Notices.

Sixth Edition (28 February 2022)

This edition applies to the *IBM System Storage LTO Ultrium Tape Drive SCSI Reference* and to all subsequent releases and modifications unless otherwise indicated in new editions.

**Copyright International Business Machines Corporation 2011, 2017, 2020, 2021, 2022.**

US Government Users Restricted Rights -- Use, duplication or disclosure restricted by GSA ADP Schedule Contract with IBM Corp.

## 0. Read This First

This is the Sixth Edition of the *IBM System Storage LTO Tape Drive SCSI Reference*.

### 0.1 Summary of Changes

#### 0.1.1 First Edition, April 2011

The *IBM System Storage LTO Ultrium Tape Drive SCSI Reference* describes the SCSI interface for the IBM LTO 1 tape drive through the IBM LTO 4 tape drive. The first edition of the *IBM System Storage LTO Tape Drive SCSI Reference* describes the SCSI interface for the IBM LTO 5 tape drive and does not describe the previous generation tape drives that are described in the *IBM System Storage LTO Ultrium Tape Drive SCSI Reference*.

The list of Functional Change Requests (FCR) applied to the previous generation device (i.e., LTO4) that are included follow:

- FCR 3163r3 - IP Address Information Configuration;
- FCR 3164 - LTO Engineering Log (Buffer ID 06h);
- FCR 3165 - LTO5 - TapeAlert 10h behavior;
- FCR 3167 - Persistent Reserve Out SCOPE field;
- FCR 3173 - Device Attributes Mode Pages;
- FCR 3174r2 - LTO5 - Sleep Mode (Mode Page 1Ah);
- FCR 3175r3 - LTO5 - Partitioning SCSI changes;
- FCR 3176r1 - Encryption Selection mode page;
- FCR 3177 - LTO5 - SCSI Identifier updates;
- FCR 3178r2 - LTO5 - SkipSync;
- FCR 3179r2 - LTO5 - Append-only mode (data-safe);
- FCR 3180r2 - LTO5 - Transport Log & Mode pages;
- FCR 3181 - LTO5 Report Supported OpCode;
- FCR 3183r1 - LTO5 Programmable Early Warning;
- FCR 3184 - LTO5 Volume Statistics log page (17h);
- FCR 3185 - LTO5 Device Statistics log page (14h);
- FCR 3186 - LTO5 Data Compression log page (1Bh);
- FCR 3187 - SPIN & SPOUT (OOBE-KMIP-SSC-4);
- FCR 3188r1 - LTO5 Engineering & Speed log pages;
- FCR 3193 - End of partition behavior control;
- FCR 3194 - SAS TLR count in log pages;
- FCR 3197 - Update standard inquiry version field;
- FCR 3202 - CM from EOD dataset Read Buffer;
- FCR 3205 - Drive Type in Inquiry C0h;
- FCR 3208 - Logical block protection;
- FCR 3212 - LOAD ID for LTO HH V2 drives;

#### 0.1.2 Second Edition, February 2013

The second edition of the *IBM System Storage LTO Tape Drive SCSI Reference* describes the SCSI interface for the IBM LTO 5 and LTO 6 tape drives.

The list of defects and changes applied to the first edition of the *IBM System Storage LTO Tape Drive SCSI Reference* to create this edition follow:

- FCR 3178r5 - Update SkipSync for LTO6. See MP 30h[40h]: SkipSync - Device attribute settings (see 6.6.21.5.1 on page 411)
- FCR 3182r2 - Dynamic Runtime Information clean-up. See READ DYNAMIC RUNTIME ATTRIBUTE - A3h[1Eh] or D1h (see 5.2.19 on page 114), WRITE DYNAMIC RUNTIME ATTRIBUTE - A4h[1Eh] or D2h (see 5.2.45 on page 182), and Dynamic runtime attributes (DRA) (see 6.1 on page 187)
- FCR 3206 - Describe Units of measure used in this document
- FCR 3227 - Make OIR saveable in MP 10h: Device Configuration (see 6.6.11 on page 375)
- FCR 3229 - Deferred Check Condition (DCC) (see 4.19.3 on page 64)
- FCR 3233, FCR 3233r1, FCR 3233r2 - LTO6 SCSI Identifier updates
- FCR 3235 - Add IP B1h: Manufacturer-assigned Serial Number (see 6.3.10 on page 244)
- FCR 3237, FCR 3237r1 - Add READ BLOCK LIMITS maximum logical object identifier data (see 5.2.17.2 on page 113)
- FCR 3240 - Add Remaining Native Capacity to LP 17h: Volume Statistics (see 6.4.14 on page 301)
- FCR 3241 - BOP caching (see 4.5.2 on page 34)
- FCR 3242 - Add LTO6 Encryption Algorithm to SPIN (20h[0010h]) - Data Encryption Capabilities page (see 6.8.2.3 on page 446)
- FCR 3244 - Add create FMR tape and update drive From FMR tape to Supported Page 80h Diags (see 6.2.2 on page 206)
- FCR 3246 - Add OEM Specific Inquiry field
- FCR 3248 - Add LTO6 Timeout values to the Command timeouts descriptor (see 5.2.28.3 on page 147) of the REPORT SUPPORTED OPERATION CODES command
- FCR 3249 - Ignore PS bit on MODE SELECT
- FCR 3250 - Add LOCATE to EOD
- FCR 3251 - Encryption Sense Key changes (see Annex B.)
- FCR 3253 - Partition mode page partition size table mods
- FCR 3256 - Add standardized method for reading drive dumps
- FCR 3257 - Update LP31h for 4 partitions
- FCR 3258 - Tape Diagnostic Data - correct PARAMETER CODE field
- Various corrections of editorial and functional documentation issues.
- 31999 - LTO SCSI Ref: ASC/ASCQ EE31 description should be "Key Unknown" (see Annex B.)

### 0.1.3 Third Edition, 28 September 2015

The third edition of the *IBM System Storage LTO Tape Drive SCSI Reference* describes the SCSI interface for the IBM LTO tape drives from generation 5 and later. The primary purpose of this edition is to document the new LTO 7 drive.

The list of significant defects and changes applied to the second edition of the *IBM System Storage LTO Tape Drive SCSI Reference* to create this edition follow:

- FCR 3260 - Cache Attributes for READ ATTRIBUTES
- FCR 3268 - Add Potential Conflict List and Extended VHF data to LP 11h: DT Device Status (see 6.4.10 on page 269)
- FCR 3271 - Download ucode additions
- FCR 3273 - Add part number to standard inquiry
- FCR 3282 - LTO7 SCSI Identifiers
- FCR 3284 - READ LOGGED-IN HOST TABLE - A3h[1Fh][01h] (see 5.2.21 on page 122)
- FCR 3285 - Add Encr Policy - Rqst Params every reposition to Device Hardware Encryption (see 4.15 on page 54)

FCR 3286 - Add Read Buffer MODE [1Ch] 11h: Mini dump (see 6.7.2.7.3.3 on page 436) and Diag - 0163h: Force Mini Dump (see 6.2.12 on page 216)

FCR 3287 - Extend OEM field of Standard Inquiry

FCR 3289 - Automation Device S/N VPD Page

FCR 3292 - Additional params in LP3Eh

FCR 3293 - READ END OF WRAP POSITION

FCR 3297 - Unique Cartridge Identity (MAM 1001h)

FCR 3299 - Add TA 31h Diminished Native Capacity to Parameter Definitions (2Eh) (see 6.4.18.2 on page 317)

FCR 3302 - Correct MP 1Ch: Informational Exceptions Control (see 6.6.17 on page 390)

FCR 3308 - READ BUFFER non-volatile host buffer

FCR 3309 - Add option to Disable BOP caching (see 4.5.2 on page 34)

FCR 3310 - Describe Mode Page Behaviors (see 4.7 on page 39) that are non-standard

FCR 3311 - Inquiry Allocation Length

FCR 3314 - LTFS MAM parms 0820h & 0821h

FCR 3316 - LTO7 increase counter sizes

FCR 3317 - LTO7 LBP add support for CRC32C

Various corrections of editorial and functional documentation issues.

Added SPIN (00h[0002h]) - Security Compliance Information (see 6.8.1.3 on page 442) and SPIN (20h[0031h]) - Device Server Key Wrapping Public Key page (see 6.8.2.9 on page 461) during review

#### 0.1.4 Fourth Edition, GA32-0928-03, 16 October 2017

The fourth edition of the *IBM System Storage LTO Tape Drive SCSI Reference* describes the SCSI interface for the IBM LTO tape drives from generation 5 and later. The primary purpose of this edition is to document the new LTO 8 drive.

The list of significant defects and changes applied to the third edition of the *IBM System Storage LTO Tape Drive SCSI Reference* to create this edition follow:

Various corrections of editorial and functional documentation issues.

f3255, f3255r1 - Correct LOAD UNLOAD command

f3264 - Terminate Immediate

f3266 - Correct MultiP bit in standard inquiry

f3321 - LBP Support Inquiry B5h

f3327 - LP11 Parm 8001 Medium Encryption Status

f3331 - Encrypt only

f3332 - LTO8+ Volume Personality Scheme

f3333 - Update DRA to support standards

f3334 - Update SCSI Reference with LP12h

f3330, f3330r2 - LTO8 SCSI Identifiers

f3325 - LTO8 Type M SCSI Interface

f3336 - Additional M8 MAM Changes

#### 0.1.5 Fifth Edition, GA32-0928-04, 15 July 2021

The fifth edition of the *IBM System Storage LTO Tape Drive SCSI Reference* describes the SCSI interface for the IBM LTO tape drives from generation 5 and later. The primary purpose of this edition is to document the new LTO 9 drive.

The list of significant defects and changes applied to the fourth edition of the *IBM System Storage LTO Tape Drive SCSI Reference* to create this edition follow:

Various corrections of editorial and functional documentation issues.

35236 - TA 31h clear on load/unload instead of removal (see 6.4.18)

37348 - 4/0302 missing sk/ascq from sense Annex (see B.5.)

37479 - PAMR note about library incorrect (see 5.2.14)

37537 - DOC:0/0019 missing(locate immediate in progress) (see B.1.)

37553 - Correct log pages for missing SAS 12G values (see 6.4.10) and change section style to be consistent with the style used in the SCSI Reference (see 6.4.15).

37623 - POST B diagnostic description should list FSC 52E7 (see 6.2.6)

37691 - Externalize the mode page to set the preferred cartridge type (see 6.6.21.5.4)

FCR 3283r2 - Environmental Conditions Log Page 0Dh[01h] - Temperature and Humidity (see 6.4.9)

FCR 3336r1 - Supported Density Codes Attribute ID change (see 6.5.2.3)

FCR 3337 - Archive Mode setting MP30[43] (see 6.6.21.5.3)

FCR 3339 - Long Erase Timeout adjustments (see 5.2.28.3)

FCR 3344 - LTO SCSI Ref RW Buffer Corrections (see 5.2.18, 5.2.44, and 6.7)

FCR 3346 - Report Optical Transceiver Information (see 6.4.10.1.9)

FCR 3347 - SCSI Reference Log Page Corrections (see 6.4.3)

FCR 3350 - Autoload Mode SCSI Configuration (see 6.6.7)

FCR 3351r1 - IP C1h Drive Serial Numbers (see 6.3.15)

FCR 3356 - Add barcode inquiry page IP C2h (see 6.3.16)

FCR 3360 - Tape Cartridge Type LP11h[8001h] (see 6.4.10.1.11)

FCR 3366 - LTO9 SCSI Identifiers

FCR 3367 - RAO-Open (LTO9) (see 4.6)

FCR 3369 - IDLE\_C Saveable (see 6.6.16)

FCR 3370 - Subcomponent Version List (see 6.3.17)

FCR 3371 - Design Capacity (see 3.4.1)

FCR 3372 - Log Supages (see 6.4)

FCR 3373 - TA23h - Humidity Tape Alert (see 6.4.18)

FCR 3376 - Document cmds that reset idle\_c timer (see 5.1.2)

FCR 3377 - LTO9 Device Stats medium descriptor (see 6.4.12.3.2.1.1)

FCR 3378 - Describe Engineering Log entry formats (see 6.7.2.1 and 6.7.2.2)

FCR 3381 - Partitioning adjustments (see 4.4.2, 6.6.13, and Annex A.)

FCR 3383 - Medium Characterization + format (see 4.1, 5.2.3, and E.3.)

FCR 3384 - LTO Cart Motion Meters MAM Attribute (see 6.5.2.5.5)

FCR 3385 - Update RSOC for TDScal (see 5.2.28.3)

### 0.1.6 Sixth Edition, GA32-0928-05, 22 February 2022

The sixth edition of the *IBM System Storage LTO Tape Drive SCSI Reference* describes the SCSI interface for the IBM LTO tape drives from generation 5 and later. The primary purpose of this edition is to document the additions related to the LTO 9 Half-Height drive.

The list of significant defects and changes applied to the fifth edition of the *IBM System Storage LTO Tape Drive SCSI Reference* to create this edition follow:

- Various corrections of editorial and functional documentation issues.  
Externalized Medium Calibration Audit (see 6.2.9)  
Added Best Practices to the organization list in the Preface (see 1.1)

- FCR 3382 - MAM Attribs for Medium Characterization (see 6.5.2.5, 4.1, and E.3.) made External

- FCR 3391 - IDLE\_C optional 12V disable (see 6.6.16 and 6.6.21.5.3)

- FCR 3392 - LTO9 Cleaning Criteria (see 4.13.3)

- FCR 3393 - ERASE IN PROGRESS ASC/Q (see B.1.)

- FCR 3395 - Clarify Error Counter LPs descriptions (see 6.4.5, 6.4.6, 6.4.22, and 6.4.23)





## Contents

	Page
0. Read This First .....	a
0.1 Summary of Changes .....	a
0.1.1 First Edition, April 2011 .....	a
0.1.2 Second Edition, February 2013 .....	a
0.1.3 Third Edition, 28 September 2015 .....	b
0.1.4 Fourth Edition, GA32-0928-03, 16 October 2017 .....	c
0.1.5 Fifth Edition, GA32-0928-04, 15 July 2021 .....	c
0.1.6 Sixth Edition, GA32-0928-05, 22 February 2022 .....	d
1. Preface .....	1
1.1 Organization .....	1
1.2 Related Publications .....	1
2. Definitions, symbols, abbreviations, and conventions .....	3
2.1 Definitions .....	3
2.2 Conventions .....	16
2.2.1 Radix representation .....	16
2.2.2 Bit Numbering .....	16
2.2.3 Units of measure for data storage .....	16
2.2.4 Subpages .....	17
2.2.5 Hyperlinks .....	17
2.3 Tape Drive Model Names .....	17
3. Introduction .....	19
3.1 Drive Overview .....	19
3.2 Supported Servers and Operating Systems .....	20
3.2.1 Primary Interface Attachment .....	20
3.3 Supported Device Drivers .....	21
3.4 Supported Tape Cartridges .....	22
3.4.1 Design Capacity .....	23
3.5 Microcode Detection of Errors .....	24
3.5.1 Fencing Behavior .....	24
4. Implementation Considerations .....	25
4.1 Media Optimization (LTO9+) .....	25
4.2 Write modes .....	25
4.2.1 Write mode introduction .....	25
4.2.2 Overwrite-allowed mode .....	25
4.2.3 Append-only mode (also known as Data-safe mode) .....	26
4.3 Archive mode unthread (LTO7+) .....	29
4.4 Volume partitioning .....	29
4.4.1 Volume partitioning overview .....	29
4.4.2 Wrap-wise Partitioning .....	29
4.4.3 Partitioning and capacity scaling .....	33
4.4.4 Partitioning and media types .....	33
4.4.5 Partitioning and reformatting .....	33
4.4.6 Partitioning and encryption .....	34
4.5 Object buffer .....	34
4.5.1 Object buffer introduction .....	34
4.5.2 BOP caching .....	34
4.5.2.1 BOP caching side effects .....	35
4.6 Recommended access order (RAO) (LTO-9+ Full-Height) .....	35
4.6.1 RAO Suitability .....	35
4.6.2 RAO overview .....	35

4.6.2.1	User data segments (UDS) in a partition .....	35
4.6.2.2	User data segment descriptors .....	35
4.6.3	RAO features .....	36
4.6.3.1	RAO features overview .....	36
4.6.3.2	Determining the UDS limits .....	36
4.6.3.3	Specifying the process for generating the RAO list .....	36
4.6.3.4	Specifying binding points in the RAO list .....	36
4.6.4	RAO usage .....	37
4.6.4.1	User data segment geometry usage .....	39
4.7	Mode Page Behaviors .....	39
4.7.1	Policy — non-standard .....	39
4.7.1.1	Mode parameter header and block descriptor policy .....	39
4.7.1.2	Mode page policy .....	39
4.7.2	Classification of mode parameters .....	41
4.7.2.1	Save behavior — non-standard .....	41
4.7.2.2	Parameter Saveable behavior — non-standard .....	41
4.7.3	Mode parameters and unit attentions .....	42
4.8	Programmable early warning .....	42
4.9	Logical block protection .....	43
4.9.1	Logical block protection overview .....	43
4.9.1.1	Logical block protection .....	43
4.9.2	Protection information on a volume .....	43
4.9.3	Logical blocks and protection information .....	45
4.9.4	Protecting logical blocks transferred during writes .....	45
4.9.5	Protecting logical blocks processed during reads and verifies .....	46
4.10	Multiple Port Behavior .....	46
4.11	Data Transfer, Block Limits, and Fixed Block Option .....	47
4.12	Request Sense Information, ILI, and Command Interactions .....	47
4.12.1	General Read-Type Handling .....	47
4.12.2	Interactions Summary .....	49
4.13	Drive Cleaning .....	51
4.13.1	Cleaning the Drive in a Library .....	51
4.13.2	Drive Cleaning Indicators .....	51
4.13.2.1	Panel Cleaning Indication .....	52
4.13.2.2	Host Interface - Dynamic Cleaning Indicators .....	52
4.13.2.3	Host Interface - Static Cleaning Indicator (Sense Data Byte 70) .....	52
4.13.3	Cleaning Criteria .....	52
4.14	WORM Behaviors .....	53
4.14.1	Conditions for Writing .....	53
4.14.2	Command Behavior When WORM Medium Has Been Tampered With .....	53
4.15	Device Hardware Encryption .....	54
4.15.1	Encryption Control - IBM Proprietary Protocol (IPP) .....	54
4.15.2	Encryption Control - T10 Standards .....	55
4.15.2.1	External Data Encryption Control .....	55
4.16	Attachment Features .....	55
4.16.1	Types of Interface Attachments .....	55
4.16.2	Common Tape LUN Behaviors .....	55
4.16.2.1	Power-On .....	56
4.16.2.2	Reset Strategy .....	56
4.16.2.3	Abort Handling .....	56
4.16.2.4	Multi-initiator Support .....	58
4.16.2.5	Status Codes .....	58
4.16.3	Features of the Fibre Channel Interface .....	58
4.16.3.1	Topology .....	59
4.16.3.1.1	Two-Node Switched Fabric Topology .....	60
4.16.3.1.2	Two-Node Direct Connection Topology .....	60
4.16.3.2	Speed .....	60

4.16.3.3 Addressing Assignments .....	60
4.16.4 Features of the Serial Attached SCSI (SAS) Interface .....	60
4.17 Device Clocks .....	61
4.18 Dynamic runtime information .....	61
4.18.1 Dynamic runtime information overview .....	61
4.18.2 Dynamic runtime information timestamp .....	62
4.18.3 Setting dynamic runtime information into the drive .....	62
4.18.4 Retrieving dynamic runtime information from the drive .....	63
4.18.5 Management of dynamic runtime information .....	63
4.18.5.1 Dynamic Runtime Information Lifetime .....	63
4.19 Error Information .....	64
4.19.1 Sense Data .....	64
4.19.2 Sense Data Management .....	64
4.19.3 Deferred Check Condition (DCC) .....	64
4.19.4 Unit Attention Conditions .....	65
4.19.5 Persistent Errors .....	65
4.19.5.1 Fencing Behavior .....	65
4.19.5.1.1 ALLOW_NO_OPERATION .....	66
4.19.5.1.2 ALLOW_LOCATE .....	66
4.19.5.1.3 ALLOW_UNLOAD .....	66
4.19.5.1.4 MID-TAPE RECOVERY .....	66
4.19.5.1.4.1 Normal operation (i.e., MTR Fence) .....	66
4.19.5.1.4.2 Panic Fence operation .....	67
4.20 Medium auxiliary memory .....	67
4.21 Volume Coherency .....	68
4.22 Error history (i.e., drive dump) .....	69
4.22.1 Error history overview .....	69
4.22.2 Retrieving error history with the READ BUFFER command .....	69
4.23 Potential conflict list (LTO6 and later) .....	71
4.24 Environmental Conditions Thresholding (LTO9 and later) .....	72
5. SCSI Commands .....	75
5.1 SCSI Commands Overview .....	75
5.1.1 Unsupported SCSI Commands .....	75
5.1.2 Supported SCSI Commands .....	75
5.1.2.1 Supported SCSI Commands on LUN 1 .....	75
5.1.2.2 Supported SCSI Commands on LUN 0 .....	75
5.1.2.3 Control Byte Definition .....	78
5.2 SCSI Commands Listing .....	79
5.2.1 ALLOW OVERWRITE - 82h .....	79
5.2.2 ERASE - 19h .....	80
5.2.3 FORMAT MEDIUM - 04h .....	80
5.2.4 GENERATE RECOMMENDED ACCESS ORDER (GRAO) - A4h[1Dh] (LTO9+) .....	82
5.2.4.1 GRAO Parameter Data .....	83
5.2.4.1.1 GRAO User Data Segment descriptor .....	84
5.2.5 INQUIRY - 12h .....	84
5.2.5.1 Standard Inquiry Data .....	85
5.2.6 LOAD/UNLOAD - 1Bh .....	90
5.2.7 LOCATE (10/16) - 2Bh/92h .....	92
5.2.8 LOG SELECT - 4Ch .....	94
5.2.9 LOG SENSE - 4Dh .....	94
5.2.10 MODE SELECT (6/10) - 15h/55h .....	95
5.2.11 MODE SENSE (6/10) - 1Ah/5Ah .....	96
5.2.12 PERSISTENT RESERVE IN (PRIN)- 5Eh .....	98
5.2.12.1 READ KEYS service action .....	98
5.2.12.2 READ RESERVATION service action .....	100
5.2.12.3 REPORT CAPABILITIES service action .....	101

5.2.12.4 READ FULL STATUS service action .....	102
5.2.12.4.1 Full status descriptors .....	103
5.2.13 PERSISTENT RESERVE OUT - 5Fh .....	104
5.2.13.1 Basic PERSISTENT RESERVE OUT parameter list .....	105
5.2.13.2 PERSISTENT RESERVE OUT with REGISTER AND MOVE service action parameters .....	106
5.2.14 PREVENT ALLOW MEDIUM REMOVAL - 1Eh .....	106
5.2.14.1 Medium removal .....	107
5.2.15 READ - 08h .....	107
5.2.16 READ ATTRIBUTE - 8Ch .....	108
5.2.16.1 ATTRIBUTE VALUES service action .....	109
5.2.16.2 ATTRIBUTE LIST service action .....	110
5.2.16.3 LOGICAL VOLUME LIST service action .....	110
5.2.16.4 PARTITION LIST service action .....	111
5.2.16.5 SUPPORTED ATTRIBUTES service action .....	111
5.2.17 READ BLOCK LIMITS - 05h .....	112
5.2.17.1 READ BLOCK LIMITS block length data .....	112
5.2.17.2 READ BLOCK LIMITS maximum logical object identifier data .....	113
5.2.18 READ BUFFER - 3Ch .....	113
5.2.19 READ DYNAMIC RUNTIME ATTRIBUTE - A3h[1Eh] or D1h .....	114
5.2.19.1 READ DYNAMIC RUNTIME ATTRIBUTE Service Action .....	116
5.2.19.2 SUPPORTED ATTRIBUTES service action .....	116
5.2.19.3 ATTRIBUTE VALUES FOR THIS I_T NEXUS service action .....	117
5.2.19.4 ATTRIBUTE VALUES FOR ALL I_T NEXUSES service action .....	118
5.2.20 READ END OF WRAP POSITION - A3h[1Fh][45h] .....	119
5.2.20.1 REOWP Short form parameter data .....	121
5.2.20.2 REOWP Long form parameter data .....	121
5.2.20.2.1 Wrap descriptor .....	122
5.2.21 READ LOGGED-IN HOST TABLE - A3h[1Fh][01h] .....	122
5.2.21.1 READ LOGGED-IN HOST TABLE parameter data .....	123
5.2.21.1.1 Logged-In Host Descriptor .....	124
5.2.22 READ POSITION - 34h .....	125
5.2.22.1 READ POSITION command description .....	125
5.2.22.2 READ POSITION data format, short form .....	125
5.2.22.3 READ POSITION data format, long form .....	128
5.2.22.4 READ POSITION data format, extended form .....	129
5.2.23 RECEIVE DIAGNOSTIC RESULTS - 1Ch .....	131
5.2.24 RECEIVE RECOMMENDED ACCESS ORDER (RRAO) - A3h[1Dh] (LTO9+) .....	131
5.2.24.1 RRAO parameter data .....	132
5.2.24.1.1 UDS Limits page .....	133
5.2.24.1.2 RAO list .....	133
5.2.24.1.3 User Data Segment descriptor .....	134
5.2.24.1.3.1 Additional information descriptor .....	136
5.2.25 RELEASE UNIT (6/10)- 17h/57h .....	137
5.2.26 REPORT DENSITY SUPPORT - 44h .....	138
5.2.26.1 Report Density Support data format .....	138
5.2.26.1.1 Density descriptor overview .....	138
5.2.26.1.2 Density information .....	141
5.2.27 REPORT LUNS - A0h .....	142
5.2.27.1 Report LUNs data format .....	142
5.2.28 REPORT SUPPORTED OPERATION CODES - A3h[0Ch] .....	143
5.2.28.1 All_commands parameter data format .....	145
5.2.28.2 One_command parameter data format .....	146
5.2.28.3 Command timeouts descriptor .....	147
5.2.28.3.1 Overview .....	147
5.2.28.3.2 WRITE BUFFER command timeouts descriptor command specific field usage .....	158
5.2.29 REPORT SUPPORTED TASK MANAGEMENT FUNCTIONS - A3h[0Dh] .....	158
5.2.29.1 REPORT SUPPORTED TASK MANAGEMENT FUNCTIONS parameter data .....	159

5.2.30 REPORT TIMESTAMP - A3h[0Fh] .....	160
5.2.30.1 REPORT TIMESTAMP parameter data .....	161
5.2.31 REQUEST SENSE - 03h .....	161
5.2.31.1 Sense Data Format .....	162
5.2.32 RESERVE (6/10)- 16h/56h .....	168
5.2.33 REWIND - 01h .....	169
5.2.34 SECURITY PROTOCOL IN (SPIN) - A2h .....	169
5.2.35 SECURITY PROTOCOL OUT (SPOUT) - B5h .....	170
5.2.36 SEND DIAGNOSTIC - 1Dh .....	171
5.2.37 SET CAPACITY - 0Bh .....	172
5.2.38 SET TIMESTAMP - A4h[0Fh] .....	173
5.2.38.1 SET TIMESTAMP Parameter List .....	174
5.2.39 SPACE (6/16) - 11h/91h .....	175
5.2.40 TEST UNIT READY - 00h .....	176
5.2.41 VERIFY (6) - 13h .....	176
5.2.42 WRITE - 0Ah .....	178
5.2.43 WRITE ATTRIBUTE - 8Dh .....	178
5.2.44 WRITE BUFFER - 3Bh .....	181
5.2.45 WRITE DYNAMIC RUNTIME ATTRIBUTE - A4h[1Eh] or D2h .....	182
5.2.45.1 WRITE DYNAMIC RUNTIME ATTRIBUTE parameter list .....	183
5.2.46 WRITE FILEMARKS - 10h .....	184
6. Parameters for SCSI Commands .....	185
6.1 Dynamic runtime attributes (DRA) .....	187
6.1.1 Attribute format .....	187
6.1.2 Attribute identifier values .....	188
6.1.2.1 Attribute identifier values overview .....	188
6.1.2.2 Logical unit type attributes .....	188
6.1.2.2.1 I_T_L nexus identifying information descriptor .....	188
6.1.2.3 Target type attributes .....	193
6.1.2.4 Initiator type attributes .....	194
6.2 Diagnostic Parameters (Diag) .....	195
6.2.1 Diag Page Formats .....	195
6.2.1.1 Page 00h .....	195
6.2.1.2 SendDiag Data - Page 00h .....	195
6.2.1.3 RcvDiag Data - Page 00h .....	196
6.2.1.4 Page 80h .....	197
6.2.1.4.1 SendDiag - Page 80h .....	197
6.2.1.5 RcvDiag - Page 80h .....	198
6.2.1.5.1 RcvDiag - Page 80h Typical Results .....	199
6.2.1.5.2 SIM/MIM Message .....	201
6.2.1.5.2.1 SIM/MIM Header Data .....	201
6.2.1.5.2.2 SIM Messages .....	202
6.2.1.5.3 MIM Messages .....	204
6.2.2 Supported Page 80h Diags .....	206
6.2.3 Diag - SelfTest: Self Test .....	207
6.2.3.1 SendDiag Command - Self Test .....	207
6.2.3.2 RcvDiag Data - Self Test .....	207
6.2.4 Diag - 0090h: Primary port wrap test .....	207
6.2.4.1 SendDiag Parm Data - Primary port wrap test .....	208
6.2.4.2 RcvDiag Data - Primary port wrap test .....	208
6.2.5 Diag - 0100h: POST A .....	208
6.2.5.1 SendDiag Parm Data - POST A .....	209
6.2.5.2 RcvDiag Data - POST A .....	209
6.2.6 Diag - 0101h: POST B Performance .....	209
6.2.6.1 SendDiag Parm Data - POST B Performance .....	210
6.2.6.2 RcvDiag Data - POST B Performance .....	210

6.2.7 Diag - 0102h: POST C Media Test .....	210
6.2.7.1 SendDiag Parm Data - POST C Media Test .....	210
6.2.7.2 RcvDiag Data - POST C Media Test .....	210
6.2.8 Diag - 0103h: POST D Head Test .....	211
6.2.8.1 SendDiag Parm Data - POST D Head Test .....	211
6.2.8.2 RcvDiag Data - POST D Head Test .....	211
6.2.9 Diag -0111h: Medium Calibration Audit .....	211
6.2.9.1 SendDiag Parm Data - Medium Calibration Audit .....	212
6.2.9.2 RcvDiag Data - Medium Calibration Audit .....	213
6.2.9.2.1 Common results descriptor .....	213
6.2.10 Diag - 0160h: Force Dump .....	214
6.2.10.1 SendDiag Parm Data - Force Dump .....	215
6.2.10.2 RcvDiag Data - Force Dump .....	215
6.2.11 Diag -0161h: Write Dump to Cartridge .....	215
6.2.11.1 SendDiag Parm Data - Write Dump to Cartridge .....	215
6.2.11.2 RcvDiag Data - Write Dump to Cartridge .....	215
6.2.12 Diag - 0163h: Force Mini Dump .....	216
6.2.12.1 SendDiag Parm Data - Force Mini Dump .....	216
6.2.12.2 RcvDiag Data - Force Mini Dump .....	216
6.2.13 Diag - 0170h: Create FMR Cartridge (not on LTO5) .....	216
6.2.13.1 SendDiag Parm Data - Create FMR Cartridge .....	217
6.2.13.2 RcvDiag Results Data - Create FMR Cartridge .....	217
6.2.14 Diag - 0171h: Unmake FMR Cartridge (not on LTO5) .....	217
6.2.14.1 SendDiag Parm Data - Unmake FMR Cartridge .....	218
6.2.14.2 RcvDiag Results Data - Unmake FMR Cartridge .....	218
6.2.15 Diag - 0175h: Use FMR Cartridge (not on LTO5) .....	218
6.2.15.1 SendDiag Parm Data - Use FMR Cartridge .....	219
6.2.15.2 RcvDiag Results Data - Use FMR Cartridge .....	219
6.2.16 Diag - 0190h: Set Traps .....	219
6.2.16.1 SendDiag Parm Data - Set Traps .....	219
6.2.16.2 RcvDiag Data - Set Traps .....	220
6.2.17 Diag - 0191h: Remove Traps .....	220
6.2.17.1 SendDiag Parm Data - Remove Traps .....	220
6.2.17.2 RcvDiag Data - Remove Traps .....	221
6.2.18 Diag - 0210h: Terminate Immediate Command .....	221
6.2.18.1 Send Data – Terminate Immed Command .....	221
6.2.18.2 Results Data – Terminate Immed Command .....	223
6.2.19 Diag - 1002h: Read Thermal Sensor .....	223
6.2.19.1 SendDiag Parm Data - Read Thermal Sensor .....	223
6.2.19.2 RcvDiag Data - Read Thermal Sensor .....	224
6.2.20 Diag - 2002h: Reset Drive .....	225
6.2.20.1 SendDiag Parm Data - Reset Drive .....	225
6.2.20.2 RcvDiag Command - Reset Drive .....	225
6.3 Inquiry Vital Product Data Parameters (IP) .....	227
6.3.1 IP 00h: Supported Vital Product Data Pages .....	227
6.3.1.1 Returned Data - Inquiry Page 00h: Supported Inquiry Pages .....	227
6.3.2 IP 03h: Firmware Designation .....	228
6.3.2.1 Returned Data - IP 03h: Firmware Designation .....	229
6.3.3 IP 80h: Unit Serial Number .....	230
6.3.3.1 Returned Data - IP 80h: Unit Serial Number .....	230
6.3.4 IP 83h: Device Identification .....	230
6.3.4.1 Returned Data - Inquiry Page 83h: Device Identification .....	231
6.3.4.1.1 T10 vendor ID designation descriptor .....	232
6.3.4.1.2 Logical Unit (NAA) - WWNN designation descriptor .....	233
6.3.4.1.3 Relative target port identifier designation descriptor .....	234
6.3.4.1.4 Port Name (NAA) - WWPN designation descriptor .....	235
6.3.4.1.5 Target Device Name (NAA) designation descriptor (SAS only) .....	235

6.3.5 IP 86h: Extended INQUIRY Data .....	236
6.3.6 IP 87h: Mode Page Policy .....	238
6.3.6.1 Returned Data - IP 87h: Mode Page Policy .....	239
6.3.6.1.1 Mode page policy descriptor .....	239
6.3.7 IP 88h: SCSI ports .....	240
6.3.7.1 Returned Data - IP 88h: SCSI ports .....	240
6.3.8 IP 90h: Protocol-Specific Logical Unit Information .....	242
6.3.8.1 Returned Data - IP 90h: SCSI ports .....	242
6.3.8.2 Logical unit information descriptor .....	243
6.3.9 IP B0h: Sequential-Access device capabilities .....	243
6.3.9.1 Returned Data - IP B0h: Sequential-Access device capabilities .....	244
6.3.10 IP B1h: Manufacturer-assigned Serial Number .....	244
6.3.10.1 Returned Data - IP B1h: Manufacturer-assigned Serial Number .....	244
6.3.11 IP B3h: Automation Device Serial Number .....	245
6.3.11.1 Returned Data - IP B3h: Automation Device Serial Number .....	245
6.3.12 IP B4h: Data Transfer Device Element Address .....	245
6.3.12.1 Returned Data - IP B4h: Data Transfer Device Element Address .....	246
6.3.13 IP B5h: Logical Block Protection .....	246
6.3.13.13 Returned Data - IP B5h: Logical Block Protection .....	247
6.3.14 IP C0h: Drive Component Revision Levels .....	248
6.3.14.1 Returned Data - IP C0h: Drive Component Revision Levels .....	249
6.3.15 IP C1h: Drive Serial Numbers .....	250
6.3.15.1 Returned Data - IP C1h: Drive Serial Numbers .....	250
6.3.16 IP C2h: Drive Bar codes .....	251
6.3.16.1 Returned Data - IP C2h: Drive Bar codes .....	251
6.3.16.1.1 Bar code descriptor .....	252
6.3.16.1.1.1 00h — 11S Bar code descriptor .....	252
6.3.17 IP C3h: Subcomponent Version List .....	253
6.3.17.1 Returned Data - IP C3h: Subcomponent Version List .....	253
6.3.17.1.1 Subcomponent version descriptor .....	254
6.3.18 IP C7h: Device Unique Configuration Data .....	254
6.3.18.1 Returned Data - IP C7h: Device Unique Configuration Data .....	254
6.3.19 IP C8h: Mode Parameter Default Settings .....	254
6.3.19.1 Returned Data - IP C8h: Mode Parameter Default Settings .....	254
6.4 Log Parameters (LP) .....	255
6.4.1 Log Page Format .....	257
6.4.2 Log Parameter Format .....	258
6.4.2.1 Log Parameter Byte 2 — Control Byte .....	258
6.4.3 General Log Parameter Reset Behavior .....	258
6.4.4 Supported Log Pages, Supported Log pages and Subpages, and Supported Subpages .....	258
6.4.4.1 LP 00h: Supported Log Pages .....	259
6.4.4.2 LP [PAGE CODE][FFh]: Supported subpages .....	259
6.4.5 LP 02h: Write Error Counters .....	261
6.4.5.1 Parameter Definitions (02h) .....	262
6.4.6 LP 03h: Read Error Counters .....	262
6.4.6.1 Parameter Definitions (03h) .....	263
6.4.7 LP 06h: Non-Medium Errors .....	263
6.4.7.1 Parameter Definitions (06h) .....	264
6.4.8 LP 0Ch: Sequential-Access Device .....	264
6.4.8.1 Parameter Definitions (0Ch) .....	265
6.4.9 LP 0Dh[01h]: Environmental Reporting (LTO9 and later) .....	266
6.4.9.1 Parameter Reset Behavior .....	266
6.4.9.2 Parameter Definitions .....	266
6.4.9.2.1 Temperature Report parameter data .....	267
6.4.9.2.2 Relative Humidity Report parameter data .....	268
6.4.10 LP 11h: DT Device Status .....	269
6.4.10.1 Parameter Definitions (11h) .....	270

6.4.10.1.1	Very high frequency data log parameter	271
6.4.10.1.2	Very high frequency polling delay log parameter	275
6.4.10.1.3	Extended very high frequency data log parameter	276
6.4.10.1.4	Primary port status log parameter(s)	277
6.4.10.1.5	Fibre Channel port status data	278
6.4.10.1.6	Serial Attached SCSI port status data	280
6.4.10.1.7	Potential conflict list entries present log parameter	281
6.4.10.1.8	Potential conflict list log parameter(s)	282
6.4.10.1.9	DT device primary port physical interface information	283
6.4.10.1.10	Medium VolSer	284
6.4.10.1.11	Medium Status Data	285
6.4.10.1.12	Drive Status Data	286
6.4.10.1.13	Primary Port Features	287
6.4.10.1.14	Encryption Control Descriptor	288
6.4.11	LP 12h: TapeAlert Response	288
6.4.11.1	Parameter Definitions (12h)	289
6.4.12	LP 14h: Device Statistics	289
6.4.12.1	Parameter Reset Behavior (14h)	290
6.4.12.2	Parameter Definitions (14h)	290
6.4.12.3	Log parameter formats	294
6.4.12.3.1	Device statistics data counter log parameter format	294
6.4.12.3.2	Device statistics medium type log parameter format	295
6.4.12.3.2.1	Device statistics medium type descriptor	295
6.4.12.3.2.1.1	Supported descriptors	296
6.4.12.3.3	Device statistics string data log parameter format	297
6.4.13	LP 16h: Tape diagnostic data	298
6.4.13.1	Parameter Definitions (16h)	298
6.4.14	LP 17h: Volume Statistics	301
6.4.14.1	Parameter Definitions	302
6.4.14.2	Parameter formats	306
6.4.14.2.1	Data counter log parameter format	306
6.4.14.2.2	Volume statistics string data log parameter format	307
6.4.14.2.3	Volume statistics partition record log parameter format	307
6.4.15	LP 18h: Protocol-specific port	308
6.4.15.1	Parameter Reset Behavior (18h)	309
6.4.15.2	Parameter Definitions (18h)	309
6.4.16	LP 1A: Power Condition Transitions	313
6.4.16.1	Parameter Definitions (1Ah)	313
6.4.17	LP 1Bh: Data Compression	314
6.4.17.1	Parameter Definitions	314
6.4.17.2	Parameter format	316
6.4.18	LP 2Eh: TapeAlerts	316
6.4.18.1	Parameter Reset Behavior (2Eh)	317
6.4.18.2	Parameter Definitions (2Eh)	317
6.4.19	LP 30h: Tape Usage	319
6.4.19.1	Parameter Definitions (30h)	319
6.4.20	LP 31h: Tape capacity	320
6.4.20.1	Parameter Reset Behavior (31h)	320
6.4.20.2	Parameter Definitions(31h)	320
6.4.21	LP 32h: Data compression	321
6.4.21.1	Parameter Definitions (32h)	321
6.4.22	LP 33h: Write Errors	322
6.4.22.1	Parameter Definitions (33h)	322
6.4.23	LP 34h: Read Forward Errors	324
6.4.23.1	Parameter Definitions (34h)	324
6.4.24	LP 37h: Performance Characteristics	326
6.4.24.1	Parameter Reset Behavior (37h)	326



6.4.24.2 Parameter Definitions (37h)	326
6.4.25 LP 38h: Blocks/Bytes Transferred	337
6.4.25.1 Parameter Definitions (38h)	338
6.4.26 LP 39h: Host Port 0 Interface Errors	340
6.4.26.1 Parameter Definitions (39h)	340
6.4.27 LP 3Ah: Drive control verification	341
6.4.28 LP 3Bh: Host Port 1 Interface Errors	341
6.4.28.1 Parameter Definitions (3Bh)	341
6.4.29 LP 3Ch: Drive usage information	342
6.4.29.1 Parameter Reset Behavior (3Ch)	342
6.4.29.2 Parameter Definitions (3Ch)	342
6.4.30 LP 3Dh: Subsystem Statistics	344
6.4.30.1 Parameter Reset Behavior (3Dh)	344
6.4.30.2 Parameter Definitions (3Dh)	345
6.4.31 LP 3Eh: Engineering Use	346
6.4.32 LP 3Eh[3Ch]: Drive Control Statistics	347
6.5 Medium auxiliary memory attributes (MAM)	349
6.5.1 MAM attribute format	349
6.5.2 Attribute identifier values	350
6.5.2.1 Attribute identifier values overview	350
6.5.2.2 Device type attributes	350
6.5.2.3 Medium type attributes	353
6.5.2.4 Host type attributes	355
6.5.2.5 Vendor-Specific Medium Type Attributes	357
6.6 Mode Parameters (MP)	359
6.6.1 Mode Parameter List for Mode Select (6/10)	359
6.6.1.1 Mode Parameter Header for Mode Select (6/10)	359
6.6.1.2 Block Descriptor for Mode Select (6/10)	361
6.6.2 Mode Parameter List for Mode Sense (6/10)	362
6.6.2.1 Mode Parameter Header for Mode Sense (6/10)	363
6.6.2.2 Block Descriptor for Mode Sense (6/10)	364
6.6.3 Mode Page Format	364
6.6.4 Supported Mode Pages	365
6.6.5 MP 01h: Read-Write Error Recovery	366
6.6.6 MP 02h: Disconnect-Reconnect	367
6.6.7 MP 0Ah: Control	369
6.6.8 MP 0Ah[01h]: Control Extension	370
6.6.9 MP 0Ah[F0h]: Control Data Protection	371
6.6.10 MP 0Fh: Data Compression	373
6.6.11 MP 10h: Device Configuration	375
6.6.12 MP 10h[01h]: Device Configuration Extension	377
6.6.13 MP 11h: Medium Partition Page	380
6.6.14 MP 18h: Protocol-Specific Logical Unit	385
6.6.14.1 MP 18h: Fibre Channel Logical Unit	385
6.6.14.2 MP 18h: SAS Logical Unit	386
6.6.15 MP 19h: Protocol specific port	386
6.6.15.1 MP 19h: FCP port	387
6.6.15.2 MP 19h: SAS port	388
6.6.16 MP 1Ah: Power Condition	389
6.6.17 MP 1Ch: Informational Exceptions Control	390
6.6.18 MP 1Dh: Medium Configuration	392
6.6.19 MP 24h: Vendor-Specific	393
6.6.20 MP 2Fh: Behavior Configuration	397
6.6.21 MP 30h: Device Attribute Settings	400
6.6.21.1 MP 30h: Directory Listing - Device Attribute Settings	400
6.6.21.2 Supported subpage list - Device Attribute Settings	401
6.6.21.3 MP 30h[01h-02h]: Ethernet attributes - Device attribute settings	402

6.6.21.3.1 Ethernet attributes overview .....	402
6.6.21.3.1.1 Ethernet socket address descriptor .....	402
6.6.21.3.1.1.1 Sockaddr for an IPv4 IP address .....	403
6.6.21.3.1.1.2 Sockaddr for an IPv6 address .....	403
6.6.21.3.2 MP 30h[01h]: Drive MAC address - Device attribute settings .....	405
6.6.21.3.3 MP 30h[02h]: Drive IP address and subnet mask - Device attribute settings .....	407
6.6.21.4 MP 30h[20h-(20h)]: Encryption Attributes - Device Attribute Settings .....	409
6.6.21.4.1 MP 30h[20h]: Encryption mode - Device Attribute Settings .....	409
6.6.21.5 MP 30h[40h-44h]: Data processing attributes - Device attribute settings .....	411
6.6.21.5.1 MP 30h[40h]: SkipSync - Device attribute settings .....	411
6.6.21.5.2 MP 30h[42h]: End of partition behavior control - Device attribute settings .....	414
6.6.21.5.3 MP 30h[43h]: Feature switches - Device attribute settings .....	415
6.6.21.5.4 MP 30h[44h]: Preferred Cartridge Type — Device attribute settings .....	417
6.6.21.5.4.1 Preferred cartridge descriptor .....	418
6.6.21.5.4.2 Preferred Cartridge Type support .....	418
6.6.22 MP 3Eh: Engineering Support .....	419
6.7 Read/Write Buffers (RB) .....	421
6.7.1 Read/Write Buffer Modes .....	421
6.7.1.1 MODE [00h] – Combined header and data .....	421
6.7.1.2 MODE [02h] – Data .....	421
6.7.1.3 MODE [03h] (RB)– Descriptor .....	422
6.7.1.4 MODE [04h] (WB) – Download microcode and activate .....	422
6.7.1.5 MODE [05h] (WB) – Download microcode, save, and activate .....	423
6.7.1.6 MODE [06h] (WB) – Download microcode with offsets and activate .....	423
6.7.1.7 MODE [07h] (WB) – Download microcode with offsets, save, and activate .....	423
6.7.1.8 MODE [07h] (RB) – Descriptor with algorithmic offset boundary .....	423
6.7.1.9 MODE [0Ah] – Echo buffer .....	423
6.7.1.10 MODE [0Bh] (RB) – Echo buffer descriptor .....	423
6.7.1.11 mode [0Dh] (WB) – Download microcode with offsets, select activation, save, and defer activate mode .....	424
6.7.1.12 mode [0Fh] (WB) – Activate deferred microcode mode .....	424
6.7.1.13 MODE [1Ch] (RB) – Error history .....	424
6.7.1.13.1 Error history overview .....	424
6.7.2 Supported Buffers .....	425
6.7.2.1 RB 06h: Error Log (aka. Engineering Log) .....	426
6.7.2.2 RB 07h: SCSI Log (aka Error log) .....	427
6.7.2.3 RB 08h: World Wide Name .....	427
6.7.2.4 RB 19h: Host non-volatile .....	428
6.7.2.5 RB 21h: Cartridge Memory from EOD dataset .....	428
6.7.2.6 RB 50h: Active IP addresses .....	428
6.7.2.6.1 Active IP addresses fixed buffer (LTO5 only) .....	429
6.7.2.6.2 Active IP addresses variable buffer (LTO6 and later) .....	430
6.7.2.7 Supported Buffers when the mode field is 1Ch .....	432
6.7.2.7.1 MODE [1Ch] 00h to 03h: Error history directory .....	433
6.7.2.7.2 Error history directory entry .....	435
6.7.2.7.3 MODE [1Ch] 10h to FEh: Error history data buffer .....	436
6.7.2.7.3.1 MODE [1Ch] 10h to FEh: Error history data buffer overview .....	436
6.7.2.7.3.2 MODE [1Ch] 10h: Current error history snapshot .....	436
6.7.2.7.3.3 MODE [1Ch] 11h: Mini dump .....	436
6.7.2.7.3.4 MODE [1Ch] 20h: Emergency dump .....	436
6.7.2.7.3.5 MODE [1Ch] 21h to 28h: Prioritized flash dump .....	436
6.7.2.7.3.6 MODE [1Ch] EFh: Error history names list .....	437
6.7.2.7.3.6.1 Error history names entry .....	437
6.7.2.7.4 MODE [1Ch] FEh: Clear error history I_T_L nexus .....	438
6.7.2.7.5 MODE [1Ch] FFh: Clear error history I_T_L nexus and release snapshot .....	438
6.8 Security Protocol Parameters (SPP) .....	439
6.8.1 SPIN Pages (00h - Security Protocol Information) .....	439

6.8.1.1 SPIN (00h[0000h]) - Supported Security Protocols List .....	440
6.8.1.2 SPIN (00h[0001h]) - Certificate Data .....	441
6.8.1.3 SPIN (00h[0002h]) - Security Compliance Information .....	442
6.8.2 SPIN Pages (20h - Tape Data Encryption) .....	443
6.8.2.1 SPIN (20h[0000h]) - Tape Data Encryption In Support Pages page .....	443
6.8.2.2 SPIN (20h[0001h]) - Tape Data Encryption Out Support Pages page .....	445
6.8.2.3 SPIN (20h[0010h]) - Data Encryption Capabilities page .....	446
6.8.2.3.1 Data Encryption Algorithm Descriptor - Standard Encryption .....	447
6.8.2.4 SPIN (20h[0011h]) - Supported Key Formats page .....	451
6.8.2.4.1 Plaintext Key Format (00h) .....	451
6.8.2.5 SPIN (20h[0012h]) - Data Encryption Management Capabilities .....	452
6.8.2.6 SPIN (20h[0020h]) - Data Encryption Status page .....	453
6.8.2.7 SPIN (20h[0021h]) - Next Block Encryption Status page .....	456
6.8.2.7.1 Key-Associated Data (KAD) Descriptors .....	459
6.8.2.8 SPIN (20h[0030h]) - Random Number page .....	460
6.8.2.9 SPIN (20h[0031h]) - Device Server Key Wrapping Public Key page .....	461
6.8.3 SPOUT Pages (20h - Tape Data Encryption security protocol) .....	461
6.8.3.1 SPOUT (20h[0010h]) - Set Data Encryption .....	462
6.8.3.2 Key-Associated Data (KAD) Descriptors .....	465
6.8.3.2.1 KAD 00h - UKAD (Unauthenticated KAD) .....	465
6.8.3.2.2 KAD 01h - AKAD (Authenticated KAD) / DKi (Data Key Identifier) .....	465
6.8.3.2.3 KAD 02h - Nonce .....	466
6.8.3.2.4 KAD 03h - MKAD (Metadata) .....	467
Annex A. Summary of Drive Generation Differences .....	469
A.1. Differences in Command Timeout Values .....	470
A.2. Command and Parameter Differences Between Generations .....	474
Annex B. Error Sense Information .....	477
B.1. Sense Key 0 (No Sense) .....	477
B.2. Sense Key 1 (Recovered Error) .....	478
B.3. Sense Key 2 (Not Ready) .....	478
B.4. Sense Key 3 (Medium Error) .....	479
B.5. Sense Key 4 (Hardware Error) .....	480
B.6. Sense Key 5 (Illegal Request) .....	481
B.7. Sense Key 6 (Unit Attention) .....	483
B.8. Sense Key 7 (Data Protect) .....	485
B.9. Sense Key 8 (Blank Check) .....	486
B.10. Sense Key B (Aborted Command) .....	486
B.11. Sense Key D (Volume Overflow) .....	486
Annex C. Firmware Download .....	487
C.1. Identifying Level Hardware of Drive .....	487
C.2. Identifying the product for which the firmware image is intended .....	491
C.3. Download Process .....	491
Annex D. Protection Information CRC's .....	493
D.1. Reed-Solomon CRC .....	493
D.1.1. Reed-Solomon CRC Algorithm .....	493
D.1.2. Sample C program to generate Reed-Solomon CRC .....	493
D.1.3. Sample C program to compute and append Reed-Solomon CRC to a data block .....	494
D.1.4. Sample C program to to verify block with Reed-Solomon CRC .....	495
D.2. CRC32C (Castagnoli) .....	495
D.2.1. CRC32C Algorithm .....	495
D.2.2. Sample C program to generate CRC32C (Castagnoli) .....	496
D.2.3. Sample C code to compute and append CRC32C to a data block .....	497
D.2.4. Sample C code to verify block with CRC32C CRC .....	497

D.3. CRC32-IEEE .....	498
D.3.1. CRC32-IEEE Algorithm .....	498
Annex E. Best Practices .....	499
E.1. Overview .....	499
E.2. Handling of Type M cartridges .....	499
E.3. LTO-9 Cartridge Initialization .....	499
E.3.1. LTO-9 cartridge initialization overview .....	499
E.3.2. Usage recommendations .....	499
E.3.3. SCSI command additions / updates .....	500
Annex F. Notices .....	501
F.1. Trademarks .....	501

## Tables

	Page
1 Comparison of binary and decimal units and values .....	16
2 Percentage difference between binary and decimal units .....	17
3 Features of the IBM Ultrium Tape Drives and the IBM 3580 Ultrium Tape Drive .....	19
4 Supported Servers and Operating Systems for Primary Interface Attachment .....	20
5 LTO capacities by density, cartridges, and products .....	22
6 LTO design capacities by density and cartridges .....	24
7 allow_overwrite variable definition .....	26
8 Partition sizes for wrap-wise partitioning (selection fields) .....	30
9 Partition sizes for wrap-wise partitioning (resultant sizes) .....	31
10 Partition values for L5, L6, and L7 .....	32
11 Partition values for M8, L8, and L9 .....	33
12 PROCESS for generating recommended access order .....	36
13 Mode page policy .....	39
14 Mode parameter change behavior .....	41
15 Logical block with no protection information .....	45
16 Logical block with protection information .....	45
17 Information and ILI Behavior Summary .....	49
18 ASC/ASCQ Codes Related to Cleaning .....	52
19 Drive Cleaning Criteria to assert Clean Requested .....	53
20 Behavior when the loaded medium has suspect integrity .....	54
21 Abort Condition Handling .....	56
22 Status Codes .....	58
23 Topologies through which this device's port(s) can operate .....	59
24 TIMESTAMP ORIGIN .....	61
25 TIMESTAMP Format .....	61
26 Types of DRA attributes .....	62
27 DRA attribute states .....	62
28 Error to Fence State mapping .....	65
29 Types of MAM attributes .....	68
30 MAM attribute states .....	68
31 Supported Common SCSI Commands .....	76
32 Control Byte Definition .....	78
33 ALLOW OVERWRITE CDB .....	79
34 allow overwrite field definition .....	79
35 ERASE CDB .....	80
36 FORMAT MEDIUM CDB .....	81
37 FORMAT MEDIUM format field .....	81
38 GENERATE RECOMMENDED ACCESS ORDER CDB .....	82
39 GRAO Parameter List .....	83
40 GRAO - User Data Segment descriptor .....	84
41 INQUIRY CDB .....	84
42 Standard INQUIRY data valid LUN format .....	85
43 eServer attachment Standard Inquiry Data Valid LUN .....	87
44 Standard Inquiry Product Identification Table .....	88
45 Standard Inquiry protocol identifier values .....	89
46 Standard Inquiry SAS maximum speed supported values .....	89
47 Standard Inquiry Fibre Channel maximum speed supported values .....	89
48 Standard Inquiry fips field values .....	90
49 LOAD/UNLOAD CDB .....	90
50 Behavior for the combinations of the RETEN, LOAD, HOLD bits .....	91
51 Medium removal prevented behavior .....	92
52 LOCATE (10) CDB .....	92
53 LOCATE (16) CDB .....	92
54 LOG SELECT CDB .....	94
55 LOG SENSE CDB .....	94

56 MODE SELECT (6) CDB .....	95
57 MODE SELECT (10) CDB .....	96
58 MODE SENSE (6) CDB .....	97
59 MODE SENSE (10) CDB .....	97
60 PERSISTENT RESERVE IN CDB .....	98
61 PERSISTENT RESERVE IN parameter data for READ KEYS .....	99
62 PERSISTENT RESERVE IN parameter data for READ RESERVATION .....	100
63 PERSISTENT RESERVE IN parameter data for REPORT CAPABILITIES .....	101
64 PERSISTENT RESERVE IN parameter data for READ FULL STATUS .....	102
65 PERSISTENT RESERVE IN full status descriptor format .....	103
66 PERSISTENT RESERVE OUT CDB .....	104
67 PERSISTENT RESERVE OUT parameter list .....	105
68 PERSISTENT RESERVE OUT with REGISTER AND MOVE service action parameter list .....	106
69 PREVENT ALLOW MEDIUM REMOVAL CDB .....	106
70 READ CDB .....	107
71 READ ATTRIBUTE CDB .....	108
72 READ ATTRIBUTE with ATTRIBUTE VALUES service action parameter list format .....	109
73 READ ATTRIBUTE with ATTRIBUTE LIST service action parameter list format .....	110
74 READ ATTRIBUTE with LOGICAL VOLUME LIST service action parameter list format .....	110
75 READ ATTRIBUTE with PARTITION LIST service action parameter list format .....	111
76 READ ATTRIBUTE with SUPPORTED ATTRIBUTES service action parameter list format .....	111
77 READ BLOCK LIMITS CDB .....	112
78 RBL parameter data .....	112
79 READ BLOCK LIMITS maximum logical object identifier data .....	113
80 READ BUFFER CDB .....	113
81 READ DYNAMIC RUNTIME ATTRIBUTE CDB (legacy) .....	114
82 READ DYNAMIC RUNTIME ATTRIBUTE CDB (standardized) .....	114
83 READ DYNAMIC RUNTIME ATTRIBUTE Service Action codes .....	116
84 READ DYNAMIC RUNTIME ATTRIBUTE with SUPPORTED ATTRIBUTES service action parameter list format .....	117
85 Byte one of the parameter list data .....	117
86 READ DYNAMIC RUNTIME ATTRIBUTE with ATTRIBUTE VALUES FOR THIS I_T NEXUS service action parameter list format .....	118
87 Byte one of the parameter list data .....	118
88 READ DYNAMIC RUNTIME ATTRIBUTE with ATTRIBUTE VALUES FOR ALL I_T NEXUSES service action parameter list format .....	119
89 Byte one of the parameter list data .....	119
90 READ END OF WRAP POSTITION CDB .....	119
91 REOWP short form parameter data format .....	121
92 REOWP long form parameter data format .....	121
93 REOWP Wrap descriptor format .....	122
94 READ LOGGED-IN HOST TABLE CDB .....	122
95 READ LOGGED-IN HOST TABLE parameter data format .....	123
96 Logged-In Host Descriptor format .....	124
97 READ POSITION CDB .....	125
98 READ POSITION data format, short form .....	126
99 READ POSITION data format, long form .....	128
100 READ POSITION data format, extended form .....	129
101 RECEIVE DIAGNOSTIC RESULTS CDB .....	131
102 RECEIVE RECOMMENDED ACCESS ORDER CDB .....	132
103 UDS Limits page .....	133
104 RAO List .....	133
105 User Data Segment descriptor .....	134
106 Additional information descriptor .....	136
107 RELEASE UNIT (6) CDB .....	137
108 RELEASE UNIT (10) CDB .....	137
109 REPORT DENSITY SUPPORT CDB .....	138

110 REPORT DENSITY SUPPORT data format .....	139
111 Density support data block descriptor format .....	140
112 Density information LTO-3 through LTO-6 .....	141
114 REPORT LUNS CDB .....	142
113 Density information LTO-7 and later .....	142
115 RLUNS Logical Unit Numbers Data .....	143
116 REPORT SUPPORTED OPERATION CODES CDB .....	144
117 REPORT SUPPORTED OPERATION CODES reporting options field .....	144
118 RSOC All_commands parameter data .....	145
119 RSOC Command descriptor format .....	145
120 RSOC One_command parameter data .....	146
121 RSOC One_command support values .....	146
122 RSOC Command timeouts descriptor format .....	147
123 RSOC Command timeouts descriptor command specific field usage .....	148
124 RSOC Command timeout values for Full-Height (at publication) .....	149
125 RSOC Command timeout values for Full-Height (at publication) not returned to command .....	153
126 RSOC Command timeout values for Half-Height (at publication) .....	153
127 RSOC Command timeout values for Half-Height (at publication) not returned to command .....	158
128 REPORT SUPPORTED TASK MANAGEMENT FUNCTIONS CDB .....	159
129 REPORT SUPPORTED TASK MANAGEMENT FUNCTIONS parameter data .....	159
130 REPORT TIMESTAMP CDB .....	160
131 REPORT TIMESTAMP Timestamp Descriptor .....	161
132 REQUEST SENSE CDB .....	161
133 REQUEST SENSE Sense Data Format .....	162
134 RESERVE (6) CDB .....	168
135 RESERVE (10) CDB .....	168
136 REWIND CDB .....	169
137 SECURITY PROTOCOL IN - A2h CDB .....	169
138 SECURITY PROTOCOL OUT B5h CDB .....	170
139 SEND DIAGNOSTIC CDB .....	171
140 SET CAPACITY CDB .....	172
141 SET CAPACITY MEDIUM FOR USE PROPORTION VALUE and resultant capacity .....	173
142 SET TIMESTAMP CDB .....	174
143 SET TIMESTAMP parameter list format .....	174
144 SPACE (6) CDB .....	175
145 SPACE (16) CDB .....	175
146 TEST UNIT READY CDB .....	176
147 VERIFY (6) CDB .....	177
148 WRITE CDB .....	178
149 WRITE ATTRIBUTE CDB .....	179
150 WRITE ATTRIBUTE parameter list format .....	180
151 WRITE BUFFER CDB .....	181
152 WRITE DYNAMIC RUNTIME ATTRIBUTE CDB (legacy) .....	182
153 WRITE DYNAMIC RUNTIME ATTRIBUTE CDB (standardized) .....	182
154 WRITE DYNAMIC RUNTIME ATTRIBUTE parameter list .....	183
155 WRITE FILEMARKS CDB .....	184
156 DRA ATTRIBUTE format .....	187
157 DRA attribute FORMAT field .....	187
158 DRA attribute identifier range assignments .....	188
159 DRA Logical unit type attributes .....	188
160 DRA I_T_L nexus identifying information format .....	189
161 Reservation Information Dynamic Runtime Attribute value format .....	190
162 DRA RESERVATION TYPE values .....	191
163 Registration Information Dynamic Runtime Attribute value format .....	191
164 Prevent Allow Medium Removal Information Dynamic Runtime Attribute value format .....	192
165 DRA Target type attributes .....	193
166 DRA Last access time format .....	193

167 DRA Initiator type attributes .....	194
168 SendDiag - Page 00h Parm Data .....	195
169 RcvDiag - Page 00h Parm Data .....	196
170 SendDiag - Page 80h Parm Data .....	197
171 RcvDiag Data - Page 80h Results .....	198
172 RcvDiag Data - Page 80h Results .....	199
173 Diag SIM Data Structure .....	201
174 Diag SIM Data Structure .....	202
175 Diag MIM Data Structure .....	204
176 Supported Page 80 Diag Routines .....	206
177 SendDiag CDB - Self Test .....	207
178 Primary Port Wrap Test SendDiag Parm Data .....	208
179 SendDiag Parm Data - POST A .....	209
180 SendDiag Parm Data - POST B .....	210
181 SendDiag Parm Data - POST C Media Test .....	210
182 SendDiag Parm Data - POST D Head Test .....	211
183 SendDiag Parm Data - Medium Calibration Audit .....	212
184 RcvDiag Data - Medium Calibration Audit .....	213
185 Common results descriptor .....	214
186 SendDiag Parm Data - Force Dump .....	215
187 SendDiag Parm Data - Write Dump to Cartridge .....	215
188 SendDiag Parm Data - Force Mini Dump .....	216
189 Send Diagnostic Parameter Data - Create FMR Cartridge .....	217
190 Send Diagnostic Parameter Data - Unmake FMR Cartridge .....	218
191 Send Diagnostic Parameter Data - Use FMR Cartridge .....	219
192 SendDiag Parm Data - Set Traps .....	219
193 SendDiag Parm Data - Remove Traps .....	220
194 RcvDiag Data - Remove Traps .....	221
195 Send Data – (Diag 0210h) Terminate Immed Command .....	221
196 Supported Commands in the Terminate Immediate Command diagnostic .....	223
197 Diag parameter data - Read Thermal Sensor .....	223
198 Receive Diag parameter data - Read Thermal Sensor .....	224
199 SendDiag Parm Data - Reset Drive .....	225
200 IP 00h Supported Vital Product Data Inquiry Page .....	227
201 IP 03h Firmware Designation Page .....	229
202 IP 80h Unit Serial Number Inquiry Page .....	230
203 IP 83h Device Identification VPD page .....	231
204 T10 vendor ID based designation descriptor of IP 83h .....	232
205 Logical Unit (NAA) - WWNN designation descriptor of IP 83h .....	233
206 Relative target port identifier designation descriptor of IP 83h .....	234
207 Port Name (NAA) - WWPN designation descriptor of IP 83h .....	235
208 Target Device Name (NAA) designation descriptor of IP 83h (SAS only) .....	235
209 IP 86h Extended INQUIRY Data VPD page .....	236
210 IP 87h Mode Page Policy page .....	239
211 Mode page policy descriptor of IP 87h .....	239
212 IP 88h SCSI Ports VPD page .....	240
213 SCSI port designation descriptor of IP 88h .....	241
214 Target port descriptor of IP 88h .....	241
215 IP 90h Protocol-Specific Logical Unit Information VPD page for SAS SSP .....	242
216 Logical unit information descriptor for SAS SSP of IP 90h .....	243
217 IP B0hSequential-Access Device Capabilities Page .....	244
219 IP B3h Automation Device Serial Number VPD page .....	245
220 IP 84h Data Transfer Device Element Address VPD page .....	246
221 IP 85h Logical Block Protection VPD page .....	247
222 IP C0h: Drive Component Revision Levels .....	249
223 PLATFORM definition of IP C0h .....	250
224 IP C1h: Drive Serial Numbers .....	250



225 IP C2h: Drive Bar codes .....	251
226 Bar code descriptor .....	252
227 Bar code descriptor .....	252
228 IP C3h: Subcomponent Version List .....	253
229 Subcomponent version descriptor .....	254
230 Subcomponent designator-length-description .....	254
231 Supported log pages .....	255
232 Log page format .....	257
233 Log Parameter Format .....	258
234 Supported Log Pages .....	259
235 Supported Subpages .....	260
236 Supported Subpage descriptor .....	261
237 LP 02h: Write Error Log Parameters .....	262
238 LP 03h: Read Error Log Parameters .....	263
239 LP 06h: Non-Medium Errors log parameter codes .....	264
240 LP 0Ch: Sequential-Access Device log parameters .....	265
241 LP 0Dh[01h]: Environmental Reporting log parameters .....	266
242 Temperature Report parameter data format .....	267
244 LP 11h: DT Device Status log page .....	270
245 DT Device Status log parameters of LP 11h .....	270
246 Very high frequency data log parameter format of LP 11h .....	271
247 VHF data descriptor .....	272
248 Very high frequency polling delay log parameter format of LP 11h .....	275
250 Primary port status log parameter(s) format of LP 11h .....	277
251 Fibre Channel port status data format of LP 11h .....	278
252 Serial Attached SCSI port status data format of LP 11h .....	280
253 NEGOTIATED PHYSICAL LINK RATE values .....	280
254 Potential conflict list entries present log parameter of LP 11h .....	281
255 Potential conflict list log parameter of LP 11h .....	282
256 DT device primary port status log parameter(s) format .....	283
257 Medium Volume Label Serial Number log parameter of LP 11h .....	284
258 Medium Volume Label Serial Number log parameter of LP 11h .....	285
259 Medium Volume Label Serial Number log parameter of LP 11h .....	286
260 Primary Port Features log parameter of LP 11h .....	287
261 Encryption Control Descriptor log parameter of LP 11h .....	288
263 LP 14h: Device Statistics log parameter codes .....	290
264 Device statistics data counter log parameter format of LP 14h .....	294
265 Device statistics medium type log parameter format of LP 14h .....	295
266 Device statistics medium type descriptor format .....	295
267 LTO-5 Device statistics medium descriptor support .....	296
268 LTO-6 Device statistics medium descriptor support .....	296
269 LTO-7 Device statistics medium descriptor support .....	296
270 LTO-8 Device statistics medium descriptor support .....	297
271 LTO-9 Device statistics medium descriptor support .....	297
272 Device statistics string data log parameter format of LP 14h .....	297
273 LP 16h: Tape diagnostic data log page format .....	298
274 Tape diagnostic data log parameter format of LP 16h .....	299
275 Volume Statistics log subpage codes of LP 17h .....	301
276 LP 17h: Volume statistics log parameters .....	302
277 Volume statistics data counter log parameter format of LP 17h .....	306
278 Volume statistics string data log parameter format of LP 17h .....	307
279 Volume statistics partition log parameter format of LP 17h .....	307
280 Volume statistics partition record descriptor format of LP 17h .....	308
281 LP 18h Protocol-Specific log page for SAS .....	308
282 Protocol-Specific Port log parameter for LP 18h for SAS .....	310
283 Parameter codes for the Power Condition Transitions log page LP 1Ah .....	314
284 LP 1Bh: Data compression log parameters .....	315

285 Data compression counter log parameter format of LP 1Bh .....	316
286 LP 2Eh Supported TapeAlerts .....	318
287 LP 30h: Tape Usage log parameter codes .....	320
288 LP 31h: Tape capacity log parameters .....	321
289 LP 32h: Data Compression Log Parameters .....	322
290 LP 33h: Write Errors log parameter codes .....	323
291 LP 34h: Read Error Counters log parameter codes .....	325
292 LP 37h: Performance Characteristics: Quality Summary .....	329
293 LP 37h: Performance Characteristics: Device Usage .....	329
294 LP 37h: Performance Characteristics: Host Commands .....	330
295 LP 37h: Performance Characteristics: Host Initiators .....	333
296 LP 37h: Performance Characteristics: Host Recovery (by port) .....	334
297 LP 37h: Performance Characteristics: Mode Phase Timing Windows .....	334
298 LP 37h: Performance Characteristics: Servo Speed Characteristics .....	336
299 LP 37h: Performance Characteristics: Static Capacity .....	337
300 LP 37h: Performance Characteristics: Active Capacity .....	337
301 LP 37h: Performance Characteristics: Static Capacity per Partition .....	337
302 LP 38h: Blocks/Bytes Transferred log parameter codes .....	339
303 LP 39h: Host Port Interface Errors log parameter codes .....	341
304 LP 3Ch: Drive usage information log parameters .....	343
305 LP 3Dh: Subsystem Statistics log parameter codes .....	345
306 MAM ATTRIBUTE format .....	349
307 MAM attribute format field .....	349
308 MAM attribute identifier range assignments .....	350
309 MAM Device type attributes .....	350
310 DEVICE VENDOR/SERIAL NUMBER MAM attribute format .....	352
311 MAM Medium type attributes .....	353
312 Medium density code by product .....	354
313 MEDIUM TYPE and MEDIUM TYPE INFORMATION MAM attributes .....	354
314 SUPPORTED DENSITY CODES attribute format .....	354
315 MAM Host type attributes .....	355
316 TEXT LOCALIZATION IDENTIFIER MAM attribute values .....	356
318 MAM Vendor-Specific Medium Type Attributes .....	357
319 Mode Parameter List for Mode Select (6) .....	359
320 Mode Parameter List for Mode Select (10) .....	359
321 Mode Parameter Header for Mode Select (6) .....	360
322 Mode Parameter Header for Mode Select (10) .....	360
323 Block Descriptor for Mode Select .....	361
324 Mode Parameter List for Mode Sense (6) .....	362
325 Mode Parameter List for Mode Sense (10) .....	363
326 Mode Parameter Header for Mode Sense (6) .....	363
327 Mode Parameter Header for Mode Sense (10) .....	363
328 Block Descriptor for Mode Sense (10) or Mode Sense (6) .....	364
329 Mode Page Format .....	364
330 Mode Page Subpage Format .....	365
331 MP 01h Read-Write Error Recovery mode page .....	366
332 MP 02h Disconnect-Reconnect mode page .....	368
333 MP 0Ah Control mode page .....	369
334 MP 0Ah[01h] Control Extension mode page .....	371
335 MP 0Ah[F0h] Control Data Protection mode page format .....	372
336 MP 0Fh Data Compression mode page .....	374
337 MP 10h Device Configuration mode page .....	375
338 MP 10h[01h] Device Configuration Extension mode page .....	378
339 MP 11h Medium Partition mode page .....	381
340 MP 18h Fibre Channel Logical Unit mode page .....	385
341 MP 18h SAS Logical Unit mode page .....	386
342 MP 19h Fibre Channel Port mode page .....	387

343 MP 19h SAS Port mode page .....	388
344 MP 1Ah: Power Condition mode page format .....	389
345 MP 1Ch Informational Exceptions Control mode page .....	391
346 MP 1Dh Medium Configuration mode page .....	393
347 Vendor-Specific mode page .....	394
348 MP 2Fh Behavior Configuration Mode Page .....	397
349 MP 30h: Directory Listing - Device Attribute Settings mode page format .....	400
350 Ethernet socket address descriptor .....	402
351 Sockaddr format for IPv4 .....	403
352 Sockaddr format for IPv6 .....	403
353 MP 30h[01h] Drive MAC address .....	405
354 Drive port MAC address descriptor of MP 30h[01h] .....	406
355 MP 30h[02h] Drive IP address and subnet mask subpage .....	407
356 Drive Ethernet port descriptor of MP 30h[02h] .....	408
357 MP 30h[20h] Encryption mode mode page .....	409
358 Expected Encryption settings of MP 30h[20h] .....	410
359 MP 30h[40h] SkipSync - Device attribute settings mode page format .....	411
360 MP 30h[42h] End of partition behavior control - Device attribute settings mode page format .....	414
361 MP 30h[43h] Feature switches - Device attribute settings mode page format .....	415
362 MP 30h[44h] Preferred Cartridge Type — Device attribute settings mode page format .....	417
363 Preferred cartridge descriptor format .....	418
364 Supported “medium type—preferred density” pairs .....	418
365 MP 3Eh: Engineering Support mode page .....	419
366 READ BUFFER header .....	421
367 READ BUFFER descriptor .....	422
368 Echo buffer descriptor .....	424
369 Supported Buffer IDs .....	425
370 Error Log Buffer (06h) .....	426
371 SCSI Log Buffer (07h) .....	427
372 World Wide Name Buffer (08h) .....	428
373 Active IP addresses fixed buffer format (50h) .....	429
374 Active IP addresses variable buffer format (50h) .....	430
375 Ethernet port variable descriptor format .....	431
376 Error history buffer id field .....	432
377 Summary of error history directory device actions .....	433
378 Error history directory .....	434
379 Error history directory entry .....	435
380 MODE[1Ch] EFh: Error history names list format .....	437
381 Error history names entry .....	437
382 SPIN (00h) Security Protocol Specific Definitions for Security Protocol 00h .....	439
383 SPIN (00h[0000h]) Supported Security Protocols List Structure .....	440
384 SPIN (00h[0001h]) - Certificate Data Structure .....	441
385 SPIN (00h[0002h]) - Security Compliance Information Structure .....	442
386 SPIN (20h[0000h]) - Tape Data Encryption In Support Pages Structure .....	443
387 SPIN (20h[0000h]) - Tape Data Encryption In page codes (SECURITY PROTOCOL SPECIFIC VALUES) .....	444
388 SPIN (20h[0001h]) - Tape Data Encryption Out Support Pages Structure .....	445
389 Tape Data Encryption Out page codes .....	445
390 SPIN (20h[0010h]) - Data Encryption Capabilities page .....	446
391 Data Encryption Algorithm descriptor list returned .....	447
392 Data Encryption Algorithm Descriptor - Standard Encryption Structure .....	447
393 SPIN (20h[0011h]) - Supported Key Formats page Structure .....	451
394 Supported Key Formats .....	451
395 KEY FORMAT 00h - Plaintext Key Format Structure .....	451
396 SPIN (20h[0012h]) - Data Encryption Management Capabilities page .....	452
397 SPIN (20h[0020h]) - Data Encryption Status page .....	453
398 parameters control field .....	454
399 SPIN (20h[0021h]) - Next Block Encryption Status page .....	456

400 compression status field .....	456
401 encryption status field .....	457
402 SPIN (20h[0021h]) - KAD Parameters by Mode .....	458
403 SPIN (20h[0030h]) Random Number page .....	460
404 SPIN (20h[0031h]) Device Server Key Wrapping Public Key page .....	461
405 SPOUT (20h) - Security Protocol Specific Definitions for Security Protocol 20h .....	461
406 SPOUT (20h[0010h]) - Set Data Encryption page .....	462
407 SPOUT (20h[0010h]) - KAD Parameters by Mode .....	464
409 KAD 01h - AKAD (Authenticated KAD) / DKi (Data Key Identifier) .....	465
410 KAD 02h - Nonce .....	466
411 KAD 03h - MKAD (Metadata) .....	467
412 Command Timeout Values (Ultrium 1, 2, and 3 Full-Height) - Alphabetic Sort .....	471
413 Command Timeout Values (Ultrium 3 Half-Height and Ultrium 4) - Alphabetic Sort .....	473
A.1 Command and Parameter differences between generations .....	474
414 ASC, and ASCQ Summary for Sense Key 0 (No Sense) .....	477
415 ASC, and ASCQ Summary for Sense Key 1 (Recovered Error) .....	478
416 ASC, and ASCQ Summary for Sense Key 2 (Not Ready) .....	478
417 ASC, and ASCQ Summary for Sense Key 3 (Medium Error) .....	479
418 ASC, and ASCQ Summary for Sense Key 4 (Hardware Error) .....	480
419 ASC, and ASCQ Summary for Sense Key 5 (Illegal Request) .....	481
420 ASC, and ASCQ Summary for Sense Key 6 (Unit Attention) .....	483
421 ASC, and ASCQ Summary for Sense Key 7 (Data Protect) .....	485
422 ASC, and ASCQ Summary for Sense Key 8 (Blank Check) .....	486
423 ASC, and ASCQ Summary for Sense Key B (Aborted Command) .....	486
424 ASC, and ASCQ Summary for Sense Key D (Volume Overflow) .....	486
425 Load ID and RU Name Designation for LTO2 .....	487
426 Load ID and RU Name Designation for LTO3 .....	487
427 Load ID and RU Name Designation for LTO4 .....	488
428 Load ID and RU Name Designation for LTO5 .....	489
429 Load ID and RU Name Designation for LTO6 .....	489
430 Load ID and RU Name Designation for LTO7 .....	490
431 Load ID and RU Name Designation for LTO8 .....	490
432 Load ID and RU Name Designation for LTO9 .....	490
433 Firmware Image .....	491

## Figures

	Page
Figure 1 — IBM System Storage Ultrium Tape Drive Models. ....	19
Figure 2 — Append-only mode flowchart .....	28
Figure 3 — Wrap-wise partitioning .....	29
Figure 4 — Example Reordering of UDSeS .....	38
Figure 5 — Programmable early warning example .....	42
Figure 6 — Protection information shown in relation to logical objects and format specific symbols .....	44
Figure 7 — Dynamic runtime attributes focus .....	63
Figure 8 — Example of temperature thresholds .....	73



## 1. Preface

This publication contains information about how to use and program LTO5 models of the IBM® LTO Ultrium Tape Drive.

### 1.1 Organization

The information in this book is organized as follows:

- Read This First (see clause 0. beginning on page a)
- “Contents” (see page i)
- “Tables” (see page xiii)
- “Figures” (see page xxi)
- Preface (see clause 1. beginning on page 1)
- Definitions, symbols, abbreviations, and conventions (see clause 2. beginning on page 3)
- Introduction (see clause 3. beginning on page 19)
- Implementation Considerations (see clause 4. beginning on page 25)
- SCSI Commands (see clause 5. beginning on page 75)
- Parameters for SCSI Commands (see clause 6. beginning on page 185)
- Summary of Drive Generation Differences (see Annex A. on page 469)
- Error Sense Information (see Annex B. on page 477)
- Firmware Download (see Annex C. on page 487)
- Protection Information CRC’s (see Annex D. on page 493)
- Best Practices (see Annex E. on page 499)
- Notices (see Annex F. on page 501)
- “Index Of Counters (log parameters not in counter format are not included)” on page 503

### 1.2 Related Publications

- a) *IBM Tape Device Drivers Installation and User’s Guide*, GA32-0430, provides instructions for attaching IBM-supported hardware to open-systems operating systems. It indicates what devices and levels of operating systems are supported, gives the requirements for adapter cards, and tells how to configure servers to use the device driver with the Ultrium family of devices.
- b) *IBM Tape Device Drivers Programming Reference*, GC35-0483, supplies information to application owners who want to integrate their open-systems applications with IBM-supported Ultrium hardware. The reference contains information about the application programming interfaces (APIs) for each of the various supported operating-system environments.
- c) *Fibre Channel Arbitrated Loop (FC-AL-2)*, published by the American National Standards Institute (ANSI) as NCITS 332:1999.
- d) *Fibre Channel Tape and Tape Medium Changers (FC-TAPE)*, published by the American National Standards Institute. Final draft available as T11/99-069v4 on the web at <http://www.t11.org>; actual document available from ANSI as NCITS TR-24:1999.
- e) *Fibre Channel Protocol for SCSI, Second Version (FCP-2)*, published by the American National Standards Institute and available on the web at <http://www.t10.org>.
- f) *SCSI Parallel Interface-3 (SPI-3)*, published by InterNational Committee on Information Technology Standards (INCITS) and available on the web at <http://www.t10.org>.
- g) *SCSI-3 Stream Commands (SSC)*, published by the American National Standards Institute and available on the web at <http://www.t10.org>.

- h) *SCSI Stream Commands-2 (SSC-2)*, published by the American National Standards Institute and available on the web at <http://www.t10.org>.
- i) *SCSI Primary Commands-2 (SPC-2)*, published by the American National Standards Institute and available on the web at <http://www.t10.org>.
- j) *SCSI Primary Commands-3 (SPC-3)*, published by the American National Standards Institute and available on the web at <http://www.t10.org>.
- k) *SCSI Primary Commands-4 (SPC-4)*, published by the American National Standards Institute and available on the web at <http://www.t10.org>.
- l) *Automation/Drive Interface - Commands (ADC)*, published by the American National Standards Institute and available on the web at <http://www.t10.org>.
- m) *Automation/Drive Interface - Commands (ADC-2)*, published by the American National Standards Institute and available on the web at <http://www.t10.org>.
- n) *IBM System Storage Ultrium 4 Tape Drive Setup, Operator, and Service Guide, GC27-2102*, tells how to install and run the IBM System Storage Ultrium 4 Tape Drive. The guide also describes how to administer basic service procedures.

Portions of this manual were adapted from documentation provided by the InterNational Committee on Information Technology Standards (INCITS).



## 2. Definitions, symbols, abbreviations, and conventions

### 2.1 Definitions

This clause defines the special terms, abbreviations, and acronyms that are used in this publication. If the term being looked for is not found, refer to <http://www-01.ibm.com/software/globalization/terminology/index.jsp>.

**2.1.1 2:1 compression** The relationship between the quantity of data that can be stored with compression as compared to the quantity of data that can be stored without compression. For example, with 2:1 compression, twice as much data can be stored with compression as can be stored without compression.

**2.1.2 abend** Abnormal end of task.

**2.1.3 access method** A technique for moving data between processor storage and input/output devices.

**2.1.4 adapter** adapter card.

**2.1.5 adapter card** A circuit card that adds function to a computer.

**2.1.6 ADC** Automation/Drive Interface Commands (ADC).

**2.1.7 ADI** Automation/Drive Interface (ADI).

**2.1.8 ADT** Automation/Drive Interface Transport Protocol (ADT).

**2.1.9 AES** Advanced Encryption Standard.

**2.1.10 AK** Authentication Key

**2.1.11 AL\_PA** Arbitrated Loop Physical Address (ALPA; AL\_PA).

**2.1.12 ALPA** Arbitrated Loop Physical Address (ALPA; AL\_PA).

**2.1.13 ANSI** American National Standards Institute.

**2.1.14 Arbitrated Loop** A Fibre Channel Loop topology protocol, also known as L-port.

**2.1.15 Arbitrated Loop Physical Address (ALPA; AL\_PA)** An 8-bit value that identifies a device in an arbitrated loop..

**2.1.16 archiving** The storage of backup files and associated journals, usually for a given period of time.

**2.1.17 archiving application** The retention of records, in machine-readable form, for historical purposes.

**2.1.18 argument** Any value of an independent variable.

**2.1.19 ASC** Additional Sense Code.

**2.1.20 ASCII** American Standard Code for Information Interchange. When used to describe a field, indicates that the field contains only ASCII printable characters (i.e., code values 20h to 7Eh) and may be terminated with one or more ASCII null (00h) characters.

**2.1.21 ASCQ** Additional Sense Code Qualifier.

**2.1.22 ASN.1** Abstract Syntax Notation One - OSI's encoding (see X.208 standard)

**2.1.23 Automation/Drive Interface Commands (ADC)** A T10 standard that describes the commands that are used for communication between an Automation device (i.e., Library) and a Drive (i.e., tape drive). This command set standard is on the third generation at the time of this publication. See Project T10/1895-D, Information technology - Automation/Drive Interface Commands - 3 (ADC-3).

**2.1.24 Automation/Drive Interface (ADI)** The umbrella under which the T10 standards address the interface between removable media library controllers and the physical drives resident in those libraries. The standards defined are the Automation/Drive Interface Commands (ADC) and the *Automation/Drive Interface Transport Protocol (ADT)*.

**2.1.25 Automation/Drive Interface Transport Protocol (ADT)** The standard covering the Automation Drive Interface - Transport Protocol. This specific document covers the transport mechanisms between removable media library controllers and the physical drives resident in those libraries, specifically the encapsulation, logical transmission, and end-point delivery and reception of the commands associated with the ADI effort. At the time this document was published this standard was in its second revision. T10/1742-D, Information technology - Automation/Drive Interface - Transport Protocol -2 (ADT-2)

**2.1.26 backups** The short-term retention of records used for restoring essential business and server files when vital data has been lost.

**2.1.27 beginning of tape (BOT)** The location on a magnetic tape that indicates the beginning of the permissible recording area.

**2.1.28 BER** Basic Encoding Rules - used with ASN.1 (see X.209 standard)

**2.1.29 bezel** The frame that fits over the front of the tape drive. This includes a button and a message display.

**2.1.30 bit** The smallest unit of data in a computer. A bit (short for binary digit) has a single binary value or either 0b or 1b.

**2.1.31 BOP** Beginning of Partition - logical beginning of a data area (logical object 0)

**2.1.32 BOT** Beginning of tape.

**2.1.33 bpi** Bits per inch.

**2.1.34 BPI** Bytes per inch.

**2.1.35 buffer** A routine or storage used to compensate for a difference in rate of flow of data, or time of occurrence of events, when transferring data from one device to another.

**2.1.36 buffered mode** The buffered mode allows a number of logical objects to accumulate in the object buffer before the data is transferred to the medium or host device.

**2.1.37 byte** A byte is a unit of data comprised of 8 bits.

**2.1.38 CA** Contingent allegiance.

**2.1.39 capacity** See *media capacity*.

**2.1.40 cartridge** See *tape cartridge*.

**2.1.41 cartridge memory (CM)** A non-contact electronic module embedded in the cartridge that can be used to store and retrieve information.

**2.1.42 CC** Check Condition.

**2.1.43 CDB** Command descriptor block.

**2.1.44 cleaning cartridge** A tape cartridge that is used to clean the heads of a tape drive. Contrast with **data cartridge**.

**2.1.45 command** A control signal that initiates an operation or the beginning of a sequence of operations.

**2.1.46 command timeout** A host controlled period of time, following the issuance of a command where the host has not received a status response for that command.

**2.1.47 compaction** See **data compression**.

**2.1.48 compression** See **data compression**.

**2.1.49 contingent allegiance** (1) A condition in which a drive owes a response to a specific channel path because of a unit check. (2) A condition generated by a check condition status during which a target preserves sense data.

**2.1.50 conversion** The process of changing from one method of data processing to another or from one data-processing system to another.

**2.1.51 data** Any representations such as characters or analog quantities to which meaning is, or might be, assigned.

**2.1.52 data cartridge** A tape cartridge that is dedicated to storing data. Contrast with **cleaning cartridge**.

**2.1.53 data compression** An algorithmic data-reduction technique that encodes data from the host and stores it in less space than unencoded data. The original data is recovered by an inverse process called decompression.

**2.1.54 data compression ratio** The number of host data bytes divided by the number of encoded bytes. It is variable depending on the characteristics of the data being processed. The more random the data stream, the lower the opportunity to achieve compression.

**2.1.55 data transfer rate** The amount of data that can be stored on a tape cartridge with respect to time.

**2.1.56 dataset** The major unit of data storage and retrieval, consisting of a collection of data in one of several prescribed arrangements and described by control information to which the system has access.

**2.1.57 DCC** Deferred Check Condition, also known as **deferred unit check**.

**2.1.58 deferred unit check** A condition in which a drive returns a unit check indication for an event that occurred asynchronously with the channel commands. The deferred unit check normally does not refer to the command that receives the indication.

**2.1.59 DER** Distinguished Encoding Rules - a subset of BER

**2.1.60 design capacity** The lower range of **media capacity** that is expected and that should be accommodated (see 3.4.1).

**2.1.61 device** Any hardware component or peripheral that can receive and transmit data, such as a tape drive or tape library.

**2.1.62 device driver** An executable file or program installed on a host system used to control or access a device.

**2.1.63 diagnostic** A test or procedure designed to detect, recognize, locate, isolate or explain faults in equipment or errors in programs.

**2.1.64 diagnostic cartridge** A tape cartridge used to perform a diagnostic.

**2.1.65 digest** a cryptographically strong hash (i.e., SHA-x, MD-x)

**2.1.66 DK** Data Key - key used for encryption/decryption

**2.1.67 DKi** Data Key Identifier - a field in the EEDK(s)/SEDK and part of the DKi/IV recorded on media which associates the encryption of the record to EEDK(s) and ultimately a DK

**2.1.68 DKi/IV** Combined DKi and IV prepended to each record in the logical format

**2.1.69 drive** A device used to store data to media and subsequently restore data from media.

**2.1.70 drive dump** The recording, at a particular instant, of the contents of debug information into a buffer or onto medium for the purpose of retrieval for debug purposes.

**2.1.71 drive head** The component of a tape drive which converts and records an electrical signal to a magnetic signal on tape, and subsequently detects and converts such signals.

**2.1.72 drive loaded** A condition of a tape drive in which a tape cartridge has been inserted in the drive, and the tape has been threaded to the beginning-of-partition 0 position.

**2.1.73 effective data rate** The average number of a unit of data per unit time transferred from a data source to a data sink and accepted as valid. For example, the rates may be expressed in bits per second (bps), bytes per second (Bps), megabytes per second (MB/s), terabytes per hour (TB/hr), etc..

**2.1.74 eject** To remove or force from within. Generally refers to the last part of the unload process to allow removal of a tape cartridge from the drive.

**2.1.75 EKM** External Key Manager

**2.1.76 enable** To provide the means or opportunity. The modification of system, control unit, or device action through the change of a software module or a hardware switch (circuit jumper) position.

**2.1.77 enclosure** A device, such as a desktop unit, tape cartridge autoloader, or tape library, into which a tape drive may be installed.

**2.1.78 EOD** End Of Data - a dataset denoting the end of user data

**2.1.79 EOP** End of partition. This usually refers to Logical End of Partition (LEOP), but may refer to Physical End of Partition (PEOP).

**2.1.80 EOT** End of tape. This may refer to the physical end of tape or the logical end of tape.

**2.1.81 ERA** Error-recovery action.

**2.1.82 ERP** See error-recovery procedures (ERP)

**2.1.83 error log** Maintained by the drive, a list that contains recent error codes. The codes identify errors that pertain to the drive.

**2.1.84 error-recovery procedures (ERP)** (1) Procedures designed to help isolate and, where possible, to recover from errors in equipment. The procedures are often used in conjunction with programs that record the statistics of machine malfunctions. (2) Error-recovery procedures performed by the subsystem.

**2.1.85 explicitly activated** A process in which the attributes of an identifier are specified. Contrast with implicitly activated.

**2.1.86 extended contingent allegiance** (1) A condition caused by a permanent buffered-write error in which the drive responds only to the channel path group from which the write command was received. The extended contingent allegiance continues until a controlling computer in the channel path group retrieves the unwritten data from the buffer or issues a tape motion command. (2) A condition generated by an initiate recovery message to assist in extended error recovery procedures in multi-initiator systems.

**2.1.87 F-port** Fabric port.

**2.1.88 FC** Fibre Channel.

**2.1.89 FCP** Fibre Channel Protocol - the SCSI mapping to fibre channel

**2.1.90 fiber** A physical communication cable or connection used to attach two or more Fibre Channel devices.

**2.1.91 Fibre Channel** A standard interconnection interface used to attach host systems and/or peripheral devices.

**2.1.92 FID** Format Identification Dataset.

**2.1.93 field replaceable unit (FRU)** An assembly that is replaced in its entirety when any one of its components fails.

**2.1.94 file** A set of related records, treated as a unit; for example, in stock control, a file could consist of a set of invoices.

**2.1.95 file protected** Pertaining to a tape volume from which data can be read only. Data cannot be written on or erased from the tape.

**2.1.96 filemark** A logical object which is a demarcation, recorded on media, often used to separate files or provide other organizational structure to recorded data. Usage and convention of filemarks is controlled by the attached host system(s).

**2.1.97 FIPS** Federal Information Processing Standards

**2.1.98 firmware** Proprietary code that is usually delivered as part of an operating system or device. Firmware is more efficient than software loaded from an alterable medium, and is more adaptable to change than hardwired embedded logic.

**2.1.99 FL-port** Fabric loop port.

**2.1.100 FMR** Field microcode replacement.

**2.1.101 format** The arrangement or layout of data on a data medium.

**2.1.102 FRU** See field replaceable unit (FRU).

**2.1.103 GB** See gigabyte (GB).

**2.1.104 Gb** See gigabit (Gb).

**2.1.105 GCM** Galois Counter Mode

**2.1.106 gigabit (Gb)** 1 000 000 000 bits of storage.

**2.1.107 gigabyte (GB)** 1 000 000 000 bytes of storage.

**2.1.108 hard addressing** A method of specifying a fixed AL\_PA address for a device in a Fibre Channel loop configuration.

**2.1.109 hardware** The physical equipment or components that form a device or system.

**2.1.110 HBA** host bus adapter.

**2.1.111 head** See drive head

**2.1.112 host bus adapter** A specific type of adapter card which provides the connection to a physical device interconnect such as Fibre Channel.

**2.1.113 host system** A data-processing system that is used to prepare programs and the operating environments for use on another computer or controller.

**2.1.114 IBM Proprietary Protocol (IPP)** IBM vendor-specific method of configuring and controlling encryption

**2.1.115 IBM Tape Diagnostic Tool (ITDT)** The ITDT Tool offers multiple functional capabilities that simplify the task of updating tape and library firmware. It is available for most major platforms and requires no special device drivers. See

[https://www.ibm.com/support/fixcentral/options?selectionBean.selectedTab=find&selection=System+Storage%3bIBM%2fStorage\\_Tape%3bTape+drivers+and+software%3bIBM%2fStorage\\_Tape%2fIBM+Tape+Diagnostic+Tool+ITDT](https://www.ibm.com/support/fixcentral/options?selectionBean.selectedTab=find&selection=System+Storage%3bIBM%2fStorage_Tape%3bTape+drivers+and+software%3bIBM%2fStorage_Tape%2fIBM+Tape+Diagnostic+Tool+ITDT)

**2.1.116 ID** identifier

**2.1.117 implicitly activated** A process in which the attributes of an identifier are determined by default. Contrast with explicitly activated.

**2.1.118 initiator** A SCSI device that requests an I/O process to be performed by another SCSI device (a target). In some cases, an initiator can also be a target.

**2.1.119 input/output (I/O)** Data that is provided to a computer or data that results from computer processing.

**2.1.120 install** To set up for use or service. The act of adding a product, feature, or function to a system or device either by a singular change or by the addition of multiple components or devices.

**2.1.121 interchange application** The preparation of tapes for use on other systems or devices, either local or remote, or the use of tape data prepared by another system.

**2.1.122 Internet** The worldwide collection of interconnected networks that use the Internet suite of protocols and permit public access.

**2.1.123 invoke** To petition for help or support. The request for a feature or function to be utilized in future processing activities through the use of software or hardware commands.

**2.1.124 I/O** input/output (I/O).

**2.1.125 IPP** IBM Proprietary Protocol (IPP).

**2.1.126 ITDT** IBM Tape Diagnostic Tool (ITDT).

**2.1.127 IV** Initialization Vector - a value also called a nonce, used with a key for AES block ciphers

**2.1.128 journaling** Recording transactions against a dataset so that the dataset can be reconstructed by applying transactions in the journal against a previous version of the dataset.

**2.1.129 KB** See kilobyte.

**2.1.130 kibibyte** 1024 bytes of storage.

**2.1.131 KiB** See kibibyte.

**2.1.132 kilobyte** 1000 bytes of storage.

**2.1.133 L-port** Arbitrated Loop Fibre Channel host connection. May attach to a fabric (switch) FL-port.

**2.1.134 LDI** Library Drive Interface - a specific interface protocol for tape device to automation interface (over RS-422)

**2.1.135 LEOT** logical end of tape

**2.1.136 Linear Tape-Open (LTO)** A type of tape storage technology developed by the IBM Corporation, Hewlett-Packard, and Quantum (formerly Seagate). LTO technology is an "open format" technology, which means that its users have multiple sources of product and media. The "open" nature of LTO technology enables compatibility between different vendors' offerings by ensuring that vendors comply with verification standards.

**2.1.137 LN\_Port** Fibre Channel host attachment configuration in which the drive attempts to negotiate first to Arbitrated Loop (NL-port), then Point-to-Point (N-port). May attach to a fabric (switch) F-port or FL-port. This may be thought of as L->N negotiation.

**2.1.138 load** Following the insertion of a tape cartridge into the device, the act of positioning the tape (performed by the drive) for subsequent reading or writing.

**2.1.139 load point** The beginning of the recording area on magnetic tape.

**2.1.140 logical block** A unit of data transferred between an initiator and the drive. See record.

**2.1.141 logical end of tape** A point on the tape where written data normally ends.

**2.1.142 logical object** A logical block or a filemark.

**2.1.143 LPOS** Longitudinal Position.

**2.1.144 LSB** Least significant byte.

**2.1.145 lsb** Least significant bit.

**2.1.146 LTO** Linear Tape-Open (LTO).

**2.1.147 LTO-DC** LTO Data Compression (LTO-DC).

**2.1.148 LTO Data Compression (LTO-DC)** A method that compresses logical objects before the drive writes them to tape. LTO-DC encodes and detects record boundaries and file markers (which are encoded as control symbols). It also allows switching between compression and no compression within the data stream, which prevents data from expanding when the drive compresses random or encrypted data.

**2.1.149 LUN** Logical unit number.

**2.1.150 MAC** Message Authentication Code - a digest which validates encrypted data. Appended to each encrypted record in the logical format for cryptographic integrity validation

- 2.1.151 magnetic recording** A technique of storing data by selectively magnetizing portions of a magnetizable material.
- 2.1.152 magnetic tape** A tape with a magnetizable surface layer on which data can be stored by magnetic recording.
- 2.1.153 magnetic tape drive** A mechanism for moving magnetic tape and controlling its movement.
- 2.1.154 MAM** Medium Auxiliary Memory (MAM).
- 2.1.155 Management Information Base (MIB)** A computing information repository used by Simple Network Management Protocol (SNMP)
- 2.1.156 manual mode** A mode of operation that can be selected on a cartridge loader or library. This mode allows a single tape cartridge feed, performed by the operator.
- 2.1.157 MB** See megabyte (MB).
- 2.1.158 Mb** See megabit (Mb).
- 2.1.159 mebibit (Mib)** 1 048 576 bits of storage (i.e.,  $2^{20}$ )
- 2.1.160 mebibyte (MiB)** 1 048 576 bytes of storage (i.e.,  $2^{20}$ )
- 2.1.161 media** Plural of medium.
- 2.1.162 media capacity** The amount of data that can be contained on storage media and expressed in units of data, usually gigabyte (GB) or terabyte (TB).
- 2.1.163 medium** A physical material in or on which information may be represented, such as magnetic tape.
- 2.1.164 Medium Auxiliary Memory (MAM)** A non-volatile memory. MAM is used to store data that describes the media and its contents. MAM is usually stored on cartridge memory (CM).
- 2.1.165 megabit (Mb)** 1 000 000 bits of storage (i.e.,  $10^6$ ).
- 2.1.166 megabyte (MB)** 1 000 000 bytes of storage (i.e.,  $10^6$ ).
- 2.1.167 Mib** mebibit (Mib).
- 2.1.168 MiB** mebibyte (MiB).
- 2.1.169 microcode** Embedded device programming which controls the behavior and functioning of the device.
- 2.1.170 microprocessor** An integrated circuit that accepts coded instructions for execution; the instructions may be entered, integrated, or stored internally.
- 2.1.171 microsecond ( $\mu$ s)** One millionth of a second (0.000 001 s).
- 2.1.172 migration** See conversion.
- 2.1.173 millisecond (ms)** One thousandth of a second (0.001 s)
- 2.1.174 MIM** Medium Information Message.
- 2.1.175 msb** Most significant bit.



**2.1.176 MSB** Most significant byte.

**2.1.177 N-port** Point-to-Point Fibre Channel host connection. May attach to a fabric (switch) FL-port.

**2.1.178 N/A** Not Applicable.

**2.1.179 native data transfer rate** The amount of data that can be stored without compression on a tape cartridge with respect to time.

**2.1.180 native storage capacity** The amount of data that can be stored without compression on a tape cartridge.

**2.1.181 NL\_Port** Fibre Channel host attachment configuration in which the drive port attempts to negotiate first to Point-to-Point (N-port), then Arbitrated Loop (NL-port). May attach to a fabric (switch) F-port or FL-port. This may be thought of as N->L negotiation.

**2.1.182 node** Fibre channel term for the logical connection to a device.

**2.1.183 nominal capacity** The nominal media capacity.

**2.1.184 nonce** number used once - a value used in conjunction with the key for AES block ciphers (also IV)

**2.1.185 OEM** Original equipment manufacturer.

**2.1.186 offline** An operating condition where the host system cannot interact with the drive through the specified interface.

**2.1.187 online** An operating condition where the host system can interact normally with the drive through the specified interface.

**2.1.188 OOB** Out-Of-Band

**2.1.189 open system** Computer systems whose operating standards and methods are not proprietary.

**2.1.190 operating system** The master computer control program that translates the user commands and allows software application programs to interact with the computer hardware and attached devices.

**2.1.191 OSI** Open Systems Interconnection - (see X.200 standard)

**2.1.192 overwrite** A write operation that records a logical object in a logical position that is not an append point (see 4.2.3).

**2.1.193 parity** The state of being even-numbered or odd-numbered. A parity bit is a binary number that is added to a group of binary numbers to make the sum of that group always odd (odd parity) or even (even parity) which is commonly used for error detection.

**2.1.194 PEOT** physical end of tape (PEOT)

**2.1.195 physical end of tape (PEOT)** A point on the tape beyond which the tape is not permitted to move.

**2.1.196 PKCS** Public-Key Cryptography Standards

**2.1.197 POR** Power-on reset.

**2.1.198 port** Fibre channel or SAS term for the physical connection to a device.

**2.1.199 power-off** To remove electrical power from a device.

- 2.1.200 power-on** To apply electrical power to a device.
- 2.1.201 powered-on** The state of a device when power has been applied to it.
- 2.1.202 primed** Pertaining to a condition of a tape drive when the controlling computer addresses the drive but the drive is not in a ready state.
- 2.1.203 PRNG** Pseudo Random Number Generator
- 2.1.204 processing application** The execution of a systematic sequence of operations performed on data to accomplish a specific purpose.
- 2.1.205 protocol** The meanings of, and the sequencing rules for, requests and responses that are used to manage a network, transfer data, and synchronize the states of network components.
- 2.1.206 quiesce** To bring a device or system to a halt by a rejection of new requests for work.
- 2.1.207 read** To acquire or interpret data from a storage device, from a data medium, or from another source.
- 2.1.208 read-type commands** Any commands that cause data to be read from tape or affect buffered read data.
- 2.1.209 reboot** To reinitialize the execution of a program by repeating the initial program load (IPL) operation.
- 2.1.210 record** A logical object that contains user data (e.g., not a filemark).
- 2.1.211 recording density** The number of bits in a single linear track measured per unit of length of the recording medium.
- 2.1.212 reset** To return a device, circuit, or value to a clear state.
- 2.1.213 retension (or refresh)** The process or function of tightening the tape onto the cartridge, if it is sensed that the tape has a loose wrap on the cartridge.
- 2.1.214 RS-422 connector** Located at the rear of the device, the connector to which the internal RS-422 cable of an enclosure connects. The connection enables a library (i.e., medium changer) to communicate with the drive.
- 2.1.215 RS-422 interface** An electrical interface standard that is approved by the Electronic Industries Association (EIA) for connecting serial devices.
- 2.1.216 RSA** Method authored by Rivest, Shamir, Adleman
- 2.1.217 s** second
- 2.1.218 SAN** Storage Area Network.
- 2.1.219 SAS** Serial Attached SCSI
- 2.1.220 SCSI** Small Computer System Interface.
- 2.1.221 SCSI device** A host adapter or a target controller that can be attached to the SCSI bus.
- 2.1.222 SCSI ID** The identifier used to uniquely identify the address on the bus. When used on Fibre Channel devices this refers to the AL\_PA.

**2.1.223 SCSI Sense Data** In response to a command from the server, a packet of SCSI sense bytes that contains information about the error that is sent back to the server by the drive in autosense. SCSI Sense Data may also be returned by the REQUEST SENSE command, but that sense data is usually unsolicited sense data and does not contain error information.

**2.1.224 sense data** SCSI Sense Data.

**2.1.225 Serial Attached SCSI (SAS)** A transport for exchanging information between SCSI devices using a standardized serial interconnect.

**2.1.226 server** A functional unit that provides services to one or more clients over a network. Synonymous with host system.

**2.1.227 SHA** Secure Hash Algorithm (can be SHA-1 (160 bit), or SHA-2 algorithms at differing bit strengths shortened to SHA-256, SHA-384, SHA-512, for bit size)

**2.1.228 SIM** Service Information Message.

**2.1.229 Small Computer Systems Interface (SCSI)** A standard used by computer manufacturers for attaching peripheral devices (such as tape drives, hard disks, CD-ROM players, printers, and scanners) to computers (servers). Pronounced "scuzzy."

**2.1.230 soft addressing** A method of specifying a standard arbitration method for assigning an AL\_PA for a device in a Fibre Channel loop configuration.

**2.1.231 software** Programs, procedures, rules, and any associated documentation pertaining to the operation of a computer system.

**2.1.232 special feature** A specific design addition to an IBM product that is quoted in the IBM Sales Manual and ordered separately.

**2.1.233 standard function** The significant design elements of an IBM product that are included as part of the basic standard product.

**2.1.234 Storage Area Network (SAN)** A high-speed subnetwork of shared storage devices. A SAN's architecture makes all storage devices available to all servers on a LAN or WAN. As more storage devices are added to a SAN, they too will be accessible from any server in the larger network. Because stored data does not reside directly on any of a network's servers, server power is used for business applications, and network capacity is released to the end user.

**2.1.235 switch** A network infrastructure component to which multiple nodes attach. Unlike hubs, switches typically have the ability to switch node connections from one to another. A typical switch can facilitate several simultaneous bandwidth transmissions between different pairs of nodes.

**2.1.236 synchronization** The process of coordinating the activities of the controlling computer and the magnetic tape subsystem to obtain the condition in which the buffer is empty and the tape is in the correct position for the next operation.

**2.1.237 T10** ANSI group responsible for SCSI model and command sets, see <http://www.t10.org>

**2.1.238 T11** ANSI group responsible for FCP/fibre channel protocols, see <http://www.t11.org>

**2.1.239 TB** see terabyte (TB).

**2.1.240 tape** Commonly refers to magnetic tape or the tape cartridge.

- 2.1.241 tape cartridge** A container holding magnetic tape that can be processed without separating it from the container.
- 2.1.242 tape drive** A device that is used for moving magnetic tape and includes the mechanisms for writing and reading data to and from the tape.
- 2.1.243 tape unit** A device that contains tape drives and their associated power supplies and electronics.
- 2.1.244 TapeAlert** A patented technology and ANSI standard that defines conditions and problems that are experienced by tape drives.
- 2.1.245 TapeAlert flags** Status and error messages that are generated by the TapeAlert utility and are reported to a host system.
- 2.1.246 target** A SCSI device that performs an operation requested by the initiator.
- 2.1.247 target routine** A target routine is an I/O process directed to a target, and not to a logical unit.
- 2.1.248 terabyte (TB)** 1\_000\_000\_000\_000 bytes of storage.
- 2.1.249 topology** In communications, the physical or logical arrangement of nodes in a network, especially the relationships among nodes and the links between them.
- 2.1.250 transfer rate** data transfer rate.
- 2.1.251 TRNG** True Random Number Generator
- 2.1.252 TSM** Tivoli Storage Manager
- 2.1.253 tuple** An ordered set of values or elements.
- 2.1.254 Type A cartridge** A cartridge that has the capacity, density, and tracks as defined in the format specification for the generation that introduced this physical cartridge (e.g., for the Ultrium 7 cartridge, the U-732).
- 2.1.255 Type M cartridge** A cartridge that provides a feature different than a Type A cartridge. For LTO-8, this is an Ultrium 7 cartridge that has a capacity of 9 000 GB and reports unique density information (see 5.2.26).
- 2.1.256 Type M eligible** A cartridge that meets the definition of a new cartridge for the purpose of the cartridge being eligible to be changed to a Type M cartridge.
- 2.1.257 unload** The act (performed by the drive) of unthreading tape from the drive's internal tape path and returning it (with the leader block) to the tape cartridge.
- 2.1.258 universal time (UT)** The time at longitude zero, colloquially known as Greenwich Mean Time. See <http://www.usno.navy.mil/USNO/time/master-clock/systems-of-time>.
- 2.1.259 vital product data** Non-volatile information including configuration, calibration, etc., used to control the behavior and operation of the device.
- 2.1.260 volume** (1) A certain portion of data, together with its data carrier, that can be handled conveniently as a unit. (2) A data carrier that is mounted and demounted as a unit, for example, a reel of magnetic tape, a disk pack.
- 2.1.261 volume coherency set:** A set of information contained in logical objects including a volume coherency count (see 4.20) for which coherency across an entire volume is desired.

**2.1.262 VPD** Vital Product Data - information stored in drive nonvolatile memory

**2.1.263 web** World Wide Web (www).

**2.1.264 World Wide Name** A unique, 8-byte identifier that is assigned by IBM Manufacturing to each tape drive and used to identify a drive.

**2.1.265 World Wide Web (www)** A network of servers that contain programs and files. Many of the files contain hypertext links to other documents that are available through the network.

**2.1.266 WORM (Write Once, Read Many)** A write or append methodology for allowing data to be written only once, disallowing overwriting.

**2.1.267 write** To store or encode data to a storage device, to data medium, or to another source.

**2.1.268 Write Once, Read Many (WORM)** A write or append methodology for allowing data to be written only once, disallowing overwriting.

**2.1.269 write protected** A state disallowing write operations to a device or medium.

**2.1.270 write-type commands** Any commands that cause data to be written on tape or affect buffered write data.

## 2.2 Conventions

### 2.2.1 Radix representation

Binary numbers are represented by numbers followed by b. Hexadecimal numbers are represented by 0-9 and A-F followed by h. Numbers with no suffix can be assumed to be decimal.

### 2.2.2 Bit Numbering

Bit numbering follows ANSI standards as follows:

- Bit 7 is the most significant bit (msb) occupying the leftmost bit position in the diagrams
- Bits 6 through 1 continue from left to right in descending order
- Bit 0 is the least significant bit (lsb) occupying the rightmost bit position in the diagrams

### 2.2.3 Units of measure for data storage

Decimal units such as KB, MB, GB, and TB have commonly been used to express data storage values. Some environments, such as programming or memory values often use binary units such as KiB, MiB, GiB, and TiB. At the kilobyte level, the difference between decimal and binary units of measurement is relatively small (2.4%). This difference grows as data storage values increase, and when values reach terabyte levels the difference between decimal and binary units approaches 10% as detailed later in this section. Given this difference it is important to understand and use the expected unit for each particular value to maximize accuracy.

This document represents values using both decimal units and binary units. Values are represented by the following formats:

- for decimal units:  
the value 3.5 terabytes is displayed as 3.5 TB ( $10^{12}$ );
- for binary units:  
the value 400 mebibytes per second is displayed as 400 MiB/sec ( $2^{20}$ )
- for an indication that all values in a row of a table are in specific units a statement is made in the left-most column:

Table 1 compares the names, symbols, and values of the binary and decimal units. Table 2 shows the increasing percentage of difference between binary units and decimal units.

**Table 1 — Comparison of binary and decimal units and values**

Decimal			Binary		
Name	Symbol	Value (base-10)	Name	Symbol	Value (base-2)
kilo	K	$10^3$	kibi	Ki	$2^{10}$
mega	M	$10^6$	mebi	Mi	$2^{20}$
giga	G	$10^9$	gibi	Gi	$2^{30}$
tera	T	$10^{12}$	tebi	Ti	$2^{40}$
peta	P	$10^{15}$	pebi	Pi	$2^{50}$
exa	E	$10^{18}$	exbi	Ei	$2^{60}$

**Table 2 — Percentage difference between binary and decimal units**

Decimal Value	Binary Value	Percentage Difference
100 kilobytes (KB)	97.65 kibibytes (KiB)	2.35%
100 megabytes (MB)	95.36 mebibytes (MiB)	4.64%
100 gigabytes (GB)	93.13 gibibytes (GiB)	6.87%
100 terabytes (TB)	90.94 tebibytes (TiB)	9.06%
100 petabytes (PB)	88.81 pebibytes (PiB)	11.19%
100 exabytes (EB)	86.73 exbibytes (EiB)	13.27%

### 2.2.4 Subpages

When pages have subpages (e.g., Mode Pages, Log Pages) the convention used for Page XXh Subpage YYh is Page XXh[YYh].

When describing Security Protocol XXh with Security Protocol Specific YYYYh in the Security Protocol In command or the Security Protocol Out command XXh[YYYYh] is used.

### 2.2.5 ,Hyperlinks

This document contains many hyperlinks. Every place the text says “see clause number” should be a hyperlink. Hyperlinks have been given a special font to offset them from the rest of the text. That font is demonstrated in this following link (see 2.2.5)

## 2.3 Tape Drive Model Names

From this section forward, through the remainder of this book, Tape Drive models are referred to collectively as the LTO tape drive, the Ultrium tape drive or the 3580 tape drive. There are both a Full-High version and a Half-High version, they will be referred to as FH for Full-High and HH for Half-High. LTO drives are also available with different host attachment interfaces, referred to as FC for Fibre Channel and SAS for Serially Attached SCSI. LTO drives are also referred to by generation. Various combinations of these may be used where the differences are meaningful and described in this document. Some examples include: LTO6, LTO7 FH, LTO8 HH FC, etc.





### 3. Introduction

#### 3.1 Drive Overview

The products that are discussed in this book are high-performance, high-capacity data-storage devices that connect to and provide additional storage for supported servers. They include the LTO5 through LTO9 models of the IBM® LTO Ultrium Tape Drive.

All products use the Small Computer Systems Interface (SCSI) Architecture Model. The transports used are shown in table 3.

Figure 1 shows the IBM 3580 Ultrium Tape Drive and the IBM System Storage LTO Ultrium Tape Drive Model T200. The IBM System Storage TS2350 Tape Drive Express is similar to the IBM System Storage LTO Ultrium Tape Drive Model T200 and the IBM System Storage TS2250 Tape Drive Express is half the height.

**Figure 1 — IBM System Storage Ultrium Tape Drive Models.**

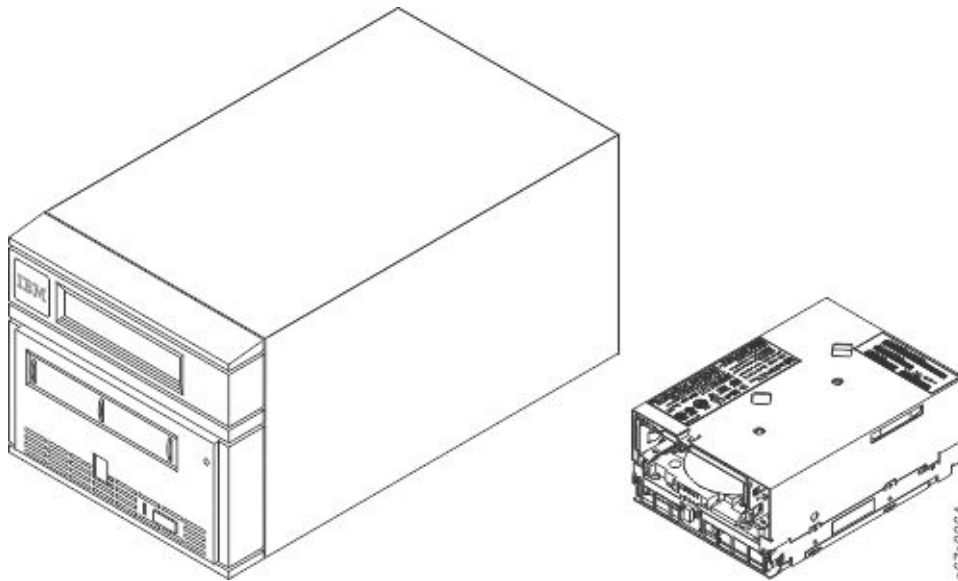

Designed to perform unattended backups as well as to retrieve and archive files, the Ultrium Tape Drives include the features that are described in table 3.

**Table 3 — Features of the IBM Ultrium Tape Drives and the IBM 3580 Ultrium Tape Drive (part 1 of 2)**

Feature	Ultrium 5	Ultrium 6	Ultrium 7	Ultrium 8 <sup>h</sup>	Ultrium 9 <sup>h</sup>
Native storage capacity	1500 GB	2500 GB	6000 GB	12000 GB	18 000 GB
Storage capacity when compression is enabled <sup>a</sup>	3.0 TB	6250 GB	15000 GB	30000 GB	45 000 GB
Native sustained data transfer rate	140 MB/s	160 MB/s	300 MB/s	360 MB/s <sup>d</sup>	400 MB/s <sup>d</sup>
Data transfer rate when compression is enabled <sup>a</sup>	280 MB/s	400 MB/s	700 MB/s <sup>e</sup> 500 MB/s <sup>f</sup>	700 MB/s <sup>e</sup> 500 MB/s <sup>f</sup>	700 MB/s <sup>e</sup> 900 MB/s <sup>g</sup>
Burst data transfer rate (1GFC)	100 MB/s	100 MB/s	100 MB/s	100 MB/s	100 MB/s
Burst data transfer rate (2GFC)	200 MB/S	200 MB/S	200 MB/S	200 MB/S	200 MB/S

**Table 3 — Features of the IBM Ultrium Tape Drives and the IBM 3580 Ultrium Tape Drive** (part 2 of 2)

Feature	Ultrium 5	Ultrium 6	Ultrium 7	Ultrium 8 <sup>h</sup>	Ultrium 9 <sup>h</sup>
Burst data transfer rate (4GFC)	400 MB/s	400 MB/s	400 MB/s	400 MB/s	400 MB/s
Burst data transfer rate (8GFC)	800 MB/s	800 MB/s	800 MB/s	800 MB/s	800 MB/s
Burst data transfer rate (3G SAS)	300 MB/s	300 MB/s	300 MB/s	300 MB/s	300 MB/s
Burst data transfer rate (6G SAS)	600 MB/s	600 MB/s	600 MB/s	600 MB/s	600 MB/s
Burst data transfer rate (12G SAS)	Not Supported				1 200 MB/s
Type of interface	LC-D <sup>b</sup> SAS <sup>c</sup>	LC-D <sup>b</sup> SAS <sup>c</sup>	LC-D <sup>b</sup> SAS <sup>c</sup>	LC-D <sup>b</sup> SAS <sup>c</sup>	LC-D <sup>b</sup> SAS <sup>c</sup>
<p>Note - All sustained data rates are dependent on the capabilities of the interconnect (for example, a 8GFC link is limited to less than 800MB/sec). All information assumes same generation media and drive.</p> <p><sup>a</sup> Generation 5 nominal compression ratio is 2:1. Subsequent generations nominal compression ratio is 2.5:1. Depending on the data, the compression ratio may be higher or lower.</p> <p><sup>b</sup> LC-D: LC-Duplex Fibre Channel, with the use of SCSI protocol</p> <p><sup>c</sup> SAS: Serial-Attached SCSI</p> <p><sup>d</sup> LTO8 and LTO9 Half-High drives have a native sustained data transfer rate of 300 MB/s</p> <p><sup>e</sup> When using an 8GFC interface</p> <p><sup>f</sup> When using a 6 Gbps SAS interface</p> <p><sup>g</sup> When using a 12Gbps SAS interface</p> <p><sup>h</sup> see 3.4.1 on page 23</p>					

## 3.2 Supported Servers and Operating Systems

The Ultrium Tape Drives are supported by a wide variety of servers and operating systems, as well as adapters. These attachments can change throughout the products' life cycles. To determine the latest supported attachments, visit the web at <https://www-03.ibm.com/systems/support/storage/ssic/interoperability.wss>.

### 3.2.1 Primary Interface Attachment

The Ultrium Tape Drives attach to servers and operating systems shown in table 4. An attachment includes (but is not limited to) the servers and operating systems in the table.

For specific instructions about attachment, see one or more of the following:

- a) *IBM System Storage TS2350 Tape Drive Setup, Operator, and Service Guide, GC27-2277-00.*

**Table 4 — Supported Servers and Operating Systems for Primary Interface Attachment**

Supported Servers	Supported Operating Systems
zSeries® s390x platform	zLinux (RHEL and SLES)
IBM Power Systems	IBM i®
IBM Power Systems	AIX®
IBM Power Systems	Linux® (RHEL and SLES)
Sun Microsystems	Solaris

**Table 4 — Supported Servers and Operating Systems for Primary Interface Attachment**

Supported Servers	Supported Operating Systems
32-bit, Intel-compatible servers	Windows Server
	Linux® (RHEL and SLES)
64-bit, Intel-compatible servers	Windows Server
	Linux® (RHEL and SLES)
<b>Supported SAN Components for Fibre Channel Attachment</b> Visit the web at: <a href="http://www-03.ibm.com/systems/support/storage/ssic/interoperability.wss">http://www-03.ibm.com/systems/support/storage/ssic/interoperability.wss</a>	

### 3.3 Supported Device Drivers

IBM maintains the latest levels of device drivers and driver documentation for the IBM Ultrium Tape Drives on the Internet. You can access this material from your browser or through the IBM FTP site by performing one of the following procedures. **(Note: If you do not have Internet access and you need information about device drivers, contact your Marketing Representative.)**

Using a browser, go to one of the following websites:

- a) The IBM storage website at <http://www.ibm.com/storage>; or
- b) The IBM Fix Central website at <http://www.ibm.com/support/fixcentral>. This is a portal to enter the download area. There are a few pull down menus to get you to the correct download as follows:
  - 1) in menu labeled "Product Group" select "Storage Systems";
  - 2) in menu labeled "Product Family" select "Tape Systems";
  - 3) in menu labeled "Product Type" select "Tape Device Drivers and Software";
  - 4) in menu labeled "Product" select "Tape Device Drivers";
  - 5) in menu labeled "Platform" select the correct operating system. You can select the generic form of the platform (e.g., Linux) and all device drivers for that platform will come up;
  - 6) click continue; and
  - 7) select the checkbox(es) of the fix pack(s) needed and click continue.

### 3.4 Supported Tape Cartridges

The IBM LTO Ultrium Tape Drives support LTO Cartridges as described in table 5.

**Table 5 — LTO capacities by density, cartridges, and products**

DENSITY NAME Colloquial Term	Cartridge	Supported by				
		LTO5	LTO6	LTO7	LTO8	LTO9
<b>U-316</b> LTO-3 Format		RO	-	-	-	-
	L3/LT	400 GB	-	-	-	-
<b>U-416</b> LTO-4 Format		WR	RO	-	-	-
	L4/LU	800 GB	800 GB	-	-	-
<b>U-516</b> LTO-5 Format		WR	WR	RO	-	-
	L5/LV	1 500 GB	1 500 GB	1 500 GB	-	-
<b>U-616</b> LTO-6 Format		-	WR	WR	-	-
	L6/LW	-	2 500 GB	2 500 GB	-	-
<b>U-732</b> LTO-7 Format		-	-	WR	WR	-
	L7/LX	-	-	6 000 GB	6 000 GB	-
<b>U-832M</b> LTO-8 Type M Format		-	-	-	WR	-
	M8 <sup>a</sup>	-	-	-	9 000 GB	-
<b>U-832</b> LTO-8 Format		-	-	-	WR	WR
	L8/LY <sup>a</sup>	-	-	-	12 000 GB	12 000 GB
<b>U-932</b> LTO-9 Format		-	-	-	-	WR
	L9/LZ <sup>a</sup>	-	-	-	-	18 000 GB

Key:

-	Not Supported	Values in GB (10 <sup>9</sup> ) native capacity (no compression)	
RW	Read/Write	RO	Read Only
L3	Generation 3 DATA	LT	Generation 3 WORM
L4	Generation 4 DATA	LU	Generation 4 WORM
L5	Generation 5 DATA	LV	Generation 5 WORM
L6	Generation 6 DATA	LW	Generation 6 WORM
L7	Generation 7 DATA	LX	Generation 7 WORM
M8	Generation 8 Type M DATA		
L8	Generation 8 DATA	LY	Generation 8 WORM
L9	Generation 9 DATA	LZ	Generation 9 WORM

<sup>a</sup> see 3.4.1 on page 23

The Ultrium 9 Tape Drive (Generation 9) uses the IBM TotalStorage 18 000 GB Data Cartridge, and is compatible with the cartridges of its predecessor (called Generation 8). The Ultrium 9 Tape Drive performs the following functions:

- Reads and writes Generation 9 cartridges to Generation 9 format
- Reads and writes Generation 8 cartridges to Generation 8 format
- Does not write Generation 9 cartridges to other generations' format
- Does not write Generation 8 cartridges to other generations' format
- Does not write or read Generation 1 through Generation 7 cartridges in any format. This includes the M8 format.

The Ultrium 8 Tape Drive (Generation 8) uses the IBM TotalStorage 12000 GB Data Cartridge, and is compatible with the cartridges of its predecessor (called Generation 7). The Ultrium 8 Tape Drive performs the following functions:

- Reads and writes Generation 8 cartridges to Generation 8 format

- b) Changes eligible Generation 7 Type A (i.e., L7) cartridges to Generation 8 Type M (i.e., M8) cartridges
- c) Reads and writes M8 cartridges to M8 format
- d) Reads and writes Generation 7 Type A cartridges to Generation 7 format
- e) Does not write Generation 8 Type A cartridges to other generations' format
- f) Does not write Generation 8 Type M cartridges to other generations' format
- g) Does not write Generation 7 Type A cartridges to other generations' format
- h) Does not write or read Generation 1 through Generation 6 cartridges in any format

The Ultrium 7 Tape Drive (Generation 7) uses the IBM TotalStorage 6000 GB Data Cartridge, and is compatible with the cartridges of its predecessors (called Generation 5 and Generation 6). The Ultrium 7 Tape Drive performs the following functions:

- a) Reads and writes Generation 7 cartridges to Generation 7 format
- b) Reads and writes Generation 6 cartridges to Generation 6 format
- c) Reads Generation 5 cartridges in Generation 5 format
- d) Does not write cartridges to other generations' format
- e) Does not write Generation 5 cartridges
- f) Does not write or read Generation 1, Generation 2, Generation 3, or Generation 4 cartridges in any format

The Ultrium 6 Tape Drive (Generation 6) uses the IBM TotalStorage 2500 GB Data Cartridge, and is compatible with the cartridges of its predecessors (called Generation 4 and Generation 5). The Ultrium 6 Tape Drive performs the following functions:

- a) Reads and writes Generation 6 cartridges to Generation 6 format
- b) Reads and writes Generation 5 cartridges to Generation 5 format
- c) Reads Generation 4 cartridges in Generation 4 format
- d) Does not write cartridges to other generations' format
- e) Does not write Generation 4 cartridges
- f) Does not write or read Generation 1, Generation 2, or Generation 3 cartridges in any format

The Ultrium 5 Tape Drive (Generation 5) uses the IBM TotalStorage 1500 GB Data Cartridge, and is compatible with the cartridges of its predecessors (called Generation 3 and Generation 4). The Ultrium 5 Tape Drive performs the following functions:

- a) Reads and writes Generation 5 cartridges to Generation 5 format
- b) Reads and writes Generation 4 cartridges to Generation 4 format
- c) Reads Generation 3 cartridges in Generation 3 format
- d) Does not write cartridges to other generations' format
- e) Does not write Generation 3 cartridges
- f) Does not write or read Generation 1 cartridges or Generation 2 cartridges in any format

### 3.4.1 Design Capacity

The capacities referenced throughout this book are based on the **nominal capacity**. From LTO-8 format types and later, it has become more critical that systems be designed taking into consideration the lower range of media

capacity that is expected and that should be accommodated (i.e., the design capacity). Table 6 shows the design capacity values for each cartridge.

**Table 6 — LTO design capacities by density and cartridges**

<u>DENSITY NAME</u> Colloquial Term	Cartridge	Nominal Capacity	Design Capacity
<b>U-832M</b> LTO-8 Type M Format	M8	9 000 GB	8 400 GB
<b>U-832</b> LTO-8 Format	L8/LY	12 000 GB	11 600 GB
<b>U-932</b> LTO-9 Format	L9/LZ	18 000 GB	17 400 GB

Values in GB (10<sup>9</sup>) native capacity (no compression)  
 Key:  
 M8 Generation 8 Type M DATA  
 L8 Generation 8 DATA  
 LY Generation 8 WORM  
 L9 Generation 9 DATA  
 LZ Generation 9 WORM  
 NOTE: see table 5 for Drive cartridge support.

### 3.5 Microcode Detection of Errors

The drive microcode is designed to check for logic errors, to handle hardware-detected errors, and to detect and report microcode-related errors.

#### 3.5.1 Fencing Behavior

For a description of the Fencing Behavior and Persistent Error handling, see Persistent Errors (see 4.19.5 on page 65).

## 4. Implementation Considerations

### 4.1 Media Optimization (LTO9+)

Media optimization is a new feature for the LTO9 tape drive with L9/LZ media.

The increased number of tracks used to write data on tape requires greater precision. Media optimization creates a referenced calibration for each cartridge that enables the tape drive's intelligent alignment to optimize data placement. LTO-9 media optimization enhances LTO tape long-term media durability.

It is important to consider when media optimization is performed:

- a) Media optimization is performed on first load of L9/LZ media during initialization.
- b) Recommendation is to perform first load in the location of deployment, which should be in a stable environment that meets the recommended environmental specification (see Product Document for details).
- c) Media optimization is a one-time operation that can be completed on any drive in the environment, enabling the media to be used across all tape drives without further optimization.

Other considerations for media optimization:

- a) Media optimization averages 40 minutes per first load of a cartridge to a tape drive. Although most media optimizations will complete within 60 minutes some media optimizations may take up to 2 hours.
- b) Interruption of the process is not recommended.
- c) A different mount will not necessarily improve the time to complete the one-time optimization.

Media optimization may be requested by:

- a) Using the FORMAT MEDIUM command. For details on the FORMAT MEDIUM command options that re-optimize a cartridge refer to [FORMAT MEDIUM - 04h](#) (see 5.2.3 on page 80).

===== WARNING ===== WARNING =====  
 Performing a FORMAT MEDIUM destroys all data on the cartridge including user MAM data.

===== WARNING ===== WARNING =====

- b) The MEDIUM OPTIMIZATION NEEDED MAM attribute may be used to force a Medium Optimization by setting it's value to TRUE

On first use of an L9/LZ cartridge that has its MEDIUM OPTIMIZATION NEEDED (ATTRIBUTE IDENTIFIER 1010h) MAM attribute set to TRUE, the load automatically performs the same optimization. The MEDIUM OPTIMIZATION NEEDED MAM attribute may be set to TRUE by using the WRITE ATTRIBUTE command when the tape is empty (see 6.5.2.5.3). Upon successful completion of a media optimization the MEDIUM OPTIMIZATION NEEDED MAM attribute is set to FALSE.

For best practices, refer to [LTO-9 Cartridge Initialization](#) (see E.3. on page 499).

### 4.2 Write modes

#### 4.2.1 Write mode introduction

Write modes of the device entity specify the allowable behaviors for altering logical objects on a mounted volume. When the write mode rules allow altering of logical objects then the operation shall be processed following the write protection rules defined in SSC-4 clause 4.2.14 (i.e., Write Protection).

#### 4.2.2 Overwrite-allowed mode

Overwrite-allowed mode is used to allow alteration of any logical object on the medium. Overwrite-allowed mode is enabled or disabled using the WRITE MODE field of the Device Configuration Extension mode page (see 6.6.12).

This mode is set in the device entity to enable device server behaviors. The overwrite-allowed mode does not modify the volume. When the volume is removed from the device no indication of whether overwrite-allowed mode is enabled or disabled is carried with the volume.

When overwrite-allowed mode is enabled in the drive, then any command that would result in a write shall be processed normally. If the mounted volume is a WORM volume, then a write type command shall be processed following the WORM rules.

#### 4.2.3 Append-only mode (also known as Data-safe mode)

Append-only mode is used to protect data from being accidentally overwritten. Sometimes, due to errors in the configuration of the environment an application client attempts to rewind a drive that it is not transferring data to. Without append-only mode, if the application client writing to the logical unit has not reserved the logical unit, then a different application client is allowed to rewind the volume causing an accidental overwrite of the medium. With append-only mode enabled, the medium is not allowed to be overwritten.

Append-only mode is enabled or disabled using the WRITE MODE field of the Device Configuration Extension mode page (see 6.6.12). This mode is set in the device server to enable device server behaviors. The append-only mode does not modify the volume. When the volume is removed from the device it behaves as a normal volume.

When append-only mode is enabled in the drive, then any command that would result in a write to a location that is not an append point shall be rejected with a CHECK CONDITION, DATA PROTECT, OPERATOR SELECTED WRITE PROTECT (7h / 5A02h) and TapeAlert 09h shall be set. An append point shall be:

- a) the logical position zero if there are no logical objects beyond BOP;
- b) the current logical position if:
  - A) the current logical position is at BOP; and
  - B) there are only filemarks between the current logical position and EOD;
- c) the current logical position if:
  - A) the current logical position is between BOP and EOD;
  - B) there are only filemarks from the current logical position to EOD; and
  - C) there is at least one filemark immediately before the current logical position;

or

- d) the current logical position if the current logical position is at EOD.

The device server maintains an allow\_overwrite variable. The allow\_overwrite variable defines what operation is currently allowed when in append-only mode. The allow\_overwrite variable values are defined in table 7.

**Table 7 — allow\_overwrite variable definition**

Name	Description
Disabled	A write type operation at a position that is not an append point is not allowed.
Current Position	A write type operation is allowed at the position specified by the allow_overwrite_position variable.
Format	An operation that modifies the format of the medium is allowed

The allow\_overwrite\_position variable specifies the position (i.e., partition and logical object identifier) at which a write to a position that is not an append point is allowed.

Append-only mode is a function of the device server and is not a function of the volume. Append-only mode may be used when accessing Data Volumes or WORM volumes. An application client may overwrite data by using a special command called the ALLOW OVERWRITE command (see 5.2.1). The ALLOW OVERWRITE command specifies the logical position where the overwrite is to occur. After successfully processing an ALLOW OVERWRITE command, a write type command at the specified position is processed normally. If the position of the medium is changed or the volume is unmounted, then the device server shall set the allow\_overwrite variable to Disabled (i.e., 0h) and the allow\_overwrite\_position variable to invalid. The ALLOW OVERWRITE command requires the partition number and the logical position to be passed in the CDB. If the position information passed



in the ALLOW OVERWRITE command does not specify the current position of the medium, then the command is terminated with CHECK CONDITION status with the sense key set to ILLEGAL REQUEST and the additional sense code set to SEQUENTIAL POSITIONING ERROR. If there is no volume loaded and the device server processes an ALLOW OVERWRITE command, then the command is terminated with CHECK CONDITION status with sense key set to NOT READY.

An ALLOW OVERWRITE command that returns GOOD status shall:

- a) set the allow\_overwrite variable to the value in the ALLOW OVERWRITE field of the ALLOW OVERWRITE command; and
- b) set the allow\_overwrite\_position variable to the current position.

An ALLOW OVERWRITE command that returns a CHECK CONDITION shall:

- a) set the allow\_overwrite variable to Disabled (i.e., 0h); and
- b) set the allow\_overwrite\_position to invalid.

If append-only mode is enabled, the mounted volume is a WORM volume, and the allow\_overwrite variable is not set to Disabled, then a write type command shall be processed following the WORM rules. Figure 2 shows a representative flowchart of append-only mode behavior.

Figure 2 — Append-only mode flowchart

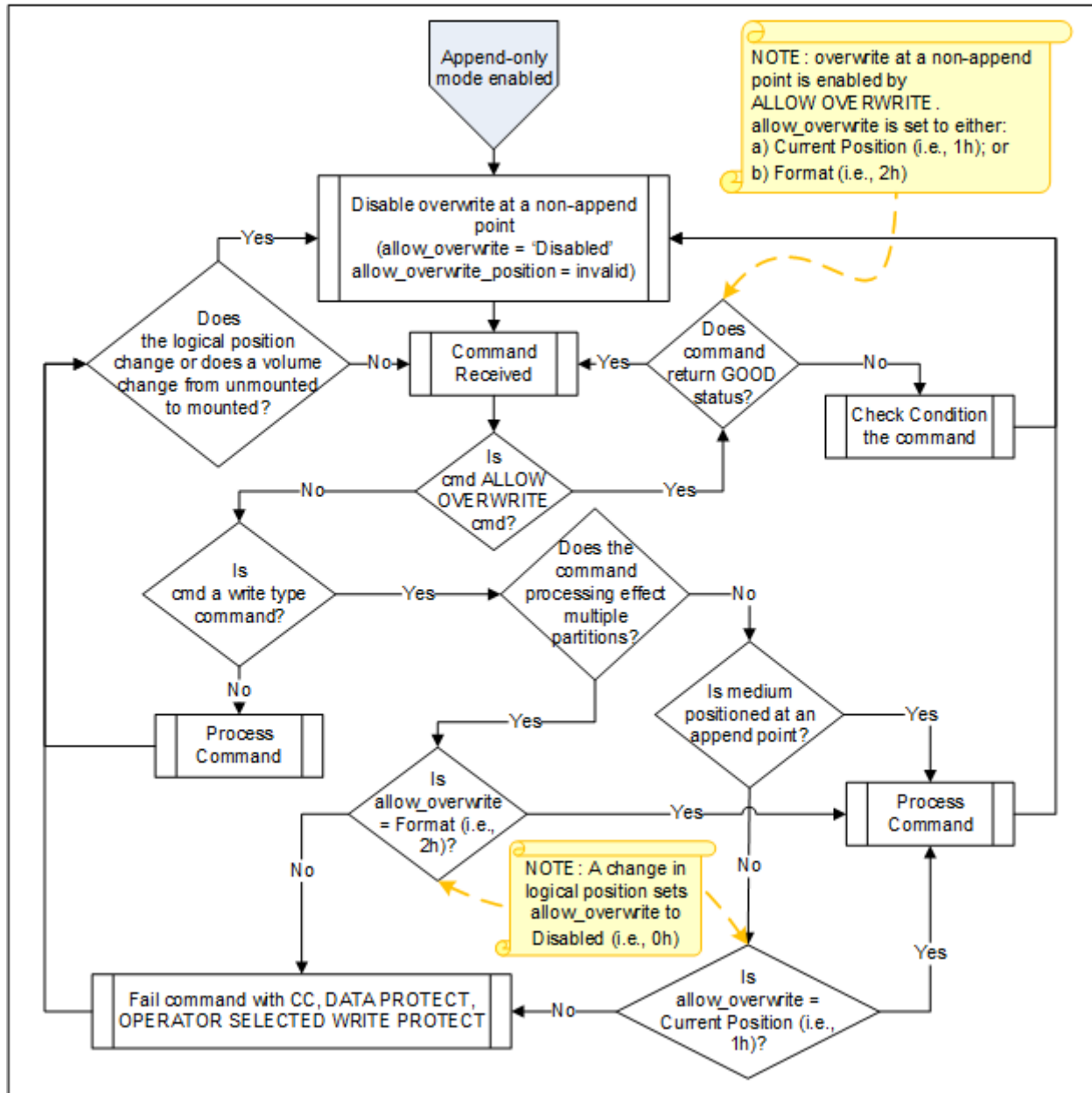

If the ALLOW OVERWRITE command is received by the device server and append-only mode is not enabled, the command is rejected with CHECK CONDITION, ILLEGAL REQUEST, ILLEGAL COMMAND WHEN NOT IN APPEND-ONLY MODE.

When in append-only mode the allow\_overwrite variable shall be set to Disabled (i.e., 0h) and the allow\_overwrite\_position variable shall be set to invalid if:

- the WRITE MODE field of the Device Configuration Extension mode page changes to a value of 01h (i.e., The write-type operation shall only allow appends as specified for the append-only mode in 4.2.3);
- a change in logical position occurs;
- a volume changes state from unmounted to mounted;
- the CDB of a write type command is validated and the write processing begins; or
- an ALLOW OVERWRITE command returns a CHECK CONDITION.

### 4.3 Archive mode unthread (LTO7+)

LTO-7 and LTO-8 drives support choosing a trade-off between fast unthread times without optimizing the preparation of the medium for long term storage and slower unthread times that optimize the preparation of the medium for long term storage. This trade-off is selected through the Archive mode unthread feature. LTO-9 and later drives always optimize the preparation of the medium for long term storage.

Archive mode unthread is able to be invoked either by using the RETEN bit of the LOAD/UNLOAD command (see 5.2.6) or by configuring the drive to use the Archive mode unthread for every unload that occurs. The drive is configured to use the Archive mode unthread for every unload that occurs by setting the E\_ARCHIVE bit to one in the MP 30h[43h]: Feature switches - Device attribute settings (see 6.6.21.5.3) mode page. This mode parameter has a mode parameter policy of (changeable-saveable) and may be saved by setting the SP (save pages) bit to one in the MODE SELECT command. LTO-9 and later drives always behave as if the E\_ARCHIVE bit is set to one (i.e., ignore the bit).

===== WARNING =====
===== WARNING =====  
 Archive mode unthread should be used for volumes that may be stored for extended periods of time.  
===== WARNING =====
===== WARNING =====

## 4.4 Volume partitioning

### 4.4.1 Volume partitioning overview

Starting with LTO 5 volume partitioning is supported by the device on certain media types. A volume is recorded in the same format for the entire volume as indicated by the primary density code (see 5.2.24) but each partition may have differences in how it is encrypted.

The device supports wrap-wise partitioning (see 4.4.2).

This clause and its subclauses describe partitioning and its relationship to:

- a) capacity scaling (see 4.4.3);
- b) media types (see 4.4.4);
- c) reformatting (see 4.4.5); and
- d) encryption (see 4.4.6).

### 4.4.2 Wrap-wise Partitioning

Wrap-wise partitioning uses the length of the medium that is available for user data to create each partition. By default, this is the full length of the medium but the length available for user data may have been shortened through capacity scaling (see 4.4.3). Wrap-wise partitioning is shown logically in figure 3.

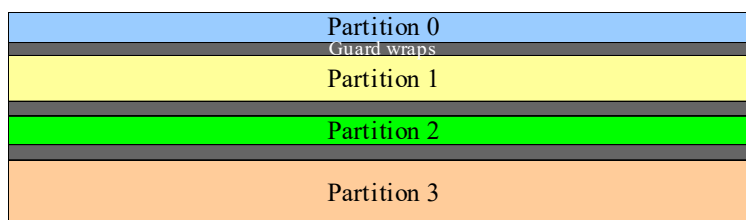

**Figure 3 — Wrap-wise partitioning**

Wrap-wise partitioning uses a minimum of two wraps and has guard wraps of two wraps or four wraps between each partition depending on generation and number of partitions. For Ultrium 9+ cartridges with an even number of equally sized partitions using SDP, the purpose of the guard wraps is fulfilled by the band boundaries thereby not sacrificing capacity for guard wrap overhead. The amount of usable capacity may be reduced depending on various factors including volume generation (e.g., up to 2.5% per partition boundary for Ultrium 5 volumes).

When using wrap-wise partitioning an Ultrium 5 volume supports one or two partitions and an Ultrium 6 or later generation volume supports a maximum of four partitions with any number of partitions between one and four inclusive.

Table 8, and table 9 show the partition sizes that result from a MODE SELECT of the Medium partition mode page (see 6.6.13) with the indicated field settings.

**Table 8 — Partition sizes for wrap-wise partitioning (selection fields)**

Ref <sup>a</sup>	FDP	SDP	IDP	ADDITIONAL PARTITIONS DEFINED <sup>b</sup>	PARTITION SIZE							
					(first)	(second)	(third)	(last)				
row1	1	0	0	X								
row2	0	1	0	00h	X	X	X	X				
row3				01h								
row4				02h								
row5				03h								
row6				0					0	1	00h	FFFFh
row7	s <sup>c</sup>											
row8	01h	s	FFFFh		0							
row9		FFFFh	t									
row10	s <sup>c</sup>	t <sup>c</sup>										
row11	02h	s	t		FFFFh							
row12		s	FFFFh		u							
row13		FFFFh	t		u							
row14		s <sup>c</sup>	t <sup>c</sup>		u <sup>c</sup>							
row15	03h	s	t		u	FFFFh						
row16		s	t		FFFFh	v						
row17		s	FFFFh		u	v						
row18		FFFFh	t		u	v						
row19		s <sup>c</sup>	t <sup>c</sup>		u <sup>c</sup>	v <sup>c</sup>						
others	All other combinations											

<sup>a</sup> The Ref column is the reference that ties the rows in this table to the corresponding rows in table 9.

<sup>b</sup> When more than one partition is defined there may be overhead that results in a loss of capacity

<sup>c</sup> Value must be exact partition size allowed and when summed with other values in the row equal full capacity. This permits a MODE SENSE followed by a MODE SELECT with no change. It is highly recommended that this method only be used in the case where the MODE SELECT data is a return of the MODE SENSE data.

**Table 9 — Partition sizes for wrap-wise partitioning (resultant sizes) (part 1 of 2)**

Ref <sup>a</sup>	Partition 0 <sup>b</sup>	Partition 1 <sup>b</sup>	Partition 2 <sup>b</sup>	Partition 3 <sup>b</sup>
row1	$s=K*n$ ; where $n=N_2$	$t=K$	-	-
Ultrium 5 through Ultrium 8 Cartridges				
row2	$C_{MAX}$	-		
row3	$s=K*n$ ; where $n=\text{integer of } \{(N_2+1)/2\}$	$t=K*m$ ; where $m=N_2+1-n$	-	
row4	$s=K*n$ ; where $n=\text{integer of } \{(N_3+2)/3\}$	$t=K*m$ ; where $m=\text{integer of } \{(N_3+2)/3\}$	$s=K*u$ ; where $u=N_3+2-n-m$	-
row5	$s=K*n$ ; where $n=\text{integer of } \{(N_4+3)/4\}$	$t=K*m$ ; where $m=\text{integer of } \{(N_4+3)/4\}$	$s=K*u$ ; where $u=\text{integer of } \{(N_4+3)/4\}$	$s=K*v$ ; where $v=N_4+3-n-m-u$
Ultrium 9 Cartridge				
row2	$C_{MAX}$	-		
row3	$s=C_{MAX} / 2$	$t=C_{MAX} / 2$	-	
row4	$s=K*\text{ROUNDDOWN}(n/3)$ where $n = (N_3+2)$	$t=K*\text{ROUNDDOWN}(m/2)$ where $m = (N_3+2) - \text{ROUNDDOWN}(n/3)$	$u=K*((N_3+2) - \text{ROUNDDOWN}(n/3) - \text{ROUNDDOWN}(m/2))$	-
row5	$s=C_{MAX} / 4$	$t=C_{MAX} / 4$	$u=C_{MAX} / 4$	$v=C_{MAX} / 4$
row6	$C_{MAX}$	-		
row7	$C_{MAX}$			
row8	$s=K*n$ ; where $1<=n<=N_2$	$C_{MAX} - \text{overhead-}$ (partition size 0)	-	
row9	$C_{MAX} - \text{overhead-}$ (partition size 1)	$t=K*m$ ; where $1<=m<=N_2$		
row10	$s=K*n$ ; where $1<=n<=N_2$ and $n+m=N_2+1$	$t=K*m$ ; where $1<=m<=N_2$ and $n+m=N_2+1$		
row11	$s=K*n$ ; where $1<=n<=N_3$	$t=K*m$ ; where $1<=m<=N_3$	$C_{MAX} - \text{overhead-}$ (partition size 0)- (partition size 1)	-
row12		$C_{MAX} - \text{overhead-}$ (partition size 0)- (partition size 2)	$u=K*p$ ; where $1<=p<=N_3$	
row13	$C_{MAX} - \text{overhead-}$ (partition size 1)- (partition size 2)	$t=K*m$ ; where $1<=m<=N_3$		
row14	$s=K*n$ ; where $1<=n<=N_3$ and $n+m+p=N_3+2$	$t=K*m$ ; where $1<=m<=N_3$ and $n+m+p=N_3+2$	$u=K*p$ ; where $1<=p<=N_3$ and $n+m+p=N_3+2$	
<sup>a</sup> The values in the Ref column refer back to the associated row in table 8. <sup>b</sup> The values for $C_{MAX}$ , $K$ , $N_2$ , $N_3$ , $N_4$ , and the sum of existing partitions are specified in table 10.				

Table 9 — Partition sizes for wrap-wise partitioning (resultant sizes) (part 2 of 2)

Ref <sup>a</sup>	Partition 0 <sup>b</sup>	Partition 1 <sup>b</sup>	Partition 2 <sup>b</sup>	Partition 3 <sup>b</sup>
row15	s=K*n; where 1<=n<=N <sub>4</sub>	t=K*m; where 1<=m<=N <sub>4</sub>	u=K*p; where 1<=p<=N <sub>4</sub>	C <sub>MAX</sub> - overhead- (partition size 0)- (partition size 1)- (partition size 2)
row16			C <sub>MAX</sub> - overhead- (partition size 0)- (partition size 1)- (partition size 3)	v=K*q; where 1<=q<=N <sub>4</sub>
row17		C <sub>MAX</sub> - overhead- (partition size 0)- (partition size 2)- (partition size 3)	u=K*p; where 1<=p<=N <sub>4</sub>	
row18		t=K*m; where 1<=m<=N <sub>4</sub>		
row19	s=K*n; where 1<=n<=N <sub>4</sub> and n+m+p+q=N <sub>4</sub> +3	t=K*m; where 1<=m<=N <sub>4</sub> and n+m+p+q=N <sub>4</sub> +3	u=K*p; where 1<=p<=N <sub>4</sub> and n+m+p+q=N <sub>4</sub> +3	v=K*q; where 1<=q<=N <sub>4</sub> and n+m+p+q=N <sub>4</sub> +3
others	Check Condition, Illegal Request, Invalid Field in Parameter Data			
<sup>a</sup> The values in the Ref column refer back to the associated row in table 8. <sup>b</sup> The values for C <sub>MAX</sub> , K, N <sub>2</sub> , N <sub>3</sub> , N <sub>4</sub> , and the sum of existing partitions are specified in table 10.				

Table 10 — Partition values for L5, L6, and L7

Parameter in table 9	Primary Density Code		
	58h	5Ah	5Ch
C <sub>MAX</sub> <sup>b</sup>	1.5 TB	2.5 TB	6.0 TB
K <sup>a, b</sup>	37.500 GB	36.764 GB	107.142 GB
N <sub>2</sub>	38	66	54
N <sub>3</sub>	N/A	64	52
N <sub>4</sub>	N/A	62	50
Sum of all partitions <sup>a, b</sup> s+t+[u]+[v]	s+t=1 462.500 GB	s+t=2 463.235 GB s+t+u=2 426.470 GB s+t+u+v=2 389.705 GB	s+t=5 892.857 GB s+t+u=5 785.714 GB s+t+u+v=5 678.571 GB
<sup>a</sup> The precision of capacity values able to be expressed is limited by the 2-byte PARTITION SIZE field and the value of the PARTITION UNITS field of the Medium Partition mode page (see 6.6.13). Actual size on medium is not limited by the precision of the fields in the mode page. <sup>b</sup> The capacity values assume a volume that has not been capacity scaled (see 4.4.3).			

Table 11 — Partition values for M8, L8, and L9

Parameter in table 9	Primary Density Code		
	5Dh	5Eh	60h
$C_{MAX}^b$	9.0 TB <sup>c</sup>	12.0 TB <sup>c</sup>	18.0 TB <sup>c</sup>
$K^{a,b}$	107.142 GB <sup>c</sup>	115.384 GB <sup>c</sup>	128.571 GB <sup>c</sup>
$N_2$	82	102	137
$N_3$	80	100	134
$N_4$	78	98	131
Sum of all partitions <sup>a,b</sup> $s+t+[u]+[v]$	$s+t=8\ 892.857\ GB^c$ $s+t+u=8\ 785.714\ GB^c$ $s+t+u+v=8\ 678.571\ GB^c$	$s+t=11\ 884.615\ GB^c$ $s+t+u=11\ 769.230\ GB^c$ $s+t+u+v=11\ 653.846\ GB^c$	$s+t=17\ 742.660\ GB^c$ $s+t+u=17\ 485.656\ GB^c$ $s+t+u+v=17\ 228.514\ GB^c$ if SDP=1b $s+t=18\ 000.000\ GB^c$ $s+t+u+v=18\ 000.000\ GB^c$
Design capacity <sup>c,b</sup>	$K = 100.000\ GB$ Partitions: count total size 2 8 300.000 GB 3 8 200.000 GB 4 8 100.000 GB	$K = 111.538\ GB$ Partitions: count total size 2 11 488.461 GB 3 11 376.923 GB 4 11 265.384 GB	$K = 124.284\ GB$ Partitions: count total size 2 17 151.330 GB 3 16 902.857 GB 4 16 654.190 GB if SDP was 1b during partition creation 2 17 400.000 GB 3 16 902.857 GB 4 17 400.000 GB
<p><sup>a</sup> The precision of capacity values able to be expressed is limited by the 2-byte PARTITION SIZE field and the value of the PARTITION UNITS field of the Medium Partition mode page (see 6.6.13). Actual size on medium is not limited by the precision of the fields in the mode page.</p> <p><sup>b</sup> The capacity values assume a volume that has not been capacity scaled (see 4.4.3).</p> <p><sup>c</sup> see Design Capacity (3.4.1 on page 23)</p>			

#### 4.4.3 Partitioning and capacity scaling

Partitioning of volumes is supported on capacity scaled volumes. If a volume has been capacity scaled through the use of the SET CAPACITY command (see 5.2.37), the medium available for use to record user data is reduced and partitioning functions within those bounds. The act of processing a SET CAPACITY command removes any partitions that may exist and changes the medium available for use to record user data. The resultant volume contains a single partition which may subsequently be partitioned using the Medium partition mode page (see 6.6.13) and the FORMAT MEDIUM command (see 5.2.3).

#### 4.4.4 Partitioning and media types

Partitioning of volumes is supported on media in Ultrium 5 (i.e., primary density code = 58h) and and later logical formats only.

#### 4.4.5 Partitioning and reformatting

Partitions are created and destroyed using the FORMAT MEDIUM command (see 5.2.3). How a volume is formatted depends on the settings in the Medium Partition mode page (see 6.6.13), if the volume is capacity scaled (see 4.4.3), and the settings in the FORMAT MEDIUM command (see 5.2.3). The FORMAT MEDIUM command specifies how to format the volume and the interactions of these conditions using the FORMAT field.

The Medium Partition mode page is used to specify the group of medium partitions. The partitioning of the mounted volume is not changed until a subsequent FORMAT MEDIUM command is issued while the volume is mounted.

The device ensures consistency of the partitioning values set in Medium Partition mode page by causing a CHECK CONDITION status with the sense key set to ILLEGAL REQUEST and the additional sense code set to PARAMETER VALUE INVALID to be returned to a subsequent FORMAT MEDIUM command attempting to use the values set in Medium Partition mode page if values in those values become inconsistent between when they were set and when the FORMAT MEDIUM command is received. The invalidation of the values in this page is accomplished by setting the FDP, SDP, and IDP bits to zero and the other values in this page to:

- a) the values dictated by the format of the currently mounted volume, if a volume is mounted; or
- b) the default values present after power-on, if no volume is mounted.

The invalidation of values in this page occurs if:

- a) the volume is capacity scaled (see 4.4.3); or
- b) other events that are determined to make the values in this page inconsistent.

#### 4.4.6 Partitioning and encryption

The relationship between partitioning and encryption is described in Device Hardware Encryption (see 4.15 on page 54).

### 4.5 Object buffer

#### 4.5.1 Object buffer introduction

This device contains an object buffer capable of holding logical objects being written to the medium or logical objects being transferred from the medium in read-ahead operations. The object buffer is used during write operations when the device is configured to use buffered mode (i.e., the BUFFER MODE field of the mode parameter header is set to a non-zero value per Mode Parameter Header for Mode Select (6/10) (see 6.6.1.1 on page 359))) and during read operations regardless of the buffer mode.

When the device is reading logical objects from the medium, it uses the object buffer in a read-ahead fashion to improve performance. Logical objects are read from the medium and placed into the object buffer such that they are available to an application that is reading without the application being required to wait for each block to be read from the medium prior to being transferred on the SCSI interface. Read-ahead operations often occur at the conclusion of space, locate, and load operations in order to prime the object buffer with logical objects in case a read operation follows.

#### 4.5.2 BOP caching

Devices starting with LTO6 use a small portion of the object buffer as a cache to retain data read at BOP while the remainder of the object buffer is used for read-ahead operations. The data around BOP, once read, is generally retained in the BOP cache until a demount or partition change. If D\_BOPC of the MP 30h[43h]: Feature switches - Device attribute settings (see 6.6.21.5.3 on page 415) mode page is set to 0b and a command is received by the device that requests access to a logical object identifier (aka, logical block address) that is in the BOP cache, that data is read from the BOP cache without requiring actual access to the medium (i.e., it uses the cached data without changing the physical location of the medium). This allows for a volume that is located away from BOP to read the data around BOP very quickly without disturbing the current physical position of the medium. If D\_BOPC of the MP 30h[43h]: Feature switches - Device attribute settings mode page is set to 1b, then a request to perform positioning changes the physical location of the medium and performs a read-ahead operation as appropriate.



#### 4.5.2.1 BOP caching side effects

It is important to understand the side effects that BOP caching may present:

- a) Processing time to position near BOP may be transferred from the positioning command to a subsequent command (e.g., the time for a REWIND could be transferred to a subsequent UNLOAD);
- b) When reading data in the BOP cache and the command requests a read through the cache boundary to data not in the cache, there may be processing time to position the medium to the proper position to read the data, as well as the time to read the data from the medium;
- c) If a sequence of commands like:
  - 1) REWIND;
  - 2) READ one block;
  - 3) LOCATE to position prior to the REWIND;
  - 4) READ one block;
  - 5) Go to step 1,

is performed, the tape will typically move in a sequential fashion like a READ without positioning to BOP in each iteration.

### 4.6 Recommended access order (RAO) (LTO-9+ Full-Height)

#### 4.6.1 RAO Suitability

The RAO implementation in LTO produces the best results for performance enhancement when there is little variability in block size or data compression ratio. When the variability in compression ratio or block sizes increase, the accuracy of the locate estimates may be reduced and any potential performance enhancements may be diminished.

#### 4.6.2 RAO overview

A feature of the LTO-9 and later full-height drives is the ability to accept a list of User Data Segments (see 4.6.2.1) and reorder those User Data Segments into a recommended access order that minimizes the locate portion of the time to read those User Data Segments. This sorted list is called a Recommended Access Order (RAO) list. A User Data Segment (UDS) is defined as a grouping of contiguous logical objects (i.e., logical blocks and filemarks) and is described by partition number, beginning logical object identifier, and ending logical object identifier.

An additional capability to optimize this list to minimize the time for a subsequent unload, as well as the capability to bind to a specific starting point or ending point is included (see 4.6.3.4).

##### 4.6.2.1 User data segments (UDS) in a partition

Within a partition that has recorded logical objects a contiguous sequence of logical blocks or logical files may be referenced as a user data segment (UDS).

##### 4.6.2.2 User data segment descriptors

UDS descriptors (see 5.2.24.1.3) are used to describe attributes of the UDS and contain the following:

- a) an application client specified name;
- b) a partition number;
- c) a beginning logical object identifier;
- d) an ending logical object identifier;
- e) in a returned RAO list, an estimate of the time to locate from the end of the current UDS to the beginning of the next UDS to access. This does not include the time required to read the UDS as this has variability dictated by the application, the load on the server, and other unknown factors; and
- f) optionally, in a returned RAO list, the physical geometry of the UDS if requested in the GRAO command.

### 4.6.3 RAO features

#### 4.6.3.1 RAO features overview

The drive accepts a list of User Data Segments (see 4.6.2) in a GRAO parameter list and may reorder those UDSes into a recommended access order that reduces the time to process the list.

The list of UDSes is sent to the drive using the Generate Recommended Access Order (GRAO) command (see 5.2.4). The drive creates the RAO list from the list of UDSes and optionally sorts the list of UDSes. The RAO list may then be read with one or more Receive Recommended Access Order (RRAO) commands (see 5.2.24). The RRAO command allows retrieval of the ROA list with or without geometry information.

The RAO feature allows the user to:

- a) determine the UDS limits for the type of RAO list to generate;
- b) specify the process to use in generating the RAO list; and
- c) specify binding points in the RAO list.

#### 4.6.3.2 Determining the UDS limits

RAO supports thousands of User Data Segments in the RAO list. The RRAO command (see 5.2.24) with the UDS\_LIMITS bit set to one may be used to determine the number of supported UDSes for the type of RAO list to generate (i.e., for the specific setting of the UDS\_TYPE field) as well as the maximum size of each UDS for the type of RAO list to generate. At the time this document was published, the maximum number of supported UDSes for all values of UDS\_TYPE is 2730.

#### 4.6.3.3 Specifying the process for generating the RAO list

The GRAO command specifies the process to use in generating the RAO list as defined in table 12

**Table 12 — PROCESS for generating recommended access order**

Value	Description
000b	Not supported
001b	Drive does not reorder the UDSes passed in the GRAO parameter list, but does calculate the time to sequentially locate to each UDS in the list from the end of the prior position.
010b	Drive reorders the UDSes passed in the GRAO parameter list into the recommended access order and calculates the time to sequentially locate to each UDS in its resultant position from the end of the prior position.
011b-111b	Reserved

#### 4.6.3.4 Specifying binding points in the RAO list

The binding points are limited to:

- a) the starting point of the sort;
- b) the ending point of the sort; and
- c) the unloaded position.

Binding points are specified by placing single-object UDSes in specific positions in the list. A single-object UDS is one where the BEGINNING LOGICAL OBJECT IDENTIFIER field is identical to the ENDING LOGICAL OBJECT IDENTIFIER field. The Starting Point UDS must be the first single-object UDS in the list. The Unloaded Position UDS is a single-object UDS with the PARTITION NUMBER field, the BEGINNING LOGICAL OBJECT IDENTIFIER field, and the ENDING LOGICAL OBJECT IDENTIFIER field set to zero and must be the last UDS in the list. The Ending Point UDS must be either the last UDS in the list or immediately precede the Unloaded Position UDS. Other single-object UDSes are not binding points and are optimally sorted.

The RAO list contains all the UDSes sent in the GRAO parameter list including the binding points. The positions of the binding point UDSes are unchanged, but the remaining UDSes, including any single-object UDSes that are

not binding points are optionally sorted. The ESTIMATED LOCATE TIME TO UDS field in the Unloaded Position UDS is the estimated time for the cartridge to be unloaded to the ejected position (i.e., fully unloaded).

Specifying both an Ending Point UDS and an Unload Position UDS is logically contradictory and is not recommended. The ending point precludes any sort optimization indicated by the unload position.

#### 4.6.4 RAO usage

The RRAO command returns the RAO list generated in the last successful GRAO command. The RAO list that is generated is valid for the state of the currently mounted volume (i.e., logical position, logical objects on media, etc.) at the time the list is generated. If the logical position of the medium is changed, or if logical objects are written or erased, then the RAO list becomes out of date. However, the device server takes no action to invalidate the list or to enforce a specific sequence of operation before returning an RAO list. Therefore, the responsibility of ensuring the RAO list has not been invalidated by commands since the processing of the GRAO command rests with the application.

An example of how an application client may use the recommended access order model (see 4.6.1) is to:

- 1) Read the UDS limits (see 5.2.24.1.1) to determine the number of supported UDSes (see 4.6.2.1);
- 2) Compose a list of UDSes to be accessed;
- 3) Generate an RAO list (see 5.2.24.1.2) from the list of UDSes to be accessed using the GRAO command (see 5.2.4);
- 4) Read a portion of the RAO list using the RRAO command (see 5.2.24) with the RAO LIST OFFSET field set to zero and the ALLOCATION LENGTH field set as appropriate for the Data-In Buffer;
- 5) Check the RAO PROCESS field and the STATUS field of the RAO list (see 5.2.24.1.2) to confirm that the RAO list was generated as expected;
- 6) For all user data segment descriptors returned in this portion of the RRAO list (in order):
  - A) ignore a binding UDS;
  - B) locate to the BEGINNING LOGICAL OBJECT IDENTIFIER; and
  - C) read to the ENDING LOGICAL OBJECT IDENTIFIER;
- 7) If the value in the RAO list RAO DESCRIPTOR LIST LENGTH field returned in step 4) is larger than the sum of the value in the RAO LIST OFFSET field and the size of the portion of the RAO list returned in response to the RAO command, then read another portion of the RAO list using the RRAO command with the RAO LIST OFFSET field and the ALLOCATION LENGTH field set as appropriate for the Data-In Buffer;
- 8) Repeat steps 4) through 7) as necessary until all UDSes have been read; and
- 9) Unload, if desired.

An example of the resulting order after a GRAO with the RAO PROCESS set to 010b is shown in figure 4. This simplified example only shows 8 wraps per data band for a total of 32 wraps.

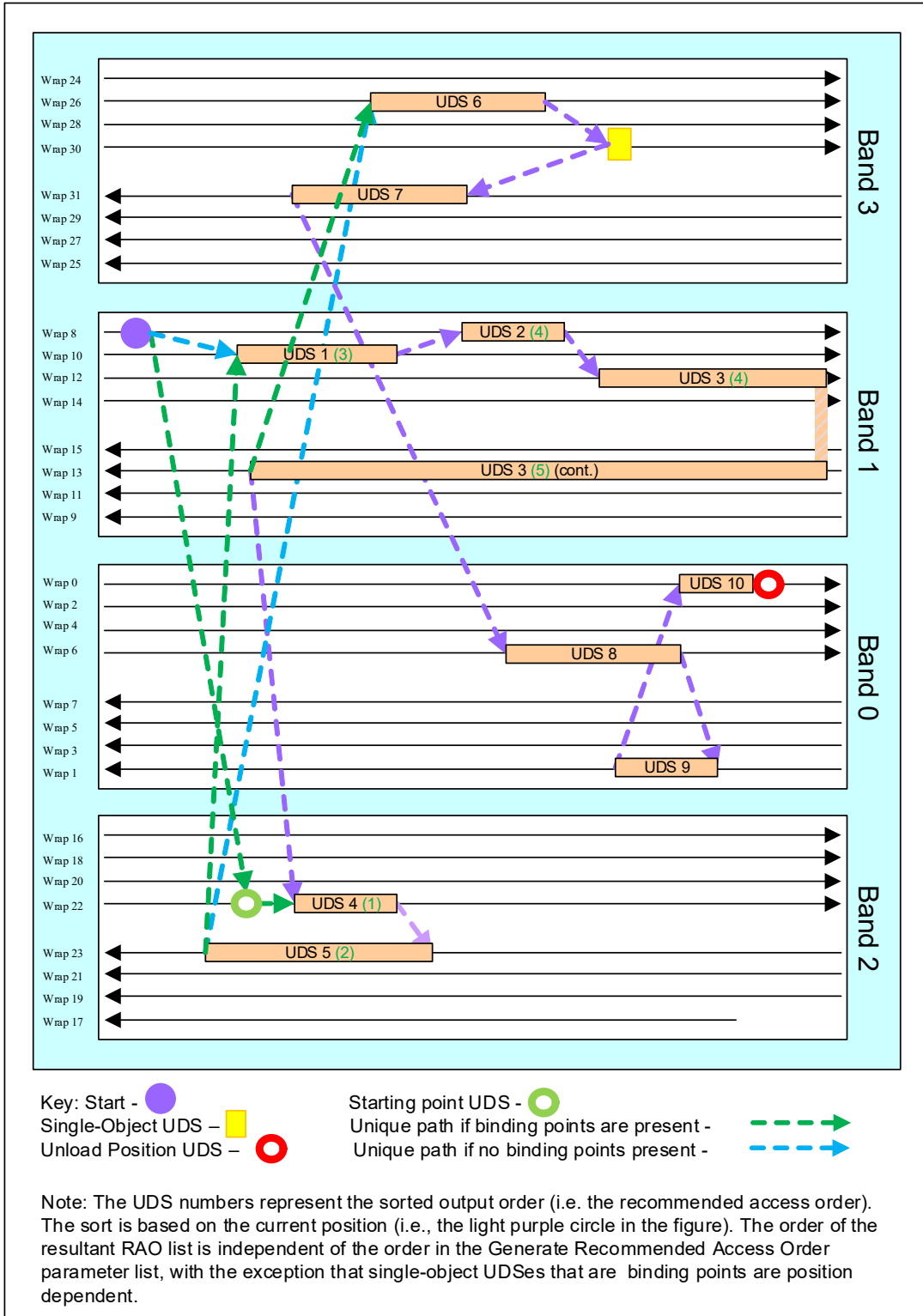

Figure 4 — Example Reordering of UDSes

#### 4.6.4.1 User data segment geometry usage

If the RAO list generated contains UDSeS with geometry (see 5.2.24), then the geometry descriptors (see 5.2.24.1.3.1) may be used to build a representation of the physical layout of the UDSeS on tape. This may be useful for visual feedback or for an application to create its' own algorithm for UDS retrieval based on physical location.

### 4.7 Mode Page Behaviors

#### 4.7.1 Policy — non-standard

This device implements a non-standard behavior related to mode page policy. The mode page policies defined are:

Mode page policy	Number of mode page copies
<Shared>	One copy of the mode page that is shared by all I_T nexuses.
<Per target port>	A separate copy of the mode page for each target port with each copy shared by all initiator ports.
<Per I_T nexus>	A separate copy of the mode page for each I_T nexus

##### 4.7.1.1 Mode parameter header and block descriptor policy

This device implements mode page policy in a manner different than specified in T10/SPC-4. The mode page policy for mode parameter header and block descriptor values depends on the specific parameter as shown here for the applicable parameters:

Field	Mode page policy
BUFFERED MODE	<Shared>
SPEED	<Shared>
BLOCK LENGTH	<Per I_T nexus>

##### 4.7.1.2 Mode page policy

The mode page policy implemented by this device is shown in table 13

**Table 13 — Mode page policy (part 1 of 2)**

Mode Page	MLUS <sup>a</sup>	Mode page policy	IP 87h <sup>b</sup>	Returned in MP 3Fh <sup>c</sup>
Default mode page policy descriptor returned in IP 87h: Mode Page Policy (see 6.3.6 on page 238) as MP 3Fh[FFh]	-	<Shared>	Y	-
MP 01h: Read-Write Error Recovery (see 6.6.5 on page 366)	-	<Shared>	-	Y
MP 02h: Disconnect-Reconnect (see 6.6.6 on page 367)	Y	<Per I_T nexus>	Y	Y
MP 0Ah: Control (see 6.6.7 on page 369)	-	<Shared>	-	Y
<b>Key:</b> - No Y Yes <sup>a</sup> The MLUS (multiple logical units share) indicates if this mode page—subpage combination may be shared by other logical units (e.g., The FCP port (19h) page controls port related functions) <sup>b</sup> A mode page policy descriptor other than the default mode page policy descriptor is returned for this page in IP 87h: Mode Page Policy (see 6.3.6 on page 238). <sup>c</sup> Whether on not the mode page is returned in mode page 3Fh or mode page 3Fh[FFh] is indicated in this column. Some vendor-specific pages are not returned with an all pages request.				

Table 13 — Mode page policy (part 2 of 2)

Mode Page	MLUS <sup>a</sup>	Mode page policy	IP 87h <sup>b</sup>	Returned in MP 3Fh <sup>c</sup>
MP 0Ah[01h]: Control Extension (see 6.6.8 on page 370)	Y	<Shared>	Y	Y
MP 0Ah[F0h]: Control Data Protection (see 6.6.9 on page 371)	-	<Per I_T nexus>	Y	Y
MP 0Fh: Data Compression (see 6.6.10 on page 373)	-	<Shared>	-	Y
MP 10h: Device Configuration (see 6.6.11 on page 375)	-	<Shared>	-	Y
MP 10h[01h]: Device Configuration Extension (see 6.6.12 on page 377)	-	<Shared>	-	Y
MP 11h: Medium Partition Page (see 6.6.13 on page 380)	-	<Shared>	-	Y
MP 18h: Fibre Channel Logical Unit (see 6.6.14.1 on page 385)	Y	<Per I_T nexus>	Y	Y
MP 18h: SAS Logical Unit (see 6.6.14.2 on page 386)	Y	<Per I_T nexus>	Y	Y
MP 19h: FCP port (see 6.6.15.1 on page 387)	Y	<Per target port>	Y	Y
MP 19h: SAS port (see 6.6.15.2 on page 388)	Y	<Per target port>	Y	Y
MP 1Ah: Power Condition (see 6.6.16 on page 389)	-	<Shared>	-	Y
MP 1Ch: Informational Exceptions Control (see 6.6.17 on page 390)	-	<Per I_T nexus>	Y	Y
MP 1Dh: Medium Configuration (see 6.6.18 on page 392)	-	<Shared>	-	Y
MP 24h: Vendor-Specific (see 6.6.19 on page 393)	-	<Shared>	-	-
MP 2Fh: Behavior Configuration (see 6.6.20 on page 397)	-	<Shared>	-	Y
MP 30h: Device Attribute Settings (see 6.6.21 on page 400)	Y	<Shared>	Y	Y
MP 30h[01h]: Drive MAC address - Device attribute settings (see 6.6.21.3.2 on page 405)	Y	<Shared>	Y	Y
MP 30h[02h]: Drive IP address and subnet mask - Device attribute settings (see 6.6.21.3.3 on page 407)	Y	<Shared>	Y	Y
MP 30h[20h]: Encryption mode - Device Attribute Settings (see 6.6.21.4.1 on page 409)	Y	<Shared>	Y	Y
MP 30h[40h]: SkipSync - Device attribute settings (see 6.6.21.5.1 on page 411)	Y	<Shared>	Y	Y
MP 30h[42h]: End of partition behavior control - Device attribute settings (see 6.6.21.5.2 on page 414)	Y	<Shared>	Y	Y
MP 30h[43h]: Feature switches - Device attribute settings (see 6.6.21.5.3 on page 415)	Y	<Shared>	Y	Y
MP 3Eh: Engineering Support (see 6.6.22 on page 419)	-	<Shared>	-	
<b>Key:</b> - No Y Yes <sup>a</sup> The MLUS (multiple logical units share) indicates if this mode page—subpage combination may be shared by other logical units (e.g., The FCP port (19h) page controls port related functions) <sup>b</sup> A mode page policy descriptor other than the default mode page policy descriptor is returned for this page in IP 87h: Mode Page Policy (see 6.3.6 on page 238). <sup>c</sup> Whether on not the mode page is returned in mode page 3Fh or mode page 3Fh[FFh] is indicated in this column. Some vendor-specific pages are not returned with an all pages request.				

#### 4.7.2 Classification of mode parameters

The page control (PC) field of the MODE SENSE command indicates four classifications of mode pages:

Value	Description
00b	Current values
01b	Changeable values
10b	Default values
11b	Saved values.

This device has the following behaviors for mode parameters:

**Table 14 — Mode parameter change behavior**

Term	Values reported for Mode Sense with page control of Changeable values (01b)	Action when a value of a field received is different than the Current values (00b) <sup>a</sup>
(changeable)	The bits of this field are set to one in the parameter data returned to a MODE SENSE command with the PC field set to 01b (i.e., Changeable values).	The current value is updated.
(changeable-special)		See the description of the parameter to determine the action (e.g., the parameter may be writeable and change the behavior to that indicated by the received value, but not update the Current values).
(changeable-saveable)		The current value is updated. If the SP bit in the MODE SELECT CDB is set to one, then the value for the Saved values (11b) for this page is updated and saved to non-volatile memory before SCSI status is returned.
(changeable-ignored)		The current value is unchanged. No action is taken.
(non-changeable)	The bits of this field are set to zero in the parameter data returned to a MODE SENSE with a PC field set to 01b (i.e., Changeable values).	The MODE SELECT command is rejected with a 5/2600h (i.e., ILLEGAL REQUEST, INVALID FIELD IN PARAMETER LIST).
<sup>a</sup> A value in the mode parameter data received with a MODE SELECT command is different than the value in the mode parameter data returned to a MODE SENSE command with the PC field set to 00b (i.e., Current values).		

This device implements the following features differently than specified in SPC-4:

- a) Save behavior — non-standard (see 4.7.2.1 on page 41); and
- b) Parameter Saveable behavior — non-standard (see 4.7.2.2 on page 41).

##### 4.7.2.1 Save behavior — non-standard

This device implements mode parameter saving in a manner different than specified in SPC-4. The SP bit of the MODE SELECT command (see 5.2.10) applies only to the parameters sent in parameter data to that MODE SELECT command. No other mode parameters' Current values are saved. This is contrary to SPC-4 which mandates that the Current values of all saveable mode pages be saved if the SP bit is set to one.

##### 4.7.2.2 Parameter Saveable behavior — non-standard

The parameter saveable (PS) bit in the mode parameters is set to one in the parameter data returned to a MODE SENSE if at least one mode parameter in the page is saveable. Since only some parameters are saveable and others are not, it may be possible that some of the changeable parameters in the page are saveable and other changeable parameters in the page are not. There is no programmatic method for retrieving a list of which specific mode parameters are saveable.

The parameter saveable (PS) bit in the mode parameters is ignored during the processing of a MODE SELECT command.

### 4.7.3 Mode parameters and unit attentions

Some mode parameters, including mode parameters in the mode parameter header, in the block descriptor, and in some mode pages are affected by mounting a volume. When this occurs, there is no unit attention for MODE PARAMETERS CHANGED (i.e., 6/2A01h) established.

## 4.8 Programmable early warning

When writing, the application client may need an indication prior to early warning to allow for the application client to prepare to be ready for early warning (e.g., flush buffers in the application client).

Application clients that need this indication may request the device server to create a zone called the programmable-early-warning zone (PEWZ) by setting the PEWS field (see 6.6.8) to the requested size of the PEWZ. The EOP side of PEWZ is established at early-warning and extends towards BOP for a distance indicated by the PEWS field. See figure 5.

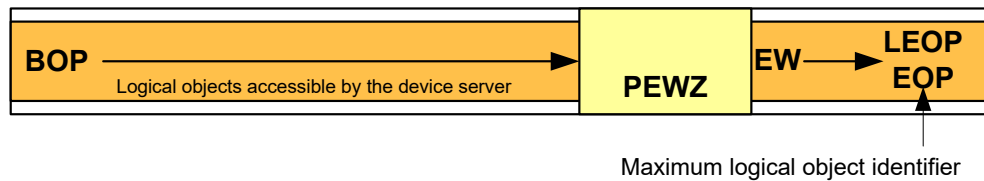

**Figure 5 — Programmable early warning example**

==== **WARNING** ===== **WARNING** =====

If PEWZ is used, all applications that may access the drive when a PEWZ exists, should support PEWZ or there is a risk of the application that does not support PEWZ detecting an unknown error or a diminished capacity when the PROGRAMMABLE EARLY WARNING error is reported.

==== **WARNING** ===== **WARNING** =====

The REW bit in the Device Configuration mode page (see 6.6.11) shall have no effect on the device server behavior in the PEWZ.

The device server shall return CHECK CONDITION status, with the sense key set to NO SENSE, the EOM bit set to one and the additional sense code set to PROGRAMMABLE EARLY WARNING DETECTED at the completion of a command that caused the medium to transition into the PEWZ if that command is:

- a) WRITE(6); or
- b) WRITE FILEMARKS(6).

Encountering the PEWZ shall not cause the device server to perform a synchronize operation or terminate the command. If processing this command results in any other exception condition except early-warning, the CHECK CONDITION status associated with that exception condition shall be reported instead. If early-warning is crossed prior to the PROGRAMMABLE EARLY WARNING DETECTED additional sense being reported, the PROGRAMMABLE EARLY WARNING DETECTED additional sense shall be reported before the early-warning CHECK CONDITION.

If the PROGRAMMABLE EARLY WARNING DETECTED additional sense code was not reported, the next write in PEWZ or beyond early-warning that would otherwise complete with GOOD status, shall return the programmable-early-warning CHECK CONDITION instead.

If the PEWZ is entered and exited on the BOP side before the PROGRAMMABLE EARLY WARNING DETECTED additional sense code is returned, the device server shall not report CHECK CONDITION status with the additional sense code set to PROGRAMMABLE EARLY WARNING DETECTED.



## 4.9 Logical block protection

### 4.9.1 Logical block protection overview

The device contains hardware or software that is capable of checking and generating protection information (i.e., 4-byte CRC) that is transferred with logical blocks between the device server and an application client. This protection information transferred with logical blocks is saved to the medium with each logical block and read from the medium with each logical block. This protection information is validated at the destination prior to completing the task thereby ensuring that the logical block has not been corrupted. This level of detection is not achievable by methods where the application client inserts vendor-specific data protection information in its data. Some devices support a standardized method of logical block protection (see 4.9.1.1). The protection method (if any) used to write a given block does not need to be the same as the method (if any) used to read that same block. This includes where a drive (e.g., prior generation) which does not support the protection method used to write a given block may read those blocks using any (or no) protection method supported on the reading drive.

#### 4.9.1.1 Logical block protection

Logical block protection support using the CRC32C (Castagnoli) algorithm (see D.2.) was added in LTO7 and may be used by an LTO7 drive when processing any generation of cartridge supported by the LTO7 drive. When used with prior generation cartridge it does not affect interoperability with drive generations that do not support the CRC32C algorithm. In other words, a cartridge written with CRC32C in an LTO7 drive may be read in a previous generation drive using a different algorithm.

A device that supports using protection information in the standardized method configures this capability using MP 0Ah[F0h]: Control Data Protection (see 6.6.9 on page 371). Logical block protection is enabled by setting the LOGICAL BLOCK PROTECTION METHOD field of the Control Data Protection mode page to a non-zero value. Logical block protection is disabled by setting the LOGICAL BLOCK PROTECTION METHOD field of the Control Data Protection mode page to zero.

A device server that supports using this protection information shall:

- a) set the PROTECT bit in standard inquiry (see 5.2.5.1) to one;
- b) set the SPT field of the Extended INQUIRY Data VPD page (see 6.3.5) to 001b; and
- c) set the value returned in the MAXIMUM BLOCK LENGTH LIMIT field of the READ BLOCK LIMITS command to a value which when added to the largest value supported in the LOGICAL BLOCK PROTECTION INFORMATION LENGTH field of the Control Data Protection mode page is less than or equal to the maximum length able to be represented in commands that transfer logical blocks between the application client and the device server.

### 4.9.2 Protection information on a volume

A recorded volume contains logical objects and format specific symbols. Logical objects are application client accessible. Format specific symbols are used by the device server to provide methods for recording logical objects on the medium in a manner that allows them to be successfully read at a later date and may not be application client accessible. Format specific symbols contain information used to protect logical objects. The drive includes the protection information field as one of the format specific symbols. The format specific symbol that is the protection information field is written to the medium with each logical block. The protection information used as a format specific symbol by the drive is a 4-byte Reed-Solomon CRC (see D.1.). A representation of logical objects and format specific symbols is shown in figure 6.

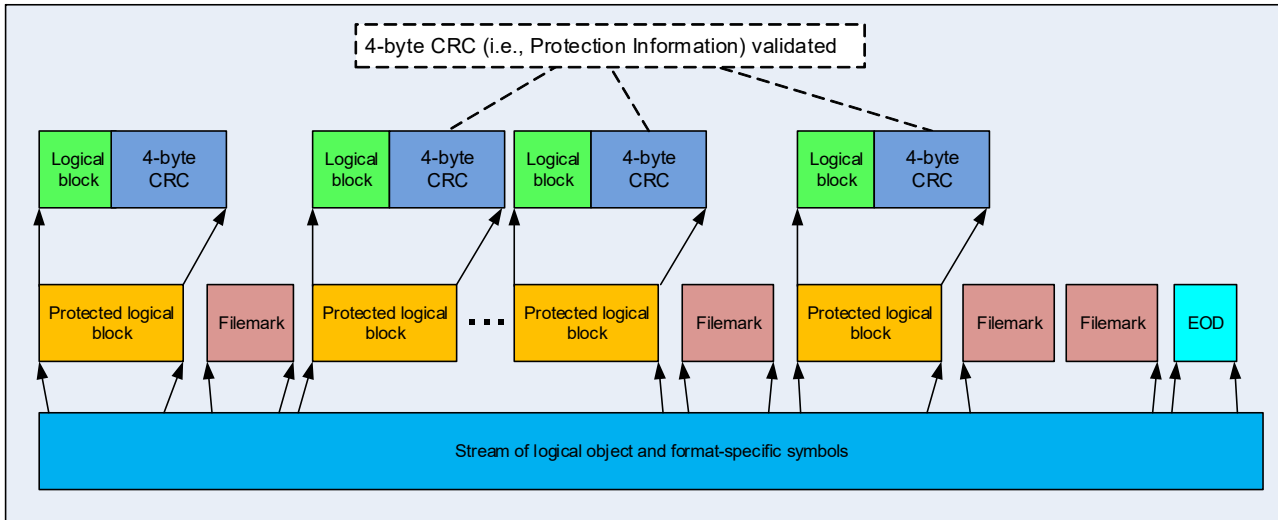

**Figure 6 — Protection information shown in relation to logical objects and format specific symbols**

The device generates the protection information and adds it to a logical block before recording the logical block to the medium if the command that transferred the logical block being recorded to medium was received on an I\_T\_L nexus for which the LOGICAL BLOCK PROTECTION METHOD field of the Control Data Protection mode page:

- a) is set to zero; or
- b) is set to a non-zero value and the LBP\_W bit of the Control Data Protection mode page is set to zero.

The drive reads the protection information from the medium, validates it, and removes it from the logical block before transferring the logical block to the application client if the command that is requesting the transfer of a logical block being read was received on an I\_T\_L nexus for which the LOGICAL BLOCK PROTECTION METHOD field of the Control Data Protection mode page:

- a) is set to zero; or
- b) is set to a non-zero value and the LBP\_R bit of the Control Data Protection mode page is set to zero.

Protection information may be:

- a) compressed;
- b) encrypted; or
- c) included in byte counts in log parameters.

NOTE 1 - Device side counters reported in log pages generally include bytes from the protection information at all times. Host side counters reported in log pages when CRC Protection and Logical block protection are disabled generally do not include bytes from the protection information. Host side counters reported in log pages when CRC Protection is enabled or when Logical block protection is enabled generally include bytes from the protection information.

### 4.9.3 Logical blocks and protection information

If the LOGICAL BLOCK PROTECTION METHOD field of the Control Data Protection mode page is set to zero for a specific I\_T\_L nexus, then a logical block transferred between the application client and the device server through that I\_T\_L nexus is defined by Table 15.

**Table 15 — Logical block with no protection information**

Byte	Bit							
	7	6	5	4	3	2	1	0
0	Data							
n-1								
n = the TRANSFER LENGTH field specified in CDB for variable length transfers; the BLOCK LENGTH field specified in the mode parameter header (see SPC-4) for fixed block transfers.								

If the LOGICAL BLOCK PROTECTION METHOD field of the Control Data Protection mode page is set to a non-zero value for a specific I\_T\_L nexus, then a logical block transferred between the application client and the device server through that I\_T\_L nexus is defined by Table 16.

**Table 16 — Logical block with protection information**

Byte	Bit							
	7	6	5	4	3	2	1	0
0	Data							
n-x-1								
n-x	Protection Information							
n-1								
n = the TRANSFER LENGTH field specified in the CDB for variable length transfers; the BLOCK LENGTH field specified in the mode parameter header (see SPC-4) for fixed block transfers.								
x = the LOGICAL BLOCK PROTECTION INFORMATION LENGTH specified in the Control Data Protection mode page.								

If the protection information to be transferred between the drive and the host is not the Reed-Solomon CRC, then the protection information is transformed between the Reed-Solomon CRC and the CRC algorithm selected (see 6.6.9).

### 4.9.4 Protecting logical blocks transferred during writes

If the LOGICAL BLOCK PROTECTION METHOD field and LBP\_W bit of the Control Data Protection mode page (see 6.6.9) is set to a non-zero value for a specific I\_T\_L nexus, then each logical block transferred from the application client through that I\_T\_L nexus due to a WRITE(6) command contains protection information.

For the WRITE(6) command, the device server validates the protection information before the logical block is written to medium. If the FIXED bit in the CDB is set to one each logical block is validated before being written to the medium. If the validation of the protection information for a logical block fails, then the processing of the command terminates prior to writing the failed logical block to the medium. If the validation of the protection information fails, the device server reports a CHECK CONDITION status with Sense Code of Current or Deferred, the sense key set to HARDWARE ERROR and the additional sense code set to LOGICAL BLOCK GUARD CHECK FAILED.

An application client shall add the protection information on each logical block before transferring that logical block and shall increase the TRANSFER LENGTH field by the length of the logical block protection information if it has set the LOGICAL BLOCK PROTECTION METHOD field of the Control Data Protection mode page to a non-zero value and the LBP\_W bit of the Control Data Protection mode page to one.

The application client should add the protection information to the logical block at the earliest point possible. If the data has had the protection information added to the logical block at some point in the application client prior to the hardware that transfers the logical block, then the protection information should be validated when it is

transferred. If the validation fails, then the application client should abort the command and report a status to the user that validation failed.

NOTE 2 - The device server treats the LOGICAL BLOCK PROTECTION INFORMATION field as the protection information. If the protection information is not added to the logical block, then the validation fails when the bytes used do not validate (e.g., the last 4-bytes of the logical block are treated as the CRC and the last 4-bytes of the logical block do not calculate as the CRC of the previous data)

#### 4.9.5 Protecting logical blocks processed during reads and verifies

Protection information is validated by the device server as logical blocks are processed regardless of the the logical block protection settings. If the validation of the protection information fails, then the device server reports a CHECK CONDITION status with Sense Code of Current Sense, the sense key set to HARDWARE ERROR and the additional sense code set to LOGICAL BLOCK GUARD CHECK FAILED.

When a logical block is transferred to the host, if the LOGICAL BLOCK PROTECTION METHOD field and the LBP\_R bit of the Control Data Protection mode page (see 6.6.9) are set to a non-zero value for a specific I\_T\_L nexus, then the protection information is transferred with the logical block to the application client on that I\_T\_L nexus. An application client should validate the protection information on each logical block at the latest point possible before using the data.

### 4.10 Multiple Port Behavior

There are two primary ports in the device and may be either Fibre Channel ports or SAS ports. The two primary ports provide alternate paths through which the logical unit(s) of the device may be reached. The ports are referred to as Port 0 (or alternately, Relative Target Port 1) and Port 1 (or alternately, Relative Target Port 2). Each port maintains its own unique settings and address.

If the device is contained in a library or medium changer, the library may enable (also known as online) or disable (also known as offline) each port independently.

When an offline port is set online, all initiators on that port receive a Unit Attention condition.

Offline ports do not generate or maintain Unit Attention conditions for initiators while the port is in an offline state.

Usage of the device with both ports online is required for dual port failover to function correctly. Generally, all initiators, regardless of port, are treated the same as multiple initiators on the same port. The exception to this is the handling of mode pages and reservations when a hard port reset condition occurs (such as loss of light, etc). The following rules are described with respect to a local interface (the host port on which the hard reset condition occurred) and a remote interface (the other host port to which the device is attached).

- a) If there are no reservations when a hard reset condition occurs, most mode pages are reset. All initiators on the local interface receive a Unit Attention condition for Power On, Reset, or Device Reset Occurred. All initiators on the remote interface receive a Unit Attention condition for Mode Parameters Changed.
- b) If there are one or more reservations when a hard reset condition occurs and all reservations were granted to initiators on the local interface, all mode pages are reset and all SPC-2 reservations are reset. All persistent reservations remain in effect. All initiators on the local interface receive a Unit Attention condition for Power On, Reset, or Device Reset Occurred. All initiators on the remote interface receive a Unit Attention condition for Mode Parameters Changed.
- c) If there are one or more reservations when a hard reset condition occurs and one or more of the reservations were granted to an initiator on the remote interface, only those mode pages and SPC-2 reservations unique to each initiator on the local interface are reset. Mode pages and reservations unique to each initiator on the remote interface are not reset. Mode pages which are defined as common to all initiators are not reset. All initiators on the local interface receive a Unit Attention condition for Power On, Reset, or Device Reset Occurred. All initiators on the remote interface see no effects of the hard reset condition on the other interface.

## 4.11 Data Transfer, Block Limits, and Fixed Block Option

This device is designed to buffer multiple records. Logical objects may be prefetched to the buffer before they are requested by a READ command or held in the buffer after they are written by a WRITE command. For successive sequential-motion operations, the presence of the buffering in the device does not adversely affect the performance of the subsystem. Non-sequential motion does not result in errors, but may result in delays because of requirements to synchronize buffers or discard read ahead data. Buffer management in the device determines when to read additional data from the medium into the buffer, or when to write data from the buffer to the medium. A logical block is not written to tape until the block is entirely received into the buffer.

When the `FIXED` bit of the command is set to 1b, each command transfers zero or more logical blocks. The subsystem takes appropriate action to assemble or disassemble the logical blocks being transferred over the interface so that they remain independent blocks on the medium. There is no guarantee that the group of blocks transferred by the Write command is requested as a group by a subsequent Read command, so the device must be prepared to assemble and disassemble on a block boundary. This is managed by treating all blocks and filemarks as independent from one another, both for data compaction and for recording.

When the `FIXED` bit of the command is set to 0b and the `TRANSFER COUNT` is non-zero, each command processes a single logical object.

The device supports a minimum logical block length of 1 and a maximum logical block length of 16 777 215 (FF FFFFh) bytes if encryption is not being used and 8 388 608 (80 0000h) bytes if encryption is being used. Any block length between the limits is also supported. Refer also to `READ BLOCK LIMITS - 05h` (see 5.2.17 on page 112) for further information on block sizes and limitations. The `READ BLOCK LIMITS` command may report a lower maximum value depending on the support of Encryption and Logical Block Protection. If the logical object identifier of the current position on medium is greater than FFFFFFF0h and less than FFFFFFFF0h, then rules for Logical EOM processing are applied. If the logical object identifier of the current position on medium is greater than or equal to FFFFFFFF0h, rules for physical end of partition processing are applied.

For read type commands, including `READ` and `VERIFY`, transfer lengths larger than the maximum device supported block size are accepted and the underlength condition rules are applied for transfer requests bigger than the actual block size. A transfer Length of 000000h indicates that no bytes/blocks are transferred. This condition is not considered an error and the logical position is not changed.

For write type commands, including `WRITE`, and `WRITE FILEMARKS`, a transfer Length of 000000h indicates that no bytes/blocks are transferred. This condition is not considered an error and the logical position is not changed.

## 4.12 Request Sense Information, ILI, and Command Interactions

The behavior and interactions between some of the commands and the `INFORMATION` and `ILI` fields in Request Sense are rather complicated. This section details the various commands which may set the information or `ILI` fields, and summarizes the relationship between such commands, their parameters, the encountered conditions, the reported status, and the expected behavior of these fields and the resulting device position.

### 4.12.1 General Read-Type Handling

Commands which return block data from media or the buffer to the host have the same general behavior. These commands include `READ` and `VERIFY`. The major difference between these is whether or not data is returned to the host.

The block at the current position is processed first, and subsequent blocks are processed in the order they were written (proceeding towards logical end of partition). The ending position is after the last block processed. For these commands, “after” will refer to the start of the next block towards the logical end of partition, and “before” will refer to the start of referenced block.

To illustrate this, from location 'N', a Read operation will return block 'N', and be positioned at 'N+1' (“after” N).

A successful command with a **FIXED** bit of 1b transfers the requested Transfer Length, times the current block length in bytes to the initiator. A successful command with a **FIXED** bit of 0b transfers the requested Transfer Length in bytes to the initiator. Upon completion, the logical position is “after” the last block transferred.

If **SILI** bit is 1b and the **FIXED** bit is 0b, the target performs one of the following actions:

- a) Reports **CHECK CONDITION** status for an incorrect block length condition only if the overlength condition exists and the **BLOCK LENGTH** field in the mode parameter block descriptor is non-zero. The associated sense data is 0/0000 (**INCORRECT LENGTH, NO SENSE DATA**).
- b) Does not report **CHECK CONDITION** status if the only error is the underlength condition, or if the only error is the overlength condition and **BLOCK LENGTH** field of the mode parameters block descriptor is 0b. (See note 4 on page 48.)

If the **SILI** bit is 1b and the **FIXED** bit is 1b, the target terminates the command with **CHECK CONDITION** status with associated sense data of 5/2400 (**ILLEGAL REQUEST, INVALID FIELD IN CDB**).

If the **SILI** bit is 0b and an incorrect length block is read, **CHECK CONDITION** status is returned and the **ILI** and **VALID** bits are set to 1b in the sense data. Upon termination, the logical position is “after” the incorrect length block. If the **FIXED** bit is 1b, the **INFORMATION** field is set to the requested Transfer Length, minus the actual number of blocks read (not including the incorrect length block).

If the **FIXED** bit is 0b, the **INFORMATION** field is set to the requested Transfer Length, minus the actual block length in two's complement format.

If the logical unit encounters a filemark during a command, **CHECK CONDITION** status is returned and the **FILEMARK** and **VALID** bits are set to 1b in the sense data. The associated sense data is set to 0/0001 (**NO SENSE, FILEMARK DETECTED**). Upon termination, the logical position is “after” the filemark. If the **FIXED** bit is 1b, the **INFORMATION** field is set to the requested Transfer Length, minus the actual number of blocks read (not including the filemark). If the **FIXED** bit is 0b the **INFORMATION** field is set to the requested Transfer Length.

If the logical unit encounters end-of-partition during a command, **CHECK CONDITION** status is returned and the **EOM** and **VALID** bits are set to 1b in the sense data. Associated sense data is set to 3/0002 (**MEDIUM ERROR, END OF PARTITION/MEDIUM**).

If the logical unit encounters early warning and the **REW** bit is set to 1 in the Device Configuration mode page, **CHECK CONDITION** status is returned and the **EOM** and **VALID** bits are set to 1b in the sense data. Associated sense data is set to D/0002 (**OVERFLOW, END-OF-PARTITION/MEDIUM DETECTED**). If the **FIXED** bit is 1b, the **INFORMATION** field is set to the requested Transfer Length, minus the actual number of blocks transferred. If the **FIXED** bit is 0b, the **INFORMATION** field is set to the requested Transfer Length.

If the drive encounters End-of-Data (EOD) while processing this command, the command is terminated at the EOD position and **CHECK CONDITION** status is returned with associated sense data of 8/0005 (**BLANK CHECK, END-OF-DATA DETECTED**).

If the logical unit encounters beginning-of-partition during a command, **CHECK CONDITION** status is returned and the **EOM** and **VALID** bits are set to 1b in the sense data. Associated sense data is set to 0/0004 (**NO SENSE, BEGINNING OF PARTITION/MEDIUM**).

**NOTE 3** - Because the residue information normally provided in the **INFORMATION** field of the sense data may not be available when the **SILI** bit is set, use other methods to determine the actual block length. For example: include length information in the data block itself, or in the case of underlength transfers, the host adapter or device driver may return accurate transfer length information.

**NOTE 4** - In the case of the **FIXED** bit of 1b with an overlength condition, only the position of the incorrect-length logical block can be determined from the sense data. The actual length of the incorrect block is not reported, and also cannot be derived from the transfer length (the device truncates the overlength block to match the current block length from the mode header). Other means may be used to determine the actual length (for example, backspace and read it again with **FIXED** bit set to 0b).

## 4.12.2 Interactions Summary

The following table summarizes various commands with the specified options, the encountered conditions, and the expected results.

Table 17 — Information and ILI Behavior Summary (part 1 of 3)

Scenario	Fixed	SILI	Block Length	Sense Error <sup>1</sup>	Information <sup>1 2</sup>	Flags IFE <sup>1</sup>	Position <sup>1</sup>
reportable UA	X	X	X	UA	not valid (0)	-	unchanged (no command)
reportable DCC	X	X	X	DCC	not valid (0)	-	unchanged (no command)
Read (any)	1	1	0	5/2400	transfer length	-	unchanged (no read)
	1	0	0	5/2400	transfer length	-	unchanged (no read)
Read transfer length 0	X	X	X	good	-	-	unchanged (no read)
Read (correct length(s))	X	X	X	good	-	-	after last block
Read Underlength	0	0	X	0/0000	transfer length - block size (+)	I	after block
	0	1	X	good	-	-	after block
	1	0	non-0	0/0000	transfer length - blocks read not including incorrect block (+)	I	after incorrect block
Read Overlength	0	0	X	0/0000	transfer length - block size (-)	I	after block
	0	1	0	good	-	-	after block
	0	1	non-0	0/0000	transfer length - block size (-)	I	after block
	1	0	non-0	0/0000	transfer length - blocks read not including incorrect block (+)	I	after incorrect block
Read FM	0	X	X	0/0001	transfer length	F	after filemark
	1	0	non-0	0/0001	transfer length - blocks read not including filemark (+)	F	after filemark
Read EOD	0	X	X	8/0005	transfer length	E <sup>7</sup>	unchanged (at EOD)
	1	0	non-0	8/0005	transfer length - blocks read (+)	E <sup>7</sup>	after last block (at EOD)
Read Perm	0	X	X	perm	transfer length	-	unchanged (at perm)
	1	0	non-0	perm	transfer length - blocks read (+)	-	after last block (at perm)

Table 17 — Information and ILI Behavior Summary (part 2 of 3)

Scenario	Fixed	SILI	Block Length	Sense Error <sup>1</sup>	Information <sup>1 2</sup>	Flags IFE <sup>1</sup>	Position <sup>1</sup>
Read after EOD/Perm	0	X	X	3/1404	transfer length	-	crossed EOD (position may change in non-predictable fashion, limited commands available)
	1	0	non-0	3/1404	transfer length - blocks read (+)	-	
Read (reverse) BOP	0	X	X	0/0004	transfer length	E	at BOP (0)
	1	0	non-0	0/0004	transfer length - blocks read (+)	E	at BOP (0)
Write (any)	1	-	0	5/2400	transfer length	-	unchanged (no write)
Write transfer length 0	X	-	X	-	-	-	unchanged (no write)
Write in Early Warning	0	-	X	0/0000 0/0002	0	E	after block
	1	-	non-0	0/0000 0/0002	transfer length - blocks written (usually 1)	E	after blocks written
Write at EOM	X	-	X	D/0002	transfer length	E	unchanged (no write)
Write Perm	0	-	X	perm	transfer length or 0 (if data is in buffer)	-	after last block in buffer
	1	-	non-0	perm	transfer length - blocks transferred into buffer	-	after last block in buffer
Write after Perm	X	-	X	3/3100	transfer length	-	unchanged (no write)
Locate (target after EOD)	encountered EOD			8/0005	not valid (0) <sup>5</sup>	E <sup>7</sup>	at EOD <sup>5</sup>
Locate	encountered Perm			perm	not valid (0) <sup>5</sup>	-	indeterminate (unchanged or at perm) <sup>5</sup>
Space blocks	encountered FM			0/0001	Count - blocks traversed <sup>3</sup>	F	after FM
	encountered EOD			8/0005		E <sup>6</sup>	at EOD
	encountered BOP			0/0004		E	at BOP (0)
	encountered perm			perm		-	indeterminate (unchanged or at perm) <sup>3</sup>
Space filemarks	encountered EOD			8/0005	Count - FMs traversed <sup>4</sup>	E <sup>6</sup>	at EOD <sup>4</sup>
	encountered BOP			0/0004		E	at BOP (0)
	encountered perm			perm		-	indeterminate (unchanged or at perm) <sup>4</sup>



Table 17 — Information and ILI Behavior Summary (part 3 of 3)

Scenario	Fixed	SILI	Block Length	Sense Error <sup>1</sup>	Information <sup>1 2</sup>	Flags IFE <sup>1</sup>	Position <sup>1</sup>
Space sequential filemarks	encountered EOD			8/0005	Count - sequential FMs traversed immediately prior to ending position <sup>5</sup>	E <sup>6</sup>	at EOD <sup>5</sup>
	encountered BOP			0/0004		E	at BOP (0)
	encountered perm			perm		-	indeterminate (unchanged or at perm) <sup>5</sup>
Space EOD	encountered EOD			good	- <sup>5</sup>	-	at EOD <sup>5</sup>
	encountered perm			perm	not valid (0) <sup>5</sup>	-	indeterminate (unchanged or at perm) <sup>5</sup>

**Legend:**

Flags:

I	ILI bit	#####	CC, sense of Sense Key/ASC ASCQ
E	EOM bit	perm	CC, sense as per perm
F	Filemark bit	good	No CC (no sense)
-	None set		
-	Not applicable		

**Notes:**

- These fields are outputs (results) from the scenario operation.
- Partial blocks are not considered read, written or traversed.
- Information field will accurately reflect the ending position.
- Information field will accurately reflect the ending position but it is not in units of logical blocks, so additional means of determining absolute location, such as Read Position, must be used.
- Information field does not accurately reflect the ending position, another means of determining absolute location, such as Read Position, must be used.
- The EOM bit may be set only if the current position is in the early warning region or if the end of partition is encountered.
- The EOM bit will only be set if end of partition is encountered (this condition should never occur), so EOM should not be set in this case. The standard specifies that EOM bit shall be set only if the current position is in the early warning region or if the end of partition is encountered.

## 4.13 Drive Cleaning

### 4.13.1 Cleaning the Drive in a Library

In a library, the drive may be automatically cleaned. If the library configures the drive for automatic cleaning, then the drive behaves as follows:

When the drive determines that either maintenance cleaning is required, or that the SARS thresholds have been reached, a message is sent to the library (via the Library/Drive interface) to request cleaning. This occurs when the Cleaning message is normally sent to the SCD (Single Character Display). The library schedules the mounting of the cleaning cartridge. Thus, the host operating system and application are freed of any responsibility to facilitate the cleaning.

### 4.13.2 Drive Cleaning Indicators

For stand-alone drive models, automatic cleaning of the drive is not possible. For library models, automatic cleaning of the drives by the library may be disabled (although it is not recommended). For either case, cleaning of the drives must be managed by the host application or manually, by the operator.

NOTE 5 - Failure to clean a drive may result in data loss.

This section describes how cleaning indicators are presented from the drive. The cleaning indicators may be presented even with automatic cleaning enabled in a library environment. The cleaning indicators can be presented through the following:

- a) Panel Cleaning Indication (see 4.13.2.1)
- b) Host Interface - Dynamic Cleaning Indicators (see 4.13.2.2)
- c) Host Interface - Static Cleaning Indicator (Sense Data Byte 70) (see 4.13.2.3)

#### 4.13.2.1 Panel Cleaning Indication

A CLEAN message is displayed on the SCD (Single Character Display) when cleaning with a cleaning cartridge is required. For additional details, see the Operator Guide for this product.

#### 4.13.2.2 Host Interface - Dynamic Cleaning Indicators

Dynamic cleaning indicators that are sent across the host interface include:

- a) ASC/ASCQ codes related to cleaning in Error Sense Information (see Annex B. on page 477). Cleaning Indicators reported with Sense Key 1 may only be reported in certain situations, see MP 01h: Read-Write Error Recovery (see 6.6.5 on page 366).

**Table 18 — ASC/ASCQ Codes Related to Cleaning**

Code Description	Sense Key	ASC ASCQ
Drive Requires Cleaning	0	82 82
Cleaning in Progress (cleaner cartridge)	2	30 03

- b) TapeAlert codes related to cleaning as described in LP 2Eh: TapeAlerts (see 6.4.18 on page 316).

NOTE 6 - If the device driver shields the application from dynamic notifications, the information is usually available from the system error log.

#### 4.13.2.3 Host Interface - Static Cleaning Indicator (Sense Data Byte 70)

The bit significance of sense data byte 21 follows:

Bit	Description
3	Set to 1b "Cleaning Required: Normal Maintenance" when cleaning is required because of the normal preventive maintenance guideline (See "MP 2Fh: Behavior Configuration" on page 397.). Reset to 0b when the cleaning cartridge is loaded.

#### 4.13.3 Cleaning Criteria

There are two main criteria used by the drive to call for cleaning:

- a) Clean Required (also known as Clean Now TapeAlert 14h)

Clean Required is triggered when the drive posts specific permanent errors or is running degraded. It is not based on temporary or permanent error rates. The permanent errors are typically read/write perms or servo related perm failures. Not all read/write or servo perms will trigger a clean. The errors are typically sticky, which means that the drive may not allow data operations unless a clean is performed, even if a power cycle occurs;

- b) Clean Requested (also know as Clean Periodic TapeAlert 15h)

Clean Requested is based on usage, but not media motion hours. Two criteria are used, Data sets processed or Meters of tape pulled across the head. If another cartridge is inserted after Clean Requested is asserted, the drive continues to operate. However, the 'C' on the Single Character Display (SCD) of the drive persists until the drive is cleaned or power cycled. If the drive is power cycled, the 'C'

will reappear on the SCD until the drive is cleaned. Periodic clean events continue to be posted to the engineering log (see 6.7.2.1) after every cartridge.

**Table 19 — Drive Cleaning Criteria to assert Clean Requested**

Generation	Data Sets Processed		Head Tape Meters Pulled	
	Criterion	Equivalent Full File Passes <sup>a</sup>	Criterion	Equivalent Full File Passes <sup>a</sup>
LTO 5 HH	5 000 000	8	2 500 000	39
LTO 5 FH	7 500 000	12	3 750 000	58
LTO 6 FH & HH	15 000 000	15	3 750 000	34
LTO 7 FH & HH	18 000 000	15	3 750 000	36
LTO 8 FH & HH	18 000 000	7.5	3 750 000	19
LTO 9 FH & HH	18 000 000	10	3 750 000	13

Key:  
 HH - Half-Height  
 FH - Full-Height  
<sup>a</sup> Equivalent Full File Passes is an estimate and are not used as criteria. This information provides a feel for the criteria used. Note that these criteria do not consider whether or not the tape is actually used in a full-file manner or whether the tape is only used repeatedly around a short area of tape.

## 4.14 WORM Behaviors

### 4.14.1 Conditions for Writing

If the following condition is met, writing is allowed:

- a) the cartridge is uninitialized

If all the following conditions are met, writing is allowed:

- a) the current logical position is at BOP
- b) there are only filemarks between here and EOD

If all of the following conditions are met, writing is allowed:

- a) if the current logical position is at BOP
- b) there are exactly 1 or 2 data records, followed by 0 to infinite number of filemarks, followed by no data records, followed by EOD

If all of the following conditions are met, writing is allowed:

- a) the current logical position is **between** BOP and EOD:
- b) there are only filemarks from the current logical position to EOD
- c) there is at least one filemark **immediately** before the current logical position

If the following condition is met, writing is allowed:

- a) the current logical position is at EOD

### 4.14.2 Command Behavior When WORM Medium Has Been Tampered With

Table 20 specifies the behavior of the device when it has detected the WORM medium that is loaded in the drive has been tampered with (See “MP 10h: Device Configuration” on page 375.).

**Table 20 — Behavior when the loaded medium has suspect integrity**

Command	WTRE=01b	WTRE=00b or 10b
WRITE	7/300Dh	7/300Dh
WRITE FILEMARK n (n !=0)	7/300Dh	7/300Dh
WRITE FILEMARK 0 (buffered data)	7/300Dh	7/300Dh
WRITE FILEMARK 0 (no buffered data)	GOOD	GOOD
ERASE	7/300Dh	7/300Dh
READ	GOOD	3/300Dh
VERIFY	GOOD	3/300Dh
SPACE	GOOD	3/300Dh
LOCATE to (block !=0)	GOOD	3/300Dh
LOCATE to 0	GOOD	GOOD
REWIND	GOOD	GOOD
UNLOAD	GOOD	GOOD
LOAD	GOOD	GOOD

## 4.15 Device Hardware Encryption

This device contains hardware which performs user data write encryption and read decryption, protecting all user data written to the medium from unauthorized use [provided it is integrated into a secure system design]. Device support for encryption may be determined by reading MP 24h: Vendor-Specific (see 6.6.19 on page 393) with the MODE SENSE command.

This device supports multiple ways of controlling encryption settings. These encryption control methodologies are called:

- a) Encryption Control - IBM Proprietary Protocol (IPP) (see 4.15.1 on page 54); and
- b) Encryption Control - T10 Standards (see 4.15.2 on page 55).

On volumes with multiple partitions, the drive handles encryption in each partition as determined by the state of the partition, position of the write and the current method / mode / policy:

- a) if the encryption method in the drive is set to the IBM proprietary methods (see 4.15.1) and the position is at BOP (logical object 0), then the block encryption is determined by the BOP write policy (if set to encrypt the write will not be allowed if there is no current key);
- b) if the encryption method in the drive is set to the IBM proprietary methods (see 4.15.1) and the current position is not at BOP (logical object greater than 0), then encryption is required only if there is at least one encrypted block anywhere on that partition; and
- c) if the encryption method in the drive is set to AME-T10 (see 4.15.2), then an intermix of encrypted and unencrypted blocks are allowed.

### 4.15.1 Encryption Control - IBM Proprietary Protocol (IPP)

The following terms are used to describe the methods of control that fall into the IPP:

- a) Library Managed Encryption (LME);
- b) System Managed Encryption (SME); and
- c) Application Managed Encryption - IBM (AME-IBM).

When a device is enabled to perform encryption using one of the IBM Proprietary Protocols (i.e., LME, SME, or AME-IBM) encryption parameters are determined at first write from BOP. On volumes with multiple partitions this means that on a write from BOP (i.e. LBA 0) of each partition the encryption parameters are determined. Writes away from BOP use the existing encryption parameters. If any logical block on the partition is encrypted, then all logical blocks subsequently written to the partition must be encrypted. If no logical blocks on the partition are encrypted then subsequent logical blocks are not required to be encrypted. When a partition change occurs the encryption parameters are cleared.

Please see IBM for additional information on IPP.

#### 4.15.2 Encryption Control - T10 Standards

The T10 standards method of controlling encryption are described in SSC-5 as well as in this document. Note that not all methods described in SSC-5 are supported.

This device uses the term Application Managed Encryption - T10 (AME-T10) to signify that it is using this standards based method.

When this device is enabled to perform encryption using AME-T10 the encryption parameters are set by either the application or the library (see 4.15.2.1) depending on how AME-T10 is configured. When the encryption parameters are set to encrypt, logical blocks are encrypted. When encryption parameters are set to not encrypt, logical blocks are not encrypted. Changing partitions when enabled for AME-T10 does not affect the encryption parameters.

This device supports the T10 method of passing the key in clear text. Some generations support RSA key wrapping with KEY FORMAT 02h. For specifics on support refer to SECURITY PROTOCOL IN (SPIN) - A2h (see 5.2.34 on page 169), SECURITY PROTOCOL OUT (SPOUT) - B5h (see 5.2.35 on page 170), and Security Protocol Parameters (SPP) (see 6.8 on page 439).

##### 4.15.2.1 External Data Encryption Control

This device supports control of encryption via the Automation/Drive Interface (ADI) using some of the methods described in ADC-4. Refer to the ADI Implementation Reference for a description of how to enable these methods.

## 4.16 Attachment Features

### 4.16.1 Types of Interface Attachments

This device communicates with servers that use Fibre Channel or SAS interfaces. The interfaces share certain tape LUN behaviors, but also possess unique features. This chapter describes the common and unique features of these interfaces.

### 4.16.2 Common Tape LUN Behaviors

Fibre Channel and SAS attached devices share the following tape LUN behaviors:

- a) Power-On (see 4.16.2.1 on page 56);
- b) Reset Strategy (see 4.16.2.2 on page 56);
- c) Abort Handling (see 4.16.2.3 on page 56);
- d) Multi-initiator Support (see 4.16.2.4 on page 58); and
- e) Status Codes (see 4.16.2.5 on page 58).

#### 4.16.2.1 Power-On

The first UAT eligible command (see table 31) from any initiator gets a CHECK CONDITION status with UNIT ATTENTION sense data for the power-on. After this, any medium access command is reported with a Sense Key of NOT READY and an additional sense code of LUN HAS NOT SELF-CONFIGURED YET (3E00).

If a cartridge is mounted in the drive when it powers up, the cartridge is unloaded, and once the drive has completed its self test and setup procedures, the drive attempts to load the cartridge. During this unmount, self-test, and remount processing, medium access commands are reported with an additional sense code of DRIVE IN PROCESS OF BECOMING READY (0401).

#### 4.16.2.2 Reset Strategy

The drive supports the hard reset option as is required by SCSI-3. On receiving a reset, the following actions are taken:

- a) The current I/O process is aborted, as in Abort Handling.
- b) Any queued I/O processes from other initiators are removed.
- c) All SPC-2 reservations are cleared, but Persistent Reservations remain in effect.
- d) Most mode values are reset to their defaults.
- e) A unit attention condition is set.
- f) A logical position is established that may or may not be the same as the position prior to the reset. Where possible, the logical position prior to reset is maintained.
- g) The next command that is eligible for the UNIT ATTENTION CHECK CONDITION from each initiator gets a CHECK CONDITION STATUS, with UNIT ATTENTION sense data for the reset. However, other commands may not be processed until the internal state of the drive has been reset.

#### 4.16.2.3 Abort Handling

Table 21 specifies the abort processing for this device.

**Table 21 — Abort Condition Handling (part 1 of 2)**

Command	Abort Processing
ALLOW OVERWRITE	The Command completes
ERASE	Long erase is aborted as quickly as possible without corrupting tape format. Short erase completes.
FORMAT	If modification to medium has started then the command is completed; otherwise, no action is taken.
INQUIRY	None.
LOAD/UNLOAD	Load completes (e.g., if the HOLD bit is zero, logically positions tape at BOP 0). Unload is aborted, leaving logical position at BOP 0 unless operation is past the 'point of no return', in which case the unload completes (e.g., if the HOLD bit is zero, the tape is ejected).
LOCATE	The logical position is set back to that at the start of the operation unless the operation is past its 'point of no return', in which case the operation completes.
LOG SELECT	If data transfer is completed, command is completed; otherwise, no action is taken.
LOG SENSE	None.
MODE SELECT	If data transfer is completed, command is completed; otherwise, no action is taken.
MODE SENSE	None.
PERSISTENT RESERVE IN	None.

Table 21 — Abort Condition Handling (part 2 of 2)

Command	Abort Processing
PERSISTENT RESERVE OUT	If data transfer is completed, the command is completed; otherwise, no action is taken.
PREVENT ALLOW MEDIUM REMOVAL	The command completes.
READ	The current position is set after the last logical block to be completely transferred to the host.
READ ATTRIBUTE	None.
READ BLOCK LIMITS	None.
READ BUFFER	None.
READ POSITION	None.
RECEIVE DIAGNOSTIC RESULTS	None.
RELEASE UNIT	The command completes.
REPORT DENSITY SUPPORT	None.
REPORT LUNs	None.
REPORT SUPPORTED OPERATION CODE	None.
REPORT SUPPORTED TASK MANAGEMENT FUNCTIONS	None.
REQUEST SENSE	Sense data is discarded.
RESERVE UNIT	The command completes.
REWIND	The command completes.
SECURITY PROTOCOL IN	None.
SECURITY PROTOCOL OUT	If data transfer is completed, the command is completed; otherwise, no action is taken.
SEND DIAGNOSTIC	Vendor unique.
SET CAPACITY	If modification to medium has started then the command is completed; otherwise, no action is taken.
SPACE	The logical position is set back to that at the start of the operation unless the operation is past its 'point of no return', in which case the operation completes.
TEST UNIT READY	None.
VERIFY	The logical position is set to the next record boundary after the point where the verify was aborted.
WRITE	Depending on where in the processing of the command the drive is, either no logical blocks, the logical block, or some of the logical blocks, if transferring in fixed block mode, are written to the buffer. The logical position is set to the point where the last block was written.
WRITE ATTRIBUTE	If data transfer is completed, the command is completed; otherwise, no action is taken.
WRITE BUFFER	If data transfer is completed, the command is completed; otherwise, no action is taken.
WRITE FILEMARKS	The command completes.

#### 4.16.2.4 Multi-initiator Support

This device supports an infinite number of I\_T nexuses, but the device has a limit on how many I\_T nexuses can be logged in processing commands concurrently. If this limit is exceeded, then the device implicitly logs out the least recently used (LRU) I\_T nexus that:

- a) is not reserved;
- b) is not registered;
- c) is not the I\_T nexus that last processed a medium access command; and
- d) does not have an outstanding command.

The device supports untagged queuing when operating with multiple initiators. If a command from one initiator is being processed when a command other than INQUIRY, REPORT LUNs, REQUEST SENSE, and TEST UNIT READY is received from a second initiator, the new command may be queued. Media access commands (for example, WRITE, WRITE FILEMARKS, READ, VERIFY, REWIND, MODE SELECT that changes block size) are always processed in strict order of receipt.

The INQUIRY, REPORT LUNS, REQUEST SENSE, and TEST UNIT READY commands are always processed immediately, irrespective of whether a command from another initiator is being processed.

The drive maintains sense data for the supported number of initiators. If an additional initiator connects to the drive and causes an initiator to be implicitly logged out, the drive erases all sense data for that initiator before processing the command for the new initiator. See Sense Data Management (see 4.19.2 on page 64) for more details of sense data management.

#### 4.16.2.5 Status Codes

**Table 22 — Status Codes**

Status Code	Value	Circumstance
GOOD	00h	The command completed without problems.
CHECK CONDITION	02h	A problem occurred during command processing. The sense data should be examined to determine the nature of the problem.
BUSY	08h	The drive is unable to accept the command at this time. This status is returned during the power-on sequence or if there are commands from too many I_T nexuses outstanding, see Multi-initiator Support (4.16.2.4 on page 58).
RESERVATION CONFLICT	18h	This status is returned if the drive is reserved for an I_T nexus other than the one sending the command.
QUEUE FULL	28h	Not normally returned.

#### 4.16.3 Features of the Fibre Channel Interface

This device is compliant with the American National Standard, Project T10/Project 1828-D, Information Technology - Fibre Channel Protocol for SCSI, Fourth Version (FCP-4), Revision 02b, January 3, 2011. The key features of the FC-Tape Technical Report of the Accredited Standard Committee NCITS that were found useful are included in FCP-4. IBM recommends that a server's device driver and host bus adapter (HBA) use:

- a) Precise delivery of commands;
- b) Confirmed completion of FCP I/O operations;
- c) Retransmission of unsuccessfully transmitted IUs; and
- d) Task retry identification as defined in FCP-4.

These features may be listed in HBA settings either individually or as a group and called:

- a) FCP-2 support;
- b) Class-3 Error Recovery;



- c) FC-Tape;
- d) Confirmed Completion; or
- e) Task retry identification.

The World Wide Node Name and Port Name that are used by the device follow the format of the Institute of Electrical and Electronics Engineers (IEEE).

#### 4.16.3.1 Topology

Fibre Channel devices (such as this device and a server) are known as nodes and have at least one port through which to receive and send data. The collection of components that connect two or more nodes is called a topology. Fibre Channel systems consist solely of two components: nodes with ports and topologies.

Each port uses a pair of fibers: one fiber carries data into the port, and the other carries data out of the port. The fibers in the channel are optical strands. The fiber pair is called a *link* and is part of the topology. Data is transmitted over the links in units known as *frames*. A frame contains an address identifier that gives the fabric and node for which the frame is destined.

This device can be attached in a two-node configuration, either directly to a switch as a public device (switched fabric) or directly to a host bus adapter (HBA) as a private device (direct connection). This device may be configured to any supported topology via a library interface, or configured by using vital product data (VPD) settings. The type of connection also depends on whether the drive recognizes the connection as a loop or a fabric connection:

- a) An L\_port supports a Fibre Channel Arbitrated Loop connection to an L\_port or FL\_port.
- b) An N\_port supports direct connection to an F\_port (for example, a director-class switch) in a fabric topology.

Regardless of the port to which this device is connected, it automatically configures to a public device (through an F\_port or FL\_port to a switch) or to a private device (through an L\_port by using direct attachment to a server). This device supports two topologies:

- a) Two-Node Switched Fabric Topology (see 4.16.3.1.1 on page 60); and
- b) Two-Node Direct Connection Topology (see 4.16.3.1.2 on page 60).

Table 23 lists the topologies in which this device is able to operate, the Fibre Channel server connections that are available, and the port (NL, N, FL, or F) through which communication must occur. The sections that follow describe each topology.

**Table 23 — Topologies through which this device's port(s) can operate**

Drive Port Configuration	Type of Fibre Channel Port to Which the Drive Port Connects			
	Server Port (HBA) (Private - Direct Connection)		Switch Port (Public - Switched Fabric)	
	Point-to-Point Topology (N_Port)	Arbitrated Loop Topology (FC-AL)		Fabric Topology (F_Port)
		L_Port	FL_Port	
Drive port configured to operate as L_Port	Invalid system configuration	L_Port	L_Port	Invalid system configuration
Drive port configured to operate as N_Port	N_Port (not supported)	Invalid system configuration	N_Port (switched fabric)	N_Port
Drive port configured to operate as LN_Port	N_Port (not supported; attempts L_Port)	L_Port	L_Port	N_Port
Drive port configured to operate as NL_Port	N_Port (not supported; attempts L_Port)	L_Port	N_Port	N_Port

#### 4.16.3.1.1 Two-Node Switched Fabric Topology

The two-node switched fabric topology supports two protocols:

- a) Use the two-node switched fabric loop protocol when attaching the device to an FL\_port; and
- b) Use the two-node switched fabric protocol when attaching the device to an F\_port.

#### 4.16.3.1.2 Two-Node Direct Connection Topology

A two-node direct connection occurs when two Fibre Channel end points are connected together. Either Arbitrated Loop or Point-to-Point topology is defined as usable in the standards, but both end points must use the same topology. Most Fibre Channel adapters have settings that allow selection of the topology or they default to the loop topology when they are not directly connected to a fabric. While this device allows you to set the port to any of these topologies (see the instructions of the library in which this device is contained) this device supports only the use of the Arbitrated Loop (L\_port) topology in a two-node direct connection. Use of the Point-to-Point topology in a two-node direct connection to an N\_port is not supported, but not prohibited.

#### 4.16.3.2 Speed

This device is an 8GFC device. This device also allows operation using previous Fibre Channel generations: 1GFC, 2GFC, and 4GFC. Each Fibre Channel generation transfers data at the following rates:

- a) 1GFC transfers data at a max burst rate of 100 MB/s;
- b) 2GFC transfers data at a max burst rate of 200 MB/s;
- c) 4GFC transfers data at a max burst rate of 400 MB/s;
- d) 5GFC transfers data at a max burst rate of 800 MB/s;

This device may be configured via a library interface or vital product data (VPD) in one of the following speed configurations:

- a) 1GFC;
- b) 2GFC;
- c) 4GFC;
- d) 8GFC; or
- e) speed negotiate

#### 4.16.3.3 Addressing Assignments

Each Fibre Channel interface port for this device can be independently assigned a specific speed and topology, or may be set to auto-negotiate.

When the topology is set to or negotiates to L-port, a hard or soft ALPA ID may be assigned. The hard ALPA ID is in the range of 01h to EFh with only certain valid values (a total of 126 addresses). Validity is enforced by the entry process. This value should be unique to each device on the Fibre Channel loop. Fibre Channel loop protocol will detect an addressing conflict on the loop, and one of the conflicting drives will not be available for use.

#### 4.16.4 Features of the Serial Attached SCSI (SAS) Interface

The World Wide Node Name and Port Name that are used by this device follow the format of the Institute of Electrical and Electronics Engineers (IEEE).

This device is compliant with the American National Standard, Project T10/1760-D, Information technology - Serial Attached SCSI - 2 (SAS-2), Revision 16, 18 April 2009.

## 4.17 Device Clocks

The drive supports a Device Clock that maintains a timestamp for various items. This timestamp gets recorded in drive error logs.

The `TIMESTAMP ORIGIN` is one of those specified in table 24.

Table 24 — `TIMESTAMP ORIGIN`

Value	Definition
000b	Timestamp initialized to zero at power-on
001b	Reserved
010b	Timestamp initialized by the <code>SET TIMESTAMP</code> command
011b	Timestamp initialized by the Library over the Library Drive Interface (i.e. RS-422)
100b - 111b	Reserved

Once a timestamp is initialized it begins counting from that time forward. Once the timestamp is initialized it remains in effect until one of the following occurs:

- a) A `SET TIMESTAMP` command (see 5.2.38) is processed;
- b) An `LDI` command is processed that modifies the timestamp; or
- c) A Hard Reset event occurs.

The method used is indicated in the Extended Control mode page.

The Timestamp is not affected by an `I_T` nexus loss or a Logical Unit reset.

The `TIMESTAMP` is specified in table 25.

Table 25 — `TIMESTAMP` Format

Byte	Bit								
	7	6	5	4	3	2	1	0	
0	(MSB)								
5	TIMESTAMP								(LSB)

The `TIMESTAMP` field contains the value established at the last action that set the timestamp incremented by one for every millisecond that has elapsed since the timestamp was set.

## 4.18 Dynamic runtime information

### 4.18.1 Dynamic runtime information overview

Dynamic runtime information allows an initiator to set dynamic runtime attributes (DRA) about itself into a device server. The device server then associates those attributes to the `I_T_L` nexus and uses the information and associations for enhanced data collection and debugging. This information and the associations are added to device error logs (e.g., drive dump) and are provided for retrieval by an application client through the `READ DYNAMIC RUNTIME ATTRIBUTE` command (see 5.2.19).

The Ultrium 5 and later devices support dynamic runtime attributes with the `READ DYNAMIC RUNTIME ATTRIBUTE` command (see 5.2.19) and the `WRITE DYNAMIC RUNTIME ATTRIBUTE` command (see 5.2.45). These commands are used to retrieve and store information in the form of dynamic runtime attributes.

A DRA is represented in the format described in 6.1.1.

There are three types of DRA attributes (see table 26).

**Table 26 — Types of DRA attributes**

Attribute Type	Focus	Attribute Source	Readable with READ DYNAMIC RUNTIME ATTRIBUTE	Writable with WRITE DYNAMIC RUNTIME ATTRIBUTE	Reference
Logical unit	Device	Set by the device server.	Yes	No	6.1.2.2
Target	I_T nexus	Set by the device server.	Yes	No	6.1.2.3
Initiator	I_T nexus	Set by the application client	Yes	Yes	6.1.2.4

DRA attributes have the states shown in table 27.

**Table 27 — DRA attribute states**

Attribute State	Description
Read Only	An application client may read the contents of the DRA attribute with the READ DYNAMIC RUNTIME ATTRIBUTE command, but an attempt to clear or change the DRA attribute using the WRITE DYNAMIC RUNTIME ATTRIBUTE command shall result in the command being terminated with CHECK CONDITION status with the sense key set to DATA PROTECT and the additional sense code set to WRITE PROTECTED. When in the read only state the READ ONLY bit (see 6.1.1) is one.
Unsupported	The device server does not support the DRA attribute and shall not return it in response to a READ DYNAMIC RUNTIME ATTRIBUTE command.
Nonexistent	An initiator attribute does not exist in the dynamic runtime attributes until a WRITE DYNAMIC RUNTIME ATTRIBUTE command creates it.
Read/Write	The DRA attribute has been created using the WRITE DYNAMIC RUNTIME ATTRIBUTE command. After the DRA attribute has been created, the contents may be altered using subsequent WRITE DYNAMIC RUNTIME ATTRIBUTE commands. A Read/Write DRA attribute may be returned to the nonexistent state using a WRITE DYNAMIC RUNTIME ATTRIBUTE command with the attribute length set to zero. When in the Read/Write state the READ ONLY bit (see 6.1.1) is zero.

#### 4.18.2 Dynamic runtime information timestamp

Some dynamic runtime attributes have a timestamp associated with them. The timestamp used is described in Device Clocks (see 4.17 on page 61). If no timestamp is set by either a SCSI command (i.e., SET TIMESTAMP or ) or by the library, then the timestamp is power-on time and may not be able to be correlated to external logs (e.g., device driver logs, application logs).

#### 4.18.3 Setting dynamic runtime information into the drive

An application client may set attributes into the drive using the WRITE DYNAMIC RUNTIME ATTRIBUTE command (see 5.2.45) to set one or more of the initiator type attributes defined in 6.1.2.4. The application client may write these values at any time and may change these values at any time. If an application client attempts to create a new attribute by writing an attribute that was previously in the non-existent state and the device server does not have the resources necessary to create that attribute the device server shall reject the command with a CHECK CONDITION with the sense code set to ILLEGAL REQUEST and the additional sense code set to INSUFFICIENT RESOURCES (i.e., 5h / 5503h).

#### 4.18.4 Retrieving dynamic runtime information from the drive

An application client may read attributes by using the READ DYNAMIC RUNTIME ATTRIBUTE command (see 5.2.19). The application client may request a single attribute or multiple attributes in a single command. The application client may read any existent attribute (see 6.1).

#### 4.18.5 Management of dynamic runtime information

Dynamic runtime attributes have either a focus of a logical unit (i.e., logical unit type attributes) or a focus of I\_T nexus (i.e., target type attributes and initiator type attributes). This relationship is shown in figure 7.

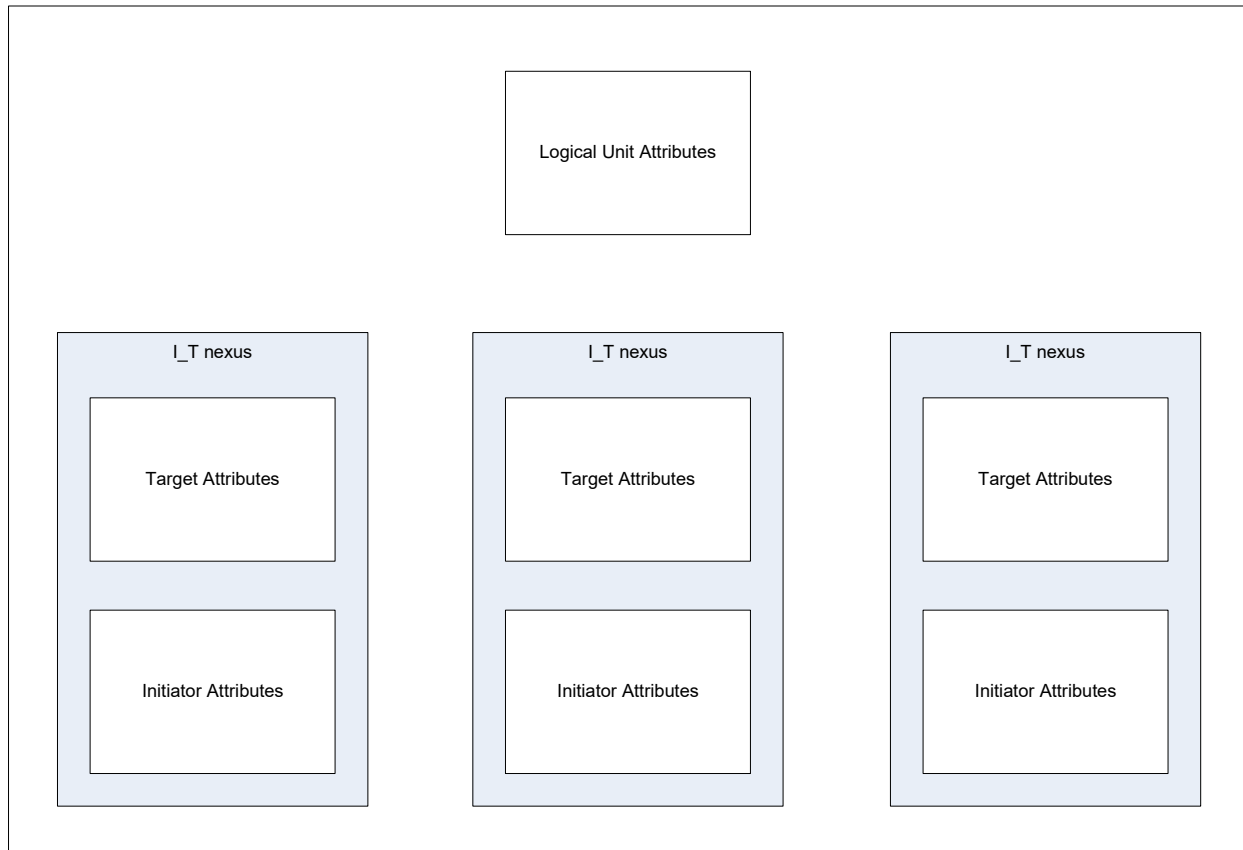

**Figure 7 — Dynamic runtime attributes focus**

For each dynamic runtime attribute (see 6.1) that the device server supports, if a command is received that should cause an update of one or more of the dynamic runtime attributes (e.g., Reserve, Persistent Reserve Out, Prevent/Allow Medium Removal), then the device server shall update that dynamic runtime attribute. If one or more of the Initiator type attributes that are supposed to be used to update the dynamic runtime attribute is in the nonexistent state, then all information that is known is used. The TransportID of the I\_T\_L nexus and the target port identifier of the I\_T\_L nexus is always known from the transport layer and are presented as target type attributes.

##### 4.18.5.1 Dynamic Runtime Information Lifetime

Dynamic Runtime Attributes are maintained separate from the device server's management of I\_T nexuses. The I\_T\_L nexus identifying information (see 6.1.2.2.1) remains in existence inside dynamic runtime attributes even after the I\_T nexus referenced is no longer known by the SCSI target port.

Logical unit type attributes (see 6.1.2.2) are created if an event occurs as described in the description of each logical unit type attribute and are destroyed if an event occurs as described in the description of each specific logical unit type attribute.

Target type attributes (see 6.1.2.3) are created by the drive if it detects communication from a new I\_T nexus (e.g., Fibre Channel PLOGI/PRLI sequence) and are destroyed by the drive if it detects the disappearance of the I\_T nexus (e.g., Fibre Channel LOGO, I\_T nexus resources are released to allow a new I\_T nexus to communicate with the drive).

Initiator type attributes (see 6.1.2.4) are created if a WRITE DYNAMIC RUNTIME ATTRIBUTE command is received requesting a new attribute and are destroyed if the drive detects the destruction of the target type attribute associated with the I\_T nexus that created the Initiator type attribute or the drive processes a WRITE DYNAMIC RUNTIME ATTRIBUTE command specifying that attribute with a length of zero..

Dynamic Runtime Attributes do not persist across a device power off.

## 4.19 Error Information

### 4.19.1 Sense Data

For a description of Sense data, see Sense Data Format (5.2.31.1 on page 162).

### 4.19.2 Sense Data Management

Sense data returned by the device contains one of two types of errors. These errors are:

Type	Description
Current	The error condition associated with the command that is currently being processed (i.e., SCSI Status for the currently processing command is the status being returned); and
Deferred	The error condition resulting from a command that has been reported as GOOD, but has generated sense data after being reported. This may be a command with the Immediate bit set or may be a buffered write.

Sense data returned is described by the Sense Key (i.e., bits 3-0 of byte 2 of Sense data). Commands that terminate in an error generate Sense data and set the Sense Key depending on the the specifics of the error. Supported Common SCSI Commands (see Table 31 — on page 76), indicates which commands are allowed to be processed in the presence of specific error conditions and which return an error.

This device communicates on transports that use the autosense protocol. This means that any Sense data generated for return to a command is returned with the SCSI status. Once a particular set of sense data has been returned, that sense data is cleared and a REQUEST SENSE command is not required to be issued to collect the Sense data. Any other sense data that is still pending may still cause CHECK CONDITION status for subsequent commands. When a REQUEST SENSE command is received, typically the only Sense data available is the default Sense data. While it is possible that a Deferred error may have generated Sense data or that a Unit Attention (see 4.19.4) has been established since the status to the last command, Sense data is not likely to exist.

### 4.19.3 Deferred Check Condition (DCC)

Deferred errors are generated by processing that occurs when that process is not attached to the currently processing command (see 4.19.2). Deferred errors are reported as sense data to a deferred check condition (DCC) eligible command (i.e., DCC column of table 31 on page 76 is set to 'Y').

In the case of a deferred write error if buffered mode 1h is selected and a DCC eligible command is received, then the error is reported to the SCSI initiator device (i.e., I\_T nexus) that has deferred error affinity.

If the drive receives a deferred error affinity command (i.e., DEA column of table 31 on page 76 is set to 'Y'), then the drive performs actions in the following order:

- 1) performs initial checking (e.g., Reservation Conflict, all pending Unit Attentions, and all pending errors to be reported to this I\_T nexus) and reports these conditions, if any;
- 2) if none of the above conditions are reported, then all pending deferred errors are migrated to the I\_T nexus through which this command was received;

- 3) the deferred error affinity is set to this I\_T nexus;
- 4) if the command is DCC eligible, then pending deferred errors, if any, are reported; and
- 5) if no deferred errors were reported process the command.

#### 4.19.4 Unit Attention Conditions

The drive generates a Unit Attention condition under the following circumstances:

- a) Reset condition (for example, power-on, SCSI reset, bus device reset);
- b) Tape Loaded condition (for example, media inserted, LOAD command from another initiator);
- c) Mode parameters changed by another initiator; and
- d) Drive firmware has been upgraded.

The drive only maintains one instance of each type of Unit Attention condition at any one time for any one initiator. If a subsequent Unit Attention condition of the same type is generated, it replaces the existing one. Unit Attentions are returned in priority order. The priorities are in the order listed above, with a reset being highest priority and a firmware upgrade being lowest priority.

#### 4.19.5 Persistent Errors

When errors occur that prevent tape operation, they are reported persistently until the problem is cleared. For medium-related errors (usually reported with a Sense Key of 3), the error is reported until the cartridge is successfully unloaded. For hardware-related errors (usually reported with a Sense Key of 4), the error is reported until the drive successfully performs a power-on self test. These persistent errors are only reported on those commands that are eligible for deferred Check Condition reporting (see table 31 on page 76). The error may or may not be reported as Deferred.

##### 4.19.5.1 Fencing Behavior

The device fences the drive (i.e., prevents certain operations) when errors are detected that could endanger customer data if further usage is allowed. The operations that are prevented depend on the nature of the error encountered and the current drive state. The drive will post an FSC (see bytes 16 and 17 of REQUEST SENSE data in Sense Data Format (see 5.2.31.1 on page 162)) for the original error that caused the fence condition. Then, CHECK CONDITION status, with the fencing FSC in the sense data is reported to an attempted command that is not allowed due to the fence condition.

Table 28 lists which errors trigger which fence state.

**Table 28 — Error to Fence State mapping**

Error that triggers Fence State	Fence State
Severe Drive Hardware problem Severe Media Hardware problem Temperature Overrange Load or Unload Hardware problem Severe Firmware Problem	ALLOW_NO_OPERATION (see 4.19.5.1.1 on page 66)
Hardware Problem detected that could affect Writing Hardware Problem detected that could affect Reading	ALLOW_LOCATE (see 4.19.5.1.2 on page 66)
Serious Drive Hardware problem -- May be recovered on a different mount Serious Media problem -- Drive may be recovered on different mount Serious Firmware problem -- May be recovered on different mount	ALLOW_UNLOAD (see 4.19.5.1.3 on page 66)
Power on occurs and the device detects a volume is loaded. This may be due to a device panic/exception.	MID-TAPE RECOVERY (see 4.19.5.1.4 on page 66)

**4.19.5.1.1 ALLOW\_NO\_OPERATION**

- a) All medium access commands (Read/Write/Motion) are rejected.
- b) (SCSI/Panel/LDI) Unload is accepted.
- c) After the cartridge is ejected:
  - A) When load is attempted, the cartridge stays at mount position and Good status is returned for TUR.
  - B) From the above state, the cartridge can be ejected normally.
  - C) Other medium access commands are rejected.

**4.19.5.1.2 ALLOW\_LOCATE**

- a) All medium access commands (Read/Write/Implicit Motion) except explicit positioning command (i.e., LOCATE, REWIND, LOAD) are rejected.
- b) (SCSI/Panel/LDI) Unload is accepted.
- c) Once a cartridge is ejected, Fence state is cleared. A new cartridge is allowed to be loaded and all medium access commands are allowed to be performed.
- d) Space command is rejected while in Fence state.

**4.19.5.1.3 ALLOW\_UNLOAD**

- a) All medium access commands (Read/Write/Motion) are rejected.
- b) (SCSI/Panel/LDI) Unload is accepted.
- c) Once a cartridge is ejected, Fence state is cleared. A new cartridge is allowed to be loaded and all medium access commands are allowed to be performed.

**4.19.5.1.4 MID-TAPE RECOVERY**

The Mid-Tape Recovery (MTR) fence behavior is configured in MP 2Fh: Behavior Configuration (see 6.6.20 on page 397). There are two different behaviors:

- a) Normal operation (i.e., MTR Fence) (see 4.19.5.1.4.1 on page 66); and
- b) Panic Fence operation (see 4.19.5.1.4.2 on page 67).

**4.19.5.1.4.1 Normal operation (i.e., MTR Fence)**

When the device powers up and no cartridge is detected, no special behavior is required and the device:

- 1) responds to the first UNIT ATTENTION eligible command with 6/2900;
- 2) responds to a CHECK CONDITION eligible command, if any, with 2/3E00 during POST; and
- 3) enters normal operation when POST is completed successfully.

When the device powers up and detects a mounted cartridge, Mid-Tape Recovery (MTR) is required and the device:

- 1) responds to the first UNIT ATTENTION eligible command with 6/2900;
- 2) responds to a CHECK CONDITION eligible command, if any, with 2/3E00 until POST is complete;
- 3) responds to a CHECK CONDITION eligible command, if any, with 2/0401 during MTR/Unload;
- 4) responds to a CHECK CONDITION eligible command, if any, with 2/0401 during MTR/Load; and then
- 5) enters the MTR Fence State when the MTR/Load has completed. In the MTR Fence State, the device:
  - A) responds to the first UNIT ATTENTION eligible command received after entering the MTR Fence State (i.e., after cartridge is loaded) with 6/2800;
  - B) responds to TUR commands, if any, with GOOD status;
  - C) responds to any medium access command not listed in the next step, if any, with 5/2C00; and
  - D) exits the MTR Fence State if an explicit positioning command completes successfully (i.e., LOCATE, REWIND, LOAD).



#### 4.19.5.1.4.2 Panic Fence operation

When the device powers up after a Panic or Exception and no cartridge is detected the device:

- 1) responds to the first UNIT ATTENTION eligible command with 6/2900;
- 2) responds to a CHECK CONDITION eligible command, if any, with 2/3E00 during POST; and
- 3) when POST is complete, enters into the Panic Fence state. In the Panic Fence state the device:
  - A) rejects SCSI commands other than RSNS/INQ/RLUNs/Read Buffer with 5/2904 sense, indicating Panic Fence state;
  - B) rejects a TUR command with 5/2904;
  - C) rejects attempts to Load a cartridge through any means;
  - D) accepts, at any time, a SCSI Read Buffer to read dump data;
  - E) exits the Panic Fence state after a dump has been successfully read and transitions to normal mode.

When the device powers up and detects a mounted cartridge, Mid-Tape Recovery (MTR) is required and the device:

- 1) responds to the first UNIT ATTENTION eligible command with 6/2900;
- 2) responds to a CHECK CONDITION eligible command, if any, with 2/3E00 until POST is complete;
- 3) responds to a CHECK CONDITION eligible command, if any, with 2/0401 during MTR/Unload;
- 4) responds to a CHECK CONDITION eligible command, if any, with 2/0401 during MTR/Load; and then
- 5) enters the Panic Fence State when the MTR/Load has completed. In the Panic Fence state the device:
  - A) responds to the first UNIT ATTENTION eligible command received after entering the Panic Fence State (i.e., after cartridge is loaded) with 6/2800;
  - B) rejects SCSI commands other than RSNS/INQ/RLUNs/Read Buffer with 5/2904 sense, indicating Panic Fence state;
  - C) returns GOOD status to a TUR command while cartridge is loaded;
  - D) rejects a TUR command with 5/2904;
  - E) allows processing of Unload command through SCSI/LDI/Button;
  - F) rejects attempts to Load a cartridge through any means;
  - G) accepts, at any time, a SCSI Read Buffer to read dump data;
  - H) exits the Panic Fence state after a dump has been successfully read and:
    - a) if there is no cartridge loaded, then transitions to normal mode; or
    - b) if there is a cartridge loaded, then transitions to the MTR Fence State. In the MTR Fence State, the device:
      - A) responds to TUR commands, if any, with GOOD status;
      - B) responds to any medium access command not listed in the next step, if any, with 5/2C00; and
      - C) exits the MTR Fence State if an explicit positioning command completes successfully (i.e., LOCATE, REWIND, LOAD).

## 4.20 Medium auxiliary memory

Some types of media, especially removable media, include a non-volatile memory referred to as MAM (medium auxiliary memory). Medium auxiliary memory is used to store data describing the media and its contents. This standard supports medium auxiliary memory with the READ ATTRIBUTE command (see 5.2.16) and the WRITE ATTRIBUTE command (see 5.2.43). These commands are used to retrieve and store information in the medium auxiliary memory in the form of MAM attributes.

A MAM attribute is represented in the format described in MAM attribute format (see 6.5.1 on page 349).

There are three types of MAM attributes (see table 29).

**Table 29 — Types of MAM attributes**

Attribute Type	Attribute Source	Example	Readable with READ ATTRIBUTE	Writable with WRITE ATTRIBUTE
Medium	Permanently stored in the medium auxiliary memory during manufacture.	Media Serial Number	Yes	No
Device	Maintained by the device server.	Load Count	Yes	No
Host	Maintained by the application client.	Backup Date	Yes	Yes

Depending on that attribute type, MAM attributes have the states shown in table 30.

**Table 30 — MAM attribute states**

Attribute Type	Attribute State	Description
Medium or Device	Read Only	An application client may read the contents of the MAM attribute with the READ ATTRIBUTE command, but an attempt to clear or change the MAM attribute using the WRITE ATTRIBUTE command shall result in the command being terminated with CHECK CONDITION status. When the READ ONLY bit (see 6.5.1) is one, the attribute is in the read only state.
	Unsupported	The device server does not support the MAM attribute and shall not return it in response to a READ ATTRIBUTE command.
Host	Nonexistent	A host attribute does not exist in the medium auxiliary memory until a WRITE ATTRIBUTE command creates it.
	Read/Write	The MAM attribute has been created using the WRITE ATTRIBUTE command. After the MAM attribute has been created, the contents may be altered using subsequent WRITE ATTRIBUTE commands. A read/write MAM attribute may be returned to the nonexistent state using a WRITE ATTRIBUTE command with the attribute length set to zero. When the READ ONLY bit (see 6.5.1) is zero, the MAM attribute is in the read/write state.

## 4.21 Volume Coherency

An application client may need to be able to determine if all logical objects on a volume are coherent with the last time an application client wrote to this volume. The VOLUME COHERENCY INFORMATION attribute (see 6.5.2.4.11) of MAM is provided for an application client to collect and save information necessary for this determination.

The VOLUME COHERENCY INFORMATION attribute for each partition is written to MAM by the application client when it has completed a write job (e.g., the volume is demounted). The VOLUME COHERENCY INFORMATION attribute contains references to a volume coherency set that the application client has written to logical objects on a partition. An application client should not create a VOLUME COHERENCY INFORMATION attribute unless it has written a volume coherency set to that partition. The volume coherency set shall include a volume coherency count. The application client shall maintain one volume coherency count for an entire volume and shall monotonically increase the volume coherency count when the state of the volume coherency set changes (e.g., writing identical volume coherency sets on each partition does not force a change of volume coherency count). When the application client writes the VOLUME COHERENCY INFORMATION attribute to MAM for a specific partition the VOLUME CHANGE REFERENCE VALUE field of the VOLUME COHERENCY INFORMATION attribute for a partition shall contain the value returned in the ATTRIBUTE VALUE field of the VOLUME CHANGE REFERENCE attribute after the last volume coherency set was written to the volume. The VOLUME COHERENCY COUNT field of the VOLUME COHERENCY INFORMATION attribute shall contain the volume coherency count that was written to the last volume coherency set written to that partition. The VOLUME

COHERENCY SET IDENTIFIER field of the VOLUME COHERENCY INFORMATION attribute for a partition contains the logical object identifier of the first byte of the last volume coherency set written to that partition. The APPLICATION CLIENT SPECIFIC INFORMATION field of the VOLUME COHERENCY INFORMATION attribute for a partition contains information the application client binds with the coherency set referenced by the VOLUME COHERENCY SET IDENTIFIER field.

NOTE 7 - The application client needs to guarantee that no other application client updates the logical objects on the volume between the time it completes writing and the time it updates the MAM parameter (e.g., use reservations)

An application client may verify that the volume coherency set written in a partition has not changed since the VOLUME COHERENCY INFORMATION attribute was written when the application client reads the VOLUME COHERENCY INFORMATION attribute for a partition (e.g., when a volume is mounted) and compares the value in the VOLUME CHANGE REFERENCE VALUE field with the value returned in the ATTRIBUTE VALUE field of the VOLUME CHANGE REFERENCE attribute. If the values match, then the volume coherency set written in that partition is unchanged.

To find the most recently written volume coherency set, the application client searches the VOLUME COHERENCY INFORMATION attributes of the partitions for which the volume coherency set is unchanged and finds the largest value in the VOLUME COHERENCY COUNT field. The application client then verifies the largest value in the VOLUME COHERENCY COUNT field with the volume coherency count stored in the volume coherency set beginning at the logical object specified by the VOLUME COHERENCY SET IDENTIFIER field. If this matches, then this is the volume coherency set that was most recently written.

The APPLICATION CLIENT SPECIFIC INFORMATION field may also be used by the application client as part of this coherency check. If the information verifies for a partition, then the volume is coherent with the last access by this application. If the information does not verify for a partition, then the volume is not coherent with the last access by this application.

## 4.22 Error history (i.e., drive dump)

### 4.22.1 Error history overview

Error history is data collected by a device to aid in troubleshooting errors.

The READ BUFFER command (see 5.2.18) provides a method for retrieving error history from the device (see 4.22.2).

All Ultrium devices support retrieving a drive dump using data mode (i.e., 02h) with buffer ID 01h. This drive dump contains a snapshot of the current debug information (i.e., the contents of the operation tracing at a specific point in time) as well as additional snapshots using development specific algorithms designed to provide the best chance of capturing data to debug problems.

Error history may be retrieved using the method defined in SPC-4 and described in the rest of this clause. Note that there are some areas which differ from the behavior specified in SPC-4.

### 4.22.2 Retrieving error history with the READ BUFFER command

The error history is retrieved using a sequence of READ BUFFER commands on one I\_T\_L nexus.

Tracing of drive operation is returned using error history snapshots. An error history snapshot is the contents of the operation tracing at a specific point in time, created by the device at vendor specific times or requested by the application client using the READ BUFFER command with certain buffer IDs.

The I\_T\_L nexus being used to retrieve an error history snapshot is called the error history I\_T\_L nexus. Only one I\_T\_L nexus is allowed to retrieve an error history snapshot at a time.

To retrieve the complete error history, an application client uses one I\_T\_L nexus to:

- 1) create an error history snapshot if one does not already exist, establish the I\_T\_L nexus as the error history I\_T\_L nexus, and retrieve the drive tracing directory by sending a READ BUFFER command (see 5.2.18) with:
  - A) the MODE field set to 1Ch (i.e., error history);
  - B) the BUFFER ID field set to one of the following:
    - a) If the error history I\_T\_L nexus is expected to be valid:
      - A) 00h (i.e., return error history directory);
      - B) 01h (i.e., return error history directory and create new snapshot);
    - b) if the application client has knowledge that the error history I\_T\_L nexus is no longer valid:
      - A) 02h (i.e., return error history directory and establish new error history I\_T\_L nexus); or
      - B) 03h (i.e., return error history directory, establish new error history I\_T\_L nexus, and create new snapshot);
  - C) the BUFFER OFFSET field set to 000000h; and
  - D) the ALLOCATION LENGTH field set to at least 2 088 (i.e., large enough to transfer the complete error history directory (see 6.7.2.7.1));
- 2) retrieve the error history. The application client uses a Data-In Buffer size that is a multiple of the offset boundary indicated in the READ BUFFER descriptor (see 6.7.1.3). Each buffer ID indicated in the error history directory is a different type of trace or error history. Buffer ID EFh contains a description of each trace (i.e., error history) that is available (see 6.7.2.7.3.6). For each buffer ID indicated in the error history directory in the range of 10h to EFh, the application client may retrieve the trace by sending one or more READ BUFFER commands (see 5.2.18) as follows:
  - 1) send the first READ BUFFER command with:
    - a) the MODE field set to 1Ch (i.e., error history);
    - b) the BUFFER ID field set to the buffer ID (i.e., an error history data buffer);
    - c) the BUFFER OFFSET field set to 000000h; and
    - d) the ALLOCATION LENGTH field set to the size of the Data-In Buffer;
  - 2) until the number of bytes returned by the previous READ BUFFER command does not equal the specified allocation length and/or the total number of bytes returned from the buffer ID equals the maximum available length indicated in the error history directory, send zero or more additional READ BUFFER commands with:
    - a) the MODE field set to 1Ch (i.e., error history);
    - b) the BUFFER ID field set to the buffer ID (i.e., an error history data buffer);
    - c) the BUFFER OFFSET field set to the previous buffer offset plus the previous allocation length; and
    - d) the ALLOCATION LENGTH field set to the size of the Data-In Buffer;

and
- 3) clear the error history I\_T\_L nexus and, depending on the buffer ID, release the error history snapshot by sending a READ BUFFER command with:
  - A) the MODE field set to 1Ch (i.e., error history);
  - B) the BUFFER ID field set to:
    - a) FEh (i.e., clear error history I\_T\_L nexus) (see 6.7.2.7.4); or
    - b) FFh (i.e., clear error history I\_T\_L nexus and release snapshot) (see 6.7.2.7.5);
  - C) the BUFFER OFFSET field set to any value allowed by table 376 (e.g., 000000h); and
  - D) the ALLOCATION LENGTH field set to any value allowed for the chosen BUFFER ID field value (see 6.7.2.7.4 or 6.7.2.7.5) (e.g., 000000h).

While an error history snapshot exists, the device does not modify the error history snapshot to reflect any changes to the error history. This does not include the emergency dump (see 6.7.2.7.3.4) or prioritized flash dumps (see 6.7.2.7.3.5). These dumps are generated internally and may be generated or modified at any time, even while an error history snapshot exists.

The device clears the established error history I\_T\_L nexus and does not release the error history snapshot:

- a) upon processing of a READ BUFFER command on the error history I\_T\_L nexus with:
  - A) the MODE field set to 1Ch (i.e., error history); and
  - B) the BUFFER ID field set to FEh (i.e., clear error history I\_T\_L nexus) (see 6.7.2.7.4);

or
- b) if an I\_T nexus loss occurs on the error history I\_T\_L nexus.

The device clears the established error history I\_T\_L nexus and releases the error history snapshot:

- a) upon processing of a READ BUFFER command using the same I\_T\_L nexus that was used to establish the snapshot with:
  - A) the MODE field set to 1Ch (i.e., error history); and
  - B) the BUFFER ID field set to FFh (i.e., clear error history I\_T\_L nexus and release snapshot) (see 6.7.2.7.5);
- b) if a power on occurs;
- c) if a hard reset occurs; or
- d) if a device reset occurs.

If a new error history snapshot is created by one of the supported methods or by internal algorithms while an error history snapshot exists, the new snapshot overwrites the existing error history snapshot (i.e., MODE [1Ch] 10h: Current error history snapshot (see 6.7.2.7.3.2 on page 436)) or drive dump (i.e., Buffer ID 01h with MODE set to 2h), then an attempt to read an error history at a non-zero offset is rejected with a CHECK CONDITION with the sense key set to ILLEGAL REQUEST and the additional sense code set to ERROR HISTORY SNAPSHOT RELEASED. This notifies the application that the snapshot (i.e., buffer ID) being retrieved has been overwritten.

### 4.23 Potential conflict list (LTO6 and later)

This device may maintain a potential conflict list. A potential conflict list is a list of entries describing I\_T nexuses and commands that have been received, where the operations requested by one I\_T nexus may conflict with the operations requested by a different I\_T nexus (e.g. a rewind requested by one I\_T nexus while a different I\_T nexus is requesting data transfers). The potential conflict list is reported in potential conflict list log parameters (see 6.4.10.1.8).

A potential conflict list command is a command that:

- a) has an entry of Conflict under the Excl Access column of the commands that are allowed in the presence of various reservations table of the command standard in which that command is defined; and
- b) is not one of:
  - A) LOG SELECT;
  - B) PERSISTENT RESERVE IN;
  - C) PERSISTENT RESERVE OUT;
  - D) READ ATTRIBUTE;
  - E) RESERVE UNIT (see SPC-2);
  - F) SECURITY PROTOCOL IN;
  - G) SECURITY PROTOCOL OUT;
  - H) TEST UNIT READY; and
  - I) commands chosen for vendor-specific reasons.

This device maintains an owner\_ITN variable that is the I\_T nexus through which a PCL command was most recently received by the RMC logical unit or the ADC logical unit.

The owner\_ITN is set to NULL, the PCL\_P bit of the extended very high frequency log parameter (see 6.4.10.1.3) is set to zero, the potential conflict list log parameter(s) are destroyed (i.e., no longer exist; the response to a LOG SENSE command does not return the parameter), and the value in the NUMBER OF POTENTIAL CONFLICT LIST ENTRIES field of the potential conflict list entries present log parameter (see 6.4.10.1.7) is set to zero, if:

- a) a Hard Reset occurs; or
- b) a volume is inserted (i.e., the MPRSNT (medium present) bit of the VHF parameter data transitions from 0b to 1b).

The owner\_ITN is set to NULL on a reservation loss or a reservation preempt.

If a PCL command is received through an I\_T nexus that is not the owner\_ITN, the command is not terminated with RESERVATION CONFLICT and:

- a) the owner\_ITN is non-NULL; or

b) the owner\_ITN is NULL, there is no reservation holder, and the addressed LUN is not an ADC LUN, then the DT device shall:

- 1) if that I\_T nexus is not listed in one of the potential conflict list log parameter(s), then:
  - A) if all the potential conflict list log parameters supported by the DT device have been created, then manage the potential conflict list in a vendor specific manner (e.g., stop adding entries to the list or replace an existing entry); or
  - B) create a new potential conflict list entry for this I\_T nexus in the potential conflict list and add the new entry to the list of potential conflict list log parameters in a vendor-specific order (e.g., entries in the potential conflict list log parameters may be reordered) with:
    - a) the TRANSPORTID field set to the TransportID (see SPC-4) of that I\_T nexus;
    - b) the RELATIVE TARGET PORT IDENTIFIER field set to the relative target port (see SPC-4) of that I\_T nexus;
    - c) all other fields set to zero; and
    - d) increment the value in the NUMBER OF POTENTIAL CONFLICT LIST ENTRIES field of the potential conflict list entries present log parameter (see 6.4.10.1.7);
- 2) select the potential conflict list log parameter with the TRANSPORTID field value and RELATIVE TARGET PORT IDENTIFIER field value that match the I\_T nexus through which the PCL command was received and update the fields in that log parameter as follows:
  - A) increment the OWNER ITN COUNT field, if not saturated at its maximum value;
  - B) set the COMMAND OPERATION CODE field to the operation code of the command;
  - C) set the COMMAND SERVICE ACTION field to the service action, if any, of the command; and
  - D) set the OWNER ITN TIME field to the parameter data for a REPORT TIMESTAMP command addressed to the ADC device server;
- 3) set the owner\_ITN to identify the I\_T nexus through which the command was received; and
- 4) set the PCL\_P bit of the extended very high frequency log parameter to one.

## 4.24 Environmental Conditions Thresholding (LTO9 and later)

This device reports current and historical limits of temperature and relative humidity in the Environmental Reporting log page (see 6.4.9). In addition, this device monitors temperature and humidity and takes protective actions such as:

- a) warning the application/library through TapeAlerts;
- b) fencing the drive from any medium access commands; and
- c) ejecting the volume and fencing load commands.

These protective actions are centered around a set of thresholds with built in hysteresis. When a threshold is met, the drive performs the indicated action. When the environmental condition (i.e., temperature or humidity) changes such that the threshold is no longer met, there is hysteresis built in prior to the resetting of that threshold. This hysteresis is designed to provide a stable return to operation and may be substantially different than the value of the threshold. These thresholds and reset points are managed by the drive.

Figure 8 shows an example of how the thresholds are set. This is only an example to describe the concept and not intended to show the relative difference in values of the various thresholds. This example describes the progression through the various thresholds.

- 1) The Normal Operation Condition range of temperature is where the drive is designed to operate. The drive operates normally in this range;
- 2) When the temperature rises towards an unsafe value, the *TapeAlert Asserted* threshold is crossed and the Drive Temperature TapeAlert (i.e., 0024h) trigger is activated. The drive asserts the Drive Temperature TapeAlert;
- 3) As the temperature continues to rise it passes through the *Fence Commands* threshold. When this occurs, the *Fence Commands* trigger is activated and the drive disallows commands determined to be unsafe in this condition (e.g., disallows medium access commands). These commands are rejected with

- a CHECK CONDITION with the sense key set to ABORTED COMMAND and the additional sense code set to WARNING - SPECIFIED TEMPERATURE EXCEEDED (i.e., B/0B01h);
- 4) As the temperature continues to rise, it passes through the *Eject Volume* threshold. When this occurs, the *Eject Volume* trigger is activated and the drive ejects the volume. An attempt to load the volume is rejected with a CHECK CONDITION with the sense key set to NOT READY and the additional sense code set to WARNING - SPECIFIED TEMPERATURE EXCEEDED (i.e., 2/0B01h);
  - 5) If the temperature decreases, it eventually passes through the temperatures of each of the reset thresholds and each of the threshold triggers are reset.

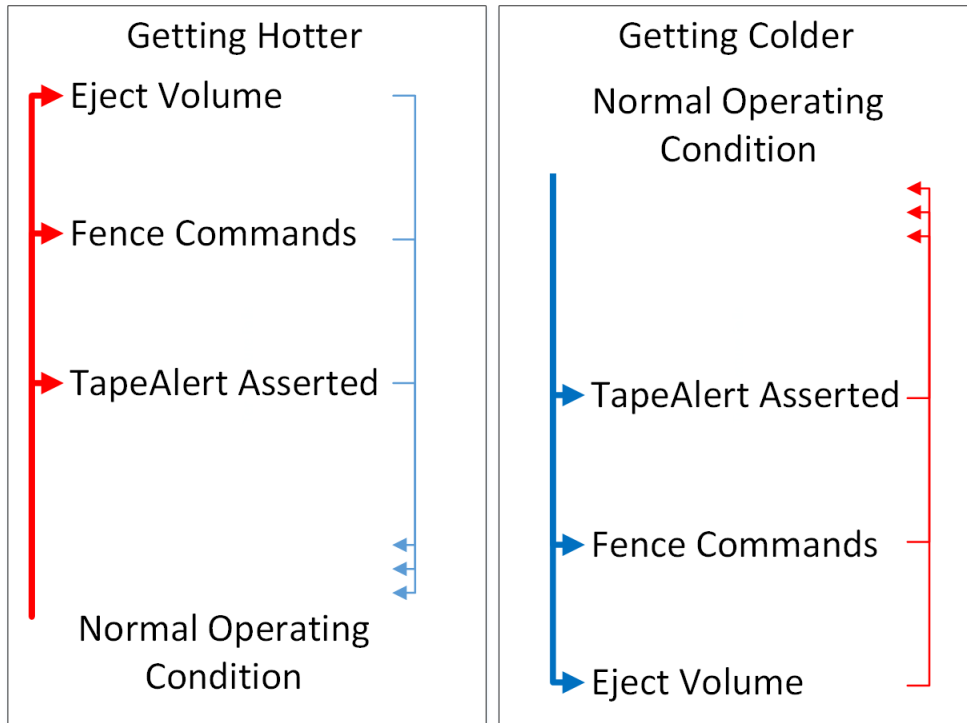

Figure 8 — Example of temperature thresholds





## 5. SCSI Commands

### 5.1 SCSI Commands Overview

This chapter describes the SCSI commands supported (LUN 0).

The following SCSI command descriptions have a table describing the fields in the Command Descriptor Block (CDB), similar to the style used in the *American National Standard of the National Committee for Information Technology Standards (NCITS)* documents.

Any data required by each command follow these descriptions and are described in a “term-definition” format. In this format, the bits or bytes to be described are highlighted and listed on the left. The definition for the bits or bytes is to the right (not highlighted).

Parameters are described in [Parameters for SCSI Commands](#) (see 6. on page 185).

#### 5.1.1 Unsupported SCSI Commands

Certain commands or features of some commands defined in SPC-4 or SSC are not currently supported but may be in the future.

The LUN field in the CDB has been obsoleted in SCSI-3 and has been repurposed for some commands. These bits are ignored in some commands, but examined in others which have repurposed these bits.

The *Read Buffer* and *Write Buffer* commands are supported but not all buffers are described in this document because many buffers are intended only to be read or written by the Service Representative or by Manufacturing. OEM customers who intend to support host microcode download on a new platform should contact IBM for a complete description of the *Write Buffer* command for this purpose. Note that new microcode may also be loaded without requiring the use of the SCSI *Write Buffer* command, by using other methods described in the maintenance information manual for this product.

#### 5.1.2 Supported SCSI Commands

This device accepts commands on LUN 0 for drive related commands (i.e., Peripheral Device Type returned in Standard Inquiry is Sequential Access Device). When in a library this device may also accept commands on LUN 1 for library related commands (i.e., Peripheral Device Type returned in Standard Inquiry is Medium Changer Device).

##### 5.1.2.1 Supported SCSI Commands on LUN 1

The list of commands supported on LUN 1 is dependant on the library in which the drive is contained. To determine the model of the library in which the drive is contained, use the INQUIRY command. Bytes 8-15 contain the T10 VENDOR IDENTIFICATION. Bytes 16 - 31 contain the PRODUCT IDENTIFICATION.

This document contains no additional information about commands supported on LUN 1. For a list of all commands supported please see the appropriate Library SCSI Reference.

##### 5.1.2.2 Supported SCSI Commands on LUN 0

Table 31 provides a list of all commands supported by this product for the sequential access device (i.e., LUN 0). For each command, the operation code, reference page for this specification, and applicability of certain conditions to the command are shown in [Table 31](#).

It is strongly recommended that device drivers or host software implement device reservations using the RESERVE/RELEASE commands or the PERSISTENT RESERVE OUT/PERSISTENT RESERVE IN commands. It is also strongly recommended that host software use the Append-only mode (also known as Data-safe mode) (see [4.2.3 on page 26](#)) as it helps cover the cases where reservations are lost or the drive reboots unexpectedly.

Table 31 — Supported Common SCSI Commands (part 1 of 2)

Command Name	Operation Code	Page	Applicable Conditions <sup>b</sup>							
			RVC	UAT	NRD	WRP	MFC	RPM	DCC	DEA
ALLOW OVERWRITE	82h	79	Y	Y	Y	-	-	Y	-	-
ERASE	19h	80	Y	Y	Y	Y	Y	Y	Y	Y
FORMAT MEDIUM	04h	80	Y	Y	Y	Y	Y	Y	Y	Y
GENERATE RECOMMENDED ACCESS ORDER (GRAO)	A4h[001Dh]	82	Y	Y	Y	-	Y	-	Y	N
INQUIRY	12h	84	-	-	-	-	-	-	-	-
LOAD/UNLOAD	1Bh	90	Y	Y	-	-	Y	Y	Y	Y
LOCATE (10/16)	2Bh/92h	92	Y	Y	Y	-	Y	Y	Y	Y
LOG SELECT	4Ch	94	Y	Y	-	-	-	-	-	-
LOG SENSE	4Dh	94	-	-	-	-	-	Y <sup>e</sup>	-	-
MODE SELECT (6/10)	15h/55h	95	Y	Y	-	-	-	Y	-	-
MODE SENSE (6/10)	1Ah/5Ah	96	-	Y	-	-	-	-	-	-
PERSISTENT RESERVE IN	5Eh	98	Y	Y	-	-	-	-	-	-
PERSISTENT RESERVE OUT	5Fh	104	Y <sup>c</sup>	Y	-	-	-	-	-	-
PREVENT ALLOW MEDIUM REMOVAL	1Eh	106	-	Y	-	-	-	-	-	-
READ	08h	107	Y	Y	Y	-	Y	Y	Y	Y
READ ATTRIBUTE	8Ch	108	Y	Y	-	-	-	- <sup>f</sup>	Y	-
READ BLOCK LIMITS	05h	112	-	Y	-	-	-	-	-	-
READ BUFFER	3Ch	113	Y	-	-	-	-	-	-	-
READ DYNAMIC RUNTIME ATTRIBUTE	A3h[1Eh] or D1h	114	-	-	-	-	-	-	-	-
READ END OF WRAP POSITION	A3h[1Fh][45h]	119	-	-	Y	-	-	-	-	-
READ LOGGED-IN HOST TABLE	A3h[1Fh][01h]	122	-	-	-	-	-	-	-	-
READ POSITION	34h	125	Y	Y	Y	-	-	Y	-	-
RECEIVE DIAGNOSTIC RESULTS	1Ch	131	Y	Y	-	-	-	-	-	-
RECEIVE RECOMMENDED ACCESS ORDER (RRAO)	A3h[001Dh]	131	Y	Y	Y	-	Y	-	Y	N
RELEASE UNIT (6/10) <sup>a</sup>	17h/57h	137	- <sup>d</sup>	Y	-	-	-	-	-	-
REPORT DENSITY SUPPORT	44h	138	-	Y	-	-	-	-	-	-
REPORT LUNs	A0h	142	-	-	-	-	-	-	-	-
REPORT SUPPORTED OPERATION CODE	A3h[0Ch]	143	-	Y	-	-	-	-	-	-
REPORT SUPPORTED TASK MANAGEMENT FUNCTIONS	A3h[0Dh]	158	-	Y	-	-	-	-	-	-
REPORT TIMESTAMP	A3h[0Fh]	160	-	Y	-	-	-	-	-	-
REQUEST SENSE	03h	161	-	-	-	-	-	-	-	-
RESERVE UNIT (6/10) <sup>a</sup>	16h/56h	168	Y <sup>d</sup>	Y	-	-	-	-	-	-
REWIND	01h	169	Y	Y	Y	-	Y	Y	Y	Y
SECURITY PROTOCOL IN (SPIN)	A2h	169	Y	Y	-	-	-	-	-	-

Table 31 — Supported Common SCSI Commands (part 2 of 2)

Command Name	Operation Code	Page	Applicable Conditions <sup>b</sup>							
			RVC	UAT	NRD	WRP	MFC	RPM	DCC	DEA
SECURITY PROTOCOL OUT (SPOUT)	B5h	170	Y	Y	-	-	Y	-	-	-
SEND DIAGNOSTIC	1Dh	171	Y	Y	-	-	Y	Y <sup>g</sup>	-	-
SET CAPACITY	0Bh	172	Y	Y	Y	Y	Y	Y	Y	Y
SET TIMESTAMP	A4h[0Fh]	173	Y	Y	-	-	-	-	Y	-
SPACE (6/16)	11h/91h	175	Y	Y	Y	-	Y	Y	Y	Y
TEST UNIT READY	00h	176	Y	Y	Y	-	-	-	Y	-
VERIFY	13h	176	Y	Y	Y	-	Y	Y	Y	Y
WRITE	0Ah	178	Y	Y	Y	Y	Y	Y	Y	Y
WRITE DYNAMIC RUNTIME ATTRIBUTE	A4h[1Eh] or D2h	182	-	-	-	-	-	-	-	-
WRITE ATTRIBUTE	8Dh	178	Y	Y	-	Y	-	-	Y	-
WRITE BUFFER	3Bh	181	Y	Y	-	-	-	- <sup>h</sup>	-	-
WRITE FILEMARKS (6)	10h	184	Y	Y	Y	Y	Y	Y	Y	Y

Note 1 - The behavior for all commands is as defined in the following SCSI-3 specifications unless otherwise indicated:

- SSC-4 (*SCSI Stream Commands - 4*)
- SPC-4 (*SCSI Primary Commands-4*)
- <sup>a</sup> The RESERVE/RELEASE commands are defined in SPC-2 (*SCSI Primary Commands-2*)
- <sup>b</sup> Applicable Conditions are as follows:
  - Y = condition applies to the command
  - = condition does not apply to the command
  - RVC = reservation conflict
  - UAT = unit attention
  - NRD = not ready
  - WRP = write protect. These are also referred to as “write-type” commands.
  - MFC = medium format corrupted. These commands are also considered Medium Access Commands
  - RPM = resets power management timer (i.e., idle\_c timer restarts countdown to enter power management). These do not necessarily take the drive out of power management. Only those commands that cause media movement take the drive out of power management.
  - DCC = deferred check condition
  - DEA = deferred error (DCC) affinity (see 4.19.3)
- <sup>c</sup> Reported as appropriate for the type of Service Action and Reservation Type requested and the current reservation state of the drive.
- <sup>d</sup> The drive sets the CRH bit to one in the parameter data returned by the REPORT CAPABILITIES service action of the PERSISTENT RESERVE IN command. This indicates that in the presence of a Persistent Reservation, a RELEASE(6) or RELEASE(10) command will complete with GOOD status, but the persistent reservation will not be released, if the command is received from:
  - a) An I\_T nexus that is a persistent reservation holder; or
  - b) An I\_T nexus that is registered if a registrants only type persistent reservation is present.
 In all other cases, the RELEASE(6)/RELEASE(10) command is rejected with a RESERVATION CONFLICT. The drive sets the CRH bit to one in the parameter data returned by the REPORT CAPABILITIES service action of the PERSISTENT RESERVE IN command. This indicates that in the presence of a Persistent Reservation, A RESERVE(6) or RESERVE(10) command will complete with GOOD status, but no reservation is established and the persistent reservation will not be changed, if the command is received from:
  - a) An I\_T nexus that is a persistent reservation holder; or
  - b) An I\_T nexus that is registered if a registrants only type persistent reservation is present.
 In all other cases, the RESERVE(6)/RESERVE(10) command is rejected with a RESERVATION CONFLICT.
- <sup>e</sup> idle\_c timer is reset by all log pages except log pages 00h, 0Ch, 0Dh[01h], 11h, 12h, 2Eh, 3Eh[00h] (a.k.a. LP 3Eh).
- <sup>f</sup> idle\_c timer is reset by SERVICE ACTION 00h with FIRST ATTRIBUTE IDENTIFIER of 0009h.
- <sup>g</sup> idle\_c timer is reset by all diagnostics except by CDB=’1D0000000000’h or DIAGNOSTIC IDs 0160h , 0163h, 0210h, 1002h, and 2003h (see 6.2.2).
- <sup>h</sup> Idle\_c timer is reset by the download code methods (see 5.2.44)

### 5.1.2.3 Control Byte Definition

This description of the control byte fields is to be used for all of the supported commands. The control byte occurs in the last byte of a command, that is, byte 5 (6-byte commands), byte 9 (10-byte commands), byte 11 (12-byte commands), or byte 15 (16-byte commands). Table 32 shows the bit significance of the control byte.

**Table 32 — Control Byte Definition**

Byte	Bit							
	7	6	5	4	3	2	1	0
5, 9, or 11	Vendor specific		Reserved			NACA	Obsolete	Obsolete

Bit	Description
7-6	Vendor specific: 00b
5-3	Reserved: 000b
2	NACA (Normal ACA): 0b
1	Obsolete: 0b
0	Obsolere: 0b

## 5.2 SCSI Commands Listing

### 5.2.1 ALLOW OVERWRITE - 82h

When append-only mode is enabled an application client may issue the ALLOW OVERWRITE command to enable the overwrite of the medium at a non-append point. The processing of the ALLOW OVERWRITE command sets the `allow_overwrite` and `allow_overwrite_position` variables as specified in Append-only mode (also known as Data-safe mode) (see 4.2.3 on page 26).

**Table 33 — ALLOW OVERWRITE CDB**

Byte	Bit							
	7 msb	6	5	4	3	2	1	0 lsb
0	OPERATION CODE (82h)							
1	Reserved							
2	Reserved				ALLOW OVERWRITE			
3	PARTITION							
4	(MSB)	LOGICAL OBJECT IDENTIFIER						(LSB)
11								
12	Reserved							
14								
15	Control Byte (see 5.1.2.3)							

The ALLOW OVERWRITE field specifies what type of overwrite is allowed. Table 34 defines the actions for the value specified in the ALLOW OVERWRITE field.

**Table 34 — ALLOW OVERWRITE field definition**

Value	Definition
0h	The <code>allow_overwrite</code> variable shall be set to Disabled
1h	The <code>allow_overwrite</code> variable shall be set to Current Position
2h	The <code>allow_overwrite</code> variable shall be set to Format
3h-Fh	The command shall be rejected with CHECK CONDITION status with the sense key set to ILLEGAL REQUEST and the additional sense code set to INVALID FIELD IN CDB.

If the ALLOW OVERWRITE field is set to Current Position (i.e., 1h), then:

- a) the PARTITION field shall be set to the active partition; and
- b) the LOGICAL OBJECT IDENTIFIER field shall be set to the current position.

If the ALLOW OVERWRITE field is set to Current Position (i.e., 1h), then the `allow_overwrite_position` variable shall be set to the current position.

If the ALLOW OVERWRITE field is not set to Current Position (i.e., 1h), then the PARTITION field and LOGICAL OBJECT IDENTIFIER field shall be ignored.

The device server shall terminate the command with CHECK CONDITION status with the sense key set to ILLEGAL REQUEST and the additional sense code set to SEQUENTIAL POSITIONING ERROR if:

- a) the ALLOW OVERWRITE field is set to Current Position (i.e., 1h); and
- b) the logical position of the medium is not at the location specified by the PARTITION field and LOGICAL OBJECT IDENTIFIER field.

If the device server terminates that command with any status other than GOOD, then the `allow_overwrite` variable shall be set to Disabled and the `allow_overwrite_position` variable shall be set to invalid.

## 5.2.2 ERASE - 19h

Table 35 — ERASE CDB

Byte	Bit							
	7	6	5	4	3	2	1	0
0	OPERATION CODE (19h)							
1	Reserved						IMMED	LONG
2	Reserved		METHOD		Reserved		SMD	VCM
3	Reserved							
4	Reserved							
5	Control Byte (see 5.1.2.3)							

EOD is written at the current position, which marks it as end of data. After the command is successfully completed, the drive is positioned immediately before End Of Data (not End Of Tape).

The following parameters apply:

- LONG:

Value	Description
-------	-------------

0b	No further writing occurs after EOD is written.
----	---

1b	The Data Set Separator (DSS) pattern is written from the new EOD to the end of the current partition to overwrite any data that is currently on the tape after the current logical position.
----	--

==== **WARNING** ===== **WARNING** :

A long erase of a partitioned volume from BOP does not erase all data on the volume. It erases all data on the current partition but does not affect other partitions. To erase all logical objects on the volume, issue a FORMAT MEDIUM command with the FORMAT field set to 0h then issue a long erase when positioned at BOP.

==== **WARNING** ===== **WARNING** :

- IMMED (Immediate):

Value	Description
-------	-------------

0b	Status is not returned until after the command has completed.
----	---

1b	The device validates the command and waits for any previous command from any server to complete, including any immediate commands that are currently being processed. It also waits for any buffered data to be flushed to tape. It then reports a DEFERRED ERROR for any preceding command or buffered data, if any. If there is no deferred error, the drive reports GOOD status and initiates processing the command.
----	--

- VCM (vendor-specific control metadata): 0b

- SMD (security metadata): 0b

- METHOD: If LONG is set to 1b, specifies the method used to erase data. If LONG is set to 0b, the METHOD field is not supported.

Value	Description
-------	-------------

00b	Same as 01b
-----	-------------

01b	The Data Set Separator (DSS) pattern is written from the new EOD to the end of the current partition to overwrite any data that is currently on the tape after the current logical position.
-----	--

## 5.2.3 FORMAT MEDIUM - 04h

The FORMAT MEDIUM command (see table 36) is used to prepare the medium for use by the logical unit. If there are unwritten logical objects in the buffer when processing of a FORMAT MEDIUM command begins, or if the medium is not at beginning-of-partition 0 (BOP 0), then the command is rejected with CHECK CONDITION

status with the sense key set to ILLEGAL REQUEST and the additional sense code set to POSITION PAST BEGINNING OF MEDIUM.

The FORMAT MEDIUM command shall function in the constraints dictated by any capacity changes resulting from a previous SET CAPACITY command that was performed on the mounted volume (i.e., The Set Capacity command controls the maximum capacity allowed for the volume and the Format Medium command works inside those constraints).

The FORMAT MEDIUM command is not allowed against a WORM cartridge. If a WORM cartridge is loaded when the FORMAT MEDIUM command is received, then the command is rejected with CHECK CONDITION status. The sense key shall be set to DATA PROTECT and the additional sense code shall be set to WORM MEDIUM - OVERWRITE ATTEMPTED.

**Table 36 — FORMAT MEDIUM CDB**

Byte	Bit							
	7	6	5	4	3	2	1	0
0	OPERATION CODE (04h)							
1	Reserved						VERIFY	IMMED
2	Reserved				FORMAT			
3	(MSB) _____							
4	TRANSFER LENGTH _____							
5	(LSB)							
5	Control Byte (see 5.1.2.3)							

At the successful completion of a FORMAT MEDIUM command, the medium shall be positioned at BOP 0.

During the format operation, in response to a REQUEST SENSE command, assuming no error has occurred, the device server returns a sense key and additional sense code of NOT READY, LOGICAL UNIT NOT READY, FORMAT IN PROGRESS (2/0404), with the sense key specific bytes set for process indication.

An immediate (IMMED) bit of zero specifies the device server shall not return status until the FORMAT MEDIUM command has completed. An IMMED bit of one specifies the device server shall return status as soon as the valid medium location has been verified and the command descriptor block of the FORMAT MEDIUM command has been validated. If CHECK CONDITION status is returned for a FORMAT MEDIUM command with an IMMED bit of one, the format operation shall not be performed.

The VERIFY bit shall be set to zero. The drive does not perform any verification of the format.

The FORMAT field is specified in table 37.

**Table 37 — FORMAT MEDIUM FORMAT field**

Code	Description	Cartridge Support	Optimization <sup>a</sup>
0h	Use default format	Ultrium 4 and later Data cartridge	L9/LZ
1h	Partition medium	Ultrium 5 and later Data cartridge	-
2h	Default format then partition	Ultrium 5 and later Data cartridge	L9/LZ
Key:			
-	Not Supported		
L9	Generation 9 DATA cartridge	LZ	Generation 9 WORM cartridge
<sup>a</sup>	A Volume Optimization is performed (see 4.1)		

If the FORMAT field is 0h, the logical unit shall format the volume to a single partition. A valid FORMAT MEDIUM command with 0h in the FORMAT field shall cause all data on the entire physical volume to be lost.

If the FORMAT field is 1h, the logical unit shall partition the medium using the current mode data from the Medium Partition mode page (see 6.6.13). If none of the mode bits SDP, FDP, or IDP are set to one, the device server shall return CHECK CONDITION. The sense key shall be set to ILLEGAL REQUEST with the addition sense code set to PARAMETER VALUE INVALID. If insufficient space exists on the medium for the requested partition sizes, the

device server shall return CHECK CONDITION status. The sense key shall be set to MEDIUM ERROR and the additional sense code shall be set to VOLUME OVERFLOW. A valid FORMAT MEDIUM command with 1h in the FORMAT field causes all data on the entire physical volume to be lost.

If the FORMAT field is 2h, the logical unit shall perform the operations equivalent to a FORMAT field of 0h followed by a FORMAT field of 1h. A valid FORMAT MEDIUM command with 2h in the FORMAT field causes all data on the entire physical volume to be lost.

When the FORMAT field contains 1h or 2h, some errors related to mode page field contents may not be detected until the FORMAT MEDIUM command is processed. Therefore, some error conditions described in MP 11h: Medium Partition Page (see 6.6.13 on page 380) may be returned in response to a FORMAT MEDIUM command with 1h or 2h in the FORMAT field.

The TRANSFER LENGTH shall be zero.

#### 5.2.4 GENERATE RECOMMENDED ACCESS ORDER (GRAO) - A4h[1Dh] (LTO9+)

The GENERATE RECOMMENDED ACCESS ORDER (GRAO) command is used by an application client to request the device server generate a recommended access order for the User Data Segments that are sent in this command.

After a GRAO command completes, use the RECEIVE RECOMMENDED ACCESS ORDER (RRAO) command (see 5.2.24) to receive the results in the form of an RAO list. When a GRAO command is received and the device server begins validation of the fields in the CDB the previous RAO list is cleared. If the GRAO command is rejected for ILLEGAL REQUEST or any error other than RESERVATION CONFLICT, Deferred Error, or Unit Attention, then the previous results are invalidated.

**Table 38 — GENERATE RECOMMENDED ACCESS ORDER CDB**

Byte	Bit							
	7 msb	6	5	4	3	2	1	0 lsb
0	OPERATION CODE (A4h)							
1	Reserved			SERVICE ACTION (1Dh)				
2	Reserved				PROCESS			
3	Reserved				UDS_TYPE			
4	Reserved							
5	Reserved							
6	MSB							
...	PARAMETER LIST LENGTH							
9	LSB							
10	Reserved							
11	Control Byte							

The following parameters apply:

- PROCESS - Requested process to generate the contents of the RAO list (see 4.6.3.3).
- UDS\_TYPE - Type of User Data Segment descriptor to generate (see 4.6.4)

Value	Description
000b	User Data Segment without geometry
001b	User Data Segment with geometry
010b-111b	Reserved

- PARAMETER LIST LENGTH: This field specifies the length in bytes of the parameter list that is transferred from the initiator to the target. A parameter list length value of zero indicates that no data is transferred and that the RAO list is to be cleared. This condition is not considered an error. If the specified parameter list length results in truncation of one or more User Data Segments, the drive returns CHECK CONDITION status



with associated sense data of 5/2400 (ILLEGAL REQUEST, INVALID FIELD IN CDB). If the parameter length is eight (i.e., no descriptors are transferred), then the RAO list is cleared. This is not considered an error. If the parameter length is less than eight, then the drive returns CHECK CONDITION status with associated sense data of 5/2400 (ILLEGAL REQUEST, INVALID FIELD IN CDB)

#### 5.2.4.1 GRAO Parameter Data

The parameter data sent with the GENERATE RECOMMENDED ACCESS ORDER command is defined in table 39.

**Table 39 — GRAO Parameter List**

Byte	Bit							
	7 msb	6	5	4	3	2	1	0 lsb
0	Reserved							
...								
3								
4	(MSB)	ADDITIONAL DATA (n-7)						(LSB)
...								
7								
User Data Segment descriptors								
x	User Data Segment descriptor (first)							
⋮								
y	User Data Segment descriptor (last)							
n								

The following parameters apply:

- ADDITIONAL DATA - This field specifies the amount of data to follow.
- User Data Segment descriptors - A list of User Data Segments for the drive to recommend an access order. The User Data Segment descriptor is defined in 5.2.4.1.1. A CHECK CONDITION with the SENSE KEY set to ILLEGAL REQUEST and the ADDITIONAL SENSE CODE set to INVALID FIELD IN PARAMETER LIST is returned and any previous recommended access order list is invalidated if:
  - A) the number of User Data Segment descriptors sent is larger than the maximum number supported;
  - B) a User Data Segment specified by one of the descriptors does not exist (i.e., the BEGINNING LOGICAL OBJECT LOCATION - PARTITION NUMBER combination does not exist or the ENDING LOGICAL OBJECT LOCATION - PARTITION NUMBER does not exist); OR
  - C) a User Data Segment specified by one of the descriptors is malformed (e.g., THE ENDING LOGICAL OBJECT LOCATION is located at a smaller location than the BEGINNING LOGICAL OBJECT LOCATION).

### 5.2.4.1.1 GRAO User Data Segment descriptor

The User Data Segment descriptor to be sent is defined in table 40.

**Table 40 — GRAO - User Data Segment descriptor**

Byte	Bit							
	7 msb	6	5	4	3	2	1	0 lsb
0	(MSB) _____							
1	DESCRIPTOR LENGTH (1Eh)							(LSB)
2	Reserved							
3	Reserved							
4	Reserved							
5	_____							
...	UDS NAME							
14	_____							
15	PARTITION NUMBER							
16	(MSB) _____							
...	BEGINNING LOGICAL OBJECT IDENTIFIER							
23	(LSB)							
24	(MSB) _____							
...	ENDING LOGICAL OBJECT IDENTIFIER							
31	(LSB)							

The following parameters apply:

#### Byte Description

- 0-1     DESCRIPTOR LENGTH - length of data to follow.
- 2-4     Reserved
- 5-14    UDS NAME - Identifier given to this User Data Segment by the application for the applications use. Not used by the drive.
- 15     PARTITION NUMBER - Number of the partition in which this User Data Segment is located.
- 16-23   BEGINNING LOGICAL OBJECT IDENTIFIER - Logical object identifier of the beginning logical object of the User Data Segment.
- 24-31   ENDING LOGICAL OBJECT IDENTIFIER - Logical object identifier of the ending logical object of the User Data Segment.

### 5.2.5 INQUIRY - 12h

The INQUIRY command instructs the drive to return data about itself to the initiator.

**Table 41 — INQUIRY CDB**

Byte	Bit							
	7 msb	6	5	4	3	2	1	0 lsb
0	OPERATION CODE (12h)							
1	Obsolete (LUN)			Reserved				EVPD
2	PAGE CODE							

Table 41 — INQUIRY CDB

Byte	Bit							
	7 msb	6	5	4	3	2	1	0 lsb
3	(MSB)							
4	ALLOCATION LENGTH							(LSB)
5	Control Byte (see 5.1.2.3)							

The following parameters apply:

- EVPD (Enable Vital Product Data)

Value	Description
-------	-------------

0b	Standard Inquiry Data is returned (see 5.2.5.1)
----	---

1b	Vital Product Data is returned according to the value in the PAGE CODE field.
----	---

- PAGE CODE: Valid if the EVPD bit is set to one. If the EVPD bit is not set to one and this field has a non-zero value, the command is rejected.

Value	Description
-------	-------------

00h	The Supported Vital Product Data Pages page is returned (see 6.3.1). This page lists the VPD pages that are supported by the drive in this configuration.
-----	---

non-zero	The VPD page with the specified PAGE CODE is requested. The VPD pages are described in 6.3 Inquiry Vital Product Data Parameters (IP).
----------	--

- ALLOCATION LENGTH: LTO5 supports sizes up 00FFh. LTO6 and later support larger sizes.

### 5.2.5.1 Standard Inquiry Data

In drives that are not configured with the eServer™ attachment feature, Standard Inquiry Data for a valid LUN is described in table 42.

Table 42 — Standard INQUIRY data valid LUN format (part 1 of 2)

Bit Byte	7	6	5	4	3	2	1	0
0	PERIPHERAL QUALIFIER			PERIPHERAL DEVICE TYPE				
1	RMB	Reserved						
2	VERSION (06h)							
3	Obsolete	Obsolete	NACA (0b)	HiSUP <sup>a</sup> (1b)	RESPONSE DATA FORMAT (2h)			
4	ADDITIONAL LENGTH (n-4)							
5	SCCS (0)	ACC (0)	TPGS (00b)		3PC (0)	Reserved		PROTECT
6	Obsolete	ENCSRV (0)	VS(0)	MULTIP	Obsolete	Obsolete	Obsolete	ADDR16(0)
7	Obsolete	Obsolete	WBUS16(0)	SYNC(0)	Obsolete	Obsolete	CmdQue	VS(0)
8	(MSB)							
15	T10 VENDOR IDENTIFICATION ("IBM ")							(LSB)
16	(MSB)							
31	PRODUCT IDENTIFICATION							(LSB)
32	(MSB)							
35	PRODUCT REVISION LEVEL (YMDV)							(LSB)
36	Reserved							AutDis
37	Obsolete							
38	PROTOCOL IDENTIFIER				MAXIMUM SPEED SUPPORTED			

<sup>a</sup> LTO-7 and later products. Earlier products report 0b.

Table 42 — Standard INQUIRY data valid LUN format (part 2 of 2)

Bit Byte	7	6	5	4	3	2	1	0	
39	Restricted	Reserved					FIPS		
40	Reserved								
41	OEM Specific								
42	OEM Specific Subfield								
43	Reserved								
47	Reserved								
48	IBM DRIVE PART NUMBER (8 ASCII characters) [The first 7 bytes of this field match the								
55	7-character drive P/N printed on the rear drive label]								
56	Reserved				CLOCKING(0)		QAS(0)	IUS(0)	
57	Reserved								
58	(MSB)	SAM-5 T10/2104-D revision 4 (00A2h)						(LSB)	
59									
60	(MSB)	if SAS drive, then SAS-2r16 (0C28h)						(LSB)	
61	if Fibre Channel drive, then FCP-4 T10/1828-D revision 02b (0A45h)								
62	(MSB)	SPC-4, no revision claimed (0460h)						(LSB)	
63									
64	(MSB)	SSC-4 (no version claimed) (0520h)						(LSB)	
65									
66	(MSB)	ADT-2 T10/1742-D revision 09 (0A28h)						(LSB)	
67									
68	(MSB)	ADC-3 T10/1895-D revision 04 (0502h)						(LSB)	
69									
<sup>a</sup> LTO-7 and later products. Earlier products report 0b.									

In drives configured with the eServer attachment feature, the Standard Inquiry Data for a valid LUN is defined in table 43.

**Table 43 — eServer attachment Standard Inquiry Data Valid LUN**

Byte	Bit							
	7	6	5	4	3	2	1	0
0	PERIPHERAL QUALIFIER			PERIPHERAL DEVICE TYPE				
1	RMB	Reserved						
2	ISO VERSION (00b)		ECMA VERSION (000b)			VERSION (3h)		
3	AERC(0b)	Obsolete	NACA(0b)	HISUP <sup>a</sup> (0b)	RESPONSE DATA FORMAT (2h)			
4	ADDITIONAL LENGTH							
5	SCCS (0)	ACC (0)	TPGS (00b)		3PC (0)	Reserved		PROTECT
6	Obsolete	ENCSR(0)	VS(0)	MULTIP	Obsolete			ADR16
7	Obsolete		WBS16	SYNC	Obsolete		CMDQ	VS(0)
8	VENDOR IDENTIFICATION (in left-aligned ASCII)							
15	"IBM"							
16	PRODUCT IDENTIFICATION (in left-aligned ASCII)							
31								
32	PRODUCT REVISION LEVEL (in left-aligned ASCII): YMDV							
35								
36	UNIT SERIAL NUMBER (8 ASCII characters)							
43	["20ssssss" = last 6 characters of the 11S identifier]							
44								
47	LOAD ID							
48	IBM DRIVE PART NUMBER (8 ASCII characters) [The first 7 bytes of this field							
55	match the 7-character drive P/N printed on the rear drive label]							
56	Reserved			CLOCKING (00b)		QAS (0b)	IUS (0b)	
57								
95	Reserved							
96								
97	Reserved							
98								
101	PLANT ID (4 ASCII characters) ("N100")							
102								
112	Reserved							
113	Reserved							LIBR(0)
114								
125	DRIVE FRU PART NUMBER (12 ASCII characters)							
126	IBM EC LEVEL (10 ASCII characters) [The first 6 bytes of this field match the							
135	EC level printed on the rear drive label]							
<sup>a</sup> LTO-7 and later products report 1b								

For Valid LUN:

- a) PERIPHERAL QUALIFIER is set to 000b.

- b) PERIPHERAL DEVICE TYPE is set to 01h.
- c) RMB is set to 1b to indicate that the medium is removable.

For Invalid LUN:

- a) PERIPHERAL QUALIFIER is set to 011b.
- b) PERIPHERAL DEVICE TYPE is set to 1Fh.
- c) RMB is set to 0b to indicate that the medium is not removable.

For all devices:

- a) The ADDITIONAL LENGTH field specifies how many bytes follow. This value is subject to change. It is strongly recommended that the user parse the data returned by using the ADDITIONAL LENGTH field.
- b) PROTECT: (see Logical block protection (see 4.9 on page 43))
- c) MULTIP bit is set to 1. Two primary ports exist but may not both be populated with transceivers.
- d) ADR16 field is set to 0.
- e) WBS16 field is set to 0.
- f) SYNC field is set to 0.
- g) CMDQ field is set to 1, which indicates that the drive supports tagged (simple) command queuing.
- h) CLOCKING field is set to 0.
- i) QAS field is set to 0, which indicates that the drive does not support quick arbitration and selection.
- j) IUS field is set to 0, which indicates that the drive does not support information unit transfers.
- k) VENDOR IDENTIFICATION returns IBM in ASCII with trailing blanks.
- l) PRODUCT VENDOR IDENTIFICATION returns ULTxxxx-zzy in ASCII with trailing blanks. For IBM drives, xxxx equals 3580; for OEM drives, xxxx equals RIUM. For full-height drives, zz equals TD; for half-height drives zz equals HH. The character y indicates the generation of the drive. See table 44 for the value returned.

**Table 44 — Standard Inquiry Product Identification Table**

Generation <sup>c</sup>	IBM Drive <sup>a</sup>	OEM Drive <sup>a</sup>	eServer Attachment enabled <sup>b</sup>
1	ULT3580-TD1	ULTRIUM-TD1	N/A
2	ULT3580-TD2	ULTRIUM-TD2	N/A
2 Half-Height	ULT3580-HH2	ULTRIUM-HH2	N/A
3	ULT3580-TD3	ULTRIUM-TD3	N/A
3 Half-Height	ULT3580-HH3	ULTRIUM-HH3	HH LTO Gen 3
4	ULT3580-TD4	ULTRIUM-TD4	N/A
4 Half-Height	ULT3580-HH4	ULTRIUM-HH4	HH LTO Gen 4
5	ULT3580-TD5	ULTRIUM-TD5	N/A
5 Half-Height	ULT3580-HH5	ULTRIUM-HH5	HH LTO Gen 5
6	ULT3580-TD6	ULTRIUM-TD6	-
6 Half-Height	ULT3580-HH6	ULTRIUM-HH6	HH LTO Gen 6
7	ULT3580-TD7	ULTRIUM-TD7	-
7 Half-Height	ULT3580-HH7	ULTRIUM-HH7	HH LTO Gen 7
8	ULT3580-TD8	ULTRIUM-TD8	-
8 Half-Height	ULT3580-HH8	ULTRIUM-HH8	HH LTO Gen 8
9	ULT3580-TD9	ULTRIUM-TD9	-
9 Half-Height	ULT3580-HH9	ULTRIUM-HH9	HH LTO Gen 9

<sup>a</sup> IBM Tape Device Drivers only configure Product IDs found in these columns.  
<sup>b</sup> IBM SCDD only configures Product IDs found in this.  
<sup>c</sup> See the *IBM System Storage LTO Ultrium Tape Drive: SCSI Reference (GA32-0450-10)* (<http://publibfi.dhe.ibm.com/epubs/pdf/32045010.pdf>) for generations prior to LTO-5.

**WARNING****WARNING**

Drives targeted to be installed in eServer hosts have the eServer Attachment enabled during manufacturing. Drives that have eServer Attachment enabled have several behaviors that are different from the drives without eServer Attachment enabled. Please see the following sections and look for eServer attachment differences: <MP 2Fh: Behavior Configuration (see 6.6.20 on page 397), REWIND - 01h (see 5.2.33 on page 169), WRITE FILEMARKS - 10h (see 5.2.46 on page 184)>.

**WARNING****WARNING**

- m) PRODUCT REVISION LEVEL has four parts:
- A) **Y** is the last character of the year (for example, A indicates the year 2010)
  - B) **M** is the month, in the alphanumeric set 1 through 9, A, B, or C
  - C) **D** is the day, in the alphanumeric set 1 through 9, A through V
  - D) **V** is the version, in the alphanumeric set 0 through 9, a through z, and A through Z, with 0 being the earliest and Z the latest (to avoid interpretation errors, the characters i, l, and 0 are not used)
- n) Automation Disabled (AutDis) field set indicates that the drive is not capable of full automation function. When this field is 0, it indicates that the drive is capable of full automation function.
- o) The OEM Specific field and OEM Specific Subfield are for OEM specific reasons.
- p) The PROTOCOL IDENTIFIER field is defined by the PROTOCOL IDENTIFIER field defined in SPC-4 and copied in table 45.

**Table 45 — Standard Inquiry PROTOCOL IDENTIFIER values**

PROTOCOL IDENTIFIER	Description	Protocol Standard
0h	Fibre Channel	FCP-4
6h	SAS Serial SCSI Protocol	SAS-2
7h	Automation/Drive Interface - Transport Protocol	ADT-2

- q) The MAXIMUM SPEED SUPPORTED field reports the maximum speed supported on the primary interface. The values for SAS attached devices are defined in table 46. The values for Fibre Channel attached devices are defined in table 47.

**Table 46 — Standard Inquiry SAS MAXIMUM SPEED SUPPORTED values**

Value	Physical Link Rate
0h	Unknown
8h	1.5 Gbps
9h	3.0 Gbps
Ah	6.0 Gbps
Bh	12.0 Gbps

**Table 47 — Standard Inquiry Fibre Channel MAXIMUM SPEED SUPPORTED values**

Value	Physical Link Rate
0h	1 Gb/s
1h	2 Gb/s
2h	4 Gb/s
3h	8 Gb/s
4h	10 Gb/s
others	Reserved

- r) The FIPS field indicates information about the code level as it relates to the Federal Information Processing Standards. The FIPS field values are defined in table 48.

**Table 48 — Standard Inquiry FIPS field values**

Value	Description
00b	Code level and base have never been certified by FIPS
01b	Code level is built on top of a FIPS 140-2 certified code level but has not been certified since the change.
10b	Reserved
11b	Code level is a FIPS 140-2 certified code level

### 5.2.6 LOAD/UNLOAD - 1Bh

This command requests the drive move a volume (i.e., cartridge) to various positions. If there is no cartridge present in the drive, the command is presented with CHECK CONDITION status and associated sense data of 2/3A00 (NOT READY, MEDIUM NOT PRESENT).

**Table 49 — LOAD/UNLOAD CDB**

Byte	Bit							
	7	6	5	4	3	2	1	0
0	OPERATION CODE (1Bh)							
1	Obsolete (LUN) (ignored)			Reserved				IMMED
2	Reserved							
3	Reserved							
4	Reserved			HOLD	EOT (0)	RETEN	LOAD	
5	Control Byte (see 5.1.2.3)							

The following parameters apply:

- IMMED (Immediate)

Value	Description
0b	Indicates the drive is to present status when the command is completed.
1b	Indicates the drive is to present status as soon as all buffered commands have completed processing and the CDB of the Load Unload command has been validated. If a failure occurs related to the buffered data, the drive reports a DEFERRED ERROR, if appropriate. If there is no deferred error, the drive reports GOOD status and initiates the unload



operation. With the exception of INQUIRY, REQUEST SENSE, and TEST UNIT READY, subsequent commands are queued until the load/unload operation is complete.

- HOLD: Requests MAM to become accessible and the volume not be positioned for access (i.e., volume to be positioned at tray down, medium not threaded). See table 50 for interaction with other bits.
- EOT (End of Tape): 0b
- RETEN (Retention): In products that support Archive mode unthread (LTO7+) (see 4.3), requests Archive mode unthread. See table 50 for interaction with other bits.
- LOAD: Requests a load or unload be performed. See table 50 for interaction with other bits.

**Table 50 — Behavior for the combinations of the RETEN, LOAD, HOLD bits**

Volume position	HOLD	LOAD <sup>a</sup>	RETEN	Description
U, M, I, or T	0b	0b	0b	Unload the cartridge from the drive. Upon completion of the command, MAM is not accessible. If the cartridge is already unloaded, GOOD Status is returned.
U, M, or I	0b	0b	1b	Unload the cartridge from the drive. Upon completion of the command, MAM is not accessible. If the cartridge is already unloaded, GOOD Status is returned.
T	0b	0b	1b	Perform an Archive mode unthread (LTO7+) (see 4.3) and then unload the cartridge from the drive. Upon completion of the command, MAM is not accessible.
U, M, or I	0b	1b	-	Load the cartridge and become READY.
T	0b	1b	-	The logical position is set to logical block 0 of partition 0 (i.e., BOP 0) (this is not equivalent to a Rewind command as the active partition is set to partition 0).
U, M, I, or T	1b	-	0b	The cartridge is moved to the seated position with MAM accessible and the tape not threaded.
U, M, or I	1b	-	1b	The cartridge is moved to the seated position with MAM accessible and the tape not threaded.
T	1b	-	1b	An Archive mode unthread (LTO7+) (see 4.3) is performed and then the cartridge is moved to the seated position with MAM accessible and the tape not threaded.

**Key:**  
U - Unloaded  
M - MAM accessible not threaded  
I = In the IDLE\_C power condition state (i.e., power saving mode) with a volume mounted  
T - Threaded  
- = Don't care

<sup>a</sup> The LOAD UNLOAD command with the LOAD bit set to 0b is sometimes called an unload command. The LOAD UNLOAD command with the LOAD bit set to 1b is sometimes called a reload command.

If medium removal prevention is in effect, then the requested action for the combinations of the LOAD bit and HOLD bit are either allowed or prevented as described in table 51.

**Table 51 — Medium removal prevented behavior**

Volume Position	HOLD = 1b	HOLD=0b	
		LOAD = 0b	LOAD =1b
Present but not loaded	-	-	-
Mounted but not threaded	-	Prevented	-
Threaded	Prevented	Prevented	-

Key:  
 - Operation allowed  
 Prevented CHECK CONDITION status is returned with the sense key set to ILLEGAL REQUEST and the additional sense code set to MEDIUM REMOVAL PREVENTED (5/5302h)

If the medium removal is prevented (i.e., the result of applying the conditions in this table is Prevented), then no Archive mode unthread (LTO7+) (see 4.3) is performed.  
 An unload from the library via LUN 2 is never prevented.

### 5.2.7 LOCATE (10/16) - 2Bh/92h

The LOCATE command causes the logical position on tape to be set to the value indicated by the LOGICAL OBJECT IDENTIFIER field. The value indicates the total number of records and marks between BOP and the desired logical position. A value of zero causes the tape to be positioned at BOP.

**Table 52 — LOCATE (10) CDB**

Byte	Bit							
	7	6	5	4	3	2	1	0
0	OPERATION CODE (2Bh)							
1	Reserved					BT	CP	IMMED
2	Reserved							
3	(MSB) _____ LOGICAL OBJECT IDENTIFIER _____ (LSB)							
6								
7	Reserved							
8	PARTITION							
9	Control Byte (see 5.1.2.3)							

**Table 53 — LOCATE (16) CDB**

Byte	Bit							
	7	6	5	4	3	2	1	0
0	OPERATION CODE (92h)							
1	Reserved			DEST_TYPE	Rsvd	CP	IMMED	
2	Reserved						BAM	
3	PARTITION							
4	(MSB) _____ LOGICAL IDENTIFIER _____ (LSB)							
11								

Table 53 — LOCATE (16) CDB

Byte	Bit							
	7	6	5	4	3	2	1	0
12	Reserved							
14								
15	Control Byte (see 5.1.2.3)							

The following parameters apply:

- BT (block type): 0b
- cp (change partition):
 

Value	Description
0b	No partition change occurs and the partition field is ignored.
1b	The logical position of the medium is changed to the partition specified in the PARTITION field as part of the locate operation.
- IMMED (Immediate):
 

Value	Description
0b	Status is not returned until after the command has completed.
1b	The device validates the command and waits for any previous command from any server to complete, including any immediate commands that are currently being processed. It also waits for any buffered data to be flushed to tape. It then reports a DEFERRED ERROR for any preceding command or buffered data, if any. If there is no deferred error, the drive reports GOOD status and initiates processing the command.
- PARTITION: The partition to locate to if the CP bit is 1b.
- DEST\_TYPE (destination type): Used in conjunction with the LOGICAL IDENTIFIER field to locate to the appropriate position of the medium.
 

Value	Description
00b	The LOGICAL IDENTIFIER field is interpreted as a logical object identifier. The Logical Position upon successful completion is on the BOP side of the logical object.
01b	The LOGICAL IDENTIFIER field is interpreted as a logical file identifier. The Logical Position upon successful completion is on the BOP side of the logical file.
011b	The LOGICAL IDENTIFIER field is ignored and the logical position upon completion is EOD (end-of-data) of the partition specified in the PARTITION field if the CP bit is set to 1b or EOD of the current partition if the CP bit is set to 0b.
others	Reserved
- LOGICAL OBJECT IDENTIFIER: The logical object identifier to which the medium is to be positioned.
- LOGICAL IDENTIFIER: The logical object identifier (if the DEST\_TYPE is set to 00b) or the logical file identifier (if the DEST\_TYPE is set to 01b) to which the medium is to be positioned.

### 5.2.8 LOG SELECT - 4Ch

The LOG SELECT command causes log data on the drive to be reset to its default value or to be set to an initiator-specific value.

**Table 54 — LOG SELECT CDB**

Byte	Bit								
	7	6	5	4	3	2	1	0	
0	OPERATION CODE (4Ch)								
1	Reserved						PCR	SP	
2	PC		PAGE CODE						
3	SUBPAGE CODE								
4	Reserved								
6	Reserved								
7	(MSB)	PARAMETER LIST LENGTH						(LSB)	
8	PARAMETER LIST LENGTH								
9	Control Byte (see 5.1.2.3)								

- Parameter Code Reset (PCR):

If the Parameter Code Reset (PCR) bit is set to one, then the PARAMETER LIST LENGTH shall be zero. The action taken by the drive is specified for the values of the Page Control (PC) field as follows:

**Value Description**

00b	no action is taken and GOOD status is returned.
01b	all resettable logs on the drive are reset to default values.
10b	no action is taken and GOOD status is returned.
11b	all resettable logs on the drive are reset to default values.

If the Parameter Code Reset (PCR) field is set to 0, the Parameter List Length is not 0. The action taken by the drive is specified for the values of the PC field as follows:

**Value Description**

00b	CHECK CONDITION status is returned with the Sense Key set to ILLEGAL REQUEST and the additional sense code set to INVALID FIELD IN CDB (5/2400h).
01b	data from the server is written to the indicated logs, provided that the logs are writable.
10b	CHECK CONDITION status is returned with the Sense Key set to ILLEGAL REQUEST and the additional sense code set to INVALID FIELD IN CDB (5/2400h).
11b	data from the server is written to the indicated logs, provided that the logs are writable.

- Save Page (SP): (0b)

For a list of supported page codes see Log Parameters (LP) (see 6.4 on page 255).

### 5.2.9 LOG SENSE - 4Dh

The LOG SENSE command causes log data to be sent to the initiator.

**Table 55 — LOG SENSE CDB**

Byte	Bit							
	7	6	5	4	3	2	1	0
0	OPERATION CODE (4Dh)							
1	Reserved						PPC	SP
2	PC		PAGE CODE					

Table 55 — LOG SENSE CDB

Byte	Bit							
	7	6	5	4	3	2	1	0
3	SUBPAGE CODE							
4	Reserved							
5	(MSB)		PARAMETER POINTER				(LSB)	
6								
7	(MSB)		ALLOCATION LENGTH				(LSB)	
8								
9	Control Byte (see 5.1.2.3)							

The log values returned are controlled by the Page Control (PC) field value as follows:

Value	Description
00b	the maximum value for each log entry is returned.
01b	the current values are returned.
10b	the maximum value for each log entry is returned.
11b	the power-on values are returned.

NOTE 8 - For page 2Eh (TapeAlert) only, the PC field is ignored. Current values are always returned.

The Parameter Pointer Control (PPC) must be set to 0. Returning changed parameters is not supported. The Save Page (SP) field must be set to 0. Saved pages are not supported. The Parameter Pointer is 0.

**WARNING**

Log parameter data must be dynamically parsed as some parameters may not be present and other parameters may be inserted. The relative location of parameters have changed and are anticipated to continue to change.

**WARNING**

For a list of supported page codes see Log Parameters (LP) (see 6.4 on page 255).

### 5.2.10 MODE SELECT (6/10) - 15h/55h

The MODE SELECT commands are defined in SPC (see the latest version at [http://www.t10.org/drafts.htm#SCSI3\\_CMNDSETS](http://www.t10.org/drafts.htm#SCSI3_CMNDSETS)). This clause describes the specific implementation.

NOTE 9 - In the future, the length of the mode parameter list for Mode Sense Page Code 3Fh (All Pages) may exceed 255 bytes. At that time, use of the Mode Select (10) and Mode Sense (10) commands is required in order to transfer all mode pages with one command. Some mode pages today exceed 255 bytes. For this reason, use of the Mode Select (6) and Mode Sense (6) commands is not recommended.

Table 56 — MODE SELECT (6) CDB

Byte	Bit							
	7 msb	6	5	4	3	2	1	0 lsb
0	OPERATION CODE (15h)							
1	Obsolete (LUN)			PF	Reserved			SP
2	Reserved							
3								
4	PARAMETER LIST LENGTH							
5	Control Byte (see 5.1.2.3)							

Table 57 — MODE SELECT (10) CDB

Byte	Bit							
	7 msb	6	5	4	3	2	1	0 lsb
0	OPERATION CODE (55h)							
1	Obsolete (LUN)			PF	Reserved			SP
2	Reserved							
6	Reserved							
7	(MSB)	PARAMETER LIST LENGTH						(LSB)
8	Control Byte (see 5.1.2.3)							
9	Control Byte (see 5.1.2.3)							

The following parameters apply:

- PF (Page Format): 1b  
The PF bit is explicitly not checked.
- SP (Save Pages): Only allowed to be set to one when explicitly mentioned in the description of the specific mode page
- PARAMETER LIST LENGTH:

This field specifies the length in bytes of the mode parameter list that is transferred from the initiator to the target. A parameter list length of zero indicates that no data is transferred. This condition is not considered as an error.

The target terminates the command with CHECK CONDITION status with associated sense data of 5/1A00 (ILLEGAL REQUEST, PARAMETER LIST LENGTH ERROR) if the parameter list length results in the truncation of the mode parameter header, the mode parameter block descriptor, or any mode page.

NOTE 10 - Issuing a MODE SENSE for current values before a MODE SELECT is generally recommended to avoid accidentally attempting to set fields that are not allowed to be changed by the initiator.

If any of the fields in the mode parameters are invalid, no parameters are altered, CHECK CONDITION status is returned, the Sense Key is set to ILLEGAL REQUEST, and the ASC/ASCQ is set to INVALID FIELD IN PARAMETER LIST (2600).

NOTE 11 - For Reserved and Vendor-Reserved fields, appropriate values to issue on a MODE SELECT may be non-zero. A MODE SELECT to pages with these fields should use a value obtained by issuing a MODE SENSE just prior to the MODE SELECT.

NOTE 12 - The PS bit in bit 7 byte 0 of each mode page is explicitly ignored on a MODE SELECT command.

Mode Parameters (MP) (see 6.6 on page 359) has a listing of all mode parameters.

See Supported Mode Pages (see 6.6.4 on page 365) for a listing of supported mode pages.

### 5.2.11 MODE SENSE (6/10) - 1Ah/5Ah

The MODE SENSE commands are defined in SPC (see the latest version at [http://www.t10.org/drafts.htm#SCSI3\\_CMNDSETS](http://www.t10.org/drafts.htm#SCSI3_CMNDSETS)). This clause describes the specific implementation.

NOTE 13 - In the future, the length of the mode parameter list for Mode Sense Page Code 3Fh (All Pages) may exceed 255 bytes. At that time, use of the MODE SELECT (10) and MODE SENSE (10) commands is required

in order to transfer all mode pages with one command. For this reason, use of the MODE SELECT (6) and MODE SENSE (6) commands is not recommended.

**Table 58 — MODE SENSE (6) CDB**

Byte	Bit							
	7 msb	6	5	4	3	2	1	0 lsb
0	OPERATION CODE (1A)							
1	Obsolete (LUN)			Reserved	DBD	Reserved		
2	PC	PAGE CODE						
3	SUBPAGE CODE							
4	ALLOCATION LENGTH							
5	Control Byte (see 5.1.2.3)							

**Table 59 — MODE SENSE (10) CDB**

Byte	Bit							
	7 msb	6	5	4	3	2	1	0 lsb
0	OPERATION CODE (5A)							
1	Obsolete (LUN)			Reserved	DBD	Reserved		
2	PC	PAGE CODE						
3	SUBPAGE CODE							
4	Reserved							
6	Reserved							
7	(MSB)	ALLOCATION LENGTH						(LSB)
8	ALLOCATION LENGTH							
9	Control Byte (see 5.1.2.3)							

The following parameters apply:

- DBD (Disable Block Descriptors): 0b or 1b. (see 6.6.2.1)
- PC (Page Control):
 

Value	Description
00b	current values
01b	changeable bitmap (changeable = 1; unchangeable = 0)
10b	default (power-on) values
11b	saved values. When values that are not saveable are returned the default values are used
- PAGE CODE: This field along with the SUBPAGE CODE field indicate which mode page is requested.
- SUBPAGE CODE: This field along with the PAGE CODE field indicate which mode page is requested.
- ALLOCATION LENGTH: The maximum number of bytes to be transferred.

If the allocation length specified is less than the amount available, then the allocated amount is transferred and no error is reported.

Mode Parameters (MP) (see 6.6 on page 359) has a listing of all mode parameters.

See Supported Mode Pages (see 6.6.4 on page 365) for a listing of supported mode pages.

### 5.2.12 PERSISTENT RESERVE IN (PRIN)- 5Eh

The PERSISTENT RESERVE IN command is defined in SPC (see the latest version at [http://www.t10.org/drafts.htm#SCSI3\\_CMNDSETS](http://www.t10.org/drafts.htm#SCSI3_CMNDSETS)). This clause describes the specific implementation.

**Table 60 — PERSISTENT RESERVE IN CDB**

Byte	Bit							
	7 msb	6	5	4	3	2	1	0 lsb
0	OPCODE (5Eh)							
1	Reserved			SERVICE ACTION				
2	Reserved							
5	Reserved							
6	(MSB)	ALLOCATION LENGTH						(LSB)
8								
9	Control Byte (see 5.1.2.3)							

The following parameters apply:

- SERVICE ACTION:
 

Value	Description
00h	READ KEYS - Reads all registered Reservation Keys (see 5.2.12.1)
01h	READ RESERVATION - Reads all current persistent reservations (see 5.2.12.2)
02h	REPORT CAPABILITIES - Returns capability information (see 5.2.12.3)
03h	READ FULL STATUS - Reads complete information about all registrations and the persistent reservations, if any (see 5.2.12.4)
- ALLOCATION LENGTH: The maximum number of bytes to be transferred.

#### 5.2.12.1 READ KEYS service action

The READ KEYS service action requests that the device server return a parameter list containing a header and a list of each currently registered I\_T nexus' reservation key.



The format for the parameter data provided in response to a PERSISTENT RESERVE IN command with the READ KEYS service action is shown in table 61.

**Table 61 — PERSISTENT RESERVE IN parameter data for READ KEYS**

Byte	Bit							
	7 msb	6	5	4	3	2	1	0 lsb
0	(MSB) PRGENERATION (LSB)							
3								
4	(MSB) ADDITIONAL LENGTH (n-7) (LSB)							
7								
Reservation key list								
8	(MSB) Reservation key [first] (LSB)							
15								
:								
n-7	(MSB) Reservation key [last] (LSB)							
n								

**Byte Description**

- 0-3 PRGENERATION: Counter for Persistent Reserve Out Command requests
- 4-7 ADDITIONAL LENGTH: A count of the number of bytes in the Reservation key list
- 8-15 First Reservation Key
- 16-n Additional Reservation keys: additional reservation keys are not supported.

### 5.2.12.2 READ RESERVATION service action

The READ RESERVATION service action requests that the device server return a parameter list containing a header and the persistent reservation, if any, that is present in the device server.

The format for the parameter data provided in response to a PERSISTENT RESERVE IN command with the READ RESERVATION service action is shown in table 62.

**Table 62 — PERSISTENT RESERVE IN parameter data for READ RESERVATION**

Byte	Bit							
	7 msb	6	5	4	3	2	1	0 lsb
0	(MSB) PRGENERATION (LSB)							
3								
4	(MSB) ADDITIONAL LENGTH (LSB)							
7								
If reservation exists (i.e., ADDITIONAL LENGTH > 0000 0000h)								
8	(MSB) RESERVATION KEY (LSB)							
15								
16	Obsolete							
19								
20	Reserved							
21	SCOPE				TYPE			
22								
23	Obsolete							

#### Byte Description

- 0-3 PRGENERATION: Counter for Persistent Reserve Out Command requests  
 4-7 ADDITIONAL LENGTH: A count of the number of bytes in the Reservation key list.

#### Value Description

- 00000000h No reservation exists  
 00000010h Reservation exists and this much data follows

- 8-n Reservation descriptor, if any: (defined below)

- 8-15 Reservation Key

- 16-19 Obsolete

- 20 Reserved

- 21

#### Bit Description

- 7-4 SCOPE: persistent reservation applies to the entire logical unit: 0h

- 4-0 TYPE:

- | Value  | Description                         |
|--------|-------------------------------------|
| 3h     | Exclusive Access                    |
| 6h     | Exclusive Access — Registrants only |
| 8h     | Exclusive Access — All Registrants  |
| others | Not supported                       |

- 22-23 Obsolete

### 5.2.12.3 REPORT CAPABILITIES service action

The REPORT CAPABILITIES service action requests that the device server return information on persistent reservation features.

The format for the parameter data provided in response to a PERSISTENT RESERVE IN command with the REPORT CAPABILITIES service action is shown in table 63.

**Table 63 — PERSISTENT RESERVE IN parameter data for REPORT CAPABILITIES**

Byte	Bit							
	7 msb	6	5	4	3	2	1	0 lsb
0	(MSB) _____							
1	LENGTH (0008h)							(LSB)
2	Reserved			CRH	SIP_C	ATP_C	Reserved	PTPL_C
3	TMV	ALLOW COMMANDS (000b)			Reserved			PTPL_A
Persistent Reservation Type Mask								
4	WR_EX_AR	EX_AC_RO	WR_EX_RO	Rsvd	EX_AC	Rsvd	WR_EX	Rsvd
5	Reserved							EX_AC_AR
6	Reserved							
7	Reserved							

#### Byte Description

0-1 LENGTH: 0008h

2

Bit	Description
7-5	Reserved
4	CRH (Compatible Reservation Handling): 1b
3	SIP_C (Specify Initiator Ports Capable): 0b
2	ATP_C (All Target Ports Capable): 0b
1	Reserved
0	PTPL_C (Persist Through Power Loss Capable): 0b

3

Bit	Description
7	TMV (Type Mask Valid): 1b
6-4	ALLOW COMMANDS: 000b
	<b>Value</b> <b>Description</b>
	000b          No information is provided about whether certain commands are allowed through certain types of persistent reservations.
	001b-100b <u>Not Supported</u> . TUR is allowed through Exclusive Access reservations [and info about certain other commands and Write Exclusive reservations].
	101b-111b   Reserved
3-1	Reserved
0	PTPL_A (Persist Through Power Loss Activated): 0b

## 4 Persistent Reservation Type Mask (byte 4)

Bit	Description
7	WR_EX_AR (Write Exclusive — All Registrants): 0b
6	EX_AC_RO (Exclusive Access — Registrants Only): 1b
5	WR_EX_RO (Write Exclusive — Registrants Only): 0b
4	Reserved
3	EX_AC (Exclusive Access): 1b
2	Reserved
1	WR_EX (Write Exclusive): 0b
0	Reserved

## 5 Persistent Reservation Type Mask (byte 5)

Bit	Description
7-1	Reserved
0	EX_AC_AR (Exclusive Access — All Registrants): 0b

## 6-7 Reserved

**5.2.12.4 READ FULL STATUS service action**

The READ FULL STATUS service action requests that the device server return a parameter list describing the registration and persistent reservation status of each currently registered I\_T nexus for the logical unit.

The format for the parameter data provided in response to a PERSISTENT RESERVE IN command with the READ FULL STATUS service action is shown in table 64.

**Table 64 — PERSISTENT RESERVE IN parameter data for READ FULL STATUS**

Byte	Bit							
	7 msb	6	5	4	3	2	1	0 lsb
0	(MSB) PRGENERATION (LSB)							
3								
4	(MSB) ADDITIONAL LENGTH (n-7) (LSB)							
7								
Full status descriptors								
8	Full status descriptor [first] (see table 65)							
⋮								
n	Full status descriptor [last] (see table 65)							

**Byte Description**

0-3	PRGENERATION:
4-7	ADDITIONAL LENGTH (n-7)
8-n	Full status descriptors (see 5.2.12.4.1).

### 5.2.12.4.1 Full status descriptors

The format of the full status descriptors is shown in table 65. Each full status descriptor describes one or more registered I\_T nexuses. The device returns persistent reservations status information for every registered I\_T nexus.

**Table 65 — PERSISTENT RESERVE IN full status descriptor format**

Byte	Bit							
	7 msb	6	5	4	3	2	1	0 lsb
0	(MSB) _____							
7	RESERVATION KEY _____ (LSB)							
8	Reserved _____							
11	Reserved _____							
12	Reserved						ALL_TG_PT	R HOLDER
13	SCOPE				TYPE			
14	Reserved _____							
17	Reserved _____							
18	(MSB) _____							
19	RELATIVE TARGET PORT IDENTIFIER _____ (LSB)							
20	(MSB) _____							
23	ADDITIONAL DESCRIPTOR LENGTH (n-23) _____ (LSB)							
24	TRANSPORTID _____							
n	_____							

#### Byte Description

0-7 RESERVATION KEY:

8-11 Reserved

12

#### Bit Description

7-2 Reserved

1 ALL\_TG\_PT (All Target Ports)

0 R HOLDER (Reservation Holder)

13

#### Bit Description

7-4 SCOPE

3-0 TYPE

14-17 Reserved

18-19 RELATIVE TARGET PORT IDENTIFIER:

20-23 ADDITIONAL DESCRIPTOR LENGTH (n-23)

24-n TRANSPORTID: TransportID identifying the initiator port that is part of the I\_T nexus or I\_T nexuses described by this full status descriptor.

### 5.2.13 PERSISTENT RESERVE OUT - 5Fh

The Persistent Reserve Out command is defined in SPC-4 (see the latest version at [http://www.t10.org/drafts.htm#SCSI3\\_CMNDSETS](http://www.t10.org/drafts.htm#SCSI3_CMNDSETS)). This clause describes the specific implementation.

**Table 66 — PERSISTENT RESERVE OUT CDB**

Byte	Bit							
	7 msb	6	5	4	3	2	1	0 lsb
0	OPCODE (5Fh)							
1	Reserved			SERVICE ACTION				
2	SCOPE				TYPE			
3	Reserved							
6	Reserved							
7	(MSB)	PARAMETER LIST LENGTH						(LSB)
8	PARAMETER LIST LENGTH							
9	Control Byte (see 5.1.2.3)							

The following parameters apply:

- SERVICE ACTION:

Value	Description
00h	REGISTER: Register a reservation key with the device server
01h	RESERVE: Create a persistent reservation using a reservation key
02h	RELEASE: Release a persistent reservation
03h	CLEAR: Clear all reservation keys and all persistent reservations
04h	PREEMPT: Preempt persistent reservations and/or removes registrations
05h	PREEMPT AND ABORT: Preempt persistent reservations and/or removes registrations and clear the task set for the preempted initiator
07h	REGISTER AND MOVE: Register And Move the registration to another I_T nexus.
08h-1Fh	Reserved

- SCOPE: 0h

If the Service Action field is set to RESERVE, RELEASE, PREEMPT, PREEMPT AND ABORT, or REGISTER AND MOVE then SCOPE shall be zero. This field is ignored for other Service Actions.

- TYPE:

Value	Description
3h	Exclusive Access
6h	Exclusive Access — Registrants only
others	Not supported

- PARAMETER LIST LENGTH:

Value	Description
0018h	All values of SERVICE ACTION except REGISTER AND MOVE (i.e., 07h)
variable	SERVICE ACTION set to REGISTER AND MOVE (i.e., 07h)

### 5.2.13.1 Basic PERSISTENT RESERVE OUT parameter list

The PERSISTENT RESERVE OUT command with any service action except the REGISTER AND MOVE service action uses the parameter list format shown in table 67.

**Table 67 — PERSISTENT RESERVE OUT parameter list**

Byte	Bit							
	7 msb	6	5	4	3	2	1	0 lsb
0	RESERVATION KEY							
7								
8	SERVICE ACTION RESERVATION KEY							
15								
16	Obsolete							
19								
20	Reserved			SPEC_I_PT	ALL_TG_PT	Reserved	APTPL	
21	Reserved							
22	Obsolete							
23								

#### Byte Description

0-7 RESERVATION KEY  
 8-15 SERVICE ACTION RESERVATION KEY  
 16-19 Obsolete  
 20

#### Bit Description

7-4 Reserved  
 3 SPEC\_I\_PT(Specify Initiator Ports): 0b  
 2 ALL\_TG\_PT(All Target Ports): 0b  
 1 Reserved  
 0 APTPL (Activate Persist Through Power Loss): 0b  
 21 Reserved  
 22-23 Obsolete

### 5.2.13.2 PERSISTENT RESERVE OUT with REGISTER AND MOVE service action parameters

The parameter list format shown in table 68 shall be used by the PERSISTENT RESERVE OUT command with REGISTER AND MOVE service action.

**Table 68 — PERSISTENT RESERVE OUT with REGISTER AND MOVE service action parameter list**

Byte	Bit							
	7 msb	6	5	4	3	2	1	0 lsb
0	(MSB) _____ RESERVATION KEY _____ (LSB)							
7								
8	(MSB) _____ SERVICE ACTION RESERVATION KEY _____ (LSB)							
15								
16	Reserved							
17	Reserved						UNREG	APTPL
18	(MSB) _____ RELATIVE TARGET PORT IDENTIFIER _____ (LSB)							
19								
20	(MSB) _____ TRANSPORTID PARAMETER DATA LENGTH (n-23) _____ (LSB)							
23								
24	TRANSPORTID _____							
n								

#### Byte Description

0-7 RESERVATION KEY

8-15 SERVICE ACTION RESERVATION KEY

16 Reserved

17

#### Bit Description

7-2 Reserved

1 UNREG (Unregister):

0 APTPL (Activate Persist Through Power Loss): 0b

18-19 RELATIVE TARGET PORT IDENTIFIER

20-23 ADDITIONAL DESCRIPTOR LENGTH (n-23)

24-n TRANSPORTID

### 5.2.14 PREVENT ALLOW MEDIUM REMOVAL - 1Eh

The PREVENT ALLOW MEDIUM REMOVAL command is defined in SSC (see the latest version at [http://www.t10.org/drafts.htm#SCSI3\\_CMNDSETS](http://www.t10.org/drafts.htm#SCSI3_CMNDSETS)). This clause describes the specific implementation.

The Prevent Allow Medium Removal command is supported only for the Prevent Cartridge Removal option. Table 69 shows the command format.

**Table 69 — PREVENT ALLOW MEDIUM REMOVAL CDB**

Byte	Bit							
	7 msb	6	5	4	3	2	1	0 lsb
0	OPERATION CODE (1Eh)							
1	Obsolete (LUN)				Reserved			



Table 69 — PREVENT ALLOW MEDIUM REMOVAL CDB

Byte	Bit							
	7 msb	6	5	4	3	2	1	0 lsb
2	Reserved							
3								
4	Reserved						PREVENT	
5	Control Byte (see 5.1.2.3)							

The following parameters apply:

- PREVENT:

Value	Description
00b	Allow Cartridge Removal: Medium removal is allowed through this I_T nexus
01b	Prevent Cartridge Removal: Medium removal is prevented through this I_T nexus
10b	Obsolete
11b	Obsolete

### 5.2.14.1 Medium removal

When medium removal is prevented and an I\_T nexus requests to eject or unmount the volume via a SCSI LOAD UNLOAD command that that command is rejected with a CHECK CONDITION status with the Sense Key set to ILLEGAL REQUEST and the additional sense code set to MEDIUM REMOVAL PREVENTED (5/5302).

When medium removal is prevented by any I\_T nexus, requests to eject the volume via the panel are ignored.

Volume removal is enabled again when each I\_T nexus that has prevented medium removal has issued the PREVENT ALLOW MEDIUM REMOVAL command with the PREVENT field set to 00b (Allow Cartridge Removal) or has experienced an I\_T nexus loss event. A reset (bus device reset, reset message, or power on reset) also restores the drive to the allow removal state. In the case of the bus device reset or the reset message, the reset restores the allow state only if the reset occurs on the same port that originally set Prevent.

If a persistent reservation or registration is being preempted by a PERSISTENT RESERVE OUT command with PREEMPT AND ABORT service action, then the equivalent of a PREVENT ALLOW MEDIUM REMOVAL command with the PREVENT field set to 00b is processed for each I\_T nexus associated with the persistent reservation or registrations being preempted.

NOTE 14 - The PREVENT ALLOW MEDIUM REMOVAL command does not prohibit medium removal by library commands that may be received.

### 5.2.15 READ - 08h

The READ command is defined in SSC (see the latest version at [http://www.t10.org/drafts.htm#SCSI3\\_CMNDSETS](http://www.t10.org/drafts.htm#SCSI3_CMNDSETS)). This clause describes the specific implementation.

Table 70 — READ CDB

Byte	Bit								
	7 msb	6	5	4	3	2	1	0 lsb	
0	OPERATION CODE (08h)								
1	Obsolete (LUN)				Reserved			SILI	FIXED
2	MSB								
4	TRANSFER LENGTH								
5	LSB								
5	Control Byte (see 5.1.2.3)								

The following parameters apply:

- SILI (Suppress Incorrect Length Indicator): (see 4.12)
- FIXED (see 4.11)
- TRANSFER LENGTH (see 4.11)

General Read-Type Handling (see 4.12.1 on page 47) provides additional information.

### 5.2.16 READ ATTRIBUTE - 8Ch

The READ ATTRIBUTE command is defined in SPC-4 (see the latest version at [http://www.t10.org/drafts.htm#SCSI3\\_CMNDSETS](http://www.t10.org/drafts.htm#SCSI3_CMNDSETS)). This clause describes the specific implementation. The READ ATTRIBUTE command (see table 71) allows an application client to read attribute values from medium auxiliary memory.

**Table 71 — READ ATTRIBUTE CDB**

Byte	Bit							
	7 msb	6	5	4	3	2	1	0 lsb
0	OPERATION CODE (8Ch)							
1	Reserved			SERVICE ACTION				
2	Obsolete							
4	Obsolete							
5	LOGICAL VOLUME NUMBER							
6	Reserved							
7	PARTITION NUMBER							
8	(MSB)	FIRST ATTRIBUTE IDENTIFIER						(LSB)
9	FIRST ATTRIBUTE IDENTIFIER							
10	(MSB)	ALLOCATION LENGTH						(LSB)
13	ALLOCATION LENGTH							
14	Reserved							CACHE
15	Control Byte (see 5.1.2.3)							

If cached attribute information is not reported (e.g., the CACHE bit is set to zero or the CACHE bit is set to one and there is no cached attributes available) and there is no medium present, then the command is terminated with CHECK CONDITION status, with NOT READY, MEDIUM NOT PRESENT (2/3A00).

If cached attribute information is not available (e.g., the CACHE bit is set to zero) and the medium is present but the medium auxiliary memory is not accessible, then the READ ATTRIBUTE command is terminated with CHECK CONDITION status, with MEDIUM ERROR, LOGICAL UNIT NOT READY, AUXILIARY MEMORY NOT ACCESSIBLE (3/0410).

If the medium auxiliary memory is not operational, the READ ATTRIBUTE command is terminated with CHECK CONDITION status, with MEDIUM ERROR, AUXILIARY MEMORY READ ERROR (3/1112) and the Memory Chip in Cartridge Failure TapeAlert (i.e., 0Fh) is asserted.

The following parameters apply:

- SERVICE ACTION:
 

Value	Description
00h	ATTRIBUTE VALUES: Return attribute values as specified in ATTRIBUTE VALUES service action (see 5.2.16.1 on page 109)
01h	ATTRIBUTE LIST: Return a list of available attribute identifiers – identifiers that are in the read only state or in the read/write state (see 4.20) as specified in ATTRIBUTE LIST service action (see 5.2.16.2 on page 110)
02h	LOGICAL VOLUME LIST: Return a list of known logical volume numbers as defined in LOGICAL VOLUME LIST service action (see 5.2.16.3 on page 110)
03h	PARTITION LIST: Return a list of known partition numbers as defined in PARTITION LIST service action (see 5.2.16.4 on page 111)
05h	SUPPORTED ATTRIBUTES: Return a list of supported attribute identifiers – identifiers that are in the read only state, in the read/write state, or in the nonexistent state (see 4.20) as defined in SUPPORTED ATTRIBUTES service action (see 5.2.16.5 on page 111)
- LOGICAL VOLUME NUMBER: 00h
- PARTITION NUMBER: The partition of the attribute to be accessed.
- FIRST ATTRIBUTE IDENTIFIER: The attribute identifier of the first attribute to be returned.
- ALLOCATION LENGTH: The number of bytes allowed to be returned
- CACHE: Specifies whether or not to report attribute information cached from the most recently mounted volume. This bit is ignored if there is a volume mounted. Attribute information from cache is the complete set of attribute information from the most recently mounted volume. Cached attribute information is cleared at the start of a volume load.

Drives prior to LTO7 always behave as if the CACHE bit is set to 1b.

Value	Description
0b	Do not report cached attribute information.
1b	Report cached attribute information.

### 5.2.16.1 ATTRIBUTE VALUES service action

The READ ATTRIBUTE command with ATTRIBUTE VALUES service action returns parameter data containing the attributes that are in the read state or read/write state (see 4.20) specified by the PARTITION NUMBER, LOGICAL VOLUME NUMBER, and FIRST ATTRIBUTE IDENTIFIER fields in the CDB. The returned parameter data shall contain the requested attributes in ascending numerical order by attribute identifier value and in the format shown in table 72.

**Table 72 — READ ATTRIBUTE with ATTRIBUTE VALUES service action parameter list format**

Byte	Bit							
	7 msb	6	5	4	3	2	1	0 lsb
0	(MSB)							
3	AVAILABLE DATA (n-3)							(LSB)
	Attribute(s)							
4	Attribute 0 (see 6.5.1)							
	⋮							
n	Attribute x (see 6.5.1)							

The AVAILABLE DATA field shall contain the number of bytes of attribute information in the parameter list.

MAM attribute format (see 6.5.1 on page 349) describes the format of the attributes.

### 5.2.16.2 ATTRIBUTE LIST service action

The READ ATTRIBUTE command with ATTRIBUTE LIST service action returns parameter data containing the attribute identifiers for the attributes that are in the read only state or in the read/write state (see 4.20) in the specified partition and volume number. The contents of FIRST ATTRIBUTE IDENTIFIER field in the CDB shall be ignored. The returned parameter data shall contain the requested attribute identifiers in ascending numerical order by attribute identifier value and in the format shown in table 73.

**Table 73 — READ ATTRIBUTE with ATTRIBUTE LIST service action parameter list format**

Byte	Bit							
	7 msb	6	5	4	3	2	1	0 lsb
0	(MSB)							
3	AVAILABLE DATA (n-3)							(LSB)
	Attribute identifiers							
4	ATTRIBUTE IDENTIFIER 0							
5								
	⋮							
n-1	ATTRIBUTE IDENTIFIER X							
n								

The AVAILABLE DATA field shall contain the number of bytes of attribute identifiers in the parameter list.

An ATTRIBUTE IDENTIFIER field is returned for each attribute that is in the read only state or in the read/write state (see 4.20) in the specified partition and volume number. Attribute identifier values (see 6.5.2 on page 350) provides a description of the attribute identifier values.

### 5.2.16.3 LOGICAL VOLUME LIST service action

The READ ATTRIBUTE command with LOGICAL VOLUME LIST service action returns parameter data (see table 74) identifying the supported number of logical volumes. The contents of LOGICAL VOLUME NUMBER, PARTITION NUMBER, and FIRST ATTRIBUTE IDENTIFIER fields in the CDB shall be ignored.

**Table 74 — READ ATTRIBUTE with LOGICAL VOLUME LIST service action parameter list format**

Byte	Bit							
	7 msb	6	5	4	3	2	1	0 lsb
0	(MSB)							
1	AVAILABLE DATA (0002h)							(LSB)
2	FIRST LOGICAL VOLUME NUMBER							
3	NUMBER OF LOGICAL VOLUMES AVAILABLE							

The AVAILABLE DATA field shall contain two.

The FIRST LOGICAL VOLUME NUMBER field indicates the first volume available. Logical volume numbering should start at zero.

The NUMBER OF LOGICAL VOLUMES AVAILABLE field indicates the number of volumes available.

### 5.2.16.4 PARTITION LIST service action

The READ ATTRIBUTE command with PARTITION LIST service action returns parameter data (see table 75) identifying the number of partitions supported in the specified logical volume number. The contents of PARTITION NUMBER and FIRST ATTRIBUTE IDENTIFIER fields in the CDB shall be ignored.

**Table 75 — READ ATTRIBUTE with PARTITION LIST service action parameter list format**

Byte	Bit							
	7 msb	6	5	4	3	2	1	0 lsb
0	(MSB)							
1	AVAILABLE DATA (0002h)							
2	FIRST PARTITION NUMBER							
3	NUMBER OF PARTITIONS AVAILABLE							

The AVAILABLE DATA field shall contain two.

The FIRST PARTITION NUMBER field indicates the first partition available on the specified logical volume number. Partition numbering should start at zero.

The NUMBER OF PARTITIONS AVAILABLE field indicates the number of partitions available on the specified logical volume number.

### 5.2.16.5 SUPPORTED ATTRIBUTES service action

The READ ATTRIBUTE command with SUPPORTED ATTRIBUTES service action returns parameter data containing the attribute identifiers for the attributes that are in the read only state, in the read/write state, or in the nonexistent state (see 4.20) in the specified partition and volume number. The contents of FIRST ATTRIBUTE IDENTIFIER field in the CDB shall be ignored. The returned parameter data shall contain the requested attribute identifiers in ascending numerical order by attribute identifier value and in the format shown in table 76.

**Table 76 — READ ATTRIBUTE with SUPPORTED ATTRIBUTES service action parameter list format**

Byte	Bit							
	7 msb	6	5	4	3	2	1	0 lsb
0	(MSB)							
3	AVAILABLE DATA (n-3)							
	(LSB)							
	Attribute identifiers							
4	ATTRIBUTE IDENTIFIER 0							
5	:							
n-1	ATTRIBUTE IDENTIFIER X							
n								

The AVAILABLE DATA field shall contain the number of bytes of attribute identifiers in the parameter list.

An ATTRIBUTE IDENTIFIER field is returned for each attribute that is in the read only state, in the read/write state, or in the nonexistent state (see 4.20) in the specified partition and volume number. Attribute identifier values (see 6.5.2 on page 350) describes the attribute identifier values.

### 5.2.17 READ BLOCK LIMITS - 05h

The READ BLOCK LIMITS command is defined in SSC (see the latest version at [http://www.t10.org/drafts.htm#SCSI3\\_CMNDSETS](http://www.t10.org/drafts.htm#SCSI3_CMNDSETS)). This clause describes the specific implementation.

**Table 77 — READ BLOCK LIMITS CDB**

Byte	Bit							
	7 msb	6	5	4	3	2	1	0 lsb
0	OPERATION CODE (05h)							
1	Obsolete (LUN)			Reserved				MLOI
2	Reserved							
4	Reserved							
5	Control Byte (see 5.1.2.3)							

The following parameters apply:

- maximum logical object identifier (MLOI):
 

<b>Value</b>	<b>Description</b>
0b	Return the READ BLOCK LIMITS block length data (see 5.2.17.1).
1b	Return the READ BLOCK LIMITS maximum logical object identifier data (see 5.2.17.2).

#### 5.2.17.1 READ BLOCK LIMITS block length data

The returned parameter data is in the format shown in table 78.

**Table 78 — RBL parameter data**

Byte	Bit							
	7 msb	6	5	4	3	2	1	0 lsb
0	Reserved			GRANULARITY				
1	(MSB)			MAXIMUM BLOCK LENGTH LIMIT				(LSB)
3								
4	(MSB)			MINIMUM BLOCK LENGTH LIMIT				(LSB)
5								

The following parameters apply to the Read Block Limits data:

#### Byte Description

0

#### Bit Description

7-5 Reserved

4-0 GRANULARITY: The supported block size granularity. The device supports all block sizes  $n$  such that  $n$  minus the MINIMUM BLOCK LENGTH LIMIT is a multiple of  $2^{\text{GRANULARITY}}$  and  $n$  is greater than or equal to the MINIMUM BLOCK LENGTH LIMIT and less than or equal to the MAXIMUM BLOCK LENGTH LIMIT.

1-3 MAXIMUM BLOCK LENGTH LIMIT: 80 0000h (8,388,608 bytes) block length limit length limits

4-5 MINIMUM BLOCK LENGTH LIMIT: 0001h (1 byte) minimum block length limit

Any block length in the range of MINIMUM BLOCK LENGTH LIMIT to MAXIMUM BLOCK LENGTH LIMIT is supported.

NOTE 15 - The value reported in the MAXIMUM BLOCK LENGTH LIMIT field is the maximum block length when there is at least one encrypted logical block on the volume. When there are no encrypted logical blocks on the volume

a larger block length is allowed but not reported. This difference in maximum block length allowed has the potential to create confusion. Because of that, it is recommended that users limit their maximum block length to the values reported.

Data Transfer, Block Limits, and Fixed Block Option (see 4.11 on page 47) provides further explanation.

### 5.2.17.2 READ BLOCK LIMITS maximum logical object identifier data

The READ BLOCK LIMITS maximum logical object identifier data (see table 79) specifies the maximum value of the logical object identifier the logical unit supports.

**Table 79 — READ BLOCK LIMITS maximum logical object identifier data**

Byte	Bit								
	7 msb	6	5	4	3	2	1	0 lsb	
0	Reserved								
...									
11									
12	(MSB)	MAXIMUM LOGICAL OBJECT IDENTIFIER							
...									
19									(LSB)

The following parameters apply to the Read Block Limits maximum logical object identifier data:

#### Byte Description

0-11 Reserved

12-19 MAXIMUM LOGICAL OBJECT IDENTIFIER: The maximum value the device server supports in a logical object identifier field. This field is set to 0000\_0000\_FFFF\_FFFFh.

NOTE 16 - The drive establishes early warning at a constant number of blocks prior to the MAXIMUM LOGICAL OBJECT IDENTIFIER. At the time this document was published, the drive assumes a block size of 32 KiB for these calculations, but this may change at any time. Additionally, programmable early warning, if configured, is returned prior to the early warning value using an assumed block size of 32 KiB.

### 5.2.18 READ BUFFER - 3Ch

The Read Buffer command is defined in SPC (see the latest version at [http://www.t10.org/drafts.htm#SCSI3\\_CMNDSETS](http://www.t10.org/drafts.htm#SCSI3_CMNDSETS)). This clause describes the specific implementation.

**Table 80 — READ BUFFER CDB**

Byte	Bit								
	7 msb	6	5	4	3	2	1	0 lsb	
0	OPERATION CODE (3Ch)								
1	Obsolete (LUN)				MODE				
2	BUFFER ID								
3	(MSB)	BUFFER OFFSET							
5									(LSB)
6	(MSB)	ALLOCATION LENGTH							
8									(LSB)
9	Control Byte (see 5.1.2.3)								

The following parameters apply:

- MODE:
  - Value – Description**
  - MODE [00h] – Combined header and data (see 6.7.1.1 on page 421)
  - MODE [02h] – Data (see 6.7.1.2 on page 421)
  - MODE [03h] (RB) – Descriptor (see 6.7.1.3 on page 422)
  - MODE [07h] (RB) – Descriptor with algorithmic offset boundary (see 6.7.1.8 on page 423)
  - MODE [0Ah] – Echo buffer (see 6.7.1.9 on page 423)
  - MODE [0Bh] (RB) – Echo buffer descriptor (see 6.7.1.10 on page 423)
  - MODE [1Ch] (RB) – Error history (see 6.7.1.13 on page 424)
- buffer id: The supported buffers are described in Supported Buffers (see 6.7.2 on page 425).
- BUFFER OFFSET: See the description of each mode for the details of this field.

NOTE 17 - If the BUFFER OFFSET is not on the boundary specified in 6.7.2 on page 425, then the device returns CHECK CONDITION status with associated sense data of 5/2400 (Illegal Request, Invalid Field in CDB).

- ALLOCATION LENGTH: The maximum number of bytes to be transferred starting at the offset specified in BUFFER OFFSET.

The device transfers the number of bytes specified in the ALLOCATION LENGTH field or the number of bytes in the header or buffer being read, whichever is less. This is not an error. The host may use MODE 03h to query the amount of data in the specified buffer prior to reading such data with MODE 02h.

Each buffer image has its own unique format, describing where certain key data may be found. Certain buffers contain embedded data in the buffer image describing the length of the total buffer image, and a CRC field that checks the total buffer image. Uploading the microcode buffer is one such example.

### 5.2.19 READ DYNAMIC RUNTIME ATTRIBUTE - A3h[1Eh] or D1h

The READ DYNAMIC RUNTIME ATTRIBUTE command has a legacy format shown in table 81 and the standardized format shown in table 82.

**Table 81 — READ DYNAMIC RUNTIME ATTRIBUTE CDB (legacy)**

Bit Byte	7	6	5	4	3	2	1	0
0	OPERATION CODE (D1h)							
1	Reserved			SERVICE ACTION				
2	FIRST DYNAMIC RUNTIME ATTRIBUTE IDENTIFIER							
3	FIRST DYNAMIC RUNTIME ATTRIBUTE IDENTIFIER							
4	LAST DYNAMIC RUNTIME ATTRIBUTE IDENTIFIER							
5	LAST DYNAMIC RUNTIME ATTRIBUTE IDENTIFIER							
6	(MSB)	ALLOCATION LENGTH						(LSB)
...	ALLOCATION LENGTH							
9	ALLOCATION LENGTH							
10	Reserved							
11	Control							

**Table 82 — READ DYNAMIC RUNTIME ATTRIBUTE CDB (standardized)**

Bit Byte	7	6	5	4	3	2	1	0
0	OPERATION CODE (A3h)							
1	ATTRIBUTE REPORT TYPE			SERVICE ACTION (1Eh)				



Table 82 — READ DYNAMIC RUNTIME ATTRIBUTE CDB (standardized)

Bit Byte	7	6	5	4	3	2	1	0
2	FIRST DYNAMIC RUNTIME ATTRIBUTE IDENTIFIER							
3								
4	LAST DYNAMIC RUNTIME ATTRIBUTE IDENTIFIER							
5								
6	(MSB)							
...	ALLOCATION LENGTH							
9								(LSB)
10	Reserved							
11	Control							

The format of parameter data returned by the READ DYNAMIC RUNTIME ATTRIBUTE command depends on the SERVICE ACTION for the legacy D1h command or the ATTRIBUTE REPORT TYPE for the standardized A3h[1Eh] command as specified in table 83.

The FIRST DYNAMIC RUNTIME ATTRIBUTE IDENTIFIER field specifies the dynamic runtime attribute identifier of the first attribute to be returned. Only attributes with a dynamic runtime attribute identifier greater than or equal to the value specified in the FIRST DYNAMIC RUNTIME ATTRIBUTE IDENTIFIER field and that are not in the nonexistent or unsupported state shall be reported. It shall not be considered an error if the specified dynamic runtime attribute is in the unsupported or nonexistent state.

The LAST DYNAMIC RUNTIME ATTRIBUTE IDENTIFIER field specifies the dynamic runtime attribute identifier of the last attribute to be returned. Only attributes with a dynamic runtime attribute identifier less than or equal to the value specified in the LAST DYNAMIC RUNTIME ATTRIBUTE IDENTIFIER field and that are not in the nonexistent or unsupported state shall be reported. It shall not be considered an error if the specified dynamic runtime attribute is in the unsupported or nonexistent state. If the attribute identifier specified in the LAST DYNAMIC RUNTIME ATTRIBUTE IDENTIFIER field is less than the attribute identifier specified in the FIRST DYNAMIC RUNTIME ATTRIBUTE IDENTIFIER field, then the command shall be terminated with CHECK CONDITION status, with the sense key set to ILLEGAL REQUEST, and the additional sense code set to INVALID FIELD IN CDB.

If the ALLOCATION LENGTH specified causes an attribute to be truncated this shall not be considered an error. All data up to the allocation length shall be returned.

### 5.2.19.1 READ DYNAMIC RUNTIME ATTRIBUTE Service Action

The actions defined for the READ DYNAMIC RUNTIME ATTRIBUTE command are shown in Table 83.

**Table 83 — READ DYNAMIC RUNTIME ATTRIBUTE Service Action codes**

Standardized (OPERATION CODE A3h[1Eh])	Legacy (OPERATION CODE D1h)	Name	Description	Ref
ATTRIBUTE REPORT TYPE	SERVICE ACTION			
000b	00h	SUPPORTED ATTRIBUTES	Return a list of dynamic runtime attribute identifiers that the device server supports. No indication of attribute state is implied.	5.2.19.2
001b	10h	ATTRIBUTE VALUES FOR THIS I_T NEXUS	Return values for: <ul style="list-style-type: none"> <li>a) all logical unit type attributes;</li> <li>b) all target type attributes associated with the I_T nexus through which the command was received; and</li> <li>c) all initiator type attributes associated with the I_T nexus through which the command was received.</li> </ul>	5.2.19.3
010b	11h	ATTRIBUTE VALUES FOR ALL I_T NEXUSES	Return values for: <ul style="list-style-type: none"> <li>a) all logical unit type attributes;</li> <li>b) all target type attributes associated with all I_T nexuses; and</li> <li>c) all initiator type attributes associated with all I_T nexuses.</li> </ul>	5.2.19.4
others		Reserved		

### 5.2.19.2 SUPPORTED ATTRIBUTES service action

The READ DYNAMIC RUNTIME ATTRIBUTE command with SUPPORTED ATTRIBUTES selected (SERVICE ACTION field set to 00h in legacy command or ATTRIBUTE REPORT TYPE set to 000b in standardized command) returns parameter data containing the attribute identifiers that the device server supports. The returned

parameter data shall contain the requested attribute identifiers in ascending numerical order by attribute identifier and in the format shown in Table 84.

**Table 84 — READ DYNAMIC RUNTIME ATTRIBUTE with SUPPORTED ATTRIBUTES service action parameter list format**

Bit Byte	7	6	5	4	3	2	1	0
0	ATTRIBUTE REPORT TYPE			SERVICE ACTION				
1	Reserved							
...								
3								
4	AVAILABLE DATA (n-7)							
...								
7								
	Attribute Identifiers							
8	Attribute Identifier 0							
9								
	Attribute Identifier x							
n-1								
n								

The SERVICE ACTION field and ATTRIBUTE REPORT TYPE field shall contain the values shown in table 85

**Table 85 — Byte one of the parameter list data**

Field	Legacy command	Standardized command
SERVICE ACTION	The value of the SERVICE ACTION field in the CDB	00h
ATTRIBUTE REPORT TYPE	000b	The value of the ATTRIBUTE REPORT TYPE field in the CDB

The AVAILABLE DATA field shall contain the number of bytes of attribute identifiers in the parameter list. The AVAILABLE DATA field shall not be adjusted by the CDB ALLOCATION LENGTH field.

An attribute identifier is returned for each attribute that the device server supports. No indication of the current state of the reported attributes is made. See 6.1.2 for a description of the attribute identifier.

### 5.2.19.3 ATTRIBUTE VALUES FOR THIS I\_T NEXUS service action

The READ DYNAMIC RUNTIME ATTRIBUTE command with ATTRIBUTE VALUES FOR THIS I\_T NEXUS selected (SERVICE ACTION field set to 10h in legacy command or ATTRIBUTE REPORT TYPE set to 001b in standardized command) returns parameter data containing the attributes for the I\_T\_L Nexus through which this command is received starting with the FIRST ATTRIBUTE IDENTIFIER field in the CDB and ending with the LAST ATTRIBUTE IDENTIFIER field in the CDB.

The returned parameter data shall contain the requested attributes in in the format shown in table 86 and in ascending numerical order by I\_T nexus index then attribute identifier

**Table 86 — READ DYNAMIC RUNTIME ATTRIBUTE with ATTRIBUTE VALUES FOR THIS I\_T NEXUS service action parameter list format**

Bit Byte	7	6	5	4	3	2	1	0
0	ATTRIBUTE REPORT TYPE			SERVICE ACTION				
1	Reserved							
...								
3								
4	AVAILABLE DATA (n-7)							
...								
7								
	Attribute(s)							
8	Attribute 0 (see 6.1.1)							
...								
...	Attribute x (see 6.1.1)							
n								

The SERVICE ACTION field and ATTRIBUTE REPORT TYPE field shall contain the values shown in table 85

**Table 87 — Byte one of the parameter list data**

Field	Legacy command	Standardized command
SERVICE ACTION	The value of the SERVICE ACTION field in the CDB	00h
ATTRIBUTE REPORT TYPE	000b	The value of the ATTRIBUTE REPORT TYPE field in the CDB

The AVAILABLE DATA field shall contain the number of bytes of attribute information in the parameter list. The value in the AVAILABLE DATA field shall not be adjusted by the CDB ALLOCATION LENGTH field.

The format of the attributes is described in 6.1.1.

#### 5.2.19.4 ATTRIBUTE VALUES FOR ALL I\_T NEXUSES service action

The READ DYNAMIC RUNTIME ATTRIBUTE command with ATTRIBUTE VALUES FOR ALL I\_T NEXUSES service action (i.e., the SERVICE ACTION field set to 11h) returns parameter data containing the attributes for all known I\_T nexuses and starting with the FIRST ATTRIBUTE IDENTIFIER field in the CDB and ending with the LAST ATTRIBUTE IDENTIFIER field in the CDB.

The returned parameter data shall contain the requested attribute values for all I\_T nexus in ascending numerical order by I\_T nexus index then attribute identifier and in the format shown in table 88.

**Table 88 — READ DYNAMIC RUNTIME ATTRIBUTE with ATTRIBUTE VALUES FOR ALL I\_T NEXUSES service action parameter list format**

Bit Byte	7	6	5	4	3	2	1	0
0	ATTRIBUTE REPORT TYPE			SERVICE ACTION				
1	Reserved							
...								
3								
4	AVAILABLE DATA (n-7)							
...								
7								
	Attribute(s)							
8	Attribute 0 (see 6.1.1)							
...								
	Attribute x (see 6.1.1)							
...								
n								

The SERVICE ACTION field and ATTRIBUTE REPORT TYPE field shall contain the values shown in table 85

**Table 89 — Byte one of the parameter list data**

Field	Legacy command	Standardized command
SERVICE ACTION	The value of the SERVICE ACTION field in the CDB	00h
ATTRIBUTE REPORT TYPE	000b	The value of the ATTRIBUTE REPORT TYPE field in the CDB

The AVAILABLE DATA field shall contain the number of bytes to follow. The value in the AVAILABLE DATA field shall not be adjusted by the CDB ALLOCATION LENGTH field.

The format of the attributes is described in 6.1.1.

**5.2.20 READ END OF WRAP POSITION - A3h[1Fh][45h]**

The READ END OF WRAP POSITION command reports the logical position(s) at the end of wrap(s). The logical position reported for the wrap in which EOD exists is the logical position of EOD. The return data is valid at load. The data becomes stale on any write operation.

**Table 90 — READ END OF WRAP POSITION CDB**

Byte	Bit							
	7 msb	6	5	4	3	2	1	0 lsb
0	OPERATION CODE (A3h)							
1	Reserved			SERVICE ACTION (1Fh)				

Table 90 — READ END OF WRAP POSITION CDB

Byte	Bit							
	7 msb	6	5	4	3	2	1	0 lsb
2	SERVICE ACTION QUALIFIER (45h)							
3	Reserved						RA	WNV
4	<b>(MSB)</b>							
5	WRAP NUMBER							
6	<b>(LSB)</b>							
6	<b>(MSB)</b>							
9	ALLOCATION LENGTH							
9	<b>(LSB)</b>							
10	Reserved							
11	Control Byte (see 5.1.2.3)							

The following parameters apply:

- RA (Report All):
 

Value	Description
0b	Requests the parameter data be returned using the REOWP short form parameter data (see 5.2.20.1). The parameter data is populated per the settings of the WNV bit and the WRAP NUMBER field.
1b	Requests the parameter data be returned using the REOWP long form parameter data (see 5.2.20.2). The logical position at the end of each wrap containing user data is reported. If the WNV bit is set to one, then the command is terminated with CHECK CONDITION status with the sense key set to ILLEGAL REQUEST and the additional sense code set to INVALID FIELD IN CDB.
- WNV (Wrap Number Valid): Specifies if the request is for the first wrap or is for a non-zero wrap number.
 

Value	Description
0b	Requests the logical position at the end of the first wrap on the tape for the current partition be reported. If the WRAP NUMBER field is not set to 00h, then the command shall be terminated with CHECK CONDITION status with the sense key set to ILLEGAL REQUEST and the additional sense code set to INVALID FIELD IN CDB.
1b	Requests the logical position at the end of the wrap specified in the WRAP NUMBER field be reported.
- WRAP NUMBER: The wrap for which the end of wrap position is requested. If the WNV bit is set to one and the WRAP NUMBER field is set to 00h or the WRAP NUMBER field is set to a wrap that does not contain user data, then the command is terminated with CHECK CONDITION status with the sense key set to ILLEGAL REQUEST and the additional sense code set to INVALID FIELD IN CDB.

### 5.2.20.1 REOWP Short form parameter data

The REOWP short form parameter data format is shown in table 91.

Table 91 — REOWP short form parameter data format

Byte	Bit								
	7 msb	6	5	4	3	2	1	0 lsb	
0	(MSB)	RESPONSE DATA LENGTH (0008h)							
1							(LSB)		
2	Reserved								
3									
4	(MSB)	LOGICAL OBJECT IDENTIFIER							
9							(LSB)		

#### Byte Description

- 0-1 RESPONSE DATA LENGTH: The number of bytes to follow.
- 2-3 Reserved
- 4-9 LOGICAL OBJECT IDENTIFIER: The logical object identifier of the object at the end of the wrap requested by the WNV bit and the WRAP NUMBER field.

### 5.2.20.2 REOWP Long form parameter data

The REOWP long form parameter data format is shown in table 92.

Table 92 — REOWP long form parameter data format

Byte	Bit								
	7 msb	6	5	4	3	2	1	0 lsb	
0	(MSB)	RESPONSE DATA LENGTH (n-1)							
1							(LSB)		
2	Reserved								
3									
Wrap descriptor list									
4	Wrap descriptor [first]								
15									
Wrap descriptor [last]									
n-11	Wrap descriptor [last]								
n									

#### Byte Description

- 0-1 RESPONSE DATA LENGTH: The number of bytes to follow.
- 2-3 Reserved
- 4-n Wrap descriptor list: A list of Wrap descriptors for each wrap on all partitions that contains user data. The Wrap descriptor is defined in Wrap descriptor (see 5.2.20.2.1 on page 122).

### 5.2.20.2.1 Wrap descriptor

A wrap descriptor describes the logical location at the end of a wrap. The wrap descriptor format is shown in table 93.

**Table 93 — REOWP Wrap descriptor format**

Byte	Bit							
	7 msb	6	5	4	3	2	1	0 lsb
0	(MSB)							
1	WRAP NUMBER							(LSB)
2	(MSB)							
3	PARTITION							(LSB)
4	Reserved							
5	Reserved							
6	(MSB)							
11	LOGICAL OBJECT IDENTIFIER							(LSB)

#### Byte Description

- 0-1 WRAP NUMBER: The wrap number associated with this information.
- 2-3 PARTITION: The partition number of the wrap specified in the WRAP NUMBER field.
- 4-5 Reserved
- 6-11 LOGICAL OBJECT IDENTIFIER: The logical object identifier of the logical object at the end of the wrap specified in the WRAP NUMBER field.

### 5.2.21 READ LOGGED-IN HOST TABLE - A3h[1Fh][01h]

The READ LOGGED-IN HOST TABLE command (see table 94) requests information about hosts that are logged-in to the tape drive's primary interfaces.

**Table 94 — READ LOGGED-IN HOST TABLE CDB**

Byte	Bit							
	7	6	5	4	3	2	1	0
0	OPERATION CODE (A3h)							
1	Reserved			SERVICE ACTION (1Fh)				
2	SERVICE ACTION QUALIFIER (01h)							
3	Reserved				REPORT TYPE			
4	Reserved							
5	Reserved							
6	(MSB)							
9	ALLOCATION LENGTH							(LSB)
10	Reserved							
11	CONTROL							



The following parameters apply:

- REPORT TYPE: Indicates which type of report is requested
 

Code	Description
000b	Return all entries
001b	Return only those entries that have changed since last retrieval of the Logged-In Host Table by this I_T nexus.
010b	Return descriptor only for Active Host. The Active Host is defined as the host which most recently performed a medium access command. No Logged-In Host Descriptor is returned if there is not an Active Host.
others	Reserved
- ALLOCATION LENGTH: The maximum number of bytes to be returned.

**5.2.21.1 READ LOGGED-IN HOST TABLE parameter data**

The parameter data returned to a READ LOGGED-IN HOST command has the format shown in table 95.

**Table 95 — READ LOGGED-IN HOST TABLE parameter data format**

Byte	Bit							
	7	6	5	4	3	2	1	0
0	(MSB)							
3	DATA LENGTH (n-3)						(LSB)	
4	Logged-In Host Descriptor [first]							
31								
	:							
	Logged-In Host Descriptor [last]							
n								

**Byte Description**

- 0-3 DATA LENGTH: The number of bytes to follow
- 4-n Logged-In Host Descriptors: Zero to n Logged-In Host Descriptors.

### 5.2.21.1.1 Logged-In Host Descriptor

A logged-in host descriptor describes information about an I\_T nexus through which a host is logged in. The format of a logged-in host descriptor is shown in table 96.

**Table 96 — Logged-In Host Descriptor format**

Byte	Bit							
	7	6	5	4	3	2	1	0
0	WWNN							
7								
8	WWPN							
15								
16	SOURCE ID							
19								
20	LOGIN TIME							
25								
26	Reserved	Vendor-Reserved				PHY PORT		
27	HOST ID							
28								
29	PRIMARY PORT INDEX							
30	Reserved							
31								

#### Byte Description

0-7 wwnn (World Wide Node Name): The WWNN of the initiator port associated with the logged-in I\_T nexus.

8-15 wwpn (World Wide Port Name): The WWPN of the initiator port associated with the logged-in I\_T nexus.

16-19 SOURCE ID:

For Fibre Channel connected devices, the source identifier of the logged-in I\_T nexus.

For SAS connected devices, the hashed SAS address of the initiator.

20-25 LOGIN TIME: Timestamp in milliseconds as initialized by the SET TIMESTAMP command most recently received before this command.

For Fibre Channel connected devices, the timestamp when this I\_T nexus completed its PLOGI process.

For SAS connected devices, the timestamp when the first command was received through this I\_T nexus.

26

#### Bit Description

7-6 Reserved

5-2 Vendor-Reserved

1-0 PHY PORT: Physical target port associated with this I\_T nexus

#### Code Description

00b Port A (port 0)

01b Port B (port 1)

others Reserved

27-28 HOST ID: Logged-in host's index in the Logged-In Host Table.

29 PRIMARY PORT INDEX: The relative target port value of the target port associated with the I\_T nexus.

Code	Description
0h	Reserved
1h	Relative Tgt Port 1 (Port 0)
2h	Relative Tgt Port 2 (Port 1)
others	Reserved

30-31 Reserved

## 5.2.22 READ POSITION - 34h

### 5.2.22.1 READ POSITION command description

The Read Position command is defined in SSC (see the latest version at [http://www.t10.org/drafts.htm#SCSI3\\_CMNDSETS](http://www.t10.org/drafts.htm#SCSI3_CMNDSETS)). This clause describes the specific implementation.

The READ POSITION command (see table 97) reports the current position and provides information about logical objects contained in the object buffer. No medium movement shall occur as a result of responding to the command.

**Table 97 — READ POSITION CDB**

Byte	Bit							
	7 msb	6	5	4	3	2	1	0 lsb
0	OPERATION CODE (34h)							
1	Reserved				SERVICE ACTION			
2	Reserved							
6	Reserved							
7	(MSB)	ALLOCATION LENGTH						(LSB)
8	Control Byte (see 5.1.2.3)							
9	Control Byte (see 5.1.2.3)							

The following parameters apply:

- SERVICE ACTION:

Value	Description
00h	SHORT FORM-- BLOCK ID: Device server shall return 20 bytes of data with the FIRST LOGICAL OBJECT LOCATION and LAST LOGICAL OBJECT LOCATION fields as logical object identifier values, relative to a partition (see 5.2.22.2). The ALLOCATION LENGTH field shall be zero.
06h	LONG FORM: Device server shall return 32 bytes of data (see 5.2.22.3). The ALLOCATION LENGTH field shall be zero.
08h	EXTENDED FORM: Device server shall return 32 bytes of data up to the maximum length specified by the ALLOCATION LENGTH field (see 5.2.22.4).
others	The command is terminated with CHECK CONDITION status with the sense key set to ILLEGAL REQUEST, and the additional sense code set to INVALID FIELD IN CDB.

- ALLOCATION LENGTH: Length of the data to return. Shall be set to 0000h if the SERVICE ACTION field is set to 00h or 06h.

### 5.2.22.2 READ POSITION data format, short form

Table 98 specifies the READ POSITION data that shall be returned if the SERVICE ACTION field is 00h.

The short form is included for legacy applications. It is highly recommended that the LONG FORM (06h) (see 5.2.22.3) or the EXTENDED FORM (08h) (see 5.2.22.4) be used instead.

**WARNING****WARNING**

The short form breaks when there are greater than  $2^{32}$  logical objects on medium and may become obsolete in the future.

**WARNING****WARNING****Table 98 — READ POSITION data format, short form**

Byte	Bit							
	7 msb	6	5	4	3	2	1	0 lsb
0	Position information/validity							
	BOP	EOP	LOCU	BYCU (1)	Rsvd	LOLU (0)	PERR	BPEW
1	PARTITION NUMBER							
2	Reserved							
3	Reserved							
4	(MSB)	FIRST LOGICAL OBJECT LOCATION						(LSB)
7								
8	(MSB)	LAST LOGICAL OBJECT LOCATION						(LSB)
11								
12	Reserved							
13	(MSB)	NUMBER OF LOGICAL OBJECTS IN OBJECT BUFFER						(LSB)
15								
16	(MSB)	NUMBER OF BYTES IN OBJECT BUFFER						(LSB)
19								

**Byte Description**

0 Position Information/Validity:

**Bit Description**

7 BOP (beginning of partition):

**Value****Description**

0b the current logical position is not at the beginning of partition.

1b the device is at the beginning of the current partition.

6 EOP (end of partition)

**Value****Description**

0b the device is not between early warning and end of partition.

1b the device is positioned between early warning and end of the current partition.

5 LOCU (logical object count unknown)

**Value****Description**

0b block count is exact

1b block count is an estimate

4 BYCU (byte count unknown)

**Value****Description**

0b byte count is exact

1b byte count is an estimate

3 Reserved

2 LOLU (logical object location unknown)

**Value****Description**

0b block position is exact

1b block position is an estimate

1 PERR (position error):

**Value****Description**

0b	An overflow has not occurred in any of the returned position data fields.
1b	An overflow has occurred in at least one of the returned position data fields. The application should use the LONG FORM (06h) (see 5.2.22.3) to obtain the current position or the application should use the EXTENDED FORM (08h) (see 5.2.22.4) to obtain the current position and number of bytes in the object buffer.
0	BPEW (beyond programmable early warning)
<b>Value</b>	<b>Description</b>
0b	The LOLU bit is set to one, the PEWS field of the MP 10h[01h]: Device Configuration Extension (see 6.6.12 on page 377) is set to zero, or the logical object location is not in a PEWZ or on the EOP side of EW.
1b	The logical object location is in a PEWZ or on the EOP side of EW.
1	PARTITION NUMBER: Reports the partition number for the current logical position. When the volume has only one partition, this field is set to 00h.
2-3	Reserved
4-7	FIRST LOGICAL OBJECT LOCATION: Specifies the logical object address associated with the current logical position, in the range 0000 0000h to FFFF FFFFh. The value indicates the logical object address of the next data block or filemark to be transferred between the initiator and the target if a READ or WRITE command is issued.
8-11	LAST LOGICAL OBJECT LOCATION: After a write command, this field specifies the logical object address associated with the next logical object to be transferred from the buffer to the medium, in the range 0000 0000h to FFFF FFFFh. After a read command, this field specifies the logical object address associated with the last (most recent) data block or filemark to be transferred from the medium to the buffer. For any case where the buffer no longer contains a whole block of data or is empty, the value reported for the LAST LOGICAL OBJECT LOCATION is equal to the value reported for the FIRST LOGICAL OBJECT LOCATION.
12	Reserved
13-15	NUMBER OF LOGICAL OBJECTS IN THE OBJECT BUFFER: The number of data blocks and filemarks in the buffer that have not been written to the medium. (This value is zero if the device is reading rather than writing.)
16-19	NUMBER OF BYTES IN THE OBJECT BUFFER: The total number of write data bytes (before compaction) in the buffer that have not been written to the medium.

## 5.2.22.3 READ POSITION data format, long form

Table 99 specifies the format of the READ POSITION data that shall be returned if the SERVICE ACTION field is 06h.

Table 99 — READ POSITION data format, long form

Byte	Bit							
	7 msb	6	5	4	3	2	1	0 lsb
0	Position information/validity							
	BOP	EOP	Reserved		MPU	LONU	Rsvd	BPEW
1	Reserved							
3	Reserved							
4	(MSB)	PARTITION NUMBER						(LSB)
7								
8	(MSB)	LOGICAL OBJECT NUMBER						(LSB)
15								
16	(MSB)	LOGICAL FILE IDENTIFIER						(LSB)
23								
24	(MSB)	Obsolete						(LSB)
31								

**Byte Description**

0 Position Information/Validity:

**Bit Description**

7 BOP (beginning of partition):

**Value****Description**

0b the current logical position is not at the beginning of partition.  
1b the device is at the beginning of the current partition.

6 EOP (end of partition)

**Value****Description**

0b the device is not between early warning and end of partition.  
1b the device is positioned between early warning and end of the current partition.

5-4 Reserved

3 MPU (mark position unknown)

**Value****Description**

0b the LOGICAL FILE IDENTIFIER field contains valid position information.  
1b the logical file identifier is not known or accurate reporting is not currently available.

2 LONU (logical object number unknown)

**Value****Description**

0b the LOGICAL OBJECT NUMBER and PARTITION NUMBER fields contain exact information.  
1b The logical object number is an estimate.

1 Rsvd (Reserved)

0 BPEW (beyond programmable early warning)

**Value****Description**

0b The LONU bit is set to one, the PEWS field in the MP 10h[01h]: Device Configuration Extension (see 6.6.12 on page 377) is set to zero, or the logical object location is not in a PEWZ or on the EOP side of EW.  
1b The logical object location is in a PEWZ or on the EOP side of EW.

- 1-3 Reserved
- 4-7 PARTITION NUMBER: The partition number for the current logical position.
- 8-15 LOGICAL OBJECT NUMBER: The number of logical objects between beginning-of-partition and the current logical position. A filemark counts as one logical object.
- 16-23 LOGICAL FILE NUMBER: The number of filemarks between beginning-of-partition and the current logical position. This value is the current logical file identifier.
- 24-31 Obsolete.

#### 5.2.22.4 READ POSITION data format, extended form

Table 100 specifies the format of the READ POSITION data that shall be returned if the SERVICE ACTION field is 08h.

**Table 100 — READ POSITION data format, extended form**

Byte	Bit							
	7 msb	6	5	4	3	2	1	0 lsb
0	Position information/validity							
	BOP	EOP	LOCU	BYCU (1)	Rsvd	LOLU (0)	PERR	BPEW
1	PARTITION NUMBER							
2	(MSB)	ADDITIONAL LENGTH (1Ch)						(LSB)
3								
4	Reserved							
5	(MSB)	NUMBER OF LOGICAL OBJECTS IN OBJECT BUFFER						(LSB)
7								
8	(MSB)	FIRST LOGICAL OBJECT LOCATION						(LSB)
15								
16	(MSB)	LAST LOGICAL OBJECT LOCATION						(LSB)
23								
24	(MSB)	NUMBER OF BYTES IN OBJECT BUFFER						(LSB)
31								

The fields are defined the same as for the corresponding fields in the READ POSITION data format, short form (see table 98).

The ADDITIONAL LENGTH field shall contain 1Ch. If the information transferred to the Data-In Buffer is truncated because of an insufficient ALLOCATION LENGTH value, the ADDITIONAL LENGTH field shall not be altered to reflect the truncation.

**Byte Description**

0 Position Information/Validity:

**Bit Description**

7 BOP (beginning of partition):

**Value Description**

0b the current logical position is not at the beginning of partition.

1b the device is at the beginning of the current partition.

6 EOP (end of partition)

**Value Description**

0b the device is not between early warning and end of partition.

1b the device is positioned between early warning and end of the current partition.

5 LOCU (logical object count unknown)

**Value Description**

0b block count is exact

1b block count is an estimate

4 BYCU (byte count unknown)

**Value Description**

0b byte count is exact

1b byte count is an estimate

3 Reserved

2 LOLU (logical object location unknown)

**Value Description**

0b block position is exact

1b block position is an estimate

1 PERR (position error):

**Value Description**

0b An overflow has not occurred in any of the returned position data fields.

1b An overflow has occurred in at least one of the returned position data fields.

0 BPEW (beyond programmable early warning)

**Value Description**

0b The LOLU bit is set to one, the PEWS field in MP 10h[01h]: Device Configuration Extension (see 6.6.12 on page 377) is set to zero, or the logical object location is not in a PEWZ or on the EOP side of EW.

1b The logical object location is in a PEWZ or on the EOP side of EW.

1 PARTITION NUMBER:

Reports the partition number for the current logical position. When the volume has only one partition, this field is set to 00h.

2-3 ADDITIONAL LENGTH: 1Ch

4 Reserved

5-7 NUMBER OF LOGICAL OBJECTS IN THE OBJECT BUFFER:

The number of data blocks and filemarks in the buffer that have not been written to the medium. (This value is zero if the device is reading rather than writing.)

8-15 FIRST LOGICAL OBJECT LOCATION:

Specifies the logical object address associated with the current logical position, in the range 0000 0000h to FFFF FFFFh. The value indicates the logical object address of the next data block or filemark to be transferred between the initiator and the target if a READ or WRITE command is issued.

16-23 LAST LOGICAL OBJECT LOCATION:

After a write command, this field specifies the logical object address associated with the next logical object to be transferred from the buffer to the medium, in the range 0000 0000h to FFFF FFFFh. After a read command, this field specifies the logical object address associated with the last (most recent) data



block or filemark to be transferred from the medium to the buffer. For any case where the buffer no longer contains a whole block of data or is empty, the value reported for the LAST LOGICAL OBJECT LOCATION is equal to the value reported for the FIRST LOGICAL OBJECT LOCATION.

24-31 NUMBER OF BYTES IN THE OBJECT BUFFER: The total number of write data bytes (before compaction) in the buffer that have not been written to the medium.

### 5.2.23 RECEIVE DIAGNOSTIC RESULTS - 1Ch

The Receive Diagnostic Results command is defined in SPC (see the latest version at [http://www.t10.org/drafts.htm#SCSI3\\_CMNDSETS](http://www.t10.org/drafts.htm#SCSI3_CMNDSETS)). This clause describes the specific implementation.

After a Send Diagnostic command completes, use the Receive Diagnostic Results command to receive the results.

As allowed by the SCSI standards, devices may implement Send Diagnostic and handle status and return information for diagnostics in somewhat different manners. To work correctly with all common variations, the following sequence should be used by the host.

The SEND DIAGNOSTIC command is issued. If a CHECK CONDITION status occurs, and a non-deferred permanent error results, then the test failed (or was not started if sense key=ILLEGAL REQUEST). If GOOD status is returned, then a RECEIVE DIAGNOSTICS RESULTS command should be issued, and:

- a) the “blocked” and “error” bit should be checked (byte 8, bits 2 and 0 respectively), and if either is set, the diagnostic was either not run or failed; and
- d) if byte 8 bit 1 is set, the SIM/MIM data in the results is valid and contains additional information relating to the failure

NOTE 18 - This process is required by this device to determine diagnostics results for those diagnostics which indicate diagnostics results data is returned. GOOD status returned from the Send Diagnostic only indicates that the diagnostic was accepted but does not indicate the ultimate result of its execution.

NOTE 19 - For diagnostics that produce diagnostic results, the device should be reserved using the Reserve or Persistent Reserve Out command to protect the results from actions of other initiators.

Table 101 shows the command format.

**Table 101 — RECEIVE DIAGNOSTIC RESULTS CDB**

Byte	Bit							
	7 msb	6	5	4	3	2	1	0 lsb
0	OPERATION CODE (1Ch)							
1	Obsolete			Reserved				
2	Reserved							
3	MSB	ALLOCATION LENGTH						LSB
4								
5	Control Byte (see 5.1.2.3)							

The following parameters apply:

- ALLOCATION LENGTH: The maximum number of bytes to be returned in the page of data following the command (if any).

Diagnostic Parameters (Diag) (see 6.2 on page 195) has a listing of all diagnostic parameters.

### 5.2.24 RECEIVE RECOMMENDED ACCESS ORDER (RRAO) - A3h[1Dh] (LTO9+)

The RECEIVE RECOMMENDED ACCESS ORDER (RRAO) command is used to retrieve a recommended access order of User Data Segments. Recommended access order (RAO) (LTO-9+ Full-Height) (see 4.6 on page 35) describes the purpose of the recommended access order.

After a GENERATE RECOMMENDED ACCESS ORDER (GRAO) command (see 5.2.4) completes, the RRAO command may be used to receive the results. The results are not cleared when read. See RAO usage (see 4.6.4 on page 37) for the recommended usage and for restrictions on the validity of the RAO list returned in this command.

Table 102 shows the command format.

**Table 102 — RECEIVE RECOMMENDED ACCESS ORDER CDB**

Byte	Bit							
	7 msb	6	5	4	3	2	1	0 lsb
0	OPERATION CODE (A3h)							
1	UDS_LIMITS	Reserved		SERVICE ACTION (1Dh)				
2	RAO LIST OFFSET							
...								
5								
6	MSB	ALLOCATION LENGTH						LSB
...								
9								
10	Reserved				UDS_TYPE			
11	Control Byte							

The following parameters apply:

- UDS\_LIMITS - Specifies if the UDS Limits page is to be returned or if the RAO parameter list is to be returned.

Value	Description
-------	-------------

0b	Return the RAO parameter list (see 5.2.24.1.2)
----	--

1b	Return the UDS Limits page using the settings of the other fields in the CDB to determine the values supported (see 5.2.24.1.1).
----	--

If this field is set to 1b, then the RAO LIST OFFSET field shall be set to zero. If the RAO LIST OFFSET field is not set to zero, then the command is terminated with CHECK CONDITION status with the Sense Key set to ILLEGAL REQUEST and the additional sense code set to INVALID FIELD IN CDB (i.e., 5/2400).

- RAO LIST OFFSET - The offset into the RAO list from which to begin returning data. This allows the RAO list to be retrieved in chunks. This value is required to be either zero or a value greater than or equal to eight and on a 4-byte boundary (i.e., 0 or 8+4n where  $n \geq 0$ ). If this value is not valid, the command is terminated with CHECK CONDITION status with the Sense Key set to ILLEGAL REQUEST and the additional sense code set to INVALID FIELD IN CDB (i.e., 5/2400).
- ALLOCATION LENGTH is the maximum number of bytes to be returned.
- UDS\_TYPE - If the UDS\_LIMITS bit is set to 1b, then this is the type of User Data Segment descriptor (see 5.2.4) to use in calculating the maximum number of UDS supported. If the UDS\_LIMITS bit is set to 0b, then this field is ignored.

### 5.2.24.1 RRAO parameter data

If the UDS\_LIMITS bit is set to 1b (i.e., return Maximum number of User Data Segments supported for these settings), then the RRAO parameter data is defined in 5.2.24.1.1. If the UDS\_LIMITS bit is set to 0b (i.e., return Recommended Access Order list), then the RRAO parameter data is defined in 5.2.24.1.2.

### 5.2.24.1.1 UDS Limits page

The parameter data received when the UDS\_LIMITS bit of the RRAO command is set to 1b (i.e., return UDS Limits page). This returns values supported for the requested setting of UDS\_TYPE and is defined in table 103.

**Table 103 — UDS Limits page**

Byte	Bit							
	7 msb	6	5	4	3	2	1	0 lsb
0	(MSB)	MAXIMUM UDS SUPPORTED						(LSB)
1		MAXIMUM UDS SIZE						(LSB)
2	(MSB)							
3								(LSB)

The following parameters apply:

#### Byte Description

- 0-1 MAXIMUM UDS SUPPORTED - This field specifies the maximum number of User Data Segments that the drive is capable of returning for the specified UDS TYPE.
- 2-3 MAXIMUM UDS SIZE - This field specifies the maximum size of the UDS descriptor (see 5.2.24.1.3) for the specified UDS TYPE.

### 5.2.24.1.2 RAO list

The parameter data received when the UDS\_LIMITS bit of the RRAO command is set to 0b (i.e., return Recommended Access Order list) is defined in table 104.

**Table 104 — RAO List**

Byte	Bit							
	7 msb	6	5	4	3	2	1	0 lsb
0	Reserved				PROCESS			
1	Reserved				STATUS			
2	Reserved							
3	Reserved							
4	(MSB)	ADDITIONAL DATA (n-7)						(LSB)
...								
7								
User Data Segment descriptors								
8	User Data Segment descriptor (first)							
x	:							
y	User Data Segment descriptor (last)							
n								

The following parameters apply:

**Byte Description**

0	<b>Bit</b>	<b>Description</b>
	7-3	Reserved
	2-0	PROCESS - Requested process to generate the contents of the RAO list (see 4.6.3)
1	<b>Bit</b>	<b>Description</b>
	7-3	Reserved
	2-0	STATUS - Status of the RAO list
	<b>Value</b>	<b>Description</b>
	000b	The RAO list does not contain a valid list (e.g., the GRAO command invalidated the list)
	001b	The RAO list contains a valid list generated using the process specified in the PROCESS field.
	010b	The RAO list contains a list matching the order of the list passed in the GRAO command but has not processed the list due to an inability to do so at this time. The ESTIMATED LOCATE TIME TO UDS field and any Additional information descriptors are present but do not contain valid data.
	others	Reserved.
2-3	Reserved	
4-7	ADDITIONAL DATA - This field specifies the amount of data to follow. If the RAO list is invalid (i.e., the STATUS field is 000b), then this field is set to zero.	
8-n	User Data Segment descriptors - A list of User Data Segments in the order specified by the last successful GRAO command (see 5.2.4). User Data Segments are defined in 5.2.24.1.3.	

### 5.2.24.1.3 User Data Segment descriptor

The User Data Segment descriptor is defined in table 105.

**Table 105 — User Data Segment descriptor (part 1 of 2)**

Byte	Bit							
	7 msb	6	5	4	3	2	1	0 lsb
0	(MSB) _____ UDS DESCRIPTOR LENGTH (n-1) _____ (LSB)							
1								
2	Reserved							
3	Reserved							
4	ESTIMATED LOCATE TIME TO UDS							
5								
...	UDS NAME _____							
14								
15	PARTITION NUMBER							
16	(MSB) _____							
...	BEGINNING LOGICAL OBJECT IDENTIFIER _____ (LSB)							
23								
24	(MSB) _____							
...	ENDING LOGICAL OBJECT IDENTIFIER _____ (LSB)							
31								

**Table 105 — User Data Segment descriptor (part 2 of 2)**

Byte	Bit							
	7 msb	6	5	4	3	2	1	0 lsb
Additional information descriptors								
32	Additional information descriptor (beginning)							
x								
⋮								
y	Additional information Geometry descriptor (ending)							
n								

The following parameters apply:

**Byte Description**

- 0-1 UDS DESCRIPTOR LENGTH - length of data to follow.
- 2 Reserved
- 3 Reserved
- 4 ESTIMATED LOCATE TIME TO UDS - An estimation of the nominal time in seconds required to change position:
  - a) if this is the first UDS in the parameter list, then from the current logical position to the BEGINNING LOGICAL OBJECT IDENTIFIER of this UDS; or
  - b) if this is not the first UDS in the parameter list, then from the ENDING LOGICAL OBJECT IDENTIFIER from the previous UDS descriptor to the BEGINNING LOGICAL OBJECT IDENTIFIER of this UDS.

This value is not guaranteed and may be affected by:

- a) read-ahead operations;
- b) application client behaviors;
- c) error recovery procedures; and
- d) other conditions.

If the time to position to this UDS is unknown, cannot be estimated, the STATUS field of the RAO list is set to 010b, or if the drive does not support ESTIMATED LOCATE TIME TO UDS then this field is set to zero.

If the time to position to this UDS is more than FEh seconds, then this field shall be set to FFh.

- 5-14 UDS NAME - Name given to this User Data Segment by the application
- 15 PARTITION NUMBER - Number of the partition in which this User Data Segment is located.
- 16-23 BEGINNING LOGICAL OBJECT IDENTIFIER - Logical object identifier of the beginning logical object of the User Data Segment.
- 24-31 ENDING LOGICAL OBJECT IDENTIFIER - Logical object identifier of the ending logical object of the User Data Segment.
- 32-n Additional information descriptors - Descriptors that describe additional information. Additional information descriptors are returned if the GRAO process selected requested that those descriptors be generated as part of the RAO list generation.

At the time this document was published, there is one geometry descriptor (see 5.2.24.1.3.1) that describes the geometry at the beginning logical object identifier and one geometry descriptor that describes the geometry at the ending logical object identifier.

### 5.2.24.1.3.1 Additional information descriptor

Additional information descriptors are used to provide additional information related to the UDS, such as its' geometry (see 5.2.24.1.3.1). The additional information descriptor is defined in table 106.

**Table 106 — Additional information descriptor**

Byte	Bit							
	7 msb	6	5	4	3	2	1	0 lsb
0	(MSB) _____							
1	ADDITIONAL INFORMATION DESCRIPTOR LENGTH							(LSB)
2	ADDITIONAL INFORMATION TYPE							
3	DIR	Reserved					BAND	
4	(MSB) _____							
...	RPOS							_____
7								(LSB)
8	WRAP _____							
9								

The following parameters apply:

#### Byte Description

0-1 ADDITIONAL INFORMATION DESCRIPTOR LENGTH - Number of additional bytes that follow in the additional information descriptor. Applications should check this length and if it is longer than expected, then use the bytes and fields understood and skip any extra bytes that are not understood. Growth may occur in the descriptor if new items are requested or found useful.

2 ADDITIONAL INFORMATION TYPE - The type of additional information descriptor.

#### Value Description

00h Begin Point Geometry - Describes the geometry of the logical object pointed to by the BEGINNING LOGICAL OBJECT IDENTIFIER field.

01h End Point Geometry - Describes the geometry of the logical object pointed to by the ENDING LOGICAL OBJECT IDENTIFIER field.

NOTE 20 - No assumption should be made about the geometry of the data between the Begin Point Geometry and the End Point Geometry since the order of wrap traversal may be non-sequential.

others Reserved for future use.

3 Flags

#### Bit Description

7 DIR - The direction of medium travel for the logical object. If the STATUS field of the RAO list (see 5.2.24.1.2) is set to 010b, then this field is set to zero.

#### Value Description

0b Forward direction (i.e., from BOT to EOT)

1b Backward direction (i.e., from EOT to BOT)

6-2 Reserved

1-0 BAND - The band in which the logical object is recorded. If the STATUS field of the RAO list (see 5.2.24.1.2) is set to 010b, then this field is set to zero.

4-7 RPOS - Estimated relative longitudinal position (in mm) of the logical object pointed to by the LOGICAL OBJECT IDENTIFIER RELATIVE TO THE EARLIEST PHYSICAL RECORDING START (i.e. LP3). This is the distance between LP3 and the logical block expressed in millimeters. If the STATUS field of the RAO list (see 5.2.24.1.2) is set to 010b, then this field is set to zero.

8-9 WRAP - Physical wrap in which the LOGICAL OBJECT IDENTIFIER is located. If the STATUS field of the RAO list (see 5.2.24.1.2) is set to 010b, then this field is set to zero.

### 5.2.25 RELEASE UNIT (6/10)- 17h/57h

The Release Unit command is defined in SPC-2 (see <http://www.t10.org/cgi-bin/ac.pl?t=f&f=spc2r20.pdf>). This clause describes the specific implementation.

**Table 107 — RELEASE UNIT (6) CDB**

Byte	Bit							
	7 msb	6	5	4	3	2	1	0 lsb
0	OPERATION CODE (17h)							
1	Obsolete				Obsolete (00h)			
2	Obsolete							
3	Reserved							
4	Reserved							
5	Control Byte (see 5.1.2.3)							

The following parameters apply:

- Obsolete: All obsolete fields shall be set to zero.

**Table 108 — RELEASE UNIT (10) CDB**

Byte	Bit							
	7 msb	6	5	4	3	2	1	0 lsb
0	OPERATION CODE (57h)							
1	Reserved			3RDPTY	Reserved		LONGID	Obsolete
2	Obsolete							
3	THIRD PARTY DEVICE ID							
4	Reserved							
5	Reserved							
6	Reserved							
7	Reserved							
8	PARAMETER LIST LENGTH							
9	Control Byte (see 5.1.2.3)							

The following parameters apply:

- Obsolete: All obsolete fields shall be set to zero.
- LONGID: 0b
- 3RDPTY: 0b
- THIRD PARTY DEVICE ID: 00h
- PARAMETER LIST LENGTH: 0000h

## 5.2.26 REPORT DENSITY SUPPORT - 44h

The Report Density Support command is defined in SSC (see the latest version at [http://www.t10.org/drafts.htm#SCSI3\\_CMNDSETS](http://www.t10.org/drafts.htm#SCSI3_CMNDSETS)). This clause describes the specific implementation.

**Table 109 — REPORT DENSITY SUPPORT CDB**

Byte	Bit								
	7 msb	6	5	4	3	2	1	0 lsb	
0	OPERATION CODE (44h)								
1	Reserved							MEDIA	
2	Reserved								
6	Reserved								
7	MSB	ALLOCATION LENGTH						LSB	
8	Control Byte (see 5.1.2.3)								
9	Control Byte (see 5.1.2.3)								

The following parameters apply:

- MEDIA:
 

Value	Description
0b	report all supported densities for all supported medium types
1b	report all supported densities for the current medium in the drive. If the device is not ready, the drive will return 2/0400h (NOT READY, NOT READY CAUSE NOT REPORTABLE).
- ALLOCATION LENGTH: The maximum number of bytes to be transferred.

### 5.2.26.1 Report Density Support data format

#### 5.2.26.1.1 Density descriptor overview

Density descriptors contain information that may be returned by the drive. While the information is reported in a manner useful to applications, SSC specifies fields that have been found to not be useful by applications in selecting which density to use. Instead applications have been found to ignore the BITS PER MM field and the TRACKS field. This device does not change the values returned in these fields by the format type – media type combinations and instead returns the largest value for the set of supported format type media type combinations. The CAPACITY field is used by applications and does report values based on the format type – media type combinations. The DENSITY CODE fields, the ASSIGNING ORGANIZATION field, the DENSITY NAME field, and the DESCRIPTION field are constant per density and are correctly reported.

This device may return different combinations of the descriptors in the REPORT DENSITY SUPPORT data depending on drive generation, medium loaded, setting of the MEDIA bit, and settings of various mode parameters related to densities.

In LTO-8 drives, if the MEDIA bit is set to one and a volume is mounted, the REPORT DENSITY SUPPORT data may contain a number of different descriptors due to support of creating an Ultrium 7 Type M cartridge (i.e., M8) out of an Ultrium 7 cartridge. The potential combinations are:

- a) **L7 volume:**
  - a single descriptor indicating the “U-732 “ density (i.e., 5Ch) (see table 113) with the WRTOk bit set to 1b and the DEFLT bit set to 1b, if the volume is an Ultrium 7 Type A cartridge (see 2.1.254) and:
    - A) the cartridge is not Type M eligible (see 2.1.256); or
    - B) the Preferred Cartridge Type for an Ultrium 7 volume is Type A cartridge;
- b) **M8 capable Ultrium 7 cartridge; drive configured by library to make L7 volume:**
  - two descriptors, the first indicating the “U-732 “ density (i.e., 5Ch) with the WRTOk bit set to 1b and the



DEFLT bit set to 1b, and the second indicating the "U-832M " density (i.e., 5Dh) (see table 113) with the WR TOK bit set to 1b and the DEFLT bit set to 0b, if:

- A) the volume is an Ultrium 7 Type A cartridge;
  - B) the cartridge is Type M eligible (see 2.1.256); and
  - C) the Preferred Cartridge Type for an Ultrium 7 volume is Type A cartridge;
- c) **M8 capable Ultrium 7 cartridge; drive configured by library to make M8 volume:**  
two descriptors, the first indicating the "U-732 " density (i.e., 5Ch) with the WR TOK bit set to 1b and the DEFLT bit set to 0b, and the second indicating the "U-832M " density (i.e., 5Dh) (see table 113) with the WR TOK bit set to 1b and the DEFLT bit set to 1b, if:
- A) the volume is an Ultrium 7 Type A cartridge;
  - B) the cartridge is Type M eligible (see 2.1.256); and
  - C) the Preferred Cartridge Type for an Ultrium 7 volume is Type M cartridge (see 2.1.255);
- d) **M8 volume:**  
a single descriptor indicating the "U-832M " density (i.e., 5Dh) with the WR TOK bit set to 1b and the DEFLT bit set to 1b, if the volume is a Type M cartridge;
- or
- e) **L8 volume:**  
a single descriptor indicating the "U-832 " density (i.e., 5Eh) (see table 113) with the WR TOK bit set to 1b and the DEFLT bit set to 1b, if the volume is an Ultrium 8 Type A cartridge (see 2.1.254).

In other generation drives, there is one descriptor per generation cartridge.

The Report Density Support data format is shown in table 110.

**Table 110 — REPORT DENSITY SUPPORT data format**

Byte	Bit								
	7	6	5	4	3	2	1	0	
0	(MSB)	AVAILABLE DENSITY SUPPORT LENGTH						(LSB)	
1									
2	Reserved								
3	Reserved								
Density support data block descriptors									
4	Density support data block descriptor [first]								
⋮									
n	Density support data block descriptor [last]								

The Density support data block descriptor format is shown in table 111.

**Table 111 — Density support data block descriptor format**

Byte	Bit							
	7	6	5	4	3	2	1	0
0	PRIMARY DENSITY CODE							
1	SECONDARY DENSITY CODE							
2	WRTOK	DUP	DEFLT	Reserved				DLV
3	(MSB)	DESCRIPTOR LENGTH						(LSB)
4								
5	(MSB)	BITS PER MM						(LSB)
7								
8	(MSB)	MEDIA WIDTH						(LSB)
9								
10	(MSB)	TRACKS						(LSB)
11								
12	(MSB)	CAPACITY						(LSB)
15								
16								
23	ASSIGNING ORGANIZATION							
24								
31	DENSITY NAME							
32								
51	DESCRIPTION							

## 5.2.26.1.2 Density information

The density information is shown in table 112 and table 113.

**Table 112 — Density information LTO-3 through LTO-6**

Field	PRIMARY DENSITY CODE			
	44h	46h	58h	5Ah
PRIMARY DENSITY CODE	44h	46h	58h	5Ah
SECONDARY DENSITY CODE	44h	46h	58h	5Ah
WR TOK	0b The device cannot write this format 1b The device can write this format			
DUP	0	0	0	0
DEFLT	0b This density is not currently selected for use on a write from BOP 1b This density is currently selected for use on a write from BOP			
DLV	0	0	0	0
DESCRIPTOR LENGTH	0000h	0000h	0000h	0000h
BITS PER MM	9,638	12,725	15,142	15,142
MEDIA WIDTH (mm)	127	127	127	127
TRACKS	704	896	1280	2176
CAPACITY	381,469 (in 2 <sup>20</sup> bytes)	800,000 (in 10 <sup>6</sup> bytes)	1,500,000 (in 10 <sup>6</sup> bytes)	2,500,000 (in 10 <sup>6</sup> bytes)
ASSIGNING ORGANIZATION (ASCII)	"LTO-CVE "	"LTO-CVE "	"LTO-CVE "	"LTO-CVE "
DENSITY NAME (ASCII)	"U-316 "	"U-416 "	"U-516 "	"U-616 "
DESCRIPTION (ASCII)	"Ultrium 3/16T "	"Ultrium 4/16T "	"Ultrium 5/16T "	"Ultrium 6/16T "

Table 113 — Density information LTO-7 and later

Field	PRIMARY DENSITY CODE			
	5Ch	5Dh	5Eh	60h
PRIMARY DENSITY CODE	5Ch	5Dh	5Eh	60h
SECONDARY DENSITY CODE	5Ch	5Dh	5Eh	60h
WRTOK	0b The device cannot write this format 1b The device can write this format			
DUP	0	0	0	0
DEFLT	0b This density is not currently selected for use on a write from BOP 1b This density is currently selected for use on a write from BOP			
DLV	0	0	0	0
DESCRIPTOR LENGTH	0000h	0000h	0000h	0000h
BITS PER MM	19,107	19,107	20,669	21,459
MEDIA WIDTH (mm)	127	127	127	127
TRACKS	3584	5376	6656	8960
CAPACITY	6,000,000 (in 10 <sup>6</sup> bytes)	9,000,000 (in 10 <sup>6</sup> bytes)	12,000,000 (in 10 <sup>6</sup> bytes)	18,000,000 (in 10 <sup>6</sup> bytes)
ASSIGNING ORGANIZATION (ASCII)	"LTO-CVE "	"LTO-CVE "	"LTO-CVE "	"LTO-CVE "
DENSITY NAME (ASCII)	"U-732 "	"U-832M "	"U-832 "	"U-932 "
DESCRIPTION (ASCII)	"Ultrium 7/32T "	"Ultrium 8/32T Type M"	"Ultrium 8/32T "	"Ultrium 9/32T "

### 5.2.27 REPORT LUNS - A0h

The Report LUNs command is defined in SPC (see the latest version at [http://www.t10.org/drafts.htm#SCSI3\\_CMNDSETS](http://www.t10.org/drafts.htm#SCSI3_CMNDSETS)). This clause describes the specific implementation.

Table 114 — REPORT LUNS CDB

Byte	Bit							
	7 msb	6	5	4	3	2	1	0 lsb
0	OPERATION CODE (A0h)							
1	Reserved							
5	Reserved							
6	MSB	ALLOCATION LENGTH						LSB
9	Reserved							
10	Reserved							
11	Control Byte (see 5.1.2.3)							

The following parameters apply:

- ALLOCATION LENGTH: The maximum number of bytes to be transferred.

#### 5.2.27.1 Report LUNs data format

Table 115 shows the data that is returned:

Table 115 — RLUNS Logical Unit Numbers Data

Byte	Bit							
	7	6	5	4	3	2	1	0
0	(MSB)							
3	LUN LIST LENGTH							(LSB)
4	Reserved							
7	LUN list							
8	(MSB)							
15	FIRST LUN							(LSB)
	⋮							
n-7	(MSB)							
n	LAST LUN							(LSB)

### Byte Description

- 0-3 LUN LIST LENGTH (n-7): This field is set to 8 times the number of LUNs configured in the device. There will always be a LUN 0. There may be a library LUN (i.e., LUN 1) and/or there may be an ADC LUN (i.e., LUN 2).
- 4-7 Reserved
- 8-15 FIRST LUN: 0000 0000 0000 0000h (i.e., LUN 0)
- 16-23 Second LUN, if any
- | LUN   | Description  |
|-------|--|
| LUN 1 | 0001 0000 0000 0000h (returned only if LUN 1 exists)   |
| LUN 2 | 0002 0000 0000 0000h (returned only if LUN 1 does not exist and the device is configured for ADI and the ENABLE bit of LOGICAL UNIT INDEX 02h in Mode Page 0Eh subpage 03h of the ADC LUN (i.e., LUN 2) is set to one. |
- 24-31 LAST LUN, if any
- | LUN   | Description  |
|-------|--|
| LUN 2 | 0002 0000 0000 0000h (returned only if LUN 1 exists and configured for ADI and the ENABLE bit of LOGICAL UNIT INDEX 02h in Mode Page 0Eh subpage 03h of the ADC LUN (i.e., LUN 2) is set to one. |

NOTE 21 - If this command is received over the ADT port, then a LUN descriptor is returned with a value of 0002 0000 0000 0000h, even if the ENABLE bit of LOGICAL UNIT INDEX 02h in Mode Page 0Eh subpage 03h is set to zero.

### 5.2.28 REPORT SUPPORTED OPERATION CODES - A3h[0Ch]

The Report LUNs command is defined in SPC (see the latest version at [http://www.t10.org/drafts.htm#SCSI3\\_CMNDSETS](http://www.t10.org/drafts.htm#SCSI3_CMNDSETS)). This clause describes the specific implementation. Ultrium 5 and later devices support the REPORT SUPPORTED OPERATION CODES command. The REPORT SUPPORTED OPERATION CODES command (see table 116) requests information on commands the addressed logical unit supports. An application client may request a list of all operation codes and service actions supported by the logical unit or the command support data for a specific command.

The REPORT SUPPORTED OPERATION CODES command is a service action of the MAINTENANCE IN command.

**Table 116 — REPORT SUPPORTED OPERATION CODES CDB**

Byte	Bit							
	7	6	5	4	3	2	1	0
0	OPERATION CODE (A3h)							
1	Reserved				SERVICE ACTION (0Ch)			
2	RCTD	Reserved				REPORTING OPTIONS		
3	REQUESTED OPERATION CODE							
4	(MSB)	REQUESTED SERVICE ACTION						(LSB)
5								
6	(MSB)	ALLOCATION LENGTH						(LSB)
9								
10	Reserved							
11	Control Byte (see 5.1.2.3)							

A return command timeouts descriptor (RCTD) bit set to one specifies that the command timeouts descriptor (see 5.2.28.3) shall be included in each command descriptor (see 5.2.28.1) that is returned or in the one\_command parameter data (see 5.2.28.2) that is returned. A RCTD bit set to zero specifies that the command timeouts descriptor shall not be included in any parameter data returned.

The REPORTING OPTIONS field (see table 117) specifies the information to be returned in the parameter data.

**Table 117 — REPORT SUPPORTED OPERATION CODES REPORTING OPTIONS field**

Code	Description	Parameter Data Reference
000b	A list of all operation codes and service actions supported by the logical unit shall be returned in the all_commands parameter data format. The REQUESTED OPERATION CODE CDB field and REQUESTED SERVICE ACTION CDB field shall be ignored.	5.2.28.1
001b	The command support data for the operation code specified in the REQUESTED OPERATION CODE field shall be returned in the one_command parameter data format. The REQUESTED SERVICE ACTION CDB field shall be ignored. If the REQUESTED OPERATION CODE field specifies an operation code that has service actions, then the command shall be terminated with CHECK CONDITION status, with the sense key set to ILLEGAL REQUEST, and the additional sense code set to INVALID FIELD IN CDB.	5.2.28.2
010b	The command support data for the operation code and service action specified in the REQUESTED OPERATION CODE CDB field and REQUESTED SERVICE ACTION CDB field shall be returned in the one_command parameter data format. If the REQUESTED OPERATION CODE CDB field specifies an operation code that does not have service actions, then the command shall be terminated with CHECK CONDITION status, with the sense key set to ILLEGAL REQUEST, and the additional sense code set to INVALID FIELD IN CDB.	5.2.28.2
011b to 111b	Reserved	

The REQUESTED OPERATION CODE field specifies the operation code of the command to be returned in the one\_command parameter data format (see 5.2.28.2).

The REQUESTED SERVICE ACTION field specifies the service action of the command to be returned in the one\_command parameter data format.

The ALLOCATION LENGTH field specifies the maximum number of bytes or blocks that an application client has allocated in the Data-In Buffer.

### 5.2.28.1 All\_commands parameter data format

The REPORT SUPPORTED OPERATION CODES all\_commands parameter data format (see table 118) begins with a four-byte header that contains the length in bytes of the parameter data followed by a list of supported commands. Each command descriptor contains information about a single supported command CDB (i.e., one operation code and service action combination, or one non-service-action operation code). The list of command descriptors shall contain all commands supported by the logical unit.

**Table 118 — RSOC All\_commands parameter data**

Byte	Bit							
	7	6	5	4	3	2	1	0
0	(MSB)							
3	COMMAND DATA LENGTH (n-3)							(LSB)
Command descriptors								
4	Command descriptor 0 (see table 119)							
⋮								
n	Command descriptor x (see table 119)							

The COMMAND DATA LENGTH field indicates the length in bytes of the command descriptor list.

Each command descriptor (see table 119) contains information about a single supported command CDB.

**Table 119 — RSOC Command descriptor format**

Byte	Bit							
	7	6	5	4	3	2	1	0
0	OPERATION CODE							
1	Reserved							
2	(MSB)							
3	SERVICE ACTION							(LSB)
4	Reserved							
5	Reserved						CTDP	SERVACTV
6	(MSB)							
7	CDB LENGTH							(LSB)
8	Command timeouts descriptor, if any (see 5.2.28.3)							
19								

The OPERATION CODE field contains the operation code of a command supported by the logical unit.

The SERVICE ACTION field contains a supported service action of the supported operation code indicated by the OPERATION CODE field. If the operation code indicated in the OPERATION CODE field does not have a service actions, the SERVICE ACTION field shall be set to 00h.

A command timeouts descriptor present (CTDP) bit set to one indicates that the command timeouts descriptor (see 5.2.28.3) is included in this command descriptor. A CTDP bit set to zero indicates that the command timeouts descriptor is not included in this command descriptor.

A service action valid (SERVACTV) bit set to zero indicates the operation code indicated by the OPERATION CODE field does not have service actions and the SERVICE ACTION field contents are reserved. A SERVACTV bit set to one indicates the operation code indicated by the OPERATION CODE field has service actions and the contents of the SERVICE ACTION field are valid.

The CDB LENGTH field contains the length of the command CDB in bytes for the operation code indicated in the OPERATION CODE field, and if the SERVACTV bit is set to the service action indicated by the SERVICE ACTION field.

If the RCTD bit is set to one in the REPORT SUPPORTED OPERATION CODES CDB (see 5.2.28), the command timeouts descriptor (see table 122 in 5.2.28.3) shall be included. If the RCTD bit is set to zero, the command timeouts descriptor shall not be included.

### 5.2.28.2 One\_command parameter data format

The REPORT SUPPORTED OPERATION CODES one\_command parameter data format (see table 120) contains information about the CDB and a usage map for bits in the CDB for the command specified by the REPORTING OPTIONS, REQUESTED OPERATION CODE, and REQUESTED SERVICE ACTION fields in the REPORT SUPPORTED OPERATION CODES CDB.

**Table 120 — RSOC One\_command parameter data**

Byte	Bit							
	7	6	5	4	3	2	1	0
0	Reserved							
1	CTDP	Reserved				SUPPORT		
2	(MSB)							
3	CDB SIZE (n-3)						(LSB)	
4	CDB USAGE DATA							
n								
n+1	Command timeouts descriptor, if any (see 5.2.28.3)							
n+12								

A command timeouts descriptor present (CTDP) bit set to one indicates that the command timeouts descriptor (see 5.2.28.3) is included in the parameter data. A CTDP bit set to zero indicates that the command timeouts descriptor is not included in the parameter data.

The SUPPORT field is defined in table 121.

**Table 121 — RSOC One\_command SUPPORT values**

Support	Description
000b	Data about the requested SCSI command is not currently available. All data after byte 1 is not valid. A subsequent request for command support data may be successful.
001b	The device server does not support the requested command. All data after byte 1 is undefined.
010b	Reserved
011b	The device server supports the requested command in conformance with a SCSI standard. The parameter data format conforms to the definition in table 120.
100b	Reserved
101b	The device server supports the requested command in a vendor specific manner. The parameter data format conforms to the definition in table 120.
110b to 111b	Reserved

The CDB SIZE field contains the size of the CDB USAGE DATA field in the parameter data, and the number of bytes in the CDB for command being queried (i.e., the command specified by the REPORTING OPTIONS, REQUESTED



OPERATION CODE, and REQUESTED SERVICE ACTION fields in the REPORT SUPPORTED OPERATION CODES CDB).

The CDB USAGE DATA field contains information about the CDB for the command being queried. The first byte of the CDB USAGE DATA field shall contain the operation code for the command being queried. If the command being queried contains a service action, then that service action code shall be placed in the CDB USAGE DATA field in the same location as the SERVICE ACTION field of the command CDB. All other bytes of the CDB USAGE DATA field shall contain a usage map for bits in the CDB for the command being queried.

The bits in the usage map shall have a one-for-one correspondence to the CDB for the command being queried. If the device server evaluates a bit in the CDB for the command being queried, the usage map shall contain a one in the corresponding bit position. If any bit representing part of a field is returned as one, all bits for the field shall be returned as one. If the device server ignores or treats as reserved a bit in the CDB for the command being queried, the usage map shall contain a zero in the corresponding bit position. The usage map bits for a given CDB field all shall have the same value.

For example, the CDB usage bit map for the REPORT SUPPORTED OPERATION CODES command is: A3h, 0Ch, 87h, FFh, FFh, FFh, FFh, FFh, FFh, 00h, 07h. This example assumes that the logical unit only supports the low-order three bits of the CDB CONTROL byte. The first byte contains the operation code, and the second byte contains three reserved bits and the service action. The remaining bytes contain the usage map.

If the RCTD bit is set to one in the REPORT SUPPORTED OPERATION CODES CDB (see 5.2.28), the command timeouts descriptor (see table 122 in 5.2.28.3) shall be included. If the RCTD bit is set to zero, the command timeouts descriptor shall not be included.

### 5.2.28.3 Command timeouts descriptor

#### 5.2.28.3.1 Overview

The command timeouts descriptor (see table 122) returns timeout information for commands supported by the logical unit based on the time from the start of processing for the command to its reported completion.

Values returned in the command timeouts descriptor do not include times that are outside the control of the device server (e.g., prior commands with the IMMED bit set to one in the CDB, concurrent commands from the same or different I\_T nexuses, manual unloads, power-on self tests, prior aborted commands, commands that force cache synchronization, delays in the service delivery subsystem).

For commands that cause a change in power condition, values returned in the command timeouts descriptor do not include the power condition transition time (e.g., the time to thread the media).

Values returned in the command timeouts descriptor should not be used to compare products.

**Table 122 — RSOC Command timeouts descriptor format**

Byte	Bit							
	7	6	5	4	3	2	1	0
0	(MSB) _____							
1	DESCRIPTOR LENGTH (0Ah)							(LSB)
2	Reserved							
3	COMMAND SPECIFIC							
4	(MSB) _____							
7	NOMINAL COMMAND PROCESSING TIMEOUT							(LSB)
8	(MSB) _____							
11	RECOMMENDED COMMAND TIMEOUT							(LSB)

The DESCRIPTOR LENGTH field indicates the number of bytes that follow in the command timeouts descriptor.

The COMMAND SPECIFIC field contains timeout information that is specific to the commands listed in table 123.

**Table 123 — RSOC Command timeouts descriptor COMMAND SPECIFIC field usage**

Command	Reference
WRITE BUFFER	5.2.28.3.2

A non-zero value in the NOMINAL COMMAND PROCESSING TIMEOUT field indicates the minimum amount of time in seconds the application client should wait prior to querying for the progress of the command identified by the parameter data that contains this command timeouts descriptor. A value of zero in the NOMINAL COMMAND PROCESSING TIMEOUT field indicates that no timeout is indicated.

NOTE 22 - The value contained in the NOMINAL COMMAND PROCESSING TIMEOUT field may include time required for typical device error recovery procedures expected to occur on a regular basis.

A non-zero value in the RECOMMENDED COMMAND TIMEOUT field specifies the recommended time in seconds the application client should wait prior to timing out the command identified by the parameter data that contains this command timeouts descriptor. A value of zero in the RECOMMENDED COMMAND TIMEOUT field indicates that no time is indicated.

The device server should set the recommended command timeout to a value greater than or equal to the nominal command processing timeout.

Application clients should use the Report Supported Operation Codes command to discover command timeout values. The following tables list the command timeout values at the time this document was published for the commands supported at the time the document was published. These values may have changed since publication.

Table	Contents
Table 124	RSOC Command timeout values for Full-Height (at publication)
Table 125	RSOC Command timeout values for Full-Height (at publication) not returned to command
Table 126	RSOC Command timeout values for Half-Height (at publication)
Table 127	RSOC Command timeout values for Half-Height (at publication) not returned to command

Due to the sequential nature of tape devices, many host commands are serialized, and command timeouts consequently have an additive effect. Using reservations prevents this from causing application disruptions in a multi-initiator or SAN environment. Similar additive timeout effects may occur if the host is using command queuing (simple queuing).

NOTE 23 - The time-outs in the following table are based on the time from the start of processing of the command, to its reported completion. Since applications are generally concerned with the time from the command being issued, to its reported completion, it should be noted that this overall time may be affected by currently processing operations. Some of these conditions include:

- a) A prior command was issued with the Immediate bit set in the CDB
- b) Multiple concurrent commands with Simple queuing are processed
- c) Multi-initiator configurations without reservations
- d) Non-host operations, such as manual unloads, power-on self tests, etc.
- e) Commands issued shortly after certain aborted commands
- f) Commands which force flushes when unwritten write data is in the buffer
- g) commands which require interactions with an out-of-band key manager

Table 124 — RSOC Command timeout values for Full-Height (at publication) (part 1 of 4)

Op Codes	Service Action	Command	Ultrium 5		Ultrium 6		Ultrium 7		Ultrium 8		Ultrium 9	
			Nom	Rec	Nom	Rec	Nom	Rec	Nom	Rec	Nom	Rec
00h	----	TEST UNIT READY (see 5.2.40)	60	60	60	60	60	60	60	60	60	60
01h	----	REWIND (see 5.2.33)	300	600	300	600	300	600	300	600	300	600
03h	----	REQUEST SENSE (see 5.2.31)	60	60	60	60	60	60	60	60	60	60
04h	----	FORMAT MEDIUM (see 5.2.3)	300	1 560	480	3 000	420	3 000	420	3 000	420	7 200
05h	----	READ BLOCK LIMITS (see 5.2.17)	60	60	60	60	60	60	60	60	60	60
08h	----	READ (see 5.2.15)	300	1 500	300	1 500	120	2 280	120	2 280	120	2 340
0Ah	----	WRITE (see 5.2.42)	300	1 500	300	1 500	120	1 500	120	1 500	120	1 500
0Bh	----	SET CAPACITY (see 5.2.37)	300	780	300	780	300	780	300	780	300	780
10h	----	WRITE FILEMARK (see 5.2.46)	300	1 620	300	1 620	300	1 620	300	1 620	300	1 620
11h	----	SPACE (6) (see 5.2.39)	300	2 040	300	2 040	360	2 940	360	2 940	360	2 940
12h	----	INQUIRY (see 5.2.5)	60	60	60	60	60	60	60	60	60	60
13h	----	VERIFY (VTE=1b or VBF=1b) (see 5.2.41)	13 800	16 920	20 400	25 200	24 600	28 860	41 100	47 700	55 020	63 300
15h	----	MODE SELECT (6) (see 5.2.10)	60	60	60	60	60	60	60	60	60	60
16h	----	RESERVE UNIT (6) (see 5.2.32)	60	60	60	60	60	60	60	60	60	60
17h	----	RELEASE UNIT (6) (see 5.2.25)	60	60	60	60	60	60	60	60	60	60
19h	----	ERASE (see 5.2.2)	13 800	16 380	20 400	24 600	24 600	27 540	46 029	54 896	64 048	74 341
1Ah	----	MODE SENSE (6) (see 5.2.11)	60	60	60	60	60	60	60	60	60	60
1Bh	----	LOAD/UNLOAD (see 5.2.6)	300	780	300	780	540	960	540	960	540	7 200
1Ch	----	RECEIVE DIAGNOSTIC RESULTS (see 5.2.23)	60	60	60	60	60	60	60	60	60	60
1Dh	----	SEND DIAGNOSTIC (see 5.2.36)	900	2 100	900	2 100	900	1 980	900	1 980	900	7 200
1Eh	----	PREVENT/ALLOW MEDIUM REMOVAL (see 5.2.14)	60	60	60	60	60	60	60	60	60	60
2Bh	----	LOCATE (10) (see 5.2.7)	300	2 040	300	2 040	360	2 940	360	2 940	360	2 940
34h	----	READ POSITION (see 5.2.22) — [SHORT FORM -- BLOCK ID]	60	60	60	60	60	60	60	60	60	60
34h	0006h	READ POSITION (see 5.2.22) — [LONG FORM]	60	60	60	60	60	60	60	60	60	60

**NOTE:** The timeout value are in seconds

Table 124 — RSOC Command timeout values for Full-Height (at publication) (part 2 of 4)

Op Codes	Service Action	Command	Ultrium 5		Ultrium 6		Ultrium 7		Ultrium 8		Ultrium 9	
			Nom	Rec	Nom	Rec	Nom	Rec	Nom	Rec	Nom	Rec
34h	0008h	READ POSITION (see 5.2.22) — [EXTENDED FORM]	60	60	60	60	60	60	60	60	60	60
3Bh	----	WRITE BUFFER (see 5.2.44)	300	540	300	540	120	540	120	540	120	540
3Ch	----	READ BUFFER (see 5.2.18)	300	480	300	480	120	480	120	480	120	480
44h	----	REPORT DENSITY SUPPORT (see 5.2.26)	60	60	60	60	60	60	60	60	60	60
4Ch	----	LOG SELECT (see 5.2.8)	60	60	60	60	60	60	60	60	60	60
4Dh	----	LOG SENSE (see 5.2.9)	60	60	60	60	60	60	60	60	60	60
55h	----	MODE SELECT (10) (see 5.2.10)	60	60	60	60	60	60	60	60	60	60
56h	----	RESERVE UNIT (10) (see 5.2.32)	60	60	60	60	60	60	60	60	60	60
57h	----	RELEASE UNIT (10) (see 5.2.25)	60	60	60	60	60	60	60	60	60	60
5Ah	----	MODE SENSE (10) (see 5.2.11)	60	60	60	60	60	60	60	60	60	60
5Eh	----	PERSISTENT RESERVE IN — [READ KEYS] (see 5.2.12)	60	60	60	60	60	60	60	60	60	60
5Eh	0001h	PERSISTENT RESERVE IN — [READ RESERVATION] (see 5.2.12)	60	60	60	60	60	60	60	60	60	60
5Eh	0002h	PERSISTENT RESERVE IN — [REPORT CAPABILITIES] (see 5.2.12)	60	60	60	60	60	60	60	60	60	60
5Eh	0003h	PERSISTENT RESERVE IN — [READ FULL STATUS] (see 5.2.12)	60	60	60	60	60	60	60	60	60	60
5Fh	----	PERSISTENT RESERVE OUT — [REGISTER] (see 5.2.13)	60	60	60	60	60	60	60	60	60	60
5Fh	0001h	PERSISTENT RESERVE OUT — [RESERVE] (see 5.2.13)	60	60	60	60	60	60	60	60	60	60
5Fh	0002h	PERSISTENT RESERVE OUT — [RELEASE] (see 5.2.13)	60	60	60	60	60	60	60	60	60	60
5Fh	0003h	PERSISTENT RESERVE OUT — [CLEAR] (see 5.2.13)	60	60	60	60	60	60	60	60	60	60

**NOTE:** The timeout value are in seconds

Table 124 — RSOC Command timeout values for Full-Height (at publication) (part 3 of 4)

Op Codes	Service Action	Command	Ultrium 5		Ultrium 6		Ultrium 7		Ultrium 8		Ultrium 9	
			Nom	Rec	Nom	Rec	Nom	Rec	Nom	Rec	Nom	Rec
5Fh	0004h	PERSISTENT RESERVE OUT — [PREEMPT] (see 5.2.13)	60	60	60	60	60	60	60	60	60	60
5Fh	0005h	PERSISTENT RESERVE OUT — [PREEMPT AND ABORT] (see 5.2.13)	60	60	60	60	60	60	60	60	60	60
5Fh	0006h	PERSISTENT RESERVE OUT — [REGISTER AND IGNORE EXISTING KEY] (see 5.2.13)	60	60	60	60	60	60	60	60	60	60
5Fh	0007h	PERSISTENT RESERVE OUT — [REGISTER AND MOVE] (see 5.2.13)	60	60	60	60	60	60	60	60	60	60
82h	----	ALLOW DATA OVERWRITE (see 5.2.1)	60	60	60	60	60	60	60	60	60	60
8Ch	----	READ ATTRIBUTE (see 5.2.16) — [ATTRIBUTE VALUES]	60	60	60	60	60	60	60	60	60	60
8Ch	0001h	READ ATTRIBUTE (see 5.2.16) — [ATTRIBUTE LIST]	60	60	60	60	60	60	60	60	60	60
8Ch	0002h	READ ATTRIBUTE (see 5.2.16) — [LOGICAL VOLUME LIST]	60	60	60	60	60	60	60	60	60	60
8Ch	0003h	READ ATTRIBUTE (see 5.2.16) — [PARTITION LIST]	60	60	60	60	60	60	60	60	60	60
8Ch	0005h	READ ATTRIBUTE (see 5.2.16) — [SUPPORTED ATTRIBUTES]	60	60	60	60	60	60	60	60	60	60
8Dh	----	WRITE ATTRIBUTE (see 5.2.43)	60	60	60	60	60	60	60	60	60	60
91h	----	SPACE (16) (see 5.2.39)	300	2 040	300	2 040	360	2 940	360	2 940	360	2 940
92h	----	LOCATE (16) (see 5.2.7)	300	2 040	300	2 040	360	2 940	360	2 940	360	2 940
A0h	----	REPORT LUNS (see 5.2.27)	60	60	60	60	60	60	60	60	60	60
A2h	----	SECURITY PROTOCOL IN (see 5.2.34)	60	60	60	60	60	60	60	60	60	60
A3h	000Ch	REPORT SUPPORTED OPERATION CODE (see 5.2.28)	60	60	60	60	60	60	60	60	60	60
A3h	000Dh	REPORT SUPPORTED TASK MANAGEMENT FUNCTIONS (see 5.2.29)	60	60	60	60	60	60	60	60	60	60
A3h	000Fh	REPORT TIMESTAMP (see 5.2.30)	60	60	60	60	60	60	60	60	60	60

**NOTE:** The timeout value are in seconds

Table 124 — RSOC Command timeout values for Full-Height (at publication) (part 4 of 4)

Op Codes	Service Action	Command	Ultrium 5		Ultrium 6		Ultrium 7		Ultrium 8		Ultrium 9	
			Nom	Rec	Nom	Rec	Nom	Rec	Nom	Rec	Nom	Rec
A3h	001Dh	RECEIVE RECOMMENDED ACCESS ORDER (RRAO) (see 5.2.24)	Not supported								60	60
A3h	001Eh	READ DYNAMIC RUNTIME ATTRIBUTE (standardized) (see 5.2.19)	60	60	60	60	60	60	60	60	60	60
A3h	001Fh	[01h] - READ LOGGED-IN HOST TABLE (see 5.2.21) [45h] - READ END OF WRAP POSITION (see 5.2.20)	Not supported		60	60	60	60	60	60	60	60
A4h	000Fh	SET TIMESTAMP (see 5.2.38)	60	60	60	60	60	60	60	60	60	60
A4h	001Dh	GENERATE RECOMMENDED ACCESS ORDER (GRAO) (see 5.2.4)	Not supported								60	60
A4h	001Eh	WRITE DYNAMIC RUNTIME ATTRIBUTE (standardized) (see 5.2.45)	60	60	60	60	60	60	60	60	60	60
B5h	----	SECURITY PROTOCOL OUT (see 5.2.35)	60	60	60	60	60	60	60	60	60	60
D1h	0000h	READ DYNAMIC RUNTIME ATTRIBUTE (legacy) — [SUPPORTED ATTRIBUTES] (see 5.2.19)	60	60	60	60	60	60	60	60	60	60
D1h	0010h	READ DYNAMIC RUNTIME ATTRIBUTE (legacy) — [ATTRIBUTE VALUES FOR THIS I_T NEXUS] (see 5.2.19)	60	60	60	60	60	60	60	60	60	60
D1h	0011h	READ DYNAMIC RUNTIME ATTRIBUTE (legacy) — [ATTRIBUTE VALUES FOR ALL I_T NEXUSES] (see 5.2.19)	60	60	60	60	60	60	60	60	60	60
D2h	----	WRITE DYNAMIC RUNTIME ATTRIBUTE (legacy) (see 5.2.45)	60	60	60	60	60	60	60	60	60	60

**NOTE:** The timeout value are in seconds

Table 125 lists the command timeout values for abnormal conditions or for options that are too long to make them useful with the values returned in Table 124. This contains the commands supported at the time the document was published. These values may have changed since publication.

**Table 125 — RSOC Command timeout values for Full-Height (at publication) not returned to command**

Op Codes	Service Action	Command	Ultrium 5		Ultrium 6		Ultrium 7		Ultrium 8		Ultrium 9	
			Nom	Rec	Nom	Rec	Nom	Rec	Nom	Rec	Nom	Rec
04h	----	FORMAT MEDIUM (see 5.2.3) (using FORMAT=1h)	300	1 560	480	3 000	420	3 000	420	3 000	420	3 000
11h	----	SPACE (6) (see 5.2.39) (slow—e.g., lost directory)	13 800	16 920	20 400	25 200	24 600	28 860	41 100	47 700	55 020	63 300
13h	----	VERIFY (see 5.2.41) (VTE=0b and VBF=0b) (e.g., single block verify)	300	1 500	300	1 500	120	2 280	120	2 280	120	2 340
1Bh	----	LOAD/UNLOAD (see 5.2.6) (Normal load, not cartridge initialization)	300	780	300	780	540	960	540	960	540	960
1Dh	----	SEND DIAGNOSTIC (see 5.2.36) (Diagnostics other than 0111h)	900	2 100	900	2 100	900	1 980	900	1 980	900	1 980
2Bh	----	LOCATE (10) (see 5.2.7) (slow—e.g., lost directory)	13 800	16 920	20 400	25 200	24 600	28 860	41 100	47 700	55 020	63 300
91h	----	SPACE (16) (see 5.2.39) (slow—e.g., lost directory)	13 800	16 920	20 400	25 200	24 600	28 860	41 100	47 700	55 020	63 300
92h	----	LOCATE (16) (see 5.2.7) (slow—e.g., lost directory)	13 800	16 920	20 400	25 200	24 600	28 860	41 100	47 700	55 020	63 300

**NOTE:** The timeout value are in seconds

**Table 126 — RSOC Command timeout values for Half-Height (at publication) (part 1 of 5)**

Op Codes	Service Action	Command	Ultrium 5		Ultrium 6		Ultrium 7		Ultrium 8		Ultrium 9	
			Nom	Rec	Nom	Rec	Nom	Rec	Nom	Rec	Nom	Rec
00h	----	TEST UNIT READY (see 5.2.40)	60	60	60	60	60	60	60	60	60	60
01h	----	REWIND (see 5.2.33)	300	780	300	780	300	600	300	600	300	600
03h	----	REQUEST SENSE (see 5.2.31)	60	60	60	60	60	60	60	60	60	60
04h	----	FORMAT MEDIUM (see 5.2.3)	300	1 980	480	3 840	420	3 240	420	3 240	420	7 920
05h	----	READ BLOCK LIMITS (see 5.2.17)	60	60	60	60	60	60	60	60	60	60
08h	----	READ (see 5.2.15)	300	1 920	300	1 920	120	2 340	120	2 340	120	2 340
0Ah	----	WRITE (see 5.2.42)	300	1 920	300	1 920	120	1 560	120	1 560	120	1 560
0Bh	----	SET CAPACITY (see 5.2.37)	300	960	300	960	300	960	300	960	300	960

**NOTE:** The timeout value are in seconds

Table 126 — RSOC Command timeout values for Half-Height (at publication) (part 2 of 5)

Op Codes	Service Action	Command	Ultrium 5		Ultrium 6		Ultrium 7		Ultrium 8		Ultrium 9	
			Nom	Rec	Nom	Rec	Nom	Rec	Nom	Rec	Nom	Rec
10h	----	WRITE FILEMARK (see 5.2.46)	300	1 740	300	1 740	300	1 680	300	1 680	300	1 680
11h	----	SPACE (6) (see 5.2.39)	360	2 700	360	2 700	360	2 940	360	2 940	360	2 940
12h	----	INQUIRY (see 5.2.5)	60	60	60	60	60	60	60	60	60	60
13h	----	VERIFY (VTE=1b or VBF=1b) (see 5.2.41)	13 800	19 980	20 400	30 000	24 600	28 860	48 420	54 360	55 020	63 300
15h	----	MODE SELECT (6) (see 5.2.10)	60	60	60	60	60	60	60	60	60	60
16h	----	RESERVE UNIT (6) (see 5.2.32)	60	60	60	60	60	60	60	60	60	60
17h	----	RELEASE UNIT (6) (see 5.2.25)	60	60	60	60	60	60	60	60	60	60
19h	----	ERASE (see 5.2.2)	13 800	19 200	20 400	29 400	24 600	27 540	98 732	121 448	137 477	166 370
1Ah	----	MODE SENSE (6) (see 5.2.11)	60	60	60	60	60	60	60	60	60	60
1Bh	----	LOAD/UNLOAD (see 5.2.6)	360	1 020	360	1 020	540	960	540	960	540	7 920
1Ch	----	RECEIVE DIAGNOSTIC RESULTS (see 5.2.23)	60	60	60	60	60	60	60	60	60	60
1Dh	----	SEND DIAGNOSTIC (see 5.2.36)	960	3 120	960	3 120	900	2 040	900	2 040	900	7 920
1Eh	----	PREVENT/ALLOW MEDIUM REMOVAL (see 5.2.14)	60	60	60	60	60	60	60	60	60	60
2Bh	----	LOCATE (10) (see 5.2.7)	360	2 700	360	2 700	360	2 940	360	2 940	360	2 940
34h	----	READ POSITION (see 5.2.22) — [SHORT FORM -- BLOCK ID]	60	60	60	60	60	60	60	60	60	60
34h	0006h	READ POSITION (see 5.2.22) — [LONG FORM]	60	60	60	60	60	60	60	60	60	60
34h	0008h	READ POSITION (see 5.2.22) — [EXTENDED FORM]	60	60	60	60	60	60	60	60	60	60
3Bh	----	WRITE BUFFER (see 5.2.44)	300	720	300	720	120	540	120	540	120	540
3Ch	----	READ BUFFER (see 5.2.18)	300	660	300	660	120	480	120	480	120	480
44h	----	REPORT DENSITY SUPPORT (see 5.2.26)	60	60	60	60	60	60	60	60	60	60
4Ch	----	LOG SELECT (see 5.2.8)	60	60	60	60	60	60	60	60	60	60
4Dh	----	LOG SENSE (see 5.2.9)	60	60	60	60	60	60	60	60	60	60
55h	----	MODE SELECT (10) (see 5.2.10)	60	60	60	60	60	60	60	60	60	60
56h	----	RESERVE UNIT (10) (see 5.2.32)	60	60	60	60	60	60	60	60	60	60
57h	----	RELEASE UNIT (10) (see 5.2.25)	60	60	60	60	60	60	60	60	60	60

**NOTE:** The timeout value are in seconds



Table 126 — RSOC Command timeout values for Half-Height (at publication) (part 3 of 5)

Op Codes	Service Action	Command	Ultrium 5		Ultrium 6		Ultrium 7		Ultrium 8		Ultrium 9	
			Nom	Rec	Nom	Rec	Nom	Rec	Nom	Rec	Nom	Rec
5Ah	----	MODE SENSE (10) (see 5.2.11)	60	60	60	60	60	60	60	60	60	60
5Eh	----	PERSISTENT RESERVE IN — [READ KEYS] (see 5.2.12)	60	60	60	60	60	60	60	60	60	60
5Eh	0001h	PERSISTENT RESERVE IN — [READ RESERVATION] (see 5.2.12)	60	60	60	60	60	60	60	60	60	60
5Eh	0002h	PERSISTENT RESERVE IN — [REPORT CAPABILITIES] (see 5.2.12)	60	60	60	60	60	60	60	60	60	60
5Eh	0003h	PERSISTENT RESERVE IN — [READ FULL STATUS] (see 5.2.12)	60	60	60	60	60	60	60	60	60	60
5Fh	----	PERSISTENT RESERVE OUT — [REGISTER] (see 5.2.13)	60	60	60	60	60	60	60	60	60	60
5Fh	0001h	PERSISTENT RESERVE OUT — [RESERVE] (see 5.2.13)	60	60	60	60	60	60	60	60	60	60
5Fh	0002h	PERSISTENT RESERVE OUT — [RELEASE] (see 5.2.13)	60	60	60	60	60	60	60	60	60	60
5Fh	0003h	PERSISTENT RESERVE OUT — [CLEAR] (see 5.2.13)	60	60	60	60	60	60	60	60	60	60
5Fh	0004h	PERSISTENT RESERVE OUT — [PREEMPT] (see 5.2.13)	60	60	60	60	60	60	60	60	60	60
5Fh	0005h	PERSISTENT RESERVE OUT — [PREEMPT AND ABORT] (see 5.2.13)	60	60	60	60	60	60	60	60	60	60
5Fh	0006h	PERSISTENT RESERVE OUT — [REGISTER AND IGNORE EXISTING KEY] (see 5.2.13)	60	60	60	60	60	60	60	60	60	60
5Fh	0007h	PERSISTENT RESERVE OUT — [REGISTER AND MOVE] (see 5.2.13)	60	60	60	60	60	60	60	60	60	60
82h	----	ALLOW DATA OVERWRITE (see 5.2.1)	60	60	60	60	60	60	60	60	60	60
8Ch	----	READ ATTRIBUTE (see 5.2.16) — [ATTRIBUTE VALUES]	60	60	60	60	60	60	60	60	60	60
8Ch	0001h	READ ATTRIBUTE (see 5.2.16) — [ATTRIBUTE LIST]	60	60	60	60	60	60	60	60	60	60

**NOTE:** The timeout value are in seconds

Table 126 — RSOC Command timeout values for Half-Height (at publication) (part 4 of 5)

Op Codes	Service Action	Command	Ultrium 5		Ultrium 6		Ultrium 7		Ultrium 8		Ultrium 9	
			Nom	Rec	Nom	Rec	Nom	Rec	Nom	Rec	Nom	Rec
8Ch	0002h	READ ATTRIBUTE (see 5.2.16) — [LOGICAL VOLUME LIST]	60	60	60	60	60	60	60	60	60	60
8Ch	0003h	READ ATTRIBUTE (see 5.2.16) — [PARTITION LIST]	60	60	60	60	60	60	60	60	60	60
8Ch	0005h	READ ATTRIBUTE (see 5.2.16) — [SUPPORTED ATTRIBUTES]	60	60	60	60	60	60	60	60	60	60
8Dh	----	WRITE ATTRIBUTE (see 5.2.43)	60	60	60	60	60	60	60	60	60	60
91h	----	SPACE (16) (see 5.2.39)	360	2 700	360	2 700	360	2 940	360	2 940	360	2 940
92h	----	LOCATE (16) (see 5.2.7)	360	2 700	360	2 700	360	2 940	360	2 940	360	2 940
A0h	----	REPORT LUNS (see 5.2.27)	60	60	60	60	60	60	60	60	60	60
A2h	----	SECURITY PROTOCOL IN (see 5.2.34)	60	60	60	60	60	60	60	60	60	60
A3h	000Ch	REPORT SUPPORTED OPERATION CODE (see 5.2.28)	60	60	60	60	60	60	60	60	60	60
A3h	000Dh	REPORT SUPPORTED TASK MANAGEMENT FUNCTIONS (see 5.2.29)	60	60	60	60	60	60	60	60	60	60
A3h	000Fh	REPORT TIMESTAMP (see 5.2.30)	60	60	60	60	60	60	60	60	60	60
A3h	001Eh	READ DYNAMIC RUNTIME ATTRIBUTE (standardized) (see 5.2.19)	60	60	60	60	60	60	60	60	60	60
A3h	001Fh	[01h] - READ LOGGED-IN HOST TABLE (see 5.2.21) [45h] - READ END OF WRAP POSITION (see 5.2.20)	Not Supported		60	60	60	60	60	60	60	60
A4h	000Fh	SET TIMESTAMP (see 5.2.38)	60	60	60	60	60	60	60	60	60	60
A4h	001Eh	WRITE DYNAMIC RUNTIME ATTRIBUTE (standardized) (see 5.2.45)	60	60	60	60	60	60	60	60	60	60

**NOTE:** The timeout value are in seconds

Table 126 — RSOC Command timeout values for Half-Height (at publication) (part 5 of 5)

Op Codes	Service Action	Command	Ultrium 5		Ultrium 6		Ultrium 7		Ultrium 8		Ultrium 9	
			Nom	Rec	Nom	Rec	Nom	Rec	Nom	Rec	Nom	Rec
B5h	----	SECURITY PROTOCOL OUT (see 5.2.35)	60	60	60	60	60	60	60	60	60	60
D1h	----	READ DYNAMIC RUNTIME ATTRIBUTE (legacy) — [SUPPORTED ATTRIBUTES] (see 5.2.19)	60	60	60	60	60	60	60	60	60	60
D1h	0010h	READ DYNAMIC RUNTIME ATTRIBUTE (legacy) — [ATTRIBUTE VALUES FOR THIS I_T NEXUS] (see 5.2.19)	60	60	60	60	60	60	60	60	60	60
D1h	0011h	READ DYNAMIC RUNTIME ATTRIBUTE (legacy) — [ATTRIBUTE VALUES FOR ALL I_T NEXUSES] (see 5.2.19)	60	60	60	60	60	60	60	60	60	60
D2h	----	WRITE DYNAMIC RUNTIME ATTRIBUTE (legacy) (see 5.2.45)	60	60	60	60	60	60	60	60	60	60

**NOTE:** The timeout value are in seconds

Table 127 lists the command timeout values for abnormal conditions or for options that are too long to make them useful with the values returned in Table 126. This contains the commands supported at the time the document was published. These values may have changed since publication.

**Table 127 — RSOC Command timeout values for Half-Height (at publication) not returned to command**

Op Codes	Service Action	Command	Ultrium 5		Ultrium 6		Ultrium 7		Ultrium 8		Ultrium 9	
			Nom	Rec	Nom	Rec	Nom	Rec	Nom	Rec	Nom	Rec
04h	----	FORMAT MEDIUM (see 5.2.3) (using FORMAT=1h)	300	1 980	480	3 840	420	3 240	420	3 240	420	3 240
11h	----	SPACE (6) (see 5.2.39) (slow—e.g., lost directory)	13 800	19 980	20 400	30 000	24 600	28 860	41 100	47 700	67 020	74 160
13h	----	VERIFY(see 5.2.41) (VTE=0b and VBF=0b) (e.g., single block verify)	300	1 920	300	1 920	120	2340	120	2340	120	2340
1Bh	----	LOAD/UNLOAD (see 5.2.6) (Normal load, not cartridge initialization)	360	1 020	360	1 020	540	960	540	960	540	960
1Dh	----	SEND DIAGNOSTIC (see 5.2.36) (Diagnostics other than 0111h)	960	3 120	960	3 120	900	2 040	900	2 040	900	2 040
2Bh	----	LOCATE (10) (see 5.2.7) (slow—e.g., lost directory)	13 800	19 980	20 400	30 000	24 600	28 860	41 100	47 700	67 020	74 160
91h	----	SPACE (16) (see 5.2.39) (slow—e.g., lost directory)	13 800	19 980	20 400	30 000	24 600	28 860	41 100	47 700	67 020	74 160
92h	----	LOCATE (16) (see 5.2.7) (slow—e.g., lost directory)	13 800	19 980	20 400	30 000	24 600	28 860	41 100	47 700	67 020	74 160

**NOTE:** The timeout value are in seconds

### 5.2.28.3.2 WRITE BUFFER command timeouts descriptor COMMAND SPECIFIC field usage

For the WRITE BUFFER command, the COMMAND SPECIFIC field usage is reserved for all modes except the following:

- Download microcode mode (04h);
- Download microcode and save mode (05h);
- Download microcode with offsets mode (06h);
- Download microcode with offsets and save mode (07h);
- Download microcode with offsets and defer activation mode (0Eh) only if the microcode is activated by an event other than an activate deferred microcode mode; and
- Activate deferred microcode mode (0Fh).

If the command timeouts descriptor describes one of the WRITE BUFFER modes listed in this subclause, then the COMMAND SPECIFIC field indicates the maximum time, in one second increments, that access to the SCSI device is limited or not possible through any SCSI ports associated with a logical unit that processes a WRITE BUFFER command that specifies one of the named modes. A value of zero in the COMMAND SPECIFIC field indicates that the no maximum time is indicated.

### 5.2.29 REPORT SUPPORTED TASK MANAGEMENT FUNCTIONS - A3h[0Dh]

The REPORT SUPPORTED TASK MANAGEMENT FUNCTIONS command is defined in SPC (see the latest version at [http://www.t10.org/drafts.htm#SCSI3\\_CMNDSETS](http://www.t10.org/drafts.htm#SCSI3_CMNDSETS)). The REPORT SUPPORTED TASK MANAGEMENT FUNCTIONS command (see table 128) requests information on task management functions supported by the drive.

**Table 128 — REPORT SUPPORTED TASK MANAGEMENT FUNCTIONS CDB**

Byte	Bit							
	7	6	5	4	3	2	1	0
0	OPERATION CODE (A3h)							
1	Reserved			SERVICE ACTION (0Dh)				
2	REPD	Reserved						
3	Reserved							
5	Reserved							
6	(MSB)	ALLOCATED LENGTH (4h or larger)						Reserved
9	Reserved							
10	Reserved							
11	Control Byte (see 5.1.2.3)							

The following parameters apply:

- SERVICE ACTION: 0Dh
- REPD (report extended parameter data): 0b
- ALLOCATION LENGTH: The number of bytes allowed to be returned. Shall be 4h or larger.

#### 5.2.29.1 REPORT SUPPORTED TASK MANAGEMENT FUNCTIONS parameter data

The format of the parameter data returned by the REPORT TASK MANAGEMENT FUNCTIONS command is shown in table 129.

**Table 129 — REPORT SUPPORTED TASK MANAGEMENT FUNCTIONS parameter data**

Byte	Bit							
	7	6	5	4	3	2	1	0
0	ATS	ATSS	CACAS	CTSS	LURS	QTS	TRS	WAKE
1	Reserved					QAES	QTSS	ITNRS
2	Reserved							
3	REPORT SUPPORTED TASK MANAGEMENT FUNCTIONS ADDITIONAL DATA LENGTH							

The parameters are defined as follows:

**Byte Description**

0

Bit	Description
7	ATS (abort task): 1b
6	ATSS (abort task set): 1b
5	CACAS (clear aca): 0b
4	CTSS (clear task set): 1b
3	LURS (logical unit reset): 1b
2	QTS (query task):
	<b>Value Description</b>
	0b Set on FC attached devices to indicate not supported.
	1b Set on SAS attached devices to indicate supported.
1	TRS (target reset):
	<b>Value Description</b>
	0b Set on SAS attached devices to indicate not supported.
	1b Set on FC attached devices to indicate supported.
0	WAKE (wakeup): 0b

1

Bit	Description
7-3	Reserved
2	QAES (query asynchronous event): 0b
1	QTSS (query task set): 0b
0	ITNRS (I_T nexus reset): 0b

2 Reserved

3 REPORT SUPPORTED TASK MANAGEMENT FUNCTIONS ADDITIONAL DATA LENGTH: 00h

### 5.2.30 REPORT TIMESTAMP - A3h[0Fh]

The REPORT TIMESTAMP command (see table 130) is defined in SPC (see the latest version at [http://www.t10.org/drafts.htm#SCSI3\\_CMNDSETS](http://www.t10.org/drafts.htm#SCSI3_CMNDSETS)). This clause describes the specific implementation.

**Table 130 — REPORT TIMESTAMP CDB**

Byte	Bit							
	7	6	5	4	3	2	1	0
0	OPERATION CODE (A3h)							
1	Reserved			SERVICE ACTION (0Fh)				
2	Reserved							
5	Reserved							
6	(MSB)	ALLOCATION LENGTH						(LSB)
9								
10	Reserved							
11	Control Byte (see 5.1.2.3)							

The following parameters apply:

- SERVICE ACTION: 0Fh
- ALLOCATION LENGTH: The number of bytes that have been allocated for the returned parameter data.

### 5.2.30.1 REPORT TIMESTAMP parameter data

The format of the parameter data returned by the REPORT TIMESTAMP command is shown in table 131.

**Table 131 — REPORT TIMESTAMP Timestamp Descriptor**

Byte	Bit							
	7	6	5	4	3	2	1	0
0	(MSB) _____							
1	TIMESTAMP PARAMETER DATA LENGTH (0Ah)							(LSB)
2	Reserved				TIMESTAMP ORIGIN			
3	Reserved							
4	(MSB) _____							
9	TIMESTAMP							(LSB)
10	Reserved							
11	_____							

The parameters are defined as follows:

#### Byte Description

0-1      TIMESTAMP PARAMETER DATA LENGTH: 0Ah  
2

#### Bit Description

7-3      Reserved

2-0      TIMESTAMP ORIGIN: Device Clocks (see 4.17 on page 61) defines the TIMESTAMP ORIGIN

3      Reserved

4-9      TIMESTAMP: Device Clocks (see 4.17 on page 61) defines the timestamp.

10-11    Reserved

### 5.2.31 REQUEST SENSE - 03h

The REQUEST SENSE command is defined in SPC (see the latest version at [http://www.t10.org/drafts.htm#SCSI3\\_CMNDSETS](http://www.t10.org/drafts.htm#SCSI3_CMNDSETS)). This clause describes the specific implementation.

**Table 132 — REQUEST SENSE CDB**

Byte	Bit							
	7 msb	6	5	4	3	2	1	0 lsb
0	OPERATION CODE (03h)							
1	Obsolete			Reserved				
2	Reserved							
3	_____							
4	ALLOCATION LENGTH							
5	Control Byte (see 5.1.2.3)							

The following parameters apply:

- ALLOCATION LENGTH: The maximum number of bytes to be transferred.

This device generates up to 96 bytes of sense data. If the ALLOCATION LENGTH specified is less than the generated sense data length, then the allocated amount is transferred, the remaining sense data is lost, and no error is reported. If the ALLOCATED LENGTH specified is greater, then the entire sense data is transferred and no error is reported.

In read ILI conditions only 18 bytes of sense data may be generated. While processing sense data, the host should use the ADDITIONAL SENSE LENGTH field (i.e., byte 7) to determine the amount of sense data generated to insure that only valid transferred fields are examined.

### 5.2.31.1 Sense Data Format

**Table 133 — REQUEST SENSE Sense Data Format (part 1 of 2)**

Byte	Bit							
	7 msb	6	5	4	3	2	1	0 lsb
0	VALID	RESPONSE CODE						
1	Obsolete (00h)							
2	FILEMARK	EOM	ILI	Reserved	SENSE KEY			
3	INFORMATION							
6								
7	ADDITIONAL SENSE LENGTH							
8								
11	COMMAND SPECIFIC INFORMATION							
12	ADDITIONAL SENSE CODE							
13	ADDITIONAL SENSE CODE QUALIFIER							
14	FIELD REPLACEABLE UNIT CODE							
15	SKSV	C/D	Reserved		BPV	BIT POINTER		
16	SKSV (1: FIELD POINTER)							
17	SKSV (0: REPORTING ERROR FAULT SYMPTOM CODE)							
18	REPORTING ERROR FLAG DATA							
19								
20	SPEED INDEX							
21	Reserved			DRVSRVC	CLN	Reserved	DUMP	VOLVALID
22	VOLUME LABEL							
28								
29	PHYSICAL WRAP LOW							
30	(MSB)	RELATIVE LPOS VALUE						(LSB)
33								
34	SCSI ADDRESS							
35	RS422 INFORMATION							
36	Reserved				PHYSICAL WRAP HIGH	ACTIVE PARTITION		
37	(MSB)	PORT IDENTIFIER OF PORT REPORTING SENSE						(LSB)
39	(This is the address of the port through which sense is reported.)							



**Table 133 — REQUEST SENSE Sense Data Format (part 2 of 2)**

Byte	Bit							
	7 msb	6	5	4	3	2	1	0 lsb
40	TAPE DIRECTORY VALID	TAPE PARTITIONS EXIST	Reserved	Reserved	Reserved	RELATIVE TGT PORT REPORTING SENSE: 0: Reserved 1: Relative Tgt Port 1 (Port 0) 2: Relative Tgt Port 2 (Port 1) 3: Relative Tgt Port 3 (RS422 Port) 4: Relative Tgt Port 4 (Ethernet Port)		
41	HOST COMMAND (SCSI Opcode)							
42	CARTRIDGE GENERATION TYPE 0: No media present / Gen1 1: Gen2 2: Gen3 3: Gen 4 4: Gen 5 5: Gen 6 6: Gen 7 7: Gen 8 8: Gen 9				MEDIA TYPE (Vendor Reserved)			
43	VOLUME LABEL CARTRIDGE TYPE							
44	LOGICAL BLOCK NUMBER (Current LBA that would be reported in Read Position command)							
45	LOGICAL BLOCK NUMBER (Current LBA that would be reported in Read Position command)							
48	LOGICAL BLOCK NUMBER (Current LBA that would be reported in Read Position command)							
49	(MSB)	DATASET NUMBER						(LSB)
52	DATASET NUMBER							
53	1ST ERROR FSC							
54	1ST ERROR FSC							
55	1ST ERROR FLAG DATA							
56	1ST ERROR FLAG DATA							
57	2ND ERROR FSC							
58	2ND ERROR FSC							
59	2ND ERROR FLAG DATA							
60	2ND ERROR FLAG DATA							
61	NEXT-TO-LAST ERROR FSC							
62	NEXT-TO-LAST ERROR FSC							
63	NEXT-TO-LAST ERROR FLAG DATA							
64	NEXT-TO-LAST ERROR FLAG DATA							
65	LAST ERROR FSC							
66	LAST ERROR FSC							
67	LAST ERROR FLAG DATA							
68	LAST ERROR FLAG DATA							
69	LPOS REGION							
70	LPOS REGION							
85	ERP SUMMARY INFORMATION							
86	(MSB)	CARTRIDGE SERIAL NUMBER (This is the value from the CM right justified, not the Barcode)						(LSB)
95	CARTRIDGE SERIAL NUMBER (This is the value from the CM right justified, not the Barcode)							

**Byte Description**

0

Bit	Description
7	VALID
	<b>Value Description</b>
	0b information bytes 3-6 are not valid
	1b information bytes 3-6 are valid
6-0	RESPONSE CODE
	<b>Value Description</b>
	70h current (non-deferred)
	71h deferred

1 Obsolete: 00h

2

Bit	Description
7	FILEMARK (see Request Sense Information, ILI, and Command Interactions (see 4.12 on page 47))
	<b>Value Description</b>
	0b the current command has not encountered a filemark
	1b the current command has encountered a filemark.
	This device does not report Setmarks, per Mode Page 10h, byte 8, bit 5.
6	EOM (End-Of-Medium):
	<b>Value Description</b>
	0b indicates that the device is not at the end of medium.
	1b indicates that the device is at the end of medium.
5	ILI (Incorrect Length Indicator): see Request Sense Information, ILI, and Command Interactions (see 4.12 on page 47). ILI residual counts are in the Information field.
4	Reserved
3-0	SENSE KEY (see Annex B.)
3-6	INFORMATION: The content of this field varies depending on the failing command and error. This field is only valid when the Valid bit (byte 0, bit 7) is set to 1. This field is generally only valid for non-deferred errors. See Request Sense Information, ILI, and Command Interactions (see 4.12 on page 47)
7	ADDITIONAL SENSE LENGTH (n-7): 0Ah or 58h
	This device returns 96 bytes of sense data (a value of 58h in the Additional Sense Length field). The first 18 bytes are standard.
	Only the first 18 bytes of sense data may be returned (a value of 0Ah in the Additional Sense Length field) in association with ILI conditions for read-type commands.
8-11	COMMAND-SPECIFIC INFORMATION: 0000_0000h
	This device does not support the commands associated with this field.
12	ADDITIONAL SENSE CODE (ASC) (see Annex B.)
13	ADDITIONAL SENSE CODE QUALIFIER (ASCQ) (see Annex B.)
14	FIELD REPLACEABLE UNIT CODE (FRU)
	This field indicates a possible component or area which is related to the error or failure. Since this device is a single FRU product, this does not necessarily mean a replaceable component has been identified. Instead, this is used for extended fault isolation information.

## 15-17 SENSE KEY SPECIFIC

When the SKSV bit is 1b (often set when SENSE KEY is ILLEGAL REQUEST), bytes 15-17 are interpreted as follows:

**Byte Description**

15 SENSE KEY SPECIFIC

**Bit Description**

7 SKSV (Sense Key Specific Valid): 1b

6 C/D (Control/Data):

**Value Description**

0b specifies that the error is in a data field of the parameter list.

1b specifies that the error is in a CDB field.

5-4 Reserved

3 BPV (Bit Pointer Valid):

**Value Description**

0b specifies that the Bit Pointer Field is not valid.

1b specifies that the Bit Pointer Field is valid.

2-0 BIT POINTER

When BPV is set to 1b, this field points to the bit in error of the field specified by the FIELD POINTER.

## 16-17 FIELD POINTER

Points to the CDB byte or parameter byte in error.

When the SKSV bit is 0b, bytes 15-17 are interpreted as follows:

**Byte Description**

15 Vendor-Unique Indicators

**Bit Description**

7 SKSV (Sense Key Specific Valid): 0b

6-0 Reserved

## 16-17 REPORTING ERROR FAULT SYMPTOM CODE (FSC)

## 18-19 REPORTING ERROR FLAG DATA

20 SPEED INDEX: The index of the speed which is currently being used. Speed 1 is the highest speed and higher numbers are progressively slower speeds.

21

**Bit Description**

7-5 Reserved

4 DRVSRVC: This bit is set to one by code whenever the drive determines that it has a hardware fault causing the drive to be inoperative. This bit is mapped to the "DEAD DRIVE" Flag {3Ch:000Dh}" (see page 344) of LP 3Ch: Drive usage information (see 6.4.29 on page 342). This bit:

- a) is maintained across all reset conditions, firmware downloads, and power cycles;
- b) is tested and reported by the SEND DIAGNOSTIC Command and any diagnostics run on the drive except the Power-On-Test if this drive is configured for attachment to eServer;
- c) does not affect drive operations; and
- d) is not affected by the Power-On-Test.

3 CLN:

**Value Description**

0b this device is not requesting a clean.

1b this device is requesting a clean.

2 Reserved

1 DUMP: This bit indicates if there is a drive dump (i.e., drive debug log) present in the drive.

If this bit is set, the dump should be read prior to forcing a dump by using the Force Dump diagnostic of the SEND DIAGNOSTIC command.

**WARNING****WARNING**

This bit should be examined before reading a drive dump and if it is set to zero, then no attempt should be made to read a dump prior to forcing the dump with the Force Dump diagnostic. If a dump is read when there is not one present, then interface information in a subsequent dump forced by the Force Dump diagnostic is washed out by the reading of the non-dump.

**WARNING****WARNING**

	<b>Value</b>	<b>Description</b>
	0b	no dump is present.
	1b	a dump is present.
0	VOLVALID: indicates if the VOLUME LABEL field and the VOLUME LABEL CARTRIDGE TYPE field contain valid information.	
	<b>Value</b>	<b>Description</b>
	0b	the VOLUME LABEL field and the VOLUME LABEL CARTRIDGE TYPE field do not contain valid information.
	1b	the VOLUME LABEL field and the VOLUME LABEL CARTRIDGE TYPE field contain valid information.
22-28	VOLUME LABEL: If a cartridge is loaded in the drive and the VOLVALID bit is set to 1b, then the VOLUME LABEL field reports a value in the following priority: <ol style="list-style-type: none"> <li>1) the seven characters from the left of the volume label set by the library (if one exists);</li> <li>2) the seven characters from the left of the volume label from the host bar code field in the CM (if it exists); or</li> <li>3) all spaces (ASCII 20h).</li> </ol>	
29	PHYSICAL WRAP LOW: The lower byte of the physical wrap of the current location. Prior to LTO9, this is the entire physical wrap value. In LTO9+, the most significant bits of this field are in the PHYSICAL WRAP HIGH field. The least significant bit reflects the current physical direction.	
	<b>Value</b>	<b>Description</b>
	0b	the current direction is away from physical beginning of tape.
	1b	the current direction is towards physical beginning of tape.
30-33	RELATIVE LPOS VALUE: This field is the current relative longitudinal position value.	
34	SCSI ADDRESS: Obsolete - See PORT IDENTIFIER OF PORT REPORTING SENSE (bytes 36-39) instead.	
35	RS422 INFORMATION: This field may contain a value passed across the RS-422 serial interface by, for example, a tape library, if the library vendor chooses to send such a value. The value passed from across the RS-422 interface is reported persistently until a different value is sent, at which time the new value is reported persistently.	
36	<b>Bit</b>	<b>Description</b>
	7-4	Reserved
	3	PHYSICAL WRAP HIGH: The most significant bit of the physical wrap of the current location. The lower byte of the physical wrap is in the PHYSICAL WRAP LOW field. This field is only valid in LTO9+.
	2-0	ACTIVE PARTITION: The partition number of the current logical position of the volume.
37-39	PORT IDENTIFIER OF PORT REPORTING SENSE: The address of the port through which sense is reported.	
	<b>Byte</b>	<b>Description</b>
	36	Reserved
	37-39	FIBRE CHANNEL FABRIC PORT ADDRESS (e.g., 011E13h or 000026h), if FC device; or HASHED SAS ADDRESS OF THE DRIVE PORT (e.g., F32A94h), if SAS device.

40

<b>Bit</b>	<b>Description</b>
7	TAPE DIRECTORY VALID:
6	TAPE PARTITIONS EXIST:
	This field is set to 0b when no volume is mounted
	<b>Value</b> <b>Description</b>
	0b                  The mounted volume contains only one partition (i.e., not partitioned)
	1b                  The mounted volume contains more than one partitions (i.e., is partitioned)
5-3	Reserved
2-0	RELATIVE TGT PORT REPORTING SENSE: The relative target port through which sense data is being reported.
	<b>Value</b> <b>Description</b>
	000b              Reserved
	001b              Relative target port 1 (Port 0)
	010b              Relative target port 2 (Port 1)
	011b              Relative target port 3 (RS-422 Port)
	100b              Relative target port 4 (Ethernet Port)
41	HOST COMMAND: SCSI Opcode of the command to which sense data is being returned.

42

<b>Bit</b>	<b>Description</b>
7-4	CARTRIDGE GENERATION TYPE:
	<b>Value</b> <b>Description</b>
	0h                  No media present or Gen1
	1h                  Gen2
	2h                  Gen3
	3h                  Gen 4
	4h                  Gen 5
	5h                  Gen 6
	6h                  Gen 7
	7h                  Gen 8
	8h                  Gen 9
3-0	MEDIA TYPE (Vendor Reserved)

43-44 VOLUME LABEL CARTRIDGE TYPE: This field is only valid if the VOLVALID bit is set to 1b.

<b>Value</b>	<b>Description</b>
'L3'	Ultrium 3 - Native capacity is 400 GB (10 <sup>6</sup> )
'LT'	Ultrium 3 WORM - Native capacity is 400 GB (10 <sup>6</sup> )
'L4'	Ultrium 4 - Native capacity is 800 GB (10 <sup>6</sup> )
'LU'	Ultrium 4 WORM - Native capacity is 800 GB (10 <sup>6</sup> )
'L5'	Ultrium 5 - Native capacity is 1500 GB (10 <sup>6</sup> )
'LV'	Ultrium 5 WORM - Native capacity is 1500 GB (10 <sup>6</sup> )
'L6'	Ultrium 6 - Native capacity is 2500 GB (10 <sup>6</sup> )
'LW'	Ultrium 6 WORM - Native capacity is 2500 GB (10 <sup>6</sup> )
'L7'	Ultrium 7 - Native capacity is 6000 GB (10 <sup>6</sup> )
'LX'	Ultrium 7 WORM - Native capacity is 6000 GB (10 <sup>6</sup> )
'M8'	Ultrium 8 Type M - Native capacity is 9000 GB (10 <sup>6</sup> )
'L8'	Ultrium 8 - Native capacity is 12000 GB (10 <sup>6</sup> )
'LY'	Ultrium 8 WORM - Native capacity is 12000 GB (10 <sup>6</sup> )
'L9'	Ultrium 9 - Native capacity is 18000 GB (10 <sup>6</sup> )
'LZ'	Ultrium 9 WORM - Native capacity is 18000 GB (10 <sup>6</sup> )

45-48 LOGICAL BLOCK NUMBER: Current LBA that would be reported in Read Position command

49-52 DATASET NUMBER:

53-54 1ST ERROR FSC:

55-56 1ST ERROR FLAG DATA:  
 57-58 2ND ERROR FSC:  
 59-60 2ND ERROR FLAG DATA:  
 61-62 NEXT-TO-LAST ERROR FSC:  
 63-64 NEXT-TO-LAST ERROR FLAG DATA:  
 65-66 LAST ERROR FSC:  
 67-68 LAST ERROR FLAG DATA:  
 69 LPOS REGION:  
 70-85 ERP SUMMARY INFORMATION:  
 86-95 CARTRIDGE SERIAL NUMBER: This is the value from the CM right justified, not the Barcode

### 5.2.32 RESERVE (6/10)- 16h/56h

The RESERVE command is defined in SPC-2 (see <http://www.t10.org/cgi-bin/ac.pl?t=f&f=spc2r20.pdf>). This clause describes the specific implementation.

**Table 134 — RESERVE (6) CDB**

Byte	Bit							
	7 msb	6	5	4	3	2	1	0 lsb
0	Operation code (16h)							
1	Obsolete				Obsolete			
2	Obsolete							
4	Obsolete							
5	Control Byte (see 5.1.2.3)							

**Table 135 — RESERVE (10) CDB**

Byte	Bit							
	7 msb	6	5	4	3	2	1	0 lsb
0	OPERATION CODE (56h)							
1	Reserved			3RDPTY	Reserved		LONGID	Obsolete
2	Obsolete							
3	THIRD-PARTY DEVICE ID							
4	Reserved							
6	Reserved							
7	(MSB)	PARAMETER LIST LENGTH						(LSB)
8	PARAMETER LIST LENGTH							
9	Control Byte (see 5.1.2.3)							

The following parameters apply:

- 3RDPTY (Third Party): 0b
- LONGID: 0b
- Obsolete: All obsolete fields shall be set to zero.
- THIRD - PARTY DEVICE ID: 00h
- PARAMETER LIST LENGTH: 0000h

NOTE 24 - Reserves are honored across initiator as well as port boundaries. For additional information, see "Multiple Port Behavior" on page 263.

### 5.2.33 REWIND - 01h

The Rewind command is defined in SSC (see the latest version at [http://www.t10.org/drafts.htm#SCSI3\\_CMNDSETS](http://www.t10.org/drafts.htm#SCSI3_CMNDSETS)). This clause describes the specific implementation.

**Table 136 — REWIND CDB**

Byte	Bit							
	7 msb	6	5	4	3	2	1	0 lsb
0	OPERATION CODE (01h)							
1	Obsolete				Reserved			IMMED
2	Reserved							
4	Reserved							
5	Control Byte (see 5.1.2.3)							

The following parameters apply:

- Immed (Immediate):
 

Value	Description
0b	present status when command is completed.
1b	present status when all buffered data is successfully written to the media.

NOTE 25 - On eServer enabled drives (i.e., The PRODUCT ID returned in Standard Inquiry is "HH LTO Gen x" where "x" is a number), a CHECK CONDITION status with SENSE KEY set to 1h and the additional sense code set to DEGRADED MEDIA (i.e., ASC/ASCQ 8252h) may be returned after completion of the REWIND command if certain conditions are met.

### 5.2.34 SECURITY PROTOCOL IN (SPIN) - A2h

The Security Protocol In command is defined in SPC-4 (see the latest version at [http://www.t10.org/drafts.htm#SCSI3\\_CMNDSETS](http://www.t10.org/drafts.htm#SCSI3_CMNDSETS)). This clause describes the specific implementation.

The SECURITY PROTOCOL IN command (see table 137) is:

- supported in encryption capable drives that are configured for AME-T10 mode (see 4.15); and
- is used to retrieve security protocol information (see 6.8.1) or the results of one or more SECURITY PROTOCOL OUT commands (see 5.2.35).

**Table 137 — SECURITY PROTOCOL IN - A2h CDB**

Byte	Bit							
	7 msb	6	5	4	3	2	1	0 lsb
0	OPERATION CODE (A2h)							
1	SECURITY PROTOCOL							
2	SECURITY PROTOCOL SPECIFIC							
3	SECURITY PROTOCOL SPECIFIC							
4	inc_512	Reserved						
5	Reserved							
6	(MSB)	Allocation Length						(LSB)
9	Allocation Length							
10	Reserved							
11	Control Byte (see 5.1.2.3)							

The following parameters apply:

- SECURITY PROTOCOL: SPIN (00h[0000h]) - Supported Security Protocols List (see 6.8.1.1 on page 440) lists the supported security protocols.
- SECURITY PROTOCOL SPECIFIC - The contents depend on the protocol specified by the SECURITY PROTOCOL field. The following SPIN pages provide a list of supported SECURITY PROTOCOL SPECIFIC values:
  - SPIN (00h[0000h]) - Supported Security Protocols List (see 6.8.1.1 on page 440)
  - SPIN (20h[0000h]) - Tape Data Encryption In Support Pages page (see 6.8.2.1 on page 443)
  - SPIN (20h[0001h]) - Tape Data Encryption Out Support Pages page (see 6.8.2.2 on page 445)
- INC\_512: 0b
- ALLOCATION LENGTH:

Security Protocol Parameters (SPP) (see 6.8 on page 439) has a listing of all security protocol parameters.

### 5.2.35 SECURITY PROTOCOL OUT (SPOUT) - B5h

The Security Protocol Out command is defined in SPC-4 (see the latest version at [http://www.t10.org/drafts.htm#SCSI3\\_CMNDSETS](http://www.t10.org/drafts.htm#SCSI3_CMNDSETS)). This clause describes the specific implementation.

The SECURITY PROTOCOL OUT command (see Table 138) is:

- supported in encryption capable drives that are configured for AME-T10 mode Encryption Control - T10 Standards (see 4.15.2 on page 55); and
- used to send data to the logical unit. The data sent specifies one or more operations to be performed by the logical unit. The format and function of the operations depends on the contents of the SECURITY PROTOCOL field (see table 138). Depending on the protocol specified by the SECURITY PROTOCOL field, the application client may use the SECURITY PROTOCOL IN command (see 5.2.34) to retrieve data derived from these operations.

NOTE 26 - The operation code, B5h has been recovered from a seldom used media changer (i.e. LUN 1) command (REQUEST VOLUME ELEMENT ADDRESS). If the device driver being used still uses the LUN field of the CDB from SCSI-2 days, this command is routed to the incorrect LUN. Since the SPOUT command is a DATA OUT type command, whereas the REQUEST VOLUME ELEMENT ADDRESS command is a DATA IN type command this has the potential to cause strange system behaviors.

**Table 138 — SECURITY PROTOCOL OUT B5h CDB**

Byte	Bit							
	7 msb	6	5	4	3	2	1	0 lsb
0	OPERATION CODE (B5h)							
1	SECURITY PROTOCOL							
2	SECURITY PROTOCOL SPECIFIC							
3	SECURITY PROTOCOL SPECIFIC							
4	inc_512	Reserved						
5	Reserved							
6	(MSB)	ALLOCATION LENGTH						
9	ALLOCATION LENGTH							(LSB)
10	Reserved							
11	Control Byte (see 5.1.2.3)							



The following parameters apply:

- SECURITY PROTOCOL
 

Value	Description
20h	Tape Data Encryption security protocol (see 6.8.3).
- SECURITY PROTOCOL SPECIFIC: The contents depend on the protocol specified by the SECURITY PROTOCOL field.
- INC\_512: 0b
- ALLOCATION LENGTH:

Security Protocol Parameters (SPP) (see 6.8 on page 439) has a listing of all security protocol parameters.

### 5.2.36 SEND DIAGNOSTIC - 1Dh

The SEND DIAGNOSTIC command is defined in SPC (see the latest version at [http://www.t10.org/drafts.htm#SCSI3\\_CMNDSETS](http://www.t10.org/drafts.htm#SCSI3_CMNDSETS)). This clause describes the specific implementation.

After a Send Diagnostic command completes, use the Receive Diagnostic Results command to receive the results.

For diagnostics that produce diagnostic results, the LUN should be reserved to allow the I\_T nexus that issued the Send Diagnostic command to issue the Receive Diagnostic Results command before a different I\_T nexus clears the results by reading them.

**Table 139 — SEND DIAGNOSTIC CDB**

Byte	Bit							
	7 msb	6	5	4	3	2	1	0 lsb
0	OPERATION CODE (1Dh)							
1	Obsolete			PF	Reserved	SELFTEST	DEVOFL	UNITOFL
2	Reserved							
3	MSB							
4	PARAMETER LIST LENGTH							LSB
5	Control Byte (see 5.1.2.3)							

The following parameters apply:

- PF (Page Format): 1b
- SELFTEST:
 

Value	Description
0b	Perform the diagnostic operation specified in the parameter list.
1b	Perform self test. See 6.2.3 on page 207 for details of this diagnostic.

NOTE 27 - When Self Test is requested, no other diagnostic may be simultaneously requested.

- DEVOFL (Device Off Line):
 

Value	Description
0b	is supported and prohibits any diagnostic operations that may be detected by subsequent I/O processes.
1b	is supported and grants permission to the target to perform diagnostic operations that may affect all the logical units on a target; that is, alteration of reservations, log parameters, or sense data.
x	in the diagnostic description indicates that either 0b or 1b may be used with identical effects.

NOTE 28 - DEVOFI and UNITOFI are set by the system. These bits grant permission to the target to perform vendor-specific diagnostic operations on the target that may be visible to attached initiators. Thus, by preventing operations that are not enabled by these bits, the target assists the operating system in protecting its resources.

- UNITOFI (Unit Off Line):

Value	Description
0b	is supported and prohibits any diagnostic operations that may be detected by subsequent I/O processes.
1b	is supported and grants permission to the target to perform diagnostic operations that may affect the user medium on the logical unit; for example, write operations to the user-accessible medium, or operations that reposition the medium on sequential access devices.
x	in the diagnostic description indicates that either 0b or 1b may be used with identical effects.

- PARAMETER LIST LENGTH: This field specifies the length in bytes of the parameter list that is transferred from the initiator to the target. A parameter list length value of zero specifies that no data is transferred. This condition is not considered an error. If the specified parameter list length results in truncation of one or more pages (PF bit set to 1b), the target returns CHECK CONDITION status with associated sense data of 5/2400 (ILLEGAL REQUEST, INVALID FIELD IN CDB).

Diagnostic Parameters (Diag) (see 6.2 on page 195) has a listing of all diagnostic parameters.

### 5.2.37 SET CAPACITY - 0Bh

The SET CAPACITY command is defined in SSC (see the latest version at [http://www.t10.org/drafts.htm#SCSI3\\_CMNDSETS](http://www.t10.org/drafts.htm#SCSI3_CMNDSETS)). This clause describes the specific implementation.

The SET CAPACITY command sets the available medium for the currently mounted volume to a proportion of the total medium for use. Any excess space shall be unavailable on the medium after successful completion of this command until changed by a new SET CAPACITY command. This change shall persist through power cycles, logical unit resets, I\_T nexus losses, and unloading or reloading of the volume.

**Table 140 — SET CAPACITY CDB**

Byte	Bit							
	7	6	5	4	3	2	1	0
0	OPERATION CODE (0Bh)							
1	Reserved							IMMED
2	Reserved							
3	(MSB)	MEDIUM FOR USE PROPORTION VALUE						(LSB)
4								
5	Control Byte (see 5.1.2.3)							

If no volume is loaded, then the command is terminated with CHECK CONDITION status. The sense key is set to NOT READY, and the additional sense code is set to MEDIUM NOT PRESENT.

The SET CAPACITY command is accepted only when the medium is at beginning-of-partition 0 (BOP 0). If the medium is logically at any other position, the command is rejected with CHECK CONDITION status. The sense key is set to ILLEGAL REQUEST and the additional sense code is set to POSITION PAST BEGINNING OF MEDIUM.

A valid SET CAPACITY command causes all data and partitioning information on the entire physical volume to be lost. If the partitioning information changes, a unit attention condition is established for all initiators with the additional sense code set to MODE PARAMETERS CHANGED.

The following parameters apply:

- IMMED (immediate):
 

Value	Description
0b	present status when command is completed.
1b	present status when the command descriptor block has been validated all buffered data, if any, is successfully written to the medium.
- MEDIUM FOR USE PROPORTION VALUE (MFUPV): The portion of the total medium to be made available for use. This field is the numerator to a fraction that has a denominator of 65\_535 (FFFFh). The resulting available capacity on the tape is equal to the total unscaled tape capacity multiplied by this fraction.

$$\frac{\text{MFUPV}}{65535} \times \text{TotalUnscaledTapeCapacity} = \text{ResultingAvailableCapacity}$$

This device may round up the capacity to the next highest supported value. This rounding is not considered an error and is not reported. If the MEDIUM FOR USE PROPORTION VALUE does not meet the ranges specified in table 141 then CHECK CONDITION status is returned with ILLEGAL FIELD IN CDB (5/2400h).

===== WARNING =====

If the Capacity Proportion is increased it is possible that a debris dump may exist at the previous logical end of medium. This may cause a defect when attempting to write through that area.

===== WARNING =====

**Table 141 — SET CAPACITY MEDIUM FOR USE PROPORTION VALUE and resultant capacity**

Cartridge	Minimum MEDIUM FOR USE PROPORTION VALUE	Resultant Approximate MEDIUM FOR USE PROPORTION VALUE	Maximum Capacity
Ultrium 4	123Dh	52 GB	800 GB
Ultrium 5	0FD8h	92 GB	1500 GB
Ultrium 6	0FD8h	154 GB	2500 GB
Ultrium 7	0DEAh	326 GB	6000 GB
Ultrium M8	0946h	326 GB	9 000 GB
Ultrium 8	0E5Fh	674 GB	12 000 GB
Ultrium 9	0CD7h	902 GB	18 000 GB
Note - Available and total tape capacities are approximate values that may be affected by defects which reduce the actual available capacity of the tape. Other factors, such as compression and block packing, may also affect available capacity.			

NOTE 29 - The MEDIUM FOR USE PROPORTION VALUE relates to the physical proportion of the medium that is available for use to record logical objects and is not limited by the maximum number of logical objects that the device server is capable of supporting. This maintains the orthogonality between the volume and the logical unit that exists due to volumes being transferred to logical units that may support a different number of logical objects.

### 5.2.38 SET TIMESTAMP - A4h[0Fh]

The SET TIMESTAMP command is defined in SPC-4 (see the latest version at [http://www.t10.org/drafts.htm#SCSI3\\_CMNDSETS](http://www.t10.org/drafts.htm#SCSI3_CMNDSETS)). This clause describes the specific implementation.

The SET TIMESTAMP command (see table 142) requests the drive to initialize the timestamp (see 4.17), if the SCSIIP bit is set to one or the TCMOS bit is set to one in MP 0Ah[01h]: Control Extension (see 6.6.8 on page 370). If the SCSIIP bit is set to zero, the SET TIMESTAMP command is terminated with CHECK CONDITION status, with the sense key set to ILLEGAL REQUEST, and the additional sense code set to INVALID FIELD IN CDB.

Table 142 — SET TIMESTAMP CDB

Byte	Bit							
	7	6	5	4	3	2	1	0
0	OPERATION CODE (A4h)							
1	Reserved				SERVICE ACTION (0Fh)			
2	Reserved							
5	Reserved							
6	(MSB)	PARAMETER LIST LENGTH						(LSB)
9	Reserved							
10	Reserved							
11	Control Byte (see 5.1.2.3)							

The following parameters apply:

- PARAMETER LIST LENGTH: The length in bytes of the SET TIMESTAMP parameters that is transferred from the application client to the device server. A PARAMETER LIST LENGTH of zero indicates that no data is transferred, and that no change is made to the timestamp. Allowed values are 000Ch and 0000h.

### 5.2.38.1 SET TIMESTAMP Parameter List

The format for the parameter data for the SET TIMESTAMP command is shown in table 143.

Table 143 — SET TIMESTAMP parameter list format

Byte	Bit							
	7	6	5	4	3	2	1	0
0	Reserved							
3	Reserved							
4	(MSB)	TIMESTAMP						(LSB)
9	Reserved							
10	Reserved							
11	Reserved							

The definition of the parameters follows:

#### Byte Description

0-3 Reserved

4-9 **TIMESTAMP**: The initial value of the timestamp in the format defined in Device Clocks (see 4.17 on page 61). The timestamp should be the number of milliseconds that have elapsed since midnight, 1 January 1970 UT. If the high order byte in the **TIMESTAMP** field is greater than F0h, the command is terminated with CHECK CONDITION status, with the sense key set to ILLEGAL REQUEST, and the additional sense code set to INVALID FIELD IN PARAMETER LIST.

10-11 Reserved

On successful completion of a SET TIMESTAMP command the drive generates a UNIT ATTENTION condition for the initiator port associated with every I\_T nexus except the I\_T nexus on which the SET TIMESTAMP command was received, with the additional sense code set to TIMESTAMP CHANGED.

### 5.2.39 SPACE (6/16) - 11h/91h

The Space commands are defined in SSC (see the latest version at [http://www.t10.org/drafts.htm#SCSI3\\_CMNDSETS](http://www.t10.org/drafts.htm#SCSI3_CMNDSETS)). This clause describes the specific implementation.

The Space command is implemented similar to the Locate command, causing the tape to move at maximum speed when appropriate.

**Table 144 — SPACE (6) CDB**

Byte	Bit							
	7 msb	6	5	4	3	2	1	0 lsb
0	Operation code (11h)							
1	Obsolete (LUN)			Reserved			CODE	
2	MSB _____							
4	COUNT _____							
5	Control Byte (see 5.1.2.3)							

The Space (16) command (see table 145), operates identically to the Space (6) command, but allows specifying a Count field up to eight bytes in length.

This command is newly added to the standards. The only exceptions to SSC for this command are that the explicit command set is not supported and the list of values supported in the Code field.

**Table 145 — SPACE (16) CDB**

Byte	Bit							
	7 msb	6	5	4	3	2	1	0 lsb
0	Operation Code (91h)							
1	Reserved				CODE			
2	Reserved							
3	Reserved							
4	(MSB) _____							
11	COUNT _____							
12	(MSB) _____							
13	PARAMETER LENGTH (0000h)							
14	Reserved							
15	Control Byte (see 5.1.2.3)							

The following parameters apply:

- CODE: Specifies the type of logical objects to be spaced over or the termination point of the operation.

<b>Value</b>	<b>Description</b>
--------------	--------------------

0h	Blocks:
----	---------

If a filemark is encountered while spacing over logical blocks, the command is terminated. CHECK CONDITION status is returned, and the FILEMARK and VALID bits are set to one in the sense data. The sense key is set to NO SENSE and the additional sense code is set to FILEMARK DETECTED. The INFORMATION field is set to the number of logical objects to be spaced over minus the actual number of logical objects spaced over not including the filemark. The logical position is on the end-of-partition side of the filemark if movement was

in the forward direction and on the beginning-of-partition side of the filemark if movement was in the reverse direction.

1h	Filemarks
3h	End of Data
others	Reserved

- COUNT: A value in two's complement notation specifying the number of logical objects to be spaced over and the direction of movement. If the CODE field is set to 3h (i.e., End-of-data), then the COUNT field is ignored.

When spacing over logical objects, the magnitude of the value in the COUNT field specifies the number of logical objects to be spaced over in the current partition and the sign of the value in the COUNT field specifies the direction of movement.

If the COUNT field contains a positive value N and the CODE field does not contain 3h (i.e., end-of-data) then the device server positions in the forward direction (i.e., toward end-of-partition) over N logical objects ending on the end-of-partition side of the last logical object.

If the COUNT field contains a negative value -N, in two's complement notation, and the CODE field does not contain 3h (i.e., end-of-data) then the device server positions in the reverse direction (i.e., toward beginning-of-partition) over N logical objects ending on the beginning-of-partition side of the last logical object.

If the drive encounters End-of-Data (EOD) while processing this command, the command is terminated at the EOD position and CHECK CONDITION status is returned with associated sense data of 8/0005 (BLANK CHECK, END-OF-DATA DETECTED).

- PARAMETER LENGTH: 0000h

#### 5.2.40 TEST UNIT READY - 00h

The TEST UNIT READY command is defined in SPC (see the latest version at [http://www.t10.org/drafts.htm#SCSI3\\_CMNDSETS](http://www.t10.org/drafts.htm#SCSI3_CMNDSETS)). This clause describes the specific implementation.

The TEST UNIT READY command reports when there is a medium in the drive that is ready to accept medium access commands. If a medium is loaded and a problem is detected that does not force the automatic ejection of the medium, GOOD status will still be returned to the TEST UNIT READY command. Whatever error is detected is returned in response to the next medium access command.

**Table 146 — TEST UNIT READY CDB**

Byte	Bit							
	7	6	5	4	3	2	1	0
0	Operation Code (00h)							
1	Obsolete				Reserved			
2	Reserved							
3	Reserved							
4	Reserved							
5	Control Byte (see 5.1.2.3)							

#### 5.2.41 VERIFY (6) - 13h

The VERIFY command is defined in SSC (see the latest version at [http://www.t10.org/drafts.htm#SCSI3\\_CMNDSETS](http://www.t10.org/drafts.htm#SCSI3_CMNDSETS)). This clause describes the specific implementation. The VERIFY (6) command (see table 147) requests that the device server verify one or more logical block(s) or one

or more logical file(s) beginning at the current logical position. Prior to performing the verify operation, the device server performs a synchronize operation (see 4.2.11).

**Table 147 — VERIFY (6) CDB**

Byte	Bit								
	7 msb	6	5	4	3	2	1	0 lsb	
0	OPERATION CODE (13h)								
1	Reserved	VTE	VLBPM	VBF	IMMED	BYTCMP	FIXED		
2	(MSB)	VERIFICATION LENGTH						(LSB)	
4									
5	Control Byte (see 5.1.2.3)								

The following parameters apply:

- **VTE (verify to end-of-data):** If the VTE bit is set to zero, then a verify to EOD is not requested.  
If the VTE bit is set to one, then the expected verification sequence termination condition is met when EOD is encountered. If a filemark is encountered during the sequence, processing continues. If the verify command fails, then the VALID bit and the INFORMATION field of sense data are set to zero. The VBF bit shall be set to zero. The VERIFICATION LENGTH field is ignored.
- **VLBPM (verify logical block protection method):** This bit has no effect. The result is the same for either setting.
- **VBF (verify by filemarks):** If the VBF bit is set to zero, then a verify of n filemarks is not requested.  
If the VBF bit is set to one, then the expected verification sequence termination condition is met if the number of filemarks specified by the VERIFICATION LENGTH field have been traversed. If a filemark is encountered during the sequence, processing continues. If EOD is encountered, the sense key is set to BLANK CHECK, the EOM bit is set to one if the logical position is at or after early warning, and the additional sense code is set to END-OF-DATA DETECTED. If a verify operation fails, then the verification sequence terminates and the VALID bit is set to one and the INFORMATION FIELD is set to the requested verification length minus the actual number of filemarks successfully traversed. The VTE bit shall be set to zero.

NOTE 30 - Following the completion of a verify with the VBF bit set to one, the application client should issue a READ POSITION command to determine the logical object identifier associated with the current logical position.

- **IMMED (immediate) :** An IMMED bit set to zero specifies the command shall not return status until the verify sequence has completed.  
An IMMED bit set to one specifies status shall be returned as soon as the command descriptor block has been validated. Verification sequences that complete unsuccessfully generate deferred sense data indicating the reason for termination (e.g., .an incorrect length logical block is encountered and the sense data is set to indicate an incorrect length block was encountered).

NOTE 31 - In order to ensure that no errors are lost, the application client should set the IMMED bit to zero on the last VERIFY (6) command of a series of VERIFY (6) commands.

- **BYTCMP (byte compare):** Byte compare is not supported by this device. The BYTCMP bit shall be set to zero to specify the verification shall be a verification of logical blocks on the medium (e.g., CRC, ECC). No data shall be transferred from the application client to the device server.
- **FIXED:** If the VTE bit and the VBF bit are set to zero and the FIXED bit is set to one, then the expected verification sequence termination condition is met when the number of logical blocks specified in the VERIFICATION LENGTH field have been traversed. If the VERIFICATION LENGTH field is set to zero, then no logical objects are verified and the current logical position is not changed. This condition is not an error. If a filemark is encountered during the sequence, processing terminates with filemark encountered as specified in the READ(6) command (see 5.2.15). If EOD is encountered, the sense key is set to BLANK CHECK, the EOM bit is set to one if the logical position is at or after early warning, and the additional sense code is set

to END-OF-DATA DETECTED. If a verify operation fails, then the verification sequence terminates and the VALID bit is set to one and the INFORMATION FIELD is set to the requested verification length minus the actual number of logical blocks successfully traversed.

If the VTE bit and the VBF bit are set to zero and the FIXED bit is set to zero, then the expected verification sequence termination condition is met when one logical block has been traversed. The length of the verified logical block is equal to the value specified in the VERIFICATION LENGTH field. If the VERIFICATION LENGTH field is set to zero, then no logical objects are verified and the current logical position is not changed. This condition is not considered an error. If a filemark is encountered during the sequence, processing terminates with filemark encountered as specified in the READ(6) command (see 5.2.15). If EOD is encountered, the sense key is set to BLANK CHECK, the EOM bit is set to one if the logical position is at or after early warning, and the additional sense code is set to END-OF-DATA DETECTED. If a verify operation fails, then the verification sequence terminates and the VALID bit is set to one and the INFORMATION FIELD is set to the requested verification length minus the actual number of bytes successfully traversed.

A FIXED bit set to zero and either the VTE bit set to one or the VBF bit set to one specifies that the block length shall not be checked.

A FIXED bit set to one specifies that the length of verified logical blocks shall be equal to the the current block length reported in the mode parameters block descriptor. Refer to the READ(6) command (see 5.2.15) for a description of the FIXED bit and any error conditions that may result from incorrect usage.

- VERIFICATION LENGTH: The VERIFICATION LENGTH field specifies the number of bytes, logical blocks, or filemarks to traverse during verification, as specified by the VBF bit and the FIXED bit. If the VTE bit is set to one, then the VERIFICATION LENGTH field is ignored. If the VERIFICATION LENGTH field is set to zero and the VTE bit is set to zero, then no logical objects are verified and the current logical position is not changed. This condition is not considered an error.

General Read-Type Handling (see 4.12.1 on page 47) provides additional information.

### 5.2.42 WRITE - 0Ah

The WRITE command is defined in SSC (see the latest version at [http://www.t10.org/drafts.htm#SCSI3\\_CMNDSETS](http://www.t10.org/drafts.htm#SCSI3_CMNDSETS)). This clause describes the specific implementation.

**Table 148 — WRITE CDB**

Byte	Bit							
	7 msb	6	5	4	3	2	1	0 lsb
0	OPERATION CODE (0Ah)							
1	Obsolete (LUN)			Reserved				FIXED
2	TRANSFER LENGTH							
4	MSB							LSB
5	Control Byte (see 5.1.2.3)							

The following parameters apply:

- FIXED (see 4.11)
- TRANSFER LENGTH (see 4.11)

See Data Transfer, Block Limits, and Fixed Block Option (see 4.11 on page 47) for rules on EOM processing.

### 5.2.43 WRITE ATTRIBUTE - 8Dh

The WRITE ATTRIBUTE command is defined in SPC-4 (see the latest version at [http://www.t10.org/drafts.htm#SCSI3\\_CMNDSETS](http://www.t10.org/drafts.htm#SCSI3_CMNDSETS)). This clause describes the specific implementation.

The WRITE ATTRIBUTE command (see table 149) allows an application client to write attributes to medium auxiliary memory. The READ ATTRIBUTE command (see 5.2.13) is used to read these attribute. Application



clients should issue READ ATTRIBUTE commands prior to using this command to discover device server support for medium auxiliary memory.

**Table 149 — WRITE ATTRIBUTE CDB**

Bit Byte	7	6	5	4	3	2	1	0
0	OPERATION CODE (8Dh)							
1	Reserved							WTC
2	Reserved							
4	Reserved							
5	VOLUME NUMBER (00h)							
6	Reserved							
7	PARTITION NUMBER							
8	Reserved							
9	Reserved							
10	(MSB)	PARAMETER LIST LENGTH						(LSB)
13	Reserved							
14	Reserved							
15	Control Byte (see 5.1.2.3)							

The following parameters apply:

**Byte Description**

0 OPERATION CODE (8Dh)

1

**Bit Description**

7-1 Reserved

0 WTC - Write-through cache

**Value Description**

0b The attributes in the parameter list may be cached.

1b The attributes in the parameter list shall be synchronized with the medium auxiliary memory during the processing of the WRITE ATTRIBUTE command and GOOD status shall not be returned until the attributes have been synchronized with the medium auxiliary memory.

2-4 Reserved

5 VOLUME NUMBER (00h)

6 Reserved

7 PARTITION NUMBER - The number of the partition to which these attributes belong. This shall be zero if there is only one partition on the volume.

8-9 Reserved

10-13 PARAMETER LIST LENGTH - The length in bytes of the parameter list contained in the Data-Out Buffer. A parameter list length of zero specifies that no parameter data is present; this shall not be considered an error. If the parameter list length results in the truncation of an attribute, the WRITE ATTRIBUTE command is terminated with CHECK CONDITION status, with the sense key set to ILLEGAL REQUEST, and the additional sense code set to PARAMETER LIST LENGTH ERROR.

14 Reserved

15 CONTROL (see 5.1.2.3)

The parameter list shall have the format shown in table 150. Attributes shall be sent in ascending numerical order. If the attributes are not in order, then no attributes are changed and the WRITE ATTRIBUTE command is terminated with CHECK CONDITION status, with the sense key set to ILLEGAL REQUEST, and the additional sense code set to INVALID FIELD IN PARAMETER LIST.

**Table 150 — WRITE ATTRIBUTE parameter list format**

Bit Byte	7	6	5	4	3	2	1	0	
0	(MSB) _____								
3	PARAMETER DATA LENGTH (n-3)								(LSB)
	Attribute(s)								
4	_____								_____
	Attribute 0 (see 6.5)								
	:								
	_____								_____
n	Attribute x (see 6.5)								

The PARAMETER DATA LENGTH field should contain the number of bytes of attribute data and shall be ignored by the device server.

The format of the attributes is described in READ ATTRIBUTE - 8Ch (see 5.2.16 on page 108).

If there is not enough space to write the attributes to the medium auxiliary memory, then no attributes shall be changed and the WRITE ATTRIBUTE command shall be terminated with CHECK CONDITION status, with the sense key set to ILLEGAL REQUEST, and the additional sense code set to AUXILIARY MEMORY OUT OF SPACE.

If the medium auxiliary memory is not accessible because there is no medium present, then no attributes shall be changed and the WRITE ATTRIBUTE command shall be terminated with CHECK CONDITION status, with the sense key set to NOT READY, and the additional sense code set to MEDIUM NOT PRESENT.

If the medium is present but the medium auxiliary memory is not accessible, then no attributes shall be changed and the WRITE ATTRIBUTE command shall be terminated with CHECK CONDITION status, with the sense key set to MEDIUM ERROR, and the additional sense code set to LOGICAL UNIT NOT READY, AUXILIARY MEMORY NOT ACCESSIBLE.

If the medium auxiliary memory is not operational (e.g., bad checksum), the WRITE ATTRIBUTE command shall be terminated with CHECK CONDITION status, with the sense key set to MEDIUM ERROR, and the additional sense code set to AUXILIARY MEMORY WRITE ERROR.

If the WRITE ATTRIBUTE command parameter data contains an attribute with an ATTRIBUTE LENGTH field set to zero, then one of the following actions shall occur:

- a) if the attribute state is unsupported or read only (see 4.20), then no attributes shall be changed and the WRITE ATTRIBUTE command shall be terminated with CHECK CONDITION status, with the sense key set to ILLEGAL REQUEST, and the additional sense code set to INVALID FIELD IN PARAMETER LIST;
- b) if the attribute state is read/write, the attribute shall be changed to the nonexistent state. This attribute shall not be returned in response to a READ ATTRIBUTE command and not be reported by the READ ATTRIBUTE command with ATTRIBUTE LIST service action; or
- c) if the attribute state is nonexistent, the attribute in the WRITE ATTRIBUTE command parameter list shall be ignored; this shall not be considered an error.

No attributes shall be changed, the WRITE ATTRIBUTE command shall be terminated with CHECK CONDITION status, with the sense key set to ILLEGAL REQUEST, and the additional sense code set to INVALID FIELD IN PARAMETER LIST if the parameter data contains any of the following:

- a) an attempt to change an attribute in the read only state;
- b) an attribute with incorrect ATTRIBUTE LENGTH field contents; or

- c) an attribute with unsupported ATTRIBUTE VALUE field contents.

#### 5.2.44 WRITE BUFFER - 3Bh

The Write Buffer command is defined in SPC (see the latest version at [http://www.t10.org/drafts.htm#SCSI3\\_CMNDSETS](http://www.t10.org/drafts.htm#SCSI3_CMNDSETS)). This clause describes the specific implementation.

The Write Buffer command is supported, but not all buffers are described in this document because most buffers are intended only to be written by the service representative or by manufacturing. OEM customers who intend to support host microcode download on a new platform should contact IBM for a complete description of the Write Buffer command for this purpose. Note that new microcode may also be loaded without requiring the use of the SCSI Write Buffer command, by using the Field Microcode Replacement (FMR) tape process described in the maintenance information manual for this product. See Supported Buffers (see 6.7.2 on page 425) for a list of the buffers supported by the drive. Table 151 shows the command format.

**Table 151 — WRITE BUFFER CDB**

Byte	Bit							
	7 msb	6	5	4	3	2	1	0 lsb
0	OPERATION CODE (3Bh)							
1	MODE SPECIFIC				MODE			
2	BUFFER ID							
3	(MSB)	BUFFER OFFSET						(LSB)
5								
6	(MSB)	PARAMETER LIST LENGTH						(LSB)
8								
9	Control Byte (see 5.1.2.3)							

The following parameters apply:

- MODE SPECIFIC: This field is valid for mode [0Dh] (WB) – Download microcode with offsets, select activation, save, and defer activate mode (see 6.7.1.11 on page 424) only. It is Reserved for other modes.

Bit	Description
7	PO_ACT (1b): Activate on Power On reset is required to be set to 1b, since deferred microcode always activates on power on reset.
6	HR_ACT (0b): Activate on Hard Reset is required to be set to 0b, since deferred microcode does not activate on a hard reset.
5	VSE_ACT: Selects whether or not to activate on medium removal.
	<b>Value</b> <b>Description</b>
	0b                              Do not set deferred microcode to be activated on medium removal (i.e., MPRSNT bit of VHF data transitions from 1b to 0b)
	1b                              Set deferred microcode to be activated on medium removal (i.e., MPRSNT bit of VHF data transitions from 1b to 0b). On control path drives (i.e., LUN 1 is enabled) this setting is allowed and ignored (i.e., an explicit activate with the mode field set 0Fh or a power on reset is required to activate the deferred microcode).

- MODE:

Value	Description
00h	MODE [00h] – Combined header and data (see 6.7.1.1 on page 421): the header is required to be all zeroes.
02h	MODE [02h] – Data (see 6.7.1.2 on page 421).
04h	MODE [04h] (WB) – Download microcode and activate (see 6.7.1.4 on page 422).
05h	MODE [05h] (WB) – Download microcode, save, and activate (see 6.7.1.5 on page 423).
06h	MODE [06h] (WB) – Download microcode with offsets and activate (see 6.7.1.6 on page 423): use of strictly increasing offsets is required.
07h	MODE [07h] (WB) – Download microcode with offsets, save, and activate (see 6.7.1.7 on page 423): use of strictly increasing offsets is required.
0Ah	MODE [0Ah] – Echo buffer (see 6.7.1.9 on page 423).
0Dh	mode [0Dh] (WB) – Download microcode with offsets, select activation, save, and defer activate mode (see 6.7.1.11 on page 424): use of strictly increasing offsets is required.
0Eh	Not Supported.
0Fh	mode [0Fh] (WB) – Activate deferred microcode mode (see 6.7.1.12 on page 424).

- BUFFER ID: The supported buffers are described in Supported Buffers (see 6.7.2 on page 425).
- BUFFER OFFSET: The relative byte location within the buffer to write the data transferred by this command.
- PARAMETER LIST LENGTH: If the BUFFER OFFSET and PARAMETER LIST LENGTH fields specify a transfer in excess of the buffer capacity, then the command is terminated with CHECK CONDITION status, with the sense key set to ILLEGAL REQUEST, and the additional sense code set to INVALID FIELD IN CDB (5/2400h).

### 5.2.45 WRITE DYNAMIC RUNTIME ATTRIBUTE - A4h[1Eh] or D2h

The WRITE DYNAMIC RUNTIME ATTRIBUTE command has a legacy format shown in table 152 and a standardized format shown in table 153.

**Table 152 — WRITE DYNAMIC RUNTIME ATTRIBUTE CDB (legacy)**

Bit Byte	7	6	5	4	3	2	1	0
0	OPERATION CODE (D2h)							
1	Reserved							
...								
5								
6	(MSB)	PARAMETER LIST LENGTH						
...								
9	(LSB)							
10	Reserved							
11	Control							

**Table 153 — WRITE DYNAMIC RUNTIME ATTRIBUTE CDB (standardized)**

Bit Byte	7	6	5	4	3	2	1	0
0	OPERATION CODE (A4h)							
1	Reserved			SERVICE ACTION (1Eh)				
2	Reserved							
...								
5								

Table 153 — WRITE DYNAMIC RUNTIME ATTRIBUTE CDB (standardized)

Bit Byte	7	6	5	4	3	2	1	0
6	(MSB)							
...	PARAMETER LIST LENGTH							
9	(LSB)							
10	Reserved							
11	Control							

### 5.2.45.1 WRITE DYNAMIC RUNTIME ATTRIBUTE parameter list

The parameter list shall have the format shown in table 154. Attributes that may be changed in a WRITE DYNAMIC RUNTIME ATTRIBUTE command are the initiator type attributes listed in 6.1.2.4.

Table 154 — WRITE DYNAMIC RUNTIME ATTRIBUTE parameter list

Bit Byte	7	6	5	4	3	2	1	0
0	RESERVED							
...	RESERVED							
7	RESERVED							
	Attribute(s) (see 6.1)							
8	Attribute 0 (see 6.1.1)							
...	Attribute 0 (see 6.1.1)							
	Attribute x (see 6.1.1)							
...	Attribute x (see 6.1.1)							
n	Attribute x (see 6.1.1)							

If an attribute that is not an initiator type is sent in the list of attributes, then this shall not be considered an error, the attribute shall be ignored, and the remaining attributes shall be processed normally.

The device server shall process attributes in the order received. Attributes shall be sent in ascending order by attribute identifier. If the attributes are not in order, then no attributes shall be changed and the WRITE DYNAMIC RUNTIME ATTRIBUTE command shall be terminated with CHECK CONDITION status, with the sense key set to ILLEGAL REQUEST, and the additional sense code set to INVALID FIELD IN PARAMETER LIST.

If an attribute that requires creation of that attribute is sent in the list of attributes and there are no available resources to create that attribute, then all attributes for which there are resources shall be changed and the WRITE DYNAMIC RUNTIME ATTRIBUTE command shall be terminated with a CHECK CONDITION with the sense code set to RECOVERED ERROR and the additional sense code set to INSUFFICIENT RESOURCES (i.e., 1h / 5503h).

If the WRITE DYNAMIC RUNTIME ATTRIBUTE command parameter data contains an attribute with an ATTRIBUTE LENGTH field (see 6.1.1) set to zero, then one of the following actions shall occur:

- a) if the attribute state is unsupported or read only (see 6.1.1), then the attribute shall not be changed and the WRITE DYNAMIC RUNTIME ATTRIBUTE command shall continue processing normally; this shall not be considered an error;
- b) if the attribute state is read/write, the attribute shall be changed to the nonexistent state. This attribute shall not be returned in response to a READ DYNAMIC RUNTIME ATTRIBUTE command; or

- c) if the attribute state is nonexistent, the attribute in the WRITE ATTRIBUTE command parameter list shall be ignored; this shall not be considered an error.

If the WRITE DYNAMIC RUNTIME ATTRIBUTE command parameter data contains an attribute with an ATTRIBUTE LENGTH set to a non-zero value other than that specified in 6.1.2.4, then one of the following actions shall occur:

- a) if the FORMAT is not ASCII, then the attribute shall be ignored; or  
 b) if the FORMAT is ASCII, then the attribute shall be:  
 A) truncated to the length specified in 6.1.2.4; or  
 B) ignored.

If the parameter list length results in the truncation of an attribute, the command shall be processed normally but the truncated attribute shall be ignored.

### 5.2.46 WRITE FILEMARKS - 10h

The Write Filemarks command is defined in SSC (see the latest version at [http://www.t10.org/drafts.htm#SCSI3\\_CMNDSETS](http://www.t10.org/drafts.htm#SCSI3_CMNDSETS)). This clause describes the specific implementation.

**Table 155 — WRITE FILEMARKS CDB**

Byte	Bit							
	7 msb	6	5	4	3	2	1	0 lsb
0	OPERATION CODE (10h)							
1	Obsolete			Reserved			Obsolete	IMMED
2	(MSB)	FILEMARK COUNT						(LSB)
4								
5	Control Byte (see 5.1.2.3)							

The following parameters apply:

- IMMED (Immediate):
 

Value	Description
0b	present status when command is completed.
1b	present status when command is verified.
- FILEMARK COUNT: The number of filemarks to be written.

The initiator may issue a WRITE FILEMARKS command with the IMMEDIATE bit set to 0b and the FILEMARK COUNT set to zero to ensure that all buffered data and filemarks are successfully written to the medium (synchronized).

See Data Transfer, Block Limits, and Fixed Block Option (see 4.11 on page 47) for rules on EOM processing.

A WRITE FILEMARK with FILEMARK COUNT set to zero when there is no data in the buffer to be synchronized always returns GOOD Status even if the volume is a WORM volume and:

- a) the media is not at a writable location; or  
 b) the WORM volume has been tampered with.

On eServer enabled drives, the msb of the vendor specific field in the control byte (i.e., bit 7) is ignored.

## 6. Parameters for SCSI Commands

This clause describes the parameters used in SCSI commands that are supported on LUN 0.

Parameters are described in a “term-definition” format. In this format, the bits or bytes to be described are highlighted and listed on the left. The definition for the bits or bytes is to the right (not highlighted).

The following is a list of abbreviations used to describe the various parameters referenced in this document as well as a reference to the parameter clause in which those specific parameters are defined:

<b>Term</b>	<b>Description</b>
DRA	Dynamic runtime attributes (DRA) (see 6.1 on page 187)
Diag	Diagnostic Parameters (Diag) (see 6.2 on page 195)
IP	Inquiry Vital Product Data Parameters (IP) (see 6.3 on page 227)
LP	Log Parameters (LP) (see 6.4 on page 255)
MAM	Medium auxiliary memory attributes (MAM) (see 6.5 on page 349)
MP	Mode Parameters (MP) (see 6.6 on page 359)
RB	Read/Write Buffers (RB) (see 6.7 on page 421)
SPP	Security Protocol Parameters (SPP) (see 6.8 on page 439)





## 6.1 Dynamic runtime attributes (DRA)

### 6.1.1 Attribute format

Each dynamic runtime attribute shall be communicated between the application client and device server in the format shown in table 156. This format shall be used in the parameter data for the WRITE DYNAMIC RUNTIME ATTRIBUTE command (see 5.2.45) and the READ DYNAMIC RUNTIME ATTRIBUTE command (see 5.2.19). The attribute format in this standard implies nothing about the physical representation of an attribute in memory.

**Table 156 — DRA ATTRIBUTE format**

Bit Byte	7	6	5	4	3	2	1	0
0	(MSB) _____							
1	I_T NEXUS INDEX							(LSB)
2	(MSB) _____							
3	ATTRIBUTE IDENTIFIER							(LSB)
4	READ ONLY	Reserved				FORMAT		
5	(MSB) _____							
...	ATTRIBUTE LENGTH (n-8)							_____
8								(LSB)
9	_____							
...	ATTRIBUTE VALUE							_____
n	_____							

The I\_T NEXUS INDEX field contains an index associated to the I\_T\_L nexus by the device server. How the I\_T nexus index is maintained is not specified by this standard. The I\_T nexus index association may change from one command to another. On a read the value of 0000h in the I\_T NEXUS INDEX field indicates that there is no I\_T\_L nexus associated with the attribute specified by the ATTRIBUTE IDENTIFIER field. The device server shall set the I\_T NEXUS INDEX field to 0000h in the logical unit type attributes. On a write the I\_T NEXUS INDEX field should be set to 0000h by the application client and the device server shall ignore the value and fill in the I\_T NEXUS INDEX field of the stored attribute with the value of the associated I\_T\_L nexus through which the command arrived. A value of FFFFh is reserved.

The ATTRIBUTE IDENTIFIER field contains a code value identifying the attribute (see 6.1.2).

The READ ONLY bit indicates whether the attribute is in the read only state (see 6.1.1). If an attribute is not in the non-existent state or the unsupported state and the READ ONLY bit is set to one, the attribute is in the Read Only state. If an attribute is not in the non-existent state or the unsupported state and the READ ONLY bit is set to zero, then the attribute is in the Read/Write state.

The FORMAT field (see table 157) specifies the format of the data in the ATTRIBUTE VALUE field.

**Table 157 — DRA attribute FORMAT field**

Format	Name	Description
00b	BINARY	The ATTRIBUTE VALUE field contains binary data.
01b	ASCII	The ATTRIBUTE VALUE field contains left-aligned ASCII data (see 4.4.1).
10b-11b		Reserved

The ATTRIBUTE LENGTH field specifies the length in bytes of the ATTRIBUTE VALUE field. If the ATTRIBUTE LENGTH field is set to zero, then there is no ATTRIBUTE VALUE field.

The ATTRIBUTE VALUE field contains the current value, for the READ DYNAMIC RUNTIME ATTRIBUTE command (see 5.2.19), or intended value, for the WRITE DYNAMIC RUNTIME ATTRIBUTE command (see 5.2.45), of the attribute (see 6.1.2).

## 6.1.2 Attribute identifier values

### 6.1.2.1 Attribute identifier values overview

The values in the ATTRIBUTE IDENTIFIER field (see 6.1.1) are assigned according to the attribute type (see 6.1) (see table 158).

**Table 158 — DRA attribute identifier range assignments**

Attribute Identifiers	Attribute Type	Subclause
0000h to 07FFh	Logical unit	6.1.2.2
1000h to 13FFh	Target	6.1.2.3
1800h to 1BFFh	Initiator	6.1.2.4
others	Reserved	

Devices that support this feature accept and process a WRITE DYNAMIC RUNTIME ATTRIBUTE command containing Initiator type attribute identifier values (i.e., 1800h to 1BFFh) and may be checked as described in 6.1.2.4.

### 6.1.2.2 Logical unit type attributes

Logical unit type attributes (see table 159) shall be maintained and updated by the device server. All supported logical unit type attributes shall have a status of read only (see 6.1).

**Table 159 — DRA Logical unit type attributes**

Attribute Identifier	Name	Attribute Length (in bytes)	Format	Subclause
0000h	Number of I_T nexuses supported by the Dynamic Runtime Attributes	2	BINARY	6.1.2.2.2
0001h	Timestamp when processed	12	BINARY	6.1.2.2.3
0010h	Reservation Information	V	BINARY	6.1.2.2.4
0011h	Registration Information	V	BINARY	6.1.2.2.5
0012h	Prevent Allow Medium Removal Information	V	BINARY	6.1.2.2.6
0013h	Last failed reservation	V	BINARY	6.1.2.2.7
others	Reserved			
<b>V - Variable</b>				

#### 6.1.2.2.1 I\_T\_L nexus identifying information descriptor

Attributes may contain one or more I\_T\_L nexus identifying information descriptors. The format of the I\_T\_L nexus identifying information descriptor is defined in table 160.

**Table 160 — DRA I\_T\_L nexus identifying information format**

Bit Byte	7	6	5	4	3	2	1	0
0	I_T_L NEXUS IDENTIFYING INFORMATION LENGTH (n-3)							
...								
3								
4	(MSB)	TIMESTAMP PARAMETER DATA LENGTH (0Ah)						
...								
5	(LSB)							
6	Reserved				TIMESTAMP ORIGIN			
7	Reserved							
8	(MSB)	ATTRIBUTE CREATION TIME						
...								
13	(LSB)							
14	Reserved							
15	Reserved							
16	TARGET TYPE ATTRIBUTES LIST LENGTH (x-19)							
...								
19								
Target type attributes(s) (see 6.1.2.3)								
20	Target type attributes [first]							
...								
...								
x	INITIATOR TYPE ATTRIBUTES LIST LENGTH (n-(x+4))							
x+1								
x+4								
Initiator type attributes(s) (see 6.1.2.4)								
x+5	Initiator type attributes [first]							
...								
...								
n								

The I\_T\_L NEXUS IDENTIFYING INFORMATION LENGTH field specifies the amount of data to follow.

The TIMESTAMP PARAMETER DATA LENGTH field specifies the number of following bytes used for the timestamp.

The TIMESTAMP ORIGIN field is defined in Device Clocks (see 4.17 on page 61).

The ATTRIBUTE CREATION TIME field contains the timestamp value (see 5.14) expressed in milliseconds when the attribute was created.

The TARGET TYPE ATTRIBUTES LIST LENGTH field specifies the length of the following target type attributes.

The target type attributes shall be listed in order by I\_T NEXUS INDEX and ATTRIBUTE IDENTIFIER. The I\_T NEXUS INDEX in this list is from the time the attribute was created and may be a different value than the I\_T NEXUS INDEX associated with this I\_T nexus at the time the READ DYNAMIC RUNTIME ATTRIBUTE is processed.

The INITIATOR TYPE ATTRIBUTES LIST LENGTH field specifies the length of the following initiator type attributes.

The initiator type attributes shall be listed in order by I\_T NEXUS INDEX and ATTRIBUTE IDENTIFIER. The I\_T NEXUS INDEX in this list is from the time the attribute was created and may be a different value than the I\_T NEXUS INDEX associated with this I\_T nexus at the time the READ DYNAMIC RUNTIME ATTRIBUTE is processed.

**6.1.2.2.2 Number of I\_T nexuses supported by dynamic runtime attributes:** Indicates the maximum number of instances of target type attributes and initiator type attributes.

**6.1.2.2.3 Timestamp when processed:** Timestamp when the READ DYNAMIC RUNTIME ATTRIBUTE command that returns this attribute is processed. The DYNAMIC RUNTIME ATTRIBUTE VALUE field of the timestamp when processed attribute format is the value that would be returned by the REPORT TIMESTAMP parameter data format (see 6.28).

**6.1.2.2.4 Reservation Information attribute:** The DYNAMIC RUNTIME ATTRIBUTE VALUE field of the Reservation Information attribute is the list of I\_T\_L nexus identifying information for each I\_T\_L nexus that is a reservation holder. The DYNAMIC RUNTIME ATTRIBUTE VALUE field of the Reservation Information attribute is shown in table 161.

**Table 161 — Reservation Information Dynamic Runtime Attribute value format**

Bit Byte	7	6	5	4	3	2	1	0
0	RESERVATION TYPE							
1	Reserved							
	I_T_L nexus identifying information descriptor(s) (see 6.1.2.2.1)							
2	I_T_L nexus identifying information (see 6.1.2.2.1) (first)							
...								
m	:							
x								
...	I_T_L nexus identifying information (see 6.1.2.2.1) (last)							
y								

The RESERVATION TYPE field shall contain the reservation type as defined in table 162.

**Table 162 — DRA RESERVATION TYPE values**

Code	Reservation Type
Persistent Reservations are in the range 00h - 0Fh	
00h	Persistent Reserve - Obsolete
01h	Persistent Reserve - Write Exclusive
02h	Persistent Reserve - Obsolete
03h	Persistent Reserve - Exclusive Access
04h	Persistent Reserve - Obsolete
05h	Persistent Reserve - Write Exclusive – Registrants Only
06h	Persistent Reserve - Exclusive Access – Registrants Only
07h	Persistent Reserve - Write Exclusive – All Registrants
08h	Persistent Reserve - Exclusive Access – All Registrants
09h - 0Fh	Persistent Reserve - Reserved
10h	SPC-2 Reserve
11h - FFh	Reserved

Each I\_T\_L nexus identifying information descriptor is a snapshot of the I\_T\_L nexus identifying information for an I\_T\_L nexus when a reservation is created by that I\_T\_L nexus or when that I\_T\_L nexus joins the reservation as a reservation holder. The Reservation Information attribute is created and an I\_T\_L nexus identifying information descriptor is created and added to the list when an I\_T\_L nexus reserves the logical unit with a PERSISTENT RESERVE OUT command or an SPC-2 RESERVE. Other I\_T\_L nexus identifying information descriptors are created for each I\_T\_L nexus that is a reservation holder, if any. This may be due to receipt of a PERSISTENT RESERVE OUT command or due to already registered I\_T\_L nexuses when an ALL REGISTRANTS type reservation is created. When an I\_T\_L nexus is no longer a reservation holder either due to the receipt of a PERSISTENT RESERVE OUT command to unregister the I\_T\_L nexus or the removal of the reservation holder as a side effect to some event that occurs (e.g., PREEMPT) the I\_T\_L nexus identifying information descriptor related to that I\_T\_L nexus shall be removed from the list. When the last I\_T\_L nexus identifying information descriptor has been removed and the reservation is removed the Reservation Information attribute shall be destroyed.

**6.1.2.2.5 Registration Information attribute:** The DYNAMIC RUNTIME ATTRIBUTE VALUE field of the Registration Information dynamic runtime attribute contains the list of I\_T\_L nexus identifying information descriptors for each I\_T\_L nexus that is registered for a persistent reservation. The DYNAMIC RUNTIME ATTRIBUTE VALUE field of the Registration Information dynamic runtime attribute is shown in table 163.

**Table 163 — Registration Information Dynamic Runtime Attribute value format**

Bit Byte	7	6	5	4	3	2	1	0
0	I_T_L nexus identifying information (see 6.1.2.2.1) (first)							
...								
m								
	⋮							
x	I_T_L nexus identifying information (see 6.1.2.2.1) (last)							
...								
y								

Each I\_T\_L nexus identifying information descriptor is created and added to the list when an I\_T\_L nexus registers with a PERSISTENT RESERVE OUT command. When an I\_T\_L nexus is no longer registered either

due to a PERSISTENT RESERVE OUT command is received to unregister or the registration is removed as a side effect to some event that occurs the I\_T\_L nexus identifying information descriptor related to that I\_T\_L nexus shall be removed from the list. When the last I\_T\_L nexus identifying information descriptor has been removed the Registration Information attribute shall be destroyed.

**6.1.2.2.6 Prevent Allow Medium Removal Information attribute:** The DYNAMIC RUNTIME ATTRIBUTE VALUE field of the Prevent Allow Medium Removal Information attribute is the list of I\_T\_L nexus identifying information for each I\_T\_L nexus that has prevented media removal. The DYNAMIC RUNTIME ATTRIBUTE VALUE field of the Prevent Allow Medium Removal Information attribute is shown in table 164.

**Table 164 — Prevent Allow Medium Removal Information Dynamic Runtime Attribute value format**

Bit Byte	7	6	5	4	3	2	1	0
0	I_T_L nexus identifying information (see 6.1.2.2.1) (first)							
...								
m								
	⋮							
x	I_T_L nexus identifying information (see 6.1.2.2.1) (last)							
...								
y								

Each I\_T\_L nexus identifying information descriptor is created and added to the list when a volume's removal is prevented due to a PREVENT ALLOW MEDIUM REMOVAL command received from that I\_T\_L nexus identifying information (i.e., the ATTRIBUTE CREATION TIME field is set to the time the PREVENT ALLOW REMOVAL command with the PREVENT bit set to one is received through that I\_T\_L nexus.) When an I\_T\_L nexus no longer prevents medium removal (e.g., a PREVENT ALLOW MEDIUM REMOVAL command with the PREVENT bit set to zero is received through that I\_T\_L nexus) the I\_T\_L nexus identifying information descriptor related to that I\_T\_L nexus shall be removed from the list. When the last I\_T\_L nexus identifying information descriptor has been removed from the list the Prevent Allow Medium Removal Information attribute shall be destroyed.

**6.1.2.2.7 Last failed reservation attribute:** Indicates the I\_T\_L nexus that last failed to get a reservation due to a reservation conflict. The DYNAMIC RUNTIME ATTRIBUTE VALUE field of the Last failed reservation attribute contains the I\_T\_L nexus identifying information (see 6.1.2.2.1) for the I\_T\_L nexus that last received a RESERVATION CONFLICT to one of the following commands:

- a) PERSISTENT RESERVE OUT;
- b) PERSISTENT RESERVE IN;
- c) RESERVE (see SPC-2); and
- d) RELEASE (see SPC-2).

### 6.1.2.3 Target type attributes

Target type attributes (see table 165) shall be maintained and updated by the device server. All supported target type attributes shall have a status of read only (see 6.1)..

**Table 165 — DRA Target type attributes**

Attribute Identifier	Name	Attribute Length (in bytes)	Format	Subclause
1000h	TransportID	24	BINARY	6.1.2.3.1
1001h	Target port ID (relative port identifier)	2	BINARY	6.1.2.3.2
1002h	Last access time	12	BINARY	6.1.2.3.3
1003h to 13FFh	Reserved			
<b>V - Variable</b>				

**6.1.2.3.1 TransportID:** Indicates the TransportID of the initiator port associated with this I\_T\_L nexus.

**6.1.2.3.2 Target port ID:** Indicates the relative target port identifier of the target port associated with this I\_T\_L nexus.

**6.1.2.3.3 Last access time:** Time of most recent command that effects the volume received through this I\_T\_L nexus.

**Table 166 — DRA Last access time format**

Bit Byte	7	6	5	4	3	2	1	0
0	(MSB) _____							
1	TIMESTAMP PARAMETER DATA LENGTH (0Ah)							(LSB)
2	Reserved				TIMESTAMP ORIGIN			
3	Reserved							
4	(MSB) _____							
...	ACCESS TIME							
9	(LSB)							
10	Reserved							
11	Reserved							

The TIMESTAMP ORIGIN FIELD contains the origin of the timestamp used in the ACCESS TIME field.

The ACCESS TIME field contains the timestamp value when the most recent command was received through this I\_T\_L nexus that is not in the following list:

- a) INQUIRY;
- b) LOG SENSE;
- c) MODE SENSE;
- d) READ DYNAMIC RUNTIME ATTRIBUTE;
- e) PERSISTENT RESERVE IN;
- f) REPORT LUNS;
- g) REQUEST SENSE; or
- h) TEST UNIT READY.

### 6.1.2.4 Initiator type attributes

Application clients may use the WRITE DYNAMIC RUNTIME ATTRIBUTE and READ DYNAMIC RUNTIME ATTRIBUTE commands to maintain initiator type attributes. All existent initiator type attributes shall follow the definition specified in table 167. All attributes, once created, shall exist until deleted by a WRITE DYNAMIC RUNTIME ATTRIBUTE command or until a power on event.

**Table 167 — DRA Initiator type attributes**

Attribute Identifier	Name	Attribute Length (in bytes)	Format	Subclause
1800h	Device special file name (DSFN)	1..32	ASCII	6.1.2.4.1
1801h	Data path failover enabled path	1..4	ASCII	6.1.2.4.2
1802h	Host name (HN)	1..32	ASCII	6.1.2.4.3
1803h	Operating system (OS)	1..16	ASCII	6.1.2.4.4
1804h	Operating system version (OS_V)	1..32	ASCII	6.1.2.4.5
1805h	Device driver name (DD_N)	1..16	ASCII	6.1.2.4.6
1806h	Device driver version (DD_V)	1..16	ASCII	6.1.2.4.7
1807h	Process ID	1..8	ASCII	6.1.2.4.8
1808h to 1BFFh	Reserved			

**6.1.2.4.1 Device special file name:** Indicates the device special file name used by the application client to identify the I\_T\_L nexus (e.g., “\\.\tape0”, “/dev/rmt0”, “/dev/st0”).

**6.1.2.4.2 Data path failover enabled path:** The path that is enabled for use in the device driver when data path failover (DPF) is enabled and is being used by the thread that issued this command.

**6.1.2.4.3 Host name:** Indicates the host name of the server that contains the initiator port of the I\_T\_L nexus (e.g., “myserver3”).

**6.1.2.4.4 Operating system:** Indicates the operating system being used by the application client.

**6.1.2.4.5 Operating system version:** Indicates the version of the operating system specified in 6.1.2.4.4.

**6.1.2.4.6 Device driver name:** Indicates the name of the operating system device driver.

**6.1.2.4.7 Device driver version:** i) Indicates the version of the operating system device driver specified in 6.1.2.4.6.

**6.1.2.4.8 Process ID:** The process ID of the thread that is sending commands through this I\_T nexus.



## 6.2 Diagnostic Parameters (Diag)

Diagnostic parameters are used with the SEND DIAGNOSTIC command (see SEND DIAGNOSTIC - 1Dh (see 5.2.36 on page 171) and RECEIVE DIAGNOSTIC RESULTS - 1Ch (see 5.2.23 on page 131) for additional information on the commands).

Terms used in this clause are:

Term	Description
CD	Cryptographic Diagnostic
Diag	Diagnostic
Page	Page Code
Parm	Parameter
RcvDiag	Receive Diagnostic Results
SendDaig	Send Diagnostic

### 6.2.1 Diag Page Formats

The drive supports two diagnostic pages for normal use: Page Code 00h and 80h. Page Code 81h is for engineering use only.

#### 6.2.1.1 Page 00h

#### 6.2.1.2 SendDiag Data - Page 00h

The format for the Send Diagnostic command for page 00h is shown in table 168.

**Table 168 — SendDiag - Page 00h Parm Data**

Byte	7	6	5	4	3	2	1	0	
0	PAGE CODE (00h)								
1	Reserved								
2	(MSB)	PAGE LENGTH (n-3)							
3								(LSB)	

Byte	Description
0	Page Code: 00h
1	Reserved (00h)
2-3	Page Length: 0000h

## 6.2.1.3 RcvDiag Data - Page 00h

The format for the Receive Diagnostic Results data for Page 00h is shown in table 169

**Table 169 — RcvDiag - Page 00h Parm Data**

Byte	7	6	5	4	3	2	1	0
0	PAGE CODE (00h)							
1	Reserved							
2	(MSB)	PAGE LENGTH (0002h)						(LSB)
3								
4	PAGE CODE SUPPORTED (00h)							
5	PAGE CODE SUPPORTED (80h)							

**Byte Description**

0	PAGE CODE: 00h
1	Reserved
2-3	PAGE LENGTH: 0002h
4	PAGE CODE SUPPORTED: 00h
5	PAGE CODE SUPPORTED: 80h: For Supported Page 80h Diags (see 6.2.2 on page 206)

### 6.2.1.4 Page 80h

Page Code 80h is a general purpose page for sending flags and diagnostic parameters to the target.

#### 6.2.1.4.1 SendDiag - Page 80h

The format for the Send Diagnostic command is shown in table 170

**Table 170 — SendDiag - Page 80h Parm Data**

Byte	7	6	5	4	3	2	1	0
0	PAGE CODE (80h)							
1	Reserved							
2	(MSB)	PAGE LENGTH (n-3)						(LSB)
3								
4	DIAGNOSTIC ID							
5								
6	FLAGS							CR
7	Reserved							
8	Diagnostic Parameters							
n								

#### Byte Description

0 PAGE CODE: 80h

1 Reserved

2-3 PAGE LENGTH (n-3)

4-5 DIAGNOSTIC ID

This field specifies the diagnostic that is to be run

6

#### Bits Description

7-1 FLAGS

0 CR (cartridge required)

Set to 1b when a cartridge is required for a diagnostic. When 1b, a cartridge must be loaded at the load point and ready for the SEND DIAGNOSTIC command to be accepted. See specific diagnostic descriptions for cartridge use: some diagnostics require this bit to be set to 1b, some require it to be set to 0b, and some do not require a specific bit setting.

- 0b: No cartridge required

- 1b: Cartridge required

7 Reserved

8-n Diagnostic Parameters

The Diagnostic Parameters field contains the parameters required to run the diagnostic.

See 6.2.2 for a list of supported diagnostic page 80h routines.

## 6.2.1.5 RcvDiag - Page 80h

The format for the Receive Diagnostic Results is shown in table 171

**Table 171 — RcvDiag Data - Page 80h Results**

Byte	Bit							
	7 msb	6	5	4	3	2	1	0 lsb
0	PAGE CODE (80h)							
1	Reserved							
2	(MSB)	PAGE LENGTH (n-3)						(LSB)
3								
4	(MSB)	DIAGNOSTIC ID						(LSB)
5								
6	FLAGS							
7	Reserved							
8								
n	Diagnostic Results							

**Byte Description**

0 PAGE CODE: 80h

1 Reserved

2-3 PAGE LENGTH (n-3)

4-5 DIAGNOSTIC ID

This field contains the same value as that sent with the Send Diagnostic command for which this response is associated.

6 FLAGS

7 Reserved

8-n Diagnostic Results

The Diagnostic Results field contains the results from the diagnostic. See RcvDiag - Page 80h Typical Results (see 6.2.1.5.1 on page 199) for what the majority of diagnostics with results generate.

See the individual Send Diagnostic parameter descriptions for the field contents. Refer to Supported Page 80h Diags (see 6.2.2) for a list of diagnostic parameters supported by the drive.

## 6.2.1.5.1 RcvDiag - Page 80h Typical Results

The typical results for diagnostics that generate results data is shown in RcvDiag Data - Page 80h Results (see Table 172 — on page 199)

Table 172 — RcvDiag Data - Page 80h Results

Byte	Bit							
	7 msb	6	5	4	3	2	1	0 lsb
0	PAGE CODE (80h)							
1	Reserved							
2	(MSB)	PAGE LENGTH (004Dh)						(LSB)
3								
4	(MSB)	DIAGNOSTIC ID						(LSB)
5								
6	FLAGS							
7	Reserved							
Diagnostic Results								
8	Reserved					DIAGNOSTIC BLOCKED	SIM/MIM PRESENT	ERROR
9	SIM/MIM message or all zeros							
80								
<p>Note 1 - The ERROR bit in byte 8 is set when the diagnostic detects an error.</p> <p>Note 2 - The SIM/MIM Present bit in byte 8 is set when a SIM or MIM message is contained in the diagnostic results.</p> <p>Note 3 - SIM/MIM messages are defined exactly as described in SIM/MIM Message (see 6.2.1.5.2 on page 201); the SIM/MIM is not valid if the SIM/MIM Present bit is 0b.</p> <p>Note 4 - The Diagnostic Blocked bit is set when the diagnostic cannot run all its tests. This occurs on some diagnostics if a cartridge is in the drive.</p>								

**Byte Description**

0	PAGE CODE: 80h
1	Reserved
2-3	PAGE LENGTH (004Dh)
4-5	DIAGNOSTIC ID
	This field contains the same value as that sent with the Send Diagnostic command for which this response is associated.
6	FLAGS
7	Reserved

8

Bit	Description
7-3	Reserved
2	DIAGNOSTIC BLOCKED: Indicates if the diagnostic was could not run all its tests, which may occur on some diagnostics if a cartridge is loaded in the drive.

Value	Description
0b	the diagnostic was not blocked from running
1b	the diagnostic was blocked from running
1	SIM/MIM PRESENT:
Value	Description
0b	a SIM or MIM message is not contained in the diagnostic results and the SIM/MIM field is set to all zeros.
1b	a SIM or MIM message is contained in the diagnostic results

0 ERROR

Value	Description
-------	-------------

9-80 SIM/MIM: This field contains a SIM/MIM Message (see 6.2.1.5.2 on page 201) or all zeros as indicated by the SIM/MIM PRESENT bit.

### 6.2.1.5.2 SIM/MIM Message

SIMs (Service Information Messages), and MIMs (Medium Information Messages) provide the initiator and operator details on service problems encountered by the device. The first 9 bytes are common to both the SIMs and the MIMs.

#### 6.2.1.5.2.1 SIM/MIM Header Data

**Table 173 — Diag SIM Data Structure**

Byte	Bit							
	7	6	5	4	3	2	1	0
0	Page Code (31h)							
1	Reserved							
2	(MSB) PAGE LENGTH (0044h) (LSB)							
3								
4	(MSB) PARAMETER CODE (0000h) (LSB)							
5								
6	PARAMETER CONTROL (61h)							
7	PARAMETER LENGTH (40h)							
8	SIM/MIM INDICATOR							
9								
71	SIM or MIM data							

#### Byte Description

0	Page Code
	<b>Bit Description</b>
	7-6 Reserved
	5-0 Page Code: 31h
1	Reserved
2-3	Page Length: 0044h
4-5	Parameter Code: 0000h
6	Parameter control byte
	<b>Bit Description</b>
	7 DU (Disable Update): 0b
	6 DS (Disable Save): 1b
	5 TSD (Target Save Disable): 1b
	4 ETC (Enable Threshold Comparison): 0b
	3-2 TMC (Threshold Met Comparison): 00b
	1 Reserved
	0 LP (List Parameter): 1b
7	Parameter length: 40h
8	SIM/MIM Indicator
	<b>Value Description</b>
	00h Bytes 9 through 71 are invalid.
	01h Bytes 9 through 71 are a SIM message. See “SIM Messages” on page 202.
	02h Bytes 9 through 71 are a MIM message. See “MIM Messages” on page 204.
	03-FF Bytes 9 through 71 are invalid.

## 6.2.1.5.2.2 SIM Messages

The following data are the parameters for the hardware SIM message

Table 174 — Diag SIM Data Structure

Byte	Bit							
	7	6	5	4	3	2	1	0
9	Reserved							
15	Reserved							
16	PRODUCT REVISION LEVEL							
19	PRODUCT REVISION LEVEL							
20	(MSB)	SIM MESSAGE CODE						(LSB)
21	SIM MESSAGE CODE							
22	Reserved							
23	Reserved							
24	EXCEPTION MESSAGE CODE							
25	SERVICE MESSAGE CODE							
26	SERVICE MESSAGE SEVERITY CODE							
27	Reserved							
28	(MSB)	EXCEPTION DATA						(LSB)
29	EXCEPTION DATA							
30	(MSB)	SCD ERROR CODE						(LSB)
33	SCD ERROR CODE							
34	(MSB)	FIRST FSC						(LSB)
37	FIRST FSC							
38	(MSB)	LAST FSC						(LSB)
41	LAST FSC							
42	(MSB)	PRODUCT ID (8000h)						(LSB)
45	PRODUCT ID (8000h)							
46	Product Identifier							
46	(MSB)	VENDOR ID "IBM"						(LSB)
48	VENDOR ID "IBM"							
49	(MSB)	PLANT OF MANUFACTURE						(LSB)
50	PLANT OF MANUFACTURE							
51	PLANT OF MANUFACTURE							
52	(MSB)	SERIAL NUMBER						(LSB)
63	SERIAL NUMBER							
64	(MSB)	DEVICE TYPE						(LSB)
71	DEVICE TYPE							

**Byte Description**

9-15 Reserved

16-19 PRODUCT REVISION LEVEL (microcode level): Same as bytes 32 - 35 in Standard Inquiry data



## 20-21 SIM MESSAGE CODE

<b>Value</b> (ASCII)	<b>Description</b>
'00'	No Message
'41'	Device Degraded. Call for Service
'42;	Device Hardware Failure. Call for Service
'43'	Service Circuits Failed, Operations Not Affected. Call for Service
'55'	Drive Needs Cleaning. Load Cleaning Cartridge
'57'	Drive Has Been Cleaned
All Others	Device Message message

## 22-23 Reserved

## 24 EXCEPTION MESSAGE CODE

<b>Value</b> (ASCII)	<b>Description</b>
'0'	Vendor-Reserved
'1'	Effect of Failure Is Unknown
'2'	Device Exception. No Performance Impact
'3;	Exception on Host Interface xx See bytes 28-29 (Exception Data xx) in this SIM record for the xx value.
'4'	Device Exception on ACF
'5'	Device Exception on Operator Panel
'6'	Device Exception on Tape Path
'7'	Device Exception in Drive
'8'	Cleaning Required
'9'	Cleaning Done
'A'-'F'	Vendor-Reserved

## 25 SERVICE MESSAGE CODE

<b>Value</b> (ASCII)	<b>Description</b>
'0'	Vendor-Reserved
'1'	Repair Impact is Unknown
'2'-'6'	Vendor-Reserved
'7'	Repair Will Disable Access to Device serno (serno refers to serial number in bytes 52-63 of this SIM record)
'9'	Clean Device
'A'	Device Cleaned
'B'	Device Cleaning For Performance Reasons is Required
'C'-'F'	Vendor-Reserved

## 26 SERVICE MESSAGE SEVERITY CODE

<b>Value</b> (ASCII)	<b>Description</b>
'0'	SIM severity code "Service"
'1'	SIM severity code "Moderate"
'2'	SIM severity code "Serious"
'3'	SIM severity code "Acute"
'4'-'9', 'A'-'F'	Vendor-Reserved

## 27 Reserved

## 28-29 EXCEPTION DATA

Interface Data is returned when byte 24 (Exception Message Code) in this SIM record contains the ASCII value '3'.

<b>Value</b> (ASCII)	<b>Description</b>
'00'	interface 0 is indicated
'01'	interface 1 is indicated

## 30-33 SCD ERROR CODE: Error code indicated on SCD (ASCII code). For example 0x00000035 for SCD '5'.

- 34-37 FIRST FSC  
 38-41 LAST FSC  
 42-45 PRODUCT ID: '8000' (these 4 bytes define "TAPE")  
 46-63 PRODUCT IDENTIFIER

Broken out into constituent bytes:

**Byte Description**

- 46-48 MANUFACTURER: "IBM"  
 49-50 PLANT OF MANUFACTURE  
 51 '-' (Dash symbol)  
 52-63 SERIAL NUMBER  
 64-71 DEVICE TYPE (device type portion of PRODUCT IDENTIFICATION; Inquiry Standard Data bytes 16-23)

### 6.2.1.5.3 MIM Messages

Media Information Messages (MIMs) are supported by this device. The following data are the parameters for the MIM

**Table 175 — Diag MIM Data Structure** (part 1 of 2)

Byte	Bit							
	7	6	5	4	3	2	1	0
9	Reserved							
15	Reserved							
16	PRODUCT REVISION LEVEL							
19	PRODUCT REVISION LEVEL							
20	(MSB)	MIM MESSAGE CODE						(LSB)
21	MIM MESSAGE CODE							
22	Reserved							
23	Reserved							
24	EXCEPTION MESSAGE CODE							
25	MEDIA MESSAGE CODE							
26	MEDIA MESSAGE SEVERITY CODE							
27	Reserved							
29	Reserved							
30	(MSB)	FAULT SYMPTOM CODE (FSC)						(LSB)
33	FAULT SYMPTOM CODE (FSC)							
34	VOLID (Volume Serial Number)							
39	VOLID (Volume Serial Number)							
38	VOLID VALID							
41	Reserved							
42	(MSB)	PRODUCT ID (8000h)						(LSB)
45	PRODUCT ID (8000h)							
46	Product Identifier							
46	(MSB)	VENDOR ID "IBM"						(LSB)
48	VENDOR ID "IBM"							
49	(MSB)	PLANT OF MANUFACTURE						(LSB)
50	PLANT OF MANUFACTURE							

Table 175 — Diag MIM Data Structure (part 2 of 2)

Byte	Bit							
	7	6	5	4	3	2	1	0
51	'L'							
52	(MSB) _____ SERIAL NUMBER _____ (LSB)							
63	(MSB) _____ DEVICE TYPE _____ (LSB)							
71	(MSB) _____ (LSB)							

**Byte Description**

9-15 Vendor-Reserved

16-19 PRODUCT REVISION LEVEL (microcode level): Same as bytes 32 - 35 in Standard Inquiry data

20-21 MIM MESSAGE CODE

**Value Description**

(ASCII)

'00' No Message

'60' Bad Media, Read Only permitted

'61' Rewrite Media if possible

'62' Tape Directory Invalid. Re-read media if possible

'64' Bad Media-Cannot Read or Write

'72' Replace Cleaner Cartridge

Others Vendor-Reserved

22-23 Reserved

24 EXCEPTION MESSAGE CODE

**Value Description**

(ASCII)

'2' Data Degraded

'4' Medium Degraded

'6' CM Error

'7' Medium Exception

Others Vendor-Reserved

25 MEDIA MESSAGE CODE

26 MEDIA MESSAGE SEVERITY CODE

**Value Description**

(ASCII)

'0' Service

'1' Moderate-High Temp Read/Write Errors Detected

'2' Serious-Permanent Read/Write Errors Detected

'3' CM Error

Others Vendor-Reserved

27-29 Reserved

30-33 FAULT SYMPTOM CODE (FSC)

34-39 VOLID (Volume Serial Number) (in ASCII). Only valid if indicated by VOLID Valid Flag (byte 40)

40 VOLID VALID

**Value Description**

(ASCII)

'0' VOLID (bytes 34-39) not valid

'1' VOLID valid, obtained from tape

'3' VOLID valid, obtained from host (MAM Attribute ID 0806 in CM)

'5' VOLID valid, obtained from library

Others Vendor-Reserved for future use (odd number will always indicate VOLID valid)

- 41 Reserved
- 42-45 PRODUCT ID: '8000' (these 4 bytes define "TAPE")
- 46-63 PRODUCT IDENTIFIER  
Broken out into constituent bytes:
- | Byte  | Description          |
|-------|----------------------|
| 46-48 | MANUFACTURER: "IBM"  |
| 49-50 | PLANT OF MANUFACTURE |
| 51    | '-' (Dash symbol)    |
| 52-63 | SERIAL NUMBER        |
- 64-71 DEVICE TYPE (device type portion of PRODUCT IDENTIFICATION; Inquiry Standard Data bytes 16-23)

### 6.2.2 Supported Page 80h Diags

Table 176 shows the supported diagnostic page 80h routines and indicates values required in the Send Diagnostic CDB. These diagnostics reside in the device (see SEND DIAGNOSTIC - 1Dh (see 5.2.36 on page 171) and RECEIVE DIAGNOSTIC RESULTS - 1Ch (see 5.2.23 on page 131) for additional information on the commands). Individual diagnostic descriptions follow table 176.

**Table 176 — Supported Page 80 Diag Routines** (part 1 of 2)

ID	Name/Description	See Page	Parm Length	Result Length <sup>b</sup>	Self Test	Dev Ofi	Unit Ofi	Cart Req'd
None	Self Test	207	0000h	-	1	X	X	-
0090h	Primary Port Wrap Test	207	0008h	0051h	0	X	X	X
0100h	POST A Self Test Diagnostic	208	0008h	0051h	0	X	X	X
0101h	POST B Performance Diagnostic <sup>a</sup>	209	0008h	0051h	0	X	1	1
0102h	POST C Media Test Diagnostic	210	0008h	0051h	0	X	1	1
0103h	POST D Head Test Diagnostic	211	0008h	0051h	0	X	1	1
0111h	Medium Calibration Audit	211	0018h	0210h	0	X	1	1
0160h	Force Dump	214	0008h	-	0	X	X	X
0161h	Write Dump to Cartridge <sup>a</sup>	215	0008h	0051h	0	X	1	1
0162h	Write Dump to FLASH (EEPROM)	-	0008h	-	0	X	X	X
0163h	Force Mini Dump	216	0008h	-	0	X	X	X
016Fh	Clear FLASH Dump (EEPROM)	-	0008h	-	0	X	X	X
0170h	Create FMR Cartridge <sup>a</sup>	216	0008h	0051h	0	X	1	1
0171h	Unmake FMR Cartridge <sup>a</sup>	217	0008h	0051h	0	X	1	0
0175h	Use FMR Cartridge	218	0008h	0051h	0	X	1	0
0190h	Set Traps	219	000Ah	-	0	X	X	X
0191h	Remove Traps	220	000Ah	-	0	X	X	X
0210h	Terminate Immediate Command	221	000Ah	-	0	X	X	1

Table 176 — Supported Page 80 Diag Routines (part 2 of 2)

ID	Name/Description	See Page	Parm Length	Result Length <sup>b</sup>	Self Test	Dev Ofi	Unit Ofi	Cart Req'd
1002h	Read Thermal Sensor	223	0008h	0051h	0	X	X	X
2002h	Reset Drive (Soft)	225	0008h	-	0	1	X	0
2003h	Reset Drive (Hard)	-	0008h	-	0	X	X	0

Legend  
- Not Applicable  
???? Variable  
<sup>a</sup> These diagnostics will destroy all data on the currently mounted cartridge.  
<sup>b</sup> GOOD status is returned for diagnostics which expect result data based solely on validation of the diagnostic. The Receive Diagnostics Results command must be used to determine the success or failure of the actual execution of such diagnostics. Diagnostic procedures are recommended above.

### 6.2.3 Diag - SelfTest: Self Test

When the SelfTest bit is 1b in the Send Diagnostic command (see SEND DIAGNOSTIC - 1Dh (see 5.2.36 on page 171) and RECEIVE DIAGNOSTIC RESULTS - 1Ch (see 5.2.23 on page 131) for additional information on the commands), the target runs the normal power-on self test (POST A) diagnostics that occur at bring-up. No diagnostic results are returned.

#### 6.2.3.1 SendDiag Command - Self Test

Table 177 shows the Send Diagnostic command format to specify Self Test (the SelfTest bit is set to 1b).

Table 177 — SendDiag CDB - Self Test

Byte	Bit							
	7 msb	6	5	4	3	2	1	0 lsb
0	Operation code (1Dh)							
1	Obsolete (LUN)			PF (1b)	Reserved (0b)	SELFTEST (1b)	DEVOFL (0b)	UNITOFL (0b)
2	Reserved (00h)							
3	(MSB)	PARAMETER LIST LENGTH (0000h)						(LSB)
4								
5	Control Byte (see 5.1.2.3)							

When the SelfTest bit is 1b in the Send Diagnostic command, the target will process its default power-on self test. If the self test successfully passes, the command is terminated with Good status. If the self test detects a failure, the command is terminated with CHECK CONDITION status and the sense key is set to Hardware Error.

#### 6.2.3.2 RcvDiag Data - Self Test

There are no diagnostic results for the self test.

### 6.2.4 Diag - 0090h: Primary port wrap test

This test will perform a wrap test on the specified primary port. A wrap tool must be attached prior to running this command. See SEND DIAGNOSTIC - 1Dh (see 5.2.36 on page 171) and RECEIVE DIAGNOSTIC RESULTS - 1Ch (see 5.2.23 on page 131) for additional information on the commands.

### 6.2.4.1 SendDiag Parm Data - Primary port wrap test

Table 178 shows the parameter data for the Send Diagnostic command.

**Table 178 — Primary Port Wrap Test SendDiag Parm Data**

Byte	7	6	5	4	3	2	1	0
0	PAGE CODE (80h)							
1	Reserved							
2	(MSB)	PAGE LENGTH (0004h)						(LSB)
3								
4	DIAGNOSTIC ID (0090h)							
5								
6	FLAGS (0000000b)							CR (0b)
7	PORT IDENTIFIER							

The following parameters apply:

- CR (cartridge required): 0b
- PORT IDENTIFIER: This field is identical to the PORT IDENTIFIER field described in IP 83h: Device Identification (see 6.3.4 on page 230). If the value of the PORT IDENTIFIER is zero, then the wrap test is performed on all primary ports. If the value is a valid port identifier, the wrap test is performed on the port indicated by the PORT IDENTIFIER field. If an invalid port identifier value is used, the drive will respond with a CHECK CONDITION for INVALID FIELD IN PARAMETER LIST.

### 6.2.4.2 RcvDiag Data - Primary port wrap test

RcvDiag - Page 80h Typical Results (see 6.2.1.5.1 on page 199) shows the diagnostic results data for this diagnostic.

### 6.2.5 Diag - 0100h: POST A

This diagnostic runs the POST A (power-on self test) diagnostics, as does running the Self Test diagnostic by setting the SelfTest bit to 1b in a Send Diagnostic command. However, unlike Self Test, the POST A diagnostic returns data through the Receive Diagnostic Results command. (see SEND DIAGNOSTIC - 1Dh (see 5.2.36 on page 171) and RECEIVE DIAGNOSTIC RESULTS - 1Ch (see 5.2.23 on page 131) for additional information on the commands)

### 6.2.5.1 SendDiag Parm Data - POST A

Table 179 shows the parameter data for the Send Diagnostic command.

**Table 179 — SendDiag Parm Data - POST A**

Byte	Bit							
	7 msb	6	5	4	3	2	1	0 lsb
0	PAGE CODE (80h)							
1	Reserved (00h)							
2	(MSB)	PAGE LENGTH (0004h)						(LSB)
3								
4	(MSB)	DIAGNOSTIC ID (0100h)						(LSB)
5								
6	FLAGS (0000000b)							CR(x)
7	Reserved							

Note 1 - The CR (Cartridge Required) flag may be set to 0b or 1b. If a cartridge is in the drive when this diagnostic is received, some diagnostics will not run. If the diagnostic is blocked because a cartridge is loaded in the drive or for any other reason, the BLOCKED bit is set in the Receive Diagnostics Results data.

### 6.2.5.2 RcvDiag Data - POST A

RcvDiag - Page 80h Typical Results (see 6.2.1.5.1 on page 199) shows the diagnostic results data for this diagnostic.

### 6.2.6 Diag - 0101h: POST B Performance

The Performance Diagnostic performs a test to determine how well the tape drive writes data. If the percentage degradation exceeds the threshold, the SEND DIAGNOSTIC command will return a CHECK CONDITION. The SENSE KEY is set to 1h and the ASC/ASCQ set to 0000h. The FSC field of sense data is set to:

- 52E5h, if the degradation is in the forward direction;
- 52E6h, if the degradation is in the backward direction; and
- 52E7h, if the degradation is in the combined forward/backward directions.

The FSC FLAG field of the sense data is set to the percentage. TapeAlert2 (Write Warning) is set and the SCD will display the character 'A.' The RECEIVE DIAGNOSTIC command will return SIM data related to the failure.

See SEND DIAGNOSTIC - 1Dh (see 5.2.36 on page 171) and RECEIVE DIAGNOSTIC RESULTS - 1Ch (see 5.2.23 on page 131) for additional information on the commands.

### 6.2.6.1 SendDiag Parm Data - POST B Performance

Table 180 shows the parameter data for the Send Diagnostic command.

**Table 180 — SendDiag Parm Data - POST B**

Byte	Bit							
	7 msb	6	5	4	3	2	1	0 lsb
0	PAGE CODE (80h)							
1	Reserved (00h)							
2	(MSB)	PAGE LENGTH (0004h)						(LSB)
3								
4	(MSB)	DIAGNOSTIC ID (0101h)						(LSB)
5								
6	FLAGS (0000000b)							CR (1b)
7	Reserved (00h)							
Note 1 - CR: Cartridge Required=1b, a cartridge must be loaded and ready.								

### 6.2.6.2 RcvDiag Data - POST B Performance

RcvDiag - Page 80h Typical Results (see 6.2.1.5.1 on page 199) shows the diagnostic results data for this diagnostic.

### 6.2.7 Diag - 0102h: POST C Media Test

#### 6.2.7.1 SendDiag Parm Data - POST C Media Test

**Table 181 — SendDiag Parm Data - POST C Media Test**

Byte	Bit							
	7	6	5	4	3	2	1	0
0	PAGE CODE (80h)							
1	Reserved							
2	(MSB)	PAGE LENGTH (0004h)						(LSB)
3								
4	(MSB)	DIAGNOSTIC ID (0102h)						(LSB)
5								
6	FLAGS (0000000b)							
7	Reserved							

### 6.2.7.2 RcvDiag Data - POST C Media Test

RcvDiag - Page 80h Typical Results (see 6.2.1.5.1 on page 199) shows the diagnostic results data for this diagnostic.



## 6.2.8 Diag - 0103h: POST D Head Test

### 6.2.8.1 SendDiag Parm Data - POST D Head Test

**Table 182 — SendDiag Parm Data - POST D Head Test**

Byte	Bit							
	7	6	5	4	3	2	1	0
0	PAGE CODE (80h)							
1	Reserved							
2	(MSB)	PAGE LENGTH (0004h)						(LSB)
3								
4	(MSB)	DIAGNOSTIC ID (0103h)						(LSB)
5								
6	FLAGS (0000000b)							
7	Reserved							

### 6.2.8.2 RcvDiag Data - POST D Head Test

RcvDiag - Page 80h Typical Results (see 6.2.1.5.1 on page 199) shows the diagnostic results data for this diagnostic.

## 6.2.9 Diag -0111h: Medium Calibration Audit

This diagnostic causes an audit of the medium optimization by performing non-destructive operations. An LTO-9 or later cartridge is required to be loaded to run this diagnostic. This diagnostic is expected to be used on a cartridge with customer data and is non-destructive in nature. Any data in the object buffer is flushed to the medium prior to performing this diagnostic. This diagnostic does move the physical position, but the logical position (i.e., that position seen by the host) does not change and any operations subsequent to the diagnostic are performed on the expected position. If an error occurs while this diagnostic is processing, a CHECK CONDITION status is returned and sense data contains error information. It is not considered an error if a volume is mounted that does not support this diagnostic. That information is reported in the Receive Diagnostic Results data (see 6.2.9.2).

See “SEND DIAGNOSTIC - 1Dh” on page 171 and “RECEIVE DIAGNOSTIC RESULTS - 1Ch” on page 131 for additional information on the commands.

### 6.2.9.1 SendDiag Parm Data - Medium Calibration Audit

Table 183 shows the parameter data for the Send Diagnostic command.

**Table 183 — SendDiag Parm Data - Medium Calibration Audit**

Byte	Bit							
	7 msb	6	5	4	3	2	1	0 lsb
0	PAGE CODE (80h)							
1	Reserved (00h)							
2	PAGE LENGTH (0014h)							
3								
4	DIAGNOSTIC ID (0111h)							
5								
6	FLAGS (0000000b)							CART REQ'D (1b)
7	AUDIT TYPE							
8	Reserved							
23								
<sup>a</sup> Cartridge Required = 1b, a cartridge must be loaded and ready.								

The following parameters apply:

#### Byte Description

0 PAGE CODE - Selects the diagnostic page as 80h which is the IBM general purpose page.

1 Reserved

2-3 PAGE LENGTH - The length in bytes of the diagnostic parameters that follow this field.

4-5 DIAGNOSTIC ID - The ID of the specific general purpose diagnostic.

6 FLAGS - Flags specific to this diagnostic.

#### Bit Description

7-1 Reserved

0 CR - Cartridge Required (1b)

#### Value Description

0b A cartridge is not required to be loaded and ready.

1b A cartridge is required to be loaded and ready.

7 AUDIT TYPE- The type of audit to perform.

#### Value Description

01h A Stoplight Medium Calibration Audit is performed.

others Reserved

8-23 Reserved

### 6.2.9.2 RcvDiag Data - Medium Calibration Audit

Table 184 shows the diagnostic results data received from the Medium Calibration Audit diagnostic.

**Table 184 — RcvDiag Data - Medium Calibration Audit**

Byte	Bit							
	7 msb	6	5	4	3	2	1	0 lsb
0	PAGE CODE (80h)							
1	Reserved							
2	PAGE LENGTH (020Ch)							
3								
4	DIAGNOSTIC ID (0111h)							
5								
6	FLAGS (00h)							
7	Reserved							
8	Common results descriptor (see 6.2.9.2.1)							
23								
24								
527	Vendor Reserved							

The following parameters apply:

#### Byte Description

0	PAGE CODE - 80h
1	Reserved
2-3	PAGE LENGTH - The length in bytes of the diagnostic parameters that follow this field.
4-5	DIAGNOSTIC ID - 0111h
6	FLAGS
7	Reserved
8-23	Common results descriptor (see 6.2.9.2.1)
24-527	Vendor reserved

#### 6.2.9.2.1 Common results descriptor

The common results descriptor contains the publicly available information related to the result.

**WARNING**

This descriptor should be dynamically parsed as its size may change.

**WARNING****WARNING****WARNING****Table 185 — Common results descriptor**

Byte	Bit							
	7 msb	6	5	4	3	2	1	0 lsb
0	DESCRIPTOR TYPE (01h)							
1	Reserved							
2	DESCRIPTOR LENGTH (000Ch)							
3								
4	AUDIT TYPE (01h)							
5	AUDIT RESULTS SUMMARY							
6								
15	Reserved							

The following parameters apply:

**Byte Description**

0      DESCRIPTOR TYPE (01h) - Common results descriptor.

1      Reserved

2-3    DESCRIPTOR LENGTH - The length in bytes of the remaining data in this descriptor.

4      AUDIT TYPE- 01h indicating results for a Stoplight Medium Calibration Audit.

5      AUDIT RESULTS SUMMARY - Summary of the results

**Value      Description**

00h      Green

01h      Yellow

02h      Red

0Dh      Unable to determine

0Eh      No initialization media calibration data. A FORMAT MEDIUM must occur to optimize this cartridge before a Stoplight TDS Medium Calibration Audit is allowed.

**WARNING**

A FORMAT MEDIUM command destroys all user data on the cartridge.

**WARNING****WARNING****WARNING**

0Fh      Not supported - A Stoplight TDS Medium Calibration Audit is not supported for this media type.

6-15    Reserved

**6.2.10 Diag - 0160h: Force Dump**

This diagnostic forces a dump. The dump data is stored in device control storage and can be read by the READ BUFFER command (Buffer ID of 00h) (see 5.2.18).

When a higher priority dump has been generated automatically by the drive but has not yet been read, the drive will ignore this Send Diagnostic command and return GOOD status.

Because forcing a drive dump will overwrite any previously stored dump, before forcing the dump the DUMP field of the sense data should be examined to determine if a drive dump exists.

See SEND DIAGNOSTIC - 1Dh (see 5.2.36 on page 171) and RECEIVE DIAGNOSTIC RESULTS - 1Ch (see 5.2.23 on page 131) for additional information on the commands.

### 6.2.10.1 SendDiag Parm Data - Force Dump

Table 186 shows the parameter data for the Send Diagnostic command.

**Table 186 — SendDiag Parm Data - Force Dump**

Byte	Bit							
	7 msb	6	5	4	3	2	1	0 lsb
0	PAGE CODE (80h)							
1	Reserved (00h)							
2	(MSB)	PAGE LENGTH (0004h)						(LSB)
3								
4	(MSB)	DIAGNOSTIC ID (0160h)						(LSB)
5								
6	FLAGS (0000000b)							CR (x)
7	Reserved (00h)							
Note 1 - The CR (Cartridge Required) flag may be set to 0b or 1b.								

### 6.2.10.2 RcvDiag Data - Force Dump

There are no diagnostic results for this function.

### 6.2.11 Diag -0161h: Write Dump to Cartridge

This diagnostic causes dump information residing in the device control storage to be written to a cartridge without the need to retrieve the dump data across the host interface. A cartridge is required to be loaded to run the diagnostic (see SEND DIAGNOSTIC - 1Dh (see 5.2.36 on page 171) and RECEIVE DIAGNOSTIC RESULTS - 1Ch (see 5.2.23 on page 131) for additional information on the commands).

#### 6.2.11.1 SendDiag Parm Data - Write Dump to Cartridge

Table 187 shows the parameter data for the Send Diagnostic command.

**Table 187 — SendDiag Parm Data - Write Dump to Cartridge**

Byte	Bit							
	7 msb	6	5	4	3	2	1	0 lsb
0	PAGE CODE (80h)							
1	Reserved (00h)							
2	(MSB)	PAGE LENGTH (0004h)						(LSB)
3								
4	(MSB)	DIAGNOSTIC ID (0161h)						(LSB)
5								
6	FLAGS (0000000b)							CR (1b)
7	Reserved (00h)							
Note 1 - CR (Cartridge Required)=1b, a cartridge must be loaded and ready.								

#### 6.2.11.2 RcvDiag Data - Write Dump to Cartridge

RcvDiag - Page 80h Typical Results (see 6.2.1.5.1 on page 199) shows the diagnostic results data for this diagnostic.

### 6.2.12 Diag - 0163h: Force Mini Dump

This diagnostic forces a mini dump. The dump data is stored in device control storage and can be read by the READ BUFFER command (Error History buffer 11h) (see 6.7.2.7.3.3).

See SEND DIAGNOSTIC - 1Dh (see 5.2.36 on page 171) and RECEIVE DIAGNOSTIC RESULTS - 1Ch (see 5.2.23 on page 131) for additional information on the commands.

#### 6.2.12.1 SendDiag Parm Data - Force Mini Dump

Table 186 shows the parameter data for the Send Diagnostic command.

**Table 188 — SendDiag Parm Data - Force Mini Dump**

Byte	Bit							
	7 msb	6	5	4	3	2	1	0 lsb
0	PAGE CODE (80h)							
1	Reserved (00h)							
2	(MSB)	PAGE LENGTH (0004h)						(LSB)
3								
4	(MSB)	DIAGNOSTIC ID (0163h)						(LSB)
5								
6	FLAGS (0000000b)							CR (x)
7	Reserved (00h)							

Note 1 - The CR (Cartridge Required) flag may be set to 0b or 1b.

#### 6.2.12.2 RcvDiag Data - Force Mini Dump

There are no diagnostic results for this function.

### 6.2.13 Diag - 0170h: Create FMR Cartridge (not on LTO5)

See “SEND DIAGNOSTIC - 1Dh” on page 171 and “RECEIVE DIAGNOSTIC RESULTS - 1Ch” on page 131 for additional information on the commands. This diagnostic causes the device microcode to be written to a cartridge, creating a field microcode replacement (FMR) cartridge. A cartridge is required to be mounted and ready in preparation for this diagnostic. All data on the cartridge prior to running this diagnostic is lost.

After a successful completion of this diagnostic, the cartridge is an FMR cartridge that may be used to update the functional microcode load of a drive into which it is mounted.

NOTE 32 - This function is also available from maintenance mode and the library interface (i.e. LDI and ADI).

NOTE 33 - Drive microcode updates may be performed using various methods including using the WRITE BUFFER command (see Annex C), using ftp over the Ethernet port, using the library drive interface, or using an FMR cartridge. Use of an FMR cartridge to perform drive microcode updates is useful in situations where there is no access to the drive via a SCSI interface, an Ethernet port, or a library utility.

### 6.2.13.1 SendDiag Parm Data - Create FMR Cartridge

Table 189 shows the parameter data for the Send Diagnostic command.

**Table 189 — Send Diagnostic Parameter Data - Create FMR Cartridge**

Byte	Bit							
	7 msb	6	5	4	3	2	1	0 lsb
0	PAGE CODE (80h)							
1	Reserved (00h)							
2	MSB		PAGE LENGTH (0004h)				LSB	
3								
4	MSB		DIAGNOSTIC ID (0170h)				LSB	
5								
6	FLAGS (0000000b)							CR (1b)
7	Reserved (00h)							
Note 1 - CR (Cartridge Required)=1b, a cartridge must be loaded and ready.								

### 6.2.13.2 RcvDiag Results Data - Create FMR Cartridge

RcvDiag - Page 80h Typical Results (see 6.2.1.5.1 on page 199) shows the diagnostic results data for this diagnostic.

### 6.2.14 Diag - 0171h: Unmake FMR Cartridge (not on LTO5)

See “SEND DIAGNOSTIC - 1Dh” on page 171 and “RECEIVE DIAGNOSTIC RESULTS - 1Ch” on page 131 for additional information on the commands. This diagnostic prepares the drive to receive a field microcode replacement (FMR) cartridge for the purpose of changing it from an FMR cartridge to a data cartridge.

This enables the drive to accept the mounting of an FMR cartridge and to perform the processing that changes the cartridge from a field microcode replacement (FMR) cartridge to a data cartridge. All data on the cartridge is lost. This enablement is cleared:

- a) after 60 seconds;
- b) on completion of processing the FMR cartridge if that processing results in success;
- c) on completion of processing the FMR cartridge if that processing results in failure; or
- d) on the mounting of a non-FMR cartridge.

If there is a Data cartridge in the drive, mounted and ready when this diagnostic is run, then the data on partition 0 of the cartridge is lost.

If an attempt is made to load a Data cartridge when the drive is prepared to receive an FMR cartridge (i.e., after successful completion of this diagnostic and before the enablement is cleared), then the cartridge is rejected for an unsupported format.

NOTE 34 - This function is also available from maintenance mode and the library interface (i.e. LDI and ADI).

### 6.2.14.1 SendDiag Parm Data - Unmake FMR Cartridge

Table 189 shows the parameter data for the Send Diagnostic command.

**Table 190 — Send Diagnostic Parameter Data - Unmake FMR Cartridge**

Byte	Bit							
	7 msb	6	5	4	3	2	1	0 lsb
0	PAGE CODE (80h)							
1	Reserved (00h)							
2	MSB		PAGE LENGTH (0004h)				LSB	
3								
4	MSB		DIAGNOSTIC ID (0171h)				LSB	
5								
6	FLAGS (0000000b)						CR (0b)	
7	Reserved (00h)							

### 6.2.14.2 RcvDiag Results Data - Unmake FMR Cartridge

RcvDiag - Page 80h Typical Results (see 6.2.1.5.1 on page 199) shows the diagnostic results data for this diagnostic.

### 6.2.15 Diag - 0175h: Use FMR Cartridge (not on LTO5)

See “SEND DIAGNOSTIC - 1Dh” on page 171 and “RECEIVE DIAGNOSTIC RESULTS - 1Ch” on page 131 for additional information on the commands. This diagnostic prepares the drive to receive a field microcode replacement (FMR) cartridge for the purpose of updating the functional microcode load of the drive.

This enables the drive to accept the mounting of an FMR cartridge and to automatically perform the processing that updates functional microcode with code read from that cartridge. This enablement is cleared:

- a) after 60 seconds;
- b) on completion of processing the FMR cartridge if that processing results in success;
- c) on completion of processing the FMR cartridge if that processing results in failure; or
- d) on the mounting of a non-FMR cartridge.

If there is a Data cartridge in the drive, mounted and ready when this diagnostic is run, then this diagnostic fails for an invalid image.

If an attempt is made to load a Data cartridge when the drive is prepared to receive an FMR cartridge (i.e., after successful completion of this diagnostic and before the enablement is cleared), then the cartridge is rejected for an unsupported format.

NOTE 35 - This function is also available from maintenance mode and the library interface (i.e. LDI and ADI). The MUE bit of the Logical Unit subpage (see the ADI Implementation Reference) performs this same diagnostic.



### 6.2.15.1 SendDiag Parm Data - Use FMR Cartridge

Table 189 shows the parameter data for the Send Diagnostic command.

**Table 191 — Send Diagnostic Parameter Data - Use FMR Cartridge**

Byte	Bit									
	7 msb	6	5	4	3	2	1	0 lsb		
0	PAGE CODE (80h)									
1	Reserved (00h)									
2	MSB		PAGE LENGTH (0004h)						LSB	
3										
4	MSB		DIAGNOSTIC ID (0175h)						LSB	
5										
6	FLAGS (0000000b)							CR (0b)		
7	Reserved (00h)									

### 6.2.15.2 RcvDiag Results Data - Use FMR Cartridge

RcvDiag - Page 80h Typical Results (see 6.2.1.5.1 on page 199) shows the diagnostic results data for this diagnostic.

### 6.2.16 Diag - 0190h: Set Traps

This diagnostic permits a SCSI interface user to set a microcode trap that causes a dump to occur when the specified Fault Symptom Code occurs. The drive continues to operate after the dump completes (see SEND DIAGNOSTIC - 1Dh (see 5.2.36 on page 171) and RECEIVE DIAGNOSTIC RESULTS - 1Ch (see 5.2.23 on page 131) for additional information on the commands).

#### 6.2.16.1 SendDiag Parm Data - Set Traps

Table 192 shows the parameter data for the Send Diagnostic command.

**Table 192 — SendDiag Parm Data - Set Traps**

Byte	Bit									
	7 msb	6	5	4	3	2	1	0 lsb		
0	PAGE CODE (80h)									
1	Reserved (00h)									
2	(MSB)		PAGE LENGTH (0006h)						(LSB)	
3										
4	(MSB)		DIAGNOSTIC ID (0190h)						(LSB)	
5										
6	FLAGS (0000000b)							CR (x)		
7	Reserved (00h)									
8	(MSB)		FAULT SYMPTOM CODE						(LSB)	
9										

Note 1 - CR (Cartridge Required)=1, a cartridge must be loaded and ready before the diagnostic is run.

### 6.2.16.2 RcvDiag Data - Set Traps

There are no diagnostic results for this function.

### 6.2.17 Diag - 0191h: Remove Traps

See SEND DIAGNOSTIC - 1Dh (see 5.2.36 on page 171) and RECEIVE DIAGNOSTIC RESULTS - 1Ch (see 5.2.23 on page 131) for additional information on the commands.

This diagnostic removes a microcode trap that was set via the SCSI Set Traps Diagnostic.

Sending down the Remove Traps diagnostic with the FAULT SYMPTOM CODE set to 0000h will set up diagnostic results that show which traps are currently set without changing the state of any traps.

#### 6.2.17.1 SendDiag Parm Data - Remove Traps

Table 193 shows the parameter data for the Send Diagnostic command.

**Table 193 — SendDiag Parm Data - Remove Traps**

Byte	Bit							
	7 msb	6	5	4	3	2	1	0 lsb
0	PAGE CODE (80h)							
1	Reserved (00h)							
2	(MSB)	PAGE LENGTH (0006h)						(LSB)
3								
4	(MSB)	DIAGNOSTIC ID (0191h)						(LSB)
5								
6	FLAGS (0000000b)							CR (x)
7	Reserved (00h)							
8	(MSB)	FAULT SYMPTOM CODE						(LSB)
9								

### 6.2.17.2 RcvDiag Data - Remove Traps

Table 194 shows the diagnostic results data received from the Remove Traps diagnostic.

**Table 194 — RcvDiag Data - Remove Traps**

Byte	Bit							
	7 msb	6	5	4	3	2	1	0 lsb
0	PAGE CODE (80h)							
1	Reserved (00h)							
2	(MSB)	PAGE LENGTH (n-4)						(LSB)
3								
4	(MSB)	DIAGNOSTIC ID (0191h)						(LSB)
5								
6	FLAGS (00h)							
7	Reserved (00h)							
8	Reserved (00000b)					diagnostic blocked	Reserved	ERROR
List of Fault Symptom Code's with Trap still set								
9	(MSB)	FAULT SYMPTOM CODE [first]						(LSB)
10								
	⋮							
n-1	(MSB)	FAULT SYMPTOM CODE [last]						(LSB)
n								

### 6.2.18 Diag - 0210h: Terminate Immediate Command

This diagnostic terminates all processing associated with the specified command that had been previously issued with the IMMED bit set to one. The processing to be terminated is specified by the OPERATION CODE / SERVICE ACTION pair of the command that initiated the processing. If the processing specified to terminate exists, then the drive returns GOOD status after the termination of the processing is complete (i.e., termination of processing is not instantaneous). If the processing specified to terminate does not exist, then the drive behaves as specified by the setting of the CC bit. If an error occurs during the processing of this SEND DIAGNOSTIC command, GOOD status is returned and the error is reported as a deferred error to the next eligible command.

#### 6.2.18.1 Send Data – Terminate Immed Command

Table 3 shows the Send Diagnostic parameter data for the Terminate Immed Command diagnostic.

**Table 195 — Send Data – (Diag 0210h) Terminate Immed Command**

Byte	Bit							
	7 msb	6	5	4	3	2	1	0 lsb
0	PAGE CODE (80h)							
1	Reserved (00h)							
2	(MSB)	PAGE LENGTH (0006h)						(LSB)
3								
4	(MSB)	DIAGNOSTIC ID (0210h)						(LSB)
5								
6	FLAGS (0000000b)							CR(1b)

Table 195 — Send Data – (Diag 0210h) Terminate Immed Command

Byte	Bit							
	7 msb	6	5	4	3	2	1	0 lsb
7	Reserved (00h)							
8	OPERATION CODE							
9	CC	Reserved (00b)			SERVICE ACTION			

The following parameters apply:

**Byte Description**

0 PAGE CODE - Selects the diagnostic page as 80h which is the IBM general purpose page.

1 Reserved

2-3 PAGE LENGTH - The length in bytes of the diagnostic parameters that follow this field.

4-5 DIAGNOSTIC ID - The ID of the specific general purpose diagnostic.

6 FLAGS - Flags specific to this diagnostic.

**Bit Description**

7-1 Reserved

0 CR - Cartridge Required (1b)

**Value Description**

0b A cartridge is not required to be loaded and ready.

1b A cartridge must be loaded and ready.

7 Reserved

8 OPERATION CODE - The operation code of the command to terminate.

9

**Bit Description**

7 CC - Check Condition bit

**Value Description**

0b Return Good status if the command specified by the OPERATION CODE / SERVICE ACTION pair is not currently active.

1b Return Check Condition – Invalid Field in Parameter Data (5/2600) with Field pointer set to the OPERATION CODE field if the command specified by the OPERATION CODE / SERVICE ACTION pair is not currently active.

6-4 Reserved

4-0 SERVICE ACTION - The service action of the command to terminate. If there is no service action, then the service action field shall be set to zero

Table 196 lists the commands supported by the Terminate Immediate Command diagnostic.

**Table 196 — Supported Commands in the Terminate Immediate Command diagnostic**

Command	Op Code	Service Action	State of Drive after Command is Terminated
ERASE	19h	00h	The drive stops processing and leaves the medium positioned at the stopping point. Note - This cancels the long erase. If the long erase was being used as part of a process to securely erase the medium (e.g., TSM Secure Erase), then this process must be redone in order to achieve the desired complete erasure.
SEND DIAGNOSTIC	1Dh	00h	The drive stops processing, clears the buffer, and rewinds to BOP 0.
VERIFY	13h	00h	The drive stops processing and leaves the medium positioned at the stopping point. The READ POSITION command should be used to determine the current logical position of the medium. Note - The stopping point may be anywhere between the starting point and the logical position that would have resulted had the processing from the original command completed processing.

### 6.2.18.2 Results Data – Terminate Immed Command

There is no Receive Diagnostic Results data for this function.

### 6.2.19 Diag - 1002h: Read Thermal Sensor

The Read Thermal Sensor diagnostic is used to read the digital thermal sensor on the drive (see SEND DIAGNOSTIC - 1Dh (see 5.2.36 on page 171) and RECEIVE DIAGNOSTIC RESULTS - 1Ch (see 5.2.23 on page 131) for additional information on the commands).

Starting in LTO-9 it is better to get the temperature from LP 0Dh[01h]: Environmental Reporting (LTO9 and later) (see 6.4.9 on page 266) where the humidity is also reported.

#### 6.2.19.1 SendDiag Parm Data - Read Thermal Sensor

Table 197 shows the parameter data for the Read Thermal Sensor diagnostic.

**Table 197 — Diag parameter data - Read Thermal Sensor**

Byte	Bit							
	7	6	5	4	3	2	1	0
0	PAGE CODE (80h)							
1	Reserved							
2	(MSB)	PAGE LENGTH (0004h)						(LSB)
3								
4	(MSB)	DIAGNOSTIC ID (1002h)						(LSB)
5								
6	FLAGS (0000000b)							
7	Reserved							

## 6.2.19.2 RcvDiag Data - Read Thermal Sensor

Table 198 shows the diagnostic results data received from the Read Thermal Sensor diagnostic.

**Table 198 — Receive Diag parameter data - Read Thermal Sensor**

Byte	Bit								
	7	6	5	4	3	2	1	0	
0	PAGE CODE (80h)								
1	Reserved								
2	(MSB)	PAGE LENGTH (000Eh)						(LSB)	
3									
4	(MSB)	DIAGNOSTIC ID (1002h)						(LSB)	
5									
6	FLAGS (0000000b)								
7	Reserved								
8	FLAGS (00000b)					DIAG. BLOCKED	Reserved	ERROR	
9	Reserved								
10	THERMAL READING (units of °C) <sup>a</sup> (Value read by sensor)								
11	Reserved								
12	Full-Height Drives <sup>b</sup> : WARNING THRESHOLD (units of °C) <sup>a</sup> - drive raises on alert Half-Height Drives <sup>b</sup> : FAN START TEMPERATURE (units of °C) <sup>a</sup>								
13	Reserved								
14	FENCING THRESHOLD (units of °C) <sup>a</sup> - operations fenced								
15	Reserved								
16	FENCING REMOVAL THRESHOLD (units of °C) <sup>a</sup> - remove operation fence								
17	Reserved								
<sup>a</sup> A value of 00h indicates the value is not applicable <sup>b</sup> How to determine if a drive is a Full-Height drive or Half-Height drive is shown in Table 44, "Standard Inquiry Product Identification Table," on page 88.									

### 6.2.20 Diag - 2002h: Reset Drive

This diagnostic aborts all current drive operations and restarts the functional microcode. This reset is equivalent to a power on reset (see SEND DIAGNOSTIC - 1Dh (see 5.2.36 on page 171) and RECEIVE DIAGNOSTIC RESULTS - 1Ch (see 5.2.23 on page 131) for additional information on the commands).

#### 6.2.20.1 SendDiag Parm Data - Reset Drive

Table 199 shows the parameter data for the Send Diagnostic command.

**Table 199 — SendDiag Parm Data - Reset Drive**

Byte	Bit							
	7 msb	6	5	4	3	2	1	0 lsb
0	PAGE CODE (80h)							
1	Reserved (00h)							
2	(MSB)	PAGE LENGTH (0004h)						(LSB)
3								
4	(MSB)	DIAGNOSTIC ID (2002h)						(LSB)
5								
6	FLAGS (0000000b)							CR (0b)
7	Reserved (00h)							

#### 6.2.20.2 RcvDiag Command - Reset Drive

There are no diagnostic results for this function.





## 6.3 Inquiry Vital Product Data Parameters (IP)

Inquiry vital product data parameters are returned to the Inquiry command. INQUIRY - 12h (see 5.2.5 on page 84) describes how to request these pages.

### 6.3.1 IP 00h: Supported Vital Product Data Pages

- INQUIRY - 12h (see 5.2.5 on page 84) describes how to request this page.

#### 6.3.1.1 Returned Data - Inquiry Page 00h: Supported Inquiry Pages

The Supported Vital Product Data Page contains pages that the device will return.

**Table 200 — IP 00h Supported Vital Product Data Inquiry Page**

Byte	Bit							
	7	6	5	4	3	2	1	0
0	Peripheral Qualifier (000b)			Peripheral Device Type (01h)				
1	Page Code (00h)							
2	Reserved							
3	Page Length (n-3)							
	Supported VPD page list							
4	VPD Page Code [first]							
	⋮							
n	VPD Page Code [last]							

#### Byte Description

0	Peripheral Data
	<b>Bit Description</b>
	7-5 Peripheral Qualifier: 000b
	4-0 Peripheral Device Type: 01h
1	Page Code: 00h
2	Reserved
3	Page Length (n-3)

4-n Supported VPD pages: This field is a list of 1-byte long page codes and may include some or all of the following:

Code	Inquiry Page
00h	IP 00h: Supported Vital Product Data Pages (see 6.3.1 on page 227)
03h	IP 03h: Firmware Designation (see 6.3.2 on page 228)
80h	IP 80h: Unit Serial Number (see 6.3.3 on page 230)
83h	IP 83h: Device Identification (see 6.3.4 on page 230)
86h	IP 86h: Extended INQUIRY Data (see 6.3.5 on page 236)
87h	IP 87h: Mode Page Policy (see 6.3.6 on page 238)
88h	IP 88h: SCSI ports (see 6.3.7 on page 240)
90h	IP 90h: Protocol-Specific Logical Unit Information (see 6.3.8 on page 242)
B0h	IP B0h: Sequential-Access device capabilities (see 6.3.9 on page 243)
B1h	IP B1h: Manufacturer-assigned Serial Number (see 6.3.10 on page 244)
B3h	IP B3h: Automation Device Serial Number (see 6.3.11 on page 245)
B4h	IP B4h: Data Transfer Device Element Address (see 6.3.12 on page 245)
B5h	IP B5h: Logical Block Protection (see 6.3.13 on page 246)
C0h	IP C0h: Drive Component Revision Levels (see 6.3.14 on page 248)
C1h	IP C1h: Drive Serial Numbers (see 6.3.15 on page 250)
C2h	IP C2h: Drive Bar codes (see 6.3.16 on page 251)
C3h	IP C3h: Subcomponent Version List (see 6.3.17 on page 253)
C7h	IP C7h: Device Unique Configuration Data (see 6.3.18 on page 254)
C8h	IP C8h: Mode Parameter Default Settings (see 6.3.19 on page 254)
E0-EF	Vendor-Reserved (Attachment Specification Information)

NOTE 36 - Only those drives that have the AS/400® (iSeries®) attachment enabled will have valid data in pages E0h/E1h. The contents of pages E0h/E1h are not specified in this document.

NOTE 37 - The drive may report other pages in the supported VPD page list or the drive may support and return pages not specified in this document.

### 6.3.2 IP 03h: Firmware Designation

- INQUIRY - 12h (see 5.2.5 on page 84) describes how to request this page.

### 6.3.2.1 Returned Data - IP 03h: Firmware Designation

The Firmware Designation Page is used to identify which code image may be downloaded to which drive. See Firmware Download (see Annex C. on page 487) for Firmware Download procedures.

**Table 201 — IP 03h Firmware Designation Page**

Byte	Bit							
	7	6	5	4	3	2	1	0
0	PERIPHERAL QUALIFIER (000b)			PERIPHERAL DEVICE TYPE (01h)				
1	PAGE CODE (03h)							
2	Reserved							
3	PAGE LENGTH (21h)							
4	ASCII LENGTH (00h)							
5	Reserved							
7	Reserved							
8	LOAD ID							
11	(Identifies downloadable firmware with the drive level hardware)							
12	FIRMWARE REVISION LEVEL							
15	(Defined in Standard Inquiry Data, bytes 32-35)							
16	PTF NUMBER (00000000h)							
19	Reserved							
20	PATCH NUMBER (00000000h)							
23	Reserved							
24	RU NAME							
31	(8-byte EBCDIC representation of the RU name.)							
32	Reserved							
36	LIBRARY SEQUENCE NUMBER							

The Load ID and RU Name and which drive level hardware they designate are defined in Identifying Level Hardware of Drive (see C.1. on page 487).

#### Byte Description

0 Peripheral Data

##### Bit Description

7-5 PERIPHERAL QUALIFIER: 000b

4-0 PERIPHERAL DEVICE TYPE: 01h

1 PAGE CODE: 03h

2 Reserved

3 PAGE LENGTH: 21h

4 ASCII LENGTH: 00h

5-7 Reserved

8-11 LOAD ID

The Load ID of ROM microcode, represented by eight hex characters, is used to determine if the microcode to be downloaded is compatible with the device electronics. This value can be used to compare with bytes 8-11 in the firmware image file to insure that the microcode level is intended for this device type and model.

## 12-15 FIRMWARE REVISION LEVEL

The FIRMWARE REVISION LEVEL of the device microcode, represented with four ASCII characters, is used to determine if the latest level of microcode is downloaded.

## 16-19 PTF NUMBER: (unsupported)

## 21-23 PATCH NUMBER: (unsupported)

## 24-31 RU NAME

Used by the attaching system. This is an 8-byte EBCDIC field that is incremented each time the LOAD ID is incremented. This value can be compared with bytes 24-31 in the microcode image file to insure that the microcode level is intended for this device type and model.

## 32-36 LIBRARY SEQUENCE NUMBER (in ASCII): If this field is empty it is filled in with ASCII NULL.

**6.3.3 IP 80h: Unit Serial Number**

- INQUIRY - 12h (see 5.2.5 on page 84) describes how to request this page.

**6.3.3.1 Returned Data - IP 80h: Unit Serial Number**

For a LUN that is associated with an installed device (see 5.1) the following data is returned:

**Table 202 — IP 80h Unit Serial Number Inquiry Page**

Byte	Bit						
	7	6	5	4	3	2	1
0	PERIPHERAL QUALIFIER (000b)			PERIPHERAL DEVICE TYPE (01h)			
1	PAGE CODE (80h)						
2	Reserved						
3	PAGE LENGTH (0Ah)						
4	UNIT SERIAL NUMBER						
13							

**Byte Description**

0 Peripheral Data

**Bit Description**

7-5 PERIPHERAL QUALIFIER: 000b

4-0 PERIPHERAL DEVICE TYPE: 01h

1 PAGE CODE: 80h

2 Reserved

3 PAGE LENGTH: 0Ah

4-13 UNIT SERIAL NUMBER: Serial number of device, right-justified with leading zeroes, in ASCII.

On eServer enabled drives this is the last 10 characters of the 11S identifier

**6.3.4 IP 83h: Device Identification**

- INQUIRY - 12h (see 5.2.5 on page 84) describes how to request this page.

### 6.3.4.1 Returned Data - Inquiry Page 83h: Device Identification

The Device Identification VPD page (see table 203) provides the means to retrieve designation descriptors applying to the logical unit. For a LUN that is associated with an installed device (see 5.1) the following data is returned:

**Table 203 — IP 83h Device Identification VPD page**

Byte	Bit							
	7	6	5	4	3	2	1	0
0	PERIPHERAL QUALIFIER			PERIPHERAL DEVICE TYPE				
1	PAGE CODE (83h)							
2	(MSB)							
3	PAGE LENGTH (n-3)							
	(LSB)							
Designation descriptor list								
4	T10 vendor ID based designation descriptor							
41								
42	Logical Unit (NAA) - WWNN designation descriptor							
53								
54	Relative target port identifier designation descriptor							
61								
62	Port Name (NAA) - WWPN designation descriptor							
73								
74	Target Device Name (NAA) designation descriptor (SAS only)							
85								

Each designation descriptor contains information identifying the logical unit, SCSI target device containing the logical unit, or access path (i.e., target port) used by the command and returned parameter data

#### Byte Description

0 Peripheral Data

##### Bit Description

7-5 Peripheral Qualifier: 000b

4-0 Peripheral Device Type: 01h

1 Page Code: 83h

2 Reserved

3 Page Length:

##### Value Interface type

46h Fibre Channel attached drives

50h SAS attached drives

4-41 T10 vendor ID based designation descriptor (see 6.3.4.1.1)

42-53 Logical Unit (NAA) - WWNN designation descriptor (see 6.3.4.1.2)

54-61 Relative target port identifier designation descriptor (see 6.3.4.1.3)

62-73 Port Name (NAA) - WWPN designation descriptor (see 6.3.4.1.4)

74-85 Target Device Name (NAA) designation descriptor (SAS only) (see 6.3.4.1.5)

## 6.3.4.1.1 T10 vendor ID designation descriptor

Table 204 — T10 vendor ID based designation descriptor of IP 83h

Byte	Bit							
	7	6	5	4	3	2	1	0
0	PROTOCOL IDENTIFIER				CODE SET			
1	PIV	Reserved	ASSOCIATION		DESIGNATOR TYPE			
2	Reserved							
3	DESIGNATOR LENGTH (22h)							
4	VENDOR IDENTIFICATION							
11								
12	PRODUCT IDENTIFICATION							
27								
28	SERIAL NUMBER							
37								

**Byte Description**

0 Device ID (T10 vendor ID)

**Bit Description**

7-4 PROTOCOL IDENTIFIER: 0h

3-0 CODE SET: 2h

Descriptor contains ASCII printable characters (i.e., code values 20h to 7Eh).

1

**Bit Description**

7 PIV - Protocol Identifier Valid: 0h

6 Reserved

5-4 ASSOCIATION: 00b

3-0 DESIGNATOR TYPE: 1h

2 Reserved

3 DESIGNATOR LENGTH: 22h

4-11 VENDOR IDENTIFICATION (same as Inquiry Standard Data bytes 8-15)

12-27 PRODUCT IDENTIFICATION (same as Inquiry Standard Data bytes 16-31)

28-37 SERIAL NUMBER (same as the serial number reported in the Unit serial number page bytes 4-13)

## 6.3.4.1.2 Logical Unit (NAA) - WWNN designation descriptor

Table 205 — Logical Unit (NAA) - WWNN designation descriptor of IP 83h

Byte	Bit							
	7	6	5	4	3	2	1	0
0	PROTOCOL IDENTIFIER				CODE SET			
1	PIV	Reserved	ASSOCIATION		DESIGNATOR TYPE			
2	Reserved							
3	DESIGNATOR LENGTH (n-3)							
4	WORLD WIDE NODE NAME (WWNN)							
11								

**Byte Description**

0

**Bit Description**

7-4 PROTOCOL IDENTIFIER: 0h

3-0 CODE SET: 1h

Descriptor contains binary values.

1

**Bit Description**

7 PIV - Protocol Identifier Valid: 0h

6 Reserved

5-4 ASSOCIATION: 00b

3-0 DESIGNATOR TYPE: 3h

2 Reserved

3 Identifier Length: 8h

4-11 World Wide Node Name

## 6.3.4.1.3 Relative target port identifier designation descriptor

Table 206 — Relative target port identifier designation descriptor of IP 83h

Byte	Bit							
	7	6	5	4	3	2	1	0
0	PROTOCOL IDENTIFIER				CODE SET			
1	PIV	Reserved	ASSOCIATION		DESIGNATOR TYPE			
2	Reserved							
3	DESIGNATOR LENGTH (n-3)							
4	Reserved							
5	Reserved							
6	RELATIVE TARGET PORT							
7	RELATIVE TARGET PORT							

**Byte Description**

0

**Bit Description**

7-4 PROTOCOL IDENTIFIER

3-0 CODE SET: 1h

Descriptor contains binary values.

1

**Bit Description**

7 PIV - Protocol Identifier Valid: 1h

6 Reserved

5-4 ASSOCIATION: 01b

3-0 DESIGNATOR TYPE: 4h

2 Reserved

3 Identifier Length: 4h

4-5 Reserved

6-71 Port Identifier

**Value Description**

0001h Fibre/SAS port 0

0002h Fibre/SAS port 1

0003h RS-422 (ADI)

NOTE 38 - This relates to the port on which the Inquiry command was received.



## 6.3.4.1.4 Port Name (NAA) - WWPN designation descriptor

Table 207 — Port Name (NAA) - WWPN designation descriptor of IP 83h

Byte	Bit							
	7	6	5	4	3	2	1	0
0	PROTOCOL IDENTIFIER				CODE SET			
1	PIV	Reserved	ASSOCIATION		DESIGNATOR TYPE			
2	Reserved							
3	DESIGNATOR LENGTH (n-3)							
4	WORLD WIDE PORT NAME (WWPN)							
11								

**Byte Description**

0	<b>Bit</b>	<b>Description</b>
	7-4	PROTOCOL IDENTIFIER
	3-0	CODE SET: 1h
		Descriptor contains binary values.
1	<b>Bit</b>	<b>Description</b>
	7	PIV - Protocol Identifier Valid: 1h
	6	Reserved
	5-4	ASSOCIATION: 01b
	3-0	DESIGNATOR TYPE: 3h
2	Reserved	
3	DESIGNATOR LENGTH: 8h	
4-11	WORLD WIDE PORT NAME	

## 6.3.4.1.5 Target Device Name (NAA) designation descriptor (SAS only)

Table 208 — Target Device Name (NAA) designation descriptor of IP 83h (SAS only)

Byte	Bit							
	7	6	5	4	3	2	1	0
0	PROTOCOL IDENTIFIER				CODE SET			
1	PIV	Reserved	ASSOCIATION		DESIGNATOR TYPE			
2	Reserved							
3	DESIGNATOR LENGTH (n-3)							
4	SAS ADDRESS OF DRIVE							
11								

**Byte Description**

0	<b>Bit</b>	<b>Description</b>
	7-4	PROTOCOL IDENTIFIER
	3-0	CODE SET: 1h
		Descriptor contains binary values.

1	<b>Bit</b>	<b>Description</b>
	7	PIV - Protocol Identifier Valid: 1h
	6	Reserved
	5-4	ASSOCIATION: 10b
	3-0	DESIGNATOR TYPE: 3h
2	Reserved	
3	DESIGNATOR LENGTH: 8h	
4-11	SAS ADDRESS OF DRIVE - This is in NAA IEEE Registered format and is the same as the World Wide Node Name (WWNN) of LUN 0	

### 6.3.5 IP 86h: Extended INQUIRY Data

The Extended INQUIRY Data VPD page (see table 209) provides the application client with a means to obtain information about the logical unit.

**Table 209 — IP 86h Extended INQUIRY Data VPD page**

Byte	Bit							
	7	6	5	4	3	2	1	0
0	PERIPHERAL QUALIFIER (000b)			PERIPHERAL DEVICE TYPE (01h)				
1	PAGE CODE (86h)							
2	Reserved							
3	PAGE LENGTH (3Ch)							
4	ACTIVATE MICROCODE		SPT			GRD_CHK (0b)	APP_CHK (0b)	REF_CHK (0b)
5	Reserved		UASK_SUP (0b)	GROUP_SUP (0b)	PRIOR_SUP (0b)	HEADSUP (0b)	ORDSUP (0b)	SIMPSUP (1b)
6	Reserved				WU_SUP (0b)	CRD_SUP (0b)	NV_SUP (0b)	V_SUP (0b)
7	Reserved			P_I_I_SUP (0b)	Reserved			LUICLR (0b)
8	Reserved			R_SUP (0b)	Reserved			CBCS (0b)
9	Reserved				MULTI I_T NEXUS MICROCODE DOWNLOAD			
10	(MSB) _____							
11	EXTENDED SELF-TEST COMPLETION MINUTES							(LSB)
12	POA_SUP	HOA_SUP	VSA_SUP	Reserved				
13	MAXIMUM SUPPORTED SENSE DATA LENGTH							
14	Reserved							
63	Reserved							

The following data is returned.

#### Byte Description

0	<b>Bit</b>	<b>Description</b>
	7-5	PERIPHERAL QUALIFIER: 000b
	4-0	PERIPHERAL DEVICE TYPE: 01h (Sequential Access Device)
1	PAGE CODE (86h)	
2	Reserved	

3 PAGE LENGTH (3Ch)

4

**Bit Description**

7-6 ACTIVATE MICROCODE (00b)

The ACTIVATE MICROCODE field indicates how the device server activates microcode and establishes a unit attention condition when a WRITE BUFFER command (see 5.2.44) with the download microcode mode set to "MODE [05H] (WB) – DOWNLOAD MICROCODE, SAVE, AND ACTIVATE" ON PAGE 423 or MODE [07H] (WB) – DOWNLOAD MICROCODE WITH OFFSETS, SAVE, AND ACTIVATE (SEE 6.7.1.7 ON PAGE 423) is processed.

**Value Description**

00b The actions of the device server may or may not be as defined for values 01b or 10b.

01b-10b Not supported

11b Reserved

5-3 SPT

A supported protection type (SPT) field indicates the type of protection the logical unit supports. The SPT field is reserved if the PROTECT bit in Standard Inquiry Data (see 5.2.5.1 on page 85) is set to zero.

**Value Protection type supported**

001b Logical block protection: Logical block protection (see 4.9 on page 43) describes this feature.

others Reserved

2 GRD\_CHK (0b)

1 APP\_CHK (0b)

0 REF\_CHK (0b)

5

**Bit Description**

7-6 Reserved

5 UASK\_SUP (0b)

4 GROUP\_SUP (0b)

3 PRIOR\_SUP (0b)

2 HEADSUP (0b)

1 ORDSUP (0b)

0 SIMPSUP (1b) - The device server supports simple queuing.

6

**Bit Description**

7-4 Reserved

3 WU\_SUP (0b)

2 CRD\_SUP (0b)

1 NV\_SUP (0b)

0 V\_SUP (0b)

7

**Bit Description**

7-4 Reserved

3 P\_I\_I\_SUP (0b)

2-1 Reserved

0 LUICLR (0b)

8

**Bit Description**

7-4 Reserved

3 R\_SUP (0b)

2-1 Reserved

0 CBCS (0b)

9

<b>Bit</b>	<b>Description</b>
7-4	Reserved
3-0	MULTI I_T NEXUS MICROCODE DOWNLOAD (0b) The MULTI I_T NEXUS MICROCODE DOWNLOAD field indicates how the device server handles concurrent attempts to download microcode using the WRITE BUFFER command (see 5.2.38) from multiple I_T nexuses.
	<b>Value</b> <b>Description</b>
	0h                    The handling of concurrent WRITE BUFFER download microcode operations from multiple I_T nexus is vendor specific.
	1h-3h                Not Supported
	4h-Fh                Reserved.

10-11 EXTENDED SELF-TEST COMPLETION MINUTES (0000h): Not supported.

12

<b>Bit</b>	<b>Description</b>
7	POA_SUP (Power On Activate Supported)(1b): A WRITE BUFFER command with the MODE field set to 0Dh (see 6.7.1.11) and the PO_ACT bit set to one is supported.
6	HRA_SUP (Hard Reset Activate Supported)(0b): A WRITE BUFFER command with the MODE field set to 0Dh (see 6.7.1.11) and the HR_ACT bit set to one is not supported.
5	VSA_SUP (Vendor Specific Event Activate Supported)(1b): A WRITE BUFFER command with the MODE field set to 0Dh (see 6.7.1.11) and the VSE_ACT bit set to one is supported. The vendor specific event is the detection of medium removal.
4-0	Reserved.

13 MAXIMUM SUPPORTED SENSE DATA LENGTH (0000h): Not supported.

14-63 Reserved

### 6.3.6 IP 87h: Mode Page Policy

The Mode Page Policy Page (see table 210) indicates which mode page policy is in effect for each mode page supported by the logical unit.

- INQUIRY - 12h (see 5.2.5 on page 84) describes how to request this page.

### 6.3.6.1 Returned Data - IP 87h: Mode Page Policy

The data returned is shown in table 210.

**Table 210 — IP 87h Mode Page Policy page**

Byte	Bit							
	7	6	5	4	3	2	1	0
0	Peripheral Qualifier (000b)			Peripheral Device Type (01h)				
1	Page Code (87h)							
2	(MSB)	Page Length (n-3)						(LSB)
3								
	Mode page policy descriptor list							
4								
7	Mode page policy descriptor (first)							
	⋮							
n-3	Mode page policy descriptor (last)							
n								

#### Byte Description

0 Peripheral Data

##### Bit Description

7-5 Peripheral Qualifier: 000b

4-0 Peripheral Device Type: 01h

1 Page Code: 87h

2-3 Page Length (n-3)

4-n Mode page policy descriptor list. Each mode page policy descriptor (see 6.3.6.1.1) contains information describing the mode page policy for one or more mode pages or subpages. The information in the mode page policy descriptors in this page describe the mode page policy for every mode page and subpage supported by the logical unit.

The first mode page policy descriptor in the list contains a POLICY PAGE CODE field set to 3Fh and a POLICY SUBPAGE CODE field set to FFh, indicating that the descriptor applies to all mode pages and subpages not described by other mode page policy descriptors. The POLICY PAGE CODE field is set to 3Fh and the POLICY SUBPAGE CODE field is set to FFh only in the first mode page policy descriptor in the list. If the POLICY PAGE CODE field contains a value other than 3Fh or a POLICY SUBPAGE CODE field contains a value other than FFh, then the POLICY PAGE CODE field and the POLICY SUBPAGE CODE field indicate a single mode page and a subpage to which the descriptor applies.

#### 6.3.6.1.1 Mode page policy descriptor

**Table 211 — Mode page policy descriptor of IP 87h**

Byte	Bit							
	7	6	5	4	3	2	1	0
0	Reserved		POLICY PAGE CODE					
1	POLICY SUBPAGE CODE							
2	MLUS	Reserved				MODE PAGE POLICY		
3	Reserved							

Byte Description

0

**Bit Description**

7-6 Reserved

5-0 POLICY PAGE CODE: The mode page to which the descriptor applies.

1 POLICY SUBPAGE CODE: Indicates the subpage to which the descriptor applies.

2

**Bit Description**

7 MLUS (multiple logical units share): Indicates if the mode page is shared by multiple logical units.

**Value Description**

0b Indicates that the mode page and subpage identified by the POLICY PAGE CODE field and POLICY SUBPAGE CODE field is not shared by more than one logical unit.

1b Indicates that the mode page and subpage identified by the POLICY PAGE CODE field and POLICY SUBPAGE CODE field may be shared by more than one logical unit.

6-2 Reserved

1-0 MODE PAGE POLICY: Indicates the mode page policy (see 4.7.1) for the mode page and subpage identified by the POLICY PAGE CODE field and POLICY SUBPAGE CODE field.

**Code Description**

00b <Shared>

01b <Per target port>

10b Obsolete

11b <Per I\_T nexus>

The mode page policies including the multiple logical unit shares are described in Mode page policy (see 4.7.1.2 on page 39).

### 6.3.7 IP 88h: SCSI ports

The SCSI Ports Inquiry page (see table 212) provides a means to retrieve identification descriptors for all the SCSI ports in the drive.

- INQUIRY - 12h (see 5.2.5 on page 84) describes how to request this page.

#### 6.3.7.1 Returned Data - IP 88h: SCSI ports

The SCSI ports page is shown in table 212.

**Table 212 — IP 88h SCSI Ports VPD page**

Byte	Bit							
	7	6	5	4	3	2	1	0
0	peripheral qualifier (000b)			peripheral device type (01h)				
1	PAGE CODE (88h)							
2	(MSB)							
3	PAGE LENGTH (n-3)							
	(LSB)							
	Designation descriptor list							
4	SCSI port designation descriptor [first]							
	(see table 213)							
	.							
	.							
	.							
n	SCSI port designation descriptor [last]							
	(see table 213)							

Each SCSI Port designation descriptor (see table 213) identifies a SCSI port. The SCSI port designation descriptors may be returned in any order. There is one SCSI port designation descriptor for each primary port in the drive.

**Table 213 — SCSI port designation descriptor of IP 88h**

Byte	Bit							
	7	6	5	4	3	2	1	0
0	Reserved							
1	Reserved							
2	(MSB)	RELATIVE PORT IDENTIFIER						(LSB)
3								
4	Reserved							
5	Reserved							
6	(MSB)	INITIATOR PORT TRANSPORTID LENGTH (0)						(LSB)
7								
8	Reserved							
9	Reserved							
10	(MSB)	TARGET PORT DESCRIPTORS LENGTH (n-11)						(LSB)
11								
Target port descriptor list								
12	Target port descriptor [first] (see table 214)							
⋮								
n	Target port descriptor [last] (see table 214)							

**Table 214 — Target port descriptor of IP 88h**

Byte	Bit							
	7	6	5	4	3	2	1	0
0	PROTOCOL IDENTIFIER				CODE SET (1h)			
1	PIV (1b)	Reserved	ASSOCIATION (01b)		DESIGNATOR TYPE (3h)			
2	Reserved							
3	DESIGNATOR LENGTH (8)							
4	WORLD WIDE PORT NAME (WWPN)							
11								

The PROTOCOL IDENTIFIER value is 0h on Fibre Channel devices and 6h on SAS devices.

### 6.3.8 IP 90h: Protocol-Specific Logical Unit Information

The Protocol-Specific Logical Unit Information VPD page is returned on LUN 0 of SAS attached devices that support changing the TLR control field in the frame header and contains parameters for logical unit 0 that are protocol-specific based on the I\_T nexus being used to access the logical unit.

- INQUIRY - 12h (see 5.2.5 on page 84) describes how to request this page.

#### 6.3.8.1 Returned Data - IP 90h: SCSI ports

Table 215 defines the Protocol-Specific Logical Unit Information VPD page for logical units with SAS target ports.

**Table 215 — IP 90h Protocol-Specific Logical Unit Information VPD page for SAS SSP**

Byte	Bit							
	7	6	5	4	3	2	1	0
0	PERIPHERAL QUALIFIER (000b)				PERIPHERAL DEVICE TYPE (01h)			
1	PAGE CODE (90h)							
2	(MSB)							
3	PAGE LENGTH (18h)							
	(LSB)							
Logical unit information descriptor list								
4	Logical unit information descriptor (first)(see table 216)							
15								
16	Logical unit information descriptor (second)(see table 216)							
27								

The fields are defined as follows:

#### Byte Description

0 Peripheral Data

##### Bit Description

7-5 PERIPHERAL QUALIFIER: 000b

4-0 PERIPHERAL DEVICE TYPE: 01h

1 PAGE CODE: 90h

2-3 Page Length: 18h

4-27 Logical unit information descriptor list: The logical unit information descriptor list contains a logical unit information descriptor for each SAS target port known to the device server **Logical unit information descriptor** (see 6.3.8.2 on page 243).



### 6.3.8.2 Logical unit information descriptor

Table 216 defines the logical unit information descriptor for logical units with SAS target ports.

**Table 216 — Logical unit information descriptor for SAS SSP of IP 90h**

Byte	Bit							
	7	6	5	4	3	2	1	0
0	(MSB) _____							
1	RELATIVE PORT IDENTIFIER							(LSB)
2	Reserved				PROTOCOL IDENTIFIER (6h)			
3	Reserved							
5	Reserved							
6	(MSB) _____							
7	DESCRIPTOR LENGTH (0004h)							(LSB)
Per logical unit SCSI transport specific data								
8	Reserved							TLR CTL SUP
9	Reserved							
11	Reserved							

The fields are defined as follows:

#### Byte Description

0-1 RELATIVE PORT IDENTIFIER: The Relative Target Port from the IP 83h: Device Identification (see 6.3.4 on page 230).

2

#### Bit Description

7-4 Reserved

3-0 PROTOCOL IDENTIFIER: 06h (i.e. SAS SSP specific descriptor)

3-5 Reserved

6-7 DESCRIPTOR LENGTH: 0004h

8

#### Bit Description

7-1 Reserved

0 TLR CTL SUP (TLR Control Supported):

#### Value

0b

The combination of the SCSI target port and logical unit do not support the TLR CONTROL field in the SSP frame header.

1b

The combination of the SCSI target port and logical unit support the TLR CONTROL field in the SSP frame header.

9-11 Reserved

### 6.3.9 IP B0h: Sequential-Access device capabilities

INQUIRY - 12h (see 5.2.5 on page 84) describes how to request this pages. The following parameters apply to this request:

- EVPD (Enable Vital Product Data): 1b
- Page Code: B0h
- Allocation Length: 06h bytes available

### 6.3.9.1 Returned Data - IP B0h: Sequential-Access device capabilities

For LUN 0, the following data is returned: This page provides the application client with the means to determine if the features specified in this page are supported by the drive.

**Table 217 — IP B0h Sequential-Access Device Capabilities Page**

Byte	Bit							
	7	6	5	4	3	2	1	0
0	Peripheral Qualifier (000b)			Peripheral Device Type (01h)				
1	Page Code (B0h)							
2	Page Length (2)							
3								
4	Reserved						WORM	
5	Reserved							

If the write once read many (WORM) bit is set to one, the device server supports WORM mode operation (see 4.2.24.3). If the WORM bit is set to zero, the device server does not support WORM mode operation.

### 6.3.10 IP B1h: Manufacturer-assigned Serial Number

INQUIRY - 12h (see 5.2.5 on page 84) describes how to request this pages. The following parameters apply to this request:

- EVPD (Enable Vital Product Data): 1b
- Page Code: B1h
- Allocation Length: 0Eh (14) bytes available

#### 6.3.10.1 Returned Data - IP B1h: Manufacturer-assigned Serial Number

Table 218 specifies the Manufacturer-assigned Serial Number VPD page.

**Table 218 — IP B1h Manufacturer-assigned Serial Number VPD page**

Bit Byte	7	6	5	4	3	2	1	0
0	PERIPHERAL QUALIFIER (000b)			PERIPHERAL DEVICE TYPE (01h)				
1	PAGE CODE (B1h)							
2	(MSB)	PAGE LENGTH (000Ah)						(LSB)
3								
4	(MSB)	MANUFACTURER-ASSIGNED SERIAL NUMBER						(LSB)
13								

#### Byte Description

0	Peripheral Data
<b>Bit</b>	<b>Description</b>
7-5	PERIPHERAL QUALIFIER: 000b
4-0	PERIPHERAL DEVICE TYPE: 01h
1	PAGE CODE: B1h
2-3	PAGE LENGTH: 0Ah
4-13	MANUFACTURER-ASSIGNED SERIAL NUMBER: Right-aligned ASCII data that is the manufacturer-assigned serial number. If the manufacturer-assigned serial number is not available, the device returns ASCII

spaces (20h) in this field. If the manufacturer-assigned serial number differs from the value in the UNIT SERIAL NUMBER field of IP 80h: Unit Serial Number (see 6.2.3), then the value in the UNIT SERIAL NUMBER field is used in building the T10 vendor ID descriptor.

### 6.3.11 IP B3h: Automation Device Serial Number

INQUIRY - 12h (see 5.2.5 on page 84) describes how to request this page.

#### 6.3.11.1 Returned Data - IP B3h: Automation Device Serial Number

Table 218 specifies the Automation Device Serial Number VPD page.

**Table 219 — IP B3h Automation Device Serial Number VPD page**

Bit Byte	7	6	5	4	3	2	1	0
0	PERIPHERAL QUALIFIER (000b)			PERIPHERAL DEVICE TYPE (01h)				
1	PAGE CODE (B3h)							
2	Reserved							
3	PAGE LENGTH (n-3)							
4	(MSB)	AUTOMATION DEVICE SERIAL NUMBER						(LSB)
n								

#### Byte Description

0 Peripheral Data

##### Bit Description

7-5 PERIPHERAL QUALIFIER: 000b

4-0 PERIPHERAL DEVICE TYPE: 01h

1 PAGE CODE: B3h

2-3 PAGE LENGTH: n-3. The maximum value of this field is 20h.

4-n AUTOMATION DEVICE SERIAL NUMBER: The automation device serial number set during the processing of the most recently processed SET AUTOMATION DEVICE ATTRIBUTES command on the ADC device server (i.e., LUN 2). If no automation device serial number has been set, then the device server returns 32 bytes of ASCII spaces (20h) in this field.

### 6.3.12 IP B4h: Data Transfer Device Element Address

INQUIRY - 12h (see 5.2.5 on page 84) describes how to request this page.

### 6.3.12.1 Returned Data - IP B4h: Data Transfer Device Element Address

Table 220 specifies the Data Transfer Device Element Address VPD page.

**Table 220 — IP 84h Data Transfer Device Element Address VPD page**

Bit Byte	7	6	5	4	3	2	1	0
0	PERIPHERAL QUALIFIER (000b)			PERIPHERAL DEVICE TYPE (01h)				
1	PAGE CODE (B4h)							
2	Reserved							
3	PAGE LENGTH (n-3)							
4	(MSB)	DATA TRANSFER DEVICE ELEMENT ADDRESS						(LSB)
n								

#### Byte Description

0 Peripheral Data

##### Bit Description

7-5 PERIPHERAL QUALIFIER: 000b

4-0 PERIPHERAL DEVICE TYPE: 01h

1 PAGE CODE: B4h

2-3 PAGE LENGTH: n-3. The maximum value of this field is 04h.

4-n DATA TRANSFER DEVICE ELEMENT ADDRESS: The Data Transfer Device Element Address set during the processing of the most recently processed SET AUTOMATION DEVICE ATTRIBUTES command on the ADC device server (i.e., LUN 2). If no data transfer device Element Address has been set, then the device server returns FFFF FFFFh. in this field.

### 6.3.13 IP B5h: Logical Block Protection

INQUIRY - 12h (see 5.2.5 on page 84) describes how to request this page.

6.3.13.13 Returned Data - IP B5h: Logical Block Protection

Table 220 specifies the Logical Block Protection VPD page.

**Table 221 — IP 85h Logical Block Protection VPD page**

Bit Byte	7	6	5	4	3	2	1	0
0	PERIPHERAL QUALIFIER (000b)			PERIPHERAL DEVICE TYPE (01h)				
1	PAGE CODE (B5h)							
2	(MSB)	PAGE LENGTH (n-3)						(LSB)
3								
4	Reserved							
7								
Logical block protection method descriptor list								
Logical block protection method descriptor for LBP disabled (LTO-5+)								
8	LOGICAL BLOCK PROTECTION METHOD DESCRIPTOR LENGTH (07h)							
9	LOGICAL BLOCK PROTECTION METHOD (00h)							
10	Reserved			LOGICAL BLOCK PROTECTION INFORMATION LENGTH (00h)				
11	LBP_W_C (0b)	LBP_R_C (0b)	RBDP_C (0b)	Reserved				
12								
15	Reserved							
Logical block protection method descriptor for RS-CRC (LTO-5+)								
16	LOGICAL BLOCK PROTECTION METHOD DESCRIPTOR LENGTH (07h)							
17	LOGICAL BLOCK PROTECTION METHOD (01h)							
18	Reserved			LOGICAL BLOCK PROTECTION INFORMATION LENGTH (04h)				
19	LBP_W_C (1b)	LBP_R_C (1b)	RBDP_C (0b)	Reserved				
20								
23	Reserved							
Logical block protection method descriptor for RS-CRC (LTO-7+)								
24	LOGICAL BLOCK PROTECTION METHOD DESCRIPTOR LENGTH (07h)							
25	LOGICAL BLOCK PROTECTION METHOD (02h)							
26	Reserved			LOGICAL BLOCK PROTECTION INFORMATION LENGTH (04h)				
27	LBP_W_C (1b)	LBP_R_C (1b)	RBDP_C (0b)	Reserved				
28								
31	Reserved							

**Byte Description**

0 Peripheral Data

**Bit Description**

7-5 PERIPHERAL QUALIFIER: 000b  
 4-0 PERIPHERAL DEVICE TYPE: 01h

1 PAGE CODE: B5h

2-3 PAGE LENGTH: n-3

4-7 Reserved

8-n The logical block protection method descriptor list contains a list of descriptors which describe each supported logical block protection method. The descriptors are returned in ascending order by logical block protection method code starting with logical block protection method zero (i.e., LBP not enabled). The list of logical block protection method descriptors depends on the product.

For  $x=1$  to the number of descriptors:

**Byte Description**

8x+0 LOGICAL BLOCK PROTECTION METHOD DESCRIPTOR LENGTH: 07h

8x+1 LOGICAL BLOCK PROTECTION METHOD:

8x+2

**Bit Description**

7-6 Reserved

5-0 LOGICAL BLOCK PROTECTION INFORMATION LENGTH:

8x+3

**Bit Description**

7 LBP\_W\_C (logical blocks protected during write capable):

6 LBP\_R\_C (logical block protected during read capable):

5 RBDP\_C (recover buffered data protected capable):

4-0 Reserved

(8x+4)

to

(8x+7) Reserved

### 6.3.14 IP C0h: Drive Component Revision Levels

- INQUIRY - 12h (see 5.2.5 on page 84) describes how to request this page.

6.3.14.1 Returned Data - IP C0h: Drive Component Revision Levels

For LUN 0, the following data is returned:

Table 222 — IP C0h: Drive Component Revision Levels

Byte	Bit							
	7 msb	6	5	4	3	2	1	0 lsb
0	PERIPHERAL QUALIFIER (000b)			PERIPHERAL DEVICE TYPE (01h)				
1	PAGE CODE (C0h)							
2	Reserved							
3	PAGE LENGTH (27h)							
4	code name							
15								
16	TIME(HHMMSS)							
22								
23	DATE (YYYYMMDD)							
30								
31	platform							
42								

**Byte Description**

0 Peripheral Data

**Bit Description**

7-5 Peripheral Qualifier: 000b

4-0 Peripheral Device Type: 01h

1 Page Code: C0h

2 Reserved

3 Page Length: 27h

4-15 CODE NAME - The code name definition is not published.

16-22 TIME - Time the code was built in HHMMSS format with a trailing NULL (i.e., 00h). Prior to May 2010, this field was set to ASCII zeros (i.e., 30h)

23-30 DATE - The date the code was built.

- 31-42 PLATFORM - ASCII characters containing the <protocol>\_<package>[\_<variant>] for the drive. This is left-aligned with ASCII spaces padded at the end. This is set to ASCII zeros on Ultrium drive platforms released prior to May 2010.

**Table 223 — PLATFORM definition of IP C0h**

Symbol	Description	
<protocol>	<b>Value</b>	<b>Transport Protocol</b>
	sas	Serial Attached SCSI (SAS)
	fc	Fibre Channel (FC)
<package>	<b>Value</b>	<b>Type</b>
	fh	Full height
	hh	Half height
	hl	Half height V2
<variant>	<b>Value</b>	<b>Type</b>
	f	FIPS

### 6.3.15 IP C1h: Drive Serial Numbers

- INQUIRY - 12h (see 5.2.5 on page 84) describes how to request this page.

#### 6.3.15.1 Returned Data - IP C1h: Drive Serial Numbers

For LUN 0, the following data is returned:

===== WARNING =====

The length of this page should be dynamically parsed. The size of this page has increased in the past and may increase in the future (i.e., additional fields may be added).

===== WARNING =====

**Table 224 — IP C1h: Drive Serial Numbers**

Byte	Bit							
	7	6	5	4	3	2	1	0
0	Peripheral Qualifier (000b)				Peripheral Device Type (01h)			
1	Page Code (C1h)							
2	Reserved							
3	Page Length (24h)							
4	Manufacturing Full Assembly Serial Number							
15								
16	Reported Full Assembly Serial Number							
27								
28	Manufacturing Drive Brick Serial Number							
39								

#### Byte Description

- 0 Peripheral Data
- | Bit | Description                 |
|-----|-----------------------------|
| 7-5 | Peripheral Qualifier: 000b  |
| 4-0 | Peripheral Device Type: 01h |
- 1 Page Code: C1h



- 2 Reserved
- 3 Page Length: 24h
- 4-15 Manufacturing Full Assembly Serial Number: Full Assembly Serial Number set at time of manufacture, right-justified with leading zeros, in ASCII.
- 16-27 Reported Full Assembly Serial Number: Full Assembly Serial Number used as the serial number in the Unit Serial Number Inquiry page (i.e., page 80h), right-justified with leading zeros, in ASCII.  
This value may be over-ridden by a library or FRU process.
- 28-39 Manufacturing Drive Brick Serial Number: This is the drive brick serial number set at time of manufacture, right-justified with leading zeros, in ASCII.

**6.3.16 IP C2h: Drive Bar codes**

- INQUIRY - 12h (see 5.2.5 on page 84) describes how to request this page.

**6.3.16.1 Returned Data - IP C2h: Drive Bar codes**

For LUN 0, the following data is returned:

===== WARNING =====  
This page should be dynamically parsed. Additional bar codes (i.e., fields) may be added in the future.  
===== WARNING =====

**Table 225 — IP C2h: Drive Bar codes**

Byte	Bit							
	7	6	5	4	3	2	1	0
0	PERIPHERAL QUALIFIER (000b)				PERIPHERAL DEVICE TYPE (01h)			
1	PAGE CODE (C2h)							
2	(MSB)		PAGE LENGTH (n-3)				(LSB)	
3								
	Bar code descriptor list							
4	Bar code descriptor (first)							
	⋮							
	Bar code descriptor (last)							
n								

**Byte Description**

- 0 Peripheral Data
  - Bit Description**
  - 7-5 PERIPHERAL QUALIFIER: 000b
  - 4-0 PERIPHERAL DEVICE TYPE: 01h
- 1 PAGE CODE: C2h
- 2-3 PAGE LENGTH:
- 4-n Bar code descriptor list: Each bar code descriptor (see 6.3.16.1.1) describes a bar code returned by the drive.

### 6.3.16.1.1 Bar code descriptor

Descriptor that describes a bar code.

**Table 226 — Bar code descriptor**

Byte	Bit							
	7	6	5	4	3	2	1	0
0	BAR CODE DESIGNATOR							
1	Reserved							
2	DATA IDENTIFIER LENGTH (n)							
3	BAR CODE VALUE LENGTH (m-3)							
4								
4+(n-1)								
4+n	BAR CODE VALUE							
m								

#### Byte Description

- 0 BAR CODE DESIGNATOR: A value that designates which bar code is contained in the BAR CODE VALUE field.  
**Value Bar code**  
 00h 11S Bar code from the drive brick (see 6.3.16.1.1.1)
- 1 Reserved
- 2 DATA IDENTIFIER LENGTH: Length of the DATA IDENTIFIER field of the bar code value.
- 3 BAR CODE VALUE LENGTH: Number of bytes to follow
- 4-m BAR CODE VALUE: Value that is returned when the bar code label is read by a bar code scanner. The first DATA IDENTIFIER LENGTH (n) bytes are a prefix used in a bar code to identify how the rest of the bar code is to be interpreted.

#### 6.3.16.1.1.1 00h — 11S Bar code descriptor

The bar code value returned from a bar code scanner when reading the 11S bar code from the drive brick label.

**Table 227 — Bar code descriptor**

Byte	Bit							
	7	6	5	4	3	2	1	0
0	BAR CODE DESIGNATOR (00h)							
1	Reserved							
2	DATA IDENTIFIER LENGTH (03h)							
3	BAR CODE VALUE LENGTH (16h)							
4								
6	DATA IDENTIFIER ("11S")							
7								
13	DRIVE BRICK PART NUMBER							
14								
25	DRIVE BRICK SERIAL NUMBER							

**Byte Description**

0	BAR CODE DESIGNATOR: 00h
1	Reserved
2	DATA IDENTIFIER LENGTH: 03h
3	BAR CODE VALUE LENGTH: 16h
4-6	DATA IDENTIFIER: "11S" The identifier that indicates the (concatenated) IBM part number (7 characters) and serial number (12 characters).
7-13	DRIVE BRICK PART NUMBER: This is the drive brick part number set at time of manufacture, right-justified with leading zeros, in ASCII.
14-25	DRIVE BRICK SERIAL NUMBER: This is the drive brick serial number set at time of manufacture, right-justified with leading zeros, in ASCII.

**6.3.17 IP C3h: Subcomponent Version List**

- INQUIRY - 12h (see 5.2.5 on page 84) describes how to request this page.

**6.3.17.1 Returned Data - IP C3h: Subcomponent Version List**

For LUN 0, the following data is returned:

===== WARNING =====
WARNING =====  
 This page should be dynamically parsed. Additional subcomponents (i.e., fields) may be added in the future.  
===== WARNING =====
WARNING =====

**Table 228 — IP C3h: Subcomponent Version List**

Byte	Bit							
	7	6	5	4	3	2	1	0
0	PERIPHERAL QUALIFIER (000b)			PERIPHERAL DEVICE TYPE (01h)				
1	PAGE CODE (C3h)							
2	(MSB)	PAGE LENGTH (n-3)						(LSB)
3								
	Subcomponent version descriptor list							
4	Subcomponent version descriptor (first)							
	⋮							
	Subcomponent version descriptor (last)							
n								

**Byte Description**

0	Peripheral Data
	<b>Bit Description</b>
	7-5 PERIPHERAL QUALIFIER: 000b
	4-0 PERIPHERAL DEVICE TYPE: 01h
1	PAGE CODE: C3h
2-3	PAGE LENGTH:
4-n	Subcomponent version descriptor list: Each Subcomponent version descriptor (see 6.3.16.1.1) describes a Subcomponent version returned by the drive.

### 6.3.17.1.1 Subcomponent version descriptor

Descriptor that describes a Subcomponent version.

**Table 229 — Subcomponent version descriptor**

Byte	Bit							
	7	6	5	4	3	2	1	0
0	SUBCOMPONENT DESIGNATOR							
1	SUBCOMPONENT LENGTH (m-2)							
2	SUBCOMPONENT VERSION							
3								
m								

#### Byte Description

- 0-1 SUBCOMPONENT DESIGNATOR: A value that designates which subcomponent version is contained in the SUBCOMPONENT VERSION field.
- 2 SUBCOMPONENT LENGTH: Number of bytes to follow. Depends on the value in the SUBCOMPONENT VERSION DESIGNATOR field.

**Table 230 — Subcomponent designator-length-description**

SUBCOMPONENT DESIGNATOR	SUBCOMPONENT LENGTH	Description
0000h	01h	Dynamic braking (e.g., GDB, EDB) version from the PLD

- 3-m SUBCOMPONENT VERSION: The version of the subcomponent.

### 6.3.18 IP C7h: Device Unique Configuration Data

This page provides data required by IBM eServers for connection to the drive.

- INQUIRY - 12h (see 5.2.5 on page 84) describes how to request this page.

#### 6.3.18.1 Returned Data - IP C7h: Device Unique Configuration Data

The Device Unique Configuration Data Page is supported on IBM eServer capable drives only. On drives that are not eServer capable this page is returned with all zero data.

### 6.3.19 IP C8h: Mode Parameter Default Settings

This page provides data required by IBM eServers for connection to the drive.

- INQUIRY - 12h (see 5.2.5 on page 84) describes how to request this page.

#### 6.3.19.1 Returned Data - IP C8h: Mode Parameter Default Settings

The Mode Parameter Default Settings page is supported on IBM eServer capable drives only. On drives that are not eServer capable this page is returned with all zero data. For LUN 0, the following data is returned on eServer capable drives only.

## 6.4 Log Parameters (LP)

Log parameters are used in relation to LOG SELECT - 4Ch (see 5.2.8 on page 94) commands and LOG SENSE - 4Dh (see 5.2.9 on page 94) commands.

“Index Of Counters (log parameters not in counter format are not included)” (see page 503) provides an alphabetized list of all counter type log parameters and may be useful in finding parameters that provide the information desired.

A list of all log pages, their reset behaviors, their access path policy, and links can be found in table 231.

===== WARNING =====

Log pages may have different reset behaviors. Care should be taken to ensure counters are processed appropriately, including consideration of their reset behaviors. While reset behaviors may be different between products, an attempt is made to maintain compatibility between generations of a given product. See “Log Parameters (LP)” on page 255.

===== WARNING =====

**Table 231 — Supported log pages**

Page Code	Subpage Code <sup>h</sup>	Log Page	T10 Std	Pol <sup>a</sup>	Reset		
					Sel <sup>b</sup>	Sns <sup>c</sup>	Lod <sup>d</sup>
00h	00h	LP 00h: Supported Log Pages (see 6.4.4.1 on page 259)	SPC	S	-	-	-
02h	00h	LP 02h: Write Error Counters (see 6.4.5 on page 261)	SPC	S	Y	-	Y
03h	00h	LP 03h: Read Error Counters (see 6.4.6 on page 262)	SPC	S	Y	-	Y
06h	00h	LP 06h: Non-Medium Errors (see 6.4.7 on page 263)	SPC	H,L	H,L	H,L	-
0Ch	00h	LP 0Ch: Sequential-Access Device (see 6.4.8 on page 264)	SSC	S	-	-	Y
0Dh <sup>g</sup>	01h	LP 0Dh[01h]: Environmental Reporting (LTO9 and later) (see 6.4.9 on page 266)	SPC	S	-	-	-
11h	00h	LP 11h: DT Device Status (see 6.4.10 on page 269)	ADC	S	-	-	-
12h	00h	LP 12h: TapeAlert Response (see 6.4.11 on page 288)	ADC	S	-	-	-

**Key:**

- No
- Y Yes
- S Single shared aspect
- H Aspect related to access through the host primary ports
- L Aspect related to access through the library port
- P Aspect related to access through the specific drive port
- ITN Aspect related to access through an I\_T nexus (i.e., access path)
- ALL All aspects supported by the log page
- <sup>a</sup> Policy—Which access path(s)/type(s) have common counters  
NOTE: Prior to certain levels of code H and L aspects are shared (e.g., resets by either access path affect both)
- <sup>b</sup> Aspects which may be reset using a LOG SELECT through that aspect
- <sup>c</sup> Aspects reset when the entire page is read by a LOG SENSE through that aspect
- <sup>d</sup> Aspects reset on a LOAD (regardless of cause of load)
- <sup>e</sup> This log page is for engineering use only and is not reported in LP 00h: Supported Log Pages (see 6.4.4.1 on page 259), nor in LP [PAGE CODE][FFh]: Supported subpages (see 6.4.4.2 on page 259).
- <sup>f</sup> See the page description for counters that do not follow the general behavior described in this table
- <sup>g</sup> This Page Code does not have a Subpage 00h and is not reported in LP 00h: Supported Log Pages (see 6.4.4.1 on page 259).
- <sup>h</sup> Unless otherwise stated, this Page Code has a Subpage Code FFh which returns the list of subpages associated with this Page Code as described in LP [PAGE CODE][FFh]: Supported subpages (see 6.4.4.2 on page 259).

Table 231 — Supported log pages

Page Code	Subpage Code <sup>h</sup>	Log Page	T10 Std	Pol <sup>a</sup>	Reset		
					Sel <sup>b</sup>	Sns <sup>c</sup>	Lod <sup>d</sup>
14h	00h	LP 14h: Device Statistics (see 6.4.12 on page 289)	SSC	S	Y	-	-
16h	00h	LP 16h: Tape diagnostic data (see 6.4.13 on page 298)	SSC	S	-	-	-
17h	00h	LP 17h: Volume Statistics (see 6.4.14 on page 301)	SSC	S	-	-	-
	01h						
	02h						
18h	00h	LP 18h: Protocol-specific port (see 6.4.15 on page 308)	SPC	P	-	-	-
1Ah	00h	LP 1A: Power Condition Transitions (see 6.4.16 on page 313)	SPC	S	-	-	-
1Bh	00h	LP 1Bh: Data Compression (see 6.4.17 on page 314)	SSC	S	-	-	Y
2Eh	00h	LP 2Eh: TapeAlerts (see 6.4.18 on page 316)	SSC	ITN	ALL	ITN	-
30h	00h	LP 30h: Tape Usage (see 6.4.19 on page 319)	VU	S	-	-	-
31h	00h	LP 31h: Tape capacity (see 6.4.20 on page 320)	VU	S	-	-	Y
32h	00h	LP 32h: Data compression (see 6.4.21 on page 321)	VU	S	Y	-	Y
33h	00h	LP 33h: Write Errors (see 6.4.22 on page 322)	VU	H,L	H,L	H,L	ALL
34h	00h	LP 34h: Read Forward Errors (see 6.4.23 on page 324)	VU	H,L	H,L	H,L	ALL
37h	??h	LP 37h: Performance Characteristics (see 6.4.24 on page 326)	VU	S	Y	-	-
38h	00h	LP 38h: Blocks/Bytes Transferred (see 6.4.25 on page 337)	VU	H,L	H,L	H,L	ALL
39h	00h	LP 39h: Host Port 0 Interface Errors (see 6.4.26 on page 340)	VU	H,L	H,L	H,L	-
3Ah	00h	LP 3Ah: Drive control verification (see 6.4.27 on page 341) <sup>e</sup>	VU	S	-	-	Y
3Bh	00h	LP 3Bh: Host Port 1 Interface Errors (see 6.4.28 on page 341)	VU	H,L	H,L	H,L	-

Key:

- No
- Y Yes
- S Single shared aspect
- H Aspect related to access through the host primary ports
- L Aspect related to access through the library port
- P Aspect related to access through the specific drive port
- ITN Aspect related to access through an I\_T nexus (i.e., access path)
- ALL All aspects supported by the log page

<sup>a</sup> Policy—Which access path(s)/type(s) have common counters  
NOTE: Prior to certain levels of code H and L aspects are shared (e.g., resets by either access path affect both)

<sup>b</sup> Aspects which may be reset using a LOG SELECT through that aspect

<sup>c</sup> Aspects reset when the entire page is read by a LOG SENSE through that aspect

<sup>d</sup> Aspects reset on a LOAD (regardless of cause of load)

<sup>e</sup> This log page is for engineering use only and is not reported in LP 00h: Supported Log Pages (see 6.4.4.1 on page 259), nor in LP [PAGE CODE][FFh]: Supported subpages (see 6.4.4.2 on page 259).

<sup>f</sup> See the page description for counters that do not follow the general behavior described in this table

<sup>g</sup> This Page Code does not have a Subpage 00h and is not reported in LP 00h: Supported Log Pages (see 6.4.4.1 on page 259).

<sup>h</sup> Unless otherwise stated, this Page Code has a Subpage Code FFh which returns the list of subpages associated with this Page Code as described in LP [PAGE CODE][FFh]: Supported subpages (see 6.4.4.2 on page 259).

**Table 231 — Supported log pages**

Page Code	Subpage Code <sup>h</sup>	Log Page	T10 Std	Pol <sup>a</sup>	Reset		
					Sel <sup>b</sup>	Sns <sup>c</sup>	Lod <sup>d</sup>
3Ch	00h	LP 3Ch: Drive usage information (see 6.4.29 on page 342)	VU	S	-	-	-
3Dh	00h	LP 3Dh: Subsystem Statistics (see 6.4.30 on page 344)	VU	S	-	-	-
3Eh <sup>e</sup>	00h	LP 3Eh: Engineering Use (see 6.4.31 on page 346)	VU	S	Y <sup>f</sup>	Y <sup>f</sup>	- <sup>f</sup>
	3Ch	LP 3Eh[3Ch]: Drive Control Statistics (see 6.4.32 on page 347)	VU	S	Y	-	Y

Key:  
 - No  
 Y Yes  
 S Single shared aspect  
 H Aspect related to access through the host primary ports  
 L Aspect related to access through the library port  
 P Aspect related to access through the specific drive port  
 ITN Aspect related to access through an I\_T nexus (i.e., access path)  
 ALL All aspects supported by the log page

<sup>a</sup> Policy—Which access path(s)/type(s) have common counters  
 NOTE: Prior to certain levels of code H and L aspects are shared (e.g., resets by either access path affect both)

<sup>b</sup> Aspects which may be reset using a LOG SELECT through that aspect

<sup>c</sup> Aspects reset when the entire page is read by a LOG SENSE through that aspect

<sup>d</sup> Aspects reset on a LOAD (regardless of cause of load)

<sup>e</sup> This log page is for engineering use only and is not reported in LP 00h: Supported Log Pages (see 6.4.4.1 on page 259), nor in LP [PAGE CODE][FFh]: Supported subpages (see 6.4.4.2 on page 259).

<sup>f</sup> See the page description for counters that do not follow the general behavior described in this table

<sup>g</sup> This Page Code does not have a Subpage 00h and is not reported in LP 00h: Supported Log Pages (see 6.4.4.1 on page 259).

<sup>h</sup> Unless otherwise stated, this Page Code has a Subpage Code FFh which returns the list of subpages associated with this Page Code as described in LP [PAGE CODE][FFh]: Supported subpages (see 6.4.4.2 on page 259).

**6.4.1 Log Page Format**

Each log page begins with a four-byte page header followed by zero or more variable-length log parameters defined for that log page. The log page format is defined in table 232.

**Table 232 — Log page format**

Byte	Bit								
	7 msb	6	5	4	3	2	1	0 lsb	
0	DS	SPF	PAGE CODE						
1	SUBPAGE CODE								
2	(MSB)	PAGE LENGTH (n-3)							
3								(LSB)	
Log parameter(s) (see 6.4.2)									
4	Log parameter (First)								
.									
.									
n	Log parameter (Last)								

If the SPF bit is set to 0 then the Subpage Code field is reserved and is set to zero. If the SPF bit is set to one, then the subpage format is being used and the Subpage Code field is used to determine which log parameters are to be returned.

**WARNING**

The parameters in log pages should be dynamically parsed as some parameters may not be present and new parameters may be inserted. The relative location of parameters have changed and are anticipated to continue to change.

**WARNING**

## 6.4.2 Log Parameter Format

Each log parameter begins with a 4-byte parameter header, followed by 1 or more bytes of parameter data. Table 233 shows the log parameter format. The fields of byte 2 are described under clause 6.4.2.1.

**Table 233 — Log Parameter Format**

Byte	Bit							
	7 msb	6	5	4	3	2	1	0 lsb
0	MSB							
1	PARAMETER CODE							LSB
2	DU	DS	TSD	ETC	TMC		Rsvd	LP
3	PARAMETER LENGTH (n-3)							
4	MSB							
n	Parameter Value							LSB

### 6.4.2.1 Log Parameter Byte 2 — Control Byte

A Log Parameter Control Byte is returned for each parameter code described in the log pages. The Log Parameter Control Byte is described here one time only. Any parameters using a different Log Parameter Control Byte have that byte described within that parameter.

The contents of this byte are constant; the user cannot set these values. This byte is part of the returned data described in the SCSI standard; it is described in the following list:

Bit	Description
7	DU (Disable Update): 0b
6	DS (Disable Save): 1b
5	TSD (Target Save Disable): 1b
4	ETC (Enable Threshold Comparison): 0b
3-2	TMC (Threshold Met Comparison): 00b
1	Rsvd (Reserved)
0	LP (List Parameter): 0b (indicates this is a log counter)

### 6.4.3 General Log Parameter Reset Behavior

Unless otherwise specified, each log counter is reset when read by the Log Sense command. Specific exceptions include Pages 30h, 37h, and 3Dh. Several pages have values which are reset at load time, as specified.

### 6.4.4 Supported Log Pages, Supported Log pages and Subpages, and Supported Subpages

The following methods may be used to query the drive for supported log pages:

- a) LP 00h: Supported Log Pages (see 6.4.4.1 on page 259) returns a list of supported pages with a subpage code of 00h. This is the legacy method used prior to existence of subpages with subpage code zero indicating what used to be the reserved byte;



- b) LP [PAGE CODE][FFh]: Supported subpages (see 6.4.4.2 on page 259) returns a list of all subpages with the specified page code.

If the page code in the PAGE CODE field of the LOG SENSE CDB is 00h, then a list of all log pages and all subpages supported is returned. This is the query to use when the intent is to query for a list of all pages supported by the drive. There may be log pages and subpages which are able to be read or reset which are not included in this list. Such pages are for engineering or manufacturing use and are not intended for general use.

The majority of log pages supported by this device do not have subpages and in response to queries for supported subpages return a descriptor list containing only two descriptors, one for the page code with subpage code 00h, and another for the page code with subpage code FFh. This is shown in 6.4.4.2 on page 259.

#### 6.4.4.1 LP 00h: Supported Log Pages

See LOG SELECT - 4Ch (see 5.2.8 on page 94) and LOG SENSE - 4Dh (see 5.2.9 on page 94) for directions on how to use this page. This log page returns the list of log pages supported. There may be log pages which can be read or reset which are not included in this list. Such pages are for engineering or manufacturing use and are not intended for general use. This page does not contain any log parameters.

This data can be neither reset nor written.

**Table 234 — Supported Log Pages**

Byte	Bit								
	7 msb	6	5	4	3	2	1	0 lsb	
0	DS(0b)	SPF(0b)	PAGE CODE						
1	SUBPAGE CODE (FFh)								
2	(MSB)	PAGE LENGTH							
3							(LSB)		
Supported Log Pages									
4	Supported Log Page (first)								
⋮									
n	Supported Log Page (last)								

#### Byte Description

0	
	<b>Bit Description</b>
	7 DS(0b)
	6 SPF (0b)
	5-0 Page Code (00h)
1	Subpage Code (00h)
2-3	Page Length (n-3)
4-n	Supported Log Pages: This field is a list of 1-byte log page codes and may include some of the log pages from Table 231, "Supported log pages," on page 255.

#### 6.4.4.2 LP [PAGE CODE][FFh]: Supported subpages

See LOG SENSE - 4Dh (see 5.2.9 on page 94) for directions on how to use this page. This log page returns the list of subpage codes that are implemented for the specified page code. There may be subpages which can be

read or reset which are not included in this list. Such pages are for engineering or manufacturing use and are not intended for general use. This page does not contain any log parameters.

If the page code in the PAGE CODE field of the LOG SENSE CDB is 00h, then a list of all log pages and all subpages supported is returned. There may be log pages and subpages which are able to be read or reset which are not included in this list. Such pages are for engineering or manufacturing use and are not intended for general use.

This data can be neither reset nor written.

**Table 235 — Supported Subpages**

Byte	Bit							
	7 msb	6	5	4	3	2	1	0 lsb
0	DS(0b)	SPF(1b)	PAGE CODE					
1	SUBPAGE CODE (FFh)							
2	(MSB)	PAGE LENGTH						(LSB)
3	Supported Subpage descriptors							
4	Supported Subpage descriptor (first)							
	.							
	.							
	.							
n	Supported Subpage descriptor (last)							

**Byte Description**

0

**Bit Description**

7 DS(0b)

6 SPF (1b)

5-0 PAGE CODE

1 SUBPAGE CODE (FFh)

2-3 PAGE LENGTH (n-3)

4-n Supported subpage descriptor list: This descriptor list may include some of the subpages from Table 231, "Supported log pages," on page 255 for the listed PAGE CODE. Each descriptor is a 2-byte descriptor listing the page code and subpage code of a supported page.

Table 236 — Supported Subpage descriptor

Byte	Bit							
	7 msb	6	5	4	3	2	1	0 lsb
0	Reserved		PAGE CODE					
1	SUBPAGE CODE							

**Byte Description**

0

**Bit Description**

7-6 Reserved

5-0 PAGE CODE: The page code number of a supported log page

1 SUBPAGE CODE: A supported subpage number for the listed log page

**6.4.5 LP 02h: Write Error Counters**

See LOG SELECT - 4Ch (see 5.2.8 on page 94) and LOG SENSE - 4Dh (see 5.2.9 on page 94) for directions on how to use this page. This page is for Write Errors.

### 6.4.5.1 Parameter Definitions (02h)

Parameters 0000h through 0002h are not supported and are returned as 0000\_0000h.

===== WARNING ===== WARNING =====

Log pages may have different reset behaviors. Care should be taken to ensure counters are processed appropriately, including consideration of their reset behaviors. While reset behaviors may be different between products, an attempt is made to maintain compatibility between generations of a given product. See “Log Parameters (LP)” on page 255.

===== WARNING ===== WARNING =====

===== WARNING ===== WARNING =====

The parameters in log pages should be dynamically parsed as some parameters may not be present and new parameters may be inserted. The relative location of parameters have changed and are anticipated to continue to change.

===== WARNING ===== WARNING =====

**Table 237 — LP 02h: Write Error Log Parameters**

Parameter Code (in Hex)	Counter: Description	Size
0000h	Not supported	4
0001h	Not supported	4
0002h	<b>Total Write Errors {02h:0002h}</b> : This is the sum of parameter 0003h and 0006h	4
0003h	<b>Total Corrected Write Errors {02h:0003h}</b> :: ECC correction was used. It is incremented on the initial write whether it triggered error recovery (temp or perm) or not. This is a rollup of LP 33h:0000h.	4
0004h	Not Supported	4
0005h	<b>Total Write Kibibytes Processed {02h:0005h}</b> : Each count represents a kibibyte (1024 bytes) of data processed across the host interface during write-type commands. The count does not include ERP retries. This field is identical to the Host Write Kibibytes Processed field of Page Code 38h, parameter code 0001h.	6
0006h	<b>Total Uncorrected Write Errors {02h:0006h}</b> :: Count of Temp errors where ECC data correction was insufficient to nominally write the dataset. This count is independent of whether or not ECC correction occurred on the initial error that triggered successful error recovery, but it excludes temps which started with servo errors. This count is updated at the end of a successful data recovery. This is a rollup of LP 33:0005h, 33:0007h.	4
8000h	Unspecified	8
8001h	Unspecified	4

### 6.4.6 LP 03h: Read Error Counters

See LOG SELECT - 4Ch (see 5.2.8 on page 94) and LOG SENSE - 4Dh (see 5.2.9 on page 94) for directions on how to use this page. This page is for Read Errors.

### 6.4.6.1 Parameter Definitions (03h)

Parameters 0000h through 0002h are not supported and are returned as 0000\_0000h.

===== WARNING ===== WARNING =====

Log pages may have different reset behaviors. Care should be taken to ensure counters are processed appropriately, including consideration of their reset behaviors. While reset behaviors may be different between products, an attempt is made to maintain compatibility between generations of a given product. See “Log Parameters (LP)” on page 255.

===== WARNING ===== WARNING =====

===== WARNING ===== WARNING =====

The parameters in log pages should be dynamically parsed as some parameters may not be present and new parameters may be inserted. The relative location of parameters have changed and are anticipated to continue to change.

===== WARNING ===== WARNING =====

**Table 238 — LP 03h: Read Error Log Parameters**

Parameter Code	Counter: Description	Size
0000h	Not supported	4
0001h	Not supported	4
0002h	<b>Total Read Errors {03h:0002h}</b> : This is the sum of parameter 0003h and 0006h	4
0003h	<b>Total Corrected Read Errors {03h:0003h}</b> : ECC C2 correction was used. It is incremented on the initial read whether it triggered error recovery (temp or perm) or not. This is a rollup of LP 34h:0000h.	4
0004h	Not Supported	4
0005h	<b>Total Read Kibibytes Processed {03h:0005h}</b> : Each count represents a kibibyte (1024 bytes) processed across the host interface during read-type commands. The count does not include ERP retries. This field is identical to the Host Read Kibibytes Processed field of Page Code 38h, parameter code 0003h.	6
0006h	<b>Total Uncorrected Read Errors {03h:0006h}</b> : Count of Temp errors where ECC data correction was insufficient to nominally read the dataset. This count is independent of whether or not ECC C2 correction occurred on the initial error that triggered successful error recovery, but it excludes temps which started with servo errors. This count is updated at the end of a successful data recovery. This is a rollup of LP 34:0005h, 34:0007h.	4
8000h	Unspecified	8

### 6.4.7 LP 06h: Non-Medium Errors

See LOG SELECT - 4Ch (see 5.2.8 on page 94) and LOG SENSE - 4Dh (see 5.2.9 on page 94) for directions on how to use this page. This page sums the occurrences of error events other than write or read failures. Parameter codes do not discriminate among the various types of events.

### 6.4.7.1 Parameter Definitions (06h)

==== WARNING ===== WARNING =====

Log pages may have different reset behaviors. Care should be taken to ensure counters are processed appropriately, including consideration of their reset behaviors. While reset behaviors may be different between products, an attempt is made to maintain compatibility between generations of a given product. See “Log Parameters (LP)” on page 255.

==== WARNING ===== WARNING =====

==== WARNING ===== WARNING =====

The parameters in log pages should be dynamically parsed as some parameters may not be present and new parameters may be inserted. The relative location of parameters have changed and are anticipated to continue to change..

==== WARNING ===== WARNING =====

**Table 239 — LP 06h: Non-Medium Errors log parameter codes**

Code	Counter: Description	Size
0000h	Total Non-Medium Error Count {06h:0000h}:	4

### 6.4.8 LP 0Ch: Sequential-Access Device

See LOG SELECT - 4Ch (see 5.2.8 on page 94) and LOG SENSE - 4Dh (see 5.2.9 on page 94) for directions on how to use this page. This page is for counters specific to tape drives.

## 6.4.8.1 Parameter Definitions (0Ch)

**WARNING****WARNING**

Log pages may have different reset behaviors. Care should be taken to ensure counters are processed appropriately, including consideration of their reset behaviors. While reset behaviors may be different between products, an attempt is made to maintain compatibility between generations of a given product. See “Log Parameters (LP)” on page 255.

**WARNING****WARNING****WARNING****WARNING**

The parameters in log pages should be dynamically parsed as some parameters may not be present and new parameters may be inserted. The relative location of parameters have changed and are anticipated to continue to change.

**WARNING****WARNING****Table 240 — LP 0Ch: Sequential-Access Device log parameters** (part 1 of 2)

Code	Counter: Description	Length
0000h	<b>Total Channel Write Bytes {0Ch:0000h}</b> : The total number of bytes of data written from the host on this mount.	8
0001h	<b>Total Device Write Bytes {0Ch:0001h}</b> : The total number of bytes of data written to tape on this mount, not counting ECC and formatting overhead. This is the number of data bytes after compression.	8
0002h	<b>Total Device Read Bytes {0Ch:0002h}</b> : The total number of bytes of data read from tape on this mount, not counting ECC and formatting overhead. This is the number of compressed data bytes read from media before decompression.	8
0003h	<b>Total Channel Read Bytes {0Ch:0003h}</b> : The total number of bytes of data read to the host on this mount.	8
0004h	<b>Approximate native capacity from BOP to EOD {0Ch:0004h}</b> : This is in megabytes (i.e., $10^6$ ). This is not sensitive to the current position of the medium. The approximate native capacity between EOD and EW is the difference of parameter 0005h and this parameter. Conditions may occur that reduce the amount of data that is written before reaching EW. EOD may be beyond LEOP. A value of all bits set to one indicates that this information is invalid (e.g., no volume is mounted, EOD information needs to be rebuilt).	4
0005h	<b>Approximate native capacity between BOP and EW of the current partition {0Ch:0005h}</b> : This is in megabytes (i.e., $10^6$ ). If no volume is mounted or this value is unknown the device server shall set all bits in this parameter to one.	4
0006h	<b>Minimum native capacity between EW and LEOP of the current partition {0Ch:0006h}</b> : This is in megabytes (i.e., $10^6$ ). If no volume is mounted the device server shall set all bits in this parameter to one.	4
0007h	<b>Approximate native capacity from BOP to the current position of the medium {0Ch:0007h}</b> : This is in megabytes (i.e., $10^6$ ). If no volume is mounted the device server shall set all bits in this parameter to one.	4
0008h	<b>Maximum native capacity that is currently allowed to be in the device object buffer {0Ch:0008h}</b> : This is in megabytes (i.e., $10^6$ ). This value may change depending on the current position of the medium (e.g., available native capacity may decrease as the current position of the medium approaches LEOP).	4
0100h	<b>Cleaning Requested {0Ch:0100h}</b> : A non-zero value indicates a cleaning action is requested by the drive.	8

Table 240 — LP 0Ch: Sequential-Access Device log parameters (part 2 of 2)

Code	Counter: Description	Length
8000h	<b>Total Megabytes Processed Since Cleaning {0Ch:8000h}</b> : Number of megabytes (10 <sup>6</sup> ) processed to tape since last cleaning (written after compression/read before decompression)	4
8001h	<b>Lifetime load cycles {0Ch:8001h}</b> : This is the number of times the drive has been loaded in its lifetime.	4
8002h	<b>Lifetime cleaning cycles {0Ch:8002h}</b> : This is the number of times over its lifetime the drive has been cleaned using a cleaner cartridge.	4
8003h	<b>Lifetime Power-on time {0Ch:8003h}</b> : This is the number of seconds the drive has been powered on over its lifetime.	4

#### 6.4.9 LP 0Dh[01h]: Environmental Reporting (LTO9 and later)

See LOG SELECT - 4Ch (see 5.2.8) and LOG SENSE - 4Dh (see 5.2.9) for directions on how to use this page. This page is for counters specific to tape drives.

##### 6.4.9.1 Parameter Reset Behavior

##### 6.4.9.2 Parameter Definitions

===== WARNING ===== WARNING =====  
 Log pages may have different reset behaviors. Care should be taken to ensure counters are processed appropriately, including consideration of their reset behaviors. While reset behaviors may be different between products, an attempt is made to maintain compatibility between generations of a given product. See “Log Parameters (LP)” on page 255.

===== WARNING ===== WARNING =====

===== WARNING ===== WARNING =====  
 The parameters in log pages should be dynamically parsed as some parameters may not be present and new parameters may be inserted. The relative location of parameters have changed and are anticipated to continue to change.

===== WARNING ===== WARNING =====

Table 241 — LP 0Dh[01h]: Environmental Reporting log parameters

Code	Counter: Description	Length
0000h	<b>Deck Temperature {0Dh[01h]:0000h}</b> : Information related to the reporting of temperature. See Temperature Report parameter data (see 6.4.9.2.1 on page 267) for the format of this parameter.	8
0001h to 00FFh	<b>Additional Component Temperatures {0Dh[01h]:00001h to 00FFh}</b> : Some products may report additional component temperatures at any parameter in this range. See Temperature Report parameter data (see 6.4.9.2.1 on page 267) for the format of these parameters.	8
0100h	<b>Deck Relative Humidity {0Dh[01h]:0100h}</b> : Information related to the reporting of relative humidity. See Relative Humidity Report parameter data (see 6.4.9.2.2 on page 268) for the format of this parameter.	8



### 6.4.9.2.1 Temperature Report parameter data

The Temperature Report parameter data has the format shown in table 242.

**Table 242 — Temperature Report parameter data format**

Byte	Bit							
	7 msb	6	5	4	3	2	1	0 lsb
0	Reserved							MTV
1	TEMPERATURE							
2	LIFETIME MAXIMUM TEMPERATURE							
3	LIFETIME MINIMUM TEMPERATURE							
4	MAXIMUM TEMPERATURE SINCE POWER ON							
5	MINIMUM TEMPERATURE SINCE POWER ON							
6	MAXIMUM MOUNTED TEMPERATURE							
7	MINIMUM MOUNTED TEMPERATURE							

The temperature values reported in the Temperature Report parameter data indicate a temperature in degrees Celsius. Negative values are indicated by two's complement notation. A value of -128 (i.e., 80h) specifies that temperature is not valid.

#### Byte Description

0															
	<table> <thead> <tr> <th>Bit</th> <th>Description</th> </tr> </thead> <tbody> <tr> <td>7-1</td> <td>Reserved</td> </tr> <tr> <td>0</td> <td>MTV (mounted temperature valid): Indicates if the MAXIMUM MOUNTED TEMPERATURE field and the MINIMUM MOUNTED TEMPERATURE field are valid.</td> </tr> <tr> <td></td> <td> <table> <thead> <tr> <th>Value</th> <th>Description</th> </tr> </thead> <tbody> <tr> <td>0b</td> <td>Fields are invalid</td> </tr> <tr> <td>1b</td> <td>Fields are valid</td> </tr> </tbody> </table> </td> </tr> </tbody> </table>	Bit	Description	7-1	Reserved	0	MTV (mounted temperature valid): Indicates if the MAXIMUM MOUNTED TEMPERATURE field and the MINIMUM MOUNTED TEMPERATURE field are valid.		<table> <thead> <tr> <th>Value</th> <th>Description</th> </tr> </thead> <tbody> <tr> <td>0b</td> <td>Fields are invalid</td> </tr> <tr> <td>1b</td> <td>Fields are valid</td> </tr> </tbody> </table>	Value	Description	0b	Fields are invalid	1b	Fields are valid
Bit	Description														
7-1	Reserved														
0	MTV (mounted temperature valid): Indicates if the MAXIMUM MOUNTED TEMPERATURE field and the MINIMUM MOUNTED TEMPERATURE field are valid.														
	<table> <thead> <tr> <th>Value</th> <th>Description</th> </tr> </thead> <tbody> <tr> <td>0b</td> <td>Fields are invalid</td> </tr> <tr> <td>1b</td> <td>Fields are valid</td> </tr> </tbody> </table>	Value	Description	0b	Fields are invalid	1b	Fields are valid								
Value	Description														
0b	Fields are invalid														
1b	Fields are valid														
1	<p>TEMPERATURE: The temperature in degrees Celsius most recently read by the temperature sensor.</p> <table> <thead> <tr> <th>Value</th> <th>Description</th> </tr> </thead> <tbody> <tr> <td>80h</td> <td>There is no valid temperature to report.</td> </tr> <tr> <td>other</td> <td>The temperature in two's complement notation (i.e., signed).</td> </tr> </tbody> </table>	Value	Description	80h	There is no valid temperature to report.	other	The temperature in two's complement notation (i.e., signed).								
Value	Description														
80h	There is no valid temperature to report.														
other	The temperature in two's complement notation (i.e., signed).														
2	<p>LIFETIME MAXIMUM TEMPERATURE: The maximum temperature in degrees Celsius read by the temperature sensor over the life of the drive.</p> <table> <thead> <tr> <th>Value</th> <th>Description</th> </tr> </thead> <tbody> <tr> <td>80h</td> <td>There is no valid temperature to report.</td> </tr> <tr> <td>other</td> <td>The temperature in two's complement notation (i.e., signed).</td> </tr> </tbody> </table>	Value	Description	80h	There is no valid temperature to report.	other	The temperature in two's complement notation (i.e., signed).								
Value	Description														
80h	There is no valid temperature to report.														
other	The temperature in two's complement notation (i.e., signed).														
3	<p>LIFETIME MINIMUM TEMPERATURE: The minimum temperature in degrees Celsius read by the temperature sensor over the life of the drive.</p> <table> <thead> <tr> <th>Value</th> <th>Description</th> </tr> </thead> <tbody> <tr> <td>80h</td> <td>There is no valid temperature to report.</td> </tr> <tr> <td>other</td> <td>The temperature in two's complement notation (i.e., signed).</td> </tr> </tbody> </table>	Value	Description	80h	There is no valid temperature to report.	other	The temperature in two's complement notation (i.e., signed).								
Value	Description														
80h	There is no valid temperature to report.														
other	The temperature in two's complement notation (i.e., signed).														
4	<p>MAXIMUM TEMPERATURE SINCE POWER ON: The maximum temperature in degrees Celsius read by the temperature sensor since power on (i.e., the last power cycle).</p> <table> <thead> <tr> <th>Value</th> <th>Description</th> </tr> </thead> <tbody> <tr> <td>80h</td> <td>There is no valid temperature to report.</td> </tr> <tr> <td>other</td> <td>The temperature in two's complement notation (i.e., signed).</td> </tr> </tbody> </table>	Value	Description	80h	There is no valid temperature to report.	other	The temperature in two's complement notation (i.e., signed).								
Value	Description														
80h	There is no valid temperature to report.														
other	The temperature in two's complement notation (i.e., signed).														

- 5 MINIMUM TEMPERATURE SINCE POWER ON The minimum temperature in degrees Celsius read by the temperature sensor since power on (i.e., the last power cycle).

**Value Description**

- 80h There is no valid temperature to report.  
 other The temperature in two's complement notation (i.e., signed).

- 6 MAXIMUM MOUNTED TEMPERATURE: The meaning of this field depends on the value of the MTV bit.

**MTV Meaning**

- 0b This field is ignored.  
 1b The maximum temperature detected from the most recent time that the volume was mounted until:  
 A) the current time, if the volume has not been demounted; or  
 B) the time at which the volume was demounted.

- 7 MINIMUM MOUNTED TEMPERATURE: The meaning of this field depends on the value of the MTV bit.

**MTV Meaning**

- 0b This field is ignored.  
 1b The minimum temperature detected from the most recent time that the volume was mounted until:  
 A) the current time, if the volume has not been demounted; or  
 B) the time at which the volume was demounted.

#### 6.4.9.2.2 Relative Humidity Report parameter data

The Relative Humidity Report parameter data has the format shown in table 243.

**Table 243 — Relative Humidity Report parameter data format**

Byte	Bit							
	7 msb	6	5	4	3	2	1	0 lsb
0	Reserved							MRHV
1	RELATIVE HUMIDITY							
2	LIFETIME MAXIMUM RELATIVE HUMIDITY							
3	LIFETIME MINIMUM RELATIVE HUMIDITY							
4	MAXIMUM RELATIVE HUMIDITY SINCE POWER ON							
5	MINIMUM RELATIVE HUMIDITY SINCE POWER ON							
6	MAXIMUM MOUNTED RELATIVE HUMIDITY							
7	MINIMUM MOUNTED RELATIVE HUMIDITY							

**Byte Description**

0

**Bit Description**

- 7-1 Reserved  
 0 MRHV (mounted relative humidity valid): Indicates if the MAXIMUM MOUNTED RELATIVE HUMIDITY field and the MINIMUM MOUNTED RELATIVE HUMIDITY field are valid.  
**Value Description**  
 0b Fields are invalid  
 1b Fields are valid

- 1 RELATIVE HUMIDITY: The relative humidity most recently read from the humidity sensor.

**Value Description**

- 0-100 Relative humidity  
 255 No valid relative humidity to report  
 others Reserved

- 2 LIFETIME MAXIMUM RELATIVE HUMIDITY: The maximum relative humidity read by the humidity sensor over the life of the drive.
- | Value  | Description                          |
|--------|--------------------------------------|
| 0-100  | Relative humidity                    |
| 255    | No valid relative humidity to report |
| others | Reserved                             |
- 3 LIFETIME MINIMUM RELATIVE HUMIDITY: The minimum relative humidity read by the humidity sensor over the life of the drive.
- | Value  | Description                          |
|--------|--------------------------------------|
| 0-100  | Relative humidity                    |
| 255    | No valid relative humidity to report |
| others | Reserved                             |
- 4 MAXIMUM RELATIVE HUMIDITY SINCE POWER ON: The maximum relative humidity read by the humidity sensor since power on (i.e., the last power cycle).
- | Value  | Description                          |
|--------|--------------------------------------|
| 0-100  | Relative humidity                    |
| 255    | No valid relative humidity to report |
| others | Reserved                             |
- 5 MINIMUM RELATIVE HUMIDITY SINCE POWER ON: The minimum relative humidity read by the humidity sensor since power on (i.e., the last power cycle).
- | Value  | Description                          |
|--------|--------------------------------------|
| 0-100  | Relative humidity                    |
| 255    | No valid relative humidity to report |
| others | Reserved                             |
- 6 MAXIMUM MOUNTED RELATIVE HUMIDITY: The meaning of this field depends on the value of the MRHV bit.
- | MRHV | Meaning   |
|------|---|
| 0b   | This field is ignored.  |
| 1b   | The maximum relative humidity detected from the most recent time that the volume was mounted until: <ul style="list-style-type: none"> <li>A) the current time, if the volume has not been demounted; or</li> <li>B) the time at which the volume was demounted.</li> </ul> |
- 7 MINIMUM MOUNTED RELATIVE HUMIDITY: The meaning of this field depends on the value of the MRHV bit.
- | MRHV | Meaning   |
|------|---|
| 0b   | This field is ignored.  |
| 1b   | The minimum relative humidity detected from the most recent time that the volume was mounted until: <ul style="list-style-type: none"> <li>A) the current time, if the volume has not been demounted; or</li> <li>B) the time at which the volume was demounted.</li> </ul> |

#### 6.4.10 LP 11h: DT Device Status

See LOG SELECT - 4Ch (see 5.2.8 on page 94) and LOG SENSE - 4Dh (see 5.2.9 on page 94) for directions on how to use this page.

The DT Device Status log page (see table 244) defines log information pertaining to the DT device (i.e. tape drive) and DT device primary ports.

**Table 244 — LP 11h: DT Device Status log page**

Byte	Bit							
	7 msb	6	5	4	3	2	1	0 lsb
0	Reserved		PAGE CODE (11h)					
1	Reserved							
2	(MSB)	PAGE LENGTH (n-3)						(LSB)
3								
4	DT Device Status log parameters							
n								

**Byte Description**

0	<b>Bit</b>	<b>Description</b>
	7-6	Reserved
	5-0	Page Code (11h)
1		Reserved
2-3		Page Length (n-3)
4-n		DT Device Status log parameters(see 6.4.10.1).

**6.4.10.1 Parameter Definitions (11h)**

===== WARNING =====

Log pages may have different reset behaviors. Care should be taken to ensure counters are processed appropriately, including consideration of their reset behaviors. While reset behaviors may be different between products, an attempt is made to maintain compatibility between generations of a given product. See “Log Parameters (LP)” on page 255.

===== WARNING =====

===== WARNING =====

The parameters in log pages should be dynamically parsed as some parameters may not be present and new parameters may be inserted. The relative location of parameters have changed and are anticipated to continue to change.

===== WARNING =====

DT Device Status log parameters are shown in table 245.

**Table 245 — DT Device Status log parameters of LP 11h (part 1 of 2)**

Parameter Code	Description
0000h	<b>Very high frequency data {11h:0000h}</b> : (see 6.4.10.1.1)
0001h	<b>Very high frequency polling delay {11h:0001h}</b> : (see 6.4.10.1.2)
0002h	<b>DT device ADC data encryption control status</b> : Used on the Automation Drive Interface only
0003h	<b>Key management error data</b> : Used on the Automation Drive Interface only
0004h	<b>Extended very high frequency data {11h:0004h}</b> : (see 6.4.10.1.3)
0101h - 01FFh	<b>DT device primary port status {11h:0101h+}</b> : (see 6.4.10.1.4)
0200h	<b>Potential conflict list entries present {11h:0200h}</b> : (see 6.4.10.1.7)

Table 245 — DT Device Status log parameters of LP 11h (part 2 of 2)

Parameter Code	Description
0201h to 02FFh	<b>Potential conflict list {11h:0201h+}</b> : (see 6.4.10.1.8) Note - At the time of publication, this device only supports a list of five entries (i.e., 0201h to 0205h).
0301h to 03FFh	<b>DT device primary port physical interface information</b> : (see 6.4.10.1.9) Note - Not returned on SAS devices
8000h	<b>Medium VolSer {11h:8000h}</b> : (see 6.4.10.1.10)
8001h	<b>Medium Status Data {11h:8001h}</b> : (see 6.4.10.1.11)
8100h	<b>Drive Status Data {11h:8100h}</b> : (see 6.4.10.1.12)
9101h to 9102h	<b>Primary Port Features {11h:9101h+}</b> : (see 6.4.10.1.13)
E000h	<b>Encryption Control Descriptor {11h:E00h}</b> : (see 6.4.10.1.14)

#### 6.4.10.1.1 Very high frequency data log parameter

The very high frequency data log parameter format is shown in Table 246.

Table 246 — Very high frequency data log parameter format of LP 11h

Byte	Bit							
	7 msb	6	5	4	3	2	1	0 lsb
0	(MSB) _____							
1	PARAMETER CODE (0000h)							(LSB)
2	DU (0)	Obsolete	TSD (0)	ETC (0)	TMC (0)		LBIN (1)	LP (1)
3	PARAMETER LENGTH (04h)							
4	_____							
7	VHF data descriptor _____							

#### Byte Description

- 0-1 PARAMETER CODE: (0000h)
- 2 Parameter list control byte - binary format list log parameter
- | Bit | Description |
|-----|-------------|
| 7   | DU: 0b      |
| 6   | Obsolete    |
| 5   | TSD: 0b     |
| 4   | ETC: 0b     |
| 3-2 | TMC: 00b    |
| 1   | LBIN: 1b    |
| 0   | LP: 1b      |
- 3 PARAMETER LENGTH: (04h)  
Transfer of the complete parameter is required.

## 4-7 VHF data descriptor

The VHF data descriptor is defined in table 247. Returned data shall reflect the last known values since the DT device initialized.

**Table 247 — VHF data descriptor**

Byte	Bit							
	7 msb	6	5	4	3	2	1	0 lsb
4	PAMR	HIU	MACC	CMPR	WRTP	CRQST	CRQRD	DINIT
5	INXTN	Rsvd	RAA	MPRSNT	Rsvd	MSTD	MTHRD	MOUNTED
6	DT DEVICE ACTIVITY							
7	VS	Rsvd	TDDEC	EPP	ESR	RRQST	INTFC	T AFC

NOTE 39 - In addition to reliance on indication of initialization completion, reliance on returned values should also take into consideration conditions indicated by changes in Tape Alert flag status, and process those first as needed.

**Byte Description**

4

**Bit Description**

7 PAMR (prevent/allow medium removal):

**Value Description**

0b Medium removal is not prevented as the result of a PREVENT/ALLOW MEDIUM REMOVAL command on LUN 0.

1b Medium removal is prevented as the result of a PREVENT/ALLOW MEDIUM REMOVAL command on LUN 0.

6 HIU (host initiated unload):

**Value Description**

0b Volume is not in an unload state due to a LOAD UNLOAD command.

1b Volume is unloaded due to a LOAD UNLOAD command on LUN 0.

5 MACC (medium auxiliary memory accessible):

**Value Description**

0b Medium Auxiliary Memory (MAM) is not accessible.

1b Medium Auxiliary Memory (MAM) is accessible.

4 CMPR (compress):

**Value Description**

0b Data compression is not enabled.

1b Data compression is enabled.

3 WRTP (write protect): only valid if the MPRSNT bit is set to one.

**Value Description**

0b Volume is not physically write protected.

1b Volume is physically write protected.

2 CRQST (cleaning requested):

**Value Description**

0b Cleaning not requested.

1b Cleaning requested.

1 CRQRD (cleaning required):

**Value Description**

0b Cleaning not required; normal operation possible without cleaning.

1b Cleaning required; normal operation may not be possible until drive is cleaned.

0 DINIT (DT device initialized):

**Value Description**

0b DT device initialization is required or incomplete. VHF data not valid.

1b VHF data valid

5

<b>Bit</b>	<b>Description</b>
7	INXTN (in transition): Indicates the stability of the other bits in this byte (i.e., byte 5) and whether state transitions are taking place.
	<b>Value</b> <b>Description</b>
	0b                  Device is in the state reflected by the remaining bits in this byte and is making no attempt to leave this state.
	1b                  Device is transitioning to another state; other bits in this byte are in transition.
6	Rsvd (Reserved)
5	RAA (robotic access allowed):
	<b>Value</b> <b>Description</b>
	0b                  Library or Medium Changer should not move a volume to or from the device.
	1b                  Library or Medium Changer may move a volume to or from the device.
4	MPRSNT (medium present):
	<b>Value</b> <b>Description</b>
	0b                  The device does not detect a volume present.
	1b                  The device detects a volume present.
3	Rsvd (Reserved)
2	MSTD (medium seated):
	<b>Value</b> <b>Description</b>
	0b                  Cartridge is not seated; further mechanical motion remains in order to complete the loading process, exclusive of tape threading.
	1b                  Cartridge is mechanically seated within the loading mechanism (i.e., the physical loading process has completed).
1	MTHRD (medium threaded):
	The value of the MTHRD bit may or may not correspond to the device responding with a status of GOOD to a TEST UNIT READY command, as additional processing may be required by the device after threading before the logical unit becomes ready.
	<b>Value</b> <b>Description</b>
	0b                  Medium is not threaded.
	1b                  Medium has been threaded; tape motion operations are possible.
	The value of the MTHRD bit may or may not correspond to the DT device responding with a status of GOOD to a TEST UNIT READY command, as additional processing may be required by the DT device after threading before the logical unit becomes ready.
0	MOUNTED:
	<b>Value</b> <b>Description</b>
	0b                  Volume is not mounted.
	1b                  Volume is mounted. The drive may be able to respond to a TEST UNIT READY command with GOOD status, however when a cleaning cartridge or microcode update cartridge is loaded the drive may respond to a TEST UNIT READY command with a CHECK CONDITON with the sense key set to NOT READY.

6 DT DEVICE ACTIVITY: This field is used to describe the current activity of the device

Value	Description
00h	No DT device activity
01h	Cleaning operation in progress
02h	Medium is being loaded
03h	Medium is being unloaded
04h	Other medium activity
05h	Reading from medium
06h	Writing to medium
07h	Locating medium
08h	Rewinding medium
09h	Erasing medium
0Ah	Formatting medium
0Bh	Calibrating medium
0Ch	Other DT device activity
0Dh	Microcode update in progress
0Eh	Reading encrypted from medium
0Fh	Writing encrypted to medium

7

**Bit Description**

7 vs: (0b)

6-3 Reserved

5 TDDEC (tape diagnostic data entry created):

**Value Description**

0b The device has not created a new Tape Diagnostic Data log page entry since the last retrieval of any of the parameters from the Tape Diagnostic Data log page by this I\_T nexus.

1b The device has created a new Tape Diagnostic Data log page entry since the last retrieval of any of the parameters from the Tape Diagnostic Data log page by this I\_T nexus.

4 EPP (encryption parameters present):

**Value Description**

0b The device does not have a set of saved data encryption parameters with either the ENCRYPTION MODE field set to a value other than DISABLE or the DECRYPTION MODE field set to a value other than DISABLE

1b The device has a set of saved data encryption parameters with either the ENCRYPTION MODE field set to a value other than DISABLE or the DECRYPTION MODE field set to a value other than DISABLE

3 ESR (encryption service request):

**Value Description**

0b At least one bit in the SERVICE REQUEST INDICATORS field in the DT device ADC data encryption control status log parameter has been set to one since the last retrieval of the DT device ADC data encryption control status log parameter by this I\_T nexus and at least one bit in the SERVICE REQUEST INDICATORS field in the DT device ADC data encryption control status log parameter is set to one.

1b No bits in the SERVICE REQUEST INDICATORS field in the DT device ADC data encryption control status log parameters have been set to one since the last retrieval of the DT device ADC data encryption control status log parameter by



this I\_T nexus or all of the bits in the SERVICE REQUEST INDICATORS field in the DT device ADC data encryption control status log parameter are set to zero.

2	RRQST (recovery requested):	
	<b>Value</b>	<b>Description</b>
	0b	No recovery procedure is requested.
	1b	Device has detected an error and one or more requested recovery procedures are available via the ADC Requested Recovery log page.
1	INTFC (interface changed):	
	<b>Value</b>	<b>Description</b>
	0b	No fields in the DT device primary port status log parameters have changed since the last retrieval of any of the DT device primary port status log parameters from the DT Device Status log page over this I_T nexus.
	1b	One or more fields in the DT device primary port status log parameters have changed since the last retrieval of any of the DT device primary port status log parameters from the DT Device Status log page over this I_T nexus.
0	TAFC (TapeAlert state flag changed):	
	<b>Value</b>	<b>Description</b>
	0b	No TapeAlert state flag has changed since the last retrieval of the TapeAlert Response log page over this I_T nexus.
	1b	At least one TapeAlert state flag has changed since the last retrieval of the TapeAlert Response log page over this I_T nexus.

#### 6.4.10.1.2 Very high frequency polling delay log parameter

The very high frequency polling delay log parameter format is shown in Table 248.

**Table 248 — Very high frequency polling delay log parameter format of LP 11h**

Byte	Bit							
	7 msb	6	5	4	3	2	1	0 lsb
0	(MSB) _____							
1	PARAMETER CODE (0001h)							(LSB)
2	DU (0)	Obsolete	TSD (0)	ETC (0)	TMC (00)		LBIN (1)	LP (1)
3	PARAMETER LENGTH (02h)							
4	(MSB) _____							
5	VHF POLLING DELAY							(LSB)

#### Byte Description

0-1 PARAMETER CODE: (0001h)

2 Parameter list control byte - binary format list log parameter

#### Bit Description

7 DU: 0b

6 Obsolete

5 TSD: 0b

4 ETC: 0b

3-2 TMC: 00b

1 LBIN: 1b

0 LP: 1b

3 PARAMETER LENGTH: (02h)

Transfer of the complete parameter is required.

4-7 VHF POLLING DELAY: The minimum delay in milliseconds before another DT Device Status log page should be requested.

### 6.4.10.1.3 Extended very high frequency data log parameter

The extended very high frequency data log parameter format is shown in table 249. This should be used instead of the very high frequency data log parameter.

**Table 249 — Extended very high frequency data log parameter format of LP 11h**

Byte	Bit							
	7 msb	6	5	4	3	2	1	0 lsb
0	(MSB)							
1	PARAMETER CODE (0004h)							
	(LSB)							
2	Parameter list control byte - binary format list log parameter							
	du	Obsolete	tsd	etc	tmc	format and linking		
3	PARAMETER LENGTH (08h)							
4	VHF data descriptor							
7								
8	Reserved						OVER- WRITE	PCL_P
9	Vendor-Reserved						HOST- LOGIN	SM
10	Reserved							
11								

#### Byte Description

0 to 1 PARAMETER CODE: (0004h)

2 Parameter list control byte - binary format list log parameter

#### Bit Description

7 DU: 0b

6 Obsolete

5 TSD: 0b

4 ETC: 0b

3-2 TMC: 00b

1 LBIN: 1b

0 LP: 1b

3 PARAMETER LENGTH: (08h)

4 to 7 The VHF data descriptor is defined in Very high frequency data log parameter (see 6.4.10.1.1 on page 271).

8

#### Bit Description

7 to 2 Reserved

1 OVERWRITE:

Value

0b

Description

The OVERWRITE bit is set to zero if:

a) a Hard Reset occurs; or

b) a volume is inserted (i.e., MPRSNT (medium present) of the VHF parameter data transitions from 0b to 1b).

0 1b An overwrite occurs and the write mode is not set to append-only mode.  
 0 PCL\_P (potential conflict list present) bit is set as specified in 4.23 and indicates the presence of the Potential conflict list log parameter(s) (see 6.4.10.1.8 on page 282).

9

**Bit Description**

7 to 2 Reserved

1 HOSTLOGIN:

**Value Description**

0b No host login has occurred since this I\_T nexus last retrieved the Host Login Table.

1b At least one host login has occurred since this I\_T nexus last retrieved the Host Login Table.

0 SM (sleep mode): Indicates the power condition in which the drive is operating (see 6.6.16 MP 1Ah: Power Condition)

**Value Description**

0b The device is operating in the active power condition

1b The device is operating in one of the low power states (e.g., IDLE\_C)

10-11 Reserved

**6.4.10.1.4 Primary port status log parameter(s)**

There is a primary port status log parameter for each primary port of the device. The format is shown in table 250.

**Table 250 — Primary port status log parameter(s) format of LP 11h**

Byte	Bit							
	7 msb	6	5	4	3	2	1	0 lsb
0	(MSB) _____							
1	PARAMETER CODE							(LSB)
2	DU (0)	Obsolete	TSD (0)	ETC (0)	TMC (00)		LBIN (1)	LP (1)
3	PARAMETER LENGTH (n-3)							
4	(MSB) _____							
n	Primary port status data							(LSB)

**Byte Description**

0-1 PARAMETER CODE:  
 0100h plus the value of the Relative Target Port field associated with that port. The Relative Target Port is the same as the relative target port value defined in the VPD pages of inquiry

**Value Description**

0101h Primary port 1; traditionally known as port 0.

0102h Primary port 2; traditionally known as port 1.

2 Parameter list control byte - binary format list log parameter

**Bit Description**

7 DU: 0b

6 Obsolete

5 TSD: 0b

4 ETC: 0b

3-2 TMC: 00b

1 LBIN: 1b

0 LP: 1b

3 PARAMETER LENGTH:

4-7 Primary port status data: This is determined by the protocol of the port with which the parameter is associated. The protocol of the port is reported in the PROTOCOL IDENTIFIER field of the Relative target port identifier designation descriptor of the Device identification VPD page for the associated port.

Value	Description
0h	Fibre Channel port status data (see 6.4.10.1.5 on page 278)
6h	Serial Attached SCSI port status data (see 6.4.10.1.6 on page 280)

#### 6.4.10.1.5 Fibre Channel port status data

The format of the primary port status data for a Fibre Channel port is shown in table 251. This descriptor reports the current operating points of the specified port.

**Table 251 — Fibre Channel port status data format of LP 11h**

Byte	Bit							
	7 msb	6	5	4	3	2	1	0 lsb
0	CURRTOP	CURRENT SPEED			LC	CONFLICT	SIGNAL	PIC
1	CURRENT N_PORT_ID							
3								
4	ECSV	Reserved						
5	Reserved				EXTENDED CURRENT SPEED			
6	Reserved							
7	Rsvd	CURRENT FC-AL LOOP ID						
8	CURRENT PORT NAME							
15								
16	CURRENT NODE NAME							
23								

**Byte Description**

0

<b>Bit</b>	<b>Description</b>
7	CURRTOP (current topology): This field is undefined when the PIC field is set to zero
	<b>Value Description</b>
	0b Port is currently operating in arbitrated loop mode.
	1b Port is currently operating in point to point mode.
6-4	CURRENT SPEED: This field is undefined when the PIC field is set to zero
	<b>Value Description</b>
	000b 1 Gb/sec.
	001b 2 Gb/sec.
	010b 4 Gb/sec.
	011b 8 Gb/sec.
3	LC (login complete):
	<b>Value Description</b>
	0b No host is currently logged in to the drive through this port .
	1b At least one host is currently logged in to the drive through this port (i.e., has successfully completed PRLI and still has an active session).
2	CONFLICT:
	<b>Value Description</b>
	0b No AL_PA conflict exists on this port.
	1b The required Hard AL_PA is in use by another device or no AL_PA is available for this port.
1	SIGNAL:
	<b>Value Description</b>
	0b Signal (i.e., light) is not detected on this port.
	1b Signal (i.e., light) is detected on this port.
0	PIC (port initialization complete):
	<b>Value Description</b>
	0b The FC_Port state machine is not in the ACTIVE state (if port is operating in point-to-point topology), or has not successfully completed the most recent LIP.
	1b The FC_Port state machine is in the ACTIVE state (if port is operating in point-to-point topology), or the most recent LIP has completed successfully.
1-3	CURRENT N_PORT_ID: The 24-bit N_Port_ID that is currently assigned to this port. This field is undefined when the PIC field is set to zero.

4

<b>Bit</b>	<b>Description</b>
7	ECSV (extended current speed valid): 0b
6-0	Reserved

5

<b>Bit</b>	<b>Description</b>
7-4	Reserved
3-0	EXTENDED CURRENT SPEED: 0h

6 Reserved

7

<b>Bit</b>	<b>Description</b>
7	Reserved
6-0	CURRENT FC-AL LOOP ID: The loop identifier assigned to this port. This field is ignored ignored when the PIC bit is set to zero or when the CURRTOP bit is set to one.

8-15 CURRENT PORT NAME: The port's name identifier (i.e., WWPN).

16-23 CURRENT NODE NAME: The device's node name identifier (i.e., WWNN).

## 6.4.10.1.6 Serial Attached SCSI port status data

The format of the primary port status data for a SAS port is shown in table 252.

**Table 252 — Serial Attached SCSI port status data format of LP 11h**

Byte	Bit							
	7 msb	6	5	4	3	2	1	0 lsb
0	NEGOTIATED PHYSICAL LINK RATE				Reserved		SIGNAL	PIC
1	(MSB) _____							
3	HASHED SAS ADDRESS							(LSB)
4	(MSB) _____							
11	SAS ADDRESS							(LSB)

**Byte Description**

0

Bit	Description
7-4	NEGOTIATED PHYSICAL LINK RATE: The negotiated physical link rate of the port.

**Table 253 — NEGOTIATED PHYSICAL LINK RATE values**

SP state machine ResetStatus state machine variable	Code	Description
UNKNOWN	0h	Phy is enabled; unknown physical link rate.
DISABLED	1h	Phy is disabled.
PHY_RESET_PROBLEM	2h	Phy is enabled; a phy reset problem occurred.
SPINUP_HOLD	3h	Not Supported
PORT_SELECTOR	4h	Not Supported
RESET_IN_PROGRESS	5h	Not Supported
UNSUPPORTED_PHY_ATTACHED	6h	Phy is enabled; a phy is attached without any commonly supported settings.
Reserved	7h	Reserved
G1	8h	Phy is enabled; 1.5 Gbps physical link rate.
G2	9h	Phy is enabled; 3 Gbps physical link rate.
G3	Ah	Phy is enabled; 6 Gbps physical link rate.
G4	Bh	Phy is enabled; 12 Gbps physical link rate.
Reserved	Ch to Fh	Phy is enabled; reserved for future logical or physical link rates.

3-2 Reserved

1 SIGNAL:

Value	Description
0b	Signal is not detected by the port.
1b	Signal is detected by the port.

0 PIC (port initialization complete):

Value	Description
0b	The port has not successfully completed the link reset sequence.
1b	The port has successfully completed the link reset sequence and is ready to accept connection requests.

- 1-3 HASHED SAS ADDRESS: The 24 bit hashed address that is assigned to the port. The Hashed SAS Address is based on the WWPN.
- 4-11 SAS ADDRESS: The SAS address of the port (i.e., WWPN).

#### 6.4.10.1.7 Potential conflict list entries present log parameter

The potential conflict list entries present log parameter format is shown in table 254.

**Table 254 — Potential conflict list entries present log parameter of LP 11h**

Bit Byte	7	6	5	4	3	2	1	0
0	(MSB) _____							
1	PARAMETER CODE (0200h)						_____ (LSB)	
2	Parameter list control byte - binary format list log parameter							
	DU	Obsolete	TSD	ETC	TMC		FORMAT AND LINKING	
3	PARAMETER LENGTH (01h)							
4	NUMBER OF POTENTIAL CONFLICT LIST ENTRIES							

#### Byte Description

0 to 1 PARAMETER CODE: 0200h

2 Parameter list control byte - binary format list log parameter

#### Bit Description

7 DU: 0b

6 Obsolete

5 TSD: 0b

4 ETC: 0b

3-2 TMC: 00b

1 LBIN: 1b

0 LP: 1b

3 PARAMETER LENGTH: 01h

4 NUMBER OF POTENTIAL CONFLICT LIST ENTRIES: The number of entries in the potential conflict list. This is updated as specified in 4.23.

### 6.4.10.1.8 Potential conflict list log parameter(s)

The potential conflict list log parameters shall contain potential conflict list entries as specified in 4.23. The potential conflict list log parameter format is shown in table 257.

**Table 255 — Potential conflict list log parameter of LP 11h**

Bit Byte	7	6	5	4	3	2	1	0
0	(MSB) _____							
1	PARAMETER CODE							(LSB)
2	Parameter list control byte - binary format list log parameter							
	DU	Obsolete	TSD	ETC	TMC		FORMAT AND LINKING	
3	PARAMETER LENGTH (n-3)							
4	COMMAND OPERATION CODE							
5	(MSB) _____							
6	COMMAND SERVICE ACTION							(LSB)
7	(MSB) _____							
8	OWNER ITN COUNT							(LSB)
9	OWNER ITN TIME							
20								
21	(MSB) _____							
22	RELATIVE TARGET PORT IDENTIFIER							(LSB)
23	TRANSPORTID							
n								

#### Byte Description

- 0 to 1 PARAMETER CODE: The potential conflict list entry number plus 0200h. The potential conflict list parameter code values are contiguous (i.e., the first entry in the list shall be 0201h, the second entry in the list shall be 0202h, etc.).
- 2 Parameter list control byte - binary format list log parameter
- | Bit | Description |
|-----|-------------|
| 7   | DU: 0b      |
| 6   | Obsolete    |
| 5   | TSD: 0b     |
| 4   | ETC: 0b     |
| 3-2 | TMC: 00b    |
| 1   | LBIN: 1b    |
| 0   | LP: 1b      |
- 3 PARAMETER LENGTH:
- 4 COMMAND OPERATION CODE: Set as specified in 4.23 and indicates the operation code of the command that caused this entry to be updated.
- 5 to 6 COMMAND SERVICE ACTION: Set as specified in 4.23 and indicates the service action, if any, of the command that caused this entry to be updated. If no service action exists, this field is set to zero.
- 7 to 8 OWNER ITN COUNT: Set as specified in 4.23 and indicates the number of times a command that may change the state of the medium (see 4.23) is received through an I\_T nexus which was different from the I\_T nexus through which the previous command that may change the state of the medium was received. This field saturates at FFFFh and stops incrementing.



9 to 20 OWNER ITN TIME: Set as specified in 4.23 and indicates the most recent time this I\_T nexus became the owner\_ITN. The format of this field is the format of the REPORT TIMESTAMP parameter data (see 5.2.30.1). The timestamp is updated to reflect the Timestamp origin value at the time this log parameter is read.

21 to 22 RELATIVE TARGET PORT IDENTIFIER: The relative target port identifier of the I\_T nexus through which the command that caused this entry to be updated arrived.

23 to n TRANSPORTID: Set as specified in 4.23 and specifies the initiator port of the I\_T nexus through which the command that caused this entry to be updated arrived. The value in this field is a TransportID.

**6.4.10.1.9 DT device primary port physical interface information**

The DT device primary port physical interface information log parameter(s) format is shown in table 256.

==== WARNING ===== WARNING =====  
 The information from the SFP is read during power on. If SFPs are hot swapped there is no guarantee that the data is current.  
 ===== WARNING ===== WARNING =====

**Table 256 — DT device primary port status log parameter(s) format**

Byte	Bit							
	7 msb	6	5	4	3	2	1	0 lsb
0	(MSB) _____ PARAMETER CODE _____ (LSB)							
1								
2	Parameter list control byte - binary format list log parameter							
	DU	Obsolete	TSD	Obsolete		FORMAT AND LINKING		
3	PARAMETER LENGTH (84h)							
4	PHYSICAL INFORMATION FORMAT							
5								
6	Reserved							
7								
8								
135	DT device primary port physical interface information data							

**Byte Description**

0-1 PARAMETER CODE:  
 0300h plus the value of the Relative Target Port field associated with that port. The Relative Target Port is the same as the relative target port value defined in the VPD pages of inquiry

Value	Description
0301h	Primary port 1; traditionally known as port 0.
0302h	Primary port 2; traditionally known as port 1.

2 Parameter list control byte - binary format list log parameter

Bit	Description
7	DU: 0b
6	Obsolete
5	TSD: 0b
4 to 2	Obsolete
1 to 0	FORMAT AND LINKING: 11b

- 3 PARAMETER LENGTH: (84h)
- 4 PHYSICAL INFORMATION FORMAT: The format of the DT device primary port physical interface information data
- | Code | Description   |
|------|---|
| 00h  | No information is available. The DT device primary port physical interface information data is not valid.   |
| 01h  | The DT device primary port physical interface information data is set to bytes 0 through 127 of the SFF-8472 physical interface memory map address A0h. |
- 5 to 7 Reserved
- 8 to 135 DT device primary port physical interface information data (see the PHYSICAL INFORMATION FORMAT field).

#### 6.4.10.1.10 Medium VolSer

This parameter indicates the Volume Label Serial Number (VolSer) recorded in the CM of the currently loaded cartridge. (This is not to be confused with the manufacturer's cartridge serial number also maintained in the CM.)

The drive reports the VolSer transmitted by the library and recorded in the CM via the Write Buffer command. If there is no library initiated VolSer, the drive reports the VolSer transmitted by the host application via the Write Attribute command and recorded into an LTO standard field in CM. If neither field has been recorded, the drive returns all ASCII blanks. The first seven characters of the VolSer are reported in the SCSI Request Sense data.

**Table 257 — Medium Volume Label Serial Number log parameter of LP 11h**

Bit Byte	7	6	5	4	3	2	1	0
0	(MSB) _____							
1	PARAMETER CODE _____ (LSB)							
2	Parameter list control byte - binary format list log parameter							
	DU	Obsolete	TSD	ETC	TMC	FORMAT AND LINKING		
3	PARAMETER LENGTH (08h)							
4	(MSB) _____							
11	VOLUME SERIAL NUMBER _____ (LSB)							

#### Byte Description

- 0 to 1 PARAMETER CODE: 8000h
- 2 Parameter list control byte - binary format list log parameter
- | Bit | Description |
|-----|-------------|
| 7   | DU: 0b      |
| 6   | Obsolete    |
| 5   | TSD: 0b     |
| 4   | ETC: 0b     |
| 3-2 | TMC: 00b    |
| 1   | LBIN: 1b    |
| 0   | LP: 1b      |
- 3 PARAMETER LENGTH: 08h
- 4 VOLUME SERIAL NUMBER: Volume serial number in ASCII.

6.4.10.1.11 Medium Status Data

This parameter provides information related to the currently loaded medium.

**Table 258 — Medium Volume Label Serial Number log parameter of LP 11h**

Bit Byte	7	6	5	4	3	2	1	0	
0	(MSB)	PARAMETER CODE							
1								(LSB)	
2	Parameter list control byte - binary format list log parameter								
	DU	Obsolete	TSD	ETC	TMC		FORMAT AND LINKING		
3	PARAMETER LENGTH (n-3)								
4	Reserved			TAPE CARTRIDGE TYPE					
5	Reserved	MEC	Reserved			VAE	MES		
6	Reserved								
n	Reserved								

**Byte Description**

- 0 to 1 PARAMETER CODE: 8001h
- 2 Parameter list control byte - binary format list log parameter

**Bit Description**

- 7 DU: 0b
- 6 Obsolete
- 5 TSD: 0b
- 4 ETC: 0b
- 3-2 TMC: 00b
- 1 LBIN: 1b
- 0 LP: 1b

- 3 PARAMETER LENGTH:

4

**Bit Description**

- 7-5 Reserved

4-0 TAPE CARTRIDGE TYPE:

Value	Description
01h	Ultrium 1 cartridge
02h	Cleaner cartridge
03h	Maintenance Panel created FMR tape
04h	Library created FMR tape
06h	Invalid cleaner cartridge type
07h	Invalid or unknown cartridge type
08h	Ultrium 2 cartridge
0Ah	Ultrium 3 cartridge
0Ch	Ultrium 4 cartridge
0Dh	Ultrium 5 cartridge
0Fh	Ultrium 6 cartridge
11h	Ultrium 7 cartridge
12h	Ultrium 8 cartridge
14h	Ultrium 9 cartridge

5

Bit	Description
7	Reserved
6	MEC (medium is encryption capable):
	<b>Value</b> <b>Description</b>
	0b            The currently mounted volume may not be used for encryption purposes
	1b            The currently mounted volume may be used for encryption purposes
5-3	Reserved
2	VAE (valid after eject):
	<b>Value</b> <b>Description</b>
	0b            The data in this log parameter is cleared when the cartridge is removed from the drive
	1b            The data in this log parameter is not cleared when the cartridge is removed from the drive
1-0	MES (medium encryption status): Encryption status of the currently mounted volume
	<b>Value</b> <b>Description</b>
	00b          Unable to determine if all data on all partitions is encrypted or if all data on all partitions is unencrypted
	01b          Some data on at least one partition is unencrypted
	10b          All data on all partitions is encrypted
	11b          Reserved

#### 6.4.10.1.12 Drive Status Data

This parameter provides information related to the drive.

**Table 259 — Medium Volume Label Serial Number log parameter of LP 11h**

Bit	7	6	5	4	3	2	1	0
Byte	(MSB)	PARAMETER CODE						(LSB)
0								
1								
2	Parameter list control byte - binary format list log parameter							
	DU	Obsolete	TSD	ETC	TMC	FORMAT AND LINKING		
3	PARAMETER LENGTH (n-3)							
4	Reserved						POST	
5	Reserved						EE	EC
6	Reserved							
n								

#### Byte Description

0 to 1	PARAMETER CODE: 8100h
2	Parameter list control byte - binary format list log parameter
	<b>Bit</b> <b>Description</b>
	7      DU: 0b
	6      Obsolete
	5      TSD: 0b
	4      ETC: 0b
	3-2    TMC: 00b
	1      LBIN: 1b
	0      LP: 1b
3	PARAMETER LENGTH:

4

Bit	Description
7-1	Reserved
0	POST: Indicates if the drive has completed its initialization or self test diagnostics.
	<b>Value</b> <b>Description</b>
	0b              The drive has completed its initialization or self test diagnostics
	1b              The drive has not completed its initialization or self test diagnostics

5

Bit	Description
7-2	Reserved
1	EE (encryption enabled): Indicates if the drive is enabled to perform encryption operations.
	<b>Value</b> <b>Description</b>
	0b              The drive is not enabled to perform encryption operations
	1b              The drive is enabled to perform encryption operations
0	EC (encryption capable): Indicates if the drive contains hardware capable of performing encryption operations, but does not indicate if it is enabled to perform encryption.
	<b>Value</b> <b>Description</b>
	0b              The drive does not contain hardware capable of performing encryption operations
	1b              The drive contains hardware capable of performing encryption operations

6-n      Reserved

**6.4.10.1.13 Primary Port Features**

The Primary Port Features parameter is used to report features of the primary port.

**Table 260 — Primary Port Features log parameter of LP 11h**

Bit	7	6	5	4	3	2	1	0
Byte	(MSB)	PARAMETER CODE						(LSB)
0								
1								
2	Parameter list control byte - binary format list log parameter							
	DU	Obsolete	TSD	ETC	TMC	FORMAT AND LINKING		
3	PARAMETER LENGTH (n-3)							
4	Reserved							
n								

**Byte      Description**

0 to 1      PARAMETER CODE: 910xh; where x is the relative target port value of the primary port (e.g., 9101h, 9102h)

2          Parameter list control byte - binary format list log parameter

Bit	Description
7	DU: 0b
6	Obsolete
5	TSD: 0b
4	ETC: 0b
3-2	TMC: 00b
1	LBIN: 1b
0	LP: 1b

3          PARAMETER LENGTH:

4-n      Reserved

### 6.4.10.1.14 Encryption Control Descriptor

The Encryption Control Descriptor is used to convey encryption control information during certain phases of the encryption process. Details of such events are outside the scope of this document.

**Table 261 — Encryption Control Descriptor log parameter of LP 11h**

Bit Byte	7	6	5	4	3	2	1	0	
0	(MSB)	PARAMETER CODE							
1								(LSB)	
2	Parameter list control byte - binary format list log parameter								
	DU	Obsolete	TSD	ETC	TMC		FORMAT AND LINKING		
3	PARAMETER LENGTH (n-3)								
4	ENCRYPTION SEQUENCE IDENTIFIER								
7									
8	Encryption Control Descriptor Parameter Data								
n									

#### Byte Description

0 to 1 PARAMETER CODE: E000h

2 Parameter list control byte - binary format list log parameter

#### Bit Description

7 DU: 0b

6 Obsolete

5 TSD: 0b

4 ETC: 0b

3-2 TMC: 00b

1 LBIN: 1b

0 LP: 1b

3 PARAMETER LENGTH:

4-7 ENCRYPTION SEQUENCE IDENTIFIER : This parameter identifies the remaining encryption parameter data contained within this DTD Device Status Log Page back to the drive under certain asynchronously driven encryption events. The Encryption Sequence Identifier shall be returned back to the drive without modification in certain Encryption commands (documented outside the scope of this document).

8-n Encryption Control Descriptor Parameter Data: Described in *IBM Automation Drive Interface Specification with Encryption Support*

### 6.4.11 LP 12h: TapeAlert Response

See LOG SELECT - 4Ch (see 5.2.8 on page 94) and LOG SENSE - 4Dh (see 5.2.9 on page 94) for directions on how to use this page. This page contains non-volatile information relating to volume usage.

The TapeAlert Response log page returns a bit mask of the state of the TapeAlert flags.

### 6.4.11.1 Parameter Definitions (12h)

===== WARNING ===== WARNING =====

Log pages may have different reset behaviors. Care should be taken to ensure counters are processed appropriately, including consideration of their reset behaviors. While reset behaviors may be different between products, an attempt is made to maintain compatibility between generations of a given product. See “Log Parameters (LP)” on page 255.

===== WARNING ===== WARNING =====

===== WARNING ===== WARNING =====

The parameters in log pages should be dynamically parsed as some parameters may not be present and new parameters may be inserted. The relative location of parameters have changed and are anticipated to continue to change.

===== WARNING ===== WARNING =====

Table 262 describes the TapeAlert Response log page. The parameter fields represent the various TapeAlert state flags. See LP 2Eh: TapeAlerts (see 6.4.18 on page 316) for the conditions that sets or clears a state flag.

**Table 262 — TapeAlert Response log page**

Byte	Bit								
	7 msb	6	5	4	3	2	1	0 lsb	
0	DS	SPF (0)	PAGE CODE (12h)						
1	SUBPAGE CODE (00h)								
2	(MSB)	PAGE LENGTH (000Ch)						(LSB)	
3									
4	(MSB)	PARAMETER CODE (0000h)						(LSB)	
5									
6	Parameter list control byte - binary format list log parameter								
	DU	Obsolete	TSD	Obsolete			FORMAT AND LINKING		
7	PARAMETER LENGTH (08h)								
8	FLAG01h	FLAG02h	FLAG03h	FLAG04h	FLAG05h	FLAG06h	FLAG07h	FLAG08h	
9	FLAG09h	FLAG0Ah	FLAG0Bh	FLAG0Ch	FLAG0Dh	FLAG0Eh	FLAG0Fh	FLAG10h	
10	FLAG11h	FLAG12h	FLAG13h	FLAG14h	FLAG15h	FLAG16h	FLAG17h	FLAG18h	
11	FLAG19h	FLAG1Ah	FLAG1Bh	FLAG1Ch	FLAG1Dh	FLAG1Eh	FLAG1Fh	FLAG20h	
12	FLAG21h	FLAG22h	FLAG23h	FLAG24h	FLAG25h	FLAG26h	FLAG27h	FLAG28h	
13	FLAG29h	FLAG2Ah	FLAG2Bh	FLAG2Ch	FLAG2Dh	FLAG2Eh	FLAG2Fh	FLAG30h	
14	FLAG31h	FLAG32h	FLAG33h	FLAG34h	FLAG35h	FLAG36h	FLAG37h	FLAG38h	
15	FLAG39h	FLAG3Ah	FLAG3Bh	FLAG3Ch	FLAG3Dh	FLAG3Eh	FLAG3Fh	FLAG40h	

A FLAGXX bit set to one indicates the TapeAlert state flag is set. A FLAGXX bit set to zero indicates the TapeAlert state flag is not set.

### 6.4.12 LP 14h: Device Statistics

See LOG SELECT - 4Ch (see 5.2.8 on page 94) and LOG SENSE - 4Dh (see 5.2.9 on page 94) for directions on how to use this page. This page contains non-volatile information relating to volume usage.

The Device Statistics log page defines parameters associated with utilization of the tape device.

### 6.4.12.1 Parameter Reset Behavior (14h)

---

**WARNING**

---

Log pages may have different reset behaviors. Care should be taken to ensure counters are processed appropriately, including consideration of their reset behaviors. While reset behaviors may be different between products, an attempt is made to maintain compatibility between generations of a given product. See “Log Parameters (LP)” on page 255.

---

**WARNING**

---



---

**WARNING**

---

The reset behavior varies by parameter and is specified in the Persist and Clear columns of (see table 263).

### 6.4.12.2 Parameter Definitions (14h)

---

**WARNING**

---

The parameters in log pages should be dynamically parsed as some parameters may not be present and new parameters may be inserted. The relative location of parameters have changed and are anticipated to continue to change.

---

**WARNING**

---



---

**WARNING**

---

Table 263 specifies the Device Statistics log page parameter codes.

**Table 263 — LP 14h: Device Statistics log parameter codes (part 1 of 4)**

Parameter Code	Description	Type	Persist	Clear	Size
0000h	<b>Lifetime volume loads {14h:0000h}</b> : Total number of successful load operations.	C	P	N	4
0001h	<b>Lifetime cleaning operations {14h:0001h}</b> : Total number of successful and failed cleaning operations.	C	P	N	4
0002h	<b>Lifetime power on hours {14h:0002h}</b> : Total number of hours the device has been powered on. The value reported shall be rounded up to the next full hour.	C	P	N	4
0003h	<b>Lifetime medium motion (i.e., head) hours {14h:0003h}</b> : Total number of hours that the device has spent processing commands that require medium motion. The value reported shall be rounded up to the next full hour.	C	P	N	4
0004h	<b>Lifetime meters of tape processed {14h:0004h}</b> : Total number of meters of tape that have been processed by the drive mechanism in either direction.	C	P	N	4
<b>Type Description</b> C Device statistics data counter log parameter (see 6.4.12.3.1) M Device statistics medium type log parameter (see 6.4.12.3.2) S Device statistics string data log parameter (see 6.4.12.3.3) <b>Persist Description</b> P Parameter shall be Persistent across I_T nexus loss, logical unit reset, and power-on V The persistence of this parameter varies and is inherited from the value being reported D The parameter is a duty cycle parameter and is cleared when parameter 0010h (i.e., Duty cycle sample time {14h:0010h};) is cleared <b>Clear Description</b> N Parameter shall not be cleared by use of a LOG SELECT command Y Parameter may be cleared by use of a LOG SELECT command					
<sup>a</sup> n = Number of Medium Types supported					



Table 263 — LP 14h: Device Statistics log parameter codes (part 2 of 4)

Parameter Code	Description	Type	Persist	Clear	Size
0005h	<b>Lifetime medium motion (head) hours when incompatible medium was last loaded {14h:0005h}</b> : The value that would have been reported in a lifetime medium motion (head) hours parameter at the time when an incompatible volume was last loaded.	C	P	N	4
0006h	<b>Lifetime power on hours when the last temperature condition occurred (i.e., TapeAlert code 24h) {14h:0006h}</b> : The value that would have been reported in a lifetime power on hours parameter at the time when the TapeAlert code 24h flag was last set.	C	P	N	4
0007h	<b>Lifetime power on hours when the last power consumption condition occurred (i.e., TapeAlert code 1Ch) {14h:0007h}</b> : The value that would have been reported in a lifetime power on hours parameter at the time when the TapeAlert code 1Ch flag was last set.	C	P	N	4
0008h	<b>Medium motion (i.e., head) hours since last successful cleaning operation {14h:0008h}</b> : Count of hours that medium has been in motion in either direction since the last successful cleaning operation. The value reported shall be rounded up to the next full hour.	C	P	N	4
0009h	<b>Medium motion (i.e., head) hours since second to last successful cleaning operation {14h:0009h}</b> : Count of hours that medium has been in motion in either direction since the second to last successful cleaning operation. The value reported shall be rounded up to the next full hour.	C	P	N	4
000Ah	<b>Medium motion (i.e., head) hours since third to last successful cleaning operation {14h:000Ah}</b> : Count of hours that medium has been in motion in either direction since the third to last successful cleaning operation. The value reported shall be rounded up to the next full hour.	C	P	N	4
000Bh	<b>Lifetime power on hours when the last operator initiated forced reset and/or emergency eject occurred {14h:000Bh}</b> : The value that would have been reported in a lifetime power on hours parameter at the time of the last forced reset and/or emergency eject.	C	P	N	4
000Ch	<b>Lifetime power cycles {14h:000Ch}</b> : Total number of times the drive has detected a power-on event.	C	P	N	4
<b>Type</b>	<b>Description</b>				
C	Device statistics data counter log parameter (see 6.4.12.3.1)				
M	Device statistics medium type log parameter (see 6.4.12.3.2)				
S	Device statistics string data log parameter (see 6.4.12.3.3)				
<b>Persist</b>	<b>Description</b>				
P	Parameter shall be Persistent across I_T nexus loss, logical unit reset, and power-on				
V	The persistence of this parameter varies and is inherited from the value being reported				
D	The parameter is a duty cycle parameter and is cleared when parameter 0010h (i.e., Duty cycle sample time {14h:0010h}:) is cleared				
<b>Clear</b>	<b>Description</b>				
N	Parameter shall not be cleared by use of a LOG SELECT command				
Y	Parameter may be cleared by use of a LOG SELECT command				
<sup>a</sup>	n = Number of Medium Types supported				

Table 263 — LP 14h: Device Statistics log parameter codes (part 3 of 4)

Parameter Code	Description	Type	Persist	Clear	Size
000Dh	<b>Volume loads since last parameter reset {14h:000Dh}</b> : Count of successful volume loads since the last time this parameter was reset to zero by use of a LOG SELECT command. This parameter should be retained across a power cycle.	C	P	Y	4
000Eh	<b>Hard write errors {14h:000Eh}</b> : Number of times that a write type command has terminated with a CHECK CONDITION status having the sense key set to MEDIUM ERROR or HARDWARE ERROR since the last time this parameter was reset to zero by the use of a LOG SELECT command.	C	P	Y	4
000Fh	<b>Hard read errors {14h:000Fh}</b> : Number of times that a read type command has terminated with a CHECK CONDITION status having the sense key set to MEDIUM ERROR or HARDWARE ERROR since the last time this parameter was reset to zero by the use of a LOG SELECT command.	C	P	Y	4
0010h	<b>Duty cycle sample time {14h:0010h}</b> : The time in milliseconds since the last time this parameter was reset to zero by: a) the use of a LOG SELECT command; b) a hard reset condition; or c) a vendor specific method	C	V	Y	6
0011h	<b>Read duty cycle {14h:0011h}</b> : Percentage (i.e., an integer between 0 and 100 representing a percentage) of duty cycle sample time (i.e., the value reported in parameter code 0010h) that the device was ready and was processing read type commands. This parameter shall be set to zero when the duty cycle sample time parameter is set to zero.	C	D	Y	1
0012h	<b>Write duty cycle {14h:0012h}</b> : Percentage of duty cycle sample time that the device was ready and was processing write type commands. This parameter shall be set to zero when the duty cycle sample time parameter is set to zero.	C	D	Y	1
0013h	<b>Activity duty cycle {14h:0013h}</b> : Percentage of duty cycle sample time that the device was ready and was processing write type commands, ready type commands, and other commands that cause the medium to be moved. This parameter shall be set to zero when the duty cycle sample time parameter is set to zero.	C	D	Y	1
0014h	<b>Volume not present duty cycle {14h:0014h}</b> : Percentage of the duty cycle sample time that the device server did not detect a volume present (e.g., the physical device attribute medium present was not set to true).	C	D	Y	1
<p><b>Type Description</b></p> <p>C Device statistics data counter log parameter (see 6.4.12.3.1)</p> <p>M Device statistics medium type log parameter (see 6.4.12.3.2)</p> <p>S Device statistics string data log parameter (see 6.4.12.3.3)</p> <p><b>Persist Description</b></p> <p>P Parameter shall be Persistent across I_T nexus loss, logical unit reset, and power-on</p> <p>V The persistence of this parameter varies and is inherited from the value being reported</p> <p>D The parameter is a duty cycle parameter and is cleared when parameter 0010h (i.e., Duty cycle sample time {14h:0010h};) is cleared</p> <p><b>Clear Description</b></p> <p>N Parameter shall not be cleared by use of a LOG SELECT command</p> <p>Y Parameter may be cleared by use of a LOG SELECT command</p>					
<p><sup>a</sup> n = Number of Medium Types supported</p>					

Table 263 — LP 14h: Device Statistics log parameter codes (part 4 of 4)

Parameter Code	Description	Type	Persist	Clear	Size
0015h	<b>Ready duty cycle {14h:0015h}</b> : Percentage of duty cycle sample time that the device was in the ready state.	C	D	Y	1
0016h-003Fh	Reserved				
0040h	<b>Drive manufacturer's serial number {14h:0040h}</b> : Value that is reported in the MANUFACTURER-ASSIGNED SERIAL NUMBER field of the Manufacturer-assigned serial number VPD page (B1h)	S	P	N	12
0041h	<b>Drive serial number {14h:0041h}</b> : Value that is reported in the PRODUCT SERIAL NUMBER field of the Unit Serial Number VPD page (80h).	S	P	N	12
0042h-007Fh	Reserved				
0080h	<b>Medium removal prevented {14h:0080h}</b> : A value of 01h indicates that medium removal has been prevented by: a) a prevention of medium removal condition in the device server, b) a configuration setting, or c) a vendor specific means. A value of 00h indicates that medium removal has not been prevented by one of the listed means. An error condition preventing removal of the medium does not cause this parameter to be set to a non-zero value.	C	V	N	1
0081h	<b>Maximum recommended mechanism temperature exceeded {14h:0081h}</b> : Indicates whether the device has detected at any point in the past that the maximum recommended mechanism temperature has been exceeded. a) a value of 00h indicates the temperature has not been exceeded; b) a value of 01h indicates the temperature has been exceeded; and c) a value of FFh indicates that it is unknown if the temperature has been exceeded.	C	P	N	1
0082h-0FFFh	Reserved				
1000h	<b>Medium motion (i.e., head) hours for each medium type {14h:1000h}</b> :	M	P	N	8*n <sup>a</sup>
1001h-EFFFh	Reserved				
F000h-FFFFh	Vendor-specific				
<b>Type</b>	<b>Description</b>				
C	Device statistics data counter log parameter (see 6.4.12.3.1)				
M	Device statistics medium type log parameter (see 6.4.12.3.2)				
S	Device statistics string data log parameter (see 6.4.12.3.3)				
<b>Persist</b>	<b>Description</b>				
P	Parameter shall be Persistent across I_T nexus loss, logical unit reset, and power-on				
V	The persistence of this parameter varies and is inherited from the value being reported				
D	The parameter is a duty cycle parameter and is cleared when parameter 0010h (i.e., Duty cycle sample time {14h:0010h}): is cleared				
<b>Clear</b>	<b>Description</b>				
N	Parameter shall not be cleared by use of a LOG SELECT command				
Y	Parameter may be cleared by use of a LOG SELECT command				
<sup>a</sup> n = Number of Medium Types supported					

### 6.4.12.3 Log parameter formats

#### 6.4.12.3.1 Device statistics data counter log parameter format

The device statistics data counter log parameter is used for reporting parameters specified as device statistics data counter log parameters in (see table 263). The device statistics data counter log parameter format is specified in table 264.

**Table 264 — Device statistics data counter log parameter format of LP 14h**

Byte	Bit							
	7 msb	6	5	4	3	2	1	0 lsb
0	(MSB) _____							
1	PARAMETER CODE _____ (LSB)							
2	DU	Obsolete	TSD (0b)	ETC(0b)	TMC(00b)		FORMAT AND LINKING (11b)	
3	PARAMETER LENGTH (n-3)							
4	(MSB) _____							
n	DEVICE STATISTICS DATA COUNTER _____ (LSB)							

#### Byte Description

0-1 PARAMETER CODE: defined in (see table 263).

2 Parameter control byte

#### Bit Description

7 DU (Disable Update):

6 Obsolete:

5 TSD (Target Save Disable): 0b

4 ETC (Enable Threshold Comparison): 0b

3-2 TMC (Threshold Met Comparison): 00b

1-0 FORMAT AND LINKING: 11b

3 PARAMETER LENGTH: the number of bytes in the device statistics data counter field that follows.

4-n DEVICE STATISTICS DATA COUNTER: the value of the data counter associated with the parameter code.

### 6.4.12.3.2 Device statistics medium type log parameter format

The device statistics medium type log parameter is used for reporting parameters specified as device statistics medium type log parameters in (see table 263). The device statistics medium type log parameter format is specified in table 265.

**Table 265 — Device statistics medium type log parameter format of LP 14h**

Byte	Bit							
	7 msb	6	5	4	3	2	1	0 lsb
0	(MSB) _____ PARAMETER CODE (1000h) _____ (LSB)							
1								
2	DU (0b)	Obsolete	TSD (0b)	ETC (0b)	TMC (00b)		FORMAT AND LINKING (11b)	
3	PARAMETER LENGTH (n-3)							
Device statistics medium type descriptor(s)								
4	Device statistics medium type descriptor [first] (see table 266)							
	:							
n	Device statistics medium type descriptor [last] (see table 266)							

#### Byte Description

0-1 PARAMETER CODE: 1000h.

2 Parameter control byte

#### Bit Description

7 DU (Disable Update): 0b

6 Obsolete:

5 TSD (Target Save Disable): 0b

4 ETC (Enable Threshold Comparison): 0b

3-2 TMC (Threshold Met Comparison): 00b

1-0 FORMAT AND LINKING: 11b

3 PARAMETER LENGTH: the number of bytes in the medium type descriptors that follow.

4-n Device statistics medium type descriptor(s) : the value of the data counter associated with the parameter code. The device statistics medium type descriptor is defined in 6.4.12.3.2.1.

#### 6.4.12.3.2.1 Device statistics medium type descriptor

The device statistics medium type descriptor format is specified in table 266.

**Table 266 — Device statistics medium type descriptor format**

Byte	Bit							
	7 msb	6	5	4	3	2	1	0 lsb
0	Reserved							
1	Reserved							
2	DENSITY CODE							
3	MEDIUM TYPE							
4	(MSB) _____ MEDIUM MOTION HOURS _____ (LSB)							
7								

#### Byte Description

0-1 Reserved

- 2 DENSITY CODE: the value returned in the general mode parameter block descriptor.
- 3 MEDIUM TYPE: the value returned in the mode parameter header.
- 4-7 MEDIUM MOTION HOURS: the number of medium motion (i.e., head) hours for the type of medium specified by the combination of the MEDIUM TYPE field and DENSITY CODE field.

#### 6.4.12.3.2.1.1 Supported descriptors

Table 267, table 268, table 269, table 270, and table 271 show the descriptors supported for each product.

**Table 267 — LTO-5 Device statistics medium descriptor support**

DENSITY CODE	MEDIUM TYPE
44h	38h
44h	3Ch
46h	48h
46h	4Ch
58h	58h
58h	5Ch

**Table 268 — LTO-6 Device statistics medium descriptor support**

DENSITY CODE	MEDIUM TYPE
46h	48h
46h	4Ch
58h	58h
58h	5Ch
5Ah	68h
5Ah	6Ch

**Table 269 — LTO-7 Device statistics medium descriptor support**

DENSITY CODE	MEDIUM TYPE
58h	58h
58h	5Ch
5Ah	68h
5Ah	6Ch
5Ch	78h
5Ch	7Ch

**Table 270 — LTO-8 Device statistics medium descriptor support**

DENSITY CODE	MEDIUM TYPE
5Ch	78h
5Ch	7Ch
5Dh	78h
5Eh	88h
5Eh	8Ch

**Table 271 — LTO-9 Device statistics medium descriptor support**

DENSITY CODE	MEDIUM TYPE
5Eh	88h
5Eh	8Ch
60h	98h
60h	9Ch

**6.4.12.3.3 Device statistics string data log parameter format**

The device statistics string data log parameter is used for reporting parameters specified as device statistics string data log parameters in (see table 263). The device statistics string data log parameter format is specified in table 272. The device statistics string data log parameter shall be a multiple of 4 bytes.

**Table 272 — Device statistics string data log parameter format of LP 14h**

Byte	Bit							
	7 msb	6	5	4	3	2	1	0 lsb
0	(MSB) _____							
1	PARAMETER CODE							(LSB)
2	DU (0b)	Obsolete	TSD (0b)	ETC(0b)	TMC(00b)	FORMAT AND LINKING (01b)		
3	PARAMETER LENGTH (n-3)							
4	(MSB) _____							
n	STRING DATA							(LSB)

**Byte Description**

0-1 PARAMETER CODE: defined in (see table 263).

2 Parameter control byte

**Bit Description**

7 DU (Disable Update): 0b

6 Obsolete:

5 TSD (Target Save Disable): 0b

4 ETC (Enable Threshold Comparison): 0b

3-2 TMC (Threshold Met Comparison): 00b

1-0 FORMAT AND LINKING: 01b

3 PARAMETER LENGTH: the number of bytes in the data that follows.

4-n STRING DATA: an ASCII string describing the device statistics parameter specified by the PARAMETER CODE value. The string data field is an ASCII data field.

### 6.4.13 LP 16h: Tape diagnostic data

See LOG SELECT - 4Ch (see 5.2.8 on page 94) and LOG SENSE - 4Dh (see 5.2.9 on page 94) for directions on how to use this page. This page is used to track significant errors or conditions.

The Tape Diagnostic Data log page (see table 273) provides for a number of error-event records using the list parameter format. Each error-event record contains diagnostic information for a single error type encountered by the device including data counters associated with the error event, sense data, operation code/service action and medium type with associated media motion hours, etc. The Tape Diagnostic Data log page may be used to aid in field analysis and repair.

The Tape Diagnostic Data log page only includes parameter entries for commands that terminated with a CHECK CONDITION status having the sense key set to MEDIUM ERROR, HARDWARE ERROR or ABORTED COMMAND.

The parameter code value associated with an error-event indicates the relative time at which a command terminated with a CHECK CONDITION status. A lower parameter code indicates that the command terminated with a CHECK CONDITION status at a more recent time. The parameter code values returned shall be numbered consecutively from 0000h (i.e., the most recent) up to n, where n is the number of current parameter entries.

**Table 273 — LP 16h: Tape diagnostic data log page format**

Byte	Bit							
	7 msb	6	5	4	3	2	1	0 lsb
0	DS	SPF(0)	PAGE CODE (16h)					
1	SUBPAGE CODE (00h)							
2	(MSB)	PAGE LENGTH (n-3)						
3								(LSB)
Tape Diagnostic Data log parameter(s)								
4	Tape Diagnostic Data log parameter (first)							
	.							
	.							
	.							
n	Tape Diagnostic Data log parameter (last)							

#### 6.4.13.1 Parameter Definitions (16h)

In each parameter (see table 274) if the REPEAT bit is set to zero, then the parameter represents only one event. If the REPEAT bit is set to one, then the parameter represents more than one consecutive events that had identical values for the MEDIUM ID NUMBER field, SENSE KEY field, ADDITIONAL SENSE CODE field and ADDITIONAL SENSE CODE QUALIFIER field in the parameter. If the REPEAT bit is set to one in the parameter, then other fields in the parameter shall be set to the values when the first of the consecutive events that had the identical values for the MEDIUM ID NUMBER field, SENSE KEY field, ADDITIONAL SENSE CODE field and ADDITIONAL SENSE CODE QUALIFIER field occurred.

The Tape Diagnostic Data log parameter format is specified in (see table 274)

===== WARNING ===== WARNING =====

Log pages may have different reset behaviors. Care should be taken to ensure counters are processed appropriately, including consideration of their reset behaviors. While reset behaviors may be different between products, an attempt is made to maintain compatibility between generations of a given product. See “Log Parameters (LP)” on page 255.

===== WARNING ===== WARNING =====



**WARNING****WARNING**

The parameters in log pages should be dynamically parsed as some parameters may not be present and new parameters may be inserted. The relative location of parameters have changed and are anticipated to continue to change.

**WARNING****WARNING****Table 274 — Tape diagnostic data log parameter format of LP 16h**

Byte	Bit							
	7 msb	6	5	4	3	2	1	0 lsb
0	(MSB) _____							
1	Parameter Code _____ (LSB)							
2	du(0)	Obsolete	tsd(0)	etc(0)	tmc (00b)		format and linking (11b)	
3	Parameter Length (n-3)							
4	Reserved							
5	Reserved							
6	Density Code							
7	Medium Type							
8	(MSB) _____							
11	Lifetime Media Motion Hours _____ (LSB)							
12	Reserved							
13	Repeat	Reserved			Sense Key			
14	Additional Sense Code							
15	Additional Sense Code Qualifier							
16	(MSB) _____							
19	Vendor-Specific Code Qualifier _____ (LSB)							
20	(MSB) _____							
23	Product Revision Level _____ (LSB)							
24	(MSB) _____							
27	Hours Since Last Clean _____ (LSB)							
28	Operation Code							
29	Reserved			Service Action				
30	Reserved							
31	Reserved							
32	(MSB) _____							
63	Medium Id Number _____ (LSB)							
64	Reserved				Timestamp Origin			
65	Reserved							
66	(MSB) _____							
71	Timestamp _____ (LSB)							

**Byte Description**

- 0-1 PARAMETER CODE: An indication of the relative time at which the command terminated with this CHECK CONDITION status. A lower parameter code indicates that the command terminated with a CHECK CONDITION status at a more recent time. The parameter code values returned are numbered consecutively from 0000h (i.e., the most recent) up to n, where n is the number of current parameter entries.
- 2 Parameter control byte
- | Bit | Description                           |
|-----|---------------------------------------|
| 7   | DU (Disable Update): 0b               |
| 6   | Obsolete:                             |
| 5   | TSD (Target Save Disable): 0b         |
| 4   | ETC (Enable Threshold Comparison): 0b |
| 3-2 | TMC (Threshold Met Comparison): 00b   |
| 1-0 | FORMAT AND LINKING: 01b               |
- 3 PARAMETER LENGTH: the number of bytes in the data that follows.
- 4-5 Reserved
- 6 DENSITY CODE: The density code of the medium loaded at the time the command terminated with the CHECK CONDITION status. The DENSITY CODE field is the same value as returned in the general mode parameter block descriptor. If no medium was loaded at the time the command terminated with the CHECK CONDITION status, then the DENSITY CODE field is 00h.
- 7 MEDIUM TYPE: The type of medium loaded at the time the command terminated with the CHECK CONDITION status. The MEDIUM TYPE field is the same value as returned in the mode parameter header. If no medium was loaded at the time the command terminated with the CHECK CONDITION status, then the MEDIUM TYPE is 00h.
- 8-11 LIFETIME MEDIA MOTION HOURS: The number of media motion (head) hours at the time the command terminated with the CHECK CONDITION status. The LIFETIME MEDIA MOTION HOURS field is equivalent to the value contained in LP 14h: Device Statistics (see 6.4.12 on page 289) with a parameter code value of 0003h at the time the command terminated with the CHECK CONDITION status.
- 12 Reserved
- 13
- | Bit | Description  |
|-----|--|
| 7   | REPEAT: Indicates if this parameter refers to more than one error event  |
|     | <b>Value Description</b>   |
|     | 0b This parameter represents a single event.   |
|     | 1b This parameter represents more than one consecutive events that had identical values for the MEDIUM ID NUMBER field, SENSE KEY field, ADDITIONAL SENSE CODE field, and ADDITIONAL SENSE CODE QUALIFIER field. |
| 6-4 | Reserved   |
| 3-0 | SENSE KEY: The sense key value returned for the command that terminated with the CHECK CONDITION status.   |
- 14-15 ADDITIONAL SENSE CODE/ADDITIONAL SENSE CODE QUALIFIER: The additional sense code value returned for the command that terminated with the CHECK CONDITION status.
- 16-19 VENDOR-SPECIFIC CODE QUALIFIER: The Last Error FSC and Last Error Flag Data (i.e. bytes 65-68 of Sense Data) generated for the command that terminated with the CHECK CONDITION status.
- 20-23 PRODUCT REVISION LEVEL: The product revision level (i.e., bytes 16-31 of Standard Inquiry) at the time the command terminated with the CHECK CONDITION status.
- 24-27 HOURS SINCE LAST CLEAN: The time in media motion (i.e., head) hours since the last successful cleaning at the time the command terminated with the CHECK CONDITION status. The HOURS SINCE LAST CLEAN field is equivalent to the value contained in the Device Statistics log page with a parameter code of 0008h at the time the command terminated with the CHECK CONDITION status.
- 28 OPERATION CODE: The operation code of the command that terminated with the CHECK CONDITION status.

29

Bit	Description
7-5	Reserved
4-0	SERVICE ACTION: if applicable, the service action of the command that terminated with the CHECK CONDITION status.

30-31 Reserved

32-63 MEDIUM ID NUMBER: If medium was present at the time the command terminated with the CHECK CONDITION status, then this field contains (in prioritized order):

- 1) the BARCODE field value contained in the medium auxiliary memory;
- 2) the MEDIUM SERIAL NUMBER field value contained in the medium auxiliary memory; or
- 3) the VOLUME IDENTIFIER field value contained in the medium auxiliary memory.

If no medium was present at the time the command terminated with the CHECK CONDITION status, the this field is filled with 20h (i.e., ASCII space).

64

Bit	Description
7-3	Reserved
2-0	TIMESTAMP ORIGIN: The timestamp origin maintained by the tape drive at the time the command terminated with the CHECK CONDITION status.

65 Reserved

66-71 TIMESTAMP: The timestamp maintained by the tape drive at the time the command terminated with the CHECK CONDITION status.

#### 6.4.14 LP 17h: Volume Statistics

See LOG SELECT - 4Ch (see 5.2.8 on page 94) and LOG SENSE - 4Dh (see 5.2.9 on page 94) for directions on how to use this page. This page contains non-volatile information relating to volume usage.

The Volume Statistics log page is included in Ultrium 5 and later drives. It is not included in earlier generation drives.

The Volume Statistics log page defines data parameters associated with utilization of the tape volume and the medium within the volume. Volume statistics for the most recent mounted volume are reported in the volume Statistics log page parameters. Volume statistics for previously mounted volumes may be reported in Volume Statistics log subpages (see table 275).

If a supported log subpage is requested for a mount which has not occurred, then all bytes in the parameter data fields are set to 00h.

The device server resets all volume statistics log parameter data fields to 00h after a hard reset.

NOTE 40 - An application client may detect if parameter values in the page are valid by testing for parameter value 0000h, (i.e., page valid) set to zero.

See table 275 for the definition of the SUBPAGE CODE field.

**Table 275 — Volume Statistics log subpage codes of LP 17h**

Code	Description
00h	Reserved
01h-0Fh	Volume statistics for previously mounted volumes 1 through 15. Use subpage FFh (i.e., Supported subpages log page) to determine which log subpages are supported. This will also indicate how many previous mounts are supported by the drive.
10h-FEh	Reserved
FFh	Supported subpages log page (see SPC-4)

## 6.4.14.1 Parameter Definitions

===== WARNING ===== WARNING =====

Log pages may have different reset behaviors. Care should be taken to ensure counters are processed appropriately, including consideration of their reset behaviors. While reset behaviors may be different between products, an attempt is made to maintain compatibility between generations of a given product. See “Log Parameters (LP)” on page 255.

===== WARNING ===== WARNING =====

===== WARNING ===== WARNING =====

The parameters in log pages should be dynamically parsed as some parameters may not be present and new parameters may be inserted. The relative location of parameters have changed and are anticipated to continue to change.

===== WARNING ===== WARNING =====

Table 276 — LP 17h: Volume statistics log parameters

Parameter Code	Description	Type	Size
0000h	<b>Page valid {17h:000h}</b> : A value of 01h indicates that the values reported in the parameters to follow are valid. A value of 00h indicates the values reported in the parameters that follow are invalid	C	1
0001h	<b>Volume Mounts {17h:0001h}</b> : Number of mounts for the current volume (i.e., Thread Count)	C	4
0002h	<b>Volume Datasets Written {17h:0002h}</b> : The total number of data sets written to the medium in the volume over the lifetime of the volume. (i.e., Total Datasets Written)	C	8
0003h	<b>Volume Recovered Write Data Errors {17h:0003h}</b> : The total number of recovered write data correction errors (e.g., write temps) for the lifetime of the volume. (i.e., Total Write Retries)	C	4
0004h	<b>Volume Unrecovered Write Data Errors (i.e., Write Perms) {17h:0004h}</b> : The total number of times that a write type command was terminated with CHECK CONDITION status and a sense key of MEDIUM ERROR or HARDWARE ERROR over the lifetime of the volume. (i.e., Total Unrecovered Write Errors)	C	2
0005h	<b>Volume Write Servo Errors (updated on both temp and perm) {17h:0005h}</b> : The total number of times that the device suspended a write due to detection of a servo condition which could result in an incorrectly written track and attempted to write the data at a different location. If a logical block is interrupted more than once this parameter shall only be incremented once. (i.e., Total Number of Suspended Writes)	C	2
0006h	<b>Volume Unrecovered Write Servo Errors {17h:0006h}</b> : The total number of times that the device suspended a write due to detection of a servo condition which could result in an incorrectly written track and was unable to write the data at a different location. (i.e., Total Number of Fatal Suspended Writes)	C	2
0007h	<b>Volume Datasets Read {17h:0007h}</b> : The total number of data sets read from the medium in the volume over the lifetime of the volume. (i.e., Total Data Sets Read)	C	8
0008h	<b>Volume Recovered Read Errors {17h:0008h}</b> : The total number of recovered read errors (e.g., read temps) for the lifetime of the volume. (i.e., Total Read Retries)	C	4
Type Key: C - Volume statistics counter log parameter (see 6.4.17.2) S - Volume statistics string data log parameter (see 6.4.14.2.2) P - Volume statistics partition record log parameter (see 6.4.14.2.3). Footnote: <sup>a</sup> The size field is the size of the PARTITION RECORD DATA COUNTER field of each Volume statistics partition record descriptor. The overall size depends on the number of partitions as well as other fields that are part of the partition record log parameter as defined in (see 6.4.14.2.3)			

Table 276 — LP 17h: Volume statistics log parameters

Parameter Code	Description	Type	Size
0009h	<b>Volume Unrecovered Read Errors (i.e., Read Perms) {17h:0009h}</b> : The total number of times that a read type command was terminated with CHECK CONDITION status and a sense key of MEDIUM ERROR or HARDWARE ERROR over the lifetime of the volume. (i.e., Total Unrecovered Read Errors)	C	2
000Ah-000Bh	Not Supported		
000Ch	<b>Last mount unrecovered write errors {17h:000Ch}</b> : Count of the number times a write type command was terminated with status of CHECK CONDITION and a sense key of HARDWARE ERROR, or MEDIA ERROR during the last mount	C	2
000Dh	<b>Last mount unrecovered read errors {17h:000Dh}</b> : Count of the number times a read type command was terminated with status of CHECK CONDITION and a sense key of HARDWARE ERROR, or MEDIA ERROR during the last mount	C	2
000Eh	<b>Last mount megabytes written {17h:000Eh}</b> : Count of the number of megabytes (i.e., $10^6$ bytes) of logical objects that were written to the medium after compression during the last mount. The value reported shall be rounded up to the next megabyte. The value reported contains bytes written as part of the process of writing a filemark	C	4
000Fh	<b>Last mount megabytes read {17h:000Fh}</b> : Count of the number of megabytes (i.e., $10^6$ bytes) of logical objects that were read from the medium before decompression during the last mount. The value reported shall be rounded up to the next megabyte. The value reported contains bytes read as part of a filemark	C	4
0010h	<b>Lifetime megabytes written {17h:0010h}</b> : Count of the number of megabytes (i.e., $10^6$ bytes) of logical objects that have been written to the medium after compression during the lifetime of the volume. The value reported shall be rounded up to the next megabyte. The value reported contains bytes written as part of the process of writing a filemark.	C	8
0011h	<b>Lifetime megabytes read {17h:0011h}</b> : Count of the number of megabytes (i.e., $10^6$ bytes) that have been read from the medium before decompression during the lifetime of the volume. The value reported shall be rounded up to the next megabyte. The value reported contains bytes read as part of a filemark.	C	8
0012h	<b>Last load write compression ratio {17h:0012h}</b> : (number of bytes transferred out of the logical object buffer to an application client ÷ the number of bytes in logical objects read from the medium) x 100	C	2
0013h	<b>Last load read compression ratio {17h:0013h}</b> : (number of bytes transferred from an application client into the logical object buffer ÷ the number of bytes in logical objects written to the medium) x 100	C	2
0014h	<b>Medium mount time {17h:0014h}</b> : Time in milliseconds from the time when the device server would first report GOOD status to a TEST UNIT READY command upon successful completion of a load operation until the device server did not detect a volume present.	C	6
0015h	<b>Medium ready time {17h:0015h}</b> : Time in milliseconds from the time the device server was able to process medium access commands until the device server started the processing of an unload operation.	C	6
Type Key: C - Volume statistics counter log parameter (see 6.4.17.2) S - Volume statistics string data log parameter (see 6.4.14.2.2) P - Volume statistics partition record log parameter (see 6.4.14.2.3). Footnote: <sup>a</sup> The size field is the size of the PARTITION RECORD DATA COUNTER field of each Volume statistics partition record descriptor. The overall size depends on the number of partitions as well as other fields that are part of the partition record log parameter as defined in (see 6.4.14.2.3)			

Table 276 — LP 17h: Volume statistics log parameters

Parameter Code	Description	Type	Size
0016h	<b>Total native capacity {17h:0016h}</b> : The sum of the total native capacity of all partitions in megabytes (i.e., 10 <sup>6</sup> bytes) from BOP to EOP. A data counter value with all bytes set to FFh in the partition record data counter field (see 6.4.14.2.3) indicates that the total native capacity is unknown.	C	4
0017h	<b>Total used native capacity {17h:0017h}</b> : The sum of the used native capacity of all partitions in megabytes (i.e., 10 <sup>6</sup> bytes) from BOP to EOD. A data counter value with all bytes set to FFh in the partition record data counter field (see 6.4.14.2.3) indicates that the total used native capacity is unknown	C	4
0018h-003Fh	Reserved		
0040h	<b>Volume serial number {17h:0040h}</b> : The volume serial number parameter contains the volume serial number from the cartridge.	S	32
0041h	<b>Tape lot identifier {17h:0041h}</b> : The tape lot identifier field contains the tape pancake identifier.	S	8
0042h	<b>Volume barcode {17h:0042h}</b> : The value from MAM attribute 0806h (i.e., BARCODE, see SPC-4)	S	32
0043h	<b>Volume manufacturer {17h:0043h}</b> : The volume manufacturer parameter identifies the manufacturer of the cartridge.	S	8
0044h	<b>Volume license code {17h:0044h}</b> : ASCII code to represent the license under which this volume was manufactured.	S	4
0045h	<b>Volume personality {17h:0045h}</b> : The volume personality parameter contains an ASCII string to identify the combination of physical volume type and density formatted on the medium. The intent is to provide a designator sufficient for successful volume interchange. LTO-5 to LTO-7: The value is in the format "Ultrium-" <b>+</b> "<generation number>" (e.g., "Ultrium-5") LTO-8+: The value is in the format "LTO" <b>+</b> <VOLUME LABEL CARTRIDGE TYPE (see bytes 43-44 of sense data - 5.2.31)> <b>+</b> "G" <b>+</b> <generation number> (e.g., "LTOL8G8", "LTOLYG8", "LTOM8G8", etc.)	S	9
0046h-007Fh	Reserved		
0080h	<b>Write protect {17h:0080h}</b> : A value of 01h indicates that a write protection state that is persistent with this volume is set; A value of 00h indicates that no write protection state that is persistent with this volume is set; and A value of FFh indicates that it is unknown if there is a persistent write protection condition set.	C	1
0081h	<b>WORM {17h:0081h}</b> : A value of 01h indicates that the volume is a WORM volume; A value of 00h indicates that the volume is not a WORM volume; and A value of FFh indicates that it is unknown if the volume is a WORM volume.	C	1
Type Key: C - Volume statistics counter log parameter (see 6.4.17.2) S - Volume statistics string data log parameter (see 6.4.14.2.2) P - Volume statistics partition record log parameter (see 6.4.14.2.3). Footnote: <sup>a</sup> The size field is the size of the PARTITION RECORD DATA COUNTER field of each Volume statistics partition record descriptor. The overall size depends on the number of partitions as well as other fields that are part of the partition record log parameter as defined in (see 6.4.14.2.3)			

Table 276 — LP 17h: Volume statistics log parameters

Parameter Code	Description	Type	Size
0082h	<b>Maximum recommended tape path temperature exceeded {17h:0082h}:</b> A value of 01h indicates a drive has detected at some point in the past that the maximum recommended tape path temperature has been exceeded; A value of 00h indicates no drive has detected at any point in the past that the maximum recommended tape path temperature has been exceeded; and A value of FFh indicates that it is not known if at any point in the past that the maximum recommended tape path temperature has been exceeded (e.g., Ultrium 4 volume).	C	1
0083h-00FFh	Reserved		
0100h	Not Supported		
0101h	<b>Beginning of medium passes {17h:0101h}:</b> Count of the total number of times the beginning of medium position has passed over the head.	C	4
0102h	<b>Middle of tape passes {17h:0102h}:</b> count of the total number of times that the physical middle of the user data region on the tape has passed over the head (e.g., $(EOM - BOM) \div 2$ ).	C	4
0103h-01FFh	Reserved		
0200h	<b>First encrypted logical object identifier(s) {17h:0200h}:</b> The logical object identifier(s) for the first logical object on the medium which has been encrypted for each partition on the medium. Each byte in the partition record data counter field(s) shall be set to FFh if there are no encrypted logical objects or if the partition does not exist. The least significant byte in the partition record data counter field (see 6.4.14.2.3) shall be set to FEh and all other bytes shall be set to FFh if it is not known if there are encrypted logical objects on the medium.	P	6 <sup>a</sup>
0201h	<b>First unencrypted logical object on the EOP side of the first encrypted logical object identifier(s) {17h:0201h}:</b> The logical object identifiers for the first logical object on the medium which is not encrypted and is on the EOP side of the first encrypted logical object for each partition on the medium. Each byte in the partition record data counter field (see 6.4.14.2.3) shall be set to FFh if there are no unencrypted logical objects on the EOP side of the first encrypted logical object identifier or if the partition does not exist. The least significant byte in the partition record data counter field shall be set to FEh and all other bytes shall be set to FFh if: it is not known if there are unencrypted logical objects on the EOP side of the first encrypted logical object; all bytes in the first encrypted logical object identifier are set to FFh; or the least significant byte in the first encrypted logical object identifier is set to FEh and all other bytes are set to FFh.	P	6 <sup>a</sup>
<p>Type Key:  <b>C</b> - Volume statistics counter log parameter (see 6.4.17.2)  <b>S</b> - Volume statistics string data log parameter (see 6.4.14.2.2)  <b>P</b> - Volume statistics partition record log parameter (see 6.4.14.2.3).  Footnote:  <sup>a</sup> The size field is the size of the PARTITION RECORD DATA COUNTER field of each Volume statistics partition record descriptor. The overall size depends on the number of partitions as well as other fields that are part of the partition record log parameter as defined in (see 6.4.14.2.3)</p>			

Table 276 — LP 17h: Volume statistics log parameters

Parameter Code	Description	Type	Size
0202h	<b>Approximate native capacity of partition(s) {17h:0202h}</b> : The native capacity of the partition(s) in megabytes (i.e., 10 <sup>6</sup> bytes) from BOP to EOP. A data counter value with all bytes set to FFh in the partition record data counter field (see 6.4.14.2.3) indicates that the native capacity of the partition is unknown.	P	4 <sup>a</sup>
0203h	<b>Approximate used native capacity of partition(s) {17h:0203h}</b> : The used native capacity of the partition in megabytes (i.e., 10 <sup>6</sup> bytes) from BOP to EOD. A data counter value with all bytes set to FFh in the partition record data counter field (see 6.4.14.2.3) indicates that the used native capacity of the partition is unknown.	P	4 <sup>a</sup>
0204h	<b>Approximate remaining native capacity to early warning of partition(s) {17h:0204h}</b> : The approximate remaining native capacity of the partition(s) in megabytes (i.e., 10 <sup>6</sup> bytes) that is less than or equal to the native capacity from EOD to EW. The value reported in this parameter shall be zero once EOD is at or beyond EW. A data counter value with all bytes set to FFh in the PARTITION RECORD DATA COUNTER field (see 6.4.14.2.3) indicates that the remaining native capacity of the partition is unknown.	P	4 <sup>a</sup>
0205h-EFFFh	Reserved		
F000h-FFFFh	Vendor specific		
Type Key: C - Volume statistics counter log parameter (see 6.4.17.2) S - Volume statistics string data log parameter (see 6.4.14.2.2) P - Volume statistics partition record log parameter (see 6.4.14.2.3). Footnote: <sup>a</sup> The size field is the size of the PARTITION RECORD DATA COUNTER field of each Volume statistics partition record descriptor. The overall size depends on the number of partitions as well as other fields that are part of the partition record log parameter as defined in (see 6.4.14.2.3)			

## 6.4.14.2 Parameter formats

### 6.4.14.2.1 Data counter log parameter format

The volume statistics data counter log parameter is used for reporting parameters specified as volume statistics data counter log parameters in Table 284, LP 1Bh: Data compression log parameters. The volume statistics data counter log parameter format is specified in Table 285, Data compression counter log parameter format of LP 1Bh.

Table 277 — Volume statistics data counter log parameter format of LP 17h

Byte	Bit							
	7 msb	6	5	4	3	2	1	0 lsb
0	(MSB)							
1	PARAMETER CODE							(LSB)
2	DU	Obsolete	TSD (0b)	ETC(0b)	TMC		FORMAT AND LINKING (11b)	
3	PARAMETER LENGTH (n-3)							
4	(MSB)							
n	VOLUME STATISTICS DATA COUNTER							(LSB)

The PARAMETER CODE field is defined in Table 284, LP 1Bh: Data compression log parameters.

See SPC-4 for descriptions of the DU bit, TSD bit, ETC bit, TMC field and FORMAT AND LINKING field. The TSD bit and FORMAT AND LINKING field shall be set to the values specified in Table 285, Data compression counter log parameter format of LP 1Bh.



The PARAMETER LENGTH field indicates the number of bytes in the VOLUME STATISTICS DATA COUNTER field that follows.

The VOLUME STATISTICS DATA COUNTER field is the value of the data counter associated with the parameter code.

#### 6.4.14.2.2 Volume statistics string data log parameter format

The volume statistics string data log parameter is used for reporting parameters specified as volume statistics string data log parameters in Table 284, LP 1Bh: Data compression log parameters. The volume statistics string data log parameter format is specified in Table 278, Volume statistics string data log parameter format of LP 17h. The volume statistics string data log parameter shall be a multiple of 4 bytes.

**Table 278 — Volume statistics string data log parameter format of LP 17h**

Byte	Bit							
	7 msb	6	5	4	3	2	1	0 lsb
0	(MSB)							
1	PARAMETER CODE							(LSB)
2	DU(0b)	Obsolete	TSD (0b)	ETC(0b)	TMC(00b)		FORMAT AND LINKING (01b)	
3	PARAMETER LENGTH (n-3)							
4	STRING DATA							
n								

The PARAMETER CODE field is defined in Table 284, LP 1Bh: Data compression log parameters.

See SPC-4 for descriptions of the DU bit, TSD bit, ETC bit, TMC field and FORMAT AND LINKING field. These fields shall be set to the values specified in Table 278, Volume statistics string data log parameter format of LP 17h.

The PARAMETER LENGTH field indicates the number of bytes of data that follows.

The STRING DATA field contains an ASCII string describing the volume statistics parameter specified by the PARAMETER CODE value. The STRING DATA field is an ASCII data field (see SPC-4).

#### 6.4.14.2.3 Volume statistics partition record log parameter format

The volume statistics partition record log parameter is used for reporting parameters specified as volume statistics partition record log parameters in Table 284, LP 1Bh: Data compression log parameters. The volume statistics partition record log parameter format is specified in Table 279, Volume statistics partition log parameter format of LP 17h.

**Table 279 — Volume statistics partition log parameter format of LP 17h**

Byte	Bit							
	7 msb	6	5	4	3	2	1	0 lsb
0	(MSB)							
1	PARAMETER CODE							(LSB)
2	DU	Obsolete	TSD (0b)	ETC(0b)	TMC(00b)		FORMAT AND LINKING (11b)	
3	PARAMETER LENGTH (n-3)							
	Volume statistics partition record descriptor(s)							
4	Volume statistics partition record descriptor [first]							
	⋮							
n	Volume statistics partition record descriptor [last]							

The PARAMETER CODE field is defined in Table 284, LP 1Bh: Data compression log parameters.

See SPC-4 for descriptions of the DU bit, TSD bit, ETC bit, TMC field and FORMAT AND LINKING field. The TSD bit and FORMAT AND LINKING field shall be set to the values specified in Table 279, Volume statistics partition log parameter format of LP 17h.

The PARAMETER LENGTH field indicates the number of bytes in the volume statistics partition record log descriptors.

The volume statistics partition record descriptor format is specified in Table 280, Volume statistics partition record descriptor format of LP 17h.

**Table 280 — Volume statistics partition record descriptor format of LP 17h**

Byte	Bit							
	7 msb	6	5	4	3	2	1	0 lsb
0	PARTITION RECORD DESCRIPTOR LENGTH (n-1)							
1	Reserved							
2	(MSB)	PARTITION NUMBER						(LSB)
3								
4	(MSB)	PARTITION RECORD DATA COUNTER						(LSB)
n								

The PARTITION RECORD DESCRIPTOR LENGTH field specifies the number of bytes that follow.

The PARTITION NUMBER field indicates the number of the partition that the following counter is associated with.

The PARTITION RECORD DATA COUNTER field is the value of the data counter associated with the parameter code and associated with the specified partition.

#### 6.4.15 LP 18h: Protocol-specific port

See LOG SELECT - 4Ch (see 5.2.8 on page 94) and LOG SENSE - 4Dh (see 5.2.9 on page 94) for directions on how to use this page. The Protocol-specific log page for SAS is used to report errors that have occurred on the phys of SAS drives.

There is one copy of this page for each port. This page is defined for SAS-attached devices only.

The Protocol-specific log page for SAS is defined in table 281.

**Table 281 — LP 18h Protocol-Specific log page for SAS**

Byte	Bit							
	7 msb	6	5	4	3	2	1	0 lsb
0	DS	SPF	PAGE CODE (18h)					
1	Reserved							
2	(MSB)	PAGE LENGTH (78h)						(LSB)
3								
Protocol-specific log parameter list								
4	Protocol-specific log parameter (first) (see table 282)							
63								
64	Protocol-specific log parameter (last) (see table 282)							
123								

#### 6.4.15.1 Parameter Reset Behavior (18h)

==== WARNING ===== WARNING =====

Log pages may have different reset behaviors. Care should be taken to ensure counters are processed appropriately, including consideration of their reset behaviors. While reset behaviors may be different between products, an attempt is made to maintain compatibility between generations of a given product. See “Log Parameters (LP)” on page 255.

==== WARNING ===== WARNING =====

Specific flags may be cleared when corrective actions have removed the condition that caused the flag to be set.

#### 6.4.15.2 Parameter Definitions (18h)

Table 282 defines the format for the Protocol-Specific log parameter for SAS.

**WARNING****WARNING**

The parameters in log pages should be dynamically parsed as some parameters may not be present and new parameters may be inserted. The relative location of parameters have changed and are anticipated to continue to change.

**WARNING****WARNING****Table 282 — Protocol-Specific Port log parameter for LP 18h for SAS (part 1 of 2)**

Byte	Bit							
	7 msb	6	5	4	3	2	1	0 lsb
0	(MSB) _____							
1	PARAMETER CODE (relative target port identifier)							(LSB)
2	Parameter control byte							
	DU	Obsolete	TSD	ETC	TMC		FORMAT AND LINKING	
3	PARAMETER LENGTH (38h)							
4	Reserved				PROTOCOL IDENTIFIER (6h)			
5	Reserved							
6	GENERATION CODE (00h)							
7	NUMBER OF PHYS (01h)							
SAS phy log descriptor								
8	Reserved							
9	PHY IDENTIFIER							
10	Reserved							
11	SAS PHY LOG DESCRIPTOR LENGTH (m - 3)							
12	Reserved	ATTACHED DEVICE TYPE			ATTACHED REASON			
13	REASON				NEGOTIATED LOGICAL LINK RATE			
14	Reserved				ATTACHED SSP INITIATOR PORT	ATTACHED STP INITIATOR PORT	ATTACHED SMP INITIATOR PORT	Reserved
15	Reserved				ATTACHED SSP TARGET PORT	ATTACHED STP TARGET PORT	ATTACHED SMP TARGET PORT	Reserved
16	SAS ADDRESS							
23	SAS ADDRESS							
24	ATTACHED SAS ADDRESS							
31	ATTACHED SAS ADDRESS							
32	ATTACHED PHY IDENTIFIER							
33	Reserved							
39	Reserved							
40	(MSB) _____							
43	INVALID DWORD COUNT							(LSB)

**Table 282 — Protocol-Specific Port log parameter for LP 18h for SAS (part 2 of 2)**

Byte	Bit								
	7 msb	6	5	4	3	2	1	0 lsb	
44	(MSB)	RUNNING DISPARITY ERROR COUNT							
47								(LSB)	
48	(MSB)	LOSS OF DWORD SYNCHRONIZATION							
51								(LSB)	
52	(MSB)	PHY RESET PROBLEM							
55								(LSB)	
56		Reserved							
57									
58		PHY EVENT DESCRIPTOR LENGTH							
59		NUMBER OF PHY EVENT DESCRIPTORS							

**Byte Description**

0-1 PARAMETER CODE: The relative target port identifier of the SSP target port that the log parameter describes.

2

Bit	Description
7	DU (0b)
6	obsolete
5	TSD (0b)
4	ETC (0b)
3-2	TMC (00b)
1-0	FORMAT AND LINKING (11b)

3 PARAMETER LENGTH: 38h

4

Bit	Description
7-4	Reserved
3-0	PROTOCOL IDENTIFIER: 6h

5 Reserved

6 GENERATION CODE: 00h. Related to the Phy Control and Discover mode page which is not supported.

7 NUMBER OF PHYS: 01h. The number of phys in the SAS target port (not in the entire SAS target device) and indicates the number of SAS phy log descriptors in the SAS phy log descriptor list.

8 Reserved

9 PHY IDENTIFIER: The phy identifier of the phy for which information is being returned.

10 Reserved

11 SAS PHY LOG DESCRIPTOR LENGTH: The number of bytes that follow in the SAS phy log descriptor. A SAS PHY LOG DESCRIPTOR LENGTH field set to 00h indicates that there are 44 additional bytes.

12

Bit	Description												
7	Reserved												
6-4	ATTACHED DEVICE TYPE: The device type attached to this phy												
	<table border="1"> <thead> <tr> <th>Code</th> <th>Description</th> </tr> </thead> <tbody> <tr> <td>000b</td> <td>No device attached</td> </tr> <tr> <td>001b</td> <td>SAS device</td> </tr> <tr> <td>010b</td> <td>Edge Expander device</td> </tr> <tr> <td>011b</td> <td>Fan-out expander device</td> </tr> <tr> <td>All others</td> <td>Reserved</td> </tr> </tbody> </table>	Code	Description	000b	No device attached	001b	SAS device	010b	Edge Expander device	011b	Fan-out expander device	All others	Reserved
Code	Description												
000b	No device attached												
001b	SAS device												
010b	Edge Expander device												
011b	Fan-out expander device												
All others	Reserved												
3-0	ATTACHED REASON: If a SAS phy or expander phy is attached, then the value of the REASON field received in the IDENTIFY address frame during the identification sequence.												

13

Bit	Description																								
7-4	REASON																								
	<table border="1"> <thead> <tr> <th>Code</th> <th>Description</th> </tr> </thead> <tbody> <tr> <td>0h</td> <td>Unknown reason</td> </tr> <tr> <td>1h</td> <td>Power on</td> </tr> <tr> <td>2h</td> <td>Hard reset</td> </tr> <tr> <td>3h</td> <td>SMP PHY CONTROL function LINK RESET</td> </tr> <tr> <td>4h</td> <td>Loss of dword synchronization</td> </tr> <tr> <td>5h</td> <td>Obsolete</td> </tr> <tr> <td>6h</td> <td>Not supported</td> </tr> <tr> <td>7h</td> <td>Break Timeout Timer expired</td> </tr> <tr> <td>8h</td> <td>Phy test function stopped</td> </tr> <tr> <td>9h</td> <td>Expander device reduced functionality</td> </tr> <tr> <td>Ah-Fh</td> <td>Reserved</td> </tr> </tbody> </table>	Code	Description	0h	Unknown reason	1h	Power on	2h	Hard reset	3h	SMP PHY CONTROL function LINK RESET	4h	Loss of dword synchronization	5h	Obsolete	6h	Not supported	7h	Break Timeout Timer expired	8h	Phy test function stopped	9h	Expander device reduced functionality	Ah-Fh	Reserved
Code	Description																								
0h	Unknown reason																								
1h	Power on																								
2h	Hard reset																								
3h	SMP PHY CONTROL function LINK RESET																								
4h	Loss of dword synchronization																								
5h	Obsolete																								
6h	Not supported																								
7h	Break Timeout Timer expired																								
8h	Phy test function stopped																								
9h	Expander device reduced functionality																								
Ah-Fh	Reserved																								
3-0	NEGOTIATED LOGICAL LINK RATE: The logical link rate being used by the phy (see table 253). This is negotiated during the link reset sequence.																								

14

Bit	Description						
7-4	Reserved						
3	ATTACHED SSP INITIATOR PORT:						
	<table border="1"> <thead> <tr> <th>Value</th> <th>Description</th> </tr> </thead> <tbody> <tr> <td>0</td> <td>An SSP initiator port is not attached.</td> </tr> <tr> <td>1</td> <td>An SSP initiator port is attached.</td> </tr> </tbody> </table>	Value	Description	0	An SSP initiator port is not attached.	1	An SSP initiator port is attached.
Value	Description						
0	An SSP initiator port is not attached.						
1	An SSP initiator port is attached.						
2	ATTACHED STP INITIATOR PORT:						
	<table border="1"> <thead> <tr> <th>Value</th> <th>Description</th> </tr> </thead> <tbody> <tr> <td>0</td> <td>An STP initiator port is not attached.</td> </tr> <tr> <td>1</td> <td>An STP initiator port is attached.</td> </tr> </tbody> </table>	Value	Description	0	An STP initiator port is not attached.	1	An STP initiator port is attached.
Value	Description						
0	An STP initiator port is not attached.						
1	An STP initiator port is attached.						
1	ATTACHED SMP INITIATOR PORT:						
	<table border="1"> <thead> <tr> <th>Value</th> <th>Description</th> </tr> </thead> <tbody> <tr> <td>0</td> <td>An SMP initiator port is not attached.</td> </tr> <tr> <td>1</td> <td>An SMP initiator port is attached. This may be set to one for an attached expander device.</td> </tr> </tbody> </table>	Value	Description	0	An SMP initiator port is not attached.	1	An SMP initiator port is attached. This may be set to one for an attached expander device.
Value	Description						
0	An SMP initiator port is not attached.						
1	An SMP initiator port is attached. This may be set to one for an attached expander device.						
0	Reserved						

15

<b>Bit</b>	<b>Description</b>
7-4	Reserved
3	ATTACHED SSP TARGET PORT
	<b>Value      Description</b>
	0            An SSP target port is not attached.
	1            An SSP target port is attached.
2	ATTACHED STP TARGET PORT
	<b>Value      Description</b>
	0            An STP target port is not attached.
	1            An STP target port is attached.
1	ATTACHED SMP TARGET PORT
	<b>Value      Description</b>
	0            An SMP target port is not attached.
	1            An SMP target port is attached. This is set to one for an attached expander device.
0	Reserved
16-23	SAS ADDRESS: The port identifier of this SAS port.
24-31	ATTACHED SAS ADDRESS: The SAS ADDRESS of the attached port.
32	ATTACHED PHY IDENTIFIER: The PHY IDENTIFIER of the attached port.
33-39	Reserved
40-43	INVALID DWORD COUNT: The number of invalid dwords that have been received outside of phy reset sequences.
44-47	RUNNING DISPARITY ERROR COUNT: The number of dwords containing running disparity errors that have been received outside of phy reset sequences.
48-51	LOSS OF DWORD SYNCHRONIZATION COUNT: The number of times the phy has restarted the link reset sequence because it lost dword synchronization.
52-55	PHY RESET PROBLEM COUNT: The number of times a phy reset problem occurred.
56-57	Reserved
58	PHY EVENT DESCRIPTOR LENGTH: 00h. This drive does not return phy event descriptors.
59	NUMBER OF PHY EVENT DESCRIPTORS: 00h. This drive does not return phy event descriptors.

#### 6.4.16 LP 1A: Power Condition Transitions

See LOG SELECT - 4Ch (see 5.2.8 on page 94) and LOG SENSE - 4Dh (see 5.2.9 on page 94) for directions on how to use this page. The Power Condition Transitions log page provides a count of the occurrences of power condition transition events.

##### 6.4.16.1 Parameter Definitions (1Ah)

==== WARNING ===== WARNING =====

Log pages may have different reset behaviors. Care should be taken to ensure counters are processed appropriately, including consideration of their reset behaviors. While reset behaviors may be different between products, an attempt is made to maintain compatibility between generations of a given product. See "Log Parameters (LP)" on page 255.

==== WARNING ===== WARNING =====

==== WARNING ===== WARNING =====

The parameters in log pages should be dynamically parsed as some parameters may not be present and new parameters may be inserted. The relative location of parameters have changed and are anticipated to continue to change.

==== WARNING ===== WARNING =====

The FORMAT AND LINKING field for log parameters in the Power Condition Transitions log page shall be set to 11b, indicating that the parameter is a binary format list parameter.

All Power Condition Transitions log page counters are saturating counters. A count is incremented by one for each transition (see table 283).

**Table 283 — Parameter codes for the Power Condition Transitions log page LP 1Ah**

Parameter code	Description	Size
0001h	<b>Accumulated transitions to active:</b> The number of times the device server has transitioned to the active power condition since the device was manufactured.	4
0004h	<b>Accumulated transitions to idle_c:</b> The number of times the device server has transitioned to the idle_c power condition since the device was manufactured. This includes all transitions (e.g., idle_c_condition_timer expiration)	4

#### 6.4.17 LP 1Bh: Data Compression

See LOG SELECT - 4Ch (see 5.2.8 on page 94) and LOG SENSE - 4Dh (see 5.2.9 on page 94) for directions on how to use this page. This page contains non-volatile information relating to volume usage.

The Data Compression log page is included in Ultrium 5 and later drives. It is not included in earlier generation drives.

The Data Compression log page defines data counters associated with the data compression operation for the most recent volume mount.

##### 6.4.17.1 Parameter Definitions

Parameters 0002h through 0009h are pairs that represent a large number of bytes transferred. The first parameter of the pair represents the number of whole megabytes (i.e.,  $10^6$  bytes) transferred, rounded to the nearest megabyte. The second parameter of the pair represents the difference between this number of megabytes and the actual number of bytes. This is a signed number and may be negative.

Parameters associated with data transferred from an application client indicate values prior to compression processing. Parameters associated with data transferred to the medium indicate values after compression processing. Compression processing may or may not compress logical blocks.

**WARNING**

Log pages may have different reset behaviors. Care should be taken to ensure counters are processed appropriately, including consideration of their reset behaviors. While reset behaviors may be different between products, an attempt is made to maintain compatibility between generations of a given product. See “Log Parameters (LP)” on page 255.

**WARNING**



===== WARNING =====

===== WARNING =====

The parameters in log pages should be dynamically parsed as some parameters may not be present and new parameters may be inserted. The relative location of parameters have changed and are anticipated to continue to change.

===== WARNING =====

===== WARNING =====

**Table 284 — LP 1Bh: Data compression log parameters**

Parameter Code	Description	Size
0000h	<b>Read Compression ratio {1Bh:0000h}</b> : The average data compression ratio multiplied by 100 for all user data read from the medium since the last time this parameter was reset to zero. This parameter may include user data that was read from the medium but not returned to the application client (e.g., data that was read as part of a read ahead operation). The calculation is (number of bytes transferred out of the logical object buffer to an application client ÷ the number of bytes in logical objects read from the medium) x 100	2
0001h	<b>Write Compression Ratio x 100 {1Bh:0001h}</b> : The average data compression ratio multiplied by 100 for all user data written by the device since the last time this parameter was reset to zero. The calculation is (number of bytes transferred from an application client into the logical object buffer ÷ the number of bytes in logical objects written to the medium) x 100	2
0002h	<b>Megabytes transferred to application client {1Bh:0002h}</b> : The count of the number of megabytes (i.e., 10 <sup>6</sup> bytes) of logical blocks that have been transferred to an application client after compression processing at the time this parameter is requested. The value reported shall be rounded to the nearest megabyte.	4
0003h	<b>Bytes transferred to application client {1Bh:0003h}</b> : The difference in bytes between the actual number of bytes of logical blocks transferred to the application client and the value reported in parameter 0002h (i.e., megabytes (10 <sup>6</sup> ) transferred to application client). The value reported in this parameter is a signed number and may be negative.	4
0004h	<b>Megabytes read from medium {1Bh:0004h}</b> : The count of the number of megabytes (i.e., 10 <sup>6</sup> bytes) of logical blocks that have been read from the medium before compression processing at the time this parameter is requested. The value reported shall be rounded to the nearest megabyte.	4
0005h	<b>Bytes read from medium {1Bh:0005h}</b> : The difference in bytes between the actual number of bytes of logical blocks read from the medium before decompression at the time this parameter is requested and the value reported in parameter 0004h (i.e., megabytes (10 <sup>6</sup> ) read from medium). The value reported in this parameter is a signed number and may be negative.	4
0006h	<b>Megabytes transferred from application client {1Bh:0006h}</b> : The count of the number of megabytes (i.e., 10 <sup>6</sup> bytes) of logical blocks that have been transferred from an application client before compression processing at the time this parameter is requested. The value reported shall be rounded to the nearest megabyte.	4
0007h	<b>Bytes transferred from application client {1Bh:0007h}</b> : The difference in bytes between the actual number of bytes of logical blocks transferred from an application client before compression processing at the time this parameter is requested and the value reported in parameter 0006h (i.e., megabytes (10 <sup>6</sup> ) transferred from application client). The value reported in this parameter is a signed number and may be negative.	4
0008h	<b>Megabytes written to medium {1Bh:0008h}</b> : The count of the number of megabytes (i.e., 10 <sup>6</sup> bytes) of logical blocks that have written to the medium after compression processing at the time this parameter is requested. The value reported shall be rounded to the nearest megabyte.	4

Table 284 — LP 1Bh: Data compression log parameters

Parameter Code	Description	Size
0009h	<b>Bytes written to medium {1Bh:0009h}</b> : The difference in bytes between the actual number of bytes of logical blocks written to the medium in logical blocks at the time this parameter is requested and the value reported in parameter 0008h (i.e., megabytes ( $10^6$ ) written to medium). The value reported in this parameter is a signed number and may be negative.	4
000Ah-00FFh	Reserved	
0100h	<b>Data compression enabled {1Bh:0100h}</b> : Indication of whether logical blocks will be compressed before they are written to the medium. The value reported indicates the current state of the device and does not indicate that logical blocks previously written to the medium were compressed. A data counter value set to 01h indicates that logical blocks will be compressed before being written to the medium during write type commands. A zero value indicates that logical blocks will not be compressed before being written to the medium during write type commands.	1
0101h-EFFFh	Reserved	
F000h-FFFFh	Vendor-specific	

#### 6.4.17.2 Parameter format

The data compression counter log parameter format is specified in table 285

Table 285 — Data compression counter log parameter format of LP 1Bh

Byte	Bit							
	7 msb	6	5	4	3	2	1	0 lsb
0	(msb) _____							
1	parameter code							(lsb)
2	du	Obsolete	tsd (0b)	etc(0b)	tmc(00b)	format and linking (11b)		
3	parameter length (n-3)							
4	(msb) _____							
n	data compression counter							(lsb)

The PARAMETER CODE field is defined in table 284.

See SPC-4 for descriptions of the DU bit, TSD bit, ETC bit, TMC field and FORMAT AND LINKING field. The TSD bit and FORMAT AND LINKING field shall be set to the values specified in table 285.

The PARAMETER LENGTH field indicates the number of bytes in the data compression counter field that follows.

The DATA COMPRESSION COUNTER field is the value of the data counter associated with the parameter code.

#### 6.4.18 LP 2Eh: TapeAlerts

See LOG SELECT - 4Ch (see 5.2.8 on page 94) and LOG SENSE - 4Dh (see 5.2.9 on page 94) for directions on how to use this page. This page is used to track significant errors or conditions.

#### Byte Description

0	<b>Bit</b>	<b>Description</b>
	7-6	Reserved
	5-0	Page Code: 2Eh
1		Reserved
2-3		Page length: 0140h

Page Code 2Eh is used to report conditions in the tape drive. The TapeAlert log page is unique in that the parameter value is required to be 0000h or 0001h in the Log Sense command. A result of this requirement is that all parameters are requested, so the page length field is always returned 0140h.

For a description of service actions associated with the supported parameters, refer to the *IBM System Storage TS2350 Tape Drive Setup, Operator, and Service Guide, GC27-2277-00*.

#### 6.4.18.1 Parameter Reset Behavior (2Eh)

===== WARNING =====

Log pages may have different reset behaviors. Care should be taken to ensure counters are processed appropriately, including consideration of their reset behaviors. While reset behaviors may be different between products, an attempt is made to maintain compatibility between generations of a given product. See “Log Parameters (LP)” on page 255.

===== WARNING =====

Specific flags may be cleared when corrective actions have removed the condition that caused the flag to be set (see table 286).

#### 6.4.18.2 Parameter Definitions (2Eh)

There are 64 parameters numbered from 0001h to 0040h. However, for this product only parameters listed in table 286 have meaning. The remaining parameters always return a value of 00h.

All parameters are one byte long. Each parameter is either 00h to indicate the corresponding condition has not occurred or 01h to indicate that the condition has occurred. See 6.4.18.1 Parameter Reset Behavior (2Eh) for parameter clearing behavior.

The following parameters are supported for each TapeAlert. Table 286 lists the supported TapeAlerts and additional fields as specified in SSC may be supported in the future.

Parameter description:

#### Byte Description

0-1	Parameter Code
2	Parameter control byte
	<b>Bit Description</b>
	7 DU (Disable Update): 0b
	6 DS (Disable Save): 1b
	5 TSD (Target Save Disable): 0b
	4 ETC (Enable Threshold Comparison): 0b
	3-2 TMC (Threshold Met Comparison): 00b
	1 Reserved
	0 LO (List Parameter): 0b
3	Parameter length: 01h

## 4 TapeAlert Flag

Value	Description
01h	condition occurred
00h	condition did not occur

Table 286 — LP 2Eh Supported TapeAlerts (part 1 of 2)

Code	Description	Set	Clear <sup>a</sup>	Type
0001h	Read Warning		R	Warning
0002h	Write Warning		R	Warning
0003h	Hard Error		R	Warning
0004h	Media		R	Critical
0005h	Read Failure		R	Critical
0006h	Write Failure		R	Critical
0007h	Media Life		L	Warning
0008h	Not Data Grade		R	Warning
0009h	Write Protect		R	Critical
000Ah	No Removal		R	Informational
000Bh	Cleaning Media		R	Informational
000Ch	Unsupported Format		R	Informational
000Eh	Unrecoverable Snapped Tape		R	Critical
000Fh	Memory Chip in Cartridge Failure		R	Warning
0010h	Forced Eject		L	Critical
0011h	Read Only Format		R	Warning
0012h	Tape Directory Corrupted		R	Warning
0013h	Nearing Media Life		R	Informational
0014h	Clean Now		C	Critical
0015h	Clean Periodic		C	Warning
0016h	Expired Cleaning Media	C	C	Critical
0017h	Invalid cleaning tape	C	R	Critical
0019h	Host Channel Failure			Warning
001Ah	Cooling Fan Failure	S		Warning
001Bh	Power Supply Failure	S		Warning
001Eh	Hardware A			Critical
001Fh	Hardware B			Critical
0020h	Interface			Warning
0021h	Eject Media		U,R	Critical
0022h	Download Fault			Warning
0023h	Humidity	S		Warning
0024h	Drive Temperature	S		Warning
0025h	Drive Voltage	S		Warning
0026h	Predictive Failure			Critical
0027h	Diagnostics Required			Warning
0031h	Diminished Native Capacity	B	L, U	Informational
0032h	Lost Statistics		R	Warning

Table 286 — LP 2Eh Supported TapeAlerts (part 2 of 2)

Code	Description	Set	Clear <sup>a</sup>	Type
0033h	Tape Directory Invalid at Unload		L,R	Warning
0034h	Tape System Area Write Failure		L,R	Critical
0035h	Tape System Area Read Failure		R	Critical
0036h	No Start of Data		R	Critical
0037h	Loading Failure		R	Critical
0038h	Unrecoverable Unload Failure		R	Critical
0039h	Automation Interface Failure			Critical
003Ah	Firmware Failure			Warning
003Bh	WORM Medium - Integrity Check Failed		R	Warning
003Ch	WORM Medium - Overwrite Attempted		R	Warning
003Dh	Encryption Policy Violation	P	L	Warning
Legend - Not set/supported L Load - medium is loaded C Clean - cleaner tape is loaded U Unload - medium is ejected E Error - error code is posted R Removal - medium is FULLY removed S Sensor - sensor check B Write from BOP 0 and condition exists P A primary port is set online, or when there is an attempted write while there is an encryption policy required but there is no encryption policy established <sup>a</sup> A TapeAlert flag may be cleared when the condition no longer exists				

#### 6.4.19 LP 30h: Tape Usage

See LOG SELECT - 4Ch (see 5.2.8 on page 94) and LOG SENSE - 4Dh (see 5.2.9 on page 94) for directions on how to use this page. This page contains non-volatile information relating to volume usage.

===== WARNING ===== WARNING =====

This page has been replaced by the standard log page Volume Statistics log page (17h) (see 6.4.17). This page is included for legacy applications and may become obsolete in future generation drives.

===== WARNING ===== WARNING =====

##### 6.4.19.1 Parameter Definitions (30h)

===== WARNING ===== WARNING =====

Log pages may have different reset behaviors. Care should be taken to ensure counters are processed appropriately, including consideration of their reset behaviors. While reset behaviors may be different between products, an attempt is made to maintain compatibility between generations of a given product. See "Log Parameters (LP)" on page 255.

===== WARNING ===== WARNING =====

===== WARNING =====

The parameters in log pages should be dynamically parsed as some parameters may not be present and new parameters may be inserted. The relative location of parameters have changed and are anticipated to continue to change..

===== WARNING =====

===== WARNING =====

**Table 287 — LP 30h: Tape Usage log parameter codes**

Code	Counter: Description	Size
0001h	<b>Volume Mounts {30h:0001h}</b> : Number of mounts for the current volume:	4
0002h	<b>Volume Datasets Written {30h:0002h}</b> : Total number of datasets written	8
0003h	<b>Volume Write Retries {30h:0003h}</b> : Total number of write temps	4
0004h	<b>Volume Write Perms {30h:0004h}</b> : Total write perms	2
0005h	<b>Volume Suspended Writes {30h:0005h}</b> :	2
0006h	<b>Volume Fatal Suspended Writes {30h:0006h}</b> :	2
0007h	<b>Volume Datasets Read {30h:0007h}</b> : Total number of datasets read	8
0008h	<b>Volume Read Retries {30h:0008h}</b> : Total number of read temps	4
0009h	<b>Volume Read Perms {30h:0009h}</b> : Total read perms	2
000Ah	<b>Volume Suspended Reads {30h:000Ah}</b> : Always set to 0000h	2
000Bh	<b>Volume Fatal Suspended Reads {30h:000Bh}</b> : Always set to 0000h	2

#### 6.4.20 LP 31h: Tape capacity

See LOG SELECT - 4Ch (see 5.2.8 on page 94) and LOG SENSE - 4Dh (see 5.2.9 on page 94) for directions on how to use this page.

===== WARNING =====

This vendor specific log page is obsolete and is being deprecated in favor of LP 17h: Volume Statistics (see 6.4.14 on page 301) which is defined in SSC-4. It is still returned with correct values but its not being enhanced to show additional partitions that are supported from LTO6 forward. This log page may be removed in the future. It is highly recommended that use of this log page be removed and replaced with using the Volume Statistics log page.

===== WARNING =====

===== WARNING =====

##### 6.4.20.1 Parameter Reset Behavior (31h)

===== WARNING =====

Log pages may have different reset behaviors. Care should be taken to ensure counters are processed appropriately, including consideration of their reset behaviors. While reset behaviors may be different between products, an attempt is made to maintain compatibility between generations of a given product. See "Log Parameters (LP)" on page 255.

===== WARNING =====

===== WARNING =====

This page is reflects the currently loaded volume. Values change after a successful format of the volume.

##### 6.4.20.2 Parameter Definitions(31h)

The Tape capacity log parameters are listed in table 288.

===== WARNING =====

The parameters in log pages should be dynamically parsed as some parameters may not be present and new parameters may be inserted. The relative location of parameters have changed and are anticipated to continue to change.

===== WARNING =====

===== WARNING =====

**Table 288 — LP 31h: Tape capacity log parameters**

Parameter Code (in Hex)	Counter: Description	Size
0001h	<b>Partition 0 Remaining Capacity {31h:0001h}</b> : A representation of the location on medium of EOD expressed in Mebibytes ( $2^{20}$ ) Native Capacity between EOD and EOP 0. This is intended to be used as a gauge to display the ratio of partition 0 used. There is no guarantee that the amount of data expressed in this parameter is available for writing.	4
0002h	<b>Partition 1 Remaining Capacity {31h:0002h}</b> : A representation of the location on medium of EOD expressed in Mebibytes ( $2^{20}$ ) Native Capacity between EOD and EOP 1. This is intended to be used as a gauge to display the ratio of partition 1 used. There is no guarantee that the amount of data expressed in this parameter is available for writing.	4
0003h	<b>Partition 0 Maximum Capacity {31h:0003h}</b> : Value representing the Native Capacity of partition 0 in Mebibytes ( $2^{20}$ ) Note that the value changes depending on how the volume is partitioned. See Volume partitioning (see 4.4 on page 29) for size limitations.	4
0004h	<b>Partition 1 Maximum Capacity {31h:0004h}</b> : Value representing the Native Capacity of partition 1 in Mebibytes ( $2^{20}$ ) Note that the value changes depending on how the volume is partitioned. The maximum size of partition 1 is determined by the minimum size of partition 0 and the size of formatting overhead (i.e., guard band). See Volume partitioning (see 4.4 on page 29) for size limitations.	4

#### 6.4.21 LP 32h: Data compression

See LOG SELECT - 4Ch (see 5.2.8 on page 94) and LOG SENSE - 4Dh (see 5.2.9 on page 94) for directions on how to use this page. This page contains counters related to compression.

===== WARNING =====

This page has been replaced by the standard log page, LP 1Bh: Data Compression (see 6.4.17 on page 314). This page is included for legacy applications and may become obsolete in future generation drives.

===== WARNING =====

===== WARNING =====

##### 6.4.21.1 Parameter Definitions (32h)

Parameters 0002h through 0009h occur as pairs that represent a large number of bytes transferred. The first parameter represents the number of whole megabytes ( $10^6$ ) transferred, rounded to the nearest megabyte. The second parameter represents the signed difference between this number of megabytes and the actual number of bytes using signed values.

===== WARNING =====

Log pages may have different reset behaviors. Care should be taken to ensure counters are processed appropriately, including consideration of their reset behaviors. While reset behaviors may be different between products, an attempt is made to maintain compatibility between generations of a given product. See "Log Parameters (LP)" on page 255.

===== WARNING =====

===== WARNING =====

**WARNING****WARNING**

The parameters in log pages should be dynamically parsed as some parameters may not be present and new parameters may be inserted. The relative location of parameters have changed and are anticipated to continue to change.

**WARNING****WARNING****Table 289 — LP 32h: Data Compression Log Parameters**

Parameter Code	Counter: Description	Size
0000h	<b>Read Compression ratio x 100 {32h:0000h}:</b>	2
0001h	<b>Write Compression Ratio x 100 {32h:0001h}:</b>	2
0002h	<b>Megabytes transferred to server {32h:0002h}: (10<sup>6</sup>)</b>	4
0003h	<b>Bytes transferred to server {32h:0003h}:</b>	4
0004h	<b>Megabytes read from tape {32h:0004h}: (10<sup>6</sup>)</b>	4
0005h	<b>Bytes read from tape {32h:0005h}:</b>	4
0006h	<b>Megabytes transferred from server {32h:0006h}: (10<sup>6</sup>)</b>	4
0007h	<b>Bytes transferred from server {32h:0007h}:</b>	4
0008h	<b>Megabytes written to tape {32h:0008h}: (10<sup>6</sup>)</b>	4
0009h	<b>Bytes written to tape {32h:0009h}:</b>	4

#### 6.4.22 LP 33h: Write Errors

See LOG SELECT - 4Ch (see 5.2.8 on page 94) and LOG SENSE - 4Dh (see 5.2.9 on page 94) for directions on how to use this page. This page contains detailed counters related to write operations.

##### 6.4.22.1 Parameter Definitions (33h)

When multiple errors occur on a dataset, the counter that is updated is generally based on the first error detected.

**WARNING****WARNING**

Log pages may have different reset behaviors. Care should be taken to ensure counters are processed appropriately, including consideration of their reset behaviors. While reset behaviors may be different between products, an attempt is made to maintain compatibility between generations of a given product. See “Log Parameters (LP)” on page 255.

**WARNING****WARNING**



===== WARNING =====

===== WARNING =====

The parameters in log pages should be dynamically parsed as some parameters may not be present and new parameters may be inserted. The relative location of parameters have changed and are anticipated to continue to change..

===== WARNING =====

===== WARNING =====

**Table 290 — LP 33h: Write Errors log parameter codes (part 1 of 2)**

Code	Counter: Description	Size
0000h	<b>Datasets Corrected {33h:0000h}</b> : ECC is done by hardware. This is driven by CQ rewritten counts greater than 3%. Each count represents one dataset that used ECC correction and either wrote it nominally or used it but still triggered error recovery.	2
0001h	<b>Servo Transients {33h:0001h}</b> : Media ERP action was required because of a servo detected error and the first retry was successful. Each count represents one dataset in error that was successfully recovered and written.	2
0002h	<b>Data Transients {33h:0002h}</b> : Media ERP action was required because of a readback check or ECC detected error and the first retry was successful. Each count represents one dataset in error that was successfully recovered and written.	2
0003h	<b>Velocity Events {33h:0003h}</b> : A velocity control problem occurred. Each count represents one occurrence, not just the count of affected datasets. Counts may include occurrences from both temporary and permanent errors.	2
0004h	<b>Servo Acquisition Temps {33h:0004h}</b> : A servo error (servo dropout or off-track shutdown) was detected while trying to acquire a DSS or dataset at the beginning of a write append sequence (motion); Media ERP action was required, and servo transient condition criteria were not met. Each count represents one dataset in error that was successfully recovered and written.	2
0005h	<b>Data Acquisition Temps {33h:0005h}</b> : During read-back check, the read channel failed to acquire a DSS or dataset at the beginning of a write append sequence and no servo error was reported, Media ERP action was required, and read/ECC transient condition criteria were not met. Each count represents one dataset in error that was successfully recovered and written.	2
0006h	<b>Servo Temps {33h:0006h}</b> : A servo error (servo dropout or off-track shutdown) was detected while writing data, Media ERP action was required, and servo transient condition criteria were not met. Each count represents one dataset in error that was successfully recovered and written.	2
0007h	<b>Data Temps {33h:0007h}</b> : An uncorrectable ECC error, CRC error, instantaneous speed variation (ISV) error, or no ending burst error occurred during readback check of a dataset, and no servo error was reported; Media ERP action was required, and readback/ECC transient condition criteria were not met. Each count represents one dataset in error that was successfully recovered and written.	2
0008h	<b>Total Retries {33h:0008h}</b> : The count of the total number of Media ERP actions. Each count represents one occurrence, not just one time per dataset. Counts may include occurrences from both temporary and permanent errors.	2
0009h	<b>Vendor-Reserved {33h:0009h}</b> :	2
000Ah	Obsolete	2
000Bh	<b>Servo Skip Events {33h:000Bh}</b> : The count of long servo write skips, extended DSS or long spaces between datasets written. This is generally servo write skips, but may also include other write scenarios. Each count represents one occurrence, not one count per block. Counts may include occurrences from both temporary and permanent errors.	2
000Ch	<b>Housekeeping Events {33h:000Ch}</b> : The count of total Media ERP actions needed to write datasets in the Housekeeping Dataset region. Each count represents one occurrence, not just one time per dataset. Counts may include occurrences from both temporary and permanent errors.	2
Note 1 - Media ERP is Error Recovery Procedure(s) where a backhitch/retry is required.		

Table 290 — LP 33h: Write Errors log parameter codes (part 2 of 2)

Code	Counter: Description	Size
000Dh	<b>FID Events {33h:000Dh}</b> : The count of total Media ERP actions needed to write the FID. Each count represents one occurrence, not just one time per dataset. Counts may include occurrences from both temporary and permanent errors.	2
000Eh	Not supported	2
000Fh	<b>Dataset Underrun {33h:000Fh}</b> : The number of times that the drive overran the buffer processing capability and had to stop and restart during a write. Each count represents one occurrence, not just one time per write.	2
0010h	<b>Vendor-Reserved {33h:0011h}</b> :	2
0011h	<b>Servo Position Events {33h:0011h}</b> : The number of servo detected positional compare discrepancies.	2
Note 1 - Media ERP is Error Recovery Procedure(s) where a backhitch/retry is required.		

#### 6.4.23 LP 34h: Read Forward Errors

See LOG SELECT - 4Ch (see 5.2.8 on page 94) and LOG SENSE - 4Dh (see 5.2.9 on page 94) for directions on how to use this page. This page contains detailed counters related to read operations.

##### 6.4.23.1 Parameter Definitions (34h)

When multiple errors occur on a dataset, the counter that is updated is generally based on the first error detected. ERP counters indicate which specific ERP methods were successfully employed.

**WARNING**

Log pages may have different reset behaviors. Care should be taken to ensure counters are processed appropriately, including consideration of their reset behaviors. While reset behaviors may be different between products, an attempt is made to maintain compatibility between generations of a given product. See “Log Parameters (LP)” on page 255.

**WARNING**

**WARNING****WARNING**

The parameters in log pages should be dynamically parsed as some parameters may not be present and new parameters may be inserted. The relative location of parameters have changed and are anticipated to continue to change.

**WARNING****WARNING****Table 291 — LP 34h: Read Error Counters log parameter codes (part 1 of 2)**

Code	Counter: Description	Size
0000h	<b>Datasets Corrected {34h:0000h}</b> : ECC correction is done by hardware. Each count represents one dataset that used ECC C2 correction and either read nominally or used it but still triggered error recovery.	2
0001h	<b>Servo Transients {34h:0001h}</b> : Media ERP action was required because of a servo detected error and the first retry was successful. Each count represents one dataset in error that was successfully recovered and read.	2
0002h	<b>Data Transients {34h:0002h}</b> : Media ERP action was required because of a read channel or ECC detected error and the first retry was successful. Each count represents one dataset in error that was successfully recovered and read.	2
0003h	Not supported.	2
0004h	<b>Servo Acquisition Temps {34h:0004h}</b> : A servo error (servo dropout or off track shutdown) was detected while trying to acquire an initial DSS or dataset, media ERP action was required, and servo transient condition criteria were not met. Each count represents one dataset in error that was successfully recovered and read.	2
0005h	<b>Data Acquisition Temps {34h:0005h}</b> : The read channel failed to acquire an initial DSS or dataset, and no servo error was reported; media ERP action was required, and read/ECC transient condition criteria were not met. Each count represents one dataset in error that was successfully recovered and read.	2
0006h	<b>Servo Temps {34h:0006h}</b> : A servo error (servo drop out) was detected while reading a dataset; media ERP action was required, and servo transient condition criteria were not met. Each count represents one dataset in error that was successfully recovered and read.	2
0007h	<b>Data Temps {34h:0007h}</b> : An uncorrectable error, CRC error, or no ending burst error occurred while reading a dataset, and no servo error was reported; media ERP action was required, and read/ECC transient condition criteria were not met. Each count represents one dataset in error that was successfully recovered and read.	2
0008h	Not supported	2
0009h	Not supported	2
000Ah	Not supported	2
000Bh	Not supported	2
000Ch	<b>ERP Servo Adjust Hi {34h:000Ch}</b> : The dataset was recovered by reading with servo off-track variations. Each count represents one dataset in error that was successfully recovered and read with an above-nominal setting.	2
000Dh	<b>ERP Servo Adjust Lo {34h:000Dh}</b> : The dataset was recovered by reading with servo off-track variations. Each count represents one dataset in error that was successfully recovered and read with a below-nominal setting.	2
000Eh	Obsolete	2
000Fh	Obsolete	2
0010h	Obsolete	2
0011h	Obsolete	2
0012h	Obsolete	2
0013h	Not supported	2
Note 1 - Media ERP is Error Recovery Procedure(s) where a backhitch/retry is required.		

Table 291 — LP 34h: Read Error Counters log parameter codes (part 2 of 2)

Code	Counter: Description	Size
0014h	Reserved	2
0015h	<b>Total Retries {34h:0015h}</b> : The count of the total number of Media ERP actions. Each count represents one occurrence, not just one time per dataset. Counts may include occurrences from both temporary and permanent errors.	2
0016h	Obsolete	2
0017h	<b>Housekeeping Events {34h:0017h}</b> : The count of total Media ERP actions needed to read datasets in the Housekeeping Dataset region. Each count represents one occurrence, not just one time per dataset. Counts may include occurrences from both temporary and permanent errors.	2
0018h	Not supported	2
0019h	<b>Dataset Overrun {34h:0019h}</b> : The number of times that the drive overran the buffer processing capability and had to stop and restart during a read. Each count represents one occurrence, not just one time per read.	2
001Ah	Reserved	2
001Bh	<b>Servo Skip Events {34h:001Bh}</b> : The count of extended DSS or long spaces between datasets read. This may include servo write skips, but may also include other write scenarios. Each count represents one occurrence, not one count per block. Counts may include occurrences from both temporary and permanent errors.	2
001Ch	Reserved	2
001Dh	<b>FID Events {34h:001Dh}</b> : The count of total Media ERP actions needed to read the FID. Each count represents one occurrence, not just one time per dataset. Counts may include occurrences from both temporary and permanent errors.	2
001Eh	<b>Servo Position Events {34h:001Eh}</b> : The number of servo detected positional compare discrepancies.	2
Note 1 - Media ERP is Error Recovery Procedure(s) where a backhitch/retry is required.		

#### 6.4.24 LP 37h: Performance Characteristics

See LOG SELECT - 4Ch (see 5.2.8 on page 94) and LOG SENSE - 4Dh (see 5.2.9 on page 94) for directions on how to use this page. This page includes various performance and capacity measurements across the operation of the drive. Some fields are normalized qualitative measures while others are quantitative.

##### 6.4.24.1 Parameter Reset Behavior (37h)

**WARNING**

Log pages may have different reset behaviors. Care should be taken to ensure counters are processed appropriately, including consideration of their reset behaviors. While reset behaviors may be different between products, an attempt is made to maintain compatibility between generations of a given product. See “Log Parameters (LP)” on page 255.

**WARNING**

Each parameter has different reset characteristics which are described under the Subpage Code field description for bits 7-6 Scope.

##### 6.4.24.2 Parameter Definitions (37h)

This page uses the Subpage Code mechanism (see 6.4.1) to select which groups of counters to return. This page has three scopes controlled by the SUBPAGE CODE field.

The SUBPAGE CODE field in LOG SENSE - 4Dh (see 5.2.9 on page 94) and Log Parameter Format is used as follows:

Bit	Description	
7-6	Scope	
	<b>Value</b>	<b>Description</b>
	00b	Transient values: reset on Log Select [all Subpages are reset]
	01b	Mount values: reset on load
	10b	Lifetime values: reset on device power on or device reset (not target reset)
	11b	Vendor-Reserved
5-4	Level	
	<b>Value</b>	<b>Description</b>
	00b	Return summary counters
	01b	Return basic counters
	10b	Return advanced counters
3-0	Group	
	<b>Value</b>	<b>Description</b>
	0h	All groups
	1h	Host Interface
	2h	Buffer
	3h	Medium
	4h	Capacity
	5h	Load/Unload
	6h	Servo

The Subpage field in LOG SENSE - 4Dh (see 5.2.9 on page 94) may be set to 00h when the page code field is 37h. This operation will reset all group and local counters in the transient scope. Other scope cannot be explicitly reset.

The individual log subpage and parameter codes are described in the following table. Note that the counters which are returned depends on the Level and Group fields in the subpage. A group value of 0h will return all counters of a level less than or equal to that specified.

In the following tables, multiple counter codes may be represented by a single row. There is an aspect symbol in the counter code such as 'p', 'q', 's', or '?'. The Aspect(s) column indicates which of the following values applies to the given code(s).

Aspect	Definition
p=0	primary interface (fibre) all ports (totals)
p=1	primary interface (fibre) port 0
p=2	primary interface (fibre) port 1
p=A	automation interface (RS-422)
q=1	Non-Ready: NOTE: These commands include ALL commands which are processed when the drive is in a Not Ready state.
q=2	Head-of-Queue: NOTE: These commands are commands which may be processed in any order. Such commands include: Inquiry, Report LUNs, Test Unit Ready and Request Sense. These counts are updated only when the drive is in a Ready state.
q=3	Read: NOTE: This aspect has more features detailed below.
q=4	Write: NOTE: This aspect has more features detailed below.
q=5	Sync: NOTE: This aspect has more features detailed below.
q=6	Seek: NOTE: This aspect has more features detailed below.
q=7	Non-Medium: NOTE: These commands are command issued to LUN 0 which are not in any other applicable category. These include many commands such as Log Sense, Log Select,

	Read Buffer, Reserve, etc. These counts are updated only when the drive is in a Ready state.
q=8	Non-LUN0, Non-Ready: NOTE: These commands include ALL commands which are processed by a LUN other than LUN 0 when the drive is in a Not Ready state.
q=9	Non-LUN0, Head-of-Queue: NOTE: These commands are commands which may be processed in any order. Such commands include: Inquiry, Report LUNs, Test Unit Ready and Request Sense. These counts are updated only when the drive is in a Ready state.
q=A	Non-LUN0: NOTE: These commands include any commands processed by a LUN other than LUN 0. These counts are updated only when the drive is in a Ready state.
s=1	Speed 1: Highest read/write speed
s=2	Speed 2: Second highest read/write speed
s=3	Speed 3: Third highest read/write speed
s=4	Speed 4: Fourth highest read/write speed
s=5	Speed 5: Fifth highest read/write speed
s=6	Speed 6: Sixth highest read/write speed
s=7	Speed 7: Seventh highest read/write speed
s=8	Speed 8: Eighth highest read/write speed
s=9	Speed 9: Ninth highest read/write speed
s=A	Speed 10: Tenth highest read/write speed
s=B	Speed 11: Eleventh highest read/write speed
s=C	Speed 12: Twelfth highest read/write speed
s=D	Speed 13: Thirteenth highest read/write speed
s=E	Speed 14: Fourteenth highest read/write speed
s=F	High speed locate (not read/write capable)
t=0	Partition 0
t=1	Partition 1
t=2	Partition 2
t=3	Partition 3
?=1	write - write phase without host holdoff. NOTE: if no (paused) data is supported for a particular counter, this aspect will include all write information
?=2	write (paused) - write phase while the host is being held off (buffer full)
?=3	read - read phase without host holdoff. NOTE: if no (paused) data is supported for a particular counter, this aspect will include all read information
?=4	read (paused) - read phase while the host is being held off (buffer empty)
?=5	position - during the processing of a seek operation
?=6	load - during the processing of an load operation
?=7	unload - during the processing of an unload operation
?=F	other - not in an above phase

===== WARNING =====

The parameters in log pages should be dynamically parsed as some parameters may not be present and new parameters may be inserted. The relative location of parameters have changed and are anticipated to continue to change..

===== WARNING =====

===== WARNING =====

**Table 292 — LP 37h: Performance Characteristics: Quality Summary**

Code	Aspect(s)	Name: Description	Unit	Size	Level	Group
0000h		<b>Drive Efficiency {37h:0000h}</b> : Overall measure of the drive's condition. 00h is unknown, from 01h (best) to FFh (worst)	rating	1	0	0
0001h		<b>Media Efficiency {37h:0001h}</b> : Overall measure of the currently mounted media's condition. 00h is unknown, from 01h (best) to FFh (worst)	rating	1	0	0
0010h		<b>Primary Interface Efficiency {37h:0010h}</b> : Overall measure of the interface (to the host) condition. 00h is unknown, from 01h (best) to FFh (worst)	rating	1	0	0
0011h		<b>Primary Interface Port 0 Efficiency {37h:0011h}</b> : Overall measure of the per port interface (to the host) condition. 00h is unknown, from 01h (best) to FFh (worst)	rating	1	0	0
0012h		<b>Primary Interface Port 1 Efficiency {37h:0012j}</b> : Overall measure of the per port interface (to the host) condition. 00h is unknown, from 01h (best) to FFh (worst)	rating	1	0	0
001Ah		<b>Library Interface Efficiency {37h:001Ah}</b> : Overall measure of the interface (to the library) condition. 00h is unknown, from 01h (best) to FFh (worst)	rating	1	0	0

**Table 293 — LP 37h: Performance Characteristics: Device Usage (part 1 of 2)**

Code	Aspect(s)	Name: Description	Unit	Size	Level	Group
0040h		<b>Time {37h:0040h}</b> : Amount of entire sample duration	msec	6	2	5
0041h		<b>Medium Empty Time {37h:0041h}</b> : Duration without a tape present	msec	6	2	5
0042h		<b>Medium Insert Time {37h:0042h}</b> : Duration from cartridge insert to load	msec	6	2	5
0043h		<b>Medium Mount Time {37h:0043h}</b> : Total time from start of cartridge load until cartridge ejected	msec	6	2	5
0044h		<b>Medium Load Time {37h:0044h}</b> : Total time from start of cartridge load to load complete (ready)	msec	6	2	5
0045h		<b>Medium Ready Time {37h:0045h}</b> : Total time from load complete (ready) to start of unload	msec	6	2	5
0046h		<b>Medium Eject Time {37h:0046h}</b> : Time from start of unload to unload complete	msec	6	2	5
0047h		<b>Medium Extract Time {37h:0047h}</b> : Time from cartridge unloaded to removed	msec	6	2	5

Table 293 — LP 37h: Performance Characteristics: Device Usage (part 2 of 2)

Code	Aspect(s)	Name: Description	Unit	Size	Level	Group
0048h		<b>Medium Dwell Time {37h:0048h}</b> : Time from cartridge unloaded to (re)loaded. Note - This may include time which cannot be determined as dwell or extract (when time is queried with a cartridge remaining in the unloaded position)	msec	6	2	5
0049h		<b>Medium Clean Time {37h:0049h}</b> : Time from cleaner recognized to eject complete	msec	6	2	5
0051h		<b>Medium Empty Count {37h:0051h}</b> : Number of times tape was fully removed	count	4	2	5
0052h		<b>Medium Insert Count {37h:0052h}</b> : Number of cartridge insertions to load position detected	count	4	2	5
0053h		<b>Medium Mount Count {37h:0053h}</b> : Number of mount operations	count	4	2	5
0054h		<b>Medium Load Count {37h:0054h}</b> : Number of load operations	count	4	2	5
0055h		<b>Medium Ready Count {37h:0055h}</b> : Number of ready transitions	count	4	2	5
0056h		<b>Medium Eject Count {37h:0056h}</b> : Number of unloads	count	4	2	5
0057h		<b>Medium Extract Count {37h:0057h}</b> : Number of times tape was extracted	count	4	2	5
0058h		<b>Medium Dwell Count {37h:0058h}</b> : Number of times tape was reloaded (from unload)	count	4	2	5
0059h		<b>Medium Clean Count {37h:0059h}</b> : Number of recognized cleaner loads (does not indicate successful cleans, tape may be expired)	count	4	2	5

Table 294 — LP 37h: Performance Characteristics: Host Commands (part 1 of 4)

Code	Aspect(s)	Name: Description	Unit	Size	Level	Group
0q00h	12(3456)789A	<b>Count {37h:0q00h}</b> :	count	4	2	1
0q01h	12(3456)789A	<b>Timing {37h:0q01h}</b> :	msec	6	2	1
0q02h	12(3456)789A	<b>Relative Time {37h:0q01h}</b> :	% * 65536	4	1	1
0q04h	12(3456)789A	<b>Transfer Count to Host (in) {37h:0q04h}</b> :	count	4	2	1
0q05h	12(3456)789A	<b>Transfer Byte Count to Host (in) {37h:0q05h}</b> :	bytes	8	2	1
0q06h	12(3456)789A	<b>Transfer Timing to Host (in) {37h:0q06h}</b> :	msec	6	2	1
0q08h	12(4)789A	<b>Transfer Count from Host (out) {37h:0q08h}</b> :	count	4	2	1
0q09h	12(4)789A	<b>Transfer Byte Count from Host (out) {37h:0q09h}</b> :	bytes	8	2	1
0q0Ah	12(4)789A	<b>Transfer Timing from Host (out) {37h:0q0Ah}</b> :	msec	6	2	1
Note - Read type host commands include Read, Verify and Read Reverse (not all of these may be supported). These counts are updated only when the drive is in a Ready state						
0300h		<b>Read Count {37h:0300h}</b> : Number of blocks processed to the host by read type commands	blocks	6	2	1



Table 294 — LP 37h: Performance Characteristics: Host Commands (part 2 of 4)

Code	Aspect(s)	Name: Description	Unit	Size	Level	Group
0301h		<b>Read Timing {37h:0301h}</b> : Amount of time processing read type commands. Note - Due to device specific performance path resources, this may not reflect the actual time spent processing commands, but may reflect the amount of time where read commands could be processed.	msec	6	2	1
0302h		<b>Read Relative Time {37h:0302h}</b> : Ratio of time spent reading with respect to Medium Ready Time	% * 65536	4	1	1
0304h		<b>Transfer Count to Host (in) {37h:0304h}</b> :	count	6	2	1
0305h		<b>Transfer Byte Count to Host (in) {37h:0305h}</b> :	bytes	8	2	1
0306h		<b>Transfer Timing to Host (in) {37h:0306h}</b> :	msec	6	2	1
03D0h		<b>Read Performance Efficiency {37h:03D0h}</b> : Ratio of performance read type commands with respect to all read type commands	% * 65536	4	1	1
03D4h		<b>Read Filemark (perf) Relative Time {37h:03D4h}</b> : Amount of time spent sending filemark encountered status to the host with respect to time Read Timing.	% * 65536	4	2	1
Note - Write type host commands include Write and Write Filemarks [not including any synchronization portion]. These counts are updated only when the drive is in a Ready state.						
0400h		<b>Write Count {37h:0400h}</b> : Number of blocks processed from the host by write type commands	blocks	6	2	1
0401h		<b>Write Timing {37h:0401h}</b> : Amount of time processing write type commands. Note - Due to device specific performance path resources, this may not reflect the actual time spent processing commands, but may reflect the amount of time where write commands could be processed.	msec	6	2	1
0402h		<b>Write Relative Time {37h:0402h}</b> : Ratio of time spent writing with respect to Medium Ready Time	% * 65536	4	1	1
0404h		<b>Transfer Count to Host (in) {37h:0404h}</b> :	count	6	2	1
0405h		<b>Transfer Byte Count to Host (in) {37h:0405h}</b> :	bytes	8	2	1
0406h		<b>Transfer Timing to Host (in) {37h:0406h}</b> :	msec	6	2	1
0408h		<b>Transfer Count from Host (out) {37h:0408h}</b> :	count	6	2	1
0409h		<b>Transfer Byte Count from Host (out) {37h:0409h}</b> :	bytes	8	2	1
040Ah		<b>Transfer Timing from Host (out) {37h:040Ah}</b> :	msec	6	2	1
04D0h		<b>Write Performance Efficiency {37h:04D0h}</b> : Ratio of performance write commands with respect to all write type commands	% * 65536	4	1	1
04D4h		<b>Write Filemark Relative Time {37h:04D4j}</b> : Amount of time spent writing filemarks.	% * 65536	4	2	1
Note - Sync type host commands include Write Filemarks [non-immediate]. Implicit sync type commands include mode changes while writing, non-buffered mode and idle time based syncs. These counts are updated only when the drive is in a Ready state.						
0500h		<b>Sync Count [Host] {37h:0500h}</b> : Number of host sync operations (non-immediate Write Filemarks, non-buffered writes)	count	4	2	1

Table 294 — LP 37h: Performance Characteristics: Host Commands (part 3 of 4)

Code	Aspect(s)	Name: Description	Unit	Size	Level	Group
0501h		<b>Sync Timing [Host] {37h:0501h}</b> : Amount of time processing host sync commands	msec	6	2	1
0502h		<b>Sync Relative Time [Host] {37h:0502h}</b> : Ratio of time spent processing host sync commands with respect to Medium Ready Time	% * 65536	4	1	1
0504h		<b>Transfer Count to Host (in) {37h:0504h}</b> :	count	4	2	1
0505h		<b>Transfer Byte Count to Host (in) {37h:0505h}</b> :	bytes	8	2	1
0506h		<b>Transfer Timing to Host (in) {37h:0506h}</b> :	msec	6	2	1
05D1h		<b>Sync Count [Implicit] {37h:05D1h}</b> : Number of implicit sync commands (time based flushes, mode change flushes)	count	4	2	1
05D2h		<b>Sync Timing [Implicit] {37h:05D2h}</b> : Amount of time processing implicit sync commands	msec	6	2	1
05D4h		<b>Sync Relative Time [Implicit] {37h:05D4h}</b> : Ratio of time spent processing implicit sync commands with respect to Medium Ready Time	% * 65536	4	1	1
Note - Seek type host commands include Space, Locate, and Rewind. These counts are updated only when the drive is in a Ready state.						
0600h		<b>Seek Count {37h:0600h}</b> : Number of positioning host commands	count	4	2	1
0601h		<b>Seek Timing {37h:0601h}</b> : Amount of time spent processing host positioning commands	msec	6	2	1
0602h		<b>Seek Relative Time {37h:0602h}</b> : Ratio of time spend processing host seek commands with respect to Medium Ready Time	% * 65536	4	1	1
0604h		<b>Transfer Count to Host (in) {37h:0604h}</b> :	count	4	2	1
0605h		<b>Transfer Byte Count to Host (in) {37h:0605h}</b> :	bytes	8	2	1
0606h		<b>Transfer Timing to Host (in) {37h:0606h}</b> :	msec	6	2	1
06D1h		<b>Seek Block Count {37h:06D1h}</b> : Number of blocks processed in host positioning commands	blocks	4	2	1
0Cp0h	012A	<b>Command Count {37h:0Cp0h}</b> :	count	6	2	1
0Cp1h	012A	<b>Command Timing {37h:0Cp1h}</b> :	msec	6	2	1
0Cp2h	012A	<b>Command Relative Time {37h:0Cp2h}</b> :	% * 65536	4	2	1
0Cp4h	012A	<b>Command Transfer Count to Host (in) {37h:0Cp4h}</b> :	count	6	2	1
0Cp5h	012A	<b>Command Transfer Byte Count to Host (in) {37h:0Cp5h}</b> :	bytes	8	2	1
0Cp6h	012A	<b>Command Transfer Timing to Host (in) {37h:0Cp6h}</b> :	msec	6	2	1
0Cp8h	012A	<b>Command Transfer Count from Host (out) {37h:0Cp8h}</b> :	count	6	2	1
0Cp9h	012A	<b>Command Transfer Byte Count from Host (out) {37h:0Cp9h}</b> :	bytes	8	2	1
0CpAh	012A	<b>Command Transfer Timing from Host (out) {37h:0CpAh}</b> :	msec	6	2	1
0CpCh	012A	<b>Command Queue Count {37h:0CpCh}</b> :	count	6	2	1

Table 294 — LP 37h: Performance Characteristics: Host Commands (part 4 of 4)

Code	Aspect(s)	Name: Description	Unit	Size	Level	Group
0CpDh	012A	<b>Command Queue Latency {37h:0CpDh}:</b>	msec	6	2	1
0CpEh	012A	<b>Command Queue Relative Time {37h:0CpEh}:</b>	% * 65536	4	2	1
0Dp1h	12A	<b>Port Throughput Rate Maximum Bursting {37h:0Dp1h}:</b>	bytes/sec	6	2	1
0Dp2h	12A	<b>Port Throughput Rate Maximum Sustained {37h:0Dp2h}:</b>	bytes/sec	6	2	1
0Dp3h	12A	<b>Port Throughput Rate {37h:0Dp3h}:</b>	bytes/sec	6	2	1
0Dp4h	12A	<b>Port Throughput Efficiency {37h:0Dp4h}:</b>	% * 65536	4	1	1
0Dp7h	12A	<b>Port Rate Changes {37h:0Dp7h}:</b>	count	4	2	1
0DF0h		<b>Average Command Latency {37h:0DF0h}:</b> Average amount of time commands were queued waiting for execution with respect to all commands (including unqueued commands which processed immediately).	usec	4	1	1
0DF1h		<b>Average Dequeue Latency {37h:0DF1h}:</b> Average amount of time commands were queued waiting for execution with respect to commands which were queued (not processed immediately).	usec	4	1	1
0DF8h		<b>Long Queue Latency Count [&gt;1 sec] {37h:0DF8h}:</b>	count	4	2	1
0DF9h		<b>Long Queue Latency Count [&gt;10 sec] {37h:0DF9h}:</b>	count	4	2	1
0DFAh		<b>Long Queue Latency Count [&gt;100 sec] {37h:0DFAh}:</b>	count	4	2	1
0DFBh		<b>Long Queue Latency Count [&gt;1000 sec] {37h:0DFBh}:</b>	count	4	2	1

Table 295 — LP 37h: Performance Characteristics: Host Initiators

Code	Aspect(s)	Name: Description	Unit	Size	Level	Group
Note - In dual port configurations it is possible for the same host to be identified as a different initiator when using a different logical or physical path. This can occur in failover or load balancing applications.						
0E00h		<b>Active Initiator Count {37h:0E00h}:</b> Number of initiators which processed one or more commands.	count	4	2	1
0E01h		<b>Primary Initiator {37h:0E01h}:</b> Ratio of commands issued by the initiator which is issuing the most commands with respect to all initiators.	% * 65536	4	2	1
0E02h		<b>Secondary Initiator {37h:0E02h}:</b> Ratio of commands issued by the initiator which is issuing the second most commands with respect to all initiators.	% * 65536	4	2	1
0E03h		<b>Current Initiator {37h:0E03h}:</b> Ratio of commands issued by this (the querying) initiator with respect to all initiators.	% * 65536	4	2	1

Table 296 — LP 37h: Performance Characteristics: Host Recovery (by port)

Code	Aspect(s)	Name: Description	Unit	Size	Level	Group
0Fp0h	12A	Transfer Recoveries [by port] {37h:0Fp0h}:	count	4	2	1
0Fp1h	12A	Transfer Recover Time [by port] {37h:0Fp1h}:	msec	6	2	1
0Fp2h	12A	Resource Recoveries [by port] {37h:0Fp2h}:	count	4	2	1
0Fp3h	12A	Reset Count [by port] {37h:0Fp3h}:	count	4	2	1
0Fp8h	12A	Abort Count [by port] {37h:0Fp8h}:	count	4	2	1
0Fp9h	12A	Abort Time [by port] {37h:0Fp9h}:	msec	6	2	1

Table 297 — LP 37h: Performance Characteristics: Mode Phase Timing Windows (part 1 of 3)

Code	Aspect(s)	Name: Description	Unit	Size	Level	Group
1000h		Write Cycles {37h:1000h}:	count	4	2	2
1001h		Write Pauses {37h:1001h}:	count	4	2	2
1010h		Write Cycle Time {37h:1010h}:	msec	6	2	2
1020h		Write Cycle Relative Time {37h:1020h}: Ratio of time in write mode with respect to Medium Ready Time.	% * 65536	4	1	2
1021h		Write Setup Relative Time {37h:1021h}:	% * 65536	4	2	2
1022h		Write Ready Relative Time {37h:1022h}:	% * 65536	4	1	2
1023h		Write Pause Relative Time {37h:1023h}:	% * 65536	4	1	2
1024h		Write Exit Relative Time {37h:1024h}:	% * 65536	4	2	2
1200h		Read Cycles {37h:1200h}:	count	4	2	2
1201h		Read Pauses {37h:1201h}:	count	4	2	2
1210h		Read Cycle Time {37h:1210h}:	msec	6	2	2
1220h		Read Cycle Relative Time {37h:1220h}: Ratio of time in write mode with respect to Medium Ready Time.	% * 65536	4	1	2
1221h		Read Setup Relative Time {37h:1221h}:	% * 65536	4	2	2
1222h		Read Ready Relative Time {37h:1222h}:	% * 65536	4	1	2
1223h		Read Pause Relative Time {37h:1223h}:	% * 65536	4	1	2
1224h		Read Exit Relative Time {37h:1224h}:	% * 65536	4	2	2
1225h		Read Traverse EM Relative Time {37h:1225h}:	% * 65536	4	2	2
1400h		Position Count {37h:1400h}:	count	4	2	2
1410h		Position Time {37h:1410h}:	msec	6	2	2
1420h		Position Relative Time {37h:1420h}: Ratio of time spent physically and logically positioning with respect to Medium Ready Time.	% * 65536	4	1	2
1430h		Position Relative Rate {37h:1430h}:	bytes/sec	4	1	2
1480h		Position Count (Media) {37h:1480h}:	count	4	2	2
1490h		Position Time (Media) {37h:1490h}:	msec	6	2	2
14A0h		Position Relative Time (Media) {37h:14A0h}: Ratio of time spent physically positioning media with respect to Medium Ready Time.	% * 65536	4	1	2
14B0h		Position Relative Rate (Media) {37h:14B0h}:	bytes/sec	4	1	2

Table 297 — LP 37h: Performance Characteristics: Mode Phase Timing Windows (part 2 of 3)

Code	Aspect(s)	Name: Description	Unit	Size	Level	Group
14F0h		<b>Position Buffer Hits {37h:14F0h}</b> : Ratio of positioning operations where targets were already present in the buffer.	% * 65536	4	1	2
1500h		<b>Flush Count {37h:1500h}</b> : Number of low level buffer write flush operations. These may include operations which only affect the buffer and do not involve media motion.	count	4	1	2
1510h		<b>Flush Time {37h:1510h}</b> : Time spend executing operations counted by Flush Count.	msec	6	2	2
1520h		<b>Flush Relative Time {37h:1520h}</b> : Ratio of time spent flushing with respect to Medium Ready Time.	% * 65536	4	1	2
1580h		<b>Flush Count (Media) {37h:1580h}</b> : Number of low level buffer write flush operations which involve [or continue] media motion.	count	4	1	2
1590h		<b>Flush Time (Media) {37h:1590h}</b> : Time spent executing operations counted by Flush Count (Media).	msec	6	2	2
15A0h		<b>Flush Relative Time (Media) {37h:15A0h}</b> : Ratio of time spent flushing to media with respect to Write Cycle Time.	% * 65536	4	1	2
15F0h		<b>Flush Buffer Hits {37h:15F0h}</b> : Ratio of flush operations which required media motion.	% * 65536	4	1	2
2000h		<b>Media Idle {37h:2000h}</b> :	msec	6	2	3
2001h		<b>Media Write {37h:2001h}</b> :	msec	6	2	3
2002h		<b>Media Read {37h:2002h}</b> :	msec	6	2	3
2003h		<b>Media Erase {37h:2003h}</b> :	msec	6	2	3
2004h		<b>Media Position {37h:2004h}</b> :	msec	6	2	3
20?0h	1234567F	<b>Media Phase Timing {37h:20?0h}</b> :	msec	6	2	3
20?1h	1234567F	<b>Media Phase Cycles {37h:20?1h}</b> :	count	4	2	3
2?10h	1234567F	<b>Wrap Change Count {37h:2?10h}</b> : Total number of wrap changes.	count	4	2	3
2?11h	1234567F	<b>Band Change Count {37h:2?11h}</b> : Total number of changes to different servo bands.	count	4	2	3
2?50h	13	<b>Datarate Performance Impacting ERPs {37h:2?50h}</b> :	% * 65536	4	1	3
2?51h	13567F	<b>Performance Impacting ERPs {37h:2?51h}</b> :	% * 65536	4	1	3
2?52h	1234567F	<b>Performance Impact by ERPs {37h:2?52h}</b> :	% * 65536	4	1	3
2?60h	135	<b>Uncompressed Data {37h:2?60h}</b> :	bytes	8	2	2
2?61h	135	<b>Compressed Data {37h:2?61h}</b> :	bytes	8	2	2
2?62h	135	<b>Padded Data {37h:2?62h}</b> :	bytes	8	2	2
2?63h	135	<b>Degate Data {37h:2?63h}</b> :	bytes	8	2	2
2?68h	135	<b>Datasets Processed {37h:2?68h}</b> :	datasets	4	2	2
2?6Ch	13	<b>Compression Ratio {37h:2?6Ch}</b> :	% * 65536	4	1	2
2?71h	13F	<b>Compressed Data (Medium) {37h:2?71h}</b> :	bytes	8	2	3
2?72h	13F	<b>Padded Data (Medium) {37h:2?72h}</b> :	bytes	8	2	3
2?80h	13	<b>Maximum Host Transfer Rate {37h:2?80h}</b> :	bytes/sec	4	1	2

Table 297 — LP 37h: Performance Characteristics: Mode Phase Timing Windows (part 3 of 3)

Code	Aspect(s)	Name: Description	Unit	Size	Level	Group
2?81h	13	<b>Average Host Transfer Rate {37h:2?81h}: </b>	bytes/sec	4	1	2
2?82h	13	<b>Average Host Buffer Rate {37h:2?82h}: </b>	bytes/sec	4	1	2
2?83h	13	<b>Window Host Buffer Rate {37h:2?83h}: </b>	bytes/sec	4	1	2
2?84h	13	<b>Host Buffer Efficiency {37h:2?84h}: </b>	% * 65536	4	1	2
2?85h	13	<b>Window Buffer Efficiency {37h:2?85h}: </b>	% * 65536	4	1	2
2?88h	13	<b>Average Host Transfer Length {37h:2?88h}: </b>	bytes	4	2	2
2?8Ch	1	<b>Average Host Sync Length {37h:2?8Ch}: </b>	bytes	6	2	2
2?90h	13	<b>Maximum Comp Transfer Rate {37h:2?90h}: </b>	bytes/sec	4	1	2
2?91h	13	<b>Average Comp Transfer Rate {37h:2?91h}: </b>	bytes/sec	4	1	2
2?92h	13	<b>Average Comp Buffer Rate {37h:2?92h}: </b>	bytes/sec	4	1	2
2?93h	13	<b>Window Comp Buffer Rate {37h:2?93h}: </b>	bytes/sec	4	1	2
2?94h	13	<b>Comp Buffer Efficiency {37h:2?94h}: </b>	% * 65536	4	1	2
2?95h	13	<b>Window Comp Buffer Efficiency {37h:2?95h}: </b>	% * 65536	4	1	2
2?98h	13	<b>Average Comp Transfer Length {37h:2?98h}: </b>	bytes	4	2	2
2?9Ch	1	<b>Average Comp Sync Length {37h:2?9Ch}: </b>	bytes	6	2	2
2?A0h	13	<b>Maximum Tape Transfer Rate {37h:2?A0h}: </b>	bytes/sec	4	1	2
2?A1h	13	<b>Average Tape Buffer Rate {37h:2?A1h}: </b>	bytes/sec	4	2	2
2?A2h	13	<b>Window Tape Buffer Rate {37h:2?A2h}: </b>	bytes/sec	4	2	2
2?A3h	13	<b>Moving Tape Buffer Rate {37h:2?A3h}: </b>	bytes/sec	4	2	2
2?A4h	13	<b>Window Tape Buffer Efficiency {37h:2?A4h}: </b>	% * 65536	4	2	2
2?A5h	13	<b>Moving Tape Buffer Efficiency {37h:2?A5h}: </b>	% * 65536	4	2	2
2?A6h	13	<b>Tape Buffer Efficiency {37h:2?A6h}: </b> Ratio of amount of time we are usefully moving and ready with respect to amount of time the buffer is able to process data. A ratio larger than 1 indicates the compressed host data is arriving faster than the native device rate. Lower values indicate the device has under utilized host bandwidth.	% * 65536	4	2	2
2?A7h	13F	<b>Tape Thrashing {37h:2?A7h}: </b> Ratio of amount of time we are accelerating, decelerating or backhitching with respect to the time in mode.	% * 65536	4	2	2
2?A8h	13F	<b>Tape Efficiency {37h:2?A8h}: </b> Ratio of amount of time we are usefully moving and ready with respect to the time in mode.	% * 65536	4	1	2
2?F0h	13	<b>Speed Changes {37h:2?F0h}: </b>	count	4	2	2
2?F1h	13	<b>Speed Forced {37h:2?F1h}: </b>	count	4	2	2

Table 298 — LP 37h: Performance Characteristics: Servo Speed Characteristics

Code	Aspect(s)	Name: Description	Unit	Size	Level	Group
5Fs0h	123456789ABCDEF	<b>Servo Speed Relative Time {37h:5Fs0h}: </b>	% * 65536	4	2	6

Table 299 — LP 37h: Performance Characteristics: Static Capacity

Code	Aspect(s)	Name: Description	Unit	Size	Level	Group
7000h		Static Capacity Efficiency {37h:7000h}:	% * 65536	4	1	4
7010h		Static Datasets Media {37h:7010h}:	datasets	4	2	4
7011h		Static Datasets Used {37h:7011h}:	datasets	4	2	4
7020h		Static Distance Media {37h:7020h}:	mm	8	2	4
7021h		Static Distance Used {37h:7021h}:	mm	8	2	4
7030h		Static Remaining Capacity in SkipSync Buffer {37h:7030h}:	% * 65536	4	2	4

Table 300 — LP 37h: Performance Characteristics: Active Capacity

Code	Aspect(s)	Name: Description	Unit	Size	Level	Group
7?00h	13F	Active Capacity Efficiency {37h:7?00h}:	% * 65536	4	1	4
7?10h	13F	Active Sync Loss {37h:7?10h}:	% * 65536	4	2	4
7?11h	13F	Active Skip Loss {37h:7?11h}:	% * 65536	4	2	4
7?12h	13F	Active DSS Loss {37h:7?12h}:	% * 65536	4	2	4
7?13h	13F	Active CQs Loss (on-the-fly) {37h:7?13h}:	% * 65536	4	2	4
7?21h	13F	Active Distance Skip {37h:7?21h}:	mm	8	2	4
7?22h	13F	Active Distance DSS {37h:7?22h}:	mm	8	2	4
7?23h	13F	Active Distance CQs (on-the-fly) {37h:7?23h}:	mm	8	2	4
7?2Fh	13F	Active Distance Total {37h:7?2Fh}:	mm	8	2	4

Table 301 — LP 37h: Performance Characteristics: Static Capacity per Partition

Code	Aspect(s)	Name: Description	Unit	Size	Level	Group
8t00h	01	Static Capacity Efficiency (Partition t) {37h:8t00h}:	% * 65536	4	1	4
8t10h	01	Static Datasets Media (Partition t) {37h:8t10h}:	datasets	4	2	4
8t11h	01	Static Datasets Used (Partition t) {37h:8t11h}:	datasets	4	2	4
8t20h	01	Static Distance Media (Partition t) {37h:8t20h}:	mm	8	2	4
8t21h	01	Static Distance Used (Partition t) {37h:8t21h}:	mm	8	2	4

#### 6.4.25 LP 38h: Blocks/Bytes Transferred

See LOG SELECT - 4Ch (see 5.2.8 on page 94) and LOG SENSE - 4Dh (see 5.2.9 on page 94) for directions on how to use this page.

### 6.4.25.1 Parameter Definitions (38h)

==== WARNING ===== WARNING =====

Log pages may have different reset behaviors. Care should be taken to ensure counters are processed appropriately, including consideration of their reset behaviors. While reset behaviors may be different between products, an attempt is made to maintain compatibility between generations of a given product. See “Log Parameters (LP)” on page 255.

==== WARNING ===== WARNING =====



===== WARNING =====

===== WARNING =====

The parameters in log pages should be dynamically parsed as some parameters may not be present and new parameters may be inserted. The relative location of parameters have changed and are anticipated to continue to change..

===== WARNING =====

===== WARNING =====

**Table 302 — LP 38h: Blocks/Bytes Transferred log parameter codes (part 1 of 2)**

Code	Counter: Description	Size
0000h	<b>Host Write Blocks Processed {38h:0000h}</b> : Each count represents a block processed across the host interface during a Write. The count does not include ERP retries.	8
0001h	<b>Host Write Kibibytes Processed {38h:0001h}</b> : Each count represents a kibibyte (1024 bytes) processed across the host interface during a Write. The count does not include ERP retries. This count may be divided by Device Write Kibibytes Processed, 0005, to calculate an approximate write compression ratio.	8
0002h	<b>Host Read Blocks Processed {38h:0002h}</b> : Each count represents a block processed across the host interface during a Read. The count does not include ERP retries.	8
0003h	<b>Host Read Kibibytes Processed {38h:0003h}</b> : Each count represents a kibibyte (1024 bytes) processed across the host interface during a Read. The count does not include ERP retries. This count may be divided by Device Read Kibibytes Processed, 0007, to calculate an approximate read compression ratio.	8
0004h	<b>Device Write Datasets Processed {38h:0004h}</b> : Each count represents a dataset processed on the medium. The count does not include ERP retries.	4
0005h	<b>Device Write Kibibytes Processed {38h:0005h}</b> : Each count represents a kibibyte (1024 bytes) processed on the medium. The count does not include ERP retries or any tape formatting overhead bytes.	6
0006h	<b>Device Read Datasets Processed {38h:0006h}</b> : Each count represents a dataset processed from the medium. The count does not include ERP retries.	4
0007h	<b>Device Read Kibibytes Processed {38h:0007h}</b> : Each count represents a kibibyte (1024 bytes) processed from the medium. The count does not include ERP retries or any tape formatting overhead bytes.	6
0008h	<b>Device Write Datasets Transferred {38h:0008h}</b> : Each count represents a dataset processed on the medium. The count includes ERP retries.	4
0009h	<b>Device Write Kibibytes Transferred {38h:0009h}</b> : Each count represents a kibibyte (1024 bytes) processed on the medium. The count includes ERP retries and any tape formatting overhead bytes.	6
000Ah	<b>Device Read Datasets Transferred {38h:000Ah}</b> : Each count represents a dataset processed from the medium. The count includes ERP retries.	4
000Bh	<b>Device Read Kibibytes Transferred {38h:000Bh}</b> : Each count represents a kibibyte (1024 bytes) processed from the medium. The count includes ERP retries and any tape formatting overhead bytes.	6
000Ch	<b>Nominal Capacity of Partition {38h:000Ch}</b> : The nominal capacity of the current partition (in kibibytes).	8
000Dh	<b>Fraction of Partition Traversed {38h:000Dh}</b> : The fractional part of the current partition traversed (N/255).	1
Note 1 - A value of all ones (-1) indicates the value is unknown		

Table 302 — LP 38h: Blocks/Bytes Transferred log parameter codes (part 2 of 2)

Code	Counter: Description	Size
000Eh	<b>Nominal Capacity of Volume {38h:000Eh}</b> : The nominal capacity of the mounted volume (in kibibytes). This is determined by the sum of the Nominal Capacity of Partition parameter for each partition.	8
000Fh	<b>Fraction of Volume Traversed {38h:000Fh}</b> : The fractional part of the mounted volume traversed (N/255). This reports the value that would be reported by the Fraction of Partition Traversed if the volume were a single partition.	1
0010h	<b>Remaining Capacity of Volume {38h:0010h}</b> : The nominal unwritten remaining capacity of the mounted volume (in kibibytes). This is not sensitive to current position. This is determined by the sum of the Remaining Capacity of Partition for each partition. If the tape does not have a valid EOD in at least one existing partition, or if a tape is not loaded, then a value of 'all ones' (-1) is returned.	8
0011h	<b>Remaining Capacity of Partition {38h:0011h}</b> : The nominal unwritten remaining capacity of the current partition (in kibibytes). This is not sensitive to current position. If the tape does not have a valid EOD in the current partition, or if a tape is not loaded, then a value of 'all ones' (-1) is returned.	8
Note 1 - A value of all ones (-1) indicates the value is unknown		

#### 6.4.26 LP 39h: Host Port 0 Interface Errors

See LOG SELECT - 4Ch (see 5.2.8 on page 94) and LOG SENSE - 4Dh (see 5.2.9 on page 94) for directions on how to use this page. The count of errors occurring on host interface port 0 (while the device is active on the interface).

##### 6.4.26.1 Parameter Definitions (39h)

===== WARNING =====

Log pages may have different reset behaviors. Care should be taken to ensure counters are processed appropriately, including consideration of their reset behaviors. While reset behaviors may be different between products, an attempt is made to maintain compatibility between generations of a given product. See "Log Parameters (LP)" on page 255.

===== WARNING =====

===== WARNING =====

The parameters in log pages should be dynamically parsed as some parameters may not be present and new parameters may be inserted. The relative location of parameters have changed and are anticipated to continue to change..

===== WARNING =====

===== WARNING =====

**Table 303 — LP 39h: Host Port Interface Errors log parameter codes**

Code	Counter: Description	Size
0000h	<b>Host Protocol Errors {39h:000h}</b> : Each count represents one occurrence. Counts may include occurrences from both temporary and permanent errors. (On SAS attached devices, this parameter is always set to zero. See LP 18h: Protocol-specific port (see 6.4.15 on page 308) for SAS protocol error counts).	2
0007h	<b>Host Aborts {39h:0007h}</b> : Each count represents one occurrence. Counts may include occurrences from both temporary and permanent errors.	2
0008h	<b>Host Resets {39h:0008h}</b> : Each count represents one occurrence. Counts may include occurrences from both temporary and permanent errors.	2
0009h	<b>Vendor-Reserved {39h:0009h}</b> :	2
000Ah	<b>Vendor-Reserved {39h:000Ah}</b> :	2
0010h	<b>Host Recoveries {39h:0010h}</b> : Each count represents one occurrence. Counts may include occurrences from both temporary and permanent errors. On Fibre Channel devices, this parameter is the count of Sequence Retransmission Request (SRR) occurrences. On SAS attached devices, this parameter is the count of Transport Layer Retries (TLR) occurrences.	4

#### 6.4.27 LP 3Ah: Drive control verification

See LOG SELECT - 4Ch (see 5.2.8 on page 94) and LOG SENSE - 4Dh (see 5.2.9 on page 94) for directions on how to use this page. This page is for special drive control mode verification. This page is not included in the list of supported pages (page code 00h) and is not intended for general use. This page is not shown in this document.

#### 6.4.28 LP 3Bh: Host Port 1 Interface Errors

See LOG SELECT - 4Ch (see 5.2.8 on page 94) and LOG SENSE - 4Dh (see 5.2.9 on page 94) for directions on how to use this page. The count of errors occurring on host port 1 (while the device is active on the interface).

##### 6.4.28.1 Parameter Definitions (3Bh)

NOTE 41 - The parameters are identical to those found in LP 39h: Host Port 0 Interface Errors (see 6.4.26 on page 340), except this data is recorded for incidents which occur on host interface port 1.

===== WARNING =====

Log pages may have different reset behaviors. Care should be taken to ensure counters are processed appropriately, including consideration of their reset behaviors. While reset behaviors may be different between products, an attempt is made to maintain compatibility between generations of a given product. See “Log Parameters (LP)” on page 255.

===== WARNING =====

===== WARNING =====

**WARNING****WARNING**

The parameters in log pages should be dynamically parsed as some parameters may not be present and new parameters may be inserted. The relative location of parameters have changed and are anticipated to continue to change.

**WARNING****WARNING**

### 6.4.29 LP 3Ch: Drive usage information

See LOG SELECT - 4Ch (see 5.2.8 on page 94) and LOG SENSE - 4Dh (see 5.2.9 on page 94) for directions on how to use this page. The Drive usage information log page only has valid data returned when the drive is configured for use in an eServer® system (i.e., The Product ID returned in Standard Inquiry is "HH LTO Gen x" where "x" is a number).

This page allows users to obtain the information last stored regarding the counts accumulated over the life of the drive.

#### 6.4.29.1 Parameter Reset Behavior (3Ch)

**WARNING****WARNING**

Log pages may have different reset behaviors. Care should be taken to ensure counters are processed appropriately, including consideration of their reset behaviors. While reset behaviors may be different between products, an attempt is made to maintain compatibility between generations of a given product. See "Log Parameters (LP)" on page 255.

**WARNING****WARNING**

This page is updated as events and tape pulling occurs. The nonvolatile memory is updated upon error events, the tape being unthreaded, or when the cartridge unloads. If power is lost before the updated data is written to the nonvolatile memory, the counts are not updated.

#### 6.4.29.2 Parameter Definitions (3Ch)

Each parameter is a positive value. The counts do not overflow. Once a count reaches its maximum value, that maximum value is always returned. The counts do not roll over at the maximum value.

===== WARNING =====

The parameters in log pages should be dynamically parsed as some parameters may not be present and new parameters may be inserted. The relative location of parameters have changed and are anticipated to continue to change.

===== WARNING =====

===== WARNING =====

**Table 304 — LP 3Ch: Drive usage information log parameters (part 1 of 2)**

Parameter Code	Counter: Description	Size
0001h	<b>Write Media Blocks Counter {3Ch:0001h}</b> : This counter is a lifetime statistic representing the number of physical groups (i.e. Datasets) written during a write operation. Upon reaching the maximum value, the counter does not wrap back to zero, but retains its maximum value (FFFF FFFF FFFF FFFFh).	8
0002h	<b>Rewrite Media Blocks Counter {3Ch:0002h}</b> : This counter is a lifetime statistic representing the number of physical groups (i.e. Datasets) rewritten during a write operation. Upon reaching the maximum value, the counter does not wrap back to zero, but retains its maximum value (FFFF FFFF FFFF FFFFh).	8
0003h	<b>Read Media Blocks Counter {3Ch:0003h}</b> : This counter is a lifetime statistic representing the number of physical groups (i.e. Datasets) read during a read or space operation. The counter will not increment/decrement during space reverse, space LEOP, or space fast operations. Upon reaching the maximum value, the counter does not wrap back to zero, but retains its maximum value (FFFF FFFF FFFF FFFFh).	8
0004h	<b>ECC Corrections Counter {3Ch:0004h}</b> : This counter is a lifetime statistic representing the number of physical groups (i.e. Datasets) corrected during a read operation. Upon reaching the maximum value, the counter does not wrap back to zero, but retains its maximum value (FFFF FFFF FFFF FFFFh).	8
0005h	<b>Reread Media Blocks Counter {3Ch:0005h}</b> : This counter is a lifetime statistic representing the number of physical groups (i.e. Datasets) reread during a read operation. Upon reaching the maximum value, the counter does not wrap back to zero, but retains its maximum value (FFFF FFFF FFFF FFFFh).	8
0006h	<b>Cumulative Cartridge Loads Counter {3Ch:0006h}</b> : This counter increments each time a new cartridge is loaded. All media types and lengths increments this counter. Cleaning cartridges do not increment the counter. Upon reaching the maximum value, the counter does not wrap back to zero, but retains its maximum value (FF FFFFh).	3
0007h	<b>Time Since Last Cleaning Counter {3Ch:0007h}</b> : This counter tracks the tape pulling time since the last cleaning. The count is expressed in minutes. Upon reaching the maximum value, the counter does not wrap back to zero, but retains its maximum value (FF FFFFh). The counter is reset when the drive is cleaned.	3
0008h	<b>Cumulative Power On Time Counter {3Ch:0008h}</b> : This is a cumulative count of the time the drive has been powered on. The count is expressed in minutes. Upon reaching the maximum value, the counter does not wrap back to zero, but retains its maximum value (FF FFFFh).	3
0009h	<b>Cumulative Time Tape is Loaded and Tensioned {3Ch:0009h}</b> : This is the number of minutes a tape has been threaded with tension on the tape.	3
000Ah	<b>Cumulative Cleaning Counter {3Ch:000Ah}</b> : This is the count of the number of times that a cleaning cartridge was inserted into the drive. Upon reaching the maximum value, the counter does not wrap back to zero, but retains its maximum value (FFFFh).	2
000Bh	<b>"WORN MEDIA" Flag {3Ch:000Bh}</b> : This flag is used by the drive to recommend retirement of the current cartridge. This flag is set when the condition is detected (e.g. on rewind, processing of Log Sense). This flag is cleared on next cartridge load. This corresponds to TapeAlert Flag 07h. 0001h: Media should be retired. 0000h: Media is still good enough to use or media condition cannot be determined (e.g. No media loaded).	2

Table 304 — LP 3Ch: Drive usage information log parameters (part 2 of 2)

Parameter Code	Counter: Description	Size
000Ch	<b>"DEAD MEDIA" Flag {3Ch:000Ch}</b> : This flag is used by the drive to indicate the media is no longer usable. This flag is set when the condition is detected and an error is reported. This flag is cleared on next cartridge load. This corresponds to TapeAlert flag 04h, and the posting of a "DEGRADED MEDIA" message (1/8252h). 0001h: Media is no longer usable. 0000h: Media is still usable or media condition cannot be determined (e.g. No media loaded).	2
000Dh	<b>"DEAD DRIVE" Flag {3Ch:000Dh}</b> : This flag is used by the drive to recommend its own replacement. This flag is set when the condition is detected and an error is reported. This flag is never cleared once set. 0001h: Drive hardware failure has occurred or is imminent. Replace drive. 0000h: Drive hardware failure has not been detected. No drive replacement required.	2
000Eh	Undefined Parameter (0000h)	2
000Fh	Undefined Parameter (0000h)	2
0010h	Undefined Parameter (0000h)	2
0011h	<b>Clean Requested Flag {3Ch:0011h}</b> : This flag indicates the drive should be cleaned. 02h: Drive is not requesting clean 03h: Drive is requesting clean	1
0012h	Undefined Parameter (00h)	1
0013h	Undefined Parameter (00 0000h)	3
0014h	Undefined Parameter (00 0000h)	3
0015h	<b>Cartridge Serial Number {3Ch:0015h}</b> : This is right justified with leading spaces (20h). This value is update on cartridge load and retained until the next cartridge load. If no cartridge has been loaded since last power-on this value is set to all spaces (20h).	12

### 6.4.30 LP 3Dh: Subsystem Statistics

See LOG SELECT - 4Ch (see 5.2.8 on page 94) and LOG SENSE - 4Dh (see 5.2.9 on page 94) for directions on how to use this page. The following counters all deal with subsystem statistics and errors.

#### 6.4.30.1 Parameter Reset Behavior (3Dh)

===== WARNING ===== WARNING =====

Log pages may have different reset behaviors. Care should be taken to ensure counters are processed appropriately, including consideration of their reset behaviors. While reset behaviors may be different between products, an attempt is made to maintain compatibility between generations of a given product. See "Log Parameters (LP)" on page 255.

===== WARNING ===== WARNING =====

Most of the counters on this page are never reset. Most counters are maintained in VPD and persist across Log Select, Log Sense, Power On Resets, and even microcode download. Lifetime values are written to VPD every eight operating hours when the drive is in a not ready state. The counters lock at maximum values.

## 6.4.30.2 Parameter Definitions (3Dh)

===== WARNING =====

The parameters in log pages should be dynamically parsed as some parameters may not be present and new parameters may be inserted. The relative location of parameters have changed and are anticipated to continue to change..

===== WARNING =====

===== WARNING =====

**Table 305 — LP 3Dh: Subsystem Statistics log parameter codes (part 1 of 2)**

Code	Counter: Description	Size
0020h	<b>Volume Lifetime Mounts {3Dh:0020h}</b> : The total number of successful cartridge unloads performed during the lifetime of a cartridge. This field may not be updated for mounts that occur with the volume physically write-protected.	4
0021h	<b>Volume Lifetime Megabytes Written {3Dh:0021h}</b> : The total amount of data in Megabytes ( $10^6$ ) written during the lifetime of the cartridge. On each unload, an approximate value is calculated and stored by rounding up to the nearest Megabyte. These bytes are counted as they are processed to the medium (compressed bytes), not at the host interface. This field may not be updated during mounts that occur with the volume physically write-protected.	8
0022h	<b>Volume Lifetime Megabytes Read {3Dh:0022h}</b> : The total amount of data in Megabytes ( $10^6$ ) read during the lifetime of the cartridge. On each unload, an approximate value is calculated and stored by rounding up to the nearest Megabyte. These bytes are counted as they are processed from the medium (compressed bytes), not at the host interface. This field may not be updated during mounts that occur with the volume physically write-protected.	8
0040h	<b>Drive Lifetime Mounts {3Dh:0040h}</b> : The total number of successful cartridge unloads performed during the lifetime of the drive.	4
0041h	<b>Drive Lifetime Megabytes Written {3Dh:0041h}</b> : The total amount of data in Megabytes ( $10^6$ ) written during the lifetime of the drive. On each unload, an approximate value is calculated and stored by rounding up to the nearest Megabyte. These bytes are counted as they are processed to the medium (compressed bytes), not at the host interface.	8
0042h	<b>Drive Lifetime Megabytes Read {3Dh:0042h}</b> : The total amount of data in Megabytes ( $10^6$ ) read during the lifetime of the drive. On each unload, an approximate value is calculated and stored by rounding up to the nearest Megabyte. These bytes are counted as they are processed from the medium (compressed bytes), not at the host interface.	8
0060h	<b>Clean Lifetime Mounts {3Dh:0060h}</b> : The total number of successful cleaner cartridge operations performed during the lifetime of the drive.	4
0061h	<b>Megabytes Written since Clean {3Dh:0061h}</b> : The total amount of data in Megabytes ( $10^6$ ) written since the last successful clean operation. On each unload, an approximate value is calculated and stored by rounding up to the nearest Megabyte. These bytes are counted as they are processed to the medium (compressed bytes), not at the host interface.	8
0062h	<b>Megabytes Read since Clean {3Dh:0062h}</b> : The total amount of data in Megabytes ( $10^6$ ) read since the last successful clean operation. On each unload, an approximate value is calculated and stored by rounding up to the nearest Megabyte. These bytes are counted as they are processed from the medium (compressed bytes), not at the host interface.	8
0063h	<b>Mounts since Clean {3Dh:0063h}</b> : The total number of mounts performed since the last successful clean operation.	4
0080h	<b>Library Interface Messages Received {3Dh:0080h}</b> : This counter is not stored in VPD and reflects messages since reset.	4
0081h	<b>Library Interface Messages Transmitted {3Dh:0081h}</b> : This counter is not stored in VPD and reflects message since reset.	4
0082h	<b>Library Interface Resets {3Dh:0082h}</b> : Count of hardware reset or logical reinitializations during normal operation.	4
0083h	<b>Library Interface Buffer Errors {3Dh:0083h}</b> : This includes buffer overrun or underrun conditions.	4

Table 305 — LP 3Dh: Subsystem Statistics log parameter codes (part 2 of 2)

Code	Counter: Description	Size
0084h	<b>Library Interface Sync Errors {3Dh:0084h}:</b>	4
0085h	<b>Library Interface Framing Errors {3Dh:0085h}:</b>	4
0086h	<b>Library Interface Protocol Errors {3Dh:0086h}:</b>	4
0087h	<b>Library Interface Logical Errors {3Dh:0087h}:</b>	4
0088h	<b>Library Interface Loader Failures {3Dh:0088h}:</b> This counter reflects load attempts when the drive is in an incorrect state or was otherwise unable to attempt requested loader action.	4
0089h	<b>Library Interface NAKs received {3Dh:0089h}:</b>	4
008Ah	<b>Library Interface ACK timeout {3Dh:008A}:</b>	4
008Bh	<b>Library Interface Application Layer timeout {3Dh:008B}:</b>	4
0090h	<b>Drive Lifetime Write Perms {3Dh:0090h}:</b> Total number of write permanent errors which occurred on this drive.	4
0091h	<b>Drive Lifetime Read Perms {3Dh:0091h}:</b> Total number of read permanent errors which occurred on this drive.	4
0092h	<b>Drive Lifetime Load Perms {3Dh:0092h}:</b> Total number of load permanent errors which occurred on this drive.	4
0093h	<b>Drive Lifetime Unload Perms {3Dh:0093h}:</b> Total number of unload permanent errors which occurred on this drive.	4
00A0h	<b>Drive Lifetime Write Temps {3Dh:00A0h}:</b> Total number of write temporary errors which occurred on this drive. Note - This is not a count of ERP actions taken, and certain transient errors may not be included in this count.	4
00A1h	<b>Drive Lifetime Read Temps {3Dh:00A1h}:</b> Total number of read temporary errors which occurred on this drive. Note - This is not a count of ERP actions taken, and certain transient errors may not be included in this count.	4
00A2h	<b>Drive Lifetime Load Temps {3Dh:00A2h}:</b> Total number of load temporary errors which occurred on this drive. Note - This is not a count of ERP actions taken, and certain transient errors may not be included in this count.	4
00A3h	<b>Drive Lifetime Unload Temps {3Dh:00A3h}:</b> Total number of unload temporary errors which occurred on this drive. Note - This is not a count of ERP actions taken, and certain transient errors may not be included in this count.	4
0100h	<b>Lifetime Power On Seconds {3Dh:0100h}:</b> Cumulative number of seconds which the drive has been powered on. Note - Since this time is only periodically updated in non-volatile storage, it is possible that this time may not be entirely accurate to the full resolution of the counter.	4
0101h	<b>Power On Seconds {3Dh:0101h}:</b> Number of seconds since the drive was powered on or has undergone a hard reset condition.	4
0102h	<b>Reset Seconds {3Dh:0102h}:</b> Number of seconds since the drive has undergone a soft reset condition.	4

#### 6.4.31 LP 3Eh: Engineering Use

See LOG SELECT - 4Ch (see 5.2.8 on page 94) and LOG SENSE - 4Dh (see 5.2.9 on page 94) for directions on how to use this page. This page is for engineering use only and is not included in the list of supported pages (i.e., page code 00h). As such, the counters on this page are not intended for general use and are not shown in this document.



#### 6.4.32 LP 3Eh[3Ch]: Drive Control Statistics

See LOG SELECT - 4Ch (see 5.2.8 on page 94) and LOG SENSE - 4Dh (see 5.2.9 on page 94) for directions on how to use this page. This page is for special drive control mode statistics. It is not included in the list of supported pages (page code 00h) and is not intended for general use. This page is not shown in this document.

NOTE 42 - This page was log page 3Ch in Ultrium 2, but was moved to log page 3E[3C] for Ultrium 2 HH and newer generations (eServer support with it's log page 3C was added).



## 6.5 Medium auxiliary memory attributes (MAM)

### 6.5.1 MAM attribute format

Each medium auxiliary memory attribute shall be communicated between the application client and device server in the format shown in table 306. This format shall be used in the parameter data for the WRITE ATTRIBUTE command (see 5.2.43) and the READ ATTRIBUTE command (see 5.2.13). The MAM attribute format in this standard implies nothing about the physical representation of an attribute in the medium auxiliary memory.

**Table 306 — MAM ATTRIBUTE format**

Byte	Bit							
	7 msb	6	5	4	3	2	1	0 lsb
0	(MSB) _____							
1	attribute identifier							(LSB)
2	READ ONLY	Reserved				FORMAT		
3	(MSB) _____							
4	ATTRIBUTE LENGTH (n-4)							(LSB)
5	_____							
n	attribute value							_____

The ATTRIBUTE IDENTIFIER field contains a code value identifying the attribute (see 6.5.2).

The READ ONLY bit indicates whether the attribute is in the read only state (see 4.20). If the READ ONLY bit is set to one, the attribute is in the read only state. If the READ ONLY bit is set to zero, the attribute is in the read/write state.

The FORMAT field (see table 307) specifies the format of the data in the ATTRIBUTE VALUE field.

**Table 307 — MAM attribute FORMAT field**

Format	Name	Description
00b	BINARY	The ATTRIBUTE VALUE field contains binary data.
01b	ASCII	The ATTRIBUTE VALUE field contains left-aligned ASCII data.
10b	TEXT	The attribute contains textual data. The character set is as described in the TEXT LOCALIZATION IDENTIFIER attribute (see 6.5.2.4.6).
11b		Reserved

The ATTRIBUTE LENGTH field specifies the length in bytes of the ATTRIBUTE VALUE field.

The ATTRIBUTE VALUE field contains the current value, for the READ ATTRIBUTE - 8Ch (see 5.2.16 on page 108) command, or intended value, for the WRITE ATTRIBUTE - 8Dh (see 5.2.43 on page 178) command, of the attribute.

## 6.5.2 Attribute identifier values

### 6.5.2.1 Attribute identifier values overview

The values in the ATTRIBUTE IDENTIFIER field (see 6.5.1) are assigned according to the attribute type (see 4.20) and whether the attribute is standard or vendor specific (see table 308).

**Table 308 — MAM attribute identifier range assignments**

Attribute Identifiers	Attribute Type	Standardized	Subclause
0000h to 03FFh	Device	Yes	6.5.2.2
0400h to 07FFh	Medium	Yes	6.5.2.3
0800h to 0BFFh	Host	Yes	6.5.2.4
0C00h to 0FFFh	Device	Vendor specific	
1000h to 13FFh	Medium	Vendor specific	6.5.2.5
1400h to 17FFh	Host	Vendor specific	
1800h to FFFFh	Reserved		

Device servers may accept and process a WRITE ATTRIBUTE command containing standardized host type attribute identifier values (i.e., 0800h-0BFFh) or vendor specific host type attribute identifier values (i.e., 1400h-17FFh). Standardized host type attribute identifier values may be checked as described in 6.5.2.4.

### 6.5.2.2 Device type attributes

Device type attributes (see table 309) shall be maintained and updated by the device server when the medium and associated medium auxiliary memory are present. All supported medium type attributes shall have a status of read only (see 4.20).

**Table 309 — MAM Device type attributes (part 1 of 2)**

Attribute Identifier	Name	Attribute Length (in bytes)	Format	Subclause
0000h	REMAINING CAPACITY IN PARTITION	8	BINARY	6.5.2.2.1
0001h	MAXIMUM CAPACITY IN PARTITION	8	BINARY	6.5.2.2.1
0002h	TAPEALERT FLAGS	8	BINARY	
0003h	LOAD COUNT	8	BINARY	6.5.2.2.2
0004h	MAM SPACE REMAINING	8	BINARY	6.5.2.2.3
0005h	ASSIGNING ORGANIZATION	8	ASCII	
0006h	FORMATTED DENSITY CODE	1	BINARY	6.5.2.2.4
0007h	INITIALIZATION COUNT	2	BINARY	6.5.2.2.5
0008h	Not Supported (VOLUME IDENTIFIER)	32	ASCII	
0009h	VOLUME CHANGE REFERENCE	4	BINARY	6.5.2.2.6
000Ah to 0209h	Reserved			
020Ah	DEVICE VENDOR/SERIAL NUMBER AT LAST LOAD	40	ASCII	6.5.2.2.7
020Bh	DEVICE VENDOR/SERIAL NUMBER AT LOAD-1	40	ASCII	6.5.2.2.7
020Ch	DEVICE VENDOR/SERIAL NUMBER AT LOAD-2	40	ASCII	6.5.2.2.7
020Dh	DEVICE VENDOR/SERIAL NUMBER AT LOAD-3	40	ASCII	6.5.2.2.7
020Eh to 021Fh	Reserved			
0220h	TOTAL MBYTES WRITTEN IN MEDIUM LIFE	8	BINARY	6.5.2.2.8

Table 309 — MAM Device type attributes (part 2 of 2)

Attribute Identifier	Name	Attribute Length (in bytes)	Format	Subclause
0221h	TOTAL MBYTES READ IN MEDIUM LIFE	8	BINARY	6.5.2.2.8
0222h	TOTAL MBYTES WRITTEN IN CURRENT/LAST LOAD	8	BINARY	6.5.2.2.9
0223h	TOTAL MBYTES READ IN CURRENT/LAST LOAD	8	BINARY	6.5.2.2.9
0224h	LOGICAL POSITION OF FIRST ENCRYPTED BLOCK	8	BINARY	6.5.2.2.10
0225h	LOGICAL POSITION OF FIRST UNENCRYPTED BLOCK AFTER THE FIRST ENCRYPTED BLOCK	8	BINARY	6.5.2.2.11
0226h to 033Fh	Reserved			
0340h	Not Supported (MEDIUM USAGE HISTORY)	90	BINARY	
0341h	Not Supported (PARTITION USAGE HISTORY)	60	BINARY	
0342h to 03FFh	Reserved			

**6.5.2.2.1 REMAINING CAPACITY IN PARTITION and MAXIMUM CAPACITY IN PARTITION:** Are native capacities (i.e., assuming no data compression for the specified medium partition). These values are expressed in increments of 1 048 576 bytes (e.g., a value of one means 1 048 576 bytes and a value of two means 2 097 152 bytes).

**6.5.2.2.2 LOAD COUNT:** Indicates how many times this medium has been fully loaded. This attribute should not be reset to zero by any action of the device server. The load counter is a saturating counter.

**6.5.2.2.3 MAM SPACE REMAINING:** Indicates the space currently available in the medium auxiliary memory. The total medium auxiliary memory capacity is reported in the MAM CAPACITY attribute (see 6.5.2.3.8).

NOTE 43 - It may not always be possible to utilize all of the available space in a given medium auxiliary memory implementation.

**6.5.2.2.4 FORMATTED DENSITY CODE:** Indicates the density code of the density to which the medium is currently formatted.

**6.5.2.2.5 INITIALIZATION COUNT:** Indicates the number of times that a device server has logically formatted the medium. This value is cumulative over the life of the medium and is not reset to zero. The initialization counter is a saturating counter.

**6.5.2.2.6 VOLUME CHANGE REFERENCE:** The VOLUME CHANGE REFERENCE attribute indicates changes in the state of the medium related to logical objects or format specific symbols of the currently mounted volume. There is one value for the volume change reference and the VOLUME CHANGE REFERENCE attribute for each partition shall use the same value. The VOLUME CHANGE REFERENCE attribute value shall:

- a) be written to non-volatile medium auxiliary memory before the change on medium is valid for reading; and
- b) change in a non-repeating fashion (i.e., never repeat for the life of the volume) and defined to be in a consistent manner per volume format.

The VOLUME CHANGE REFERENCE attribute value shall change when:

- a) the first logical object for each mount is written on the medium in any partition;
- b) the first logical object is written after GOOD status has been returned for a READ ATTRIBUTE command with the service action field set to ATTRIBUTE VALUES (i.e., 00h) and the first attribute identifier field set to VOLUME CHANGE REFERENCE (i.e., 0009h);
- c) any logical object on the medium (i.e., in any partition) is overwritten; or
- d) the medium is formatted.

The VOLUME CHANGE REFERENCE attribute may change at other times when the contents on the medium change.

The VOLUME CHANGE REFERENCE attribute should not change if the logical objects on the medium do not change.

A value of zero in the VOLUME CHANGE REFERENCE attribute indicates that the medium has not had any logical objects written to it (i.e., the volume is blank and has never been written to) or the value is unknown.

A value of all ones (e.g., 0xFFFF FFFFh) in the VOLUME CHANGE REFERENCE attribute indicates that all values have been used. This value indicates the VOLUME CHANGE REFERENCE value is no longer able to indicate changes to the volume. The device server does not allow further modifications of the medium.

When adding or modifying logical objects the VOLUME CHANGE REFERENCE attribute should only be read after all writing to the volume has completed and been synchronized.

**6.5.2.2.7 DEVICE VENDOR/SERIAL NUMBER AT LAST LOAD, DEVICE VENDOR/SERIAL NUMBER AT LOAD –1, DEVICE VENDOR/SERIAL NUMBER AT LOAD –2 and DEVICE VENDOR/SERIAL NUMBER AT LOAD –3:** Give a history of the last four device servers in which the medium has been loaded. The format of the attributes is shown in table 310.

**Table 310 — DEVICE VENDOR/SERIAL NUMBER MAM attribute format**

Bit Byte	7	6	5	4	3	2	1	0
0	(MSB)							
7	T10 VENDOR IDENTIFICATION							(LSB)
8	(MSB)							
39	PRODUCT SERIAL NUMBER							(LSB)

The T10 VENDOR IDENTIFICATION field shall be the same value returned in the Standard INQUIRY data.

The PRODUCT SERIAL NUMBER field contains ASCII data that is a vendor specific serial number. If the product serial number is not available, the PRODUCT SERIAL NUMBER field shall contain ASCII spaces (20h).

**6.5.2.2.8 TOTAL MBYTES WRITTEN IN MEDIUM LIFE and TOTAL MBYTES READ IN MEDIUM LIFE:**

Indicate the total number of data bytes that are transferred to or from the medium, after any data compression has been applied, over the entire medium life. These values are cumulative and shall not be reset to zero. These values are expressed in MiB ( $2^{20}$ ).

**6.5.2.2.9 TOTAL MBYTES WRITTEN IN CURRENT/LAST LOAD and TOTAL MBYTES READ IN CURRENT/LAST LOAD:** Indicate the total number of data bytes that are transferred to or from the medium, after any data compression has been applied, during the current load if the medium is currently loaded, or the last load if the medium is currently unloaded. The device server should reset these attributes to zero when the medium is loaded. These values are expressed in MiB ( $2^{20}$ ).

**6.5.2.2.10 LOGICAL POSITION OF FIRST ENCRYPTED BLOCK:** Indicates the address of the first logical block on the medium that contains encrypted data.

**6.5.2.2.11 LOGICAL POSITION OF FIRST UNENCRYPTED BLOCK AFTER THE FIRST ENCRYPTED BLOCK:** Indicates the address of the first logical block in the partition that contains unencrypted data and follows the first logical block in the partition that contains encrypted data. If this attribute is supported, then the LOGICAL POSITION OF FIRST ENCRYPTED BLOCK (see 7.3.2.2.9) attribute shall be supported. The attribute value shall be set to FFFF FFFF FFFF FFFFh if the attribute value for the LOGICAL POSITION OF FIRST ENCRYPTED BLOCK is set to:

- a) FFFF FFFF FFFF FFFFh; or

- b) any value other than FFFF FFFF FFFF FFFFh or FFFF FFFF FFFF FFFEh and no logical block in the partition after the first encrypted logical block contains unencrypted data.

The attribute value shall be set to FFFF FFFF FFFF FFFEh if the attribute value for the LOGICAL POSITION OF FIRST ENCRYPTED BLOCK is set to:

- a) FFFF FFFF FFFF FFFEh; or  
 b) any value other than FFFF FFFF FFFF FFFFh or FFFF FFFF FFFF FFFEh and it is unknown whether any logical block in the partition after the first encrypted logical block contains unencrypted data.

### 6.5.2.3 Medium type attributes

Medium type attributes (see table 311) are stored in the medium auxiliary memory by the manufacturer. The device server shall not alter medium type attributes. All supported medium type attributes shall have a status of read only (see 4.20).

**Table 311 — MAM Medium type attributes**

Attribute Identifier	Name	Attribute Length (in bytes)	Format	Subclause
0400h	MEDIUM MANUFACTURER	8	ASCII	6.5.2.3.1
0401h	MEDIUM SERIAL NUMBER	32	ASCII	6.5.2.3.2
0402h	MEDIUM LENGTH	4	BINARY	6.5.2.3.3
0403h	MEDIUM WIDTH	4	BINARY	6.5.2.3.4
0404h	ASSIGNING ORGANIZATION	8	ASCII	6.5.2.3.5
0405h	MEDIUM DENSITY CODE	1	BINARY	6.5.2.3.6
0406h	MEDIUM MANUFACTURE DATE	8	ASCII	6.5.2.3.7
0407h	MAM CAPACITY	8	BINARY	6.5.2.3.8
0408h	MEDIUM TYPE	1	BINARY	6.5.2.3.9
0409h	MEDIUM TYPE INFORMATION	2	BINARY	6.5.2.3.9
040Ah	Not Supported (NUMERIC MEDIUM SERIAL NUMBER)			
040Bh to 04FFh	Reserved			
0500h	SUPPORTED DENSITY CODES	varies	BINARY	6.5.2.3.10
0501h to 07FFh	Reserved			

**6.5.2.3.1 MEDIUM MANUFACTURER:** Contains eight bytes of left-aligned ASCII data identifying the vendor of the media.

**6.5.2.3.2 MEDIUM SERIAL NUMBER:** Contains the manufacturer's serial number for the medium.

**6.5.2.3.3 MEDIUM LENGTH:** Specifies the length of the medium in meters. A value of 0h specifies that the length of the medium is undefined.

**6.5.2.3.4 MEDIUM WIDTH:** Specifies the width of the medium supported by this density. This attribute has units of tenths of millimeters. The value in this attribute shall be rounded up if the fractional value of the actual value is greater than or equal to 0,5. The MEDIUM WIDTH attribute may vary for a given density depending on the mounted volume. A value of 0h specifies the width of the medium is undefined.

**6.5.2.3.5 ASSIGNING ORGANIZATION:** Identifies the organization responsible for the specifications defining the values in the MEDIUM DENSITY CODE attribute. The ASSIGNING ORGANIZATION attribute contains "LTO-CVE".

**6.5.2.3.6 MEDIUM DENSITY CODE:** The MEDIUM DENSITY CODE attribute specifies the DENSITY CODE that is used as the default for the volume.

**Table 312 — Medium density code by product**

Cartridge Type	density code
ULTRIUM 3	44h
ULTRIUM 4	46h
ULTRIUM 5	58h
ULTRIUM 6	5Ah
ULTRIUM 7	5Ch
ULTRIUM M8	5Dh
ULTRIUM 8	5Eh
ULTRIUM 9	60h

**6.5.2.3.7 MEDIUM MANUFACTURE DATE:** Contains the date of manufacture of the medium. The format is YYYYMMDD (i.e., four numeric ASCII characters for the year followed by two numeric ASCII characters for the month followed by two numeric ASCII characters for the day with no intervening spaces).

**6.5.2.3.8 MAM CAPACITY:** Is the total capacity of the medium auxiliary memory, in bytes, at manufacture time. It does not indicate the available space of an unused medium auxiliary memory because some of the medium auxiliary memory space may be reserved for device-specific use making it inaccessible to the application client.

**6.5.2.3.9 MEDIUM TYPE and MEDIUM TYPE INFORMATION:** Give information about non-data media and other types of media. The MEDIUM TYPE INFORMATION attribute is interpreted according to the type of medium indicated by the MEDIUM TYPE (see table 313).

**Table 313 — MEDIUM TYPE and MEDIUM TYPE INFORMATION MAM attributes**

MEDIUM TYPE	Description	MEDIUM TYPE INFORMATION
00h	Data medium	Reserved
01h	Cleaning medium	Maximum number of cleaning cycles permitted
02h to 7Fh	Reserved	Reserved
80h	Write-once medium	Reserved
81h to FFh	Reserved	Reserved

**6.5.2.3.10 SUPPORTED DENSITY CODES (LTO-8+):** The SUPPORTED DENSITY CODES attribute contains a list of supported density codes for the current volume. This list may change depending on the state of the volume. Support for this attribute begins in LTO-8 drives. The SUPPORTED DENSITY CODES attribute ATTRIBUTE VALUE field is defined in table 314.

**Table 314 — SUPPORTED DENSITY CODES attribute format**

Bit Byte	7	6	5	4	3	2	1	0
0	NUMBER OF DENSITY CODES (n)							
1	DENSITY CODE (first)							
...	...							
n	DENSITY CODE (last)							

The NUMBER OF DENSITY CODES field indicates the number of density codes that follow.



The DENSITY CODE field(s) indicate a DENSITY CODE which is supported for the volume. The density codes are in numerical ascending order.

#### 6.5.2.4 Host type attributes

Application clients may use the WRITE ATTRIBUTE and READ ATTRIBUTE commands to maintain the attributes shown in table 315. All existent host type attributes shall have a status of read/write (see 4.20).

**Table 315 — MAM Host type attributes**

Attribute Identifier	Name	Attribute Length (in bytes)	Format	Subclause
0800h	APPLICATION VENDOR	8	ASCII	6.5.2.4.1
0801h	APPLICATION NAME	32	ASCII	6.5.2.4.2
0802h	APPLICATION VERSION	8	ASCII	6.5.2.4.3
0803h	USER MEDIUM TEXT LABEL	160	TEXT	6.5.2.4.4
0804h	DATE AND TIME LAST WRITTEN	12	ASCII	6.5.2.4.5
0805h	TEXT LOCALIZATION IDENTIFIER	1	BINARY	6.5.2.4.6
0806h	BARCODE	32	ASCII	6.5.2.4.7
0807h	OWNING HOST TEXTUAL NAME	80	TEXT	6.5.2.4.8
0808h	MEDIA POOL	160	TEXT	6.5.2.4.9
0809h	Not Supported (PARTITION USER TEXT LABEL)			
080Ah	Not Supported (LOAD/UNLOAD AT PARTITION)			
080Bh	APPLICATION FORMAT VERSION	16	ASCII	6.5.2.4.10
080Ch	VOLUME COHERENCY INFORMATION	Not Specified	BINARY	6.5.2.4.11
0820h	MEDIUM GLOBALLY UNIQUE IDENTIFIER	36	BINARY	6.5.2.4.12
0821h	MEDIA POOL GLOBALLY UNIQUE IDENTIFIER	36	BINARY	6.5.2.4.13
others between 0800h and BFFh	Reserved			

**6.5.2.4.1 APPLICATION VENDOR:** Contains eight bytes of left-aligned ASCII data identifying the manufacturer of the application client (e.g., class driver or backup program) that last sent a WRITE ATTRIBUTE command to the device server while this medium auxiliary memory was accessible. The application vendor shall be a T10 vendor identification assigned by INCITS. A list of assigned T10 vendor identifications is on the T10 web site (<http://www.T10.org>).

**6.5.2.4.2 APPLICATION NAME:** Contains the name of the application client.

**6.5.2.4.3 APPLICATION VERSION:** Contains the version of the application client.

**6.5.2.4.4 USER MEDIUM TEXT LABEL:** Contains the user level identifier for the medium.

**6.5.2.4.5 DATE & TIME LAST WRITTEN:** Contains when the application client last wrote to the medium auxiliary memory. The format is YYYYMMDDHHMM (i.e., four numeric ASCII characters for the year followed by two numeric ASCII characters for the month followed by two numeric ASCII characters for the day followed by two numeric ASCII characters between 00 and 24 for the hour followed by two numeric ASCII characters for the minute with no intervening spaces).

**6.5.2.4.6 TEXT LOCALIZATION IDENTIFIER:** Defines the character set (see table 316) used for attributes with a TEXT format (see 6.5.1).

**Table 316 — TEXT LOCALIZATION IDENTIFIER MAM attribute values**

Value	Meaning
00h	No code specified (ASCII)
01h	ISO/IEC 8859-1 (Europe, Latin America)
02h	ISO/IEC 8859-2 (Eastern Europe)
03h	ISO/IEC 8859-3 (SE Europe/miscellaneous)
04h	ISO/IEC 8859-4 (Scandinavia/Baltic)
05h	ISO/IEC 8859-5 (Cyrillic)
06h	ISO/IEC 8859-6 (Arabic)
07h	ISO/IEC 8859-7 (Greek)
08h	ISO/IEC 8859-8 (Hebrew)
09h	ISO/IEC 8859-9 (Latin 5)
0Ah	ISO/IEC 8859-10 (Latin 6)
0Bh to 7Fh	Reserved
80h	ISO/IEC 10646-1 (UCS-2BE)
81h	ISO/IEC 10646-1 (UTF-8)
82h to FFh	Reserved

**6.5.2.4.7 BARCODE:** Is contents of a barcode associated with the medium in the medium auxiliary memory.

**6.5.2.4.8 OWNING HOST TEXTUAL NAME:** Indicates the host from which that USER MEDIUM TEXT LABEL (see 6.5.2.4.4) originates.

**6.5.2.4.9 MEDIA POOL:** Indicates the media pool to which this medium belongs.

**6.5.2.4.10 APPLICATION FORMAT VERSION:** Indicates the version of the format being used by the application that set this attribute.

**6.5.2.4.11 VOLUME COHERENCY INFORMATION:** Contains information used to maintain coherency of information on a volume (see 4.21). The VOLUME COHERENCY INFORMATION attribute ATTRIBUTE VALUE field is defined in table 317

**Table 317: VOLUME COHERENCY INFORMATION MAM attribute format**

Byte	Bit							
	7 msb	6	5	4	3	2	1	0 lsb
0	VOLUME CHANGE REFERENCE VALUE LENGTH (n)							
1	VOLUME CHANGE REFERENCE VALUE							
n								
n+1	VOLUME COHERENCY COUNT							
n+8								
n+9	VOLUME COHERENCY SET IDENTIFIER							
n+16								
n+17	APPLICATION CLIENT SPECIFIC INFORMATION LENGTH (y-(n+18))							
n+18								
n+19	APPLICATION CLIENT SPECIFIC INFORMATION							
y								

The contents of the VOLUME CHANGE REFERENCE VALUE field, the VOLUME COHERENCY SET IDENTIFIER field, the VOLUME COHERENCY COUNT field, and the APPLICATION CLIENT SPECIFIC INFORMATION field are described in 4.21.

The VOLUME CHANGE REFERENCE VALUE LENGTH field contains the length of the VOLUME CHANGE REFERENCE VALUE field.

**6.5.2.4.12 MEDIUM GLOBALLY UNIQUE IDENTIFIER:** This attribute contains a globally unique identifier for the medium that is assigned by the application identified in the APPLICATION NAME (see 6.5.2.4.2) attribute.

**6.5.2.4.13 MEDIA POOL GLOBALLY UNIQUE IDENTIFIER:** This attribute contains a globally unique identifier for the media pool that is assigned by the application identified in the APPLICATION NAME (see 6.5.2.4.2) attribute.

### 6.5.2.5 Vendor-Specific Medium Type Attributes

Table 318 describes the vendor-specific medium type attributes. Application clients may use the READ ATTRIBUTE command to read the contents of the attributes shown in the table.

**Table 318 — MAM Vendor-Specific Medium Type Attributes**

Attribute Identifier	Name	Attribute Length (in bytes)	Format	Subclause
1000h	UNIQUE CARTRIDGE IDENTITY (UCI)	28	Binary	6.5.2.5.1
1001h	ALTERNATE UNIQUE CARTRIDGE IDENTITY (Alt-UCI)	24	Binary	6.5.2.5.2
1010h	MEDIUM OPTIMIZATION NEEDED	1	Binary	6.5.2.5.3
1011h	MEDIUM OPTIMIZATION VERSION	1	Binary	6.5.2.5.4
1100h	TOTAL TAPE MOTION METERS	8	Binary	6.5.2.5.5
others	Reserved			

**6.5.2.5.1 UNIQUE CARTRIDGE IDENTITY (UCI):** The UNIQUE CARTRIDGE IDENTITY (UCI) attribute is read only. Any attempt to access it using the WRITE ATTRIBUTE command is rejected by the drive with a CHECK CONDITION status with the Sense Key set to ILLEGAL REQUEST and the additional sense code set to INVALID FIELD IN PARAMETER LIST (i.e., 5/2600h). If the cartridge has inconsistency between the various sources from which the components of the UCI are derived, then a command to read the UCI is rejected with a CHECK CONDITION status with the Sense Key set to MEDIUM ERROR and additional sense code set to AUXILIARY MEMORY READ ERROR (i.e., 3/1112h). This error is also reported if the cartridge has not been initialized.

**6.5.2.5.2 ALTERNATE UNIQUE CARTRIDGE IDENTITY (Alt-UCI):** The ALTERNATE UNIQUE CARTRIDGE IDENTITY (Alt-UCI) attribute is read only and reported for both an initialized cartridge and an uninitialized cartridge. Any attempt to access it using the WRITE ATTRIBUTE command is rejected by the drive with a CHECK CONDITION status with the Sense Key set to ILLEGAL REQUEST and the additional sense code set to INVALID FIELD IN PARAMETER LIST (i.e., 5/2600h). If the cartridge has inconsistency between the various sources from which the components of the Alt-UCI are derived, then a command to read the Alt-UCI is rejected with a CHECK CONDITION status with the Sense Key set to MEDIUM ERROR and additional sense code set to AUXILIARY MEMORY READ ERROR (i.e., 3/1112h).

**6.5.2.5.3 MEDIUM OPTIMIZATION NEEDED:** The MEDIUM OPTIMIZATION NEEDED attribute indicates if the volume needs to be characterized. A non-zero value indicates that a volume optimization is needed. A value of zero indicates a volume optimization has been completed. This attribute is read/write and reported for both an initialized cartridge and an uninitialized cartridge. A WRITE ATTRIBUTE command is accepted if:

- a) the cartridge is a supported cartridge type;
- b) the tape is initialized;
- c) the tape has no user data (i.e., EOD is at Logical Object Identifier zero);
- d) the tape has a single partition; and
- e) the ATTRIBUTE VALUE field is set to one,

else the WRITE ATTRIBUTE command is rejected with a CHECK CONDITION status with the Sense Key set to ILLEGAL REQUEST and the additional sense code set to INVALID FIELD IN PARAMETER LIST (i.e., 5/2600h). If this attribute is not supported (e.g., Ultrium 8 cartridge), this attribute is in the non-existent state.

**6.5.2.5.4 MEDIUM OPTIMIZATION VERSION:** The MEDIUM OPTIMIZATION VERSION attribute reports the version of the optimization that was last performed on this volume. It is read only and reported for an initialized cartridge. Any attempt to access it using the WRITE ATTRIBUTE command is rejected by the drive with a CHECK CONDITION status with the Sense Key set to ILLEGAL REQUEST and the additional sense code set to INVALID FIELD IN PARAMETER LIST (i.e., 5/2600h). If the cartridge is not initialized or this attribute is not supported (e.g., Ultrium 8 cartridge), then this attribute is in the non-existent state.

**6.5.2.5.5 TOTAL TAPE MOTION METERS:** Indicates the number of meters the tape medium in this cartridge has been moved. This attribute is read only. Any attempt to access it using the WRITE ATTRIBUTE command is rejected with a CHECK CONDITION status with the Sense Key set to ILLEGAL REQUEST and the additional sense code set to INVALID FIELD IN PARAMETER LIST (i.e., 5/2600h). If the cartridge has not been initialized, then a command to read this attribute is rejected with CHECK CONDITION status with the Sense Key set to ILLEGAL REQUEST and the additional sense code set to INVALID FIELD IN CDB (i.e., 5/2400h).

## 6.6 Mode Parameters (MP)

Mode parameters are used with the MODE SELECT (6/10) - 15h/55h (see 5.2.10) commands and the MODE SENSE (6/10) - 1Ah/5Ah (see 5.2.11) commands. Mode Page Behaviors (see 4.7 on page 39) describes this device's non-standard behaviors related to mode parameters.

### 6.6.1 Mode Parameter List for Mode Select (6/10)

For Mode Select (6) the mode pages are preceded by a 4-byte mode parameter header below, and an optional 8-byte block descriptor (see 6.6.2.2). Table 319 shows the format of the mode parameter list for Mode Select (6).

**Table 319 — Mode Parameter List for Mode Select (6)**

Byte	Bit							
	7 msb	6	5	4	3	2	1	0 lsb
0	Mode Parameter Header							
3								
4								
4+n-1	Block Descriptor (n = 0 or n = 8; if n=0 Block Descriptor does not exist)							
4+n	Mode Pages							
n								

For Mode Select (10) the mode pages are preceded by a 8-byte mode parameter header (see “Mode Parameter Header for Mode Select (6/10)” on page 359) and an optional 8-byte block descriptor (see “Block Descriptor for Mode Select (6/10)” on page 361). Mode page descriptions begin at “MP 01h: Read-Write Error Recovery” on page 366.

Table 320 shows the format of the mode parameter list for Mode Select (10).

**Table 320 — Mode Parameter List for Mode Select (10)**

Byte	Bit							
	7 msb	6	5	4	3	2	1	0 lsb
0	Mode Parameter Header							
7								
8								
8+n-1	Block Descriptor (n = 0 or n = 8; if n=0 Block Descriptor does not exist)							
8+n	Mode Pages							
n								

#### 6.6.1.1 Mode Parameter Header for Mode Select (6/10)

There is one copy of the mode parameter header for each initiator. Mode parameter header and block descriptor policy (see 4.7.1.1 on page 39) describes this devices non-standard behavior related to fields in the header.

Note that mounting a volume that modifies the value of fields in the mode parameter header does not establish a unit attention condition.

Table 321 shows the format of the mode parameter header for Mode Select (6).

**Table 321 — Mode Parameter Header for Mode Select (6)**

Byte	Bit							
	7 msb	6	5	4	3	2	1	0 lsb
0	Reserved (Mode Data Length)							
1	Medium Type							
2	WP	Buffer Mode			Speed			
3	Block Descriptor Length							

Table 322 shows the format of the mode parameter header for Mode Select (10).

**Table 322 — Mode Parameter Header for Mode Select (10)**

Byte	Bit							
	7 msb	6	5	4	3	2	1	0 lsb
0	MSB	Reserved (Mode Data Length)						LSB
1	Reserved							
2	Medium Type							
3	WP	BUFFERED MODE			SPEED			
4	Reserved							
5	Reserved							
6	MSB	BLOCK DESCRIPTOR LENGTH						LSB
7	Reserved							

Mode parameter header field descriptions follow:

**Byte Description**

0-1 Reserved (Mode Data Length): must be zero.

2 MEDIUM TYPE: (changeable-ignored)

Value	Description
00h	No volume is loaded
18h	Ultrium 1 Data volume is loaded
28h	Ultrium 2 Data volume is loaded
38h	Ultrium 3 Data volume is loaded
3Ch	Ultrium 3 WORM volume is loaded
48h	Ultrium 4 Data volume is loaded
4Ch	Ultrium 4 WORM volume is loaded
58h	Ultrium 5 Data volume is loaded
5Ch	Ultrium 5 WORM volume is loaded
68h	Ultrium 6 Data volume is loaded
6Ch	Ultrium 6 WORM volume is loaded
78h	Ultrium 7 Data volume is loaded
7Ch	Ultrium 7 WORM volume is loaded
88h	Ultrium 8 Data volume is loaded
8Ch	Ultrium 8 WORM volume is loaded
98h	Ultrium 9 Data volume is loaded
9Ch	Ultrium 9 WORM volume is loaded

## 3 Device-Specific Parameter - Sequential Access Devices

**Bit Description**

- 7 WP: (changeable-ignored)  
 6-4 BUFFERED MODE: 001b <Shared> (changeable)

Value	Description
000b	Good status is reported when data on medium
001b	Good status is reported when data is in buffer
010b	Not supported
011b - 111b	Reserved

- 3-0 SPEED: 0h (use default read/write speed) <Shared> (changeable)

In this drive, contrary to the standards, speed 1h is the fastest speed and higher numbers are progressively slower speeds.

===== **WARNING** =====

Setting the SPEED field to a value other than 0h (i.e., selecting a specific speed) is not recommended. The drive is designed to dynamically select the optimal speed to achieve maximum systemic performance. This is based on complex criteria including interface bandwidth, host throughput, data compressibility, etc.

===== **WARNING** =====

- 4-5 Reserved  
 6-7 BLOCK DESCRIPTOR LENGTH: <Per I\_T nexus> (changeable)

Value	Description
0000h	No block descriptor follows
0008h	A single block descriptor follows

**6.6.1.2 Block Descriptor for Mode Select (6/10)**

The presence of the block descriptor in the Mode Select command depends on the value of the Block Descriptor Length in the mode parameter header. There is one copy of the block descriptor for each initiator. Table 323 shows the format of the block descriptor. The format of the block descriptor is the same for Mode Select (6) and Mode Select (10). Mode parameter header and block descriptor policy (see 4.7.1.1 on page 39) describes this devices non-standard behavior related to fields in the block descriptor.

Note that mounting a volume that modifies the value of fields in the block descriptor does not establish a unit attention condition.

**Table 323 — Block Descriptor for Mode Select**

Byte	Bit							
	7 msb	6	5	4	3	2	1	0 lsb
0	DENSITY CODE							
1	MSB	NUMBER OF BLOCKS						LSB
3	Reserved							
4	MSB	BLOCK LENGTH						LSB
5	BLOCK LENGTH							
7	BLOCK LENGTH							

The block descriptor field definitions follow:

### Byte Description

0 DENSITY CODE: REPORT DENSITY SUPPORT - 44h (see 5.2.26 on page 138) provides additional information (changeable-ignored)

Value	Description
00h	The density is unidentified for one of the following reasons: <ul style="list-style-type: none"> <li>• No medium present</li> <li>• Unknown/Unsupported medium present</li> </ul>
40h	Ultrium 1 density
42h	Ultrium 2 density
44h	Ultrium 3 density
46h	Ultrium 4 density
58h	Ultrium 5 density
5Ah	Ultrium 6 density
5Ch	Ultrium 7 density
5Dh	Ultrium M8 density
5Eh	Ultrium 8 density
60h	Ultrium 9 density
7Fh	Do not change density (set only - NOOP)
FFh	Use current medium density (set only)

1-3 NUMBER OF BLOCKS: 000000h (non-changeable)

4 Reserved

5-7 BLOCK LENGTH: 000000h <Per I\_T nexus> (changeable)

Any value of block length can be specified between the minimum and the maximum block lengths, inclusive, specified in the Read Block Limits command.

A Block Length value of 000000h indicates that the logical block size to be written to or read from the medium must be explicitly specified by the Transfer Length field in the CDB and the fixed bit must be 0b (see READ - 08h (see 5.2.15 on page 107), VERIFY (6) - 13h (see 5.2.41 on page 176), and WRITE - 0Ah (see 5.2.42 on page 178)). Additionally the read-type overlength ILI reporting is suppressed as described in General Read-Type Handling (see 4.12.1 on page 47).

### 6.6.2 Mode Parameter List for Mode Sense (6/10)

For Mode Sense (6) the mode pages are preceded by a 4-byte mode parameter header below and an optional block descriptor. If the DBD field is 0b, an 8-byte block descriptor follows the mode parameter header (see “Block Descriptor for Mode Sense (6/10)” on page 364). If the DBD field is 1b, the block descriptor is not present and the first mode page follows the mode parameter header. Table 324 shows the format of the mode parameter list.

**Table 324 — Mode Parameter List for Mode Sense (6)**

Byte	Bit							
	7 msb	6	5	4	3	2	1	0 lsb
0	Mode Parameter Header							
3								
4	Block Descriptor (if DBD = 0b, then n = 8 and m=12, else (i.e., DBD = 1b), n = 0, and m = 4)							
4+n-1								
m	Mode Pages							
p								

For Mode Sense (10) the mode pages are preceded by an 8-byte mode parameter header (see “Mode Parameter Header for Mode Sense (6/10)” on page 363) and an optional block descriptor. If the DBD field is 0b, an 8-byte block descriptor follows the mode parameter header (see “Block Descriptor for Mode Select (6/10)” on



page 361). If the DBD field is 1b, the block descriptor is not present and the first mode page follows the mode parameter header. Mode page descriptions begin at “MP 01h: Read-Write Error Recovery” on page 366. Table 325 shows the format of the mode parameter list.

**Table 325 — Mode Parameter List for Mode Sense (10)**

Byte	Bit							
	7 msb	6	5	4	3	2	1	0 lsb
0	Mode Parameter Header							
7								
8	Block Descriptor (if DBD = 0b, then n = 8 and m=16, else (i.e., DBD = 1b) n = 0, and m = 8)							
8+n-1								
m	Mode Pages							
p								

### 6.6.2.1 Mode Parameter Header for Mode Sense (6/10)

There is one copy of the mode parameter header for each initiator. Table 326 shows the format of the mode parameter header for Mode Sense (6).

Note that mounting a volume that modifies the value of fields in the mode parameter header does not establish a unit attention condition.

**Table 326 — Mode Parameter Header for Mode Sense (6)**

Byte	Bit							
	7 msb	6	5	4	3	2	1	0 lsb
0	MODE DATA LENGTH							
1	MEDIUM TYPE							
2	WP	BUFFERED MODE			SPEED			
3	BLOCK DESCRIPTOR LENGTH							

Table 327 shows the format of the mode parameter header for Mode Sense (10).

**Table 327 — Mode Parameter Header for Mode Sense (10)**

Byte	Bit							
	7 msb	6	5	4	3	2	1	0 lsb
0	MSB	MODE DATA LENGTH						LSB
1								
2	MEDIUM TYPE							
3	WP	BUFFERED MODE			SPEED			
4	MSB	Reserved						LSB
5								
6	MSB	BLOCK DESCRIPTOR LENGTH						LSB
7								

Mode parameter header field descriptions follow:

**Byte Description**

- 0-1 MODE DATA LENGTH  
The length in bytes of the following data that is available to be transferred. The mode data length does not include itself; that is, the length value is total length of the data available minus the size of this field (1 or 2, depending on Mode Sense (6) or (10), respectively).
- 2 MEDIUM TYPE: See 6.6.1.1 Mode Parameter Header for Mode Select (6/10)
- 3 Device-Specific Parameter - Sequential Access Devices See 6.6.1.1 Mode Parameter Header for Mode Select (6/10)
- 4-5 Reserved
- 6-7 BLOCK DESCRIPTOR LENGTH: See 6.6.1.1 Mode Parameter Header for Mode Select (6/10)

**6.6.2.2 Block Descriptor for Mode Sense (6/10)**

The presence of the block descriptor in the MODE SENSE command depends on the value of the DBD bit in the CDB. There is one copy of the block descriptor for each initiator. Table 328 shows the format of the block descriptor.

Note that mounting a volume that modifies the value of fields in the block descriptor does not establish a unit attention condition.

**Table 328 — Block Descriptor for Mode Sense (10) or Mode Sense (6)**

Byte	Bit							
	7 msb	6	5	4	3	2	1	0 lsb
0	DENSITY CODE							
1	NUMBER OF BLOCKS							
3								
4	Reserved							
5	BLOCK LENGTH							
7								

The block descriptor definition is shown in Block Descriptor for Mode Select (6/10) (see 6.6.1.2 on page 361)

**6.6.3 Mode Page Format**

Table 329 shows the format of mode pages that do not use subpages.

**Table 329 — Mode Page Format**

Byte	Bit							
	7 msb	6	5	4	3	2	1	0 lsb
0	PS	SPF(0b)	PAGE CODE					
1	PAGE LENGTH (n-1)							
2	Mode Parameters							
n								

Table 330 shows the format of mode pages that use subpages.

**Table 330 — Mode Page Subpage Format**

Byte	Bit							
	7 msb	6	5	4	3	2	1	0 lsb
0	PS	SPF(1b)	PAGE CODE					
1	SUBPAGE CODE							
2	(MSB)	PAGE LENGTH (n-3)						(LSB)
3								
4	Mode Parameters							
n								

The individual mode page descriptions that follow include the field descriptions. Each field is non-changeable unless specifically identified otherwise.

For those mode pages that allow saving of at least one parameter, the PS (Parameter Saveable) bit is returned in a MODE SENSE with a value of 1b. For those mode pages that do not allow saving of at least one parameter, the PS bit is returned in a MODE SENSE with a value of 0b. The PS bit is ignored in the parameter data transferred with a MODE SELECT command.

#### 6.6.4 Supported Mode Pages

The following standards-based mode pages are supported

- MP 01h: Read-Write Error Recovery (see 6.6.5 on page 366)
- MP 02h: Disconnect-Reconnect (see 6.6.6 on page 367)
- MP 0Ah: Control (see 6.6.7 on page 369)
- MP 0Ah[01h]: Control Extension (see 6.6.8 on page 370)
- MP 0Ah[F0h]: Control Data Protection (see 6.6.9 on page 371)
- MP 0Fh: Data Compression (see 6.6.10 on page 373)
- MP 10h: Device Configuration (see 6.6.11 on page 375)
- MP 10h[01h]: Device Configuration Extension (see 6.6.12 on page 377)
- MP 11h: Medium Partition Page (see 6.6.13 on page 380)
- MP 18h: Protocol-Specific Logical Unit (see 6.6.14 on page 385)
- MP 19h: Protocol specific port (see 6.6.15 on page 386)
- MP 1Ah: Power Condition (see 6.6.16 on page 389)
- MP 1Ch: Informational Exceptions Control (see 6.6.17 on page 390)
- MP 1Dh: Medium Configuration (see 6.6.18 on page 392)

The following vendor-specific mode pages are also supported

- MP 24h: Vendor-Specific (see 6.6.19 on page 393)
- MP 2Fh: Behavior Configuration (see 6.6.20 on page 397)
- MP 30h: Device Attribute Settings (see 6.6.21 on page 400)
- MP 30h[01h]: Drive MAC address - Device attribute settings (see 6.6.21.3.2 on page 405)
- MP 30h[02h]: Drive IP address and subnet mask - Device attribute settings (see 6.6.21.3.3 on page 407)
- MP 30h[20h]: Encryption mode - Device Attribute Settings (see 6.6.21.4.1 on page 409)
- MP 30h[40h]: SkipSync - Device attribute settings (see 6.6.21.5.1 on page 411)
- MP 30h[42h]: End of partition behavior control - Device attribute settings (see 6.6.21.5.2 on page 414)
- MP 30h[43h]: Feature switches - Device attribute settings (see 6.6.21.5.3 on page 415)
- MP 30h[44h]: Preferred Cartridge Type — Device attribute settings (see 6.6.21.5.4 on page 417)
- MP 3Eh: Engineering Support (see 6.6.22 on page 419)
- Mode Page 3Fh: All Pages

NOTE 44 - Mode page 3Eh is for engineering use only and is not included in page 3Fh

### 6.6.5 MP 01h: Read-Write Error Recovery

See MODE SELECT (6/10) - 15h/55h (see 5.2.10 on page 95) for how to set these parameters and MODE SENSE (6/10) - 1Ah/5Ah (see 5.2.11 on page 96) for how to read these parameters. Mode Page Behaviors (see 4.7 on page 39) describes this device's non-standard behaviors related to mode parameters.

The mode page policy for this page is described in Policy — non-standard (see 4.7.1 on page 39).

The Read-Write Error Recovery mode page (see table 331) specifies the error recovery and reporting parameters that the device server shall use when transferring data between the device and the medium. These parameters do not affect protocol-level recovery procedures or positioning error recovery procedures.

NOTE 45 - The parameters in the Read-Write Error Recovery mode page also apply to verify operations.

**Table 331 — MP 01h Read-Write Error Recovery mode page**

Byte	Bit							
	7 msb	6	5	4	3	2	1	0 lsb
0	PS	SPF(0)	PAGE CODE (01h)					
1	PAGE LENGTH (0Ah)							
2	Reserved		TB	Rsvd	EER	PER	DTE	DCR
3	READ RETRY COUNT							
4	Reserved							
5	Reserved							
6	Reserved							
7	Reserved							
8	WRITE RETRY COUNT							
9	Reserved							
10	Reserved							
11	Reserved							

#### Byte Description

0	<b>Bit</b>	<b>Description</b>
	7	PS (Parameter Saveable): 0b. Ignored in MODE SELECT. See Parameter Saveable behavior in 4.7.2.2 on page 41
	6	Reserved
	5-0	PAGE CODE: 01h
1		PAGE LENGTH: 0Ah

2

<b>Bit</b>	<b>Description</b>
7-6	Reserved
5	TB (Transfer Block): 1b (non-changeable)
4	Reserved
3	EER (Enable Early Recovery): 1b (non-changeable)
2	PER (Post Error): 0b (changeable)
	<b>Value            Description</b>
	0b                The device does not create CHECK CONDITION status for Recovered Errors except for non-deferred sense data of:
	— 1/0017 (Recovered Error, DRIVE NEEDS CLEANING) for a LOAD UNLOAD command
	— 1/3700 (Recovered Error, ROUNDED PARAMETER) for a MODE SELECT command, and
	— 1/8383 (Recovered Error, DRIVE HAS BEEN CLEANED) for a LOAD UNLOAD command.
	1b                The device will report a CHECK CONDITION status for all recovered data and non-data errors with a sense key of 1 in non-deferred sense data as well as deferred sense data.
1	DTE (Disable Transfer on Error): 0b (non-changeable)
0	DCR (Disable Correction): 0b (non-changeable)
3	READ RETRY LIMIT: FFh (approximate maximum read recovery limit in seconds) (changeable)
	<b>Value            Description</b>
	05h                Limited error recovery; < 5 seconds. This limits the number of ERP recipes tried, not time.
	FFh                Full Recovery Routines allowed (no time limit).
	XXh                All other values may be rounded (to non-FFh).
4-7	Reserved
8	WRITE RETRY LIMIT: FFh (approximate maximum write recovery limit in seconds) (changeable)
	<b>Value            Description</b>
	02h                Limited error recovery; < 2 seconds. This limits the number of ERP recipes tried, not time.
	05h                Limited error recovery; < 5 seconds. This limits the number of ERP recipes tried, not time.
	FFh                Full Recovery Routines allowed (no time limit).
	XXh                All other values may be rounded (to non-FFh).
9-11	Reserved

### 6.6.6 MP 02h: Disconnect-Reconnect

See MODE SELECT (6/10) - 15h/55h (see 5.2.10 on page 95) for how to set these parameters and MODE SENSE (6/10) - 1Ah/5Ah (see 5.2.11 on page 96) for how to read these parameters. Mode Page Behaviors (see 4.7 on page 39) describes this device's non-standard behaviors related to mode parameters.

The mode page policy for this page is described in Policy — non-standard (see 4.7.1 on page 39).

Table 332 — MP 02h Disconnect-Reconnect mode page

Byte	Bit							
	7 msb	6	5	4	3	2	1	0 lsb
0	PS	SPF (0b)	PAGE CODE (02h)					
1	PAGE LENGTH (0Eh)							
2	buffer full ratio							
3	buffer empty ratio							
4	(MSB)	bus inactivity limit						(LSB)
5								
6	(MSB)	disconnect time limit						(LSB)
7								
8	(MSB)	connect time limit						(LSB)
9								
10	(MSB)	maximum burst size						(LSB)
11								
12	EMDP	FAIR ARBITRATION			DIMM	DTDC		
13	Reserved							
14	(MSB)	first burst size						(LSB)
15								

## Byte Description

0

**Bit Description**

7 PS (Parameter Saveable): 0b. Ignored in MODE SELECT. See Parameter Saveable behavior in 4.7.2.2 on page 41.

6 Reserved

5-0 PAGE CODE: 02h

1 PAGE LENGTH: 0Eh

2 BUFFER FULL RATIO: 00h (non-changeable)

3 BUFFER EMPTY RATIO: 00h (non-changeable)

4-5 BUS INACTIVITY LIMIT: (non-changeable)

6-7 DISCONNECT TIME LIMIT: 0000h (no limit) (non-changeable)

8-9 CONNECT TIME LIMIT: (non-changeable)

10-11 MAXIMUM BURST SIZE: 0000h (no limit) (changeable)

This value is changeable and remembered, but not used.

12

**Bit Description**

7 EMDP (Enable Modify Data Pointers): 0b (non-changeable)

6-4 FAIR ARBITRATION: 000b (non-changeable)

3 DIMM (Disconnect Immediate): 0b (non-changeable)

2-0 DTDC (Data Transfer Disconnect Word): 000b (non-changeable)

13 Reserved

14-15 First Burst Size: 0000h (non-changeable)

### 6.6.7 MP 0Ah: Control

See MODE SELECT (6/10) - 15h/55h (see 5.2.10 on page 95) for how to set these parameters and MODE SENSE (6/10) - 1Ah/5Ah (see 5.2.11 on page 96) for how to read these parameters. Mode Page Behaviors (see 4.7 on page 39) describes this device's non-standard behaviors related to mode parameters.

The mode page policy for this page is described in Policy — non-standard (see 4.7.1 on page 39).

**Table 333 — MP 0Ah Control mode page**

Byte	Bit							
	7 msb	6	5	4	3	2	1	0 lsb
0	PS	SPF (0b)	PAGE CODE (0Ah)					
1	PAGE LENGTH (0Ah)							
2	TST			Reserved			GLTSD	RLEC
3	QUEUE ALGORITHM MODIFIER				Reserved		QERR	DQUE
4	Reserved	RAC	Reserved			RAERP	UAAERP	EAERP
5	Reserved					AUTOLOAD MODE		
6	(MSB)							
7	READY AEN HOLDOFF PERIOD							(LSB)
8	(MSB)							
9	BUSY TIME-OUT PERIOD							(LSB)
10	(MSB)							
11	Reserved							(LSB)

#### Byte Description

0

##### Bit Description

7 PS (Parameter Saveable): 0b. Ignored in MODE SELECT. See Parameter Saveable behavior in 4.7.2.2 on page 41.

6 SPF: 0b

5-0 Page Code: 0Ah

1 Page Length: 0Ah

2

##### Bit Description

7-5 TST (Task Set Type): 000b (non-changeable)

4-2 Reserved

1 GLTSD (Global Logging Target Save Disable): 0b (non-changeable)

0 RLEC (Report Log Exception Condition): 0b (non-changeable)

3

##### Bit Description

7-4 QUEUE ALGORITHM MODIFIER: 0000b (non-changeable)

3-2 Reserved

1 QERR (Queue Error): 0b (non-changeable)

0 DQUE (Disable Queuing): 1b (non-changeable)

4

Bit	Description
7	Reserved
6	RAC (Report A Check): 0b (non-changeable)
5-3	Reserved
2	RAERP (Ready Asynchronous Event Reporting): 0b (non-changeable)
1	UAAERP (Unit Attention Asynchronous Event Reporting): 0b (non-changeable)
0	EAERP (Error Asynchronous Event Reporting): 0b (non-changeable)

5

Bit	Description
7-3	Reserved
2-0	AUTOLOAD MODE: 000b (changeable)

Some medium changers may silently override AUTOLOAD MODE.

Value	Description
000b	Medium is loaded for full access.
001b	Medium is loaded for MAM access only (i.e., load hold position).
010b	Medium is not allowed to be loaded.

===== WARNING ===== WARNING =====

Setting AUTOLOAD MODE to a value of 010b may cause problems for medium changers (e.g., fail move medium commands, interference with pickers, etc.)

===== WARNING ===== WARNING =====

others Reserved.

6-7	READY AEN HOLDOFF PERIOD: 0000h (non-changeable) If AEN is disabled (Byte 4 bit 2 = 0b), this field is not meaningful.
8-9	BUSY TIME-OUT PERIOD: FFFFh (non-changeable)
10	Reserved
11	Reserved

### 6.6.8 MP 0Ah[01h]: Control Extension

See MODE SELECT (6/10) - 15h/55h (see 5.2.10 on page 95) for how to set these parameters and MODE SENSE (6/10) - 1Ah/5Ah (see 5.2.11 on page 96) for how to read these parameters. Mode Page Behaviors (see 4.7 on page 39) describes this device's non-standard behaviors related to mode parameters.

The mode page policy for this page is described in Policy — non-standard (see 4.7.1 on page 39).



Table 334 — MP 0Ah[01h] Control Extension mode page

Byte	Bit							
	7 msb	6	5	4	3	2	1	0 lsb
0	PS	SPF (1b)	PAGE CODE (0Ah)					
1	SUBPAGE CODE (01h)							
2	(MSB)	PAGE LENGTH (1Ch)						(LSB)
3								
4	Reserved					TCMOS	SCSIP	IALUAE
5	Reserved				INITIAL COMMAND PRIORITY			
6	Reserved							
31	Reserved							

**Byte Description**

0

Bit	Description
7	PS (Parameter Saveable): 0b. Ignored in MODE SELECT. See Parameter Saveable behavior in 4.7.2.2 on page 41.
6	SPF: 1b
5-0	PAGE CODE: 0Ah

1 SUBPAGE CODE: 01h

2-3 PAGE LENGTH: 1Ch

4

**Bit Description**

7-3 Reserved

2 TCMOS (Timestamp Changeable by Methods Outside this Standard) (non-changeable)

A TCMOS bit set to one specifies that the timestamp may be initialized by methods outside the scope of this standard (for example The LDI Set Timestamp command). A TCMOS bit set to zero specifies that the timestamp shall not be changed by any method except those defined by this standard.

1 SCSIP (SCSI precedence) (changeable)

A SCSIP bit set to one specifies that the timestamp changed using a SET TIMESTAMP command takes precedence over methods outside the scope of this standard (for example the LDI Set Timestamp command). A SCSIP bit set to zero specifies that methods outside this standard (for example the LDI Set Timestamp command) may change the timestamp and that the SET TIMESTAMP command is illegal.

0 IALUAE (implicit asymmetric logical unit access enabled): 0b (non-changeable)

5

**Bit Description**

7-4 Reserved

3-0 INITIAL COMMAND PRIORITY: 0h (non-changeable)

6-31 Reserved

**6.6.9 MP 0Ah[F0h]: Control Data Protection**

See MODE SELECT (6/10) - 15h/55h (see 5.2.10 on page 95) for how to set these parameters and MODE SENSE (6/10) - 1Ah/5Ah (see 5.2.11 on page 96) for how to read these parameters. Mode Page Behaviors (see 4.7 on page 39) describes this device's non-standard behaviors related to mode parameters.

The Control Data Protection mode page provides controls that allow selective use of logical block protection. Logical block protection (see 4.9 on page 43) describes how this page is used to control logical block protection.

The mode page policy for this page is described in Policy — non-standard (see 4.7.1 on page 39).

**Table 335 — MP 0Ah[F0h] Control Data Protection mode page format**

Byte	Bit								
	7	6	5	4	3	2	1	0	
0	PS	SPF(1b)	PAGE CODE (0Ah)						
1	SUBPAGE CODE (F0h)								
2	(MSB)	PAGE LENGTH (28)							
3							(LSB)		
4	LOGICAL BLOCK PROTECTION METHOD								
5	Reserved		LOGICAL BLOCK PROTECTION INFORMATION LENGTH						
6	LBP_W	LBP_R	RBDP	Reserved					
7	Reserved								
8	Reserved								
31	Reserved								

**Byte Description**

0

**Bit Description**

7 PS (Parameter Saveable): 0b. Ignored in MODE SELECT. See Parameter Saveable behavior in 4.7.2.2 on page 41.

6 SPF: 1b

5-0 PAGE CODE: 0Ah

1 SUBPAGE CODE: F0h

2-3 PAGE LENGTH: 1Ch

4 LOGICAL BLOCK PROTECTION METHOD: (changeable)

**Value Description**

00h Do not use logical block protection

01h Use the Reed-Solomon CRC as defined in ECMA-319 as the logical block protection information.

02h Use the CRC32C CRC as the logical block protection information transferred between the drive and the host.

The CRC32C CRC is transformed to or from the Reed-Solomon CRC by the drive between the block being transferred across the interface and the block saved on the tape in the tape format.

others Reserved.

5

**Bit Description**

7-6 Reserved

5-0 LOGICAL BLOCK PROTECTION INFORMATION LENGTH: 00h. (changeable)

6

<b>Bit</b>	<b>Description</b>						
7	LBP_W (logical blocks protected during write): 0 (changeable) Shall be set to zero if the LOGICAL BLOCK PROTECTION METHOD field is set to zero.						
	<table border="0"> <thead> <tr> <th style="text-align: left;"><b>Value</b></th> <th style="text-align: left;"><b>Description</b></th> </tr> </thead> <tbody> <tr> <td>0</td> <td>Protection information is not included with logical blocks transferred when writing.</td> </tr> <tr> <td>1b</td> <td>Protection information is included with logical blocks transferred during processing of the commands specified in Protecting logical blocks transferred during writes (see 4.9.4 on page 45).</td> </tr> </tbody> </table>	<b>Value</b>	<b>Description</b>	0	Protection information is not included with logical blocks transferred when writing.	1b	Protection information is included with logical blocks transferred during processing of the commands specified in Protecting logical blocks transferred during writes (see 4.9.4 on page 45).
<b>Value</b>	<b>Description</b>						
0	Protection information is not included with logical blocks transferred when writing.						
1b	Protection information is included with logical blocks transferred during processing of the commands specified in Protecting logical blocks transferred during writes (see 4.9.4 on page 45).						
6	LBP_R (logical block protected during read): 0 (changeable) Shall be set to zero if the LOGICAL BLOCK PROTECTION METHOD field is set to zero.						
	<table border="0"> <thead> <tr> <th style="text-align: left;"><b>Value</b></th> <th style="text-align: left;"><b>Description</b></th> </tr> </thead> <tbody> <tr> <td>0</td> <td>Protection information is not included with logical blocks transferred when reading.</td> </tr> <tr> <td>1b</td> <td>Protection information is included with logical blocks transferred during processing of the commands specified in Protecting logical blocks processed during reads and verifies (see 4.9.5 on page 46).</td> </tr> </tbody> </table>	<b>Value</b>	<b>Description</b>	0	Protection information is not included with logical blocks transferred when reading.	1b	Protection information is included with logical blocks transferred during processing of the commands specified in Protecting logical blocks processed during reads and verifies (see 4.9.5 on page 46).
<b>Value</b>	<b>Description</b>						
0	Protection information is not included with logical blocks transferred when reading.						
1b	Protection information is included with logical blocks transferred during processing of the commands specified in Protecting logical blocks processed during reads and verifies (see 4.9.5 on page 46).						
5	RBDP (recover buffered data protected): 0b (non-changeable)						
4-0	Reserved						
7-31	Reserved						

#### 6.6.10 MP 0Fh: Data Compression

See MODE SELECT (6/10) - 15h/55h (see 5.2.10 on page 95) for how to set these parameters and MODE SENSE (6/10) - 1Ah/5Ah (see 5.2.11 on page 96) for how to read these parameters. Mode Page Behaviors (see 4.7 on page 39) describes this device's non-standard behaviors related to mode parameters.

The Data Compression mode page (see table 336) specifies the parameters for the control of data compression in the device.

The mode page policy for this page is described in Policy — non-standard (see 4.7.1 on page 39).

Table 336 — MP 0Fh Data Compression mode page

Byte	Bit							
	7 msb	6	5	4	3	2	1	0 lsb
0	PS	SPF(0)	PAGE CODE (0Fh)					
1	PAGE LENGTH (0Eh)							
2	DCE	DCC	Reserved					
3	DDE	RED		Reserved				
4	(MSB)							
7	COMPRESSION ALGORITHM							(LSB)
8	(MSB)							
11	DECOMPRESSION ALGORITHM							(LSB)
12	Reserved							
15	Reserved							

**Byte Description**

0

**Bit Description**

7 PS (Parameter Saveable): 0b. Ignored in MODE SELECT. See Parameter Saveable behavior in 4.7.2.2 on page 41.

6 Reserved

5-0 PAGE CODE: 0Fh

1 PAGE LENGTH: 0Eh

2

**Bit Description**

7 DCE (Data Compression Enabled): 1b (changeable)

**Value Description**

0 Data compression is not enabled

1 Data compression is enabled

NOTE 46 - The only advantage to disabling data compression is predictable full tape capacity (see 2.1.39)

NOTE 47 - When the SELECT DATA COMPRESSION ALGORITHM field of MP 10h: Device Configuration (see 6.6.11) is set to one the DCE bit is forced to one, even if both pages are received in the same MODE SELECT command.

6 DCC (Data Compression Capable): 1b (non-changeable)

5-0 Reserved

3

**Bit Description**

7 DDE: 1b (non-changeable)

6-5 RED (Report Exception on Decompression): 00b (non-changeable)

4-0 Reserved

4-7 COMPRESSION ALGORITHM: 0000 00FFh (Unregistered algorithm) (non-changeable)

A value of 00000001h which specifies the default algorithm shall be used is accepted on MODE SELECT.

In LTO5 this field reports a value of 0000 0001h.

- 8-11 DECOMPRESSION ALGORITHM: 0000 00FFh (Unregistered algorithm) (non-changeable)  
 A value of 00000001h which specifies the default algorithm shall be used is accepted on MODE SELECT.  
 In LTO5 this field reports a value of 0000 0001h.
- 12-15 Reserved

### 6.6.11 MP 10h: Device Configuration

See MODE SELECT (6/10) - 15h/55h (see 5.2.10 on page 95) for how to set these parameters and MODE SENSE (6/10) - 1Ah/5Ah (see 5.2.11 on page 96) for how to read these parameters.

Mode Page Behaviors (see 4.7 on page 39) describes this device's non-standard behaviors related to mode parameters.

The Device Configuration mode page (see table 337) is used to specify the configuration of items specific to tape drives.

The mode page policy for this page is described in Policy — non-standard (see 4.7.1 on page 39).

**Table 337 — MP 10h Device Configuration mode page**

Byte	Bit								
	7 msb	6	5	4	3	2	1	0 lsb	
0	PS	SPF(0)	PAGE CODE (10h)						
1	PAGE LENGTH (0Eh)								
2	Rsvd	Obsolete	CAF	ACTIVE FORMAT					
3	ACTIVE PARTITION								
4	WRITE OBJECT BUFFER FULL RATIO								
5	READ OBJECT BUFFER EMPTY RATIO								
6	(MSB)	WRITE DELAY TIME						(LSB)	
7									
8	OBR	LOIS	Obsolete	AVC	SOCF		ROBO	REW	
9	Obsolete								
10	EOD DEFINED			EEG	SEW	SWP	BAML	BAM	
11	(MSB)	OBJECT BUFFER SIZE AT EARLY WARNING						(LSB)	
13									
14	SELECT DATA COMPRESSION ALGORITHM								
15	WTRE		OIR	REWIND ON RESET		ASOCWP	PERSWP	PRMWP	

#### Byte Description

- 0
- | Bit | Description   |
|-----|---|
| 7   | PS (Parameter Saveable): 1b. Ignored in MODE SELECT. See Parameter Saveable behavior in 4.7.2.2 on page 41. |
| 6   | SPF: 0b   |
| 5-0 | PAGE CODE: 10h  |
- 1
- PAGE LENGTH: 0Eh

2

Bit	Description
7	Reserved
6	CAP (Change Active Partition): 0b (Obsolete - Refer to the LOCATE command to change partition) (non-changeable)
5	CAF (Change Active Format): 0b (non-changeable)
4-0	ACTIVE FORMAT: 00000b (non-changeable)

3 ACTIVE PARTITION (non-changeable)

4 WRITE BUFFER FULL RATIO: 00h (value not specified) (non-changeable)

5 READ BUFFER EMPTY RATIO: 00h (value not specified) (non-changeable)

6-7 WRITE DELAY TIME: 012Ch (30 sec) (changeable)

The maximum time, in 100 ms increments, that the device server waits before any buffered data that is to be written, is forced to the medium after the last buffered WRITE command that did not cause the object buffer to exceed the write object buffer full ratio.

==== WARNING ===== WARNING =====  
 Changing the WRITE DELAY TIME may result in adverse performance.

==== WARNING ===== WARNING =====

8

Bit	Description
7	OBR (Object Buffer Recovery): 0b (non-changeable)
6	LOIS (Logical Object Identifier Supported): 1b (non-changeable)
5	Obsolete
4	AVC (Automatic Velocity Control): 0b (non-changeable) The speed chosen is defined by the SPEED field in the mode parameter header.
3-2	SOCF (Stop on Consecutive Filemarks): 00b (non-changeable) Read ahead to fill buffer, without regard for filemarks
1	RBO (Recover Buffer Order): 0b (non-changeable)
0	REW (Report Early Warning on Read commands): 0b (non-changeable)

9 GAP SIZE: 00h (non-changeable)

10

Bit	Description
7-5	EOD DEFINED (End Of Data Defined): 000b (non-changeable)
4	EEG (Enable EOD Generation): 1b (non-changeable)
3	SEW (Synchronize at Early-Warning): 0b (non-changeable) The device may retain unwritten buffered logical objects in the object buffer when positioned between early-warning and EOP.
2	SWP (Soft Write Protect): 0b (non-changeable)
1	BAML (Block Address Mode Lock): 0b (non-changeable)
0	BAM (Block Address Mode): 0b (non-changeable)

11-13 OBJECT BUFFER SIZE AT EARLY WARNING: 000000h (non-changeable)

14 SELECT DATA COMPRESSION ALGORITHM: 01h (changeable)

Value	Description
00h	No compression used

NOTE 48 - The only advantage to disabling data compression is predictable full tape capacity (see 2.1.39)

01 Use default compression algorithm

NOTE 49 - On a MODE SENSE, the value of byte 14 is consistent with what is found in Mode Page 0F, Byte 2, Bit 7. If this byte alone is updated on a MODE SELECT, and Mode Page 0F is not sent, then Mode Page 0F, Byte 2, Bit 7 is updated according to this field. If both Page 10

and Page 0F are sent, then if either setting is enabled, then compression is enabled and both fields updated to reflect enablement.

15

<b>Bit</b>	<b>Description</b>
7-6	WTRE (WORM Tamper Read Enable): 10b (changeable)
	<b>Value            Description</b>
	00b            The device treats a value of 00b the same as if the value were 10b.
	01b            Detection of compromised integrity on a WORM medium shall not affect processing of a task.
	 NOTE 50 - An application client should not set the WTRE bit to 01b except for the recovery of data from a WORM medium where the integrity of the stored data has been compromised.
	10b            If the drive detects compromised integrity on a WORM medium it returns CHECK CONDITION status with the sense key set to MEDIUM ERROR and the additional sense code set to WORM MEDIUM - INTEGRITY CHECK. (3/300Dh). The position of the medium may have changed.
	11b            Reserved
5	OIR (Only If Reserved) 0b (changeable-saveable)
	This field dictates the behavior of commands other than PERSISTENT RESERVE IN, PERSISTENT RESERVE OUT, RESERVE, and RELEASE.
	<b>Value            Description</b>
	0b            Commands processed normally when no reservation exists.per RVC column of Table 31, Supported Common SCSI Commands on page 76
	1b            Commands listed with a 'Y' in the RVC column of Table 31, Supported Common SCSI Commands on page 76 are rejected with ILLEGAL REQUEST, NOT RESERVED if received and no reservation is present in the drive. If a reservation is present in the drive, the commands are processed only if a reservation exists that allows access via the I_T nexus from which the command is received.
4-3	REWIND ON RESET: 10b (non-changeable)
	The position on medium is not changed due to a logical unit reset.
2	ASOCWP (Associated Write Protect): 0b (non-changeable)
1	PERSWP (Persistent Write Protect) 0b (non-changeable)
0	PRMWP (Permanent Write Protect): 0b (non-changeable)

### 6.6.12 MP 10h[01h]: Device Configuration Extension

See MODE SELECT (6/10) - 15h/55h (see 5.2.10 on page 95) for how to set these parameters and MODE SENSE (6/10) - 1Ah/5Ah (see 5.2.11 on page 96) for how to read these parameters.

Mode Page Behaviors (see 4.7 on page 39) describes this device's non-standard behaviors related to mode parameters.

The Device Configuration Extension mode page (see table 338), a subpage of the Device Configuration mode page, provides control of the SCSI features specific to sequential-access devices.

The mode page policy for this page is described in Policy — non-standard (see 4.7.1 on page 39).

Table 338 — MP 10h[01h] Device Configuration Extension mode page

Byte	Bit								
	7 msb	6	5	4	3	2	1	0 lsb	
0	PS	SPF(1b)	PAGE CODE (10h)						
1	SUBPAGE CODE (01h)								
2	(MSB) page length (1Ch)								
3	(LSB)								
4	d	Reserve		t	t	t	t	t	
		arpf		aser		arpc		aplsd	
5	WRITE MODE				SHORT ERASE MODE				
6	(MSB) pews								
7	(LSB)								
8	d	Reserve		w	a	w	a	v	
		cwre		re		cvcelbre		celbre	
9	Reserved								
31	Reserved								

**Byte Description**

0

**Bit Description**

7 PS (Parameter Saveable): 1b. Ignored in MODE SELECT. See Parameter Saveable behavior in 4.7.2.2 on page 41.

6 SPF (Subpage Format): 1b

5-0 PAGE CODE: 10h

1 SUBPAGE CODE: 01h

2-3 PAGE LENGTH: 001Ch

4

**Bit Description**

7-4 Reserved

3 TARPF (TapeAlert respect parameter fields): 0b (non-changeable)

2 TASER (TapeAlert Select exception reporting): 0b (non-changeable)

1 TARPC (TapeAlert respect page control): 0b (non-changeable)

0 TAPLSD (TapeAlert prevent LOG SENSE deactivation): 0b (non-changeable)

5

**Bit Description**

7-4 WRITE MODE: (changeable-saveable)

Specifies the write mode (see 4.2) in which to place the device server. If a volume is loaded and an attempt is made to change the WRITE MODE from 01h (i.e., append-only) to 00h (i.e.,



overwrite-allowed), then the command shall be rejected with ILLEGAL REQUEST, INVALID FIELD IN PARAMETER LIST.

<b>Value</b>	<b>Description</b>
00h	overwrite-allowed mode (see 4.2.2).
01h	append-only mode (see 4.2.3).
3-0	SHORT ERASE MODE: (non-changeable) Specifies the action to be taken by the device server when an ERASE (16) or ERASE (6) command with the LONG bit set to zero is processed.

<b>Value</b>	<b>Description</b>
02h	The device server records an EOD indication at the specified location on the medium.
6-7	PEWS (programmable early warning size): (changeable-saveable) Specifies the number of megabytes (i.e., 10 <sup>6</sup> ) native capacity to use in establishing a PEWZ. See (see 4.8) for a description of programmable early warning. Ultrium 4 and earlier drives do not support the PEWS field and require that it be set to 0000h. The Ultrium 5 and later drives support the PEWS field set to any value and does not round the value (e.g., due to volume capacity). The default value is 0000h indicating that there is no PEWZ.

NOTE 51 - It is possible that a partition is set to a capacity less than the size that can be represented by the PEWS field. In this case the first write will get the programmable early warning indication.

NOTE 52 - PEWZ is created using the amount of medium required to fit PEWS megabytes assuming one-to-one compression (e.g., compression disabled) and the medium is in good condition.

NOTE 53 - The drive employs a design to protect against the number of blocks on medium exceeding a value that can be represented in a 4-byte field. To ensure the programmable early warning indication is reported to an application during this scenario, the drive also uses the number of blocks on medium as a determination of entering PEWZ. The drive calculates how many blocks it will take to fill PEWZ assuming a modest block size of 32KiB (i.e., PEWS/8000h = number\_of\_blocks\_to\_make\_PEWZ) and reports programmable early warning when the number of blocks on medium reaches PEWZ (i.e., Early Warning - number\_of\_blocks\_to\_make\_PEWZ).

8

<b>Bit</b>	<b>Description</b>
7-4	Reserved
3	ACWRE (automation configured writes require encryption): (non-changeable) <b>Value</b> <b>Description</b> 0b              The drive encryption policy library configuration is not configured to encryption required for writing logical blocks. 1b              The drive encryption policy library configuration is configured to encryption required for writing logical blocks.
2	WRE (writes require encryption): (changeable-saveable) <b>Value</b> <b>Description</b> 0b              The drive encryption policy application configuration is not configured to require encryption for writing to partitions. 1b              The drive encryption policy application configuration is configured to require encryption for writing to partitions.
1	ACVCELBRE (automation configured volume containing encrypted logical blocks requires encryption): (non-changeable)

NOTE 54 - This drive deviates from the T10 standard for this parameter as its setting applies to a partition and not to the volume as a whole. That is, only the active partition (i.e., the current partition) is checked to see if it contains encrypted logical blocks.

Value	Description
0b	The drive encryption policy library configuration is not configured to encryption required for appending logical blocks.
1b	The drive encryption policy library configuration is configured to encryption required for appending logical blocks.
0	VCELBRE (volume containing encrypted logical blocks requires encryption): (changeable-saveable)

NOTE 55 - This drive deviates from the T10 standard for this parameter as its setting applies to a partition and not to the volume as a whole. That is, only the active partition (i.e., the current partition) is checked to see if it contains encrypted logical blocks.

Value	Description
0b	The device server does not use the VCELB bit in the Data Encryption Status page to determine if encryption is required for appending logical blocks.
1b	If the VCELB bit in the Data Encryption Status page is set to one, then the device server requires that any logical blocks appended to the medium are encrypted.

9-31 Reserved

### 6.6.13 MP 11h: Medium Partition Page

See MODE SELECT (6/10) - 15h/55h (see 5.2.10 on page 95) for how to set these parameters and MODE SENSE (6/10) - 1Ah/5Ah (see 5.2.11 on page 96) for how to read these parameters. Mode Page Behaviors (see 4.7 on page 39) describes this device's non-standard behaviors related to mode parameters.

The mode page policy for this page is described in Policy — non-standard (see 4.7.1 on page 39).

The Medium Partition mode page (see table 339) is used to specify the group of medium partitions. Fields in the Medium Partition mode page indicating the current state of the partitions for the medium are changed by the device server to the current medium state on a not ready to ready transition when the medium state changes from demounted to mounted.

The FORMAT MEDIUM command uses the settings in the Medium Partition mode page and functions in the constraints dictated by any capacity changes resulting from a previous SET CAPACITY command that was performed on the mounted volume (i.e., The Set Capacity command controls the maximum capacity allowed for the volume and the Format Medium command works inside those constraints).

The partitioning of the mounted volume is not changed until a subsequent FORMAT MEDIUM command is issued while the volume is mounted. Note that mounting a volume that modifies the value of fields in this page does not establish a unit attention condition.

#### ==== WARNING ===== WARNING =====

The fields in this page do not follow normal mode parameter rules. Some fields always return values depending on the mounted volume even after a MODE SELECT command changes them. Other fields return pending values set by a MODE SELECT command instead of values dictated by the mounted volume. Check each field description to understand this behavior.

#### ==== WARNING ===== WARNING =====

There is an overhead associated with each additional partition, regardless of the size of the partition, that subtracts from the customer data space on the volume. The larger the number of possible partitions, the more overhead is consumed when the volume is partitioned. From LTO9 cartridges, the use of SDP=1b to create an even number of equally sized partitions uses band boundaries instead of guard wraps, thereby not requiring additional overhead.

Partitioning and reformatting (see 4.4.5 on page 33) describes restrictions on partitioning.

**Table 339 — MP 11h Medium Partition mode page**

Byte	Bit								
	7 msb	6	5	4	3	2	1	0 lsb	
0	PS(0b)	SPF(0b)	PAGE CODE (11h)						
1	PAGE LENGTH (n-1)								
2	MAXIMUM ADDITIONAL PARTITIONS								
3	ADDITIONAL PARTITIONS DEFINED								
4	FDP	SDP	IDP	PSUM (11b)		POFM (1b)	CLEAR (0b)	ADDP(0b)	
5	MEDIUM FORMAT RECOGNITION (03h)								
6	PARTITIONING TYPE				PARTITION UNITS				
7	Reserved								
Partition size descriptor(s)									
8	(MSB)	PARTITION SIZE (first)							
9								(LSB)	
...									
n-1	(MSB)	PARTITION SIZE (last)							
n								(LSB)	

**Byte Description**

0

**Bit Description**

7 PS (Parameter Saveable): 0b. Ignored in MODE SELECT. See Parameter Saveable behavior in 4.7.2.2 on page 41.

6 SPF (SubPage Format): 0b

5-0 PAGE CODE: 11h

1 PAGE LENGTH:

The page length depends on the number of partitions (i.e., 08h + 2\*ADDITIONAL PARTITIONS DEFINED). In MODE SENSE all four sizes are returned even if they don't exist on the volume (i.e., they report zero).

2 MAXIMUM ADDITIONAL PARTITIONS: (non-changeable)

This field specifies the maximum number of additional partitions supported on the loaded volume. It can be thought of as the value N-1 where N is the maximum number of partitions allowed. In a MODE SENSE command the MAXIMUM ADDITIONAL PARTITIONS field is set to the value indicated by the loaded volume, or the value reported for the previously loaded volume if there is no volume loaded. If there has been no volume loaded since power-on or the mounted volume does not support partitioning (e.g., WORM volume), then the MAXIMUM ADDITIONAL PARTITIONS field is set to 00h.

This value may be changed by the device if:

A) a volume is loaded; or

B) other unspecified events occur.

## 3 ADDITIONAL PARTITIONS DEFINED: (changeable)

This field specifies the number of additional partitions on the mounted volume (in addition to partition 0). It can be thought of as the value N-1 where N is the total number of partitions.

If SDP or IDP is set to one, then this field may be set to 00h, 01h, 02h, or 03h.

If FDP is set to one, then this field is ignored (i.e., any value is allowed and ignored).

This field is not allowed to be changed when the drive is not ready.

The partitioning of the mounted volume is not changed until a subsequent Format Medium command is issued while the volume is mounted. If the logical unit is not ready, the ADDITIONAL PARTITIONS DEFINED field is undefined.

NOTE 56 - If a MODE SENSE command is received after a MODE SELECT command but before a FORMAT MEDIUM command, then the ADDITIONAL PARTITIONS DEFINED value returned may not match the value sent in the MODE SELECT command but the device server retains the value sent in the MODE SELECT command until the FORMAT MEDIUM command is performed.

## 4

**Bit Description**

## 7 FDP (Fixed Data Partitions): (changeable)

A FDP bit of one in a MODE SELECT command specifies the logical unit shall partition the medium based on its fixed definition of partitions. Setting this bit to one is mutually exclusive with the SDP and IDP bits. The partition size descriptors are ignored by the MODE SELECT command when the FDP bit is set to one. The drive creates two partitions on the volume and assigns one partition as the minimum sized partition and one partition as the remaining available size.

When a MODE SENSE command is received after a MODE SELECT command but before a FORMAT MEDIUM command the FDP bit returned is the value that was set in the MODE SELECT command. When a MODE SENSE command is received and there is no pending change related to a MODE SELECT command for this page the FDP bit is set to zero.

NOTE 57 - The partition size descriptors are present in MODE SENSE data regardless of the settings of the FDP, SDP or IDP fields to give an estimate of the size of each partition.

## 6 SDP (Select Data Partitions): (changeable)

For Mode Select, either value is allowed

**Value Description**

0b The SDP functionality is not used.

1b The volume is partitioned into the number of partitions as specified by the ADDITIONAL PARTITIONS DEFINED field (n) using partitions as close to equal size as possible. If rounding is required to meet format requirements, partitions will be rounded in a manner to create as equal size partitions as possible. The drive partitions the volume into n+1 partitions numbered 0 through n. Setting this bit to one is mutually exclusive with the FDP and IDP fields. The partition size descriptors are ignored by the MODE SELECT command when the SDP bit is set to one.

If a MODE SENSE command is received after a MODE SELECT command but before a FORMAT command, then the SDP bit returned is the value that was set in the MODE SELECT command. If a MODE SENSE command is received and there is no pending change related to a MODE SELECT command for this page, then:

- a) if the partition boundaries on tape are guard wraps, then the SDP bit is set to zero; and
- b) if the partition boundaries on tape are band boundaries, then the SDP bit is set to one.

## 5 IDP (Initiator Defined Partitions): (changeable)

For Mode Select, either value is allowed

**Value Description**

0b The IDP functionality is not used.

1b The volume is partitioned as specified by the ADDITIONAL PARTITIONS DEFINED field and the partition size descriptors. Setting this bit to one is mutually exclusive with the FDP and SDP fields. The number of non-zero partition size descriptors received

in the Medium Partition mode page shall be at least one more than the ADDITIONAL PARTITIONS DEFINED value. The size of partition 0 shall be non-zero.

If a MODE SENSE command is received after a MODE SELECT command but before a FORMAT MEDIUM command, then the IDP bit returned is the value that was set in the MODE SELECT command. If a MODE SENSE command is received and there is no pending change related to a MODE SELECT command for this page and the SDP bit is not set to one, then the IDP bit is set to one.

- 4-3 PSUM (Partition Size Unit of Measure): 11b ( $10^{\text{PARTITION UNITS}}$  bytes) (changeable)  
 2 POFM (Partition on Format Medium): 1b (non-changeable)

This bit indicates that the Mode Select command will not cause changes to the partition sizes or user data, either recorded or buffered. Actual media partitioning occurs with a subsequent Format Medium command using the mode data for this page. Field values specified by a Mode Select command for this page will not be changed by the drive before the volume is unloaded or the drive is reset. Some field checking may be performed by the MODE SELECT command. However, there is no guarantee that any subsequent partitioning during a FORMAT MEDIUM command will complete with no errors.

- 1 CLEAR (Partition clearing): 0b (non-changeable)  
 0 ADDP (Adding Partitions): 0b (non-changeable)

The drive does not retain the method used to partition the volume, however it does recognize when it is using band boundaries as partition boundaries. If band boundaries are used as partition boundaries, then the SDP bit is set to one, otherwise the IDP bit is set to one in the MODE SENSE data.

Table 9 on page 31 shows the partition sizes that result from a MODE SELECT with the indicated field settings if the SET CAPACITY command has not shortened the tape.

Wrap-wise Partitioning (see 4.4.2 on page 29) describes how to set partition sizes and achieve desired results.

- 5 MEDIUM FORMAT RECOGNITION: 03h (Capable of format and partition recognition) (non-changeable)  
 6

**Bit Description**

- 7-4 PARTITIONING TYPE: (changeable)

The PARTITIONING TYPE field specifies the criteria used to create the partitions.

**Value Description**

- |       |   |
|-------|---|
| 0h    | The type of partitioning is vendor-specific or unknown<br><br>The drive sets the PARTITIONING TYPE field to a value of 1h when a 0h is received in a MODE SELECT command. If the volume is not partitioned this value is returned in a MODE SENSE command unless there is a pending action from a MODE SELECT |
| 1h    | The type of partitioning is optimized for streaming performance (i.e., wrap-wise partitioning).   |
| 2h    | Not Supported   |
| 3h-Eh | Reserved  |
| Fh    | For a MODE SELECT command this value is reserved.   |

When a MODE SENSE command is received after a MODE SELECT command but before a FORMAT MEDIUM command the PARTITIONING TYPE field returned is the value that was set in the MODE SELECT command. When a MODE SENSE command is received and there is no pending change related to a MODE SELECT command for this page the PARTITIONING TYPE field is set depending on how the volume is currently partitioned.

- 3-0 PARTITION UNITS: (changeable)

If the PSUM field is set to 11b, then each PARTITION SIZE descriptor specifies the size of a partition in  $10^{\text{PARTITION UNITS}}$  bytes. The PARTITION UNITS used to partition the volume are not retained.

- 7 Reserved

8-n PARTITION SIZE descriptors: (n=9, 11, 13, or 15) (changeable)

Each PARTITION SIZE descriptor specifies the size of a partition in  $10^{\text{PARTITION UNITS}}$  bytes. The device rounds any value received in a PARTITION SIZE descriptor down to the nearest valid partition size that is less than or equal to the requested value.

**Byte Description**

8-9 PARTITION SIZE descriptor for partition 00h

This shall exist and shall be non-zero.

10-11 PARTITION SIZE descriptor for partition 01h, if sent

This descriptor shall be present and non-zero if the ADDITIONAL PARTITIONS DEFINED field is 01h or greater. On Ultrium 5 and later devices this descriptor may be present and set to zero if the ADDITIONAL PARTITIONS DEFINED field is 00h.

12-13 PARTITION SIZE descriptor for partition 02h, if sent

This descriptor shall be present and non-zero if the ADDITIONAL PARTITIONS DEFINED field is 02h or greater. On Ultrium 6 and later devices this descriptor may be present and set to zero if the ADDITIONAL PARTITIONS DEFINED field is less than 02h.

14-15 PARTITION SIZE descriptor for partition 03h, if sent

This descriptor shall be present and non-zero if the ADDITIONAL PARTITIONS DEFINED field is 03h. On Ultrium 6 and later devices this descriptor may be present and set to zero if the ADDITIONAL PARTITIONS DEFINED field is less than 03h.

NOTE 58 - Summing the partition sizes provides a standardized mechanism for an initiator to calculate the volume capacity with MODE SENSE.

In a MODE SELECT command:

- a) a value of FFFFh received in a PARTITION SIZE descriptor, requests that the logical unit allocate all remaining partition space to that partition;
- b) if the FDP bit is set to one any values are allowed in the PARTITION SIZE descriptors and ignored. The PARTITION SIZE descriptors are updated by the drive when an initiator specifies a new number of partitions;
- c) if the SDP bit is set to one any values are allowed in the PARTITION SIZE descriptors and ignored. The PARTITION SIZE descriptors are updated by the drive when an initiator specifies a new number of partitions; and
- d) the device server returns CHECK CONDITION status with the Sense Key set to ILLEGAL REQUEST and the additional sense code set to INVALID FIELD IN PARAMETER LIST if:
  - A) insufficient space exists on the volume for the requested partition sizes; or
  - B) multiple partition size descriptors are set to FFFFh.

In a MODE SENSE command:

- a) a value of FFFFh returned in a PARTITION SIZE descriptor, indicates the partition size, in units indicated by PSUM and PARTITION UNITS, is greater than or equal to FFFFh;
- b) if the logical unit is not ready, then the PARTITION SIZE descriptors are undefined;
- c) if a MODE SELECT command has modified values in this page but a FORMAT MEDIUM command has not yet been processed, then the values in the PARTITION SIZE fields are the values set by the MODE SELECT command rounded to a valid partition size as described in table 9 on page 31; and
- d) if the logical unit is ready and there is no pending change related to a MODE SELECT command for this page, then the PARTITION SIZE fields reflect the size on the volume of the related partition.

NOTE 59 - When more than one partition is defined, the sum of the partition sizes may be less than when only a single partition is defined. Each partition may require a certain amount of overhead space on a volume, which reduces the usable customer data space.

### 6.6.14 MP 18h: Protocol-Specific Logical Unit

See MODE SELECT (6/10) - 15h/55h (see 5.2.10 on page 95) for how to set these parameters and MODE SENSE (6/10) - 1Ah/5Ah (see 5.2.11 on page 96) for how to read these parameters. Mode Page Behaviors (see 4.7 on page 39) describes this device's non-standard behaviors related to mode parameters.

The mode page policy for this page is described in Policy — non-standard (see 4.7.1 on page 39).

The Protocol-specific logical unit mode page for FCP attached devices is defined in 6.6.14.1.

The Protocol-specific logical unit mode page for SAS attached devices is defined in 6.6.14.2.

#### 6.6.14.1 MP 18h: Fibre Channel Logical Unit

**Table 340 — MP 18h Fibre Channel Logical Unit mode page**

Byte	Bit							
	7 msb	6	5	4	3	2	1	0 lsb
0	PS	SPF (0b)	PAGE CODE (18h)					
1	PAGE LENGTH (n-1)							
2	Reserved				PROTOCOL IDENTIFIER			
3	Reserved							EPDC
4	Reserved							
n	Reserved							

#### Byte Description

0

##### Bit Description

7 PS (Parameter Saveable): 0b. Ignored in MODE SELECT. See Parameter Saveable behavior in 4.7.2.2 on page 41.

6 Reserved

5-0 PAGE CODE: 18h

1 PAGE LENGTH: 06h

2

##### Bit Description

7-1 Reserved

3-0 PROTOCOL IDENTIFIER: 0h (FCP) (non-changeable)

3

##### Bit Description

7-1 Reserved

0 EPDC (Enable Precise Delivery Control): 1b (changeable)

##### Value

0b

##### Description

Do not use the FCP precise delivery function and ignore the contents of the COMMAND REFERENCE NUMBER field in the FCP\_CMND IU.

1b

Use the FCP precise delivery function (checking the contents of the COMMAND REFERENCE NUMBER field in the FCP\_CMND IU) to ensure that command packets are delivered in order.

4-7 Reserved

## 6.6.14.2 MP 18h: SAS Logical Unit

Table 341 — MP 18h SAS Logical Unit mode page

Byte	Bit							
	7 msb	6	5	4	3	2	1	0 lsb
0	PS	SPF (0b)	PAGE CODE (18h)					
1	PAGE LENGTH (n-1)							
2	Reserved			TLR	PROTOCOL IDENTIFIER			
3	Reserved							
n	Reserved							

**Byte Description**

0

**Bit Description**

7 PS (Parameter Saveable): 0b. Ignored in MODE SELECT. See Parameter Saveable behavior in 4.7.2.2 on page 41.

6 Reserved

5-0 PAGE CODE: 18h

1 PAGE LENGTH: 06h

2

**Bit Description**

7-5 Reserved

4 TLR (Transport Layer Retries): 1b (changeable)

3-0 PROTOCOL IDENTIFIER: 6h (Serial Attached SCSI) (non-changeable)

3-7 Reserved

**6.6.15 MP 19h: Protocol specific port**

See MODE SELECT (6/10) - 15h/55h (see 5.2.10 on page 95) for how to set these parameters and MODE SENSE (6/10) - 1Ah/5Ah (see 5.2.11 on page 96) for how to read these parameters. Mode Page Behaviors (see 4.7 on page 39) describes this device's non-standard behaviors related to mode parameters.

The mode page policy for this page is described in Policy — non-standard (see 4.7.1 on page 39).

The Protocol specific port mode page for FCP attached devices is defined in 6.6.15.1.

The Protocol specific port mode page for SAS attached devices is defined in 6.6.15.2.



6.6.15.1 MP 19h: FCP port

Table 342 — MP 19h Fibre Channel Port mode page

Byte	Bit							
	7	6	5	4	3	2	1	0
0	PS (0)	SPF (0)	PAGE CODE (19h)					
1	PAGE LENGTH							
2	Reserved				PROTOCOL IDENTIFIER			
3	DTFD (0)	PLPB (0)	DDIS (0)	DLM (0)	RHA (0)	ALWI (0)	DTIPE (0)	DTOLI (0)
4	Reserved							
5	Reserved							
6	Reserved				RR_TOV UNITS			
7	Resource Recovery Time Out Value (RR_TOV)							

**Byte Description**

0

**Bit Description**

- 7 PS (Parameter Saveable): 0b. Ignored in MODE SELECT. See Parameter Saveable behavior in 4.7.2.2 on page 41.
- 6 SPF (SubPage Format): 0b
- 5-0 PAGE CODE: 19h

1 PAGE LENGTH: 06h

NOTE 60 - A PAGE LENGTH of 0Eh is allowed on Mode Select for backwards compatibility with older devices and levels of the standard. Any fields beyond byte 7 are (changeable-ignored).

2

**Bit Description**

- 7-1 Reserved
- 3-0 PROTOCOL IDENTIFIER: 0h (FCP) (non-changeable)

3

**Bit Description**

- 7 DTFD (Disable Target Fabric Discovery): 0b (non-changeable)
- 6 PLPB (Prevent Loop Port Bypass): 0b (non-changeable)
- 5 DDIS (Disable Discovery): 0b (non-changeable)
- 4 DLM (Disable Loop Master): 0b (non-changeable)
- 3 RHA (Require Hard Address): 0b (non-changeable)
- 2 ALWI (Allow Login without Loop Initialization): 0b (non-changeable)
- 1 DTIPE (Disable Target Initiated Port Enable): 0b (non-changeable)
- 0 DTOLI (Disable Target Originated Loop Initialization): 0b (non-changeable)

4-5 Reserved

6

Bit	Description
7-3	Reserved
2-0	RR_TOV UNITS (changeable)
Value	Description
000b	No timer is specified: Default value is used and the command returns a CHECK CONDITION with Recovered Error, PARAMETERS ROUNDED (1/3700)
001b	Timer is specified in .001 second units
011b	Timer is specified in .1 second units
101b	Timer is specified in 10 second units
others	Reserved

7 RR\_TOV (Resource Recovery Time Out Value): (changeable)

NOTE 61 - The default RR\_TOV value is 25 seconds.

## 6.6.15.2 MP 19h: SAS port

Table 343 — MP 19h SAS Port mode page

Byte	Bit							
	7	6	5	4	3	2	1	0
0	PS	SPF (0)	PAGE CODE (19h)					
1	PAGE LENGTH							
2	Reserved	CONTINUE AWT	BRDCST ASYNCH EVENT	RLM	PROTOCOL IDENTIFIER			
3	Reserved							
4	(MSB)	I_T NEXUS LOSS TIME (07D0h)						(LSB)
5								
6	(MSB)	INITIATOR RESPONSE TIMEOUT (07D0h)						(LSB)
7								
8	(MSB)	REJECT TO OPEN LIMIT (0000h)						(LSB)
9								
10	Reserved							
15								

## Byte Description

0

Bit	Description
7	PS (Parameter Saveable): 0b. Ignored in MODE SELECT. See Parameter Saveable behavior in 4.7.2.2 on page 41.
6	SPF (SubPage Format): 0b (non-changeable)
5-0	PAGE CODE: 19h

1 PAGE LENGTH: 0Eh

2

Bit	Description
7	Reserved
6	CONTINUE AWT (continue arbitration wait timer): 1b (non-changeable)
5	BRDCST ASYNCH EVENT: 0b (non-changeable)
4	RLM (Ready LED Meaning): 0b (non-changeable)
3-0	PROTOCOL IDENTIFIER: 6h (SAS)

- 3 Reserved
- 4-5 I\_T NEXUS LOSS TIME: 07D0h (non-changeable)
- 6-7 INITIATOR RESPONSE TIMEOUT: 07D0h (non-changeable)
- 8-9 REJECT TO OPEN LIMIT: 0000h (non-changeable)
- 10-15 Reserved

### 6.6.16 MP 1Ah: Power Condition

See MODE SELECT (6/10) - 15h/55h (see 5.2.10 on page 95) for how to set these parameters and MODE SENSE (6/10) - 1Ah/5Ah (see 5.2.11 on page 96) for how to read these parameters. Mode Page Behaviors (see 4.7 on page 39) describes this device's non-standard behaviors related to mode parameters.

The power condition mode page controls the timers that the drive uses to go into a low-power mode. If any idle condition timer is enabled, then the low power condition is entered as the result of the expiration of one of the power condition timers in this mode page even if a volume is loaded.

The mode page policy for this page is described in Policy — non-standard (see 4.7.1 on page 39).

Table 344 defines the Power Condition mode page.

**Table 344 — MP 1Ah: Power Condition mode page format**

Byte	Bit								
	7	6	5	4	3	2	1	0	
0	PS (1b)	SPF (0b)	PAGE CODE (1Ah)						
1	PAGE LENGTH (26h)								
2	Reserved							STANDBY_Y(0)	
3	Reserved				IDLE_C	IDLE_B(0)	IDLE_A(0)	STANDBY_Z(0)	
4	(MSB)	IDLE_A CONDITION TIMER (00000000h)						(LSB)	
7									
8	(MSB)	STANDBY_Z CONDITION TIMER (00000000h)						(LSB)	
11									
12	(MSB)	IDLE_B CONDITION TIMER (00000000h)						(LSB)	
15									
16	(MSB)	IDLE_C CONDITION TIMER						(LSB)	
19									
20	(MSB)	STANDBY_Y CONDITION TIMER (00000000h)						(LSB)	
23									
24	Reserved								
39	Reserved								

#### Byte Description

- 0
  - Bit**    **Description**
  - 7        PS (Parameter Saveable): 1b. Ignored in MODE SELECT. See Parameter Saveable behavior in 4.7.2.2 on page 41.
  - 6        SPF (SubPage Format): 0b
  - 5-0      PAGE CODE: 1Ah
- 1        PAGE LENGTH: 26h

2

Bit	Description
7-1	Reserved
0	STANDBY_Y: 0b (non-changeable)

3

Bit	Description
7-4	Reserved
3	IDLE_C: 1b (changeable-saveable)
	<b>Value</b> <b>Description</b>
	0b              The idle_c condition timer is disabled and the power condition is disabled.
	1b              The idle_c condition timer is enabled. The IDLE_C power condition is enabled per the E_12VPC bit in MP 30h[43h]: Feature switches - Device attribute settings (see 6.6.21.5.3).
2	IDLE_B: 0b (non-changeable)
1	IDLE_A: 0b (non-changeable)
0	STANDBY_Z: 0b (non-changeable)
4-7	IDLE_A CONDITION TIMER: 00000000h (non-changeable)
8-11	STANDBY_Z CONDITION TIMER: 00000000h (non-changeable)
12-15	IDLE_B CONDITION TIMER: 00000000h (non-changeable)
16-19	IDLE_C CONDITION TIMER: 00002EE0h (i.e., 20 minutes) (changeable-saveable)
	Initial value, in 100 millisecond increments, for the idle_c condition timer. This value may be rounded up or down to the nearest implemented time. When in the IDLE_C mode, a REQUEST SENSE command returns NO SENSE/IDLE_C CONDITION ACTIVATED BY TIMER (0/5E07).
20-23	STANDBY_Y CONDITION TIMER: 00000000h (non-changeable)
24-39	Reserved

### 6.6.17 MP 1Ch: Informational Exceptions Control

See MODE SELECT (6/10) - 15h/55h (see 5.2.10 on page 95) for how to set these parameters and MODE SENSE (6/10) - 1Ah/5Ah (see 5.2.11 on page 96) for how to read these parameters. Mode Page Behaviors (see 4.7 on page 39) describes this device's non-standard behaviors related to mode parameters.

The mode page policy for this page is described in Policy — non-standard (see 4.7.1 on page 39).

Table 345 — MP 1Ch Informational Exceptions Control mode page

Byte	Bit								
	7	6	5	4	3	2	1	0	
0	PS	SPF (0b)	PAGE CODE (1Ch)						
1	PAGE LENGTH (0Ah)								
2	PERF	Reserved	EBF	EWASC	DEXCPT	TEST	EBACKERR	LOGERR	
3	Reserved				MRIE				
4	(MSB) _____								
7	INTERVAL TIMER								
8	(LSB) _____								
8	(MSB) _____								
11	REPORT COUNT / TEST FLAG NUMBER								
11	(LSB) _____								

**Byte Description**

0

**Bit Description**

7 PS (Page Save): 0b. Ignored in MODE SELECT. See Parameter Saveable behavior in 4.7.2.2 on page 41.

6 Reserved

5-0 PAGE CODE: 1Ch

1

PAGE LENGTH: 0Ah

2

**Bit Description**

7 PERF: 0b (non-changeable)

6-4 Reserved

3 DEXCPT: 1b (changeable)

**Value****Description**

0b Exception Reporting is enabled

1b Exception Reporting is disabled

2 TEST: 0b (changeable-special)

This bit may be written to 1b and the action described under Value 1b is performed. The value returned to a MODE SENSE command is always 0b.

**Value Description**

0b Commands are processed normally.

1b The behavior depends on the setting of the DEXCPT bit as follows:

**DEXCPT Description**

0b An exception information condition is asserted according to the REPORT COUNT / TEST FLAG NUMBER field as indicated by the MRIE field.

1b The command is rejected with 5/2600h (ILLEGAL REQUEST, INVALID FIELD IN PARAMETER DATA).

1 EBACKERR (enable background error): 0b (non-changeable)

0 LOGERR: 0b (non-changeable)

3

**Bit Description**

7-4 Reserved

3-0 MRIE: 4h (changeable)

**Value Description**

0h If an exception condition exists, it is not reported.

3h If an exception condition exists and the PER bit in the Read-Write Error Recovery mode page is set to one, unit attention eligible commands (see UAT in table 31) on this I\_T nexus that complete with status GOOD have the status modified to CHECK CONDITION and return non-deferred sense data of 1/5D00h (RECOVERED ERROR, FAILURE PREDICTION THRESHOLD EXCEEDED).

4h If an exception condition exists, unit attention eligible commands (see UAT in table 31) on this I\_T nexus that complete with status GOOD have the status modified to CHECK CONDITION and return non-deferred sense data of 1/5D00h (RECOVERED ERROR, FAILURE PREDICTION THRESHOLD EXCEEDED).

4-7 INTERVAL TIMER: 00000000h (non-changeable)

8-11 REPORT COUNT / TEST FLAG NUMBER: 00000000h (changeable-special)

If TEST=0b, this field is not changeable.

If TEST=1b, the value is not retained in the mode page. The following describes the test behavior.

**Value Description**

0000 0000h The device server shall not activate or deactivate any TapeAlert flag. After the MODE SELECT command completes, the device server reports an informational exception condition one time as specified by MRIE except with the additional sense code set to 5DFFh (FAILOVER PREDICTION THRESHOLD EXCEEDED (FALSE)). Then, if an exception condition exists, it is reported as specified by MRIE.

0000 0001h to

0000 0040h

The device server activates the TapeAlert flag specified by the REPORT COUNT/TEST FLAG NUMBER field. After the MODE SELECT completes the device server reports an informational exception condition one time as specified by MRIE except with an additional sense code of 5DFFh (FAILOVER PREDICTION THRESHOLD EXCEEDED (FALSE)). Then, if an exception condition exists, it is reported as specified by MRIE.

NOTE 62 - If the specified TapeAlert flag was already active, then the behavior may be the same as 0000\_0000h. To guarantee that a TapeAlert flag causes a non-test exception condition to exist, the deactivate (i.e., FFFF\_FFFFh to FFFF\_FFC0h) should be used prior to the activate. A non-test exception condition exists in any case where a LOG SENSE of log page 2Eh returns a non-zero TapeAlert flag. Reading log page 2Eh with LOG SENSE effectively clears the exception condition until a TapeAlert condition is activated.

NOTE 63 - While the scope of this page is <Per I\_T nexus>, the activated or deactivated TapeAlerts have the full effects of normally occurring TapeAlerts on other initiators, on libraries, etc. After performing a test, TapeAlert flags activated using this mechanism should be deactivated before resuming normal operation.

FFFF FFFFh to

FFFF FFC0h

The device server shall deactivate the TapeAlert flag specified by the absolute value of the REPORT COUNT/TEST FLAG NUMBER field. Deactivating the flag in this way is equivalent to performing the specified corrective action for that flag. Then, if an exception condition exists, it is reported as specified by MRIE.

**6.6.18 MP 1Dh: Medium Configuration**

See MODE SELECT (6/10) - 15h/55h (see 5.2.10 on page 95) for how to set these parameters and MODE SENSE (6/10) - 1Ah/5Ah (see 5.2.11 on page 96) for how to read these parameters. Mode Page Behaviors (see 4.7 on page 39) describes this device's non-standard behaviors related to mode parameters.

The Medium Configuration mode page (see table 346) specifies any special considerations the device server shall use when processing commands that access the medium.

The mode page policy for this page is described in Policy — non-standard (see 4.7.1 on page 39).

**Table 346 — MP 1Dh Medium Configuration mode page**

Byte	Bit								
	7	6	5	4	3	2	1	0	
0	PS	SPF(0)	PAGE CODE (1Dh)						
1	PAGE LENGTH (1Eh)								
2	Reserved						WORMM		
3	Reserved								
4	WORM MODE LABEL RESTRICTIONS								
5	WORM MODE FILEMARK RESTRICTIONS								
6	Reserved								
31	Reserved								

**Byte Description**

0

**Bit Description**

7 PS (Parameter Saveable): 0b. Ignored in MODE SELECT. See Parameter Saveable behavior in 4.7.2.2 on page 41.

6 SPF (Subpage Format): 0b

5-0 PAGE CODE: 1Dh

1 PAGE LENGTH: 1Eh

2

**Bit Description**

7-1 Reserved

0 WORMM (WORM mode): (non-changeable)

**Value Description**

0 The device server is not operating in WORM mode

1 The device server is operating in WORM mode

This field is changed by the device and is not allowed to be changed in a MODE SELECT command.

3 Reserved

4 WORM MODE LABEL RESTRICTIONS: 01h (non-changeable)

The device allows a tape label to be overwritten. The tape label is defined as 0, 1, or 2 logical blocks followed by nothing except 0 to n Filemarks and EOD. This must be overwritten from BOP.

5 WORM MODE FILEMARKS RESTRICTIONS: 02h (non-changeable)

The device server shall allow any number of filemarks immediately preceding EOD to be overwritten except the filemark closest to BOP.

6-31 Reserved

**6.6.19 MP 24h: Vendor-Specific**

See MODE SELECT (6/10) - 15h/55h (see 5.2.10 on page 95) for how to set these parameters and MODE SENSE (6/10) - 1Ah/5Ah (see 5.2.11 on page 96) for how to read these parameters. Mode Page Behaviors (see 4.7 on page 39) describes this device's non-standard behaviors related to mode parameters.

The Vendor-Specific Speed Matching Control mode page provides control over undocumented test options. Modifying these values could have adverse effects on the drives operation. As such, this page should never be used in a MODE SELECT operation. A MODE SENSE of this page may be used to determine if the drive supports encryption. The Vendor-Specific mode page is defined in table 347.

The mode page policy for this page is described in Policy — non-standard (see 4.7.1 on page 39).

**Table 347 — Vendor-Specific mode page**

Byte	Bit								
	7	6	5	4	3	2	1	0	
0	PS (0)	SPF(0)	PAGE CODE (24h)						
1	PAGE LENGTH (06h)								
2	Vendor-Specific								
3	Vendor-Specific								
4	Reserved								
6	Reserved								
7	Reserved				ENCR_E	Reserved	FIPS	ENCR_C	

**Byte Description**

0

**Bit Description**

7 PS (Parameter Saveable): 0b. Ignored in MODE SELECT. See Parameter Saveable behavior in 4.7.2.2 on page 41.

6 SPF (SubPage Format): 0b

5-0 PAGE CODE: 24h

1 PAGE LENGTH: 06h

2

**Bit Description**

7-1 Reserved

0 Vendor-Specific: (changeable)

3 Vendor-Specific: (changeable)

4-6 Reserved



7

<b>Bit</b>	<b>Description</b>
7-4	Reserved
3	ENCR_E (Device Supports Encryption - Enabled) (changeable-ignored)
	<b>Value            Description</b>
	0b                Device does not support encryption
	1b                Device supports encryption (encryption interface(s) are enabled)

NOTE 64 - There are multiple encryption methods, Application Managed Encryption (AME), System Managed Encryption (SME), and Library Managed Encryption (LME). When the drive is configured for SME or LME, encryption is transparent to the application and the SECURITY PROTOCOL IN command reports no encryption support.

2	Vendor-Reserved
1	FIPS: (changeable-ignored)
	<b>Value            Description</b>
	0b                Code is not FIPS level of code
	1b                Code is FIPS level of code
0	ENCR_C (Device Supports Encryption- Capable) (changeable-ignored)
	<b>Value            Description</b>
	0b                Device does not support encryption (does not have encryption hardware)
	1b                Device supports encryption (encryption interface(s) are not necessarily enabled)



## 6.6.20 MP 2Fh: Behavior Configuration

There is one copy of this page for the drive.

Mode Page Behaviors (see 4.7 on page 39) describes this device's non-standard behaviors related to mode parameters.

The mode page policy for this page is described in Policy — non-standard (see 4.7.1 on page 39).

Device support for the fields in this page vary by generation and/or code level. To discover if a field can be modified, issue a MODE SENSE with the PC field set to 01b to see if the field is changeable. This will also return the PAGE LENGTH, which must be examined to determine the length of this page, because it is expected to increase as additional Behavior configurations are added to subsequent code levels.

===== WARNING =====

This page changes the normal behavior of the drive. Some settings effect error reporting and may even cause the drive to violate SCSI standards. Care should be taken to ensure that the behavior change and its effects on the system are understood.

===== WARNING =====

**Table 348 — MP 2Fh Behavior Configuration Mode Page**

Byte	Bit								
	7	6	5	4	3	2	1	0	
0	PS	SPF (0b)	PAGE CODE (2Fh)						
1	PAGE LENGTH ( $n-1$ )								
2	FENCE BEHAVIOR								
3	CLEAN BEHAVIOR								
4	WORM BEHAVIOR								
5	SENSE DATA BEHAVIOR								
6	Reporting Behavior								
	Reserved					CCDM	DDEOR	CLNCHK	
7	Firmware Update Behavior								
	Reserved							DFMRDL	
8	Unload On Error Behavior								
	Reserved		UOE-C	UOE-F			UOE-D		
9	TapeAlert Behavior								
	Reserved							TA10	
	⋮								
n	Reserved for Future Use								

### Byte Description

0		
	<b>Bit</b>	<b>Description</b>
	7	PS (Parameter Saveable): 1b. Ignored in MODE SELECT. See Parameter Saveable behavior in 4.7.2.2 on page 41.
	6	SPF (SubPage Format): 0b
	5-0	PAGE CODE: 2Fh
1		PAGE LENGTH:

## 2 FENCE BEHAVIOR: 00h (changeable-saveable)

This field defines drive behavior in situations deemed dangerous for either media or data on the media.

Value	Description
00h	Normal operation (i.e., MTR Fence) (see 4.19.5.1.4.1 on page 66)
01h	Panic Fence operation (see 4.19.5.1.4.2 on page 67)
02h-FFh	Reserved

## 3 CLEAN BEHAVIOR: 01h (non-changeable)

Value	Description
01h	Periodic Clean Notification The device monitors criteria since last cleaning. When that criteria is exceeded, the drive puts itself in a clean needed notification state. The criteria used is subject to change.
others	Reserved

## 4 WORM BEHAVIOR: 00h (non-changeable)

Value	Description
00h	Normal Operation (reset to this value on Medium Removal)
others	Reserved

## 5 SENSE DATA BEHAVIOR: 01h (non-changeable)

When the sense data is associated with an Illegal Length read, an 18-byte Request Sense data may be used regardless of the value in this field.

Value	Description
00h	Obsolete (Earlier generation devices used this to indicate Sense data was 35-bytes in length)
01h	Sense data is 96-bytes in length
02h-FFh	Reserved

## 6 Reporting Behavior

Configures behaviors related to reporting conditions across the primary interface.

Bit	Description
7-3	Reserved
2	CCDM (Check Condition for Dead Media): 0b (changeable-saveable) On eServer enabled drives (i.e., The PRODUCT ID returned in Standard Inquiry is "HH LTO Gen x" where "x" is a number) the default of this field is one.

Value	Description
0b	Does not specify CHECK CONDITION behavior when cleaning is required.
1b	Return a CHECK CONDITION with Sense Key set to 1h and the additional sense code set to DEGRADED MEDIA (8252h) after a Rewind command when the criteria are met to set the DEAD MEDIA flag in Log Page 3Ch.

## 1 DDEOR (Disable Deferred Error On Rewind): 0b (changeable-saveable)

On eServer enabled drives (i.e., The PRODUCT ID returned in Standard Inquiry is "HH LTO Gen x" where "x" is a number) that are attached to AIX, the DDEOR bit gets set to one by the SCDD.

Value	Description
0b	Deferred error may be reported to a rewind command.
1b	Deferred error shall not be reported to a rewind command.

## 0 CLNCHK (Clean Check): 0b (changeable-saveable)

Value	Description
0b	Does not specify CHECK CONDITION behavior when cleaning is required.
1b	Return a CHECK CONDITION with Sense Key set to 0h and the additional sense code set to DRIVE REQUIRES CLEANING (8282h) after a REWIND, SPACE, LOCATE, or UNLOAD when cleaning is required.

## 7 Firmware Update Behavior

Configures behaviors related to updating device firmware.

**Bit Description**

7-1 Reserved

0 DFMRDL (Disable Field Microcode Replacement Down Level): 0b (changeable-saveable)

This configures the ability to use an FMR tape to update to a lower level of firmware. This bit does not effect code downloads by means other than an FMR tape (e.g. WRITE BUFFER over SCSI interface).

On eServer enabled drives (i.e., The PRODUCT ID returned in Standard Inquiry is "HH LTO Gen x" where "x" is a number) that are attached to AIX, the DFMRDL bit is set to one by the SCDD.

**Value Description**

0b Device may accept down level firmware by FMR tape.

1b Device shall not accept down level firmware by FMR tape.

## 8 Unload On Error Behavior

Configures auto unload behaviors of different types of cartridges when the following errors occur:

- a) Bad Media causes a mount failure;
- b) FMR cartridge is loaded when it has not been requested;
- c) Expired cleaner cartridge is loaded; or
- d) An invalid or unsupported cleaner cartridge is loaded.

Settings specified over a library interface (i.e. LDI or ADI) take precedence over these settings, but do not modify these values.

Currently the only values allowed are 00h (no exceptional behavior for any cartridge type) or 15h (do not auto-eject on error for any cartridge type). That is, all fields shall have the same value.

**Bit Description**

7-6 Reserved

5-4 UOE-C (Unload On Error - Cleaner): 01b (changeable-saveable)

**Value Description**

00b No exceptional behavior specified

01b Do not auto-eject on error

10b-11b Reserved

3-2 UOE-F (Unload on Error - FMR): 01b (changeable-saveable)

**Value Description**

00b No exceptional behavior specified

01b Do not auto-eject on error

10b-11b Reserved

1-0 UOE-D (Unload On Error - Data): 01b (changeable-saveable)

**Value Description**

00b No exceptional behavior specified

01b Do not auto-eject on error

10b-11b Reserved

## 9 TapeAlert Behavior

This field defines unique behaviors for specific TapeAlert flags.

**Bit Description**

7-1 Reserved

0 TA10: 1b (changeable-saveable)

**Value Description**

0b TapeAlert 10h is asserted when a Write, Read, or Verify command is aborted because the unload button on the panel is pressed

1b TapeAlert 10h is asserted when the unload button on the panel is pressed and the tape is away from BOP (channel LBA != 0); TapeAlert 10h will not be asserted if the tape is at BOP or if the tape is not threaded.

10-n Future behaviors that may have been defined after publication of this document.

### 6.6.21 MP 30h: Device Attribute Settings

The device attribute settings page and the related subpages are used to query and configure settings used by the drive to control its behavior and configuration in a specified environment. MP 30h: Directory Listing - Device Attribute Settings (see 6.6.21.1 on page 400) is the directory listing of supported subpages and is in the Mode Page Format (see Table 329 — on page 364). Each subpage is for the query and/or setting of device attributes for a specific function and is in the Mode Page Subpage Format (see Table 330 — on page 365). The persistence of parameters and statement of which parameters are settable or only readable is stated in the section describing each subpage.

See MODE SELECT (6/10) - 15h/55h (see 5.2.10 on page 95) for how to set these parameters and MODE SENSE (6/10) - 1Ah/5Ah (see 5.2.11 on page 96) for how to read these parameters.

Mode Page Behaviors (see 4.7 on page 39) describes this device's non-standard behaviors related to mode parameters.

The mode page policy for this page is described in Policy — non-standard (see 4.7.1 on page 39).

#### 6.6.21.1 MP 30h: Directory Listing - Device Attribute Settings

The directory listing - device attribute settings mode page is used to report the list of supported subpages in the device attribute settings mode page and subpages. The page is valid only for a Mode Sense command.

This page is defined as common to all initiators.

**Table 349 — MP 30h: Directory Listing - Device Attribute Settings mode page format**

Byte	Bit							
	7 msb	6	5	4	3	2	1	0 lsb
0	PS	SPF(0)	PAGE CODE (30h)					
1	PAGE LENGTH (n-1)							
Supported subpage list								
2	Supported subpage [first]							
⋮								
n	Supported subpage [last]							

The supported subpage list is a list of supported subpages listed in ascending order. Since the list of supported subpages is anticipated to differ between code levels (i.e., newer code levels may add subpages) the complete list is not described here. A user should read this page to determine which subpages may be used.

The following parameters apply:

#### Byte Description

0									
	<table> <thead> <tr> <th>Bit</th> <th>Description</th> </tr> </thead> <tbody> <tr> <td>7</td> <td>PS (Parameter Saveable): 0b. Ignored in MODE SELECT. See Parameter Saveable behavior in 4.7.2.2 on page 41.</td> </tr> <tr> <td>6</td> <td>SPF (SubPage Format): 0b</td> </tr> <tr> <td>5-0</td> <td>PAGE CODE: 30h</td> </tr> </tbody> </table>	Bit	Description	7	PS (Parameter Saveable): 0b. Ignored in MODE SELECT. See Parameter Saveable behavior in 4.7.2.2 on page 41.	6	SPF (SubPage Format): 0b	5-0	PAGE CODE: 30h
Bit	Description								
7	PS (Parameter Saveable): 0b. Ignored in MODE SELECT. See Parameter Saveable behavior in 4.7.2.2 on page 41.								
6	SPF (SubPage Format): 0b								
5-0	PAGE CODE: 30h								
1	PAGE LENGTH:								
2-n	Supported subpage list: Supported subpage list - Device Attribute Settings (see 6.6.21.2 on page 401) describes the subpages that were implemented or planned at the time this document was published.								

### 6.6.21.2 Supported subpage list - Device Attribute Settings

The supported subpage list returns the list of supported subpages. These subpages are organized in logical groupings by function.

Range	Description
01h-03h	MP 30h[01h-02h]: Ethernet attributes - Device attribute settings (see 6.6.21.3 on page 402).
04h-1Fh	Reserved
20h	MP 30h[20h-(20h)]: Encryption Attributes - Device Attribute Settings (see 6.6.21.4 on page 409).
21h-3Fh	Reserved
40h-44h	MP 30h[40h-44h]: Data processing attributes - Device attribute settings (see 6.6.21.5 on page 411)
44h-FEh	Reserved

The list of supported subpages that were implemented at the time this document was published follows:

2-n Supported subpages: This field is a list of 1-byte long subpage codes and may include some or all of the following:

Code	Mode Page 30h Subpage
01h	MP 30h[01h]: Drive MAC address - Device attribute settings (see 6.6.21.3.2 on page 405)
02h	MP 30h[02h]: Drive IP address and subnet mask - Device attribute settings (see 6.6.21.3.3 on page 407)
20h	MP 30h[20h]: Encryption mode - Device Attribute Settings (see 6.6.21.4.1 on page 409)
40h	MP 30h[40h]: SkipSync - Device attribute settings (see 6.6.21.5.1 on page 411)
42h	MP 30h[42h]: End of partition behavior control - Device attribute settings (see 6.6.21.5.2 on page 414)
43h	MP 30h[43h]: Feature switches - Device attribute settings (see 6.6.21.5.3 on page 415)
44h	MP 30h[44h]: Preferred Cartridge Type — Device attribute settings (see 6.6.21.5.4 on page 417)

### 6.6.21.3 MP 30h[01h-02h]: Ethernet attributes - Device attribute settings

#### 6.6.21.3.1 Ethernet attributes overview

The Ethernet attributes subpages of the device attribute mode page describe information related to the drives Ethernet interface. The subclauses to this subclause list structures used by the Ethernet attribute subpages that are described in the subclauses that are at a peer level to this subclause.

##### 6.6.21.3.1.1 Ethernet socket address descriptor

The IP address and subnet mask is defined in table 350..

**Table 350 — Ethernet socket address descriptor**

Byte	Bit								
	7	6	5	4	3	2	1	0	
0	MSB							ETHERNET SOCKET ADDRESS DESCRIPTOR LENGTH (22h)	LSB
1									
2	MSB							RELATIVE SOCKET ADDRESS IDENTIFIER	LSB
3									
4								SOCKADDR	
31									
32								SUBNET MASK LENGTH	
33								Reserved	
35									

The following parameters apply:

#### Byte Description

- 0-1      ETHERNET SOCKET ADDRESS DESCRIPTOR LENGTH - The number of bytes to follow in the Ethernet socket address descriptor.
- 2-3      RELATIVE SOCKET ADDRESS IDENTIFIER - A unique identifier for this Ethernet socket address.
- 4-31     SOCKADDR - defined by type of IP address
 

Type	Description
IPv4	6.6.21.3.1.1.1
IPv6	6.6.21.3.1.1.2
- 32        SUBNET MASK LENGTH - The number of bits set to one in the subnet mask.
- 33-35    Reserved



### 6.6.21.3.1.1.1 Sockaddr for an IPv4 IP address

The sockaddr for an IPv4 IP address is defined in table 351.

**Table 351 — Sockaddr format for IPv4**

Byte	Bit							
	7	6	5	4	3	2	1	0
0	ADDRESS LENGTH							
1	ADDRESS FAMILY							
2	MSB							
3	PORT							
4	MSB							
7	INTERNET ADDRESS							
8	Pad bytes							
27	LSB							

The following parameters apply:

#### Byte Description

- 0 ADDRESS LENGTH (10h)
- 1 ADDRESS FAMILY (02h)
- 2-3 PORT - The TCP port number, if any. Zero if there is no TCP port number.
- 4-7 INTERNET ADDRESS - The IP Address.
- 8-27 Pad bytes - All bytes set to zero.

### 6.6.21.3.1.1.2 Sockaddr for an IPv6 address

The sockaddr for an IPv6 IP address is defined in table 352.

**Table 352 — Sockaddr format for IPv6**

Byte	Bit							
	7	6	5	4	3	2	1	0
0	ADDRESS LENGTH							
1	ADDRESS FAMILY							
2	MSB							
3	PORT							
4	FLOW INFO							
7	MSB							
8	INTERNET ADDRESS							
23	LSB							
24	SCOPE ID							
27	LSB							

The following parameters apply:

**Byte Description**

0	ADDRESS LENGTH (1Ch)
1	ADDRESS FAMILY (0Ah)
2-3	PORT - The TCP port number, if any. Zero if there is no TCP port number.
4-7	FLOW INFO - (0000_0000h)
8-23	INTERNET ADDRESS - The IP Address.
24-27	SCOPE ID - (0000_0000h)

### 6.6.21.3.2 MP 30h[01h]: Drive MAC address - Device attribute settings

Mode Page Behaviors (see 4.7 on page 39) describes this device's non-standard behaviors related to mode parameters.

The mode page policy for this page is described in Policy — non-standard (see 4.7.1 on page 39).

The drive MAC address is read only and is defined in table 353.

**Table 353 — MP 30h[01h] Drive MAC address**

Byte	Bit								
	7	6	5	4	3	2	1	0	
0	ps (0b)	spf(1b)	PAGE CODE (30h)						
1	SUBPAGE CODE (01h)								
2	(MSB)	PAGE LENGTH (n-3)							
3								(LSB)	
4	Reserved								
5	Reserved								
6	Reserved								
7	number of drive port mac address descriptors								
8	Drive port MAC address descriptor [first]								
15	:								
n-7	Drive port MAC address descriptor [last]								
n									

The following parameters apply:

#### Byte Description

0

#### Bit Description

7 PS (Parameter Saveable): 0b. Ignored in MODE SELECT. See Parameter Saveable behavior in 4.7.2.2 on page 41.

6 SPF (1b)

5-0 PAGE CODE (30h)

1 SUBPAGE CODE (01h)

2-3 PAGE LENGTH

4-6 Reserved

7 NUMBER OF DRIVE PORT MAC ADDRESS DESCRIPTORS (non-changeable) - The number of descriptors to follow

8-n Drive port MAC address descriptors. (non-changeable)

The Drive port MAC address descriptors are listed in ascending order by RELATIVE TARGET PORT IDENTIFIER. The Drive port MAC address descriptor is defined in table 354.

**Table 354 — Drive port MAC address descriptor of MP 30h[01h]**

Byte	Bit							
	7	6	5	4	3	2	1	0
0	relative target port identifier							
1	relative target port identifier							
2	mac address							
7	mac address							

**Byte Description**

- 0-1 RELATIVE TARGET PORT IDENTIFIER - The relative port value for the Ethernet port.  
 2-7 MAC ADDRESS - The binary representation of the MAC address for that port.

### 6.6.21.3.3 MP 30h[02h]: Drive IP address and subnet mask - Device attribute settings

The drive IP address and subnet mask subpage is defined in table 355.

Mode Page Behaviors (see 4.7 on page 39) describes this device's non-standard behaviors related to mode parameters.

The mode page policy for this page is described in Policy — non-standard (see 4.7.1 on page 39).

Note that MODE SELECT parameter data is not required to match the structure of the parameter data returned by MODE SENSE. There is a fixed portion of the mode page that is required to be the same, but the descriptor list may contain a subset of descriptors. The Changeable Values are reported in the same structure as Current Values in MODE SENSE but are not used to positionally validate values received in MODE SELECT.

The SP bit of a MODE SELECT command shall be set to one for this mode page. If the SP bit is set to zero, then the drive rejects the command with a CHECK CONDITION and sets the sense key to ILLEGAL REQUEST and the additional sense code to INVALID FIELD IN CDB.

**Table 355 — MP 30h[02h] Drive IP address and subnet mask subpage**

Byte	Bit								
	7	6	5	4	3	2	1	0	
0	ps	spf(1b)	PAGE CODE (30h)						
1	SUBPAGE CODE (02h)								
2	(MSB)	PAGE LENGTH (n-3)							
3								(LSB)	
4	Reserved								
5	Reserved								
6	Restricted								
7	number of drive ethernet port descriptors								
8	Drive Ethernet port descriptor [first]								
m	:								
n-k	Drive Ethernet port descriptor [last]								
n									

The following parameters apply:

#### Byte Description

0	<b>Bit</b>	<b>Description</b>
	7	PS (Parameter Saveable): 1b. Ignored in MODE SELECT. See Parameter Saveable behavior in 4.7.2.2 on page 41.
	6	SPF (1b)
	5-0	PAGE CODE (30h)
1	SUBPAGE CODE (02h)	
2-3	PAGE LENGTH	
4-5	Reserved	
6	Restricted	
7	NUMBER OF DRIVE PORT DESCRIPTORS (changeable) - May be set to any number between one and the number of drive Ethernet ports inclusive. Changes will only affect the ports for which a drive Ethernet port descriptor is sent.	

## 8-n Drive Ethernet port descriptors.

The drive Ethernet port descriptors shall be sent in ascending order by RELATIVE TARGET PORT IDENTIFIER (see table 356). The drive Ethernet port descriptor is defined in table 356.

**Table 356 — Drive Ethernet port descriptor of MP 30h[02h]**

Byte	Bit								
	7	6	5	4	3	2	1	0	
0	MSB							DRIVE ETHERNET PORT DESCRIPTOR LENGTH (n-1)	LSB
1									
2	MSB							RELATIVE TARGET PORT IDENTIFIER	LSB
3									
4								Reserved	
5								Reserved	
6								Reserved	DHCP_v4
7	number of ethernet socket address descriptors								
8	Ethernet socket address descriptor [first]								
x								⋮	
y	Ethernet socket address descriptor [last]								
n									

**Byte Description**

0-1 DRIVE ETHERNET PORT DESCRIPTOR LENGTH - The number of bytes to follow in the drive Ethernet port descriptor.

2-3 RELATIVE TARGET PORT IDENTIFIER (changeable) - The relative port identifier of the Ethernet port.

4-5 Reserved

6

**Bit Description**

7-1 Reserved

0 DHCP\_v4 (changeable-saveable)

**Value Description**

1b DHCP shall be used to obtain an additional IPv4 address.

0b DHCP shall not be used to obtain an additional IPv4 address.

7 NUMBER OF ETHERNET SOCKET ADDRESS DESCRIPTORS (changeable) - Shall be set to 01h or 02h.

8-n Ethernet socket address descriptors. (changeable-saveable)

The Ethernet socket address descriptor is defined in 6.6.21.3.1.1 on page 402.

In each Ethernet socket address descriptor the PORT field of the SOCKADDR (see table 351 and table 352) is reserved and shall be set to zero.

In each Ethernet socket address descriptor the FLOW INFO field of the SOCKADDR (see table 352), if any, is reserved and shall be set to zero.

In each Ethernet socket address descriptor the SCOPE ID field of the SOCKADDR (see table 352), if any, is reserved and shall be set to zero.

### 6.6.21.4 MP 30h[20h-(20h)]: Encryption Attributes - Device Attribute Settings

#### 6.6.21.4.1 MP 30h[20h]: Encryption mode - Device Attribute Settings

Mode Page Behaviors (see 4.7 on page 39) describes this device's non-standard behaviors related to mode parameters.

The mode page policy for this page is described in Policy — non-standard (see 4.7.1 on page 39).

The Encryption mode - Device attribute settings mode page allows an application client to query the encryption settings in the drive. If the drive receives an encryption mode - device attribute settings mode page in a Mode Select command it shall reject the command with an ILLEGAL REQUEST, INVALID FIELD IN PARAMETER LIST. The encryption mode - Device attribute settings mode page is defined in table 357.

**Table 357 — MP 30h[20h] Encryption mode mode page**

Byte	Bit							
	7	6	5	4	3	2	1	0
0	PS	SPF(1b)	PAGE CODE (30h)					
1	SUBPAGE CODE (20h)							
2	(MSB)	PAGE LENGTH (0005h)						(LSB)
3								
4	Reserved							
5	ENCRYPTION SOLUTION METHOD							
6	KEY PATH							
7	DEFAULT ENCRYPTION STATE							
8	DENSITY REPORTING							

The Encryption mode - Device attribute settings mode page is not allowed in a Mode Select command. The Encryption mode - Device attribute settings mode page may be used in a Mode Sense command to query the current Encryption settings. Some of the settings likely to be reported are listed in table 358.

**Table 358 — Expected Encryption settings of MP 30h[20h]**

Encryption setting	Method (byte 5)	Key Path (byte 6)	Default Encryption State (byte 7)	Density Reporting (byte 8)
No Encryption	01h	01h	01h	00h
AME (Application Managed Encryption)	03h	01h	01h	00h
LME (Library Managed Encryption) - Barcode policy	04h	01h	03h	00h
LME - Internal label (selects) policy	04h	01h	06h	00h
LME - Internal label (all) policy	04h	01h	07h	00h
LME - Encrypt Always policy	04h	01h	02h	00h
Custom	combinations not listed above			

**Byte Description**

0

**Bit Description**

7 PS (Parameter Saveable): 0b. Ignored in MODE SELECT. See Parameter Saveable behavior in 4.7.2.2 on page 41. Note that the parameters do change in response to configuration changes made via other paths (e.g., through the library).

6 SPF: 1b

5-0 PAGE CODE: 30h

1 SUBPAGE CODE: 20h

2-3 PAGE LENGTH: 05h

4 Reserved

5 ENCRYPTION SOLUTION METHOD:

6 KEY PATH:

7 DEFAULT ENCRYPTION STATE:

8 DENSITY REPORTING:



### 6.6.21.5 MP 30h[40h-44h]: Data processing attributes - Device attribute settings

#### 6.6.21.5.1 MP 30h[40h]: SkipSync - Device attribute settings

See MODE SELECT (6/10) - 15h/55h (see 5.2.10) for how to set these parameters and MODE SENSE (6/10) - 1Ah/5Ah (see 5.2.11) for how to read these parameters.

Mode Page Behaviors (see 4.7 on page 39) describes this device's non-standard behaviors related to mode parameters.

The mode page policy for this page is described in Policy — non-standard (see 4.7.1 on page 39).

Note that mounting a volume that modifies the value of fields in this page does not establish a unit attention condition.

The SkipSync mode page is defined in table 353. SkipSync is a feature that performs a trade-off between how much data can be written to a volume and how fast that data can be written when the data is a small file size. This mode page allows the feature to be enabled and disabled. It also provides information that describes certain aspects of this trade-off, such as the Target Minimum Capacity. This feature is only available for use on volumes that are not scaled and that are not partitioned. The volume must be an Ultrium 5 or newer cartridge.

**Table 359 — MP 30h[40h] SkipSync - Device attribute settings mode page format**

Bit Byte	7	6	5	4	3	2	1	0
0	PS	SPF(1b)	PAGE CODE (30h)					
1	SUBPAGE CODE (40h)							
2	(MSB)	PAGE LENGTH 10h						(LSB)
3								
4	Reserved				SV		ENABLE	
5	Reserved							
6	Reserved							
7	SKIPSYNC POLICY							
8	(MSB)	TARGET MINIMUM CAPACITY						(LSB)
11								
12	(MSB)	Vendor-restricted						(LSB)
15								
16	(MSB)	Vendor-restricted						(LSB)
19								

#### Byte Description

0	
	<b>Bit Description</b>
7	PS (Parameter Saveable): 1b. Ignored in MODE SELECT. See Parameter Saveable behavior in 4.7.2.2 on page 41. It is recommended that users set the SP bit of the MODE SELECT command to one.
6	SPF (SubPage Format): 1b
5-0	PAGE CODE: 30h
1	SUBPAGE CODE: 40h
2-3	PAGE LENGTH: 10h

4

<b>Bit</b>	<b>Description</b>
7-3	Reserved
2-1	sv (SkipSync Validity): (changeable-ignored)

Note that mounting a volume that modifies the value of this field does not establish a unit attention condition.

<b>Value</b>	<b>Description</b>
00b	There is no volume mounted, or SkipSync is not valid for mounted volume.
01b	SkipSync valid for mounted volume but SKIPSYNC POLICY field not supported
others	Reserved

0 ENABLE: 0b (changeable-saveable)

<b>Value</b>	<b>Description</b>
0b	The SkipSync function is disabled.
1b	The SkipSync function is enabled. The drive operates in a manner to increase performance and reduce backhitches while still performing synchronizations on small file writes.

5-6 Reserved

7 SKIPSYNC POLICY:

The SkipSync Policy field indicates the algorithm used in performing the SkipSync operations.

<b>Value</b>	<b>Description</b>
00h	Sync performance allowing capacity reduction (a MODE SENSE command may be used to report in, other fields, the limits; e.g., TARGET MINIMUM CAPACITY) The overall capacity may be reduced to the value reported in the TARGET MINIMUM CAPACITY field (at the time of publication this reduction may be up to 33%) depending on the transfer characteristics (e.g., transfer rate and the interval between the sync completion and the next data transfer).

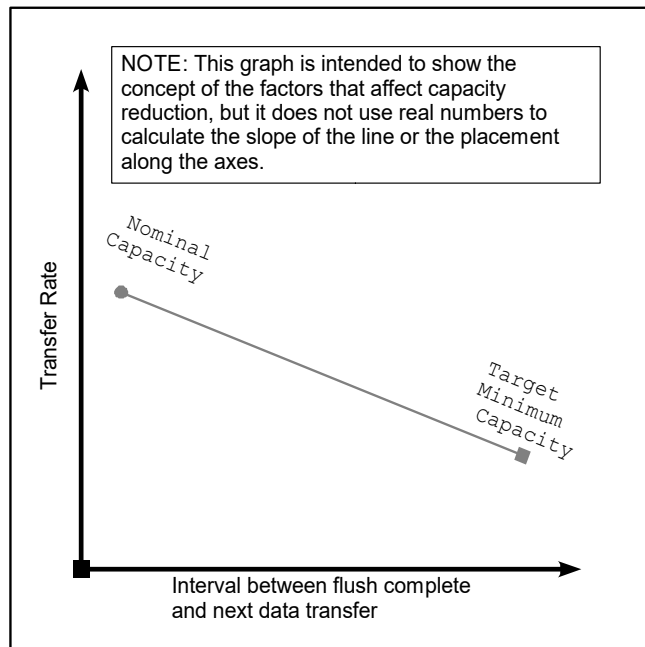

8-11 TARGET MINIMUM CAPACITY (MiB): (changeable-ignored)

This field indicates the target capacity in mebibytes ( $2^{20}$ ) to which the capacity of the current partition when full may be decreased in order to perform SkipSync operations. The total capacity may be smaller than TARGET MINIMUM CAPACITY if the average of transaction sizes is very small.

If the mounted volume is not capable of supporting skipsync this field is set to zero.

12-15 Vendor-restricted

16-19 Vendor-restricted

### 6.6.21.5.2 MP 30h[42h]: End of partition behavior control - Device attribute settings

The End of partition behavior control - Device attribute settings mode page is defined in table 353.

Mode Page Behaviors (see 4.7 on page 39) describes this device's non-standard behaviors related to mode parameters.

The mode page policy for this page is described in Policy — non-standard (see 4.7.1 on page 39).

**Table 360 — MP 30h[42h] End of partition behavior control - Device attribute settings mode page format**

Byte	Bit								
	7	6	5	4	3	2	1	0	
0	ps	spf(1b)	PAGE CODE (30h)						
1	SUBPAGE CODE (42h)								
2	(MSB)	PAGE LENGTH (n-3)							
3							(LSB)		
4	LEOP METHOD								

The following parameters apply:

#### Byte Description

0 Byte zero

##### Bit Description

7 PS (Parameter Saveable): 1b. Ignored in MODE SELECT. See Parameter Saveable behavior in 4.7.2.2 on page 41.

6 SPF (1b)

5-0 PAGE CODE: 30h

1 SUBPAGE CODE (42h)

2-3 PAGE LENGTH

4 LEOP METHOD - Logical end of partition (LEOP) method: 00h (changeable-saveable)

##### Value Description

00h LEOP is determined by density code  
(i.e., Ultrium 4 and earlier use maximize capacity; Ultrium 5 and later use constant capacity)

Value	Description
others	Constant medium capacity
40h to 46h	Maximize medium capacity

01h Maximize medium capacity - LEOP is based on the amount of physical medium available. Early warning is based on the drive's buffer size, the nominal physical dataset length, and some margin (i.e., the drive will accept write request before LEOP if there is tape available).

02h Constant medium capacity - LEOP is determined to provide constant medium capacity. Early warning is based on the user's logical data capacity already written to the tape (i.e constant capacity). If the medium condition or drive condition is degraded enough to reach a predetermined LPOS tape region, then LEOP may be reached prior to the constant capacity.

others Reserved

### 6.6.21.5.3 MP 30h[43h]: Feature switches - Device attribute settings

The Feature switches - Device attribute settings mode page is defined in table 361.

This page is defined as common to all initiators.

**Table 361 — MP 30h[43h] Feature switches - Device attribute settings mode page format**

Byte	Bit								
	7	6	5	4	3	2	1	0	
0	ps	spf(1b)	PAGE CODE (30h)						
1	SUBPAGE CODE (43h)								
2	(MSB)	PAGE LENGTH (10h)						(LSB)	
3									
4	Reserved					E_12VPC	E_ARCHIVE	D_BOPC	
5									
19	Reserved								

The following parameters apply:

#### Byte Description

0 Byte zero

##### Bit Description

7 PS - parameters saveable: 1b. Ignored in MODE SELECT. See Parameter Saveable behavior in 4.7.2.2 on page 41.

6 SPF (1b)

5-0 PAGE CODE: 30h

1 SUBPAGE CODE (43h)

2-3 PAGE LENGTH

4

##### Bit Description

7-3 Reserved

2 E\_12VPC (Enable 12V during IDLE\_C power condition): 0b (changeable-saveable) LTO7+

This control determines if the 12V power is disabled or enabled while transitioning from the active power condition to the IDLE\_C power condition. Any changes will not take effect until the the drive subsequently transitions from the active power condition to the IDLE\_C power condition.

##### Value Description

0b The 12V power is disabled while transitioning from the active power condition to the IDLE\_C power condition

1b The 12V power is not disabled while transitioning from the active power condition to the IDLE\_C power condition.

1 E\_ARCHIVE (Enable Archive mode unthread): 0b (changeable-saveable) for LTO7 and LTO8 and (changeable-ignored) in LTO9 and later.

See Archive mode unthread (LTO7+) (see 4.3)

==== WARNING ===== WARNING =====

See Archive mode unthread (LTO7+) (see 4.3) for warnings.

==== WARNING ===== WARNING =====

0 D\_BOPC (Disable BOP Cache): 0b (changeable)

This control indicates if the BOP cache information is used during a reposition operation. It does not alter the accumulation of BOP cache information.

<b>Value</b>	<b>Description</b>
--------------	--------------------

0b	Use cached BOP information (if available) to perform positioning requests (see 4.5.2)
----	---

1b	Ignore cached BOP information when performing positioning requests (e.g., Perform physical positioning and read data sequentially into buffer from BOP)
----	---

5-19 Reserved

#### 6.6.21.5.4 MP 30h[44h]: Preferred Cartridge Type — Device attribute settings

The Preferred Cartridge Type — Device attribute settings mode page is defined in table 361. The parameters in this mode page are set to their saved values when the volume transitions to no longer present (i.e., the medium present bit of VHF data in LP11h DT device status changes from 1b to 0b).

NOTE 65 - The application client (e.g., Library) should explicitly set the preferred cartridge type back to the default if conditions occur such that no volume gets unloaded (e.g., volume does not get mounted) in order to ensure a subsequent cartridge does not have its type accidentally changed.

The mode page policy for this page is Shared.

This mode page is common between LUN 0 (i.e., the SSC device server) and LUN 2 (i.e., the ADC device server). A change of a mode parameter on a specific LUN shall not establish a Unit Attention condition on the other LUN.

It is strongly encouraged that automation application clients access this mode page on LUN2.

It is strongly encouraged that application clients perform a read-modify-write sequence (i.e., MODE SENSE, modify desired values, MODE SELECT) when updating this mode page.

**Table 362 — MP 30h[44h] Preferred Cartridge Type — Device attribute settings mode page format**

Byte	Bit								
	7	6	5	4	3	2	1	0	
0	PS	SPF(1b)	PAGE CODE (30h)						
1	SUBPAGE CODE (44h)								
2	(MSB)	PAGE LENGTH (n-3)						(LSB)	
3									
4	Preferred cartridge descriptor [first]								
7									
	.								
	.								
	.								
n-3	Preferred cartridge descriptor [last]								
n									

The following parameters apply:

#### Byte Description

0	Byte zero
	<b>Bit Description</b>
	7 PS - parameters saveable: 1b. Ignored in MODE SELECT.
	6 SPF (1b)
	5-0 PAGE CODE: 30h
1	SUBPAGE CODE (44h)
2-3	PAGE LENGTH
4-7	Preferred cartridge descriptor [first]: The Preferred cartridge descriptor is defined in 6.6.21.5.4.1. There is one cartridge descriptor for each cartridge type supported by the device (see table 364).
...	
n-3	Preferred cartridge descriptor [last]:

### 6.6.21.5.4.1 Preferred cartridge descriptor

A 4-byte tuple that defines a preferred cartridge type.

**Table 363 — Preferred cartridge descriptor format**

Byte	Bit							
	7	6	5	4	3	2	1	0
0	MEDIUM TYPE							
1	PREFERRED DENSITY							
2	Reserved							
3								

#### Byte Description

- 0 MEDIUM TYPE: (non-changeable) A value indicating the physical cartridge type (see mode parameter header).
- 1 PREFERRED DENSITY: (changeable-saveable) The density preferred for use with a Type M eligible cartridge (see 2.1.256), if:
- C) initialization is performed on the cartridge;
  - D) a destructive overwrite is performed. For example:
    - a) a format operation is performed on the cartridge; or
    - b) logical object identifier zero of BOP 0 is written to the cartridge and the volume is a single partition volume.

NOTE 66 - The preferred cartridge setting is only used when a cartridge is Type M eligible (see 2.1.256), the cartridge is a Type A cartridge (see 2.1.254). Regardless of the preferred cartridge setting, a Type M cartridge (see 2.1.255) will not be changed back to a Type A cartridge.

#### Value Description

00h Use native cartridge density (e.g., Ultrium 7 cartridge use “Ultrium-7” density (see table 113))

others If supported density, set to that density. If not a supported density, terminate the command with CHECK CONDITION status, with sense key set to ILLEGAL REQUEST, with additional sense code set to INVALID FIELD IN PARAMETER LIST (5/2600).

2-3 Reserved

### 6.6.21.5.4.2 Preferred Cartridge Type support

The medium type—preferred density pairs that are supported are shown in table 364.

**Table 364 — Supported “medium type—preferred density” pairs**

Product	MEDIUM TYPE	PREFERRED DENSITY <sup>a</sup>
LTO-1 to LTO-7	n/a	n/a
LTO-8	78h (i.e., Ultrium 7 DATA volume)	5Ch (i.e., “U-732 “ density) <sup>b</sup>
		5Dh (i.e., “U-832M “ density)
	7Ch (i.e., Ultrium 7 WORM volume)	5Ch (i.e., “U-732 “ density)
	88h (i.e., Ultrium 8 DATA volume)	5Eh (i.e., “U-832 “ density)
	8Ch (i.e., Ultrium 8 WORM volume)	5Eh (i.e., “U-832 “ density)
<sup>a</sup> See DENSITY NAME in Table 113, Density information LTO-7 and later. <sup>b</sup> Default.		



### 6.6.22 MP 3Eh: Engineering Support

See MODE SELECT (6/10) - 15h/55h (see 5.2.10 on page 95) for how to set these parameters and MODE SENSE (6/10) - 1Ah/5Ah (see 5.2.11 on page 96) for how to read these parameters.

Mode Page Behaviors (see 4.7 on page 39) describes this device's non-standard behaviors related to mode parameters.

The mode page policy returned in IP 87h: Mode Page Policy (see 6.3.6 on page 238) for this page is described in Policy — non-standard (see 4.1.1 on page 2). However, the behavior related to mode page policy for this page is not defined, and may contain elements which are common to all initiators, as well as elements which are initiator unique.

NOTE 67 - As this page is not for normal application use, it is not returned in mode page 3Fh (all pages). Consequently, this page must be specifically queried and set.

NOTE 68 - For more information on special needs and the usage of this page contact IBM.

**Table 365 — MP 3Eh: Engineering Support mode page**

Byte	Bit								
	7	6	5	4	3	2	1	0	
0	PS	SPF (0b)	PAGE CODE (3Eh)						
1	PAGE LENGTH ( $n-1$ )								
2	Vendor-reserved								
127									

#### Byte Description

0

##### Bit Description

7 PS (Parameter Saveable): 0b. Ignored in MODE SELECT. See Parameter Saveable behavior in 4.7.2.2 on page 41.

6 SPF (SubPage Format): 0b

5-0 PAGE CODE: 3Eh

1 PAGE LENGTH: 7Eh

2-127 Vendor-Reserved



## 6.7 Read/Write Buffers (RB)

Read/Write Buffers are used with the READ BUFFER command (see 5.2.18) and/or the WRITE BUFFER command (see 5.2.44).

### 6.7.1 Read/Write Buffer Modes

#### 6.7.1.1 MODE [00h] – Combined header and data

In this mode in response to a READ BUFFER command, a four-byte header followed by data bytes is returned to the application client in the Data-In Buffer. The allocation length should be set to four or greater.

The BUFFER ID field identifies a specific buffer within the device. If an unsupported buffer ID code is selected, the command is terminated with CHECK CONDITION status, with the sense key set to ILLEGAL REQUEST, and the additional sense code set to INVALID FIELD IN CDB (5/2400h).

The four-byte READ BUFFER header (see table 366) is followed by data bytes from the buffer.

**Table 366 — READ BUFFER header**

Byte	Bit							
	7 msb	6	5	4	3	2	1	0 lsb
0	Reserved							
1	BUFFER CAPACITY							
3								
4	Data							
n								

The following parameters apply:

#### Byte Description

- 0 Reserved
- 1-3 BUFFER CAPACITY: The total number of data bytes available in the buffer.
- 4-n Data: Data from the buffer specified by the BUFFER ID field.

In this mode in a WRITE BUFFER command, the four-byte header consists of all reserved bytes.

The MODE SPECIFIC field of the WRITE BUFFER command is reserved.

The PARAMETER LIST LENGTH field of the WRITE BUFFER command is as specified in the *The following parameters apply* description of the WRITE BUFFER command.

#### 6.7.1.2 MODE [02h] – Data

In this mode, the Buffer is logical unit buffer data. The BUFFER ID field identifies a specific buffer within the device. If an unsupported buffer ID code is selected, the command is terminated with CHECK CONDITION status, with the sense key set to ILLEGAL REQUEST, and the additional sense code set to INVALID FIELD IN CDB (5/2400h).

The BUFFER OFFSET field of the READ BUFFER command CDB contains the byte offset within the specified buffer from which or to which data is transferred. The application client should conform to the offset boundary requirements returned in the READ BUFFER descriptors (MODE [03h] (RB)– Descriptor (see 6.7.1.3 on page 422) or MODE [07h] (RB) – Descriptor with algorithmic offset boundary (see 6.7.1.8 on page 423)). If the device server is unable to accept the specified buffer offset, the command is terminated with CHECK

CONDITION status, with the sense key set to ILLEGAL REQUEST, and the additional sense code set to INVALID FIELD IN CDB.

### 6.7.1.3 MODE [03h] (RB)– Descriptor

This mode is limited to the READ BUFFER command. A maximum of four bytes of READ BUFFER descriptor information is returned. The BUFFER OFFSET field is reserved in this mode. The allocation length should be set to four or greater. The READ BUFFER descriptor is defined as shown in table 367.

**Table 367 — READ BUFFER descriptor**

Byte	Bit								
	7 msb	6	5	4	3	2	1	0 lsb	
0	OFFSET BOUNDARY								
1	(MSB)								
3	BUFFER CAPACITY							(LSB)	

The following parameters apply:

#### Byte Description

0 OFFSET BOUNDARY:

For READ BUFFER commands, the OFFSET BOUNDARY field applies to the following modes:

- c) MODE[02h] – Data (see 6.7.1.2); and
- d) MODE[1Ch] – Error history (see 6.7.1.13).

For WRITE BUFFER commands, the OFFSET BOUNDARY field applies to the following modes:

- a) MODE [02h] – Data (see 6.7.1.2 on page 421);
- b) MODE [04h] (WB) – Download microcode and activate (see 6.7.1.4 on page 422);
- c) MODE [05h] (WB) – Download microcode, save, and activate (see 6.7.1.5 on page 423);
- d) MODE [06h] (WB) – Download microcode with offsets and activate (see 6.7.1.6 on page 423);
- e) MODE [07h] (WB) – Download microcode with offsets, save, and activate (see 6.7.1.7 on page 423); and
- f) mode [0Dh] (WB) – Download microcode with offsets, select activation, save, and defer activate mode (see 6.7.1.11 on page 424).

The boundary alignment indicated by the OFFSET BOUNDARY field applies only to the buffer specified by the BUFFER ID field.

#### Value Description

others Multiples of  $2^{\text{code}}$  (e.g., 00h means multiples of 1 byte or no offset restrictions, 01h means multiples of 2 bytes or even offsets, 02h means multiples of 4 bytes)

80h to FEh The offset and capacity values are shifted by n where n is the value returned in the OFFSET BOUNDARY field using the equation  $80h \mid n$  (e.g., 86h indicates shift value left by 6 bits)

FFh 000000h is the only supported buffer offset

1-3 BUFFER CAPACITY: The size in bytes of the data available in the buffer specified by the BUFFER ID field for the:

- a) READ BUFFER command with data mode (i.e., 02h); and
- b) WRITE BUFFER command with data mode (i.e., 02h).

### 6.7.1.4 MODE [04h] (WB) – Download microcode and activate

This mode is the same as MODE [07h] (WB) – Download microcode with offsets, save, and activate (see 6.7.1.7 on page 423).

**6.7.1.5 MODE [05h] (WB) – Download microcode, save, and activate**

This mode is the same as **MODE [07h] (WB) – Download microcode with offsets, save, and activate** (see 6.7.1.7 on page 423).

**6.7.1.6 MODE [06h] (WB) – Download microcode with offsets and activate**

This mode is the same as **MODE [07h] (WB) – Download microcode with offsets, save, and activate** (see 6.7.1.7 on page 423).

**6.7.1.7 MODE [07h] (WB) – Download microcode with offsets, save, and activate**

In this mode for the WRITE BUFFER command, microcode is transferred to the device, saved to nonvolatile storage, and activated.

The MODE SPECIFIC field in the WRITE BUFFER command is reserved.

The BUFFER ID field in the WRITE BUFFER command is ignored.

**6.7.1.8 MODE [07h] (RB) – Descriptor with algorithmic offset boundary**

In this mode for the READ BUFFER command, the OFFSET BOUNDARY field determines how the BUFFER OFFSET and BUFFER CAPACITY fields (see table 367) are interpreted for modes that do not ignore the BUFFER ID field. The OFFSET BOUNDARY values are interpreted as follows:

Value	Description
00h to 7Fh	The offset and capacity values are specified in multiples of 64 bytes (i.e., shifted by 6 bits)
80h to FEh	The offset and capacity values are shifted by n where n is the value returned in the OFFSET BOUNDARY field using the equation $80h   n$ (e.g., 86h indicates shift value left by 6 bits)
FFh	000000h is the only supported buffer offset

**6.7.1.9 MODE [0Ah] – Echo buffer**

In this mode, parameter data is transferred in a WRITE BUFFER command and saved to an echo buffer which is returned as parameter data in a READ BUFFER command.

If no WRITE BUFFER command with the mode set to echo buffer received on this I\_T\_L nexus has completed without an error, then the READ BUFFER command terminates with CHECK CONDITION status, with the sense key set to ILLEGAL REQUEST, and the additional sense code set to COMMAND SEQUENCE ERROR. If the data in the echo buffer has been overwritten by another I\_T\_L nexus, then the READ BUFFER command is terminated with CHECK CONDITION status, with the sense key set to ABORTED COMMAND, and the additional sense code set to ECHO BUFFER OVERWRITTEN.

The BUFFER ID and BUFFER OFFSET fields are ignored in this mode.

**6.7.1.10 MODE [0Bh] (RB) – Echo buffer descriptor**

In this mode, a maximum of four bytes of READ BUFFER descriptor information is returned. The device server returns the descriptor information for the echo buffer. The BUFFER ID field and BUFFER OFFSET field are reserved in

this mode. The allocation length should be set to four or greater. The READ BUFFER descriptor is defined as shown in table 368.

**Table 368 — Echo buffer descriptor**

Byte	Bit								
	7 msb	6	5	4	3	2	1	0 lsb	
0	Reserved							EBOS	
1	Reserved								
2	Reserved			(MSB)					
3	BUFFER CAPACITY							(LSB)	

The following parameters apply:

**Byte Description**

0

Bit	Description
7-1	Reserved
0	EBOS (echo buffer overwritten supported): 1b

1 Reserved

2-3 BUFFER CAPACITY: The size of the echo buffer in bytes aligned to a four-byte boundary. The maximum echo buffer size is 4 096 bytes.

**6.7.1.11 MODE [0Dh] (WB) – Download microcode with offsets, select activation, save, and defer activate mode**

In this mode, microcode is transferred to the device server using one or more WRITE BUFFER commands, saved to nonvolatile storage, and considered deferred. The deferred microcode is activated if a WRITE BUFFER command with the activate deferred microcode mode (0Fh) is processed (see 6.49.11).

The MODE SPECIFIC field (see page 181) specifies additional events that may be selected to activate the deferred microcode.

The BUFFER ID field, BUFFER OFFSET field, and PARAMETER LIST LENGTH field are defined in WRITE BUFFER - 3Bh (see 5.2.44 on page 181).

**6.7.1.12 MODE [0Fh] (WB) – Activate deferred microcode mode**

In this mode, deferred microcode is activated.

The MODE SPECIFIC field is reserved.

The the BUFFER ID field, the BUFFER OFFSET field, and the PARAMETER LIST LENGTH field are ignored.

If there is no deferred microcode the WRITE BUFFER command is terminated with CHECK CONDITION status, with the sense key set to ILLEGAL REQUEST, and the additional sense code set to COMMAND SEQUENCE ERROR (5/2C00h).

**6.7.1.13 MODE [1Ch] (RB) – Error history**

**6.7.1.13.1 Error history overview**

This mode is used to manage and retrieve error history (see 4.22).

If the device is unable to process a READ BUFFER command with the MODE field set to 1Ch, then the device terminates the READ BUFFER command with CHECK CONDITION status, with the sense key set to ILLEGAL REQUEST, and the additional sense code set to COMMAND SEQUENCE ERROR.

See Supported Buffers when the mode field is 1Ch (see 6.7.2.7 on page 432) for a description of the BUFFER ID and the actions the device performs, and parameter data, if any, that the device returns.

## 6.7.2 Supported Buffers

Table 369 lists the supported buffers.

**Table 369 — Supported Buffer IDs**

ID	RB modes	WB modes	Buffer Description	OFFSET BOUNDARY
-	A	A	See MODE [0Ah] – Echo buffer (see 6.7.1.9 on page 423)	-
-	B		See MODE [0Bh] (RB) – Echo buffer descriptor (see 6.7.1.10 on page 423)	-
-	1C		See Supported Buffers when the mode field is 1Ch (see 6.7.2.7 on page 432)	
-		4,5,6,7 ,D	Firmware If one of the listed modes is specified, the BUFFER ID is ignored and the command is treated as a Firmware buffer)	02h
-		F	Activate deferred Firmware	-
01h	0,2,3		Dump Data Dump data should be read in a series of blocks larger than 64 KiB and smaller than 1 MiB (for example 256 KiB) with strictly increasing offsets	02h
02h	0,2,3	0,2	Test	02h
04h	0,2,3	2,	Firmware	02h
05h	0,2,3		Cartridge Memory	02h
06h	0,2,3		RB 06h: Error Log (aka. Engineering Log) (see 6.7.2.1 on page 426)	02h
07h	0,2,3		RB 07h: SCSI Log (aka Error log) (see 6.7.2.2 on page 427)	02h
08h	0,2,3		RB 08h: World Wide Name (see 6.7.2.3 on page 427)	02h
19h	0,2,3	0,2	RB 19h: Host non-volatile (see 6.7.2.4 on page 428)	FFh
20h	0,2,3		Cartridge Memory (same as Buffer ID 05h)	02h
21h	0,2,3		RB 21h: Cartridge Memory from EOD dataset (see 6.7.2.5 on page 428)	02h
50h	0,2,3		RB 50h: Active IP addresses (see 6.7.2.6 on page 428)	00h
Legend				
- Not Applicable				
a				

### 6.7.2.1 RB 06h: Error Log (aka. Engineering Log)

The error log buffer (also known as Engineering Log) contains zero or more entries described in table 370. Entries are returned in order by the most recent entry first. Each entry represents a unique occurrence of an error.

**Table 370 — Error Log Buffer (06h)**

Byte	Bit							
	7	6	5	4	3	2	1	0
0	(MSB)							
3	TIME STAMP							(LSB)
4	ENTRY NUMBER							
5	ERROR CODE							
6	FSC 1ST TEXT							
7	FSC 1ST DATA							
8	FSC 2ND TEXT							
9	FSC 2ND DATA							
10	CARTRIDGE SERIAL NUMBER							
11	LINK LEVEL							
12	HARDWARE LEVEL							
13								
14								
21								
22								
27								
28								
31								

The following parameters apply to the Error Log Buffer:

#### Byte Description

- 0-3 TIME STAMP: The value of the drive's timestamp at the time of the error. This timestamp may be the power-on seconds or it may be the value of the timestamp as set by the library or the host converted to seconds since 01 January 2001 00:00:00. It is generally not sufficient on its own to provide relative ordering of the entries.
- 4 ENTRY NUMBER: This is a value used internally to the drive.
- 5 ERROR CODE: The error code used for the Single Character Display.
- 6-7 FSC 1ST TEXT: Fault Symptom Code text
- 8-9 FSC 1ST DATA: Fault Symptom Code data
- 10-11 FSC 2ND TEXT: Fault Symptom Code text
- 12-13 FSC 2ND DATA: Fault Symptom Code data
- 14-21 CARTRIDGE SERIAL NUMBER: This is the cartridge serial number of the volume that was mounted in the drive when the error occurred. The cartridge serial number is set using this priority:
  - 1) Volume Serial Number set by library;
  - 2) Volume Serial Number set by host; then
  - 3) Cartridge Serial Number from Cartridge Memory.
- 22-27 LINK LEVEL: The link level of the code that was loaded in the drive when the error occurred.
- 28-31 HARDWARE LEVEL: Not used.



### 6.7.2.2 RB 07h: SCSI Log (aka Error log)

The SCSI Log Buffer contains 10 entries, each of which has the format described in table 371. An entry is created each time sense data with a Sense Key 3h or 4h is returned with a CHECK CONDITION Status to a command that is received on LUN 0.

**Table 371 — SCSI Log Buffer (07h)**

Byte	Bit							
	7	6	5	4	3	2	1	0
0	(MSB)							
3	TIME STAMP (seconds)							
4	(LSB)							
4	ENTRY NUMBER							
5	INITIATOR SCSI ID							
6	SCSI STATUS							
7	Reserved							
8	CDB							
23								
24	SENSE DATA							
59								

The following parameters apply:

#### Byte Description

- 0-3 TIME STAMP: The value of the drive's timestamp at the time of the error. This timestamp may be the power-on seconds or it may be the value of the timestamp as set by the library or the host converted to seconds since 01 January 2001 00:00:00. It is generally not sufficient on its own to provide relative ordering of the entries.
- 4 ENTRY NUMBER: A value of 0 indicates that the entry is not valid. The scheme used for setting the Entry Number is not described in this manual.
- 5 INITIATOR SCSI ID: The least significant byte of the address used to identify the initiator (e.g., on Fibre Channel drives the ALPA)
- 6 SCSI STATUS: The value that would be returned as SCSI Status.
- 7 Reserved
- 8-23 CDB: The contents of the CDB that was presented the CHECK CONDITION Status even if that CHECK CONDITION is for a DEFERRED ERROR.
- 24-59 SENSE DATA: The sense data that was created as a result of this error.

### 6.7.2.3 RB 08h: World Wide Name

This buffer contains the World Wide Name values that are used by the drive.

Table 372 — World Wide Name Buffer (08h)

Byte	Bit							
	7	6	5	4	3	2	1	0
0	(MSB) _____							
7	WORLD WIDE NODE NAME							(LSB)
8	(MSB) _____							
15	WORLD WIDE PORT NAME							(LSB)

The following parameters apply:

#### Byte Description

- 0-7 WORLD WIDE NODE NAME: The world wide identifier used by the drive to identify LUN 0.  
 8-15 WORLD WIDE PORT NAME: The world wide identifier used by the drive port through which the READ BUFFER command was received.

#### 6.7.2.4 RB 19h: Host non-volatile

The Host non-volatile buffer is intended for use by an application to write or read information that is to be stored in non-volatile memory. This data is also captured in drive dumps.

The size of this buffer may be determined by using a READ BUFFER (see 5.2.18) with mode 03h (see 6.7.1.3).

#### 6.7.2.5 RB 21h: Cartridge Memory from EOD dataset

The Cartridge Memory from EOD dataset buffer provides a method to retrieve the copy of cartridge memory (CM) that exists in the EOD dataset. This is used for debug and error recovery only.

The volume must be positioned at the EOD from which the CM contents will be read (e.g., issue LOCATE to desired partition then issue SPACE EOD then issue the READ BUFFER command). If the medium is not positioned at EOP, then the READ BUFFER command is rejected with CHECK CONDITION status and Sense Key set to ILLEGAL REQUEST with the additional sense code set to SEQUENTIAL POSITIONING ERROR. If the medium is positioned at EOP and the EOD cannot be found the READ BUFFER command is rejected with CHECK CONDITION status and Sense Key set to MEDIUM ERROR with the additional sense code set to END-OF-DATA NOT FOUND.

#### 6.7.2.6 RB 50h: Active IP addresses

The Active IP addresses buffer returns a list of IP addresses that have successfully completed negotiation on the Ethernet link and are active. This list does not contain IP addresses that the drive attempts but cannot use due to conflicts or other errors. The format of the Data field of the active IP addresses buffer depends on the value in byte 0. If byte 0 contains a non-zero value, then the format is defined in Active IP addresses fixed buffer (LTO5 only) (see 6.7.2.6.1). If byte 0 contains a zero value, then the format is defined in the Active IP addresses variable buffer (LTO6 and later) (see 6.7.2.6.2).

### 6.7.2.6.1 Active IP addresses fixed buffer (LTO5 only)

The format of the Data field of the active IP addresses fixed buffer is described in table 373

**Table 373 — Active IP addresses fixed buffer format (50h)**

Byte	Bit							
	7	6	5	4	3	2	1	0
0	NUMBER OF ETHERNET PORTS							
1	SIZE OF SOCKADDR (m-2)							
2	NUMBER OF SOCKADDR STRUCTURES							
List of sockaddr structures (see 6.6.21.3.1.1.1 or 6.6.21.3.1.1.2)								
3	sockaddr [first]							
m	⋮							
n-(m-3)	sockaddr [last]							
n								

The following parameters apply:

#### Byte Description

- 0 NUMBER OF ETHERNET PORTS - The number of physical Ethernet ports functioning in the drive.
- 1 SIZE OF SACKADDR - The size of each sockaddr. All sockaddr's are the same size
- 2 NUMBER OF SOCKADDR - The number of sockaddr structures returned.
- 3-n List of sockaddr structures. Each sockaddr structure describes one active IP address. The sockaddr structure is defined in clauses Sockaddr for an IPv4 IP address (see 6.6.21.3.1.1.1 on page 403) and Sockaddr for an IPv6 address (see 6.6.21.3.1.1.2 on page 403).

6.7.2.6.2 Active IP addresses variable buffer (LTO6 and later)

The format of the Data field of the active IP addresses buffer is described in table 373

**Table 374 — Active IP addresses variable buffer format (50h)**

Byte	Bit							
	7	6	5	4	3	2	1	0
0	Reserved							
1								
2	ACTIVE IP ADDRESSES BUFFER LENGTH (n-3)							
3								
4	Reserved							
6								
7	NUMBER OF ETHERNET PORTS							
List of Ethernet port descriptors								
8	Ethernet port variable descriptor [first]							
	⋮							
	Ethernet port variable descriptor [last]							
n								

The following parameters apply:

**Byte Description**

- 0 NUMBER OF ETHERNET PORTS - The number of physical Ethernet ports functioning in the drive.
- 1-n List of Ethernet port descriptors. There is one Ethernet port descriptor (see table 375) for each physical Ethernet port functioning in the drive. The size of each descriptor may vary from Ethernet port to Ethernet port.

The Ethernet port variable descriptor format is defined in table 375

**Table 375 — Ethernet port variable descriptor format**

Byte	Bit							
	7	6	5	4	3	2	1	0
0	DESCRIPTOR LENGTH (m-1)							
1	PORT IDENTIFIER							
2	Reserved							
3	NUMBER OF SOCKADDR STRUCTURES							
4	List of Ethernet socket address descriptors (see 6.6.21.3.1.1)							
5	Ethernet socket address descriptor [first]							
6	⋮							
7	Ethernet socket address descriptor [last]							
m								

The following parameters apply:

**Byte Description**

- 0 SIZE OF SACKADDR - The size of each sockaddr. All sockaddr's are the same size
- 1 number of sockaddr - The number of sockaddr structures returned.
- 2-n List of Ethernet socket address descriptors. Each Ethernet socket address descriptor describes one active IP address and has the RELATIVE SOCKET ADDRESS IDENTIFIER field set to zero. The Ethernet socket address descriptor is defined in Ethernet socket address descriptor (see 6.6.21.3.1.1 on page 402).

### 6.7.2.7 Supported Buffers when the MODE field is 1Ch

The BUFFER ID field (see table 376) specifies the action that the device performs, and the parameter data, if any, that the device returns.

**Table 376 — Error history BUFFER ID field**

Code	Description	Buffer offset	Error history I_T_L nexus constrained	Reference
00h	Return error history directory	0000h	Yes	6.7.2.7.1
01h	Return error history directory and create new error history snapshot	0000h	Yes	6.7.2.7.1
02h	Return error history directory and establish new error history I_T_L nexus	0000h	No	6.7.2.7.1
03h	Return error history directory, establish new error history I_T_L nexus, and create new error history snapshot	0000h	No	6.7.2.7.1
04h to 0Fh	Reserved		Yes	
10h to EFh	Return error history	0000h to FFFFh	Yes	6.7.2.7.3
10h	Return current error history snapshot: A drive dump created at the most recent snapshot event (i.e. snapshot –no embedded dumps).			6.7.2.7.3.2
11h	Return mini dump: A dump created at the most recent Send Diagnostic with Diagnostic ID 0163h.			6.7.2.7.3.3
20h	Return emergency dump (e.g., a dump copied to flash by copy to flash request)			6.7.2.7.3.4
21h to 28h	Return prioritized dump in flash (i.e., 21h is the highest priority and 28h is the lowest priority)			6.7.2.7.3.5
29h to EEh	Reserved for future error histories			
EFh	Return error history names list			6.7.2.7.3.6
F0h to FDh	Reserved		Yes	
FEh	Clear error history I_T_L nexus	Ignored	Yes	6.7.2.7.4
FFh	Clear error history I_T_L nexus and release error history snapshot	Ignored	Yes	6.7.2.7.5

The command is terminated with CHECK CONDITION status with the sense key set to ILLEGAL REQUEST and the additional sense code set to OPERATION IN PROGRESS if the device receives a READ BUFFER command:

- a) with the MODE field set to 1Ch;
- b) with the BUFFER ID field set to a value that table 376 shows as constrained by error history I\_T\_L nexus;

- c) if an error history I\_T\_L nexus exists and the command is received from an I\_T\_L nexus that is different than that I\_T\_L nexus; and
- d) an error history snapshot exists.

The BUFFER OFFSET field specifies the byte offset from the start of the buffer specified by the BUFFER ID field from which the device returns data. The application client should conform to the offset boundary requirements indicated in the READ BUFFER descriptor (see 6.7.1.3). If the buffer offset is not one of those shown in table 376 or the device is unable to accept the specified buffer offset, then the device terminates the READ BUFFER command with CHECK CONDITION status, with the sense key set to ILLEGAL REQUEST, and the additional sense code set to INVALID FIELD IN CDB.

#### 6.7.2.7.1 MODE [1Ch] 00h to 03h: Error history directory

Whenever allowed by established error history I\_T\_L nexus constraints (see 6.7.1.13), if any, all error history device actions return an error history directory (see table 378). Some error history device actions also discard the existing error history snapshot and create a new error history snapshot (see table 377). If there is no current error history snapshot and no minidump, then a new Current Error History Snapshot is forced.

**Table 377 — Summary of error history directory device actions**

BUFFER ID field	Establish new error history I_T_L nexus	Current error history snapshot	
		Preserved (if exists)	Created
00h	No <sup>a</sup>	Yes	No <sup>b</sup>
01h	No <sup>a</sup>	No	Yes
02h	Yes	Yes	No <sup>b</sup>
03h	Yes	No	Yes

<sup>a</sup> If no error history I\_T\_L nexus is established, a new one is established.

<sup>b</sup> If no Current error history snapshot and no minidump exists, a new one is created.

The error history directory is defined in table 378.

**Table 378 — Error history directory**

Bit Byte	7	6	5	4	3	2	1	0
0	(MSB)							
7	t10 vendor identification							(LSB)
8	version							
9	Reserved			ehs_retrieved		ehs_source		clr_sup
10	Reserved							
29	Reserved							
30	(MSB)							
31	DIRECTORY LENGTH (n-31)							(LSB)
Error history directory list								
32	Error history directory entry [first]							
39	(see table 379)							
	⋮							
n-7	Error history directory entry [last]							
n	(see table 379)							

The following parameters apply:

**Byte Description**

- 0-7 T10 VENDOR IDENTIFICATION: Same as standard inquiry
- 8 VERSION: 01h



9

Bit	Description										
7-5	Reserved										
4-3	EHS_RETRIEVED (error history retrieved): indicates whether a clear error history device action has been requested for the error history snapshot. EHS_RETRIEVED field is set to 10b when the error history snapshot is created.										
	<table border="1"> <thead> <tr> <th>Value</th> <th>Description</th> </tr> </thead> <tbody> <tr> <td>00b</td> <td>No information</td> </tr> <tr> <td>01b</td> <td>The error history I_T_L nexus has requested buffer ID FEh (i.e., clear error history I_T_L nexus) or buffer ID FFh (i.e., clear error history I_T_L nexus and release snapshot) for the current error history snapshot.</td> </tr> <tr> <td>10b</td> <td>An error history I_T_L nexus has not requested buffer ID FEh (i.e., clear error history I_T_L nexus) or buffer ID FFh (i.e., clear error history I_T_L nexus and release snapshot) for the current error history snapshot.</td> </tr> <tr> <td>11b</td> <td>Reserved</td> </tr> </tbody> </table>	Value	Description	00b	No information	01b	The error history I_T_L nexus has requested buffer ID FEh (i.e., clear error history I_T_L nexus) or buffer ID FFh (i.e., clear error history I_T_L nexus and release snapshot) for the current error history snapshot.	10b	An error history I_T_L nexus has not requested buffer ID FEh (i.e., clear error history I_T_L nexus) or buffer ID FFh (i.e., clear error history I_T_L nexus and release snapshot) for the current error history snapshot.	11b	Reserved
Value	Description										
00b	No information										
01b	The error history I_T_L nexus has requested buffer ID FEh (i.e., clear error history I_T_L nexus) or buffer ID FFh (i.e., clear error history I_T_L nexus and release snapshot) for the current error history snapshot.										
10b	An error history I_T_L nexus has not requested buffer ID FEh (i.e., clear error history I_T_L nexus) or buffer ID FFh (i.e., clear error history I_T_L nexus and release snapshot) for the current error history snapshot.										
11b	Reserved										
2-1	EHS_SOURCE (error history source): indicates the source of the error history snapshot.										
	<table border="1"> <thead> <tr> <th>Value</th> <th>Description</th> </tr> </thead> <tbody> <tr> <td>00b</td> <td>The error history snapshot was created by the device and was not created due to processing a READ BUFFER command.</td> </tr> <tr> <td>01b</td> <td>Error history snapshot was created due to processing of the current READ BUFFER command</td> </tr> <tr> <td>10b</td> <td>Error history snapshot was created due to processing of a previous READ BUFFER command</td> </tr> <tr> <td>11b</td> <td>Reserved</td> </tr> </tbody> </table>	Value	Description	00b	The error history snapshot was created by the device and was not created due to processing a READ BUFFER command.	01b	Error history snapshot was created due to processing of the current READ BUFFER command	10b	Error history snapshot was created due to processing of a previous READ BUFFER command	11b	Reserved
Value	Description										
00b	The error history snapshot was created by the device and was not created due to processing a READ BUFFER command.										
01b	Error history snapshot was created due to processing of the current READ BUFFER command										
10b	Error history snapshot was created due to processing of a previous READ BUFFER command										
11b	Reserved										
0	CLR_SUP (clear support): 0b										
10-29	Reserved										
30-31	DIRECTORY LENGTH: indicates the number of bytes that follow in the error history directory list.										
32-n	Error history directory list: contains an error history directory entry (see table 379) for each supported buffer ID in the range of 00h to EFh. The first entry is for buffer ID 00h and the other entries are in order of ascending buffer IDs. The supported buffer IDs are not necessarily contiguous.										

#### 6.7.2.7.2 Error history directory entry

An error history directory entry contains information about a buffer that is available to be read with the error history mode. One or more error history directory entries are listed in the error history directory list. The error history directory entry is defined in table 379.

**Table 379 — Error history directory entry**

Bit	7	6	5	4	3	2	1	0	
Byte	supported buffer id								
0									
1	Reserved								
3									
4	(MSB)	maximum available length							
7								(LSB)	

The following parameters apply:

#### Byte Description

0	SUPPORTED BUFFER ID: indicates the error history buffer ID associated with this entry.
1-3	Reserved.

4-7      **MAXIMUM AVAILABLE LENGTH:** indicates the current size of the data available for transfer from the buffer indicated in the **SUPPORTED BUFFER ID** field (i.e., the actual size of the data).

### **6.7.2.7.3 MODE [1Ch] 10h to FEh: Error history data buffer**

#### **6.7.2.7.3.1 MODE [1Ch] 10h to FEh: Error history data buffer overview**

Unless an error is encountered, the device returns parameter data that contains the error history from the error history snapshot from the specified buffer at the specified buffer offset.

If the device receives a **READ BUFFER** command with the **MODE** field set to 1Ch from the established error history I\_T\_L nexus and the **BUFFER ID** field is set to a value that the error history directory (see 6.7.2.7.1) shows as not supported, then the command is terminated with **CHECK CONDITION** status with the sense key set to **ILLEGAL REQUEST** and the additional sense code set to **INVALID FIELD IN CDB**.

If the value in the **BUFFER OFFSET** field is not supported, the command is terminated with **CHECK CONDITION** status with the sense key set to **ILLEGAL REQUEST** and the additional sense code set to **INVALID FIELD IN CDB**.

The amount of error history in the specified buffer is less than or equal to the number of bytes indicated by the **MAXIMUM AVAILABLE LENGTH** field in the error history directory (see 6.7.2.7.1).

#### **6.7.2.7.3.2 MODE [1Ch] 10h: Current error history snapshot**

The current error history snapshot is the most recent dump either explicitly forced or implicitly created by internal algorithms. This buffer may or may not exist.

#### **6.7.2.7.3.3 MODE [1Ch] 11h: Mini dump**

The minidump is a dump written to volatile memory using **Send Diagnostic Force Mini Dump** (Diag 0163). This buffer may or may not exist.

#### **6.7.2.7.3.4 MODE [1Ch] 20h: Emergency dump**

The emergency dump is a dump that was written to non-volatile memory using **Send Diagnostic Write Dump to FLASH** (Diag 0162) or written by internal algorithms. This buffer may or may not exist.

#### **6.7.2.7.3.5 MODE [1Ch] 21h to 28h: Prioritized flash dump**

The prioritized flash dumps are written to non-volatile memory and prioritized by internal algorithms that are designed to provide the optimum data capture for debug. The highest priority buffer is 21h and the lowest priority buffer is 28h. These buffers may or may not exist.

### 6.7.2.7.3.6 MODE [1Ch] EFh: Error history names list

The error history names list buffer(i.e., Buffer ID EFh) contains a list of error history buffer ID's and their associated names. The error history names list is defined in table 380.

**Table 380 — MODE[1Ch] EFh: Error history names list format**

Bit Byte	7	6	5	4	3	2	1	0
0	(MSB)							
1	NAMES LIST LENGTH (n-1)							(LSB)
	Error history names list							
2	Error history names entry [first]							
37	(see table 381)							
	⋮							
n-35	Error history names entry [last]							
n	(see table 381)							

The following parameters apply:

#### Byte Description

- 0-1 NAMES LIST LENGTH: indicates the number of bytes that follow in the error history names list.
- 2-n Error history names list: contains an error history names entry (see table 381) for each supported buffer. An entry in this list does not mean that there is any data currently available in the buffer.

#### 6.7.2.7.3.6.1 Error history names entry

An error history names entry contains the buffer ID and name associated with an error history buffer. The error history names entry is defined in table 381.

**Table 381 — Error history names entry**

Bit Byte	7	6	5	4	3	2	1	0
0	supported buffer id							
1	Reserved							
3								
4	(MSB)							
35	error history name							(LSB)

The following parameters apply:

#### Byte Description

- 0 SUPPORTED BUFFER ID: indicates the error history buffer ID associated with this entry.
- 1-3 Reserved.

- 4-35 ERROR HISTORY NAME: contains a 32 character ASCII name assigned to the error history contained in the buffer associated with SUPPORTED BUFFER ID.

#### **6.7.2.7.4 MODE [1Ch] FEh: Clear error history I\_T\_L nexus**

If the BUFFER ID field is set to FEh, the device:

- a) clears the error history I\_T\_L nexus, if any; and
- b) does not transfer any data.

#### **6.7.2.7.5 MODE [1Ch] FFh: Clear error history I\_T\_L nexus and release snapshot**

If the BUFFER ID field is set to FFh, the device:

- a) clears the error history I\_T\_L nexus, if any,
- b) releases the error history snapshot, if any; and
- c) does not transfer any data.

## 6.8 Security Protocol Parameters (SPP)

Security Protocol parameters are used by the SECURITY PROTOCOL IN (SPIN) - A2h (see 5.2.34 on page 169) command and by the SECURITY PROTOCOL OUT (SPOUT) - B5h (see 5.2.35 on page 170) command.

The following terms are used in this clause:

Term	Description
SPIN	Security Protocol In
SPOUT	Security Protocol Out

### 6.8.1 SPIN Pages (00h - Security Protocol Information)

See SECURITY PROTOCOL IN (SPIN) - A2h (see 5.2.34 on page 169) for a description of how to request this page. The Security Protocol Specific field of the SPIN CDB is defined by Table 382

**Table 382 — SPIN (00h) Security Protocol Specific Definitions for Security Protocol 00h**

Code	Reference
0000h	SPIN (00h[0000h]) - Supported Security Protocols List (see 6.8.1.1 on page 440)
0001h	SPIN (00h[0001h]) - Certificate Data (see 6.8.1.2 on page 441)
0002h	SPIN (00h[0002h]) - Security Compliance Information (see 6.8.1.3 on page 442)
0003h - FFFFh	Reserved

### 6.8.1.1 SPIN (00h[0000h]) - Supported Security Protocols List

See SECURITY PROTOCOL IN (SPIN) - A2h (see 5.2.34 on page 169) for a description of how to request this page. If the SECURITY PROTOCOL field is set to 00h and the SECURITY PROTOCOL SPECIFIC field is set to 0000h in a SECURITY PROTOCOL IN command, the parameter data shall have the format shown in Table 383.

**Table 383 — SPIN (00h[0000h]) Supported Security Protocols List Structure**

Byte	Bit							
	7 msb	6	5	4	3	2	1	0 lsb
0	Reserved							
5								
6	(MSB)	SUPPORTED SECURITY PROTOCOL LIST LENGTH (m-7)						(LSB)
7								
8	Supported Security Protocol (first)							
	⋮							
m	Supported Security Protocol (last)							

The Supported Security Protocol list contains the following supported security protocols:

Value	Description
00h	Security protocol information (see 6.8.1).
20h	Tape Data Encryption (see 6.8.2).

### 6.8.1.2 SPIN (00h[0001h]) - Certificate Data

See SECURITY PROTOCOL IN (SPIN) - A2h (see 5.2.34 on page 169) for a description of how to request this page. The drive certificate (if present) is provided in X.509 format via this interface (see SPC-4).

If the Security Protocol field is set to 00h and the Security Protocol Specific field is set to 0001h in a Security Protocol In command, the parameter data shall have the format shown in Table 384.

**Table 384 — SPIN (00h[0001h]) - Certificate Data Structure**

Byte	Bit							
	7 msb	6	5	4	3	2	1	0 lsb
0	Reserved							
1	Reserved							
2	(MSB)	CERTIFICATE LENGTH (m-3)						(LSB)
3	CERTIFICATE							
4	CERTIFICATE							
m	CERTIFICATE							

The following parameters apply:

- CERTIFICATE LENGTH - The total length, in bytes, of the certificate that follows.
- CERTIFICATE - The drive certificate set during manufacturing is returned.

### 6.8.1.3 SPIN (00h[0002h]) - Security Compliance Information

See SECURITY PROTOCOL IN (SPIN) - A2h (see 5.2.34 on page 169) for a description of how to request this page. The security compliance information describes this drives security compliance.

===== WARNING =====

This page returns information to assist locating potential security compliance information only. It does not indicate that the code or hardware is actually compliant with such certification or used in a manner consistent with such compliance.

===== WARNING =====

If the Security Protocol field is set to 00h and the Security Protocol Specific field is set to 0002h in a Security Protocol In command, the parameter data shall have the format shown in Table 385.

**Table 385 — SPIN (00h[0002h]) - Security Compliance Information Structure**

Byte	Bit							
	7 msb	6	5	4	3	2	1	0 lsb
0	SECURITY COMPLIANCE INFORMATION LENGTH (000 0210h)							
3								
4								
4	(MSB)	COMPLIANCE DESCRIPTOR TYPE (0001h)						(LSB)
5								
6	Reserved							
7								
8	(MSB)	COMPLIANCE DESCRIPTOR LENGTH (0000 0208h)						(LSB)
11								
12	related standard							
13	overall security level							
14	Reserved							
19								
20	(MSB)	COMPLIANCE DESCRIPTOR HARDWARE VERSION						(LSB)
147								
148	(MSB)	COMPLIANCE DESCRIPTOR VERSION						(LSB)
275								
276	(MSB)	COMPLIANCE DESCRIPTOR MODULE NAME						(LSB)
531								



The following parameters apply:

- SECURITY COMPLIANCE INFORMATION LENGTH - The total length, in bytes, of the compliance descriptors that follow.
- COMPLIANCE DESCRIPTOR TYPE - The the format of the descriptor specific information. This field is set to 0001h to indicate Security requirements for cryptographic modules.
- COMPLIANCE DESCRIPTOR LENGTH - The number of bytes in the compliance descriptor.
- RELATED STANDARD - An ASCII data field that indicates the related standard described by this compliance descriptor.
- OVERALL SECURITY LEVEL - An ASCII data field that indicates the FIPS 140 overall security level that is reported by NIST or CSEC.
- COMPLIANCE DESCRIPTOR HARDWARE VERSION - Null terminated, null padded data that indicates the version number of the hardware in the module, as reported by NIST or CSEC.
- COMPLIANCE DESCRIPTOR VERSION - Null terminated, null padded data that indicates the version number of the firmware or software in the module, as reported by NIST or CSEC.
- COMPLIANCE DESCRIPTOR MODULE NAME - Null terminated, null padded data that indicates the name or identifier of the cryptographic module, as reported by NIST or CSEC.

### 6.8.2 SPIN Pages (20h - Tape Data Encryption)

See SECURITY PROTOCOL IN (SPIN) - A2h (see 5.2.34 on page 169) for a description of how to request this page. The SECURITY PROTOCOL SPECIFIC field specifies the type of report that the application client is requesting. See SPIN (00h[0000h]) - Supported Security Protocols List (see 6.8.1.1 on page 440) for the supported SECURITY PROTOCOL SPECIFIC field values.

#### 6.8.2.1 SPIN (20h[0000h]) - Tape Data Encryption In Support Pages page

See SECURITY PROTOCOL IN (SPIN) - A2h (see 5.2.34 on page 169) for a description of how to request this page. Supported protocol specific in pages for protocol 20h are indicated above (see SSC-3).

**Table 386 — SPIN (20h[0000h]) - Tape Data Encryption In Support Pages Structure**

Byte	Bit							
	7 msb	6	5	4	3	2	1	0 lsb
0	(MSB)	PAGE CODE (0000h)						(LSB)
1								
2	(MSB)	PAGE LENGTH (n-3)						(LSB)
3								
Tape Data Encryption In Support page code list								
4	(MSB)	Tape Data Encryption In Support page code (first)						(LSB)
5								
		⋮						
n-1	(MSB)	Tape Data Encryption In Support page code (last)						(LSB)
n								

Table 387 on page 444 show which Tape Data Encryption In page codes are supported:

**Table 387 — SPIN (20h[0000h]) - Tape Data Encryption In page codes** (SECURITY PROTOCOL SPECIFIC values)

Page Code	Reference
0000h	SPIN (20h[0000h]) - Tape Data Encryption In Support Pages page (see 6.8.2.1 on page 443)
0001h	SPIN (20h[0001h]) - Tape Data Encryption Out Support Pages page (see 6.8.2.2 on page 445)
0010h	SPIN (20h[0010h]) - Data Encryption Capabilities page (see 6.8.2.3 on page 446)
0011h	SPIN (20h[0011h]) - Supported Key Formats page (see 6.8.2.4 on page 451)
0012h	SPIN (20h[0012h]) - Data Encryption Management Capabilities (see 6.8.2.5 on page 452)
0020h	SPIN (20h[0020h]) - Data Encryption Status page (see 6.8.2.6 on page 453)
0021h	SPIN (20h[0021h]) - Next Block Encryption Status page (see 6.8.2.7 on page 456)
0030h	SPIN (20h[0030h]) - Random Number page (see 6.8.2.8 on page 460)
0031h	SPIN (20h[0031h]) - Device Server Key Wrapping Public Key page (see 6.8.2.9 on page 461)

### 6.8.2.2 SPIN (20h[0001h]) - Tape Data Encryption Out Support Pages page

See SECURITY PROTOCOL IN (SPIN) - A2h (see 5.2.34 on page 169) for a description of how to request this page. Supported protocol specific out pages for protocol 20h are indicated above (see SSC-3).

**Table 388 — SPIN (20h[0001h]) - Tape Data Encryption Out Support Pages Structure**

Byte	Bit							
	7 msb	6	5	4	3	2	1	0 lsb
0	(MSB)	Page Code (0001h)						(LSB)
1								
2	(MSB)	Page Length (n-3)						(LSB)
3								
Tape Data Encryption Out Support page code list								
4	(MSB)	Tape Data Encryption Out Support page code (first)						(LSB)
5								
		⋮						
n-1	(MSB)	Tape Data Encryption Out Support page code (last)						(LSB)
n								

Table 389 on page 445 show which Tape Data Encryption Out page codes are supported:

**Table 389 — Tape Data Encryption Out page codes**

Page Code	Reference
0010h	SPOUT (20h[0010h]) - Set Data Encryption (see 6.8.3.1 on page 462)

### 6.8.2.3 SPIN (20h[0010h]) - Data Encryption Capabilities page

See SECURITY PROTOCOL IN (SPIN) - A2h (see 5.2.34 on page 169) for a description of how to request this page. Table 97 specifies the format of the Data Encryption Capabilities page.

**Table 390 — SPIN (20h[0010h]) - Data Encryption Capabilities page**

Byte	Bit							
	7 msb	6	5	4	3	2	1	0 lsb
0	(MSB) PAGE CODE (0010h) (LSB)							
1								
2	(MSB) PAGE LENGTH (n-3) (LSB)							
3								
4	Reserved				extdecc		cfg_p	
5	Reserved							
19								
Data Encryption Algorithm descriptor list								
20	Data Encryption Algorithm descriptor (first)							
	⋮							
n	Data Encryption Algorithm descriptor (last)							

The Data Encryption Capabilities page description follows:

#### Byte Description

- 0-1 PAGE CODE: 0010h  
 2-3 PAGE LENGTH: The number of bytes that follow  
 4

#### Bit Description

- 7-4 Reserved  
 3-2 EXTDECC (external data encryption control capable): Specifies the external data encryption control capability of the drive.

#### Value

#### Description

- 00b The external data encryption control capability is not reported.  
 01b The drive is not external data encryption control capable.  
 10b The drive is external data encryption control capable.  
 11b Reserved

- 1-0 CFG\_P (configuration prevented): Specifies the logical block encryption parameters configuration capabilities for the algorithms reported in the logical block encryption algorithm descriptors.

#### Value

#### Description

- 00b The logical block encryption configuration capabilities are not reported.  
 01b The drive is configured to allow this device server to establish or change logical block encryption parameters.  
 10b The drive is configured to not allow this device server to establish or change logical block encryption parameters.  
 In code levels that set this field, this value is reported when in LME mode.  
 11b Reserved

- 5-19 Reserved

- 20-n Data Encryption Algorithm descriptor list. There is one Data Encryption Algorithm Descriptor - Standard Encryption (see 6.8.2.3.1 on page 447) for each supported Data Encryption Algorithm (i.e., one for each generation that supports encryption).

**Byte Description**

- 20-43 Data Encryption Algorithm descriptor [First], if any  
 44-67 Data Encryption Algorithm descriptor [Second], if any  
 68-91 Data Encryption Algorithm descriptor [Third], if any

**Table 391 — Data Encryption Algorithm descriptor list returned**

Data Encryption Algorithm descriptor	On Ultrium 4 drives	On Ultrium 5 drives	On Ultrium 6 drives	On Ultrium 7 drives
First (bytes 20-43)	ALGORITHM INDEX (01h)	ALGORITHM INDEX (01h)	ALGORITHM INDEX (01h)	ALGORITHM INDEX (02h)
Second (bytes 44-67)	N/A	ALGORITHM INDEX (02h)	ALGORITHM INDEX (02h)	ALGORITHM INDEX (03h)
Third (bytes 68-91)	N/A	N/A	ALGORITHM INDEX (03h)	ALGORITHM INDEX (04h)

**6.8.2.3.1 Data Encryption Algorithm Descriptor - Standard Encryption**

The Standard Encryption Algorithm Descriptor is shown in table 392

**Table 392 — Data Encryption Algorithm Descriptor - Standard Encryption Structure**

Byte	Bit							
	7 msb	6	5	4	3	2	1	0 lsb
0	ALGORITHM INDEX							
1	Reserved							
2	(MSB)	DESCRIPTOR LENGTH (0014h)						(LSB)
3								
4	AVFMV	SDK_C (0b)	MAC_C (1b)	DELB_C (1b)	DECRYPT_C (10b)		ENCRYPT_C (10b)	
5	AVFCLP		NONCE_C (11b)		KADF_C (1b)	VCELB_C (1b)	UKADF (0b)	AKADF (0b)
6	(MSB)	MAXIMUM UNAUTHENTICATED KEY-ASSOCIATED DATA (U-KAD) BYTES (0020h)						(LSB)
7								
8	(MSB)	MAXIMUM AUTHENTICATED KEY-ASSOCIATED DATA (A-KAD) BYTES						(LSB)
9								
10	(MSB)	LOGICAL BLOCK ENCRYPTION KEY SIZE (0020h)						(LSB)
11								
12	DKAD_C (11b)		EEMC_C (10b)		RDMC_C (101b)		EAREM (1b)	
13	Reserved							
14								
15	MSDK_COUNT (0000h)							
16								
19	Reserved							
20	(MSB)	SECURITY ALGORITHM CODE (0001_0014h)						(LSB)
23								

Each Data Encryption Algorithm Descriptor is specified by its ALGORITHM INDEX. For fields whose value changes depending on the ALGORITHM INDEX, the value is specified in the description of that field. The Data Encryption Algorithm Descriptor - Standard Encryption Structure description follows:

**Byte Description**

0 ALGORITHM INDEX: The index of the Data Encryption Algorithm being described. Used by the SECURITY PROTOCOL OUT command Set Data Encryption page to select this algorithm.

1 Reserved

2-3 DESCRIPTOR LENGTH:

4

**Bit Description**

7 AVFMV (algorithm valid for mounted volume): Specifies if the algorithm selected by the ALGORITHM INDEX is valid for the currently mounted volume.

**Value Description**

0b There is no volume mounted or the algorithm being described is not valid for the currently mounted volume.

1b A volume is currently mounted and the encryption algorithm being described is valid for that volume.

6 SDK\_C (supplemental decryption key capable):

5 MAC\_C (message authentication code capable):

4 DELB\_C (distinguish encrypted logical block capable):

3-2 DECRYPT\_C (decryption capabilities):

**Value Description**

00b No capability — The drive has no logical block decryption capability using this algorithm. This value shall be returned if the specified algorithm is disabled.

01b Software capable — Not Supported.

10b Hardware capable — The drive has the ability to decrypt logical blocks using this algorithm in hardware.

11b Capable with external control — The drive has the capability to decrypt logical blocks using this algorithm, but control of the logical block encryption parameters by this device server is prevented.

1-0 ENCRYPT\_C (encryption capabilities):

**Value Description**

00b No capability — The drive has no logical block encryption capability using this algorithm. This value shall be returned if the specified algorithm is disabled.

01b Software capable — Not Supported.

10b Hardware capable — The drive has the ability to encrypt logical blocks using this algorithm in hardware.

11b Capable with external control — The drive has the capability to encrypt logical blocks using this algorithm, but control of the logical block encryption parameters by this device server is prevented.

5

Bit	Description										
7-6	AVFCLP (algorithm valid for current logical position): Specifies if the encryption algorithm being specified is valid for writing to the mounted volume at the current logical position										
	<table border="1"> <thead> <tr> <th>Value</th> <th>Description</th> </tr> </thead> <tbody> <tr> <td>00b</td> <td>Current logical position is not applicable to the encryption algorithm validity or no volume is loaded.</td> </tr> <tr> <td>01b</td> <td>The encryption algorithm being specified is not valid for writing to the mounted volume at the current logical position.</td> </tr> <tr> <td>10b</td> <td>The encryption algorithm being specified is valid for writing to the mounted volume at the current logical position.</td> </tr> <tr> <td>11b</td> <td>Reserved</td> </tr> </tbody> </table>	Value	Description	00b	Current logical position is not applicable to the encryption algorithm validity or no volume is loaded.	01b	The encryption algorithm being specified is not valid for writing to the mounted volume at the current logical position.	10b	The encryption algorithm being specified is valid for writing to the mounted volume at the current logical position.	11b	Reserved
Value	Description										
00b	Current logical position is not applicable to the encryption algorithm validity or no volume is loaded.										
01b	The encryption algorithm being specified is not valid for writing to the mounted volume at the current logical position.										
10b	The encryption algorithm being specified is valid for writing to the mounted volume at the current logical position.										
11b	Reserved										
5-4	NONCE_C: <table border="1"> <thead> <tr> <th>Value</th> <th>Description</th> </tr> </thead> <tbody> <tr> <td>00b-10b</td> <td>Not Supported.</td> </tr> <tr> <td>11b</td> <td>The drive supports all or part of the nonce value provided by the application client. If the Set Data Encryption page that enables encryption does not include a nonce value descriptor, the drive generates the nonce value.</td> </tr> </tbody> </table>	Value	Description	00b-10b	Not Supported.	11b	The drive supports all or part of the nonce value provided by the application client. If the Set Data Encryption page that enables encryption does not include a nonce value descriptor, the drive generates the nonce value.				
Value	Description										
00b-10b	Not Supported.										
11b	The drive supports all or part of the nonce value provided by the application client. If the Set Data Encryption page that enables encryption does not include a nonce value descriptor, the drive generates the nonce value.										
3	KADF_C (KAD format capable): Indicates if the drive is KAD format capable, that is, it supports: <ul style="list-style-type: none"> <li>A) the ENCRYPTION PARAMETERS KAD FORMAT field in the Data Encryption Status page (see 6.8.2.6);</li> <li>B) the NEXT BLOCK KAD FORMAT field in the Next Block Encryption Status page (see 6.8.2.7); and</li> <li>C) the KAD FORMAT field in the Set Data Encryption page (see 6.8.3.1).</li> </ul> <table border="1"> <thead> <tr> <th>Value</th> <th>Description</th> </tr> </thead> <tbody> <tr> <td>0b</td> <td>The drive is not KAD format capable as described herein.</td> </tr> <tr> <td>1b</td> <td>The drive is KAD format capable as described herein.</td> </tr> </tbody> </table>	Value	Description	0b	The drive is not KAD format capable as described herein.	1b	The drive is KAD format capable as described herein.				
Value	Description										
0b	The drive is not KAD format capable as described herein.										
1b	The drive is KAD format capable as described herein.										
2	VCELB_C (volume contains encrypted logical blocks capable):										
1	UKADF (U-KAD fixed): Specifies restrictions on the length of the U-KAD, if present. <table border="1"> <thead> <tr> <th>Value</th> <th>Description</th> </tr> </thead> <tbody> <tr> <td>0b</td> <td>If the value in the MAXIMUM UNAUTHENTICATED KEY-ASSOCIATED DATA BYTES field is non-zero, then the length of the U-KAD, if present in the parameter data for a SECURITY PROTOCOL OUT command, shall be a value between one and the value in the MAXIMUM UNAUTHENTICATED KEY-ASSOCIATED DATA BYTES field.</td> </tr> <tr> <td>1b</td> <td>The length of the U-KAD in the parameter data for a SECURITY PROTOCOL OUT command shall be MAXIMUM UNAUTHENTICATED KEY-ASSOCIATED DATA BYTES in length and the MAXIMUM UNAUTHENTICATED KEY-ASSOCIATED DATA BYTES field shall contain a non-zero value.</td> </tr> </tbody> </table>	Value	Description	0b	If the value in the MAXIMUM UNAUTHENTICATED KEY-ASSOCIATED DATA BYTES field is non-zero, then the length of the U-KAD, if present in the parameter data for a SECURITY PROTOCOL OUT command, shall be a value between one and the value in the MAXIMUM UNAUTHENTICATED KEY-ASSOCIATED DATA BYTES field.	1b	The length of the U-KAD in the parameter data for a SECURITY PROTOCOL OUT command shall be MAXIMUM UNAUTHENTICATED KEY-ASSOCIATED DATA BYTES in length and the MAXIMUM UNAUTHENTICATED KEY-ASSOCIATED DATA BYTES field shall contain a non-zero value.				
Value	Description										
0b	If the value in the MAXIMUM UNAUTHENTICATED KEY-ASSOCIATED DATA BYTES field is non-zero, then the length of the U-KAD, if present in the parameter data for a SECURITY PROTOCOL OUT command, shall be a value between one and the value in the MAXIMUM UNAUTHENTICATED KEY-ASSOCIATED DATA BYTES field.										
1b	The length of the U-KAD in the parameter data for a SECURITY PROTOCOL OUT command shall be MAXIMUM UNAUTHENTICATED KEY-ASSOCIATED DATA BYTES in length and the MAXIMUM UNAUTHENTICATED KEY-ASSOCIATED DATA BYTES field shall contain a non-zero value.										
0	AKADF (A-KAD fixed): Specifies restrictions on the length of the A-KAD, if present. <table border="1"> <thead> <tr> <th>Value</th> <th>Description</th> </tr> </thead> <tbody> <tr> <td>0b</td> <td>If the value in the MAXIMUM AUTHENTICATED KEY-ASSOCIATED DATA BYTES field is non-zero, then the length of the A-KAD, if present in the parameter data for a SECURITY PROTOCOL OUT command, shall be a value between one and the value in the MAXIMUM AUTHENTICATED KEY-ASSOCIATED DATA BYTES field.</td> </tr> <tr> <td>1b</td> <td>The length of A-KAD in the parameter data for a SECURITY PROTOCOL OUT command shall be MAXIMUM AUTHENTICATED KEY-ASSOCIATED DATA BYTES in length and the MAXIMUM AUTHENTICATED KEY-ASSOCIATED DATA BYTES field shall contain a non-zero value.</td> </tr> </tbody> </table>	Value	Description	0b	If the value in the MAXIMUM AUTHENTICATED KEY-ASSOCIATED DATA BYTES field is non-zero, then the length of the A-KAD, if present in the parameter data for a SECURITY PROTOCOL OUT command, shall be a value between one and the value in the MAXIMUM AUTHENTICATED KEY-ASSOCIATED DATA BYTES field.	1b	The length of A-KAD in the parameter data for a SECURITY PROTOCOL OUT command shall be MAXIMUM AUTHENTICATED KEY-ASSOCIATED DATA BYTES in length and the MAXIMUM AUTHENTICATED KEY-ASSOCIATED DATA BYTES field shall contain a non-zero value.				
Value	Description										
0b	If the value in the MAXIMUM AUTHENTICATED KEY-ASSOCIATED DATA BYTES field is non-zero, then the length of the A-KAD, if present in the parameter data for a SECURITY PROTOCOL OUT command, shall be a value between one and the value in the MAXIMUM AUTHENTICATED KEY-ASSOCIATED DATA BYTES field.										
1b	The length of A-KAD in the parameter data for a SECURITY PROTOCOL OUT command shall be MAXIMUM AUTHENTICATED KEY-ASSOCIATED DATA BYTES in length and the MAXIMUM AUTHENTICATED KEY-ASSOCIATED DATA BYTES field shall contain a non-zero value.										
6-7	MAXIMUM UNAUTHENTICATED KEY-ASSOCIATED DATA BYTES: Indicates the maximum size of the unauthenticated key-associated data supported by the device server for this algorithm.										

8-9 MAXIMUM AUTHENTICATED KEY-ASSOCIATED DATA BYTES:  
Indicates the maximum size of the authenticated key-associated data supported by the device server for this algorithm. The value for each algorithm follows.

**ALGORITHM**

INDEX	Value
01h	000Ch
02h	003Ch
03h	003Ch

10-11 LOGICAL BLOCK ENCRYPTION KEY SIZE:

Indicates the size in bytes of the logical block encryption key required by the algorithm.

12

**Bit Description**

7-6 DKAD\_C (decryption KAD capabilities):

Indicates the decryption capabilities when the DECRYPTION MODE field of the Set Data Encryption page (see 6.8.3.1) is set to DECRYPT or MIXED.

Value	Description
00b	not specified — No capabilities are specified.
01b	KAD Required — Not Supported.
10b	KAD Not Allowed — Not Supported.
11b	KAD Capable — The drive accepts U-KAD and/or A-KAD provided by the application client with the Set Data Encryption page, but is not required.

5-4 EEMC\_C (external encryption mode control capabilities):

Indicates the capabilities the encryption algorithm provides to the application client to control write operations that transfer encrypted logical blocks while the encryption mode is set to EXTERNAL.

Value	Description
00b	No capabilities are specified.
01b	Not Supported.
10b	The encryption algorithm allows write operations in EXTERNAL encryption mode. The device server does act as a KCDLU for this encryption algorithm.
11b	Reserved

3-1 RDMC\_C (raw decryption mode control capabilities):

Indicates the capabilities the encryption algorithm provides to the application client to control read operations that access encrypted logical blocks while the decryption mode is set to RAW.

Value	Description
000b	No capabilities are specified.
001b	Not Supported.
010b-011b	Reserved
100b	Not Supported.
101b	The encryption algorithm enables read operations in RAW mode by default and allows the application client to control RAW reads via the RDMC field in the Set Data Encryption page (see 6.8.3.1). The device server acts as a KCSLU for this encryption algorithm.
110b	Not Supported.
111b	Not Supported.

0 EAREM (encryption algorithm records encryption mode):

Value	Description
0b	The encryption mode is not recorded with each encrypted logical block.
1b	The encryption mode is recorded with each encrypted logical block.

13 Reserved

14-15 MSDK\_COUNT (maximum supplemental decryption key count):

16-19 Reserved

20-23 SECURITY ALGORITHM CODE:

Contains a security algorithm code (see SPC-4).



6.8.2.4 SPIN (20h[0011h]) - Supported Key Formats page

See SECURITY PROTOCOL IN (SPIN) - A2h (see 5.2.34 on page 169) for a description of how to request this page.

The structure of the Supported Key Formats page is shown in Table 393 on page 451

**Table 393 — SPIN (20h[0011h]) - Supported Key Formats page Structure**

Byte	Bit							
	7 msb	6	5	4	3	2	1	0 lsb
0	(MSB) PAGE CODE (0011h) (LSB)							
1								
2	(MSB) PAGE LENGTH (n-3) (LSB)							
3								
Supported Key Format list								
4	Supported Key Format [first]							
	⋮							
n	Supported Key Format [last]							

**Table 394 — Supported Key Formats**

Key Format	Reference
00h	Plaintext Key Format (00h) (see 6.8.2.4.1 on page 451)
02h	Key wrapped by device server public key. See SSC. Note - The device supports only RSA 2048 public key wrapping. The device allows SIGNATURE to be sent, but does not perform signature verification.

6.8.2.4.1 Plaintext Key Format (00h)

The Plaintext Key Format structure is shown in Table 395 on page 451

**Table 395 — KEY FORMAT 00h - Plaintext Key Format Structure**

Byte	Bit							
	7 msb	6	5	4	3	2	1	0 lsb
0	KEY							
n								

### 6.8.2.5 SPIN (20h[0012h]) - Data Encryption Management Capabilities

See SECURITY PROTOCOL IN (SPIN) - A2h (see 5.2.34 on page 169) for a description of how to request this page.

Table 396 on page 452 specifies the format of the Data Encryption Management Capabilities page.

**Table 396 — SPIN (20h[0012h]) - Data Encryption Management Capabilities page**

Byte	Bit							
	7 msb	6	5	4	3	2	1	0 lsb
0	(MSB) PAGE CODE (0012h) (LSB)							
1								
2	(MSB) PAGE LENGTH (000ch) (LSB)							
3								
4	Reserved							LOCK_C (1b)
5	Reserved					CKOD_C (1b)	CKORP_C (1b)	CKORL_C (1b)
6	Reserved							
7	Reserved					AITN_C (1b)	LOCAL_C (1b)	PUBLIC_C (1b)
8	Reserved							
15	Reserved							

### 6.8.2.6 SPIN (20h[0020h]) - Data Encryption Status page

Table 397 specifies the format of the Data Encryption Status page

This is a query of information which was set with Security Protocol Out 0010h - Set Data Encryption and does not reflect the actual state of the medium itself or of any data on medium..

**Table 397 — SPIN (20h[0020h]) - Data Encryption Status page**

Byte	Bit							
	7 msb	6	5	4	3	2	1	0 lsb
0	(MSB) PAGE CODE (0020h) (LSB)							
1								
2	(MSB) PAGE LENGTH (n-3) (LSB)							
3								
4	I_T NEXUS SCOPE			Reserved		LOGICAL BLOCK ENCRYPTION SCOPE		
5	ENCRYPTION MODE							
6	DECRYPTION MODE							
7	ALGORITHM INDEX							
8	(MSB) KEY INSTANCE COUNTER (LSB)							
11								
12	Reserved	PARAMETERS CONTROL			VCELB	CEEMS		RDMD
13	ENCRYPTION PARAMETERS KAD FORMAT							
14	(MSB) ASDK_COUNT (0000h) (LSB)							
15								
16	Reserved							
23								
Key-associated data descriptor list								
24	Key-associated data descriptor (first)							
Key-associated data descriptor (last)								
n								

The I\_T NEXUS SCOPE field shall contain the value from the logical block encryption scope saved for the I\_T\_L nexus through which this command was received.

The LOGICAL BLOCK ENCRYPTION SCOPE field shall contain the value from the logical block encryption scope in the saved logical block encryption parameters currently associated with the I\_T\_L nexus on which this command was received.

The ENCRYPTION MODE field shall contain the value from the encryption mode in the saved logical block encryption parameters currently associated with the I\_T\_L nexus on which this command was received.

The DECRYPTION MODE field shall contain the value from the decryption mode in the saved logical block encryption parameters currently associated with the I\_T\_L nexus on which this command was received.

The ALGORITHM INDEX field shall contain the value from the algorithm index in the saved logical block encryption parameters currently associated with the I\_T\_L nexus on which this command was received. If the ENCRYPTION MODE field and the DECRYPTION MODE field are both set to DISABLE, the value in the ALGORITHM INDEX field is undefined.

The KEY INSTANCE COUNTER field contains the value of the logical block encryption parameters key instance counter assigned to the logical block encryption key indicated by the LOGICAL BLOCK ENCRYPTION SCOPE field value.

The PARAMETERS CONTROL field specifies information on how the logical block encryption parameters are controlled. The PARAMETERS CONTROL field values are specified in table 398.

**Table 398 — PARAMETERS CONTROL field**

Code	Description
000b	Logical block encryption parameters control is not reported. This value is returned on Ultrium 4 devices
001b	Logical block encryption parameters are not exclusively controlled by external data encryption control. This value is returned when in AME encryption mode.
010b	Logical block encryption parameters are exclusively controlled by the sequential-access device server.
011b	Logical block encryption parameters are exclusively controlled by the automation/drive interface device server. This value is returned when in LME or ADC Controlled encryption mode.
100b	Not supported.
101b-111b	Reserved

A volume contains encrypted logical blocks (VCELB) bit set to one indicates that the mounted volume contains an encrypted logical block. A VCELB bit set to zero indicates that either:

- a) the mounted volume does not contain any encrypted logical blocks;
- b) there is no volume mounted; or
- c) the VCELB\_C bit in the Data Encryption Capabilities page is set to zero.

The raw decryption mode disabled (RDMD) bit shall be set to one if the device entity is configured to mark each encrypted record as disabled for raw read operations based on the RDMC\_C value and the raw decryption mode disable parameter in the saved logical block encryption parameters currently associated with the I\_T\_L nexus on which the command was received.

The check external encryption mode status (CEEMS) field shall contain the value from the check external encryption mode parameter in the saved logical block encryption parameters currently associated with the I\_T\_L nexus on which the command was received.

The ENCRYPTION PARAMETERS KAD FORMAT field shall contain the value from the KAD\_FORMAT in the saved logical block encryption parameters currently associated with the I\_T\_L nexus on which this command was received. If the encryption algorithm specified in the ALGORITHM INDEX field reports a KADF\_C bit set to zero, then the ENCRYPTION PARAMETERS KAD FORMAT field shall be set to zero.

The available supplemental decryption key count (ASDK\_COUNT) field shall be set to zero because the device server is not capable of supporting supplemental decryption keys.

If the ENCRYPTION MODE field and the DECRYPTION MODE field are both set to DISABLE, the key-associated data descriptors list shall not be included in the page.

If either the ENCRYPTION MODE field or the DECRYPTION MODE field is set to a value other than DISABLE, the key-associated data descriptors list shall include Tape Data Encryption descriptors describing attributes assigned to the logical block encryption key defined by the I\_T NEXUS SCOPE and LOGICAL BLOCK ENCRYPTION SCOPE fields at the time the logical block encryption key was established in the device entity (see “Key-Associated Data (KAD) Descriptors” on page 465). If more than one key-associated data descriptor is included, they shall be in increasing numeric order of the value in the KEY DESCRIPTOR TYPE field. Descriptors shall be included as defined by the following paragraphs.

An unauthenticated key-associated data descriptor shall be included if an unauthenticated key-associated data descriptor was included when the logical block encryption key was established in the device entity. The AUTHENTICATED field is reserved. The KEY DESCRIPTOR field shall contain the U-KAD value associated with the logical block encryption key.

An authenticated key-associated data descriptor shall be included if an authenticated key-associated data descriptor was included when the logical block encryption key was established in the device entity. The AUTHENTICATED field is reserved. The KEY DESCRIPTOR field shall contain the A-KAD value associated with the logical block encryption key.

A nonce value descriptor shall be included if a nonce value descriptor was included when the logical block encryption key was established in the device entity. The AUTHENTICATED field is reserved. The KEY DESCRIPTOR field shall contain the nonce value associated with the logical block encryption key. A nonce value descriptor may be included if no nonce value descriptor was included when the logical block encryption key was established in the device entity. In this case, the KEY DESCRIPTOR field shall be set to the nonce value established by the device entity for use with the selected logical block encryption key.

A metadata key-associated data descriptor shall be included if the metadata key-associated data descriptor was included when the logical block encryption parameters were established. The KEY DESCRIPTOR field shall contain the M-KAD value associated with the logical block encryption key.

### 6.8.2.7 SPIN (20h[0021h]) - Next Block Encryption Status page

See SECURITY PROTOCOL IN (SPIN) - A2h (see 5.2.34 on page 169) for a description of how to request this page.

NOTE 69 - Next block encryption status may not be available in all situations. When it is not known appropriate values are returned as per the standard. In most situations next block information is available during read operations when read ahead is being performed. This is automatically managed by the device.

Table 399 specifies the format of the Next Block Encryption Status page

**Table 399 — SPIN (20h[0021h]) - Next Block Encryption Status page**

Byte	Bit							
	7 msb	6	5	4	3	2	1	0 lsb
0	(MSB) PAGE CODE (0021h) (LSB)							
1								
2	(MSB) PAGE LENGTH (n-3) (LSB)							
3								
4	(MSB) LOGICAL OBJECT NUMBER (LSB)							
11								
12	COMPRESSION STATUS (0h)				ENCRYPTION STATUS			
13	ALGORITHM INDEX							
14	Reserved						EMES	RDMDS
15	NEXT BLOCK KAD FORMAT							
Key-associated data descriptor list								
16	Key-associated data descriptor [first]							
n	Key-associated data descriptor [last]							

The LOGICAL OBJECT NUMBER field contains the logical object identifier of the next logical object.

The COMPRESSION STATUS field values are specified in table 400.

**Table 400 — COMPRESSION STATUS field**

Code	Description
0h	The device entity is incapable of determining if the logical object referenced by the LOGICAL OBJECT NUMBER field has been compressed.
1h	Not Supported.
2h	Not Supported.
3h	Not Supported.
4h	Not Supported.
5h-Fh	Reserved

The ENCRYPTION STATUS field values are specified in table 401.

**Table 401 — ENCRYPTION STATUS field**

Code	Description
0h	The device entity is incapable of determining if the logical object referenced by the LOGICAL OBJECT NUMBER field has been encrypted.
1h	The device entity is capable of determining if the logical object referenced by the LOGICAL OBJECT NUMBER field has been encrypted, but is not able to at this time. Possible reasons are: the next logical block has not yet been read into the buffer; there was an error reading the next logical block; or there are no more logical blocks (i.e., end-of-data).
2h	The device entity has determined that the logical object referenced by the LOGICAL OBJECT NUMBER field is not a logical block.
3h	The device entity has determined that the logical object referenced by the LOGICAL OBJECT NUMBER field is not encrypted.
4h	The device entity has determined that the logical object referenced by the LOGICAL OBJECT NUMBER field is encrypted by an algorithm that is not supported by this device server. The values in the key-associated data descriptors list contain information pertaining to the encrypted logical block.
5h	The device entity has determined that the logical object referenced by the LOGICAL OBJECT NUMBER field is encrypted by an algorithm that is supported by this device server. The values in the ALGORITHM INDEX field and key-associated data descriptors list contain information pertaining to the encrypted logical block.
6h	The device entity has determined that the logical object referenced by the LOGICAL OBJECT NUMBER field is encrypted by an algorithm that is supported by this device server, but the device entity is either not enabled to decrypt or does not have the correct logical block encryption key or nonce value to decrypt the encrypted logical block.
7h-Fh	Reserved

The ALGORITHM INDEX field indicates which of the encryption algorithms reported by the SECURITY PROTOCOL IN command Data Encryption Capabilities page was used to encrypt the logical block. For values in the ENCRYPTION STATUS field (see table 401) that do not indicate the ALGORITHM INDEX field is valid, the algorithm index is undefined.

The encryption mode external status (EMES) bit shall be set to one if:

- a) the ENCRYPTION STATUS field is set to either 5h or 6h;
- b) the EAREM bit in the algorithm descriptor (see 6.8.2.3) for the algorithm specified by the ALGORITHM INDEX field is set to one; and
- c) the next logical block is marked as having been written to the medium while the encryption mode was set to EXTERNAL.

The EMES bit shall be set to zero if:

- a) the ENCRYPTION STATUS field is set to a value other than 5h or 6h;
- b) the EAREM bit in the algorithm descriptor (see 6.8.2.3) for the algorithm specified by the ALGORITHM INDEX field is set to zero; or
- c) the next logical block is marked as having been written to the medium while the encryption mode was set to ENCRYPT.

The raw decryption mode disabled status (RDMS) bit shall be set to one if:

- a) the device server supports raw decryption mode;
- b) the ENCRYPTION STATUS field is set to either 5h or 6h; and
- c) the next logical block is marked as disabled for raw decryption mode operations.

The RDMS bit shall be set to zero if:

- a) the device server does not support raw decryption mode;
- b) the ENCRYPTION STATUS field is set to a value other than 5h or 6h; or
- c) the next logical block is not marked as disabled for raw decryption mode operations.

If the value in the ENCRYPTION STATUS field indicates that the next logical block is encrypted by a supported algorithm, then the NEXT BLOCK KAD FORMAT field shall contain the KAD\_FORMAT logical block encryption parameters associated with the encrypted logical block. If the value in the ENCRYPTION STATUS field does not indicate that the next logical object is an encrypted logical block, then the NEXT BLOCK KAD FORMAT field shall be ignored. If the encryption algorithm specified in the ALGORITHM INDEX field reports a KADF\_C bit set to zero, then the NEXT BLOCK KAD FORMAT field shall be set to zero.

If the value in the ENCRYPTION STATUS field indicates that the next logical block is encrypted by a supported algorithm, then the device server shall include in the key-associated data descriptor list (see “Key-Associated Data (KAD) Descriptors” on page 465) all key-associated data that is associated with the encrypted logical block. If more than one key-associated data descriptor is included in the Next Block Encryption Status page, then they shall be in increasing numeric order of the value in the KEY DESCRIPTOR TYPE field.

An unauthenticated key-associated data descriptor (see 6.8.3.2.1) shall be included if any unauthenticated key-associated data is associated with the next logical block. The AUTHENTICATED field shall be set to 1. The KEY DESCRIPTOR field shall contain the U-KAD value associated with the encrypted logical block.

An authenticated key-associated data descriptor (see 6.8.3.2.2) shall be included if any authenticated key-associated data is associated with the next logical block. The AUTHENTICATED field shall indicate the status of the authentication done by the device entity. The KEY DESCRIPTOR field shall contain the A-KAD value associated with the encrypted logical block.

The Next Block Encryption Status page may include a nonce value descriptor (see 6.8.3.2.3). If a nonce value descriptor is included, then the AUTHENTICATED field shall indicate the status of the authentication done by the device entity. The KEY DESCRIPTOR field shall contain the nonce value associated with the encrypted logical block.

A metadata key-associated data descriptor (see 6.8.3.2.4) shall be included if any M-KAD is associated with the next logical block and the decryption mode is set to RAW in the saved logical block encryption parameters currently associated with the I\_T\_L nexus on which this command was received. The KEY DESCRIPTOR field shall contain the M-KAD value associated with the encrypted logical block.

The following table indicates valid combinations of record status, Decryption Mode and returned Key-Associated Descriptors reflecting the currently setup state of the device.

**Table 402 — SPIN (20h[0021h]) - KAD Parameters by Mode**

Record Information	Decryption Mode	Read Data	Status	Key-Associated Descriptors				Notes
				uKAD 00h	aKAD (DKi) 01h	Nonce 02h	Meta data 03h	
Unknown	any	?	1h	O	O	n/a	n/a	
Filemark	any	n/a	1h, 3h, 5h, or 6h <sup>a</sup>	n/a	n/a	n/a	n/a	may be unknown
EOD	any	n/a	1h, 3h, 5h, or 6h <sup>a</sup>	O	O	n/a	n/a	may be unknown
Error	any	n/a	1h	O	O	n/a	n/a	may be unknown
Cleartext	0h Disable	C	3h	n/a	n/a	n/a	n/a	
Cleartext	1h Raw	E	3h	n/a	n/a	n/a	n/a	not readable
Cleartext	2h Decrypt	E	3h	n/a	n/a	n/a	n/a	not readable
Cleartext	3h Mixed	C	3h	n/a	n/a	n/a	n/a	
Legend: Y: element is required O: element is optional N: element is not present n/a: not applicable (element is not present) C: cleartext (not encrypted) R: raw (compressed encoded/encrypted) E: error condition, record cannot be read				Notes: 1: Data is decrypted 2: Drive returns Next Block Encryption Status values for the previous block when positioned at EOD  Footnotes: <sup>a</sup> Depends on surrounding content.				



Table 402 — SPIN (20h[0021h]) - KAD Parameters by Mode

Record Information	Decryption Mode	Read Data	Status	Key-Associated Descriptors				Notes
				uKAD 00h	aKAD (DKi) 01h	Nonce 02h	Meta data 03h	
Encrypted	0h Disable	E	4h 5h or 6h	O	O	N	N	not readable
Encrypted	1h Raw	R		N	N	N	Y	
Encrypted	2h Decrypt	C <sup>1</sup>		O	O	N	N	
Encrypted	3h Mixed	C <sup>1</sup>		O	O	N	N	
Legend: Y: element is required O: element is optional N: element is not present n/a: not applicable (element is not present) C: cleartext (not encrypted) R: raw (compressed encoded/encrypted) E: error condition, record cannot be read				Notes: 1: Data is decrypted 2: Drive returns Next Block Encryption Status values for the previous block when positioned at EOD  Footnotes: <sup>a</sup> Depends on surrounding content.				

### 6.8.2.7.1 Key-Associated Data (KAD) Descriptors

See “Key-Associated Data (KAD) Descriptors” on page 465

## 6.8.2.8 SPIN (20h[0030h]) - Random Number page

Table 403 specifies the format of the Random Number page.

**Table 403 — SPIN (20h[0030h]) Random Number page**

Byte	Bit							
	7 msb	6	5	4	3	2	1	0 lsb
0	(MSB)	PAGE CODE (0030h)						(LSB)
1		PAGE LENGTH (32)						(LSB)
2	(MSB)	RANDOM NUMBER						(LSB)
3								
4	(MSB)							
35								(LSB)

The RANDOM NUMBER field contains a secure random number, suitable for use as a random nonce, that is generated by the device server using a source of entropy available within the device. Each request for the Random Number page generates a new secure random number for the RANDOM NUMBER field.

### 6.8.2.9 SPIN (20h[0031h]) - Device Server Key Wrapping Public Key page

Table 403 specifies the format of the Device Server Key Wrapping Public Key page. This page returns the drive's key wrapping public key. The device supports only RSA 2048 public key wrapping.

**Table 404 — SPIN (20h[0031h]) Device Server Key Wrapping Public Key page**

Byte	Bit								
	7 msb	6	5	4	3	2	1	0 lsb	
0	(MSB)	PAGE CODE (0031h)							
1								(LSB)	
2	(MSB)	PAGE LENGTH (n-3)							
3								(LSB)	
4	(MSB)	PUBLIC KEY TYPE (00000000h)							
7								(LSB)	
8	(MSB)	PUBLIC KEY FORMAT (00000000h)							
11								(LSB)	
12	(MSB)	PUBLIC KEY LENGTH (n-13)							
13								(LSB)	
14	(MSB)	PUBLIC KEY							
n								(LSB)	

#### Byte Description

- 0-1 PAGE CODE: 0031h
- 2-3 PAGE LENGTH: The number of bytes that follow
- 4-7 PUBLIC KEY TYPE : The type of public key in the PUBLIC KEY field. This is set to 00000000h to indicated RSA 2048
- 8-11 PUBLIC KEY FORMAT : This field depends on the public key type. This is set to 00000000h to indicate RSA 2048.
- 12-13 PUBLIC KEY LENGTH : The length of the public key.
- 14-n PUBLIC KEY: This field depends on the public key type.

### 6.8.3 SPOUT Pages (20h - Tape Data Encryption security protocol)

See SECURITY PROTOCOL OUT (SPOUT) - B5h (see 5.2.35 on page 170) for a description of how to send this page.

The Security Protocol Specific field (see Table 138, "SECURITY PROTOCOL OUT B5h CDB," on page 170) specifies the type of page that the application client is sending. Table 405 shows supported values.

**Table 405 — SPOUT (20h) - Security Protocol Specific Definitions for Security Protocol 20h**

Page Code	Reference
0010h	SPOUT (20h[0010h]) - Set Data Encryption (see 6.8.3.1 on page 462)

### 6.8.3.1 SPOUT (20h[0010h]) - Set Data Encryption

See SECURITY PROTOCOL OUT (SPOUT) - B5h (see 5.2.35 on page 170) for a description of how to send this page.

Table 406 specifies the format of the Set Data Encryption page.

**Table 406 — SPOUT (20h[0010h]) - Set Data Encryption page**

Byte	Bit							
	7 msb	6	5	4	3	2	1	0 lsb
0	(MSB) PAGE CODE (0010h) (LSB)							
1								
2	(MSB) PAGE LENGTH (m-3) (LSB)							
3								
4	SCOPE			Reserved				LOCK
5	CEEM		RDMC		SDK (0b)	CKOD	CKORP	CKORL
6	ENCRYPTION MODE							
7	DECRYPTION MODE							
8	ALGORITHM INDEX							
9	LOGICAL BLOCK ENCRYPTION KEY FORMAT							
10	KAD FORMAT							
11	Reserved							
17								
18	(MSB) LOGICAL BLOCK ENCRYPTION KEY LENGTH (n-19) (LSB)							
19								
20	LOGICAL BLOCK ENCRYPTION KEY							
n								
Key-associated data descriptor list								
n+1	Key-associated data descriptor [first]							
m	Key-associated data descriptor [last]							

The following parameters apply:

- SCOPE

Value	Description
0h	Public
1h	Local
2h	All I_T Nexus

- LOCK

- CEEM (check external encryption mode)

Value	Description
00h	Use device default behavior (same behavior as 01b).
01b	Do not check the encryption mode that was in use when the logical block was written to the medium.
10b	On read and verify commands, check the encryption mode that was in use when the logical block was written to the medium. Report an error if the logical block was written in EXTERNAL mode
11b	On read and verify commands, check the encryption mode that was in use when the logical block was written to the medium. Report an error if the logical block was written in ENCRYPT mode

- RDMC (raw decryption mode control)

This field is ignored if the ENCRYPTION MODE field is not set to ENCRYPT.

Value	Description
00b	The device entity shall mark each encrypted logical block per the RDMC_C setting for the algorithm.
10b	The device entity shall mark each encrypted logical block written to the medium as enabled for raw decryption mode operations.
11b	The device entity shall mark each encrypted logical block written to the medium as disabled for raw decryption mode operations.

- CKOD (clear key on demount)
- CKORP (clear key on reservation preempt)
- CKORL (clear key on reservation loss)

- ENCRYPTION MODE

Value	Description
0h	Disable
1h	External
2h	Encrypt

- DECRYPTION MODE

Value	Description
0h	Disable
1h	Raw
2h	Decrypt
3h	Mixed

- ALGORITHM INDEX: The ALGORITHM INDEX is used based on the underlying format characteristics of each specific medium format. The drive allows relaxed usage of the value of this field and only enforces fields which are incompatible with the medium and may do so in a latent fashion (e.g., when operations which need to use such settings are attempted). Some examples include larger KAD sizes than supported by a generation which are flagged at write, or attempts to use raw copy methods (ENCRYPTION MODE of EXTERNAL between devices with incompatible / mismatched encryption algorithms).
- LOGICAL BLOCK ENCRYPTION KEY FORMAT: (see table 394)
- KAD FORMAT

A non-zero value is only allowed if the algorithm in the ALGORITHM INDEX field reports a KADF\_C bit set to one.

Value	Description
0h	Unspecified
1h	Binary logical block encryption key name
2h	ASCII logical block encryption key name

If the KAD FORMAT value is non-zero, then:

- a) a) only an A-KAD descriptor is provided and the authenticated key-associated data is the key name;
  - b) b) only a U-KAD descriptor is provided and the unauthenticated key-associated data is the key name; or
  - c) c) both an A-KAD descriptor and a U-KAD descriptor is provided and the key name is formed by the authenticated key-associated data followed by the unauthenticated key-associated data.
- LOGICAL BLOCK ENCRYPTION KEY LENGTH
 

Value	Description
0000h	When no Key is specified
0020h	When Key is specified using Key Format 00h
others	When Key is specified using Key Format 02h
  - LOGICAL BLOCK ENCRYPTION KEY
  - Key-Associated Descriptors List (See "Key-Associated Data (KAD) Descriptors" on page 465)

The following table indicates valid combinations of Encryption Mode and Decryption Mode and mandatory, optional and prohibited Key and Key-Associated Descriptors.

**Table 407 — SPOUT (20h[0010h]) - KAD Parameters by Mode**

Encryption Mode	Decryption Mode	R/W Data	Key	Key-Associated Descriptors				Notes
				uKAD 00h	aKAD (DKi) 01h	Nonce 02h	Meta data 03h	
0h Disable	0h Disable	C/C	P	P	P	P	P	
0h Disable	1h Raw	R/C	P	P	P	P	P	not recommended
0h Disable	2h Decrypt	C <sup>4</sup> /C	M <sup>2</sup>	P	P	P	P	not recommended
0h Disable	3h Mixed	C <sup>6</sup> /C	M <sup>2</sup>	P	P	P	P	
1h External	0h Disable	C/R	P	P	P	P	M <sup>1</sup>	not recommended
1h External	1h Raw	R/R	P	P	P	P	M <sup>1</sup>	
1h External	2h Decrypt	C <sup>4</sup> /R	M <sup>2</sup>	P	P	P	M <sup>1</sup>	not recommended
1h External	3h Mixed	C <sup>6</sup> /R	M <sup>2</sup>	P	P	P	M <sup>1</sup>	not recommended
2h Encrypt	0h Disable	C/C <sup>4</sup>	M <sup>1</sup>	O <sup>1</sup>	O <sup>1</sup>	O <sup>1,3</sup>	P	
2h Encrypt	1h Raw	R/C <sup>4</sup>	M <sup>1</sup>	O <sup>1</sup>	O <sup>1</sup>	O <sup>1,3</sup>	P	not recommended
2h Encrypt	2h Decrypt	C <sup>5</sup> /C <sup>4</sup>	M	O <sup>1</sup>	O <sup>1</sup>	O <sup>1,3</sup>	P	
2h Encrypt	3h Mixed	C <sup>6</sup> /C <sup>4</sup>	M	O <sup>1</sup>	O <sup>1</sup>	O <sup>1,3</sup>	P	
Legend:				Notes:				
M: element is mandatory (required)				1: Only used for writing				
P: element prohibited (must not be present)				2: Only used for reading				
O: element is optional (may be device generated)				3: May be partially ignored				
I: element is ignored (may be present)				4: Data is encrypted				
C: cleartext (not encrypted)				5: Data is decrypted				
R: raw (compressed encoded/encrypted)				6: Data is decrypted (if needed)				

### 6.8.3.2 Key-Associated Data (KAD) Descriptors

#### 6.8.3.2.1 KAD 00h - UKAD (Unauthenticated KAD)

The UKAD field is an optional field which is used when writing and is recorded with each record.

**Table 408 — KAD 00h - UKAD (Unauthenticated KAD)**

Byte	Bit							
	7 msb	6	5	4	3	2	1	0 lsb
0	KEY DESCRIPTOR TYPE (00h)							
1	Reserved				AUTHENTICATED			
2	(MSB)	KEY DESCRIPTOR LENGTH (n-3)						(LSB)
3								
4								
n	UNAUTHENTICATED DATA							

The following parameters apply:

- AUTHENTICATED
 

Value	Description
0h	Reserved (must be set for Security Protocol Out)
1h	Not Covered by Authentication (only Security Protocol In)
- KEY DESCRIPTOR LENGTH: may be up to 0020h bytes.
- UNAUTHENTICATED DATA

#### 6.8.3.2.2 KAD 01h - AKAD (Authenticated KAD) / DKi (Data Key Identifier)

The AKAD field is an optional field which is used when writing and is recorded with each record. This also referred to as the DKi (Data Key Identifier) in some related encryption documentation.

**Table 409 — KAD 01h - AKAD (Authenticated KAD) / DKi (Data Key Identifier)**

Byte	Bit							
	7 msb	6	5	4	3	2	1	0 lsb
0	KEY DESCRIPTOR TYPE (01h)							
1	Reserved				AUTHENTICATED			
2	(MSB)	KEY DESCRIPTOR LENGTH (n-3)						(LSB)
3								
4								
n	AUTHENTICATED DATA / DKi							

The following parameters apply:

- AUTHENTICATED
 

Value	Description
0h	Reserved (must be set for Security Protocol Out)
2h	No attempt has been made to authenticate (only Security Protocol In)
- KEY DESCRIPTOR LENGTH: maximum size is determined by generation algorithm.
- AUTHENTICATED DATA / DKi

### 6.8.3.2.3 KAD 02h - Nonce

The Nonce/IV is not technically KAD. The Nonce may be set to provide the initial value for IV generation for write operations. This field is optional and the device is capable of generating high quality random IV values. When an application specifies nonce values, it is possible that a systemic cryptographic weakness may be introduced into the system. It is strongly recommended that nonce values are not supplied by the application.

NOTE 70 - The Nonce KAD is only reported by the device in SPIN (20h[0020h]) - Data Encryption Status page (see 6.8.2.6 on page 453), and the value returned is the exact value specified in SPOUT (20h[0010h]) - Set Data Encryption (see 6.8.3.1 on page 462). This may not reflect the actual nonce or IV used for writing encrypted data.

NOTE 71 - IV values are constructed using only part of the specified Nonce value and are altered for each write in a device dependent manner.

**Table 410 — KAD 02h - Nonce**

Byte	Bit							
	7 msb	6	5	4	3	2	1	0 lsb
0	Key Descriptor Type (02h)							
1	Reserved				Authenticated			
2	(MSB)	KEY DESCRIPTOR LENGTH (000Ch)						(LSB)
3								
4	NONCE/IV							
n								

The following parameters apply:

- AUTHENTICATED
 

Value	Description
0h	Reserved (must be set for Security Protocol Out)
1h	Not Covered by Authentication (only Security Protocol In)
- KEY DESCRIPTOR LENGTH: the only supported length is 000Ch
- NONCE/IV



### 6.8.3.2.4 KAD 03h - MKAD (Metadata)

The MKAD field is used for a keyless copy operation (i.e., RAW decryption mode and EXTERNAL encryption mode).

**Table 411 — KAD 03h - MKAD (Metadata)**

Byte	Bit								
	7 msb	6	5	4	3	2	1	0 lsb	
0	KEY DESCRIPTOR TYPE (03h)								
1	Reserved				AUTHENTICATED				
2	(MSB)	KEY DESCRIPTOR LENGTH (n-3)							
3								(LSB)	
4	KEY DESCRIPTOR								
n									

The following parameters apply:

- AUTHENTICATED
 

Value	Description
0h	Reserved (must be set for Security Protocol Out)
2h	No attempt has been made to authenticate (only Security Protocol In)
- KEY DESCRIPTOR LENGTH
- KEY DESCRIPTOR: Data required by the encryption algorithm for a keyless copy operation.



## Annex A. Summary of Drive Generation Differences

This chapter provides a summary of the differences in host attachment protocol between:

- a) the System Storage Ultrium 9 Tape Drive (Generation 9);
- b) the System Storage Ultrium 8 Tape Drive (Generation 8);
- c) the System Storage Ultrium 7 Tape Drive (Generation 7);
- d) the System Storage Ultrium 6 Tape Drive (Generation 6); and
- e) the System Storage Ultrium 5 Tape Drive (Generation 5).

The features of the Ultrium 9 Tape Drive that differ from those of the previous generations include the following:

- a) Increased maximum sustained native data rate on the full-height drive
- b) Makes Archive Mode Unthread enabled and non-changeable
- c) Adds volume optimization of a cartridge (adds significant time to first-time load & FORMAT MEDIUM command)
- d) Adds support for Recommended Access Order (RAO) on the full-height drive
- e) Adds support for 12 Gb SAS
- f) Maximizes the capacity of partitions by using band boundaries to guard between partitions instead of guard wraps when there are an even number of equally sized partitions created with SDP.

The features of the Ultrium 8 Tape Drive that differ from those of the previous generations include the following:

- a) Increased maximum sustained native data rate on the full-height drive
- b) Supports a Type M cartridge. Type M cartridge is an Ultrium 7 cartridge that is used at a 9 000 GB capacity, and is called an M8 cartridge. See Supported Tape Cartridges (see 3.4 on page 22).

The features of the Ultrium 7 Tape Drive that differ from those of the previous generations include the following:

- a) Larger read-and-write cache
- b) 32 data channels
- c) Improved rewrite methodology decreases capacity loss due to errors while writing
- d) Ability to disable BOP caching

The features of the Ultrium 6 Tape Drive that differ from those of the previous generations include the following:

- a) Larger read-and-write cache
- b) Partition capability up to four partitions (see 6.6.13)
- c) Improved SkipSync capability (see 6.6.21.5.1)
- d) Larger compression history buffer enabling improved nominal compression ratio

The features of the Ultrium 5 Tape Drive that differ from those of the previous generations include the following:

- a) Full-Height and Half-Height drive option with:
  - A) Fibre Channel 8Gbit/sec Interface, or
  - B) Serial Attached SCSI (SAS) 6Gbit/sec Interface
- b) Larger read-and-write cache
- c) Encryption of data on Ultrium 4 and Ultrium 5 cartridges
- d) T10 key management method
- e) Transparent management method
  - A) when using IBM device driver,
  - B) when in an IBM library, or
  - C) when using T10 External Encryption Control
- f) 14 Speeds in Digital Speed Matching
- g) Partition capability up to two partitions (see 6.6.13)
- h) Data Safe Mode (i.e., Append-only mode) capability (see 4.2.3)
- i) SkipSync capability (see 6.6.21.5.1)
- j) Ideal Capacity (see 6.6.21.5.2)
- k) Dynamic Runtime Attributes
- l) Power Condition mode page for user controlled power management (see 6.6.16)
- m) Ethernet port for configuration/debug (see 6.6.21.3)
- n) Standards based setting of time (see 4.17)
- o) Logical block protection (i.e., CRC on bus; fixity checks; tape checksum) (see 4.9)

- p) Command timeout values reported at runtime with Report Supported Opcodes command (see 5.2.28)
- q) Standards based retrieval of drive error logs (i.e., drive dump)
- r) New standardized log pages with expanded counters:
  - A) Extended Device Statistics log page (14h) (see 6.4.12)
  - B) Volume Statistics log page (17h) (see 6.4.14)
  - C) Data Compression log page (1Bh) (see 6.4.17)

## A.1. Differences in Command Timeout Values

Due to differences between the of the various Ultrium drive products, the maximum amount of time it takes for various SCSI commands to process and return status may be different. A list of all recommended host command time-outs from commands defined by the referenced SCSI-3 standard or by this product as vendor-unique for sequential access devices are listed with the following information for each command: the operation code, recommended timeout, and notes.

It is strongly recommended that device drivers or host software implement device reservations using the Reserve or Persistent Reserve commands. Due to the sequential nature of tape devices, many host commands are serialized, and command time-outs consequently have an additive effect. Using reservations prevents this from causing application disruptions in a multi-initiator or SAN environment. Similar additive timeout effects can occur if the host is using command Queuing (that is, simple queuing).

The time-outs are based on the time from the start of command processing, to its reported completion. Since applications are generally concerned with the time from the command being issued, to its reported completion, it should be noted that this overall time may be affected by currently processing operations. Some of these conditions include:

- a) A prior command was issued with the Immediate bit set in the CDB
- b) Multiple concurrent commands with Simple queuing are processed
- c) Multi-initiator configurations without reservations
- d) Non-host operations, such as manual unloads, power-on self tests, and so on
- e) Commands issued shortly after certain aborted commands
- f) Commands that force flushes when unwritten write data is in the buffer

Ultrium 5 and later tape drives support the REPORT SUPPORTED OPERATION CODES - A3h[0Ch] (see 5.2.28 on page 143) command and provide command timeout values at run time. See the REPORT SUPPORTED OPERATION CODES command for Ultrium 5 and later tape drive command timeouts. Command timeout values for Ultrium 1 through Ultrium 4 tape drives are listed in the following tables:

Table 412, "Command Timeout Values (Ultrium 1, 2, and 3 Full-Height) - Alphabetic Sort," on page 471

Table 413, "Command Timeout Values (Ultrium 3 Half-Height and Ultrium 4) - Alphabetic Sort," on page 473

Table 412 — Command Timeout Values (Ultrium 1, 2, and 3 Full-Height) - Alphabetic Sort (part 1 of 2)

OpCode	Command	Timeout for Ultrium Tape Drive (in minutes)	Timeout for Ultrium 2 Tape Drive (in minutes)		Timeout for Ultrium 3 Full-Height Tape Drive (in minutes)		
			Gen 1 Cartridge	Gen 2 Cartridge	Gen 1 Cartridge	Gen 2 Cartridge	Gen 3 Cartridge
19h	ERASE	204	138	151	N/A	160	134
12h	INQUIRY	1	1	1	1	1	1
1Bh	LOAD (Cartridge Insert -> BOM)	11	12	12	8	8	8
	LOAD (LP4 -> BOM)	8	9	8	8	8	9
2Bh/92h	LOCATE(10/16) (Normal)	16	15	14	14	14	16
	LOCATE(10/16) (Slow)	173	138	151	127	165	140
4Ch	LOG SELECT	1	1	1	1	1	1
4Dh	LOG SENSE	1	1	1	1	1	1
15h/55h	MODE SELECT(6/10)	1	1	1	1	1	1
1Ah/5Ah	MODE SENSE(6/10)	1	1	1	1	1	1
5Eh	PERSISTENT RESERVE IN (PRIN)	1	1	1	1	1	1
5Fh	PERSISTENT RESERVE OUT (PROUT)	1	1	1	1	1	1
1Eh	PREVENT/ALLOW MEDIUM REMOVAL	1	1	1	1	1	1
08h	READ	18	18	18	16	16	17
8Ch	READ ATTRIBUTE	1	1	1	1	1	1
05h	READ BLOCK LIMITS	1	1	1	1	1	1
3Ch	READ BUFFER	8	8	8	7	7	8
34h	READ POSITION	1	1	1	1	1	1
1Ch	RECEIVE DIAGNOSTIC RESULTS	1	1	1	1	1	1
17h/57h	RELEASE UNIT(6/10)	1	1	1	1	1	1
44h	REPORT DENSITY SUPPORT	1	1	1	1	1	1
A0h	REPORT LUNS	1	1	1	1	1	1
A3h:0Ch	REPORT SUPPORTED OPERATION CODES	N/A	N/A	N/A	1	1	1
A3h:0Dh	REPORT SUPPORTED TASK MANAGEMENT FUNCTIONS	N/A	N/A	N/A	1	1	1
A3h:0Fh	REPORT TIMESTAMP	N/A	N/A	N/A	1	1	1
03h	REQUEST SENSE	1	1	1	1	1	1
16h/56h	RESERVE UNIT(6/10)	1	1	1	1	1	1
01h	REWIND	8	9	8	8	8	9
A2h	SECURITY PROTOCOL IN (SPIN)	N/A	N/A	N/A	N/A	N/A	1
B5h	SECURITY PROTOCOL OUT (SPOUT)	N/A	N/A	N/A	N/A	N/A	N/A
1Dh	SEND DIAGNOSTIC	29	35	35	13	39	34
0Bh	SET CAPACITY	N/A	13	13	N/A	11	12
A4h:0Fh	SET TIMESTAMP	N/A	N/A	N/A	1	1	1

Table 412 — Command Timeout Values (Ultrium 1, 2, and 3 Full-Height) - Alphabetic Sort (part 2 of 2)

OpCode	Command	Timeout for Ultrium Tape Drive (in minutes)	Timeout for Ultrium 2 Tape Drive (in minutes)		Timeout for Ultrium 3 Full-Height Tape Drive (in minutes)		
			Gen 1 Cartridge	Gen 2 Cartridge	Gen 1 Cartridge	Gen 2 Cartridge	Gen 3 Cartridge
91h	SPACE(16) (Normal)	N/A	N/A	N/A	14	14	16
	SPACE(16) (Slow)	N/A	N/A	N/A	127	165	140
11h	SPACE(6) (Normal)	16	15	14	14	14	16
	SPACE(6) (Slow)	173	138	151	127	165	140
00h	TEST UNIT READY	1	1	1	1	1	1
1Bh	UNLOAD (BOM -> Cartridge Eject)	10	10	10	10	10	11
	UNLOAD (LP4 -> Cartridge Eject)	11	12	11	11	11	12
13h	VERIFY	18	18	18			
0Ah	WRITE	18	18	18	N/A	16	18
8Dh	WRITE ATTRIBUTE	1	1	1	1	1	1
3Bh	WRITE BUFFER	8	8	8	8	8	8
10h	WRITE FILEMARK	15	15	15	N/A	15	17

Table 413 — Command Timeout Values (Ultrium 3 Half-Height and Ultrium 4) - Alphabetic Sort (part 1 of 2)

OpCode	Command	Timeout for Ultrium 3 Half-Height Tape drive (in minutes)			Timeout for Ultrium 4 Tape Drive (in minutes)		
		Gen 1 Cartridge	Gen 2 Cartridge	Gen 3 Cartridge	Gen 2 Cartridge	Gen 3 Cartridge	Gen 4 Cartridge
19h	ERASE	N/A	191	255	N/A	134	180 <sup>a</sup>
12h	INQUIRY	1	1	1	1	1	1
1Bh	LOAD (Cartridge Insert -> BOM)	9	9	9	8	8	8
	LOAD (LP4 -> BOM)	11	11	13	8	9	9
2Bh/92h	LOCATE(10/16) (Normal)	20	20	22	14	16	21
	LOCATE(10/16) (Slow)	199	264	201	165	140	183
4Ch	LOG SELECT	1	1	1	1	1	1
4Dh	LOG SENSE	1	1	1	1	1	1
15h/55h	MODE SELECT (6/10)	1	1	1	1	1	1 <sup>a</sup>
1Ah/5Ah	MODE SENSE (6/10)	1	1	1	1	1	1
5Eh	PERSISTENT RESERVE IN	1	1	1	1	1	1
5Fh	PERSISTENT RESERVE OUT	1	1	1	1	1	1
1Eh	PREVENT/ALLOW MEDIUM REMOVAL	1	1	1	1	1	1
08h	READ	21	21	23	16	17	22 <sup>b</sup>
BCh	READ ATTRIBUTE	1	1	1	1	1	1
05h	READ BLOCK LIMITS	1	1	1	1	1	1
3Ch	READ BUFFER	9	9	10	7	8	8
34h	READ POSITION	1	1	1	1	1	1
1Ch	RECEIVE DIAGNOSTIC RESULTS	1	1	1	1	1	1
17h/57h	RELEASE UNIT (6/10)	1	1	1	1	1	1
44h	REPORT DENSITY SUPPORT	1	1	1	1	1	1
A0h	REPORT LUNS	1	1	1	1	1	1
A3h:0Ch	REPORT SUPPORTED OP CODES	1	1	1	1	1	1
A3h:0Dh	REPORT SUPPORTED TASK MANAGEMENT FUNCTIONS	1	1	1	1	1	1
A3h:0Fh	REPORT TIMESTAMP	1	1	1	1	1	1
03h	REQUEST SENSE	1	1	1	1	1	1
16h/56h	RESERVE UNIT (6/10)	1	1	1	1	1	1
01h	REWIND	11	11	13	8	9	9
A2h	SECURITY PROTOCOL IN	N/A	N/A	N/A	N/A	N/A	1
B5h	SECURITY PROTOCOL OUT	N/A	N/A	N/A	N/A	N/A	1
1Dh	SEND DIAGNOSTIC	13	39	40	13	34	35
0Bh	SET CAPACITY	N/A	14	16	N/A	12	12
A4h:0Fh	SET TIMESTAMP	1	1	1	1	1	1
11h/91h	SPACE(16) (Normal)	20	20	22	14	16	21
	SPACE(16) (Slow)	199	264	201	165	140	183

**Table 413 — Command Timeout Values (Ultrium 3 Half-Height and Ultrium 4) - Alphabetic Sort (part 2 of 2)**

OpCode	Command	Timeout for Ultrium 3 Half-Height Tape drive (in minutes)			Timeout for Ultrium 4 Tape Drive (in minutes)		
		Gen 1 Cartridge	Gen 2 Cartridge	Gen 3 Cartridge	Gen 2 Cartridge	Gen 3 Cartridge	Gen 4 Cartridge
00h	TEST UNIT READY	1	1	1	1	1	1
1Bh	UNLOAD (BOM -> Cartridge Eject)	12	12	14	10	11	11
	UNLOAD (LP4 -> Cartridge Eject)	14	14	16	11	12	13
13h	VERIFY	21	21	23	16	17	22 <sup>b</sup>
0Ah	WRITE	N/A	21	24	N/A	18	23 <sup>b</sup>
BDh	WRITE ATTRIBUTE	1	1	1	1	1	1
3Bh	WRITE BUFFER	10	10	11	8	8	8
10h	WRITE FILEMARK	N/A	21	23	N/A	17	22 <sup>a</sup>
<sup>a</sup> When positioned at BOP: These commands require an increased timeout when encryption is active and an out-of-band key manager is used. The command timeout should be increased by 300 seconds. <sup>b</sup> These commands require an increased timeout when encryption is active and an out-of-band key manager is used. The command timeout should be increased by 300 seconds.							

## A.2. Command and Parameter Differences Between Generations

Table A.1 shows commands and parameters added since LTO5 and in which generation(s) it is applicable.

**Table A.1 — Command and Parameter differences between generations**

Command or Parameter	Generation				
	5	6	7	8	9
GENERATE RECOMMENDED ACCESS ORDER (GRAO) - A4h[1Dh] (LTO9+) (see 5.2.4 on page 82)	-	-	-	-	Y <sup>a</sup>
RECEIVE RECOMMENDED ACCESS ORDER (RRAO) - A3h[1Dh] (LTO9+) (see 5.2.24 on page 131)	-	-	-	-	Y <sup>a</sup>
LP 0Dh[01h]: Environmental Reporting (LTO9 and later) (see 6.4.9 on page 266)	-	-	-	-	Y
Design Capacity (see 3.4.1 on page 23)	-	-	-	Y <sup>b</sup>	Y
Archive mode unthread (LTO7+) (see 4.3 on page 29)	-	-	Y <sup>b</sup>	Y <sup>b</sup>	Y
DT device primary port physical interface information (see 6.4.10.1.9 on page 283)	-	-	Y <sup>b</sup>	Y <sup>b</sup>	Y
IP C1h: Drive Serial Numbers (see 6.3.15 on page 250)	-	-	Y <sup>b</sup>	Y <sup>b</sup>	Y
IP C2h: Drive Bar codes (see 6.3.16 on page 251)	-	-	Y <sup>b</sup>	Y <sup>b</sup>	Y
IP C3h: Subcomponent Version List (see 6.3.17)	-	-	Y <sup>b</sup>	Y <sup>b</sup>	Y
READ END OF WRAP POSITION - A3h[1Fh][45h] (see 5.2.20 on page 119)	-	-	Y	Y	Y
READ LOGGED-IN HOST TABLE - A3h[1Fh][01h] (see 5.2.21 on page 122)	-	-	Y	Y	Y
MP 30h[43h]: Feature switches - Device attribute settings (see 6.6.21.5.3 on page 415)	-	-	Y	Y	Y
Logical block protection support using the CRC32C (Castagnoli) algorithm (see D.2.) was added. See Logical block protection (see 4.9 on page 43)	-	-	Y	Y	Y
Many counter sizes were increased. See Log Parameters (LP) (see 6.4 on page 255)	-	-	Y	Y	Y
LTFS MAM parms 0820h & 0821h were added. See Host type attributes (see 6.5.2.4 on page 355)	-	-	Y	Y	Y
Inquiry Allocation Length expanded. See INQUIRY - 12h (see 5.2.5 on page 84)	-	-	Y	Y	Y
Mode page behaviors were made consistent and non-standard behaviors better described. See Mode Page Behaviors (see 4.7 on page 39)	-	-	Y	Y	Y



Table A.1 — Command and Parameter differences between generations

Command or Parameter	Generation				
	5	6	7	8	9
RB 19h: Host non-volatile (see 6.7.2.4 on page 428)	-	-	Y	Y	Y
MP 1Ch: Informational Exceptions Control (see 6.6.17 on page 390) behaviors were modified	-	-	Y	Y	Y
IP B3h: Automation Device Serial Number (see 6.3.11 on page 245)	-	-	Y	Y	Y
IP B4h: Data Transfer Device Element Address (see 6.3.12 on page 245)	-	-	Y	Y	Y
SPIN (00h[0002h]) - Security Compliance Information (see 6.8.1.3 on page 442)	-	-	Y	Y	Y
SPIN (20h[0031h]) - Device Server Key Wrapping Public Key page (see 6.8.2.9 on page 461)	-	-	Y	Y	Y
IP B1h: Manufacturer-assigned Serial Number (see 6.3.10 on page 244)	-	Y	Y	Y	Y
BOP caching (see 4.5.2 on page 34)	-	Y	Y	Y	Y
IP B5h: Logical Block Protection (see 6.3.13)	Y <sup>b</sup>	Y <sup>b</sup>	Y <sup>b</sup>	Y	Y
Key: - Not Supported <sup>a</sup> Full-Height drive only <sup>b</sup> Added after GA					



## Annex B. Error Sense Information

This annex lists all possible combinations of Sense Keys, Additional Sense Codes (ASC), and Additional Sense Code Qualifiers (ASCQ) that are reported by this device.

NOTE 72 - ASCs of EEh and EFh are used for encryption related features and are only supported by encryption capable devices

NOTE 73 - When using encryption enabled devices in an in-band configuration (System method or key path), ASCs of EFh are used to initiate a key management session via a system proxy.

### B.1. Sense Key 0 (No Sense)

Table 414 — ASC, and ASCQ Summary for Sense Key 0 (No Sense)

ASC ASCQ	Description
00 00	NO ADDITIONAL SENSE INFORMATION - (UNSOLICITED, NO CA/CC)
00 00	NO ADDITIONAL SENSE INFORMATION - EOM=1B (EARLY WARNING)
00 00	NO ADDITIONAL SENSE INFORMATION - ILI=1B
00 00	NO ADDITIONAL SENSE INFORMATION - FM=1B
00 01	FILEMARK DETECTED
00 02	END-OF-PARTITION/MEDIUM DETECTED, EARLY WARNING
00 04	BEGINNING-OF-PARTITION/MEDIUM DETECTED
00 07	PROGRAMMABLE EARLY WARNING DETECTED
00 16	OPERATION IN PROGRESS
00 18	ERASE OPERATION IN PROGRESS
00 19	LOCATE OPERATION IN PROGRESS
00 1C	VERIFY OPERATION IN PROGRESS
5E 00	Always replaced by 5E 07
5E 07	IDLE_C CONDITION ACTIVATED BY TIMER (and LOW POWER CONDITION ON for any reason)
82 82	DRIVE REQUIRES CLEANING
EF 13	ENCRYPTION - KEY TRANSLATE
<p>Note - ASCs of EEh and EFh are used for encryption related features and are only supported by encryption capable devices</p> <p>Note - When using encryption enabled devices in an in-band configuration (System method or key path), ASCs of EFh are used to initiate a key management session via a system proxy.</p>	

## B.2. Sense Key 1 (Recovered Error)

Table 415 — ASC, and ASCQ Summary for Sense Key 1 (Recovered Error)

ASC ASCQ	Description
00 00	NO ADDITIONAL SENSE INFORMATION
00 17	DRIVE NEEDS CLEANING
0C 00	WRITE ERROR: A write error occurred, but was recovered. Data was successfully written to tape.
11 00	READ ERROR: A read error occurred, but was recovered. Data was successfully read from tape.
17 01	RECOVERED DATA WITH RETRIES
37 00	ROUNDED PARAMETER
5D 00	FAILURE PREDICTION THRESHOLD EXCEEDED
5D FF	FAILURE PREDICTION THRESHOLD EXCEEDED (FALSE)
82 52	DEGRADED MEDIA
83 83	DRIVE HAS BEEN CLEANED
<p>Note - Many additional ASC ASCQ combinations are possible if recovered error reporting is enabled via Mode Select. Recovered Error Reporting Enabled is the default option with some of the device drivers.</p>	

## B.3. Sense Key 2 (Not Ready)

Table 416 — ASC, and ASCQ Summary for Sense Key 2 (Not Ready)

ASC ASCQ	Description
04 00	LOGICAL UNIT NOT READY, CAUSE NOT REPORTABLE
04 01	LOGICAL UNIT IS IN PROCESS OF BECOMING READY
04 02	INITIALIZING COMMAND REQUIRED: A tape is present in the drive, but it is not logically loaded
04 04	NOT READY, FORMAT IN PROGRESS
04 12	LOGICAL UNIT NOT READY, OFFLINE
04 13	LOGICAL UNIT NOT READY, SA CREATION IN PROGRESS
0B 01	WARNING - SPECIFIED TEMPERATURE EXCEEDED
30 03	CLEANING IN PROGRESS
30 07	CLEANING FAILURE
3A 00	MEDIUM NOT PRESENT
3A 04	NOT READY - MEDIUM AUXILIARY MEMORY ACCESSIBLE
3E 00	LOGICAL UNIT HAS NOT SELF-CONFIGURED
53 00	MEDIA LOAD OR EJECT FAILED
74 11	SA CREATION PARAMETER VALUE REJECTED

**B.4. Sense Key 3 (Medium Error)****Table 417 — ASC, and ASCQ Summary for Sense Key 3 (Medium Error)**

ASC ASCQ	Description
04 10	LOGICAL UNIT NOT READY, AUXILIARY MEMORY NOT ACCESSIBLE
09 00	TRACK FOLLOWING ERROR
0C 00	WRITE ERROR
11 00	UNRECOVERED READ ERROR
11 12	AUXILIARY MEMORY READ ERROR
14 00	RECORDED ENTITY NOT FOUND
30 00	INCOMPATIBLE MEDIUM INSTALLED
30 01	CANNOT READ MEDIUM, UNKNOWN FORMAT
30 02	CANNOT READ MEDIUM, INCOMPATIBLE FORMAT
30 0D	WORM MEDIUM - TAMPERING DETECTED
31 00	MEDIUM FORMAT CORRUPTED
3B 00	SEQUENTIAL POSITIONING ERROR
50 00	WRITE APPEND ERROR
51 00	ERASE FAILURE
52 00	CARTRIDGE FAULT
53 00	MEDIA LOAD OR EJECT FAILED
53 04	MEDIUM THREAD OR UNTHREAD FAILURE
EE 60	ENCRYPTION - PROXY COMMAND ERROR
EE D0	ENCRYPTION - DATA READ DECRYPTION FAILURE
EE D1	ENCRYPTION - DATA READ AFTER WRITE DECRYPTION FAILURE
EE E0	ENCRYPTION - KEY TRANSLATION FAILURE
EE E1	ENCRYPTION - KEY TRANSLATION AMBIGUOUS
EE F0	ENCRYPTION - DECRYPTION FENCED (READ)
EE F1	ENCRYPTION - ENCRYPTION FENCED (WRITE)
<p>Note - ASCs of EEh and EFh are used for encryption related features and are only supported by encryption capable devices</p> <p>Note - When using encryption enabled devices in an in-band configuration (System method or key path), ASCs of EFh are used to initiate a key management session via a system proxy.</p>	

## B.5. Sense Key 4 (Hardware Error)

Table 418 — ASC, and ASCQ Summary for Sense Key 4 (Hardware Error)

ASC ASCQ	Description
03 02	EXCESSIVE WRITE ERRORS: The drive is fenced. Contact Service
04 03	MANUAL INTERVENTION REQUIRED: A tape is present in the drive but could not be loaded or unloaded without manual intervention. Contact Service
10 01	LOGICAL BLOCK GUARD CHECK FAILED
40 XX	DIAGNOSTIC FAILURE: The Additional Sense Code Qualifier (i.e., XX) indicates the failing component. Contact Service
41 00	DATA PATH FAILURE
44 00	INTERNAL TARGET FAILURE Drive Needs Cleaning, Warning Threshold Exceeded
51 00	ERASE FAILURE
52 00	CARTRIDGE FAULT
53 00	MEDIA LOAD OR EJECT FAILED
53 04	MEDIUM THREAD OR UNTHREAD FAILURE
EE 0E	ENCRYPTION - KEY SERVICE TIME-OUT <sup>a</sup>
EE 0F	ENCRYPTION - KEY SERVICE FAILURE <sup>a</sup>
<p>Note - ASCs of EEh and EFh are used for encryption related features and are only supported by encryption capable devices</p> <p>Note - When using encryption enabled devices in an in-band configuration (System method or key path), ASCs of EFh are used to initiate a key management session via a system proxy.</p> <p><sup>a</sup> Returned in LTO5 and earlier</p>	

## B.6. Sense Key 5 (Illegal Request)

**Table 419 — ASC, and ASCQ Summary for Sense Key 5 (Illegal Request)** (part 1 of 2)

ASC ASCQ	Description
0E 03	INVALID FIELD IN COMMAND INFORMATION UNIT (e.g., FCP_DL error)
1A 00	PARAMETER LIST LENGTH ERROR
20 00	INVALID COMMAND OPERATION CODE
20 0C	ILLEGAL COMMAND WHEN NOT IN APPEND-ONLY MODE
24 00	INVALID FIELD IN CDB
25 00	LOGICAL UNIT NOT SUPPORTED
26 00	INVALID FIELD IN PARAMETER LIST
26 02	PARAMETER VALUE INVALID
26 04	INVALID RELEASE OF PERSISTENT RESERVATION
26 11	ENCRYPTION - INCOMPLETE KEY-ASSOCIATE DATA SET
26 12	VENDOR SPECIFIC KEY REFERENCE NOT FOUND
29 04	DEVICE INTERNAL RESET
2A 0B	ERROR HISTORY SNAPSHOT RELEASED
2C 00	COMMAND SEQUENCE ERROR
2C 0B	NOT RESERVED - The OIR bit of the Sequential Access Device page is set and the I_T nexus attempting to communicate with the drive does not hold a reservation.
3B 00	SEQUENTIAL POSITIONING ERROR
3B 0C	POSITION PAST BEGINNING OF MEDIUM: A command that required the medium to be at BOP was attempted when the medium was not at BOP (for example, SET CAPACITY)
49 00	INVALID MESSAGE ERROR
53 02	MEDIUM REMOVAL PREVENTED
55 08	MAXIMUM NUMBER OF SUPPLEMENTAL DECRYPTION KEYS EXCEEDED
74 08	DIGITAL SIGNATURE VALIDATION FAILURE
74 0C	UNABLE TO DECRYPT PARAMETER LIST
74 10	SA CREATION PARAMETER VALUE INVALID
74 11	SA CREATION PARAMETER VALUE REJECTED
74 12	INVALID SA USAGE
74 30	SA CREATION PARAMETER NOT SUPPORTED
82 83	BAD MICROCODE DETECTED: The data transferred to the drive during a firmware upgrade is corrupted or incompatible with the drive hardware
A3 01	OEM Vendor-specific
EE 00	ENCRYPTION - KEY SERVICE NOT ENABLED
EE 01	ENCRYPTION - KEY SERVICE NOT CONFIGURED
EE 02	ENCRYPTION - KEY SERVICE NOT AVAILABLE
EE 0D	ENCRYPTION - MESSAGE CONTENT ERROR
EE 10	ENCRYPTION - KEY REQUIRED
<p>Note - ASCs of EEh and EFh are used for encryption related features and are only supported by encryption capable devices</p> <p>Note - When using encryption enabled devices in an in-band configuration (System method or key path), ASCs of EFh are used to initiate a key management session via a system proxy.</p>	

Table 419 — ASC, and ASCQ Summary for Sense Key 5 (Illegal Request) (part 2 of 2)

ASC ASCQ	Description
EE 20	ENCRYPTION - KEY COUNT EXCEEDED
EE 21	ENCRYPTION - KEY ALIAS EXCEEDED
EE 22	ENCRYPTION - KEY RESERVED
EE 23	ENCRYPTION - KEY CONFLICT
EE 24	ENCRYPTION - KEY METHOD CHANGE
EE 25	ENCRYPTION - KEY FORMAT NOT SUPPORTED
EE 26	ENCRYPTION - UNAUTHORIZED REQUEST - DAK
EE 27	ENCRYPTION - UNAUTHORIZED REQUEST - DSK
EE 28	ENCRYPTION - UNAUTHORIZED REQUEST - EAK
EE 29	ENCRYPTION - AUTHENTICATION FAILURE
EE 2A	ENCRYPTION - INVALID RDKI
EE 2B	ENCRYPTION - KEY INCORRECT
EE 2C	ENCRYPTION - KEY WRAPPING FAILURE
EE 2D	ENCRYPTION - SEQUENCING FAILURE
EE 2E	ENCRYPTION - UNSUPPORTED TYPE
EE 2F	ENCRYPTION - NEW KEY ENCRYPTED WRITE PENDING
EE 30	ENCRYPTION - PROHIBITED REQUEST
EE 31	ENCRYPTION - KEY UNKNOWN
EE 32	ENCRYPTION - UNAUTHORIZED REQUEST - dCERT
EE 42	ENCRYPTION - EKM CHALLENGE PENDING
EE E2	ENCRYPTION - KEY TRANSLATION DISALLOWED
EE FF	ENCRYPTION - SECURITY PROHIBITED FUNCTION
EF 01	ENCRYPTION - KEY SERVICE NOT CONFIGURED
<p>Note - ASCs of EEh and EFh are used for encryption related features and are only supported by encryption capable devices</p> <p>Note - When using encryption enabled devices in an in-band configuration (System method or key path), ASCs of EFh are used to initiate a key management session via a system proxy.</p>	



**B.7. Sense Key 6 (Unit Attention)****Table 420 — ASC, and ASCQ Summary for Sense Key 6 (Unit Attention)** (part 1 of 2)

ASC ASCQ	Description
28 00	NOT READY TO READY TRANSITION, MEDIUM MAY HAVE CHANGED
28 01	IMPORT OR EXPORT ELEMENT ACCESSED
29 00	POWER ON, RESET, OR BUS DEVICE RESET OCCURRED
29 04	DEVICE INTERNAL RESET
29 05	TRANSCEIVER MODE CHANGED TO SINGLE-ENDED
29 06	TRANSCEIVER MODE CHANGED TO LVD
2A 01	MODE PARAMETERS CHANGED
2A 02	LOG PARAMETERS CHANGED
2A 03	RESERVATIONS PREEMPTED
2A 04	RESERVATIONS RELEASED
2A 05	REGISTRATIONS PREEMPTED
2A 0A	ERROR HISTORY I_T NEXUS CLEARED
2A 11	ENCRYPTION - DATA ENCRYPTION PARAMETERS CHANGED BY ANOTHER I_T NEXUS
2A 12	ENCRYPTION - DATA ENCRYPTION PARAMETERS CHANGED BY VENDOR SPECIFIC EVENT
2A 14	SA CREATION CAPABILITIES DATA HAS CHANGED
2F 00	COMMANDS CLEARED BY ANOTHER INITIATOR
3B 12	MEDIUM MAGAZINE REMOVED
3B 13	MEDIUM MAGAZINE INSERTED
3F 01	MICROCODE HAS BEEN CHANGED
3F 02	CHANGED OPERATING DEFINITION
3F 03	INQUIRY DATA HAS CHANGED
3F 05	DEVICE IDENTIFIER CHANGED
3F 0E	REPORTED LUNS DATA HAS CHANGED
5D FF	FAILURE PREDICTION THRESHOLD EXCEEDED (FALSE)
EE 11	ENCRYPTION - KEY GENERATION
EE 12	ENCRYPTION - KEY CHANGE DETECTED
EE 13	ENCRYPTION - KEY TRANSLATION
EE 18	ENCRYPTION - CHANGED (READ)
EE 19	ENCRYPTION - CHANGED (WRITE)
EE 40	ENCRYPTION - EKM IDENTIFIER CHANGED
EE 41	ENCRYPTION - EKM CHALLENGE CHANGED
EE 50	ENCRYPTION - INITIATOR IDENTIFIER CHANGED
EE 51	ENCRYPTION - INITIATOR RESPONSE CHANGED
EF 01	ENCRYPTION - KEY SERVICE NOT CONFIGURED
<p>Note - ASCs of EEh and EFh are used for encryption related features and are only supported by encryption capable devices</p> <p>Note - When using encryption enabled devices in an in-band configuration (System method or key path), ASCs of EFh are used to initiate a key management session via a system proxy.</p>	

**Table 420 — ASC, and ASCQ Summary for Sense Key 6 (Unit Attention) (part 2 of 2)**

ASC ASCQ	Description
EF 10	ENCRYPTION - KEY REQUIRED
EF 11	ENCRYPTION - KEY GENERATION
EF 13	ENCRYPTION - KEY TRANSLATION
EF 1A	ENCRYPTION - KEY OPTIONAL (i.e., chose encryption enabled/disabled)
Note - ASCs of EEh and EFh are used for encryption related features and are only supported by encryption capable devices	
Note - When using encryption enabled devices in an in-band configuration (System method or key path), ASCs of EFh are used to initiate a key management session via a system proxy.	

## B.8. Sense Key 7 (Data Protect)

Table 421 — ASC, and ASCQ Summary for Sense Key 7 (Data Protect)

ASC ASCQ	Description
26 10	ENCRYPTION - DATA DECRYPTION KEY FAIL LIMIT
27 00	WRITE PROTECTED
2A 13	ENCRYPTION - DATA ENCRYPTION KEY INSTANCE COUNTER HAS CHANGED
30 05	CANNOT WRITE MEDIUM, INCOMPATIBLE FORMAT: Check to see if the cartridge is an uninitialized read-only generation cartridge
30 06	CANNOT FORMAT MEDIUM - INCOMPATIBLE MEDIUM
30 0C	DATA PROTECT/WORM MEDIUM - OVERWRITE ATTEMPTED: Set when the drive rejects a Write operation because the rules for allowing WORM writes have not been met
30 0D	DATA PROTECT/WORM MEDIUM - INTEGRITY CHECK: Set when the drive rejects a Write operation because the current cartridge is a Suspicious WORM cartridge
50 01	WRITE APPEND POSITION ERROR (WORM)
52 00	CARTRIDGE FAULT
5A 02	OPERATOR SELECTED WRITE PROTECT
74 00	SECURITY ERROR
74 01	ENCRYPTION - UNABLE TO DECRYPT DATA
74 02	ENCRYPTION - UNENCRYPTED DATA ENCOUNTERED WHILE DECRYPTING
74 03	ENCRYPTION - INCORRECT DATA ENCRYPTION KEY
74 04	ENCRYPTION - CRYPTOGRAPHIC INTEGRITY VALIDATION FAILED
74 05	ENCRYPTION - ERROR DECRYPTING DATA
74 06	UNKNOWN SIGNATURE VERIFICATION KEY
74 07	ENCRYPTION PARAMETERS NOT USEABLE
74 09	ENCRYPTION MODE MISMATCH ON READ
74 0A	ENCRYPTED BLOCK NOT RAW READ ENABLED
74 0B	INCORRECT ENCRYPTION PARAMETERS
74 6F	EXTERNAL DATA ENCRYPTION CONTROL ERROR
EE 0E	ENCRYPTION - KEY SERVICE TIME-OUT <sup>a</sup>
EE 0F	ENCRYPTION - KEY SERVICE FAILURE <sup>a</sup>
EF 10	ENCRYPTION - KEY REQUIRED
EF 11	ENCRYPTION - KEY GENERATION
EF 13	ENCRYPTION - KEY TRANSLATE
EF 1A	ENCRYPTION - KEY OPTIONAL
EF A0	ENCRYPTION - KEY REQUIRED (T10)
EF A1	ENCRYPTION - KEY GENERATION (T10)
EF C0	ENCRYPTION - NO OPERATION
<p>Note - ASCs of EEh and EFh are used for encryption related features and are only supported by encryption capable devices</p> <p>Note - When using encryption enabled devices in an in-band configuration (System method or key path), ASCs of EFh are used to initiate a key management session via a system proxy.</p> <p><sup>a</sup> Returned in LTO6 and later</p>	

**B.9. Sense Key 8 (Blank Check)****Table 422 — ASC, and ASCQ Summary for Sense Key 8 (Blank Check)**

ASC ASCQ	Description
00 05	END-OF-DATA DETECTED

**B.10. Sense Key B (Aborted Command)****Table 423 — ASC, and ASCQ Summary for Sense Key B (Aborted Command)**

ASC ASCQ	Description
00 1E	CONFLICTING SA CREATION REQUEST
0B 01	WARNING - SPECIFIED TEMPERATURE EXCEEDED
11 0A	MISCORRECTED ERROR
2C 00	COMMAND SEQUENCE ERROR
3D 00	INVALID BITS IN IDENTIFY MESSAGE
3F 0F	ECHO BUFFER OVERWRITTEN
43 00	MESSAGE ERROR
45 00	SELECT OR RESELECT FAILURE
47 00	SCSI PARITY ERROR
47 03	INFORMATION UNIT iuCRC ERROR DETECTED
48 00	INITIATOR DETECTED ERROR MESSAGE RECEIVED
49 00	INVALID MESSAGE ERROR
4A 00	COMMAND PHASE ERROR
4B 00	DATA PHASE ERROR
4B 02	TOO MUCH WRITE DATA
4B 03	ACK/NAK TIMEOUT
4B 04	NAK RECEIVED
4B 05	DATA OFFSET ERROR
4B 06	INITIATOR RESPONSE TIMEOUT
4E 00	OVERLAPPED COMMANDS ATTEMPTED
74 40	AUTHENTICATION FAILED

**B.11. Sense Key D (Volume Overflow)****Table 424 — ASC, and ASCQ Summary for Sense Key D (Volume Overflow)**

ASC ASCQ	Description
00 02	END-OF-PARTITION/MEDIUM DETECTED

## Annex C. Firmware Download

This annex describes how to compare a firmware level binary to information returned by a drive and determine which firmware is acceptable in which drive.

### C.1. Identifying Level Hardware of Drive

The firmware that is loaded in the drive will report a LOAD ID and RU NAME in INQUIRY IP 03h: Firmware Designation (see 6.3.2 on page 228). The LOAD ID and RU NAME are used to designate the Level Hardware (i.e., Product). The following table defines the LOAD ID and RU NAME values for each Level Hardware.

**Table 425 — Load ID and RU Name Designation for LTO2**

Product (Level Hardware)	LOAD ID	RU NAME "EBCDIC" Hex	Product ID (Left-Aligned)		
			IBM	OEM	eServer
U160	A1700299	"AJEFGP99" 0xC1D1C5C6C7D7F9F9	ULT3580-TD2	ULTRIUM-TD2	-
FC2G	A170029A	"AJEFGP9A" 0xC1D1C5C6C7D7F9C1			
U160 RoHS	A1700D67	"AJEFAX67" 0xC1D1C5C6C1E7F6F7			
FC2G RoHS	A1700D68	"AJEFAX68" 0xC1D1C5C6C1E7F6F8			
- Not Applicable HH - Half-High U - Ultra					

**Table 426 — Load ID and RU Name Designation for LTO3 (part 1 of 2)**

Product (Level Hardware)	LOAD ID	RU Name "EBCDIC" Hex	Product ID (Left-Aligned)		
			IBM	OEM	eServer
U160	A1700D50	"AJEFAX50" 0xC1D1C5C6C1E7F5F0	ULT3580-TD3	ULTRIUM-TD3	-
U160 RoHS <sup>a</sup>					
FC2G	A1700D52	"AJEFAX52" 0xC1D1C5C6C1E7F5F2			
FC4G RoHS <sup>a</sup>					
- Not Applicable HH - Half-High U - Ultra <sup>a</sup> Minimum level of firmware is 5BG2					

Table 426 — Load ID and RU Name Designation for LTO3 (part 2 of 2)

Product (Level Hardware)	LOAD ID	RU Name "EBCDIC" Hex	Product ID (Left-Aligned)		
			IBM	OEM	eServer
HH SAS	A1700D53	"AJEFAX53" 0xC1D1C5C6C1E7F5F3	-	-	HH LTO Gen 3
HH U160	A1700D69	"AJEFAX69" 0xC1D1C5C6C1E7F6F9			
HH SAS	A1700D64	"AJEFAX64" 0xC1D1C5C6C1E7F6F4	ULT3580-HH3	ULTRIUM-HH3	-
HH U160	A1700D63	"AJEFAX63" 0xC1D1C5C6C1E7F6F3			
HH SAS V2	A1700D79	"AJEFAX79" 0xC1D1C5C6C1E7F7F9			
- Not Applicable HH - Half-High U - Ultra <sup>a</sup> Minimum level of firmware is 5BG2					

Table 427 — Load ID and RU Name Designation for LTO4

Product (Level Hardware)	LOAD ID	RU Name "EBCDIC" Hex	Product ID (Left-Aligned)		
			IBM	OEM	eServer
U160	A1700D6A	"AJEFAX6A" 0xC1D1C5C6C1E7F6C1	ULT3580-TD4	ULTRIUM-TD4	-
FC4G	A1700D6B	"AJEFAX6B" 0xC1D1C5C6C1E7F6C2			
SAS	A1700D6C	"AJEFAX6C" 0xC1D1C5C6C1E7F6C3			
U320	A1700D70	"AJEFAX70" 0xC1D1C5C6C1E7F7F0			
HH SAS	A1700D71	"AJEFAX71" 0xC1D1C5C6C1E7F7F1	ULT3580-HH4	ULTRIUM-HH4	HH LTO Gen 4
HH U320	A1700D51	"AJEFAX51" 0xC1D1C5C6C1E7F5F1			
HH FC	A1700D66	"AJEFAX66" 0xC1D1C5C6C1E7F6F6			
HH FC V2	A1700D7B	"AJEFAX7B" 0xC1D1C5C6C1E7F7C2			
HH SAS V2	A1700D7A	"AJEFAX7A" 0xC1D1C5C6C1E7F7C1			
- Not Applicable HH - Half-High U - Ultra					

Table 428 — Load ID and RU Name Designation for LTO5

Product (Level Hardware)	LOAD ID	RU Name "EBCDIC" Hex	Product ID (Left-Aligned)		
			IBM	OEM	eServer
FC8G	A1700D74	"AJEFAX74" 0xC1D1C5C6C1E7F7F4	ULT3580-TD5	ULTRIUM-TD5	-
SAS	A1700D75	"AJEFAX75" 0xC1D1C5C6C1E7F7F5			
HH FC	A1700D76	"AJEFAX76" 0xC1D1C5C6C1E7F7F6	ULT3580-HH5	ULTRIUM-HH5	HH LTO Gen 5
HH FC V2					
HH SAS	A1700D77	"AJEFAX77" 0xC1D1C5C6C1E7F7F7			
HH SAS V2					
- Not Applicable HH - Half-High					

Table 429 — Load ID and RU Name Designation for LTO6

Product (Level Hardware)	LOAD ID	RU Name "EBCDIC" Hex	Product ID (Left-Aligned)		
			IBM	OEM	eServer
FC8G	A1700D81	"AJEFAX81" 0xC1D1C5C6C1E7F8F1	ULT3580-TD6	ULTRIUM-TD6	-
SAS	A1700D82	"AJEFAX82" 0xC1D1C5C6C1E7F8F2			
HH FC	A1700D83	"AJEFAX83" 0xC1D1C5C6C1E7F8F3	ULT3580-HH6	ULTRIUM-HH6	HH LTO Gen 6
HH SAS	A1700D84	"AJEFAX84" 0xC1D1C5C6C1E7F8F4			
- Not Applicable HH - Half-High					

Table 430 — Load ID and RU Name Designation for LTO7

Product (Level Hardware)	LOAD ID	RU Name "EBCDIC" Hex	Product ID (Left-Aligned)		
			IBM	OEM	eServer
FC8G	A1700D87	"AJEFAX87" 0xC1D1C5C6C1E7F8F7	ULT3580-TD7	ULTRIUM-TD7	-
SAS	A1700D88	"AJEFAX88" 0xC1D1C5C6C1E7F8F8			
HH FC	A1700D89	"AJEFAX89" 0xC1D1C5C6C1E7F8F9	ULT3580-HH7	ULTRIUM-HH7	HH LTO Gen 7
HH SAS	A1700D8A	"AJEFAX8A" 0xC1D1C5C6C1E7F8C1			
- Not Applicable HH - Half-High					

Table 431 — Load ID and RU Name Designation for LTO8

Product (Level Hardware)	LOAD ID	RU Name "EBCDIC" Hex	Product ID (Left-Aligned)		
			IBM	OEM	eServer
FC8G	A1700D8B	"AJEFAX8B" 0xC1D1C5C6C1E7F8C2	ULT3580-TD8	ULTRIUM-TD8	-
HH FC	A1700D8C	"AJEFAX8C" 0xC1D1C5C6C1E7F8C3	ULT3580-HH8	ULTRIUM-HH8	HH LTO Gen 8
HH SAS	A1700D8D	"AJEFAX8D" 0xC1D1C5C6C1E7F8C4			
- Not Applicable HH - Half-High					

Table 432 — Load ID and RU Name Designation for LTO9

Product (Level Hardware)	LOAD ID	RU Name "EBCDIC" Hex	Product ID (Left-Aligned)	
			IBM	OEM
FH FC8G	A1800300	"AJEFH700" 0xC1D1C5C6C8F7F0F0	ULT3580-TD9	ULTRIUM-TD9
FH SAS 12Gb	A1800301	"AJEFH701" 0xC1D1C5C6C8F7F0F1		
HH FC8G	A1800302	"AJEFH702" 0xC1D1C5C6C8F7F0F2	ULT3580-HH9	ULTRIUM-HH9
HH SAS 12Gb	A1800303	"AJEFH703" 0xC1D1C5C6C8F7F0F3		
- Not Applicable FH - Full-High HH - Half-High				



## C.2. Identifying the product for which the firmware image is intended

The Firmware Image is defined in table 433.

**Table 433 — Firmware Image**

Byte	Bit							
	7 msb	6	5	4	3	2	1	0 osb
0	Not Specified							
3	Not Specified							
4	(MSB)	FIRMWARE LENGTH + HEADER LENGTH (m+1)						(LSB)
7								
8	(MSB)	LOAD ID						(LSB)
11	(See "IP 03h: Firmware Designation" on page 228.)							
12	(MSB)	FIRMWARE REVISION LEVEL						(LSB)
15	(See Standard Inquiry Data bytes 32 - 35)							
16	Reserved							
23								
24	(MSB)	RU NAME						(LSB)
31	(See "IP 03h: Firmware Designation" on page 228.)							
32	Not Specified							
m								

The LOAD ID and RU NAME fields in the Firmware Image are used to define the product (i.e., Level Hardware) for which the Firmware Image is intended.

## C.3. Download Process

Confirm the Level Hardware of the Firmware Image (see C.2.) to be loaded matches the Level Hardware of the drive (see C.1.).

Download the Firmware Image using the WRITE BUFFER - 3Bh (see 5.2.44 on page 181) command.



## Annex D. Protection Information CRC's

### D.1. Reed-Solomon CRC

#### D.1.1. Reed-Solomon CRC Algorithm

The Reed Solomon CRC algorithm defined in ECMA-319 is used in this drive:

- a) as a format specific symbol written to tape with each logical block; and
- b) is available for use as protection information associated with each logical block transferred between the drive and a host (see 4.9).

The CRC bytes are Reed-Solomon (N, N-4) codes over GF (256).

A calculation in GF (256) is defined by  $P(x) = x^8 + x^4 + x^3 + x^2 + 1$

$\alpha = (0\ 0\ 0\ 0\ 0\ 0\ 1\ 0)$

$G(x) = x^4 + \alpha^{201}x^3 + \alpha^{246}x^2 + \alpha^{201}x + 1$

#### D.1.2. Sample C program to generate Reed-Solomon CRC

The following is sample C code for generating the Reed-Solomon CRC defined in ECMA-319

```

/*-----
** ABSTRACT: function to compute interim LBP CRC
** INPUTS:   crc   - initial crc (0 for fresh) (i.e., seed)
**           cnt   - the number of data bytes to compute CRC for
**           start - the starting address of the data bytes (e.g., data buffer)
** OUTPUTS:  UINT32 - crc in big endian (MSB is first byte)
*/
UINT32 GenerateRSCRC(UINT32 crc, UINT32 cnt, const void *start)
{
    static const UINT32 crcTable[256]=
    { 0x00000000,0x38CF3801,0x70837002,0x484C4803,0xE01BE004,0xD8D4D805,
      0x90989006,0xA857A807,0xDD36DD08,0xE5F9E509,0xADB5AD0A,0x957A950B,
      0x3D2D3D0C,0x05E2050D,0x4DAE4D0E,0x7561750F,0xA76CA710,0x9FA39F11,
      0xD7EFD712,0xEF20EF13,0x47774714,0x7FB87F15,0x37F43716,0x0F3B0F17,
      0x7A5A7A18,0x42954219,0x0AD90A1A,0x3216321B,0x9A419A1C,0xA28EA21D,
      0xEAC2EA1E,0xD20DD21F,0x53D85320,0x6B176B21,0x235B2322,0x1B941B23,
      0xB3C3B324,0x8B0C8B25,0xC340C326,0xFB8FFB27,0x8EEE8E28,0xB621B629,
      0xFE6DFE2A,0xC6A2C62B,0x6EF56E2C,0x563A562D,0x1E761E2E,0x26B9262F,
      0xF4B4F430,0xCC7BCC31,0x84378432,0xBCF8BC33,0x14AF1434,0x2C602C35,
      0x642C6436,0x5CE35C37,0x29822938,0x114D1139,0x5901593A,0x61CE613B,
      0xC999C93C,0xF156F13D,0xB91AB93E,0x81D5813F,0xA6ADA640,0x9E629E41,
      0xD62ED642,0xEEE1EE43,0x46B64644,0x7E797E45,0x36353646,0x0EFA0E47,
      0x7B9B7B48,0x43544349,0x0B180B4A,0x33D7334B,0x9B809B4C,0xA34FA34D,
      0xEB03EB4E,0xD3CCD34F,0x01C10150,0x390E3951,0x71427152,0x498D4953,
      0xE1DAE154,0xD915D955,0x91599156,0xA996A957,0xDC77DC58,0xE438E459,
      0xAC74AC5A,0x94BB945B,0x3CEC3C5C,0x0423045D,0x4C6F4C5E,0x74A0745F,
      0xF575F560,0xCDBACD61,0x85F68562,0xBD39BD63,0x156E1564,0x2DA12D65,
      0x65ED6566,0x5D225D67,0x28432868,0x108C1069,0x58C0586A,0x600F606B,
      0xC858C86C,0xF097F06D,0xB8DBB86E,0x8014806F,0x52195270,0x6AD66A71,
      0x229A2272,0x1A551A73,0xB202B274,0x8ACD8A75,0xC281C276,0xFA4EFA77,
      0x8F2F8F78,0xB7E0B779,0xFFACFF7A,0xC763C77B,0x6F346F7C,0x57FB577D,
      0x1FB71F7E,0x2778277F,0x51475180,0x69886981,0x21C42182,0x190B1983,
      0xB15CB184,0x89938985,0xC1DFC186,0xF910F987,0x8C718C88,0xB4BEB489,

```

```

0xFCF2FC8A,0xC43DC48B,0x6C6A6C8C,0x54A5548D,0x1CE91C8E,0x2426248F,
0xF62BF690,0xC EE4CE91,0x86A88692,0xBE67BE93,0x16301694,0x2EFF2E95,
0x66B36696,0x5E7C5E97,0x2B1D2B98,0x13D21399,0x5B9E5B9A,0x6351639B,
0xCB06CB9C,0xF3C9F39D,0xBB85BB9E,0x834A839F,0x029F02A0,0x3A503AA1,
0x721C72A2,0x4AD34AA3,0xE284E2A4,0xDA4BDAA5,0x920792A6,0xAAC8AAA7,
0xDFA9DFA8,0xE766E7A9,0xAF2AAFAA,0x97E597AB,0x3FB23FAC,0x077D07AD,
0x4F314FAE,0x77FE77AF,0xA5F3A5B0,0x9D3C9DB1,0xD570D5B2,0xEDBFEDB3,
0x45E845B4,0x7D277DB5,0x356B35B6,0x0DA40DB7,0x78C578B8,0x400A40B9,
0x084608BA,0x308930BB,0x98DE98BC,0xA011A0BD,0xE85DE8BE,0xD092D0BF,
0xF7EAF7C0,0xCF25CFC1,0x876987C2,0xBFA6BFC3,0x17F117C4,0x2F3E2FC5,
0x677267C6,0x5FBD5FC7,0x2ADC2AC8,0x121312C9,0x5A5F5ACA,0x629062CB,
0xCAC7CACC,0xF208F2CD,0xBA44BACE,0x828B82CF,0x508650D0,0x684968D1,
0x200520D2,0x18CA18D3,0xB09DB0D4,0x885288D5,0xC01EC0D6,0xF8D1F8D7,
0x8DB08DD8,0xB57FB5D9,0xFD33FDDA,0xC5FCC5DB,0x6DAB6DDC,0x556455DD,
0x1D281DDE,0x25E725DF,0xA432A4E0,0x9CFD9CE1,0xD4B1D4E2,0xEC7EECE3,
0x442944E4,0x7CE67CE5,0x34AA34E6,0x0C650CE7,0x790479E8,0x41CB41E9,
0x098709EA,0x314831EB,0x991F99EC,0xA1D0A1ED,0xE99CE9EE,0xD153D1EF,
0x035E03F0,0x3B913BF1,0x73DD73F2,0x4B124BF3,0xE345E3F4,0xDB8ADBF5,
0x93C693F6,0xAB09ABF7,0xDE68DEF8,0xE6A7E6F9,0xAE EBAEFA,0x962496FB,
0x3E733EFC,0x06BC06FD,0x4EF04EFE,0x763F76FF};

```

```

    UINT32 i;
const UINT8* d = start;

for ( i=0; i<cnt; i++ )
{
    crc = (crc << 8) ^ crcTable[*d ^ (crc >> 24)];
    d++;
}
return crc;
}

```

### D.1.3. Sample C program to compute and append Reed-Solomon CRC to a data block

```

/*-----
** ABSTRACT: function to compute and append LBP CRC to a data block
** INPUTS:   blkbuf - starting address of the data block to protect
**           blklen - length of block to protect (NOT including CRC)
** OUTPUTS:  UINT32 - length of protected block (to write) including LBP CRC
*/
UINT32 BlockProtectRSCRC(UINT8 *blkbuf, UINT32 blklen)
{
    UINT32 crc = GeneratorRSCRC(0x00000000, blklen, blkbuf);

    if (blklen == 0)
        return 0; //no such thing as a zero length block in SSC (write NOP)

    //append CRC in proper byte order (regardless of system endian-ness)
    blkbuf[blklen+0] = (crc >> 24) & 0xFF;
    blkbuf[blklen+1] = (crc >> 16) & 0xFF;
    blkbuf[blklen+2] = (crc >> 8) & 0xFF;
    blkbuf[blklen+3] = (crc >> 0) & 0xFF;

    return (blklen+4); //size of block to be written includes CRC
}

```

### D.1.4. Sample C program to to verify block with Reed-Solomon CRC

```

/*-----
** ABSTRACT: function to verify block with LBP CRC
** INPUTS:   blkbuf - starting address of the data block to protect
**           blklen - length of block to verify (INCLUDING CRC)
** OUTPUTS:  UINT32 - length of block w/o CRC (0 if verify failed)
*/
UINT32 BlockVerifyRSCRC(const UINT8 *blkbuf, UINT32 blklen)
{
    if (blklen <= 4)
        return 0; //block is too small to be valid, cannot check CRC

    blklen -= 4; //user data portion does not include CRC

#ifdef 1 //method 1: calculate CRC on data only and compare against CRC from block
    {
        UINT32 crccmp = GenerateRSCRC(0x00000000, blklen, blkbuf);
        UINT32 crcblk;

        //this matches the append method in the function above
        crcblk = (blkbuf[blklen+0] << 24) |
                (blkbuf[blklen+1] << 16) |
                (blkbuf[blklen+2] << 8) |
                (blkbuf[blklen+3] << 0);

        if (crccmp != crcblk)
            return 0; //block CRC is incorrect
        return(blklen);
    }
#endif
#ifdef 1 //method 2: calculate including CRC and check magic constant
    {
        if (GenerateRSCRC(0x00000000, blklen+4, blkbuf) != 0x00000000)
            return 0; //block CRC is incorrect (CRC did not neutralize)
        return(blklen);
    }
#endif
}

```

## D.2. CRC32C (Castagnoli)

### D.2.1. CRC32C Algorithm

The CRC32C CRC algorithm is available for use as protection information associated with each logical block transferred between the drive and a host (see 4.9). Some host system architectures may offer higher performance methods to calculate CRCs using this type of polynomial over the Reed-Solomon CRC polynomial.

The algorithm is defined by the equation

$x^{32}+x^{28}+x^{27}+x^{26}+x^{25}+x^{23}+x^{22}+x^{20}+x^{19}+x^{18}+x^{14}+x^{13}+x^{11}+x^{10}+x^9+x^8+x^6+1$  which is sometimes expressed as 0x1EDC6F41.

NOTE 74 - The sample functions for CRC32C in this section use a bit swapped form, which is easier/faster for software implementation as it avoids the need to bit swap bytes of input and output.

NOTE 75 - Many other uses of CRC32C (e.g., iSCSI) pad the data to a 32 bit boundary before computing CRC32C. LBP use of CRC32C is byte oriented (as are SSC data blocks), and computes CRC32C on blocks to

the actual byte size of the block and immediately appends the CRC32C without and pad in the calculation or storage of the CRC.

NOTE 76 - Some host hardware implementations may have standard form polynomial instruction(s) that can be used for high performance computation of CRC32C or other standard form polynomials (the Reed-Solomon CRC is not such an algorithm). These instructions may have particular input data alignment requirements (e.g., 32 or 64 bit). Since LBP has no padding and is byte (8 bit) aligned, special operations (e.g., a mix of hardware and software methods) may be required to properly calculate non-aligned block sizes. Additionally hardware implementations may use the normal form rather than the swapped form shown in the code examples in this section. This can affect the method for storage and compare (magic constant). In any event, take care to ensure the CRC is stored and checked properly in all cases. Some CRC32C test vectors can be found in the iSCSI RFC 3720 (B.4). Further information (e.g., hardware implementation(s)) may be found in RFC 3385 or from other sources.

### D.2.2. Sample C program to generate CRC32C (Castagnoli)

```

/*-----
** ABSTRACT: function to compute interim LBP CRC (bit-swapped method)
** INPUTS:   crc   - initial crc (0xFFFFFFFF for fresh)
**           cnt   - the number of data bytes to compute CRC for
**           start - the starting address of the data bytes
** OUTPUTS:  UINT32 - [inverted] crc in big endian (LSB is first byte)
*/
UINT32 GenerateCRC32C(UINT32 crc, UINT32 cnt, const void *start)
{
    static const UINT32 crcTable[256]=
    { 0x00000000,0xF26B8303,0xE13B70F7,0x1350F3F4,0xC79A971F,0x35F1141C,
      0x26A1E7E8,0xD4CA64EB,0x8AD958CF,0x78B2DBCC,0x6BE22838,0x9989AB3B,
      0x4D43CFD0,0xBF284CD3,0xAC78BF27,0x5E133C24,0x105EC76F,0xE235446C,
      0xF165B798,0x030E349B,0xD7C45070,0x25AFD373,0x36FF2087,0xC494A384,
      0x9A879FA0,0x68EC1CA3,0x7BBCEF57,0x89D76C54,0x5D1D08BF,0xAF768BBC,
      0xBC267848,0x4E4DFB4B,0x20BD8EDE,0xD2D60DDD,0xC186FE29,0x33ED7D2A,
      0xE72719C1,0x154C9AC2,0x061C6936,0xF477EA35,0xAA64D611,0x580F5512,
      0x4B5FA6E6,0xB93425E5,0x6DFFE410E,0x9F95C20D,0x8CC531F9,0x7EAE2FA,
      0x30E349B1,0xC288CAB2,0xD1D83946,0x23B3BA45,0xF779DEAE,0x05125DAD,
      0x1642AE59,0xE4292D5A,0xBA3A117E,0x4851927D,0x5B016189,0xA96AE28A,
      0x7DA08661,0x8FCB0562,0x9C9BF696,0x6EF07595,0x417B1DBC,0xB3109EBF,
      0xA0406D4B,0x522BEE48,0x86E18AA3,0x748A09A0,0x67DAFA54,0x95B17957,
      0xCBA24573,0x39C9C670,0x2A993584,0xD8F2B687,0x0C38D26C,0xFE53516F,
      0xED03A29B,0x1F682198,0x5125DAD3,0xA34E59D0,0xB01EAA24,0x42752927,
      0x96BF4DCC,0x64D4CECF,0x77843D3B,0x85EFBE38,0xDBFC821C,0x2997011F,
      0x3AC7F2EB,0xC8AC71E8,0x1C661503,0xEE0D9600,0xFD5D65F4,0x0F36E6F7,
      0x61C69362,0x93AD1061,0x80FDE395,0x72966096,0xA65C047D,0x5437877E,
      0x4767748A,0xB50CF789,0xEB1FCBAD,0x197448AE,0x0A24BB5A,0xF84F3859,
      0x2C855CB2,0xDEEDDFB1,0xCDBE2C45,0x3FD5AF46,0x7198540D,0x83F3D70E,
      0x90A324FA,0x62C8A7F9,0xB602C312,0x44694011,0x5739B3E5,0xA55230E6,
      0xFB410CC2,0x092A8FC1,0x1A7A7C35,0xE811FF36,0x3CDB9BDD,0xCEB018DE,
      0xDDE0EB2A,0x2F8B6829,0x82F63B78,0x709DB87B,0x63CD4B8F,0x91A6C88C,
      0x456CAC67,0xB7072F64,0xA457DC90,0x563C5F93,0x082F63B7,0xFA44E0B4,
      0xE9141340,0x1B7F9043,0xCFB5F4A8,0x3DDE77AB,0x2E8E845F,0xDCE5075C,
      0x92A8FC17,0x60C37F14,0x73938CE0,0x81F80FE3,0x55326B08,0xA759E80B,
      0xB4091BFF,0x466298FC,0x1871A4D8,0xEA1A27DB,0xF94AD42F,0x0B21572C,
      0xDFEB33C7,0x2D80B0C4,0x3ED04330,0xCCBBC033,0xA24BB5A6,0x502036A5,
      0x4370C551,0xB11B4652,0x65D122B9,0x97BAA1BA,0x84EA524E,0x7681D14D,
      0x2892ED69,0xD9F96E6A,0xC9A99D9E,0x3BC21E9D,0xEF087A76,0x1D63F975,
      0x0E330A81,0xFC588982,0xB21572C9,0x407EF1CA,0x532E023E,0xA145813D,
      0x758FE5D6,0x87E466D5,0x94B49521,0x66DF1622,0x38CC2A06,0xCAA7A905,
      0xD9F75AF1,0x2B9CD9F2,0xFF56BD19,0x0D3D3E1A,0x1E6DCDEE,0xEC064EED,
      0xC38D26C4,0x31E6A5C7,0x22B65633,0xD0DDD530,0x0417B1DB,0xF67C32D8,
      0xE52CC12C,0x1747422F,0x49547E0B,0xBB3FFD08,0xA86F0EFC,0x5A048DFE,
      0x8ECE914,0x7CA56A17,0x6FF599E3,0x9D9E1AE0,0xD3D3E1AB,0x21B862A8,
      0x32E8915C,0xC083125F,0x144976B4,0xE622F5B7,0xF5720643,0x07198540,

```

```

0x590AB964,0xAB613A67,0xB831C993,0x4A5A4A90,0x9E902E7B,0x6CFBAD78,
0x7FAB5E8C,0x8DC0DD8F,0xE330A81A,0x115B2B19,0x020BD8ED,0xF0605BEE,
0x24AA3F05,0xD6C1BC06,0xC5914FF2,0x37FACCF1,0x69E9F0D5,0x9B8273D6,
0x88D28022,0x7AB90321,0xAE7367CA,0x5C18E4C9,0x4F48173D,0xBD23943E,
0xF36E6F75,0x0105EC76,0x12551F82,0xE03E9C81,0x34F4F86A,0xC69F7B69,
0xD5CF889D,0x27A40B9E,0x79B737BA,0x8BDCB4B9,0x988C474D,0x6AE7C44E,
0xBE2DA0A5,0x4C4623A6,0x5F16D052,0xAD7D5351 };

    UINT32 i;
const UINT8* d = start;

for ( i=0; i<cnt; i++ )
{
    crc = (crc >> 8) ^ crcTable[*d ^ (crc & 0xFF)];
    d++;
}
return crc;
}

```

### D.2.3. Sample C code to compute and append CRC32C to a data block

```

/*-----
** ABSTRACT: function to compute and append LBP CRC to a data block
** INPUTS:   blkbuf - starting address of the data block to protect
**           blklen - length of block to protect (NOT including CRC)
** OUTPUTS:  UINT32 - length of protected block (to write) including LBP CRC
*/
UINT32 BlockProtectCRC32C(UINT8 *blkbuf, UINT32 blklen)
{
    UINT32 crc = ~GenerateCRC32C(0xFFFFFFFF, blklen, blkbuf); //note bit inversion

    if (blklen == 0)
        return 0; //no such thing as a zero length block in SSC (write NOP)

    //append CRC in proper byte order (regardless of system endian-ness)
    blkbuf[blklen+0] = (crc >> 0) & 0xFF;
    blkbuf[blklen+1] = (crc >> 8) & 0xFF;
    blkbuf[blklen+2] = (crc >> 16) & 0xFF;
    blkbuf[blklen+3] = (crc >> 24) & 0xFF;

    return (blklen+4); //size of block to be written includes CRC
}

```

### D.2.4. Sample C code to verify block with CRC32C CRC

```

/*-----
** ABSTRACT: function to verify block with LBP CRC
** INPUTS:   blkbuf - starting address of the data block to protect
**           blklen - length of block to verify (INCLUDING CRC)
** OUTPUTS:  UINT32 - length of block w/o CRC (0 if verify failed)
*/
UINT32 BlockVerifyCRC32C(const UINT8 *blkbuf, UINT32 blklen)
{
    if (blklen <= 4)
        return 0; //block is too small to be valid, cannot check CRC

    blklen -= 4; //user data portion does not include CRC

    #if 1 //method 1: calculate CRC on data only and compare against CRC from block
    {
        UINT32 crccmp = ~GenerateRSCRC(0xFFFFFFFF, blklen, blkbuf); //note bit inversion
    }

```

```

UINT32 crcblk;

//this matches the append method in the function above
crcblk = (blkbuf[blklen+0] << 0) |
         (blkbuf[blklen+1] << 8) |
         (blkbuf[blklen+2] << 16) |
         (blkbuf[blklen+3] << 24);

if (crccmp != crcblk)
    return 0; //block CRC is incorrect
return(blklen);
}
#endif
#if 1 //method 2: calculate including CRC and check magic constant
{
    //NOTE: bit swapped magic constant is also bit+byte swapped
    //      0x1C2D19ED //"nominal" result including [inverted] CRC
    //      0xB798B438 //"swapped" result including [inverted] CRC
    //NOTE: magic constant check below does NOT need bit inversion
    if (GenerateCRC32C(0xFFFFFFFF, blklen+4, blkbuf) != 0xB798B438)
        return 0; //block CRC is incorrect (CRC did not neutralize)
    return(blklen);
}
#endif
}

```

## D.3. CRC32-IEEE

### D.3.1. CRC32-IEEE Algorithm

The CRC32-IEEE algorithm is not used for logical block protection but is used only in the transport layer (i.e., Fibre Channel CRC). This algorithm is defined by the equation  $x^{32}+x^{26}+x^{23}+x^{22}+x^{16}+x^{12}+x^{11}+x^{10}+x^8+x^7+x^5+x^4+x^2+x+1$  which is sometimes expressed as 0x04C11DB7.



## Annex E. Best Practices

### E.1. Overview

This Annex provides recommendations for best practices when using IBM Tape drives.

### E.2. Handling of Type M cartridges

Since LTO-2, the LTO industry has had one type of cartridge per generation. The cartridges are called Type A cartridges (see 2.1.254). LTO-8 introduced an alternate cartridge called a Type M cartridge (see 2.1.255). A Type M cartridge, called M8, is allowed to be created from an Ultrium 7 DATA cartridge (i.e., L7) that is new and has not been used yet. Once a cartridge is changed to an M8, it remains an M8. This creation happens on the first write. Whether an M8 cartridge gets created from a new L7 cartridge depends on how the drive is configured, usually by a library or support tool. Because of this, an application does not have a definitive way to know a priori if a new L7 cartridge that is mounted into an LTO-8 drive will remain an L7 cartridge or will be changed to an M8 cartridge. When an L7 cartridge is mounted into an LTO-8 drive, the REPORT DENSITY SUPPORT command (see 5.2.26) with the MEDIA bit set to 1b shows the default density the drive is configured to write to the cartridge. However, the best practice for determining definitively whether a new cartridge becomes an L7 or an M8, during the ingest and mounting of a new L7 cartridge, is to follow this ordered sequence:

- 1) mount the cartridge;
- 2) perform either:
  - A) a FORMAT MEDIUM command; or
  - B) a short erase (i.e., ERASE with LONG = 0b);
- 3) perform a REPORT DENSITY SUPPORT command with the MEDIA bit set to 1b and examine the density code; and
- 4) update the cartridge type in the application.

### E.3. LTO-9 Cartridge Initialization

#### E.3.1. LTO-9 cartridge initialization overview

The cartridge initialization in LTO-9 performed on L9 and LZ media, also performs a media optimization. See Media Optimization (LTO9+) (see 4.1 on page 25) for a description.

#### E.3.2. Usage recommendations

##### a) Timing

It is important to consider when media optimization should be performed.

As a best practice, the recommendation is to allow the drive to automatically perform media optimization in the location in which it is to be deployed. This first load should be in a stable environment that meets the recommended environmental specification.

Media optimization averages 40 minutes per first load of a cartridge to a tape drive. Although most optimizations will complete within 60 minutes some optimizations may take up to 2 hours. Interruption of the process is not recommended; a different mount will not usually improve the time to complete the 1-time optimization.

##### b) Software Application Information

As a best practice, the following items are recommendations for software applications:

- A) Update SCSI command timeout values by utilizing command timeout descriptors in the REPORT SUPPORTED OPERATION CODES - A3h[0Ch] (see 5.2.28 on page 143) command. This value is valid for both a blocking LOAD command on first load and as the time to continue polling for completion of any load of the cartridge during media optimization.
  - B) While waiting for device readiness (e.g., completion of an asynchronous load (e.g. MOVE MEDIUM, manual insertion)) use TUR polling for the duration of the load.
  - C) If a clean juncture is desired to allow access to MAM prior to beginning the optimization, then load the cartridge using:
    - 1) a LOAD command with HOLD=1 (LOAD=1 (ignored)) IMMED=0;
    - 2) perform needed operations; then
    - 3) issue LOAD command with HOLD=0 LOAD=1 IMMED=1.
  - D) When issuing SCSI LOAD command, use the IMMED bit set to one and poll with TUR for command completion.
  - E) While media optimization is in process, the DT DEVICE ACTIVITY field of VHF data described in LP 11h: DT Device Status (see 6.4.10 on page 269) indicates "CALIBRATING".
  - F) When issuing the FORMAT MEDIUM - 04h (see 5.2.3 on page 80) command with FORMAT Field = 0 or 2, use the IMMED bit set to one and poll unsolicited sense for command completion.
  - G) There are no new failure conditions attributed to media optimization. There is no new additional sense code (i.e., ASC/ASCQ) specific to media optimization.
- c) Drive Status Indicator

During the media optimization operation, the drive provides external indication via the Single Character Display (SCD). The SCD displays 'c' (a lower case c) and the green LED is blinking at a 1 Hz interval.

### E.3.3. SCSI command additions / updates

- a) UPDATE to FORMAT MEDIUM - 04h (see 5.2.3 on page 80) command

In certain instances, the FORMAT MEDIUM command also performs media optimization. Use of the FORMAT MEDIUM command for partitioning using FORMAT Field = 1 does not perform media optimization.

- b) UPDATE to REPORT SUPPORTED OPERATION CODES - A3h[0Ch] (see 5.2.28 on page 143)

As part of the RSOC timeout values, due to additional time required for cartridge initialization, information for LOAD timeout has been updated. This time may be used to know how long to allow polling before calling out an error, as well as for a blocking LOAD command and a blocking FORMAT MEDIUM command.

- c) NEW MAM Attributes

MEDIUM OPTIMIZATION VERSION and MEDIUM OPTIMIZATION NEEDED are added to the Vendor-Specific Medium Type Attributes (see 6.5.2.5 on page 357) MAM attributes.

The current state of whether characterization occurs on the next cartridge LOAD, is given by the MEDIUM OPTIMIZATION NEEDED (ATTRIBUTE IDENTIFIER 1010h) MAM attribute:

"Upon successful completion of a cartridge optimization, the attribute is set automatically by the drive to FALSE(0). This indicates that optimization does not occur on the next load.

"To indicate optimization is needed on the next load, the attribute is set to TRUE(1). This can be set to TRUE(1) using the WRITE ATTRIBUTE command when the tape is empty. After setting the attribute, the cartridge must be unloaded prior to usage.

## Annex F. Notices

### F.1. Trademarks

The following terms are trademarks of International Business Machines Corporation in the United States or other countries (or regions) or both:

AIX®	OS/400®	i5/OS
AS/400®	pSeries®	RAA
eServer™	SP	zSeries
IBM®	RS/6000®	NetBackup (NBU)
iSeries®	TotalStorage®	

The following are U. S. trademarks of Hewlett-Packard Company, International Business Machines Corporation, and Seagate Technology:

Linear Tape-Open  
LTO  
Ultrium

Intel® and Itanium are registered trademarks of Intel Corporation in the United States, or other countries (or regions), or both.

Linux is a register trademark of Linus Torvalds.

NetBackup is a trademark of Symantec

Microsoft®, Windows®, Windows NT®, and the Windows logo are registered trademarks of Microsoft Corporation in the United States, or other countries (or regions), or both.

Other company, product, and service names may be trademarks or service marks of others.



**Index Of Counters** (log parameters not in counter format are not included)

	Page
"DEAD DRIVE" Flag {3Ch:000Dh} .....	344
"DEAD MEDIA" Flag {3Ch:000Ch} .....	344
"WORN MEDIA" Flag {3Ch:000Bh} .....	343
Abort Count [by port] {37h:0Fp8h} .....	334
Abort Time [by port] {37h:0Fp9h} .....	334
Accumulated transitions to active .....	314
Accumulated transitions to idle_c .....	314
Active Capacity Efficiency {37h:7?00h} .....	337
Active CQs Loss (on-the-fly) {37h:7?13h} .....	337
Active Distance CQs (on-the-fly) {37h:7?23h} .....	337
Active Distance DSS {37h:7?22h} .....	337
Active Distance Skip {37h:7?21h} .....	337
Active Distance Total {37h:7?2Fh} .....	337
Active DSS Loss {37h:7?12h} .....	337
Active Initiator Count {37h:0E00h} .....	333
Active Skip Loss {37h:7?11h} .....	337
Active Sync Loss {37h:7?10h} .....	337
Activity duty cycle {14h:0013h} .....	292
Additional Component Temperatures {0Dh[01h]:00001h to 00FFh} .....	266
Approximate native capacity between BOP and EW of the current partition {0Ch:0005h} .....	265
Approximate native capacity from BOP to EOD {0Ch:0004h} .....	265
Approximate native capacity from BOP to the current position of the medium {0Ch:0007h} .....	265
Approximate native capacity of partition(s) {17h:0202h} .....	306
Approximate remaining native capacity to early warning of partition(s) {17h:0204h} .....	306
Approximate used native capacity of partition(s) {17h:0203h} .....	306
Average Command Latency {37h:0DF0h} .....	333
Average Comp Buffer Rate {37h:2?92h} .....	336
Average Comp Sync Length {37h:2?9Ch} .....	336
Average Comp Transfer Length {37h:2?98h} .....	336
Average Comp Transfer Rate {37h:2?91h} .....	336
Average Dequeue Latency {37h:0DF1h} .....	333
Average Host Buffer Rate {37h:2?82h} .....	336
Average Host Sync Length {37h:2?8Ch} .....	336
Average Host Transfer Length {37h:2?88h} .....	336
Average Host Transfer Rate {37h:2?81h} .....	336
Average Tape Buffer Rate {37h:2?A1h} .....	336
Band Change Count {37h:2?11h} .....	335
Beginning of medium passes {17h:0101h} .....	305
Bytes read from medium {1Bh:0005h} .....	315
Bytes read from tape {32h:0005h} .....	322
Bytes transferred from application client {1Bh:0007h} .....	315
Bytes transferred from server {32h:0007h} .....	322
Bytes transferred to application client {1Bh:0003j} .....	315
Bytes transferred to server {32h:0003h} .....	322
Bytes written to medium {1Bh:0009h} .....	316
Bytes written to tape {32h:0009h} .....	322
Cartridge Serial Number {3Ch:0015h} .....	344
Clean Lifetime Mounts {3Dh:0060h} .....	345
Clean Requested Flag {3Ch:0011h} .....	344
Cleaning Requested {0Ch:0100h}: .....	265
Command Count {37h:0Cp0h} .....	332
Command Queue Count {37h:0CpCh} .....	332
Command Queue Latency {37h:0CpDh} .....	333
Command Queue Relative Time {37h:0CpEh} .....	333
Command Relative Time {37h:0Cp2h} .....	332

Command Timing {37h:0Cp1h}	332
Command Transfer Byte Count from Host (out) {37h:0Cp9h}	332
Command Transfer Byte Count to Host (in) {37h:0Cp5h}	332
Command Transfer Count from Host (out) {37h:0Cp8h}	332
Command Transfer Count to Host (in) {37h:0Cp4h}	332
Command Transfer Timing from Host (out) {37h:0CpAh}	332
Command Transfer Timing to Host (in) {37h:0Cp6h}	332
Comp Buffer Efficiency {37h:2?94h}	336
Compressed Data (Medium) {37h:2?71h}	335
Compressed Data {37h:2?61h}	335
Compression Ratio {37h:2?6Ch}	335
Count {37h:0q00h}	330
Cumulative Cartridge Loads Counter {3Ch:0006h}	343
Cumulative Cleaning Counter {3Ch:000Ah}	343
Cumulative Power On Time Counter {3Ch:0008h}	343
Cumulative Time Tape is Loaded and Tensioned {3Ch:0009h}	343
Current Initiator {37h:0E03h}	333
Data Acquisition Temps {33h:0005h}	323
Data Acquisition Temps {34h:0005h}	325
Data compression enabled {1Bh:0100h}	316
Data Temps {33h:0007h}	323
Data Temps {34h:0007h}	325
Data Transients {33h:0002h}	323
Data Transients {34h:0002h}	325
Datarate Performance Impacting ERPs {37h:2?50h}	335
Dataset Overrun {34h:0019h}	326
Dataset Underrun {33h:000Fh}	324
Datasets Corrected {33h:0000h}	323
Datasets Corrected {34h:0000h}	325
Datasets Processed {37h:2?68h}	335
Deck Relative Humidity {0Dh[01h]:0100h}	266
Deck Temperature {0Dh[01h]:0000h}	266
Degate Data {37h:2?63h}	335
Device Read Datasets Processed {38h:0006h}	339
Device Read Datasets Transferred {38h:000Ah}	339
Device Read Kibibytes Processed {38h:0007h}	339
Device Read Kibibytes Transferred {38h:000Bh}	339
Device Write Datasets Processed {38h:0004h}	339
Device Write Datasets Transferred {38h:0008h}	339
Device Write Kibibytes Processed {38h:0005h}	339
Device Write Kibibytes Transferred {38h:0009h}	339
Drive Efficiency {37h:0000h}	329
Drive Lifetime Load Perms {3Dh:0092h}	346
Drive Lifetime Load Temps {3Dh:00A2h}	346
Drive Lifetime Megabytes Read {3Dh:0042h}	345
Drive Lifetime Megabytes Written {3Dh:0041h}	345
Drive Lifetime Mounts {3Dh:0040h}	345
Drive Lifetime Read Perms {3Dh:0091h}	346
Drive Lifetime Read Temps {3Dh:00A1h}	346
Drive Lifetime Unload Perms {3Dh:0093h}	346
Drive Lifetime Unload Temps {3Dh:00A3h}	346
Drive Lifetime Write Perms {3Dh:0090h}	346
Drive Lifetime Write Temps {3Dh:00A0h}	346
Drive manufacturer's serial number {14h:0040h}	293
Drive serial number {14h:0041h}	293
Drive Status Data {11h:8100h}	271
DT device ADC data encryption control status	270

DT device primary port physical interface information	271
DT device primary port status {11h:0101h+}:	270
Duty cycle sample time {14h:0010h}:	292
ECC Corrections Counter {3Ch:0004h}	343
Encryption Control Descriptor {11h:E00h}	271
ERP Servo Adjust Hi {34h:000Ch}	325
ERP Servo Adjust Lo {34h:000Dh}	325
Extended very high frequency data {11h:0004h}	270
FID Events {33h:000Dh}	324
FID Events {34h:001Dh}	326
First encrypted logical object identifier(s) {17h:0200h}	305
First unencrypted logical object on the EOP side of the first encrypted logical object identifier(s) {17h:0201h}	305
Flush Buffer Hits {37h:15F0h}	335
Flush Count (Media) {37h:1580h}	335
Flush Count {37h:1500h}	335
Flush Relative Time (Media) {37h:15A0h}	335
Flush Relative Time {37h:1520h}	335
Flush Time (Media) {37h:1590h}	335
Flush Time {37h:1510h}	335
Fraction of Partition Traversed {38h:000Dh}	339
Fraction of Volume Traversed {38h:000Fh}	340
Hard read errors {14h:000Fh}:	292
Hard write errors {14h:000Eh}:	292
Host Aborts {39h:0007h}	341
Host Buffer Efficiency {37h:2?84h}	336
Host Protocol Errors {39h:000h}	341
Host Read Blocks Processed {38h:0002h}	339
Host Read Kibibytes Processed {38h:0003h}	339
Host Recoveries {39h:0010h}	341
Host Resets {39h:0008h}	341
Host Write Blocks Processed {38h:0000h}	339
Host Write Kibibytes Processed {38h:0001h}	339
Housekeeping Events {33h:000Ch}	323
Housekeeping Events {34h:0017h}	326
Key management error data	270
Last load read compression ratio {17h:0013h}	303
Last load write compression ratio {17h:0012h}	303
Last mount megabytes read {17h:000Fh}	303
Last mount megabytes written {17h:000Eh}	303
Last mount unrecovered read errors {17h:000Dh}	303
Last mount unrecovered write errors {17h:000Ch}	303
Library Interface ACK timeout {3Dh:008A}	346
Library Interface Application Layer timeout {3Dh:008B}	346
Library Interface Buffer Errors {3Dh:0083h}	345
Library Interface Efficiency {37h:001Ah}	329
Library Interface Framing Errors {3Dh:0085h}	346
Library Interface Loader Failures {3Dh:0088h}	346
Library Interface Logical Errors {3Dh:0087h}	346
Library Interface Messages Received {3Dh:0080h}	345
Library Interface Messages Transmitted {3Dh:0081h}	345
Library Interface NAKs received {3Dh:0089h}	346
Library Interface Protocol Errors {3Dh:0086h}	346
Library Interface Resets {3Dh:0082h}	345
Library Interface Sync Errors {3Dh:0084h}	346
Lifetime cleaning cycles {0Ch:8002h}:	266
Lifetime cleaning operations {14h:0001h}:	290
Lifetime load cycles {0Ch:8001h}:	266

Lifetime medium motion (head) hours when incompatible medium was last loaded {14h:0005h}: . . . . .	291
Lifetime medium motion (i.e., head) hours {14h:0003h}: . . . . .	290
Lifetime megabytes read {17h:0011h} . . . . .	303
Lifetime megabytes written {17h:0010h} . . . . .	303
Lifetime meters of tape processed {14h:0004h}: . . . . .	290
Lifetime power cycles {14h:000Ch}: . . . . .	291
Lifetime power on hours {14h:0002h}: . . . . .	290
Lifetime power on hours when the last operator initiated forced reset and/or emergency eject occurred {14h:000Bh}: . .	291
Lifetime power on hours when the last power consumption condition occurred (i.e., TapeAlert code 1Ch) {14h:0007h}: . .	291
Lifetime power on hours when the last temperature condition occurred (i.e., TapeAlert code 24h) {14h:0006h}: . . . . .	291
Lifetime Power On Seconds {3Dh:0100h} . . . . .	346
Lifetime Power-on time {0Ch:8003h}: . . . . .	266
Lifetime volume loads {14h:0000h}: . . . . .	290
Long Queue Latency Count [>1 sec] {37h:0DF8h} . . . . .	333
Long Queue Latency Count [>10 sec] {37h:0DF9h} . . . . .	333
Long Queue Latency Count [>100 sec] {37h:0DFAh} . . . . .	333
Long Queue Latency Count [>1000 sec] {37h:0DFBh} . . . . .	333
Maximum Comp Transfer Rate {37h:2?90h} . . . . .	336
Maximum Host Transfer Rate {37h:2?80h} . . . . .	335
Maximum native capacity that is currently allowed to be in the device object buffer {0Ch:0008h} . . . . .	265
Maximum recommended mechanism temperature exceeded {14h:0081h} . . . . .	293
Maximum recommended tape path temperature exceeded {17h:0082h} . . . . .	305
Maximum Tape Transfer Rate {37h:2?A0h} . . . . .	336
Media Efficiency {37h:0001h} . . . . .	329
Media Erase {37h:2003h} . . . . .	335
Media Idle {37h:2000h} . . . . .	335
Media Phase Cycles {37h:20?1h} . . . . .	335
Media Phase Timing {37h:20?0h} . . . . .	335
Media Position {37h:2004h} . . . . .	335
Media Read {37h:2002h} . . . . .	335
Media Write {37h:2001h} . . . . .	335
Medium Clean Count {37h:0059h} . . . . .	330
Medium Clean Time {37h:0049h} . . . . .	330
Medium Dwell Count {37h:0058h} . . . . .	330
Medium Dwell Time {37h:0048h} . . . . .	330
Medium Eject Count {37h:0056h} . . . . .	330
Medium Eject Time {37h:0046h} . . . . .	329
Medium Empty Count {37h:0051h} . . . . .	330
Medium Empty Time {37h:0041h} . . . . .	329
Medium Extract Count {37h:0057h} . . . . .	330
Medium Extract Time {37h:0047h} . . . . .	329
Medium Insert Count {37h:0052h} . . . . .	330
Medium Insert Time {37h:0042h} . . . . .	329
Medium Load Count {37h:0054h} . . . . .	330
Medium Load Time {37h:0044h} . . . . .	329
Medium motion (i.e., head) hours for each medium type {14h:1000h} . . . . .	293
Medium motion (i.e., head) hours since last successful cleaning operation {14h:0008h}: . . . . .	291
Medium motion (i.e., head) hours since second to last successful cleaning operation {14h:0009h}: . . . . .	291
Medium motion (i.e., head) hours since third to last successful cleaning operation {14h:000Ah}: . . . . .	291
Medium Mount Count {37h:0053h} . . . . .	330
Medium mount time {17h:0014h} . . . . .	303
Medium Mount Time {37h:0043h} . . . . .	329
Medium Ready Count {37h:0055h} . . . . .	330
Medium ready time {17h:0015h} . . . . .	303
Medium Ready Time {37h:0045h} . . . . .	329
Medium removal prevented {14h:0080h} . . . . .	293



Medium Status Data {11h:8001h} . . . . .	271
Medium VolSer {11h:8000h} . . . . .	271
Megabytes read from medium {1Bh:0004h} . . . . .	315
Megabytes read from tape {32h:0004h} . . . . .	322
Megabytes Read since Clean {3Dh:0062h} . . . . .	345
Megabytes transferred from application client {1Bh:0006h} . . . . .	315
Megabytes transferred from server {32h:0006h} . . . . .	322
Megabytes transferred to application client {1Bh:0002h}: . . . . .	315
Megabytes transferred to server {32h:0002h} . . . . .	322
Megabytes Written since Clean {3Dh:0061h} . . . . .	345
Megabytes written to medium {1Bh:0008h} . . . . .	315
Megabytes written to tape {32h:0008h} . . . . .	322
Middle of tape passes {17h:0102h} . . . . .	305
Minimum native capacity between EW and LEOP of the current partition {0Ch:0006h} . . . . .	265
Mounts since Clean {3Dh:0063h} . . . . .	345
Moving Tape Buffer Efficiency {37h:2?A5h} . . . . .	336
Moving Tape Buffer Rate {37h:2?A3h} . . . . .	336
Nominal Capacity of Partition {38h:000Ch} . . . . .	339
Nominal Capacity of Volume {38h:000Eh} . . . . .	340
Number of mounts for the current volume . . . . .	320
Padded Data (Medium) {37h:2?72h} . . . . .	335
Padded Data {37h:2?62h} . . . . .	335
Page valid {17h:000h} . . . . .	302
Partition 0 Maximum Capacity {31h:0003h} . . . . .	321
Partition 0 Remaining Capacity {31h:0001h} . . . . .	321
Partition 1 Maximum Capacity {31h:0004h} . . . . .	321
Partition 1 Remaining Capacity {31h:0002h} . . . . .	321
Performance Impact by ERPs {37h:2?52h} . . . . .	335
Performance Impacting ERPs {37h:2?51h} . . . . .	335
Port Rate Changes {37h:0Dp7h} . . . . .	333
Port Throughput Efficiency {37h:0Dp4h} . . . . .	333
Port Throughput Rate {37h:0Dp3h} . . . . .	333
Port Throughput Rate Maximum Bursting {37h:0Dp1h} . . . . .	333
Port Throughput Rate Maximum Sustained {37h:0Dp2h} . . . . .	333
Position Buffer Hits {37h:14F0h} . . . . .	335
Position Count (Media) {37h:1480h} . . . . .	334
Position Count {37h:1400h} . . . . .	334
Position Relative Rate (Media) {37h:14B0h} . . . . .	334
Position Relative Rate {37h:1430h} . . . . .	334
Position Relative Time (Media) {37h:14A0h} . . . . .	334
Position Relative Time {37h:1420h} . . . . .	334
Position Time (Media) {37h:1490h} . . . . .	334
Position Time {37h:1410h} . . . . .	334
Potential conflict list {11h:0201h+} . . . . .	271
Potential conflict list entries present {11h:0200h} . . . . .	270
Power On Seconds {3Dh:0101h} . . . . .	346
Primary Initiator {37h:0E01h} . . . . .	333
Primary Interface Efficiency {37h:0010h} . . . . .	329
Primary Interface Port 0 Efficiency {37h:0011h} . . . . .	329
Primary Interface Port 1 Efficiency {37h:0012j} . . . . .	329
Primary Port Features {11h:9101h+} . . . . .	271
Read Compression ratio {1Bh:0000h} . . . . .	315
Read Compression ratio x 100 {32h:0000h} . . . . .	322
Read Count {37h:0300h} . . . . .	330
Read Cycle Relative Time {37h:1220h} . . . . .	334
Read Cycle Time {37h:1210h} . . . . .	334
Read Cycles {37h:1200h} . . . . .	334

Read duty cycle {14h:0011h} . . . . .	292
Read Exit Relative Time {37h:1224h} . . . . .	334
Read Filemark (perf) Relative Time {37h:03D4h} . . . . .	331
Read Media Blocks Counter {3Ch:0003h} . . . . .	343
Read Pause Relative Time {37h:1223h} . . . . .	334
Read Pauses {37h:1201h} . . . . .	334
Read Performance Efficiency {37h:03D0h} . . . . .	331
Read Ready Relative Time {37h:1222h} . . . . .	334
Read Relative Time {37h:0302h} . . . . .	331
Read Setup Relative Time {37h:1221h} . . . . .	334
Read Timing {37h:0301h} . . . . .	331
Read Traverse EM Relative Time {37h:1225h} . . . . .	334
Ready duty cycle {14h:0015h} . . . . .	293
Relative Time {37h:0q01h} . . . . .	330
Remaining Capacity of Partition {38h:0011h} . . . . .	340
Remaining Capacity of Volume {38h:0010h} . . . . .	340
Reread Media Blocks Counter {3Ch:0005h} . . . . .	343
Reset Count [by port] {37h:0Fp3h} . . . . .	334
Reset Seconds {3Dh:0102h} . . . . .	346
Resource Recoveries [by port] {37h:0Fp2h} . . . . .	334
Rewrite Media Blocks Counter {3Ch:0002h} . . . . .	343
Secondary Initiator {37h:0E02h} . . . . .	333
Seek Block Count {37h:06D1h} . . . . .	332
Seek Count {37h:0600h} . . . . .	332
Seek Relative Time {37h:0602h} . . . . .	332
Seek Timing {37h:0601h} . . . . .	332
Servo Acquisition Temps {33h:0004h} . . . . .	323
Servo Acquisition Temps {34h:0004h} . . . . .	325
Servo Position Events {33h:0011h} . . . . .	324
Servo Position Events {34h:001Eh} . . . . .	326
Servo Skip Events {33h:000Bh} . . . . .	323
Servo Skip Events {34h:001Bh} . . . . .	326
Servo Speed Relative Time {37h:5Fs0h} . . . . .	336
Servo Temps {33h:0006h} . . . . .	323
Servo Temps {34h:0006h} . . . . .	325
Servo Transients {33h:0001h} . . . . .	323
Servo Transients {34h:0001h} . . . . .	325
Speed Changes {37h:2?F0h} . . . . .	336
Speed Forced {37h:2?F1h} . . . . .	336
Static Capacity Efficiency (Partition t) {37h:8t00h} . . . . .	337
Static Capacity Efficiency {37h:7000h} . . . . .	337
Static Datasets Media (Partition t) {37h:8t10h} . . . . .	337
Static Datasets Media {37h:7010h} . . . . .	337
Static Datasets Used (Partition t) {37h:8t11h} . . . . .	337
Static Datasets Used {37h:7011h} . . . . .	337
Static Distance Media (Partition t) {37h:8t20h} . . . . .	337
Static Distance Media {37h:7020h} . . . . .	337
Static Distance Used (Partition t) {37h:8t21h} . . . . .	337
Static Distance Used {37h:7021h} . . . . .	337
Static Remaining Capacity in SkipSync Buffer {37h:7030h} . . . . .	337
Sync Count [Host] {37h:0500h} . . . . .	331
Sync Count [Implicit] {37h:05D1h} . . . . .	332
Sync Relative Time [Host] {37h:0502h} . . . . .	332
Sync Relative Time [Implicit] {37h:05D4h} . . . . .	332
Sync Timing [Host] {37h:0501h} . . . . .	332
Sync Timing [Implicit] {37h:05D2h} . . . . .	332
Tape Buffer Efficiency {37h:2?A6h} . . . . .	336

Tape Efficiency {37h:2?A8h}	336
Tape lot identifier {17h:0041h}	304
Tape Thrashing {37h:2?A7h}	336
Time {37h:0040h}	329
Time Since Last Cleaning Counter {3Ch:0007h}	343
Timing {37h:0q01h}	330
Total Channel Read Bytes {0Ch:0003h}:	265
Total Channel Write Bytes {0Ch:0000h}:	265
Total Corrected Read Errors {03h:0003h}	263
Total Corrected Write Errors {02h:0003h}:	262
Total Device Read Bytes {0Ch:0002h}:	265
Total Device Write Bytes {0Ch:0001h}:	265
Total Megabytes Processed Since Cleaning {0Ch:8000h}:	266
Total native capacity {17h:0016h}	304
Total Non-Medium Error Count {06h:0000h}:	264
Total Read Errors {03h:0002h}	263
Total Read Kibibytes Processed {03h:0005h}	263
Total Retries {33h:0008h}	323
Total Retries {34h:0015h}	326
Total Uncorrected Read Errors {03h:0006h}	263
Total Uncorrected Write Errors {02h:0006h}:	262
Total used native capacity {17h:0017h}	304
Total Write Errors {02h:0002h}	262
Total Write Kibibytes Processed {02h:0005h}:	262
Transfer Byte Count from Host (out) {37h:0409h}	331
Transfer Byte Count from Host (out) {37h:0q09h}	330
Transfer Byte Count to Host (in) {37h:0305h}	331
Transfer Byte Count to Host (in) {37h:0405h}	331
Transfer Byte Count to Host (in) {37h:0505h}	332
Transfer Byte Count to Host (in) {37h:0605h}	332
Transfer Byte Count to Host (in) {37h:0q05h}	330
Transfer Count from Host (out) {37h:0408h}	331
Transfer Count from Host (out) {37h:0q08h}	330
Transfer Count to Host (in) {37h:0304h}	331
Transfer Count to Host (in) {37h:0404h}	331
Transfer Count to Host (in) {37h:0504h}	332
Transfer Count to Host (in) {37h:0604h}	332
Transfer Count to Host (in) {37h:0q04h}	330
Transfer Recover Time [by port] {37h:0Fp1h}	334
Transfer Recoveries [by port] {37h:0Fp0h}	334
Transfer Timing from Host (out) {37h:040Ah}	331
Transfer Timing from Host (out) {37h:0q0Ah}	330
Transfer Timing to Host (in) {37h:0306h}	331
Transfer Timing to Host (in) {37h:0406h}	331
Transfer Timing to Host (in) {37h:0506h}	332
Transfer Timing to Host (in) {37h:0606h}	332
Transfer Timing to Host (in) {37h:0q06h}	330
Uncompressed Data {37h:2?60h}	335
Velocity Events {33h:0003h}	323
Vendor-Reserved {33h:0009h}	323
Vendor-Reserved {33h:0011h}	324
Vendor-Reserved {39h:0009h}	341
Vendor-Reserved {39h:000Ah}	341
Very high frequency data {11h:0000h}:	270
Very high frequency polling delay {11h:0001h}:	270
Volume barcode {17h:0042h}	304
Volume Datasets Read {17h:0007h}	302

Volume Datasets Read {30h:0007h}:	320
Volume Datasets Written {17h:0002h}	302
Volume Datasets Written {30h:0002h}:	320
Volume Fatal Suspended Reads {30h:000Bh}:	320
Volume Fatal Suspended Writes {30h:0006h}:	320
Volume license code {17h:0044h}	304
Volume Lifetime Megabytes Read {3Dh:0022h}	345
Volume Lifetime Megabytes Written {3Dh:0021h}	345
Volume Lifetime Mounts {3Dh:0020h}	345
Volume loads since last parameter reset {14h:000Dh}:	292
Volume manufacturer {17h:0043h}	304
Volume Mounts {17h:0001h}	302
Volume Mounts {30h:0001h}	320
Volume not present duty cycle {14h:0014h}	292
Volume personality {17h:0045h}	304
Volume Read Perms {30h:0009h}:	320
Volume Read Retries {30h:0008h}:	320
Volume Recovered Read Errors {17h:0008h}	302
Volume Recovered Write Data Errors {17h:0003h}	302
Volume serial number {17h:0040h}	304
Volume Suspended Reads {30h:000Ah}	320
Volume Suspended Writes {30h:0005h}:	320
Volume Unrecovered Read Errors (i.e., Read Perms) {17h:0009h}	303
Volume Unrecovered Write Data Errors (i.e., Write Perms) {17h:0004h}	302
Volume Unrecovered Write Servo Errors {17h:0006h}	302
Volume Write Perms {30h:0004h}:	320
Volume Write Retries {30h:0003h}:	320
Volume Write Servo Errors (updated on both temp and perm) {17h:0005h}	302
Window Buffer Efficiency {37h:2?85h}	336
Window Comp Buffer Efficiency {37h:2?95h}	336
Window Comp Buffer Rate {37h:2?93h}	336
Window Host Buffer Rate {37h:2?83h}	336
Window Tape Buffer Efficiency {37h:2?A4h}	336
Window Tape Buffer Rate {37h:2?A2h}	336
WORM {17h:0081h}:	304
Wrap Change Count {37h:2?10h}	335
Write Compression Ratio x 100 {1Bh:0001h}	315
Write Compression Ratio x 100 {32h:0001h}	322
Write Count {37h:0400h}	331
Write Cycle Relative Time {37h:1020h}	334
Write Cycle Time {37h:1010h}	334
Write Cycles {37h:1000h}	334
Write duty cycle {14h:0012h}	292
Write Exit Relative Time {37h:1024h}	334
Write Filemark Relative Time {37h:04D4j}	331
Write Media Blocks Counter {3Ch:0001h}	343
Write Pause Relative Time {37h:1023h}	334
Write Pauses {37h:1001h}	334
Write Performance Efficiency {37h:04D0h}	331
Write protect {17h:0080h}	304
Write Ready Relative Time {37h:1022h}	334
Write Relative Time {37h:0402h}	331
Write Setup Relative Time {37h:1021h}	334
Write Timing {37h:0401h}	331





Printed in USA

GA32-0928-05

