

IBM i
7.3

*Systems management
Journal management*

IBM

Note

Before using this information and the product it supports, read the information in [“Notices” on page 383.](#)

This edition applies to IBM i 7.3 (product number 5770-SS1) and to all subsequent releases and modifications until otherwise indicated in new editions. This version does not run on all reduced instruction set computer (RISC) models nor does it run on CISC models.

This document may contain references to Licensed Internal Code. Licensed Internal Code is Machine Code and is licensed to you under the terms of the IBM License Agreement for Machine Code.

© **Copyright International Business Machines Corporation 2004, 2015.**

US Government Users Restricted Rights – Use, duplication or disclosure restricted by GSA ADP Schedule Contract with IBM Corp.

Contents

| | |
|--|----------|
| Journal management..... | 1 |
| What's new for 7.3..... | 1 |
| PDF file for Journal management..... | 1 |
| System-managed access-path protection..... | 2 |
| Benefits of SMAPP..... | 2 |
| How SMAPP works..... | 3 |
| How the system chooses access paths to protect..... | 3 |
| Effects of SMAPP on performance and storage..... | 4 |
| How SMAPP handles changes in disk pool configuration..... | 5 |
| SMAPP and access path journaling..... | 6 |
| SMAPP and independent disk pools..... | 7 |
| Starting SMAPP or changing SMAPP values..... | 7 |
| Displaying SMAPP status..... | 8 |
| Local journal management..... | 9 |
| Journal management concepts..... | 9 |
| Benefits of journal management..... | 9 |
| How journal management works..... | 10 |
| Journal entries..... | 13 |
| Journal management and system performance..... | 14 |
| Journal management with the save-while-active function..... | 15 |
| Planning for journal management..... | 16 |
| IBM Navigator for i versus the character-based interface for journaling objects..... | 17 |
| Planning which objects to journal..... | 17 |
| Reasons to journal access paths..... | 20 |
| Reasons to journal before-images..... | 20 |
| Planning for journal use of auxiliary storage..... | 21 |
| Frequently asked questions about journaling and disk arm usage..... | 22 |
| Functions that increase the journal receiver size..... | 24 |
| Methods to estimate the size of a journal receiver..... | 24 |
| Journal sizing and planning tool..... | 25 |
| Estimating the size of the journal receiver manually..... | 26 |
| Methods to reduce the storage that journal receivers use..... | 27 |
| Determining the type of disk pool in which to place journal receivers..... | 28 |
| Journal management and independent disk pools..... | 29 |
| Planning setup for journal receivers..... | 30 |
| Disk pool assignment for journal receivers..... | 30 |
| Library assignment for journal receivers..... | 30 |
| Naming conventions for journal receivers..... | 31 |
| Threshold (disk space) for journal receivers..... | 32 |
| Security for journal receivers..... | 33 |
| Planning setup for journals..... | 34 |
| Disk pool assignment for journals..... | 34 |
| Library assignment for journals..... | 34 |
| Naming conventions for journals..... | 34 |
| Journal and journal receiver association..... | 35 |
| Journal message queue..... | 35 |
| Manual versus system journal-receiver management..... | 36 |
| Automatic deletion of journal receivers..... | 38 |
| Receiver size options for journals..... | 39 |
| Journal object limit..... | 42 |
| Minimized entry-specific data for journal entries..... | 43 |

| | |
|--|-----|
| Customization of the journal recovery count..... | 45 |
| Fixed-length options for journal entries..... | 45 |
| Journal cache..... | 46 |
| Object assignment to journals..... | 47 |
| Setting up journaling..... | 48 |
| Example: Setting up journaling..... | 49 |
| Starting and ending journaling and changing journaling attributes..... | 51 |
| Why you must save objects after you start journaling..... | 51 |
| Starting journaling..... | 52 |
| Journaling libraries..... | 53 |
| Journaling database physical files (tables)..... | 53 |
| Journal DB2 Multisystem files..... | 54 |
| Logical file journaling..... | 54 |
| Journaling integrated file system objects..... | 54 |
| Journal access paths..... | 56 |
| Journaling data areas and data queues..... | 56 |
| Automatically starting journaling..... | 57 |
| Changing journaling attributes of journaled objects without ending journaling..... | 59 |
| Ending journaling..... | 61 |
| Managing journals..... | 62 |
| Swapping, deleting, saving and restoring journals and receivers..... | 62 |
| Swapping journal receivers..... | 62 |
| Journal receiver chains..... | 64 |
| Resetting the sequence number of journal entries..... | 65 |
| Deleting journal receivers..... | 66 |
| Deleting journals..... | 69 |
| Saving and restoring journals and journal receivers..... | 70 |
| Evaluation of how system changes affect journal management..... | 73 |
| Keeping records of journaled objects..... | 74 |
| Security management for journals..... | 74 |
| Displaying information for journaled objects, journals, and receivers..... | 75 |
| Working with inoperable journal receivers..... | 77 |
| Comparing journal images..... | 77 |
| Working with IBM-supplied journals..... | 78 |
| Sending your own journal entries..... | 80 |
| Changing the state of local journals..... | 80 |
| Work with messages on the journal message queue..... | 82 |
| Scenario: Journal management..... | 82 |
| JKLPROD..... | 83 |
| JKLINT..... | 84 |
| JKLDEV..... | 84 |
| Recovery operations for journal management..... | 85 |
| Determining recovery needs using journal status..... | 85 |
| Recovery for journal management after abnormal system end..... | 86 |
| Recovering from a damaged journal receiver..... | 88 |
| Recovering a damaged journal..... | 89 |
| Associating receivers with journals..... | 90 |
| Recovering a damaged journal with the WRKJRN command..... | 91 |
| Recovery of journaled objects..... | 92 |
| Applying journaled changes..... | 93 |
| Removing journaled changes..... | 99 |
| Use of the QAJRNCHG file..... | 101 |
| Journaled changes with trigger programs..... | 106 |
| Journaled changes with referential constraints..... | 106 |
| Actions of applying or removing journaled changes by journal code..... | 107 |
| When the system ends applying or removing journaled changes..... | 116 |
| Example: Applying journaled changes..... | 118 |
| Example: Removing journaled changes..... | 120 |

| | |
|---|-----|
| Example: Recovering objects with partial transactions..... | 121 |
| Journal entry information..... | 123 |
| Journal code descriptions..... | 124 |
| All journal entries by code and type..... | 125 |
| Fixed-length portion of the journal entry..... | 161 |
| Layouts for the fixed-length portion of journal entries..... | 162 |
| Variable-length portion of the journal entry..... | 192 |
| Layouts for variable-length portion of journal entries..... | 193 |
| Working with journal entry information..... | 304 |
| Displaying and printing journal entries..... | 304 |
| Displaying journal information for a table using IBM Navigator for i..... | 307 |
| Displaying journal entry information using the Display_Journal table function | 307 |
| Receiving journal entries in an exit program..... | 307 |
| Retrieving journal entries in a program..... | 312 |
| Working with pointers in journal entries..... | 313 |
| Replaying a database operation from a single journal entry..... | 314 |
| Replaying a non-database operation from a single journal entry..... | 316 |
| Considerations for entries which contain minimized entry-specific data..... | 316 |
| Remote journal management..... | 317 |
| Remote journal concepts..... | 317 |
| Network configurations for remote journals..... | 319 |
| Types of remote journals..... | 320 |
| Filtered remote journals..... | 322 |
| Journal state and delivery mode..... | 323 |
| Journal receivers associated with a remote journal..... | 327 |
| Process of adding remote journal | 328 |
| Library redirection with remote journals..... | 329 |
| Remote journal attributes..... | 331 |
| Supported communications protocols for remote journals..... | 332 |
| Release-to-release considerations for remote journals..... | 333 |
| Planning for remote journals..... | 333 |
| Candidates for remote journal management..... | 333 |
| Synchronous and asynchronous delivery mode for remote journals..... | 334 |
| Communications protocol and delivery mode for remote journals..... | 335 |
| Where the replication of journal entries start..... | 335 |
| Factors that affect remote journal performance..... | 337 |
| Remote journals and auxiliary storage..... | 339 |
| Journal receiver disk pool considerations..... | 340 |
| Remote journals and main storage..... | 340 |
| Setting up remote journals..... | 341 |
| Preparing to use remote journals..... | 341 |
| Adding remote journals..... | 342 |
| Removing remote journals..... | 343 |
| Activating and inactivating remote journals..... | 344 |
| Activating the replication of journal entries to a remote journal..... | 344 |
| Catch-up phase for remote journals..... | 345 |
| Relational database considerations for remote journal state..... | 347 |
| Automatically restarting remote journal..... | 347 |
| Inactivating the replication of journal entries to a remote journal..... | 348 |
| Managing remote journals..... | 348 |
| Keeping records of your remote journal network..... | 349 |
| Displaying remote journal function information..... | 349 |
| Evaluating how system changes affect your remote journal network..... | 350 |
| Getting information about remote journal entries..... | 350 |
| File identifier considerations for working with integrated file system entries..... | 350 |
| Confirmed and unconfirmed journal entries..... | 352 |
| Journal entries from a remote journal with library redirection..... | 353 |
| Retrieving journal entries from a remote journal during the catch-up phase..... | 353 |

| | |
|---|------------|
| Remote journal considerations for retrieving journal entries when using commitment control..... | 354 |
| Remote journal considerations for retrieving journal entries when using journal caching... | 355 |
| Journal receiver management with remote journals..... | 355 |
| Swapping journal receiver operations with remote journals..... | 356 |
| Considerations for save and restore operations with remote journals..... | 357 |
| Rules for saving and restoring journals..... | 357 |
| Rules for saving and restoring journal receivers..... | 358 |
| Considerations for restoring journaled objects..... | 360 |
| Considerations for restoring objects saved with SAVSTG..... | 361 |
| Remote journal considerations when restarting the server..... | 361 |
| Working with remote journal error messages..... | 363 |
| Scenarios: Remote journal management and recovery..... | 364 |
| Scenario: Data replication environment for remote journals..... | 364 |
| Scenario: Hot-backup environment..... | 367 |
| Scenario: Recovery for remote journaling..... | 369 |
| Details: Recovery for remote journaling scenario..... | 370 |
| Related information for journal management..... | 380 |
| Notices..... | 383 |
| Programming interface information..... | 384 |
| Trademarks..... | 384 |
| Terms and conditions..... | 385 |

Journal management

Journal management provides a means by which you can record the activity of objects on your system. When you use journal management, you create an object called a **journal**. The journal records the activities of the objects you specify in the form of **journal entries**. The journal writes the journal entries in another object called a **journal receiver**.

Journal management provides you with the following:

- Decreased recovery time after an abnormal end
- Powerful recovery functions
- Powerful audit functions
- The ability to replicate journal entries on a remote system

This topic provides information about how to set up, manage, and troubleshoot system-managed access-path protection (SMAPP), local journals, and remote journals on the IBM® i platform.

Note: By using the code examples, you agree to the terms of the [Code license and disclaimer information](#).

What's new for 7.3

Describes the improvements and additions to journal management.



New journal entry type for journal entry code J

For journal code J- Journal operations, there is a new entry type JQ - Journal quiesce ASP activity

For a list of all journal entries by code and type see: [“All journal entries by code and type” on page 125](#)

How to see what's new or changed

To help you see where technical changes have been made, this information uses:

- The  image to mark where new or changed information begins.
- The  image to mark where new or changed information ends.

To find other information about what's new or changed this release, see the [Memo to users](#).

PDF file for Journal management

Use this to view and print a PDF of this information.

To view or download the PDF version of this document, select [Journal management](#).

You can view or download these related topics:

- [Database programming](#) contains the following topics:
 - Setting up a database on your system.
 - Using a database on your system.
- [Integrated file system](#) contains the following topics:
 - What is the integrated file system?
 - Integrated file system concepts and terminology.
 - The interfaces you can use to interact with the integrated file system.

Saving PDF files

To save a PDF on your workstation for viewing or printing:

1. Right-click the PDF in your browser (right-click the link above).
2. Click the option that saves the PDF locally.
3. Navigate to the directory in which you would like to save the PDF.
4. Click **Save**.

Downloading Adobe Reader

You need Adobe Reader installed on your system to view or print these PDFs. You can download a free copy from the [Adobe Web site \(www.adobe.com/products/acrobat/readstep.html\)](http://www.adobe.com/products/acrobat/readstep.html) .

System-managed access-path protection

System-managed access-path protection (SMAPP) allows you to use some of the advantages of journaling without explicitly setting up journaling. Use SMAPP to decrease the time it takes to restart your system after an abnormal end.

SMAPP is a way to reduce the time for the system or independent disk pool to restart after an abnormal end. An **access path** describes the order in which records in a database file are processed. A file can have multiple access paths, if different programs need to see the records in different sequences.

When the system or an independent disk pool ends abnormally, the system must rebuild the access paths the next time you restart the system, or vary on an independent disk pool. When the system must rebuild access paths, the next restart or vary on operation takes longer to complete than if the system ended normally.

When you use SMAPP, the system protects the access paths so the system does not need to rebuild the access paths after an abnormal end. This topic introduces SMAPP, describes SMAPP concepts, and provides setup and management tasks.

Benefits of SMAPP

System-managed access-path protection (SMAPP) can greatly reduce the amount of time it takes to restart your system or vary on an independent disk pool, after an abnormal end.

The time is reduced by protecting access paths. A protected access path can be recovered much quicker than an unprotected access path. It is an automatic function that runs without attention. SMAPP determines which access paths to protect without any intervention by the user. It adjusts to changes in the environment, such as the addition of new applications or new hardware.

SMAPP does not require any setup. You do not have to change your applications. You do not have to journal any physical files or even use journaling at all. You simply need to determine your policy for access path recovery:

- After a failure, how long you can afford to spend rebuilding access paths when you restart the system, or vary on an independent disk pool.
- How to balance access path protection with other demands on system resources.
- Whether to have different target times for recovering access paths for different disk pools.

You may need to experiment with different target recovery times for access paths to achieve the correct balance for your system. If you configure additional basic or independent disk pools, you must also evaluate your access path recovery times.

The system protects access paths by journaling the access paths to internal system journals. Therefore, SMAPP requires some additional auxiliary storage for journal receivers. However, SMAPP is designed to keep the additional disk usage to a minimum. SMAPP manages journal receivers and removes them from the system as soon as they are no longer needed.

Related concepts

[Independent disk pools](#)

How SMAPP works

The purpose of system-managed access-path protection (SMAPP) is to reduce the amount of time it takes to restart the system or vary on an independent disk pool, after an abnormal end.

It can take much longer than normal to restart the system when the system ends abnormally because of something like a power interruption. Also, if you are using an independent disk pool, the next vary on of the independent disk pool can take much longer than normal.

Access paths

An **access path** describes the order in which records in a database file are processed. A file can have multiple access paths, if different programs need to see the records in different sequences.

How SMAPP works with abnormal ends

When the system restarts after an abnormal end, the system rebuilds access paths that were open for updating at the time of the abnormal end. Rebuilding access paths contributes to this long restart time. Likewise, when you vary on an independent disk pool, the system rebuilds access paths that were open for updating at the time the independent disk pool ended abnormally. The system does not rebuild access paths that are specified as MAINT(*REBLD) when you create them. When protecting access paths with SMAPP, the system uses information that it has collected to bring access paths up to date, rather than rebuilding them.

You can specify the target time for rebuilding access paths after the system ends abnormally. The target time is a goal that the system does its best to achieve. The actual recovery time for access paths after a specific failure may be somewhat more or less than this target.

The target recovery time for access paths can be specified for the entire system or for individual disk pools. The system dynamically selects which access paths to protect to meet this target. It periodically estimates how long it will take to recover access paths that are open for change.

For new systems, the system-wide recovery time for access paths is 50 minutes, which is the default. If you move from a release that does not provide the SMAPP function to a release that supports SMAPP, the system-wide recovery time for access paths is also set to 50 minutes.

How the system chooses access paths to protect

The system periodically examines access path exposure and estimates how long it would take to rebuild all the exposed access paths. If the rebuild time exceeds your target recovery times for access paths, the system selects additional access paths for protection.

An access path is **exposed** when the access path has changed because records have been added or deleted or because a key field has changed, and those changes have not yet been written to the disk. The system periodically examines access path exposure and estimates the time required to rebuild all the exposed access paths. If the rebuild time exceeds your target recovery times for access paths, the system selects additional access paths for protection. The system can also remove access paths from protection if the estimated time for rebuilding access paths consistently falls below your target recovery times for access paths. The recover attribute of a file is not used in determining whether to protect access paths.

Some access paths are not eligible for protection by SMAPP:

- A file that specifies MAINT(*REBLD).
- An access path that is already explicitly journaled.
- An access path in the QTEMP library.
- An access path whose underlying physical files are journaled to different journals.
- A file journaled to a journal in standby state.

- Some access paths that use an international component for unicode (ICU) sort sequence table and aggregate encoded vector indexes.

You can use the **Display Recovery for Access Paths (DSPRCYAP)** command to see a list of access paths that are not eligible for SMAPP.

Effects of SMAPP on performance and storage

System-managed access-path protection (SMAPP) is designed to have minimal effect to your system. Though it is minimal, SMAPP does affect your system's processor performance and auxiliary storage.

Processor performance

SMAPP has some effect on processor performance. The lower the target recovery time you specify for access paths, the greater this effect may be. Typically, the effect on processor performance is not very noticeable, unless the processor is nearing capacity. Another situation that may cause an increase in processor consumption is when local journals are placed in standby state and large access paths built over files journaled to the local journal are modified. The presence of standby state flags the access paths as not eligible for SMAPP protection. This may force SMAPP to protect many other small access paths in an attempt to achieve the specified target recovery time, and this can lead to performance concerns. Using the F16=Display details function from the Display Recovery for Access Paths (DSPRCYAP) shows the internal threshold used by SMAPP. All access paths with estimated rebuild times greater than the internal threshold are protected by SMAPP. The internal threshold value might change if the number of exposed access paths changes, the estimated rebuild times for exposed access paths changes, or if the target recovery time changes.

To alleviate the processor performance impact, INCACCPH(*ELIGIBLE) can be specified on the Change Recovery for Access Paths (CHGRCYAP) command. This will give SMAPP permission to ignore any access paths built over files journaled to journals in this state which in turn will prevent SMAPP from having to protect many other small access paths. However, this INCACCPH option will ignore these access paths when estimating the IPL or independent Auxiliary Storage Pool (ASP) vary on exposure which means that the actual IPL or independent ASP vary on duration may be longer than the estimated value.

Auxiliary storage

SMAPP causes increased disk activity, which increases the load on disk input/output processors. Because the disk write operations for SMAPP do not happen at the same time, they do not directly affect the response time for a specific transaction. However, the increased disk activity might affect overall response time.

Also when you use SMAPP, the system creates an internal journal and journal receiver for each disk pool on your system. The journal receivers that SMAPP uses take additional auxiliary storage. If the target recovery time for access paths for a disk pool is set to *NONE, the journal receiver has no entries. The internal journal receivers are spread across all the arms in a disk pool, up to a maximum of 100 arms.

The system manages the journal receivers automatically to minimize the affect as much as possible. It regularly discards internal journal receivers that are no longer needed for recovery and recovers the disk space. The internal journal receivers that are used by SMAPP require less auxiliary storage than the journal receivers for explicit journaling of access paths. Internal journal receivers are more condensed because they are used only for SMAPP entries.

If you have already set up journaling for a physical file, the system uses the same journal to protect any access paths that are associated with that physical file. If the system chooses to protect additional access paths, your journal receivers will grow larger more quickly. You will need to change journal receivers more often.

Tips to reduce SMAPP's effect on auxiliary storage

- When you set up SMAPP, specify target recovery times for access paths either for the entire system or for individual disk pools, but not for both. If you specify both, the system does extra work by balancing the overall target with the individual targets.
- If you also journal physical files, to deal with the increased size of your journal receivers, consider specifying to remove internal entries when you set up journaling or swap journal receivers. If you specify this, the system periodically removes internal entries from user journal receivers when it no longer needs them to recover access paths. This prevents your journal receivers from growing excessively large because of SMAPP.
- If your system cannot support dedicating any resources to SMAPP, you can specify *OFF for the system target recovery time. Before choosing this option, consider setting the recovery time to *NONE for a normal business cycle, perhaps a week. During that time, periodically display the estimated recovery time for access paths. Evaluate whether those times are acceptable or whether you need to dedicate some system resources to protecting access paths.

If you turn SMAPP off, any disk storage that has already been used will be recovered shortly thereafter. If you set the SMAPP values to *NONE, any disk storage that has already been used will be recovered after the next time you restart your system.

Note: If you want to change the target system recovery time to a different value after you have set it to *OFF, the system must be in a restricted state.

Related concepts

Receiver size options for journals

A journal receiver holds journal entries that you might use for recovery and entries that the system might use for recovery. For example, you might use record level entries, such as database record changes, and file level entries, such as the entry for opening or closing a file. Also, the system writes entries that you never see or use, such as entries for explicitly journaled access paths, for SMAPP, or for commitment control.

Performance

How SMAPP handles changes in disk pool configuration

When you restart the system, the system checks to see if your disk pool configuration has changed. The system may change either the size of the SMAPP receiver or the placement of the receiver based on the change to the disk units.

When you restart your system, the system checks to see if your disk pool configuration has changed. The system does the following:

- If any disk units have been added or removed from an existing disk pool, the system may change either the size of the SMAPP receiver or the placement of the receiver.
- If any new disk pools are in the configuration and do not have any access path recovery times assigned for SMAPP, the system assigns a recovery time of *NONE for that disk pool. If you remove a disk pool from your configuration and later add it back, the access path for that disk pool is set to *NONE, even if that disk pool previously had a recovery time for access paths.
- If all basic user disk pools have been removed from your configuration so that you have only the system disk pool, the system access path recovery time is set to the lower of the following values:
 - The existing system access path recovery time.
 - The current access path recovery time for disk pool 1. If the current access path recovery time for disk pool 1 is *NONE, the system access path recovery time is not changed.

When you vary on an independent disk pool, the system checks to see if any disk units have been added or removed from the independent disk pool. The system may change either the size of the SMAPP receiver or the placement of the receiver based on the change to the disk units. If this is the first time the independent disk pool is varied on, then the system assigns a recovery time of *NONE for that independent disk pool.

When you add disk units to your disk configuration while your system is active, or your independent disk pool is varied on, the system does not consider those changes in making SMAPP storage decisions until the next time you restart the system, or vary on the independent disk pool. The system uses the size of the disk pool to determine the threshold size for SMAPP receivers. If you add disk units, the system does not increase the threshold size for the receivers until the next time you restart the system restart or vary on the independent disk pool. This means that the frequency of changing SMAPP receivers will not go down until you restart the system, or vary off the independent disk pool.

When you create a new user disk pool while your system is active, add all of the planned disks to the disk pool at the same time. The system uses the initial size of the new disk pool to make storage decisions for SMAPP. If you later add more disk units to the disk pool, those disk units are not considered until the next time you restart the system or vary on the independent disk pool. When you create a new user disk pool, the access path recovery time for that disk pool is set to *NONE. You can use the EDTRCYAP command to set a target recovery time for the new disk pool, if desired.

Related concepts

[Disk management](#)

SMAPP and access path journaling

In addition to using system-managed access path protection (SMAPP), you can choose to journal some access paths yourself by using the Start Journaling Access Path (STRJRNAP) command. This is called **explicit journaling**.

To journal an access path explicitly, you must first journal all the underlying physical files. SMAPP does not require that the underlying physical files be journaled.

The reason for choosing to journal an access path explicitly is that you consider the access path (and the underlying files) absolutely critical. You want to make sure that the files are available as soon as possible when the system is started after an abnormal end.

Under SMAPP, the system looks at all access paths to determine how it can meet the specified target times for recovering access paths. It may not choose to protect an access path that you consider critical.

When the system determines how to meet the target times for recovering access paths, it considers only access paths that are not explicitly journaled.

How SMAPP is different from explicitly journaling access paths:

- SMAPP does not require that underlying physical files be journaled.
- SMAPP determines which access paths to protect based strictly on the target recovery times for all access paths. You might choose to journal an access path explicitly because of your requirements for the availability of a specific file.
- SMAPP continually evaluates which access paths to protect and responds to changes in your system environment.
- SMAPP does not require any user intervention to manage its internal journals and journal receivers.
- SMAPP uses less disk space for journal receivers because they are detached and deleted regularly.

For more information about when to journal access paths, see [Reasons to journal access paths](#).

Related concepts

[Reasons to journal access paths](#)

If you journal access paths, the system can use the journal entries to recover access paths instead of rebuilding them completely.

Related reference

[Start Journal Access Path \(STRJRNAP\) command](#)

SMAPP and independent disk pools

Use SMAPP to limit recovery time for access paths that reside within independent disk pools.

When you use SMAPP to protect access paths in independent disk pools, you can specify the recovery time individually for each independent disk pool. This helps limit the vary-on duration as well as the quantity of background job activity, which must ensue to make each access path whole when you vary on your independent disk pool after an abnormal vary off.

The recovery time that you specify becomes an attribute of the independent disk pool and thus moves with the independent disk pool if you switch it between systems. Therefore, if you are switching an independent disk pool between systems, you only need to specify the recovery time once.

The only occasion when the specified recovery time is not moved is when the system you are moving the independent disk pool to has its system wide recovery time specified as *OFF. In this case, the independent disk pool's recovery time is set to *NONE when you vary on the independent disk pool.

Related concepts

[Independent disk pools](#)

Starting SMAPP or changing SMAPP values

Use the Edit Recovery Access Path (EDTRCYAP) display to start or change values for system-managed access-path protection (SMAPP).

If you use basic or independent disk pools to separate objects that have different recovery and availability requirements, you might also want to specify different recovery times for access paths in those disk pools.

For example, if you have a large history file that changes infrequently, you can put the file in a separate disk pool and set the access path recovery time for that disk pool to *NONE. Or, if you have an independent disk pool, and you want the recovery time to move with the disk pool when it is switched to another system, you can specify a specific time for that disk pool.

To start SMAPP or change SMAPP values, proceed as follows:

1. On the display, specify one of the following values in the **System access path recovery time** field:
 - *SYSDFT
 - *NONE
 - *MIN
 - *OFF
 - A specific value between 1 and 1440 minutes.
2. At the **Include access paths** field select one of the following:
 - *ALL
 - *ELIGIBLE
3. If you are starting or changing SMAPP for disk pools, change the **Target** field for individual disk pools.

To change the access path recovery time from *OFF to another value, your system must be in a restricted state.

You can also use the **Change Recovery for Access Paths (CHGRCYAP)** command to change the target recovery times without using the Edit Recovery Access Path display.

The system performance monitor also provides information about access path recovery times. The Work Management and Performance Tools for IBM i topics provide more information about monitoring performance and about what SMAPP information is available through the tools.

Related reference

[Edit Recovery Access Path \(EDTRCYAP\) command](#)

[Change Recovery for Access Paths \(CHGRCYAP\) command](#)

Related information

[Work Management](#)

[Performance Tools for System i PDF](#)

Displaying SMAPP status

You can display many types of status for SMAPP.

You can use the **Edit Recovery for Access Paths (EDTRCYAP)** command to view the following values for system-managed access-paths (SMAPP):

- The entire system.
- Basic and independent disk pools.
- Access paths not eligible for protection.
- Protected access paths.
- Unprotected access paths

Use the top part of the display to see the values for the entire system. Use the bottom part of the display to see the values for individual disk pools on the system. If you do not have basic or independent disk pools that are active, the bottom part of the display says `No user ASP configured or information not available`.

Estimated time for recovery

To see the number of minutes the system estimates it will need to recover most of the access paths, look at the **Estimated recovery time for access paths** field. The time is an estimated maximum, based on most circumstances. It assumes that the system is recovering access paths on a dedicated server (during a restart) and that all eligible access paths are being recovered or rebuilt. It does not include time to rebuild access paths that must be rebuilt for one of the following reasons:

- The access path is damaged.
- The access path was marked as `not valid` during a previous abnormal end and was not successfully rebuilt.
- One of the following commands marked the access path as `not valid` and was running when the system failed:
 - **Copy File (CPYF)**, if the system chose to rebuild the access path for efficiency.
 - **Reorganize Physical File Member (RGZPFM)**
 - **Restore Object (RSTOBJ)**

If you have basic or independent disk pools, the estimated recovery time for access paths for the entire system (**System access path recovery time** field) might not equal the total estimated recovery time for the disk pools (**Access Path Recovery Time-Estimated (Minutes)**). When you restart the system or vary on an independent disk pool, the system overlaps processing when recovering access paths to reduce the total time it requires.

Disk space used

The **Disk Storage Used** field on the display shows the disk space that SMAPP uses only for internal system journals and journal receivers. It does not include any additional space in user-managed journal receivers for protecting access paths whose underlying physical files are already journaled.

Access paths not eligible

You can display all access paths that are not eligible for protection. To view access paths that are not eligible for protection, press F13. Access paths that are not eligible for access protection are as follows:

- Access paths built over physical files which are journaled to separate journals.

- Access paths built over a physical file which is journaled to a journal whose state is currently standby.

Protected access paths

You can display up to 500 protected access paths by pressing F14. The system displays the access paths with the highest estimated recovery time first.

Unprotected access paths

You can display up to 500 access paths that are eligible for SMAPP protection but are not currently being protected by pressing F15. The system displays the access paths with the highest estimated recovery time first.

Display details

By pressing F16 you can display some additional details concerning your SMAPP environment. These details may be helpful if there are concerns with your SMAPP environment.

You can also use the **Display Recovery for Access Paths (DSPRCYAP)** command to display or print the estimated recovery times, disk usage and additional details.

Related reference

[Display Recovery for Access Paths \(DSPRCYAP\) command](#)

Local journal management

Use local journal management to recover the changes to an object that have occurred since the object was last saved, as an audit trail, or to help replicate an object. Setting up journaling locally is a prerequisite for other system functions such as remote journal management and commitment control. Use this information to set up, manage, and troubleshoot journaling on a local system.

Related information

[Journal entry information finder](#)

Journal management concepts

This topic explains how journal management works, why to use it, and how it affects your system.

Journal management enables you to recover the changes to an object that have occurred since the object was last saved. You can also use journal management to provide an audit trail or to help replicate an object. You use a journal to define what objects you want to protect with journal management. The system keeps a record of changes you make to objects that are journaled and of other events that occur on the system.

This topic provides information about how journals work, information about journal entries, and how journals affect system performance.

Benefits of journal management

The primary benefit of journal management is that it enables you to recover the changes to an object that have occurred since the object was last saved. This ability is especially useful if you have an unscheduled outage such as a power failure.

In addition to powerful recovery functions, journal management also has the following benefits:

- Journal management enhances system security. You can create an audit trail of activity that occurs for objects.
- Journal management allows you to generate user defined journal entries to record activity, even for objects that do not allow journaling.
- Journal management provides quicker recovery of access paths if your system ends abnormally.
- Journal management provides quicker recovery when restoring from save-while-active media.

- Journal management provides the means to recover an object that was saved with partial transactions. Saving your system while it is active has instructions for saving an object with partial transactions.

Related tasks

[Save your server while it is active](#)

[Example: Recovering objects with partial transactions](#)

If you restore an object that was saved with a save-while-active operation that specified that the object can be saved before it reaches a commitment boundary, it can have partial transactions. To recover objects that are in a partial state you must perform an apply or a remove journaled changes operation.

How journal management works

Use journal management to create an object called a **journal**. Use a journal to define which objects you want to protect. You can have more than one journal on your system. A journal can define protection for more than one object.

You can journal the objects that are listed below:

- Libraries
- Database physical files
- Access paths
- Data areas
- Data queues
- Integrated file system objects (stream files, directories, and symbolic links).

Journal entries

The system keeps a record of changes you make to objects that are journaled and of other events that occur on the system. These records are called journal entries. You can also write journal entries for events that you want to record, or for objects other than the object that you want to protect with journaling.

For example, some journal entries identify activity for a specific database record such as add, update, or delete. (If the updated object image after the update is the same as the image before the update, then journal entries are not deposited for that update.) Also journal entries identify activity such as a save, open, or close operation for an object. Journal entries can also identify other events that occur, such as security-relevant events on the system or changes made by dynamic performance tuning. The Journal entry information link below describes all the possible journal entry types and their contents.

Each journal entry can include additional control information that identifies the source of the activity, including the user, job, program, time, and date. The entries that the system deposits for a journaled object reflect the changes made to that journaled object. For example, the entries for changes to database records can include the entire image of the database record, not just the changed information.

Journal receivers

The system writes entries to an object called a **journal receiver**. The system sends entries for all the objects associated with a particular journal to the same journal receiver.

You can attach journal receivers to a journal by using System i® Navigator or the Create Journal (CRTJRN) and Change Journal (CHGJRN) commands. The system adds journal entries to the attached receiver. Journal receivers that are no longer attached to a journal and are still known to the system are **associated** with that journal. Use the Work with Journal Attributes (WRKJRNA) command to see a list of receivers associated with a journal.

The system adds an entry to the attached journal receiver when an event occurs to a journaled object. The system numbers each entry sequentially. For example, it adds an entry when you change a record in a journaled database file member. Journal entries contain information that identifies:

- Type of change

- Record that has been changed
- Change that has been made to the record
- Information about the change (such as the job being run and the time of the change)

When you are journaling objects, changes to the objects are added to the journal receiver. The system does not journal data that you retrieved but did not change. If the logical file record format of a database file does not contain all the fields that are in the dependent physical file record format, the journal entry still contains all the fields of the physical file record format. In addition, if you are journaling access paths, entries for those access paths are added to the journal. If the updated physical file image after the update is the same as the image before the update, and if the file has no variable length fields, then journal entries are not deposited for that update. If the updated data area image after the update is the same as the image before the update, then journal entries are not deposited for that update. If the attribute that was requested to be changed was already that value, then journal entries are not deposited for that change.

Summary of the journaling process

The following figure shows a summary of journal processing. Objects A and B are journaled; object C is not. Programs PGMX and PGMY use object B. When you make a change to object A or B, the following occurs:

- The change is added to the attached journal receiver.
- The journal receiver is written to auxiliary storage.
- The changes are written to the main storage copy of the object.

Object C changes are written directly to the main storage copy of the object because it is not being journaled. Only the entries added to the journal receiver are written immediately to auxiliary storage. Changes against the object may stay in main storage until the object is closed.

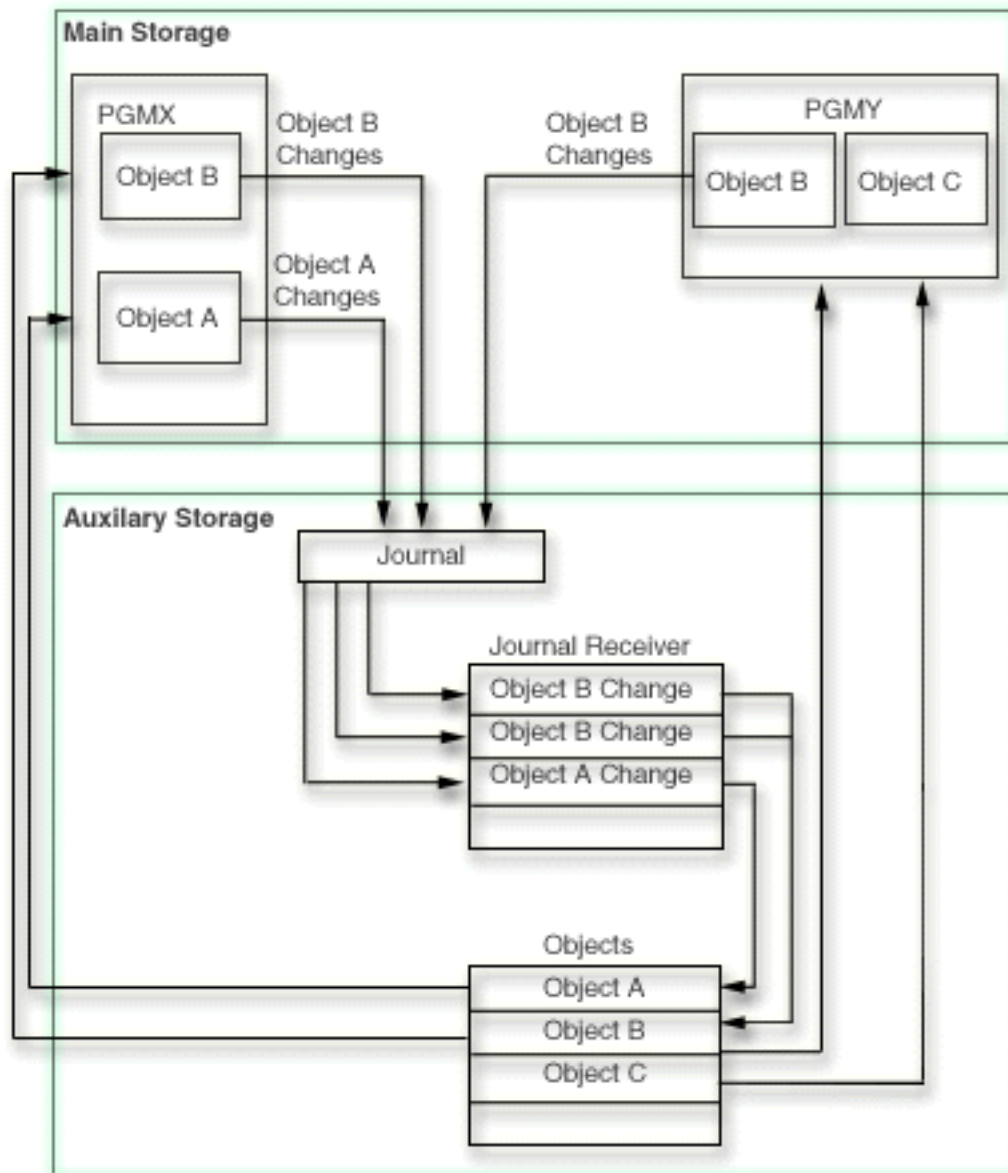

You can also take advantage of the remote journal function. The remote journal function allows you to associate a journal on a remote system with a journal on a local system. Journal entries on the local system are replicated to the remote journal receiver.

Related concepts

Journal entry information

This topic provides information and tasks for working with journal entries.

Remote journal management

Use remote journal management to establish journals and journal receivers on a remote system that are associated with specific journals and journal receivers on a local system. Remote journal management replicates journal entries from the local system to the journals and journal receivers that are located on the remote system after they have been established.

Related reference

Create Journal (CRTJRN) command

Change Journal (CHGJRN) command

Journal entries

When you use journal management, the system keeps a record of changes that you make to objects that are journaled and of other events that occur on the system. These records are called journal entries. You can use journal entries to help recover objects or analyze changes that were made to the objects.

Every journal entry is stored internally in a compressed format. The operating system must convert journal entries to an external form before you can see them. You cannot change or access the journal entries directly. Not even the security officer can remove or change journal entries in a journal receiver. You can use these journal entries to help you recover your objects or analyze changes that were made to the objects.

Contents of a journal entry

Journal entries contain the following information:

- Information that identifies the type of change.
- Information that identifies the data that was changed.
- The after-image of the data.
- Optionally, the before-image of the data (this is a separate entry in the journal).
- Information that identifies the job, the user, and the time of change.
- The journal identifier of the object.
- Information that indicates if the entry-specific data is minimized.

The system also places entries in the journal that are not for a particular journaled object. These entries contain information about the operation of the system and the control of the journal receivers.

Journal identifier

When you start journaling an object, the system assigns a unique **journal identifier** (JID) to that object. The system uses the JID to associate the journal entry with the corresponding journaled object.

Journal entry numbering

Each journal entry is sequentially numbered without any missing numbers until you reset the sequence number with the **Change Journal (CHGJRN)** command or System i Navigator. However, when you display journal entries, sequence numbers can be missing because the system uses some entries only internally. For audit purposes, you can display these internal entries with the INCHIDENT option on the **Display Journal (DSPJRN)** command.

When the system exceeds the largest sequence number, a message is sent to the system operator identifying the condition and requesting action. No other journal entries can be added to the journal until the journal receivers are changed and the sequence number is reset.

Fixed-length and variable-length portions

A journal entry that is converted for displaying or processing contains a fixed-length prefix portion that is followed by a variable-length portion. The variable-length portion contains entry-specific data and, in some cases, null-values indicator data. The format of the converted entry depends on the command that you use and the format that you specify. The entry-specific data varies by entry type. The **Send Journal Entry (SNDJRNE)** command or the QJOSJRNE API specifies the entry-specific data for user-created journal entries.

Related concepts

Why you must save objects after you start journaling

After you start journaling, it is essential that you save objects that you are journaling.

Journal entry information

This topic provides information and tasks for working with journal entries.

Related reference

[Apply Journalized Changes \(APYJRNCHG\) command](#)

[Apply Journalized Changes Extend \(APYJRNCHGX\) command](#)

[Compare Journal Images \(CMPJRNIMG\) command](#)

[Delete Pointer Handle \(QjoDeletePointerHandle\) API](#)

[Display Journal \(DSPJRN\) command](#)

[Get Path Name of Object from Its File ID \(Qp0lGetPathFromFileID\(\)\) API](#)

[Receive Journal Entry \(RCVJRNE\) command](#)

[Retrieve Journal Entry \(RTVJRNE\) command](#)

[Retrieve Journal Entries \(QjoRetrieveJournalEntries\) API](#)

[Remove Journalized Changes \(RMVJRNCHG\) command](#)

[Replay Database Operation \(QDBRPLAY\) API](#)

[Send Journal Entry \(SNDJRNE\) command](#)

[Send Journal Entry \(QJOSJRNE\) API](#)

Journal management and system performance

Journal management prevents transactions from being lost if your system ends abnormally or has to be recovered. Journal management writes changes to journaled objects immediately to the journal receiver in auxiliary storage. Journaling increases the disk activity on your system and can have a noticeable affect on system performance.

Journaling also increases the overhead associated with opening objects and closing objects, so as the number of objects you are journaling increases, the general performance of the system can be slower. The time it takes to perform an IPL on your system or vary on of an independent auxiliary storage pool (ASP) can also increase, particularly if your system or independent ASP ends abnormally.

The system takes measures to minimize the performance effect of using journaling features. For example, the system packages before-images and after-images, and any access path changes for a record in a single write operation to auxiliary storage. Therefore, journaling access paths, and before-images and after-images, usually does not cause additional performance overhead. However, they do add to the auxiliary storage requirements for journaling.

The system also spreads journal receivers across multiple disk units to improve performance. If you do not specify a maximum receiver-size option, then the system can place the journal receiver on up to ten disk units in a disk pool. If you specify a maximum receiver-size option, and a matching sufficiently large journal size threshold then the system can place the journal receiver on up to 100 disk units in a disk pool.

You can take measures to minimize the effect of journaling on your system performance:

- Consider using journal caching. Journal caching is a separately chargeable feature that causes the system to write journal entries to memory in large groups. When there are several journal entries in memory then the system writes journal entries from memory to disk. If the application performs a large number of changes, this can result in fewer synchronous disk writes resulting in improved performance. However, when you use journal caching, a few of the most recent updates to your journaled objects may be lost on an abnormal IPL or independent ASP vary on.
- Before using journal standby state, consider the potential System Managed Access Path Protection (SMAPP) impacts of making that choice and consider specifying INCACCPH(*ELIGIBLE) on the Change Recovery for Access Paths (CHGRCYAP) command.
- Do not set the force-write ratio (FRCRATIO) parameter for physical files that you are journaling. You can let the system manage when to write records for the physical file to disk because the journal receiver has a force-write ratio of 1.
- For optimal performance, ensure that your I/O processors have adequate write cache.

- Consider using record blocking when a program processes a journaled file sequentially (SEQONLY(*YES)). When you add or insert records to the file, the records are not written to the journal receiver until the block is filled. You can specify record blocking with the Override with Database File (OVRDBF) command or in some high-level language programs. If you use the OVRDBF command, do the following:
 - Set the SEQONLY parameter to (*YES).
 - Use a large enough value for the NBRRCDs parameter to make the buffer approach the optimal size of 128KB.
- Consider minimizing the fixed-length portion of the journal entry using RCVSIZOPT(*MINFIXLEN) for the journal. When you specify this option, all of the data that is selectable by the FIXLENDTA parameter is not deposited. Therefore, that information does not have to be retrieved, benefiting journal performance.
- Consider omitting information from the journal entry you do not need using the OMTJRNE parameter. When you specify the OMTJRNE parameter for database physical files you will not deposit the file open and close entries which saves processing as well as disk storage space. Similarly, if you specify the OMTJRNE parameter for directories and stream files, the object open, close, and force entries are not deposited.
- Ensure you have enough write cache for your I/O processor (IOP).

Related concepts

Receiver size options for journals

A journal receiver holds journal entries that you might use for recovery and entries that the system might use for recovery. For example, you might use record level entries, such as database record changes, and file level entries, such as the entry for opening or closing a file. Also, the system writes entries that you never see or use, such as entries for explicitly journaled access paths, for SMAPP, or for commitment control.

Journal cache

Journal caching is a separately chargeable feature with which you can specify that the system cache journal entries in main storage, before writing them to disk. Journal caching is option 42 of the IBM i operating system.

Frequently asked questions about journaling and disk arm usage

Journaling affects the disk arms that store the journal receiver.

Performance

Disk management

Striving for Optimal Journal Performance on DB2 Universal Database for iSeries

Related reference

Override with Database File (OVRDBF) command

Journal management with the save-while-active function

Journaling can help you with recovery if you use the save-while-active function in your backup strategy. If you plan to save an application without ending it for checkpoint processing, consider journaling all of the objects associated with the application. After the save operation is complete, save all of the journal receivers for the objects you are saving.

If you need to perform recovery, you can restore objects from the save-while-active media. Then you can apply journal changes to an application boundary.

You also can use the save-while-active function to save an object with partial transactions--before the transactions reach a commit boundary. When you restore an object with partial transactions, you cannot use it without additional actions. Journaling enables you to apply or remove changes to an object with partial transactions to restore it to a usable state.

Using the save-while-active function to save your journaled objects can help you recover your objects more quickly when you need to apply or remove journaled changes specifying FROMENT(*LASTSAVE) or FROMENTLRG(*LASTSAVE). When you use the save-while-active function to save your journaled objects,

the system saves and then restores information that indicates which starting journal sequence number is needed for the apply or remove operation. When this information is available for all objects to which you are applying or removing journaled changes, the system does not need to scan the journal receivers to determine this starting point. Scanning journal receiver data to find the starting points can be time consuming.

Also, using the save-while-active function when saving your objects allows you to restore a version of your object which was not from the last save and to still specify FROMENT(*LASTSAVE) or FROMENTLRG(*LASTSAVE) on the apply or remove command and successfully apply or remove changes.

Related concepts

[Commitment control](#)

Related tasks

[Save your server while it is active](#)

[Example: Recovering objects with partial transactions](#)

If you restore an object that was saved with a save-while-active operation that specified that the object can be saved before it reaches a commitment boundary, it can have partial transactions. To recover objects that are in a partial state you must perform an apply or a remove journaled changes operation.

Planning for journal management

This topic provides you with the information you need to ensure you have enough disk space, to plan what objects to journal, and to plan which journaling options to use.

Before you start to journal an object, you must make decisions that will determine how you will create journals and receivers, what objects to journal and how to journal those objects. These decisions include:

- Whether to use System i Navigator to set up your journaling environment.
- What objects to protect with journaling.
- Whether to journal other objects that the system does not journal.
- Whether to combine journaling with the save-while-active function.
- How many journals you need and which objects must be assigned to each journal.
- Whether to journal after-images only or both before-images and after-images.
- Whether your application programs must write journal entries to assist with recovery.
- What type of disk pool in which to store your journal receiver.
- Whether to use the remote journal function to replicate the journal entries and receivers to one or more additional systems.
- Whether to omit the optional open, close, or force entries for your objects.

You also need to make operational decisions about journal management:

- How often must journal receivers be changed and saved?
- How often must you save journaled objects?
- How must journals and journal receivers be secured?

Finally, you need to balance the benefits of journaling with the affect it may have on your system performance and auxiliary storage requirements.

Use the following information to help you make these decisions:

Note: The Remote journal management topic has information about remote journaling.

Related concepts

[Remote journal management](#)

Use remote journal management to establish journals and journal receivers on a remote system that are associated with specific journals and journal receivers on a local system. Remote journal management replicates journal entries from the local system to the journals and journal receivers that are located on the remote system after they have been established.

IBM Navigator for i versus the character-based interface for journaling objects

There are two environments that you can use for journal management: IBM Navigator for i and the character-based interface. Navigator for i provides a graphical interface for journaling that is easy to use and does not require the use of control language (CL) commands. The character-based interface requires the use of CL commands or APIs, but has more functionality than Navigator for i. Some of this function is also available through the System i Navigator.

Here is a list of journaling functions that are only available with the character-based interface:

- Journal access paths.
- Compare journal entries.
- Apply journaled changes.
- Remove journaled changes.
- Display journal entries.

One other difference between Navigator for i and the character-based interface is that with Navigator for i, you create the journal and journal receiver together. With the character-based interface, you create the journal receiver first.

Decide which of the two interfaces to use before you set up journal management, since the character-based interface creates journal receivers and journals separately, and Navigator for i creates journals and receivers together. However, if you decide to use a function that Navigator for i does not support after you start journaling, you can do so with the character-based interface, even if you used Navigator for i to set up journaling.

Related concepts

Receiver size options for journals

A journal receiver holds journal entries that you might use for recovery and entries that the system might use for recovery. For example, you might use record level entries, such as database record changes, and file level entries, such as the entry for opening or closing a file. Also, the system writes entries that you never see or use, such as entries for explicitly journaled access paths, for SMAPP, or for commitment control.

Minimized entry-specific data for journal entries

On the Create Journal (CRTJRN) and Change Journal (CHGJRN) commands, you can specify to allow for the deposit of minimized journal entries. This will decrease the size of your journal entries.

Fixed-length options for journal entries

You can use the Fixed Length Data (FIXLENTDA) parameter of Create Journal (CRTJRN) and Change Journal (CHGJRN) commands to audit security related activity for journaled objects on your system. The IBM Navigator for i equivalent function is **Fixed length data to include** on the **Create Journal** and **Change Receivers** dialogs.

Journal cache

Journal caching is a separately chargeable feature with which you can specify that the system cache journal entries in main storage, before writing them to disk. Journal caching is option 42 of the IBM i operating system.

Related tasks

Changing the state of local journals

Local journals can be in one of two states, active or standby. When the journal state of a local journal is active, journal entries are allowed to be deposited to the journal receiver.

Planning which objects to journal

When you plan which objects to journal, consider the following:

- What types of objects you can journal.
- What makes an object a good candidate for journaling.

- What rules for journaling apply to those objects.
- Whether or not to send journal entries for objects the system does not journal.

Types of objects that are eligible for journaling

You can journal the following object types:

- Libraries
- Database physical files
- Access paths
- Data areas
- Data queues
- Integrated file system objects (stream files, directories, and symbolic links)

General characteristics that make objects good candidates for journaling

- An object with a high volume of transactions between save operations is a good candidate for journaling.
- An object that is difficult to reconstruct the changes made to it, such as an object that receives many changes without physical documentation. For example, an object used for telephone order entry is more difficult to reconstruct than an object used for orders that arrive in the mail on order forms.
- An object that contains critical information. For example, if you restore an object back to the last save operation, and the delay from reconstructing changes to that object has a negative effect on your operation: that object is a good candidate for journaling.
- Objects that relate to other objects on the system. Although the information in a particular object may not change often, that object may be critical to other, more dynamic objects on the system. For example, many files may depend on a customer master file. If you are reconstructing orders, the customer master file must include new customers or changes in credit limits.
- Objects that require that all the actions on it be replicated.
- An object, that, after a crash, has a requirement to be recovered to a consistent state and have a journal entry show what actions completed.
- An object that can cause a negative consequence to your operation if a crash damages that object while the system is in the process of updating it.
- An object for which you want to have an audit trail of changes.

Considerations for journaling database physical files

- If you journal one file that participates in a referential constraint, you must journal all the related files. Referential constraints are not enforced when you apply or remove journaled changes, but the referential integrity of those constraints is verified.
- If you journal all related files, the process for applying and removing journaled changes keeps the relationships between your database files valid. If you do not journal all related files, your referential constraint may show a status of **check pending** after you apply or remove journaled changes. For some types of referential constraints, the system requires that you journal all of the related files.
- For a file that has a trigger program, if the trigger program only performs processing on object types which can be journaled and applied, you must journal all of the objects processed by the trigger program. If the trigger programs do additional work that must be reconstructed during a recovery, consider using the API support for sending journal entries.
- In general, database source files must not be journaled. If you use the Start Source Entry Utility (STRSEU) command to update a member, every record in that member is considered changed and every record is journaled to the journal. However, if changes to a source file are critical, you can journal the file in the same manner as data files.

Considerations for journaling integrated file system objects

- When you start journaling on a symbolic link, the link is not followed. Therefore if you want to protect the actual object with journaling, you have to journal the actual object separately.
- If you want to automatically protect all objects which are created in a directory which itself is journaled, consider the use and impacts of the inherit journaling attribute that you can associate with a journaled directory.
- Do you want to protect the structure of the directory tree, or just the data stored in stream files within that directory structure? If you just want to protect the data stored in stream files, then for performances reasons, it may be best to only journal the stream files themselves instead of journaling changes to each directory in the directory tree. You must consider this question when you use the subtree and inherit journaling attributes options on the start journaling interfaces.
- You cannot journal objects on a user-defined file system (UDFS) independent disk pool. If you want to journal objects in a UDFS, you must use a library capable independent disk pool. Journal management and independent disk pools has more information about journaling and independent disk pools.

System objects

It is recommended that you do not journal changes to IBM-supplied objects. The system sometimes creates and manages these objects differently than user-created objects. The system does not assure the recovery of these files even though all recovery activity normally succeeds.

Journal entries for objects the system does not journal

Some applications depend on information in objects that the system does not journal. For example, an application programming interface (API) might use a user space to pass data between two jobs.

You can use the Send Journal Entry (SNDJRNE) command or the Send Journal Entry (QJOSJRNE) API to write journal entries for these resources. If you need to perform recovery, you can use a program to retrieve these journal entries and make sure these application objects are synchronized with the objects you are journaling.

If you are using commitment control, you can use APIs to register these objects as committable resources.

Before images and access paths

- Reasons to journal access paths has detailed information about whether or not to journal access paths.
- Reasons to journal before-images discusses whether or not to journal before-images

Journaled object limit

The journaled object limit is the maximum number of objects that can be journaled to one journal. You can set the journal object limit to either 250 000 or 10 000 000. Use the **Journal Object Limit (JRNOBJLMT)** parameter on the **Create Journal (CRTJRN)** or **Change Journal (CHGJRN)** command to set the maximum number of journaled objects.

Journal recovery count

On the CHGJRN command, you can use the Journal Recovery Count (JRNR CYCNT) parameter to indicate how many journal entries can exist between the last deposited entry and the oldest forced entry for a journaled object. A value between 10 000 and 2 000 000 000 will be allowed. A value of *SYSDFT will also be allowed to reset the journal's recovery count to the system default journal recovery count.

Related concepts

[Journal management and independent disk pools](#)

Independent disk pools are disk pools 33 through 255. Independent disk pools can be user-defined file system (UDFS) independent disk pools or library-capable independent disk pools.

Sending your own journal entries

You can use the Send Journal Entry (SNDJRNE) command or the Send Journal Entry (QJOSJRNE) API to add your own entries to a journal. The system places these entries in the journal's attached journal receiver along with the system-created journal entries.

Commitment control

Related reference

Work with triggers and constraints

Reasons to journal access paths

If you journal access paths, the system can use the journal entries to recover access paths instead of rebuilding them completely.

When your system ends abnormally, perhaps because of a power interruption, the next IPL can take much longer than a normal IPL. Rebuilding access paths contributes to this long IPL time. When you perform an IPL after an abnormal end, the system rebuilds access paths that were exposed, except those access paths that are specified as MAINT(*REBLD) when you create the file. An access path is exposed if changes have been made to it that have not been written to the disk.

If you journal access paths, the system can use the journal entries to recover access paths instead of rebuilding them completely. This reduces the time it takes to IPL after the system ends abnormally. Access path journaling is strictly for the purpose of system recovery during an IPL. You do not use access path journal entries when you are applying journal changes to recover a file.

If certain access paths and their underlying files are critical to your operation, you want to ensure that these files are available as soon as possible after the system ends abnormally. You can choose to journal these access paths. This is called **explicit access path journaling**.

Explicit access path journaling differs system-managed access-path protection (SMAPP) in that with SMAPP you cannot control which access paths the system chooses to protect. Therefore, if the system does not protect the access path that you consider critical to meet your target recovery times, you must explicitly journal that access path.

If you choose to journal an access path, remember the following:

- You can journal an access path for a physical file only if the physical file has a keyed access path or an index created by a referential constraint.
- Before you start journaling an access path, you must journal all the underlying physical files to the same journal.
- You can journal only access paths that are defined as MAINT(*IMMED) or MAINT(*DLY).
- Some access paths with international components for unicode (ICU) sort sequence tables are too complex to be journaled. You can journal access paths with other sort sequence tables, and many of the access paths with ICU sort sequence tables.

The System-managed access-path protection topic has detailed information about SMAPP.

Related concepts

System-managed access-path protection

System-managed access-path protection (SMAPP) allows you to use some of the advantages of journaling without explicitly setting up journaling. Use SMAPP to decrease the time it takes to restart your system after an abnormal end.

Reasons to journal before-images

When you journal an object, the system always writes an after-image for every change that is made. You can request that the system write before-image journal entries for database files and data areas. All other object types only journal after-images. This significantly increases the auxiliary storage requirements for journaling.

However, you can choose to journal before-images for these reasons:

- Before-images are required for a backout recovery, where you remove journal changes with the Remove Journalized Changes (RMVJRNCHG) command rather than applying journal changes to a restored copy of an object. Backout recovery is often complex, particularly if multiple users and programs are accessing the same object. It is most commonly used when new applications or programs are being tested.
- For database physical files, before-images are required to use the Compare Journal Images (CMPJRNIMG) command. This command highlights the differences between the before-images and after-images. It is sometimes used to audit changes to a database file.
- For database physical files, if you want a copy of the record that is deleted to be part of the deleted record journal entry information, you must specify before-images.
- Commitment control requires before-images for the system to roll back uncommitted changes. When you open a database file under commitment control, the system automatically journals both before-images and after-images while the commitment definition is active. If you normally journal only after-images, the system writes before-images only for the changes made under commitment control. If the system initiates the journaling of before-images, you cannot use them to remove journalized changes. Commitment control does not support integrated file system objects, data areas, or data queues.
- Access path journaling also requires before-images for the system to use for IPL recovery. When you journal access paths, or the system journals an access path to provide system-managed access-path protection, the system will automatically journal both before and after-images. If you normally journal only after-images, the system also writes before-images if you are journaling the access path.

You can select before-images on an object-by-object basis. You specify whether you want after-images or both when you start journaling for a database file or a data area. After you start journaling a database file or a data area, you can use the Change Journal Object (CHGJRNOBJ) command to change whether you are journaling before-images.

Related concepts

System-managed access-path protection

System-managed access-path protection (SMAPP) allows you to use some of the advantages of journaling without explicitly setting up journaling. Use SMAPP to decrease the time it takes to restart your system after an abnormal end.

Related tasks

Journaling database physical files (tables)

When you start journaling a physical file (table), you specify whether you want after-images saved, or both before-images and after-images.

Journaling data areas and data queues

When you start journaling for a data area or a data queue, the system writes journal entries for all changes to the data area or data queue.

Related reference

Remove Journalized Changes (RMVJRNCHG) command

Compare Journal Images (CMPJRNIMG) command

Change Journalized Object (CHGJRNOBJ) command

Planning for journal use of auxiliary storage

If you are journaling an object, journal management writes a copy of every object change to the journal receiver. It writes additional entries for object level activity, such as opening and closing the object, adding a member, or changing an object attribute. If you have a busy system and journal many objects, your journal receivers can quickly become very large.

The maximum size for a single journal receiver varies. It depends on how the system allocates the journal receiver across multiple disk arms. The maximum size ranges from approximately 1.9 GB to 1.0 TB depending on what value you specified for the associated journal's receiver size option.

To avoid possible problems with a journal receiver exceeding the maximum size allowed on the system, specify a threshold for the receiver of no more than 900 000 000 KB if you specified a journal

receiver maximum-size option for the associated journal. Otherwise, specify a threshold of no more than 1 441 000 KB.

The following topics provide more information about how journal management affects auxiliary storage:

- Functions that increase the journal receiver size
- Methods to estimate the size of a journal receiver
- Methods to reduce the storage that journal receivers use
- Determine the type of disk pool in which to place journal receivers
- Journals and independent disk pools

Related concepts

Receiver size options for journals

A journal receiver holds journal entries that you might use for recovery and entries that the system might use for recovery. For example, you might use record level entries, such as database record changes, and file level entries, such as the entry for opening or closing a file. Also, the system writes entries that you never see or use, such as entries for explicitly journaled access paths, for SMAPP, or for commitment control.

Threshold (disk space) for journal receivers

When you create a journal receiver with System i Navigator or the Create Journal Receiver (CRTJRNRCV) command, you specify a disk space threshold that indicates when you want the system to warn you or take action.

Frequently asked questions about journaling and disk arm usage

Journaling affects the disk arms that store the journal receiver.

How the journal receiver affects the disk arm depend on several factors :

- The threshold setting you are using for your journal receiver.
- Whether or not you are using a maximum receiver-size option.
- The way in which the system writes journal entries to disk.

The following are frequently asked questions about journaling and disk arm usage:

[“How many arms in my disk pool will journaling use?” on page 22](#)

[“Which journal parameters and settings affect the number of the disk arms the journal receiver uses?” on page 23](#)

[“Why is the system not using the new disk arms I added to my disk pool?” on page 23](#)

[“Why are some disk arms used by journal receivers noticeably busier than the others and what can I do to spread out the usage?” on page 23](#)

How many arms in my disk pool will journaling use?

Starting in IBM i 7.1, journal receivers will be spread across all disk arms in the disk pool. Journaling no longer directs writes to specific disk arms.

The journal receiver threshold value will influence the number of parallel writes that journal will allow. The higher the journal receiver threshold value, the more parallel I/O requests will be allowed. Allowing more parallel I/O requests may improve performance.

For more information about disk arm use and journaling see: [Striving for Optimal Journal Performance on](#)

[DB2® Universal Database for iSeries](#)  (3.1 MB)

Back to questions

Which journal parameters and settings affect the number of the disk arms the journal receiver uses?

The threshold for the journal receiver and whether you use a maximum receiver-size option have the largest effect on how many disk arms the journal receiver uses. If you have a system which is before V5R2, removing internal entries also affects the number of disk arms that are used.

[Back to questions](#)

Why is the system not using the new disk arms I added to my disk pool?

There can be a several reasons. First, to use the newly added disk arms, you must perform a change journal operation to attach a new journal receiver. Also, the system does not necessarily use all of the disk arms in a disk pool. If you are not using a maximum receiver-size option, the most disk arms the system will spread the receiver over is ten. The number of disk arms the receiver uses also depends on the threshold you use for your journal receiver. If you use a maximum receiver-size option and increase your threshold, it is more likely that your new disk arm will be used.

If you use system-managed access-path protection (SMAPP), the system generates internal journal entries to protect the access paths for database files. If you have not upgraded to at least V5R2, setting your journal receiver to remove internal entries is an issue if you are not producing these internal entries. Before V5R2, removing internal entries can steal disk arms from the normal journal entries. For example, if you have six disk arms in the disk pool housing your journal receiver and remove internal entries, two arms are dedicated to the internal entries and four arms are used for your regular journal entries. If you do not produce any internal entries, those two arms remained idle. For V5R2 and later, this is not an issue.

For more information about disk arm use and journaling see [Striving for Optimal Journal Performance on DB2 Universal Database for iSeries](#).

[Back to questions](#)

Why are some disk arms used by journal receivers noticeably busier than the others and what can I do to spread out the usage?

The journal receivers probably use some disk arms more than other because of the way journal management writes journal entries to disk. When the system produces journal entries, journal management stores the journal entries in memory. When it is ready, journal management sends the journal entries to a disk arm in one group. When the next group of journal entries are ready, journal management sends the entries to the next disk arm. Journal management continues in this sequential manner until all of the disk arms it uses have received a group of journal entries. The cycle then repeats.

You can spread out the usage by increasing your threshold and using a maximum receiver-size option.

For more information about disk arm use and journaling see [Striving for Optimal Journal Performance on DB2 Universal Database for iSeries](#).

[Back to questions](#)

Related concepts

[Threshold \(disk space\) for journal receivers](#)

When you create a journal receiver with System i Navigator or the Create Journal Receiver (CRTJRNRCV) command, you specify a disk space threshold that indicates when you want the system to warn you or take action.

[Receiver size options for journals](#)

A journal receiver holds journal entries that you might use for recovery and entries that the system might use for recovery. For example, you might use record level entries, such as database record changes, and file level entries, such as the entry for opening or closing a file. Also, the system writes entries that you never see or use, such as entries for explicitly journaled access paths, for SMAPP, or for commitment control.

Functions that increase the journal receiver size

Some optional functions available with journal management can significantly increase auxiliary storage requirements.

You can select to journal both before-images and after-images. The system uses more storage if you select both before-images and after-images, although storage use is not necessarily doubled. If you journal access paths, the before-images and after-images are written to the journal receiver when a database file is updated. Only after-images are written when a database file is added (write operation) or deleted. Neither the before-image nor after-image is deposited into the journal if the after-image is exactly the same as the before-image.

Using Fixed-length options for journal entries can also increase auxiliary storage requirements. The additional storage that fixed-length options use is similar to the extra space that is used by journaling both before-images after-images.

The system requires additional space to journal access paths. The space required depends on the following items:

- How many access paths are journaled.
- How often you change the access paths. When you update a record in a database file, you cause an access path journal entry only if you update a field included in the access path.
- The method used to update access paths. More journal entries are written if you update access paths randomly than if you update them in ascending or descending sequence. Doing a mass change to an access path field, such as a date change, causes the fewest journal entries.

If you are using system-managed access-path protection and you journal database files, the system uses the same journal receiver to protect access paths for that file. This also increases the size of your journal receivers.

The information in Methods to estimate a journal receiver will help you predict your requirements for auxiliary storage.

Related concepts

Fixed-length options for journal entries

You can use the Fixed Length Data (FIXLENDTA) parameter of Create Journal (CRTJRN) and Change Journal (CHGJRN) commands to audit security related activity for journaled objects on your system. The IBM Navigator for i equivalent function is **Fixed length data to include** on the **Create Journal** and **Change Receivers** dialogs.

System-managed access-path protection

System-managed access-path protection (SMAPP) allows you to use some of the advantages of journaling without explicitly setting up journaling. Use SMAPP to decrease the time it takes to restart your system after an abnormal end.

Related tasks

Methods to estimate the size of a journal receiver

You can estimate the effect that a journal receiver has on auxiliary storage.

Methods to estimate the size of a journal receiver

You can estimate the effect that a journal receiver has on auxiliary storage.

The actual auxiliary storage used will be somewhat larger because the system writes additional entries for such actions as opening and closing objects, unless you omit open and close journal entries when you start journaling for database physical files or integrated file system objects.

The first method to estimate the size of a journal receiver is to use a journal receiver calculator. The Journal receiver calculator provides an easy way for you to estimate the size of your journal receiver without setting up journaling.

The calculator assumes the following:

- You are journaling after-images only.
- You are using a single journal receiver for an entire day's transactions.

- You are journaling database physical files only. It does not include estimates for libraries, access path journaling, integrated file system objects, data areas, data queues, or user-created entries.
- You are not minimizing entry-specific data for the files.

Another method for estimating the size of the journal receiver is to run a test. This method is more accurate because it includes all journal entries. Additionally, this method will work for any object type which can be journaled, not just database physical files unlike method one. To use this method, you must either have journaling set up already or you must set it up.

If you are already using journaling, skip steps 1 and 2 below. Instead, issue a Display Journal Receiver Attributes (DSPJRNRCVA) command before the time period so you can compare sizes from the beginning of the period to the end.

This method assumes that the same receiver is used during the whole test. If there is a change journal to attach a new journal receiver during the test, you must include the sizes of all the receivers.

1. Set up journaling by creating the receiver and journal.
2. Start journaling for all the objects that you plan to journal.
3. Choose a time period (1 hour) with typical transaction rates.
4. After one hour, use the Display Journal Receiver Attributes (DSPJRNRCVA) command to display the size of the receiver.
5. Multiple the size by the number of hours that your system is active in a day.

Related concepts

Minimized entry-specific data for journal entries

On the Create Journal (CRTJRN) and Change Journal (CHGJRN) commands, you can specify to allow for the deposit of minimized journal entries. This will decrease the size of your journal entries.

Related tasks

Journaling database physical files (tables)

When you start journaling a physical file (table), you specify whether you want after-images saved, or both before-images and after-images.

Journaling integrated file system objects

You can journal integrated file system objects if they are in the "root"(/), QOpenSys, and user-defined file systems.

Setting up journaling

This topic provides instructions on how to set up journals and journal receivers.

Starting journaling

This topic provides information about how to start journaling for all object types.

Related reference

Display Journal Receiver Attributes (DSPJRNRCVA) command

Journal sizing and planning tool

This tool allows one to predict the journal traffic that will be generated by journaling one or more database files.

On the IBM DB2 for i : Journal performance tools and utilities page there is a tool that can be used to help determine the amount of journal traffic that might be generated by journaling one or more files. It only predicts the traffic for database files, not for any other object types. On that page under the **Journal Sizing and Planning Tool (Pseudo Journal)**, you will find:

- Installation guide
- Tutorial
- Save file download for installation

To access follow this link-><http://www.ibm.com/systems/i/software/db2/journalperfutilities.html>

Estimating the size of the journal receiver manually

This topic provides instructions for estimating the size of your journal receiver.

This procedure assumes the following:

- You are journaling after-images only.
- You are using a single journal receiver for an entire day's transactions.
- You are journaling database physical files only. It does not include estimates for libraries, access path journaling, integrated file system objects, data areas, data queues, or user-created entries.
- You are not using the MINENTDTA parameter to minimize entry-specific data for the files.
- Most of the journal entries are record-level (changes to records in a file) instead of object-level (like renaming or moving objects, ALTER TABLE requests, creating and deleting objects, etc).

Follow the steps below to estimate the size of a journal receiver:

1. Determine the average record length for all the files that you plan to journal. If the record lengths vary significantly and the information is available, use a weighted average based on the relative number of transactions per file.
2. If you are not minimizing the fixed-length portion of the journal entry (not specifying RCVSIZOPT(*MINFIXLEN) on the CRTJRN command), you can specify the data that is included in the fixed-length portion (FIXLENDTA) of the journal entries. Find the sum of the bytes for the options you are using. Select the options from the following list:

- *JOB = 26 bytes
- *USR = 10 bytes
- *PGM = 10 bytes
- *PGMLIB = 22 bytes
- *SYSSEQ = 8 bytes
- *RMTADR = 20 bytes
- *THD = 8 bytes
- *LUW = 27 bytes
- *XID = 140 bytes

3. Estimate the number of transactions for a day.
4. The system-created portion of a journal entry is approximately 50 bytes. (It varies by the type of journal entry.)
5. Estimate the number bytes of auxiliary storage needed for one day's transactions by using the following formula:

```
Total bytes needed = (a+b+50)*c
```

where:

- a = the average record length of files (step 1)
- b = sum of values selected for FIXLENDTA (step 2)
- c = number of transactions for a day (step 3)

For example:

1. The average record length for journaled files is 115 bytes.
2. *JOB, *USR, and *PGM options of FIXLENDTA are selected. Their sum is 46 bytes.
3. The number of journaled transactions per day is 10 000.
4. The total bytes needed to journal after-images for a day is:

```
(115+46+50) * 10 000 = 2 110 000
```

Related concepts

[Fixed-length options for journal entries](#)

You can use the Fixed Length Data (FIXLENDTA) parameter of Create Journal (CRTJRN) and Change Journal (CHGJRN) commands to audit security related activity for journaled objects on your system. The IBM Navigator for i equivalent function is **Fixed length data to include** on the **Create Journal** and **Change Receivers** dialogs.

Methods to reduce the storage that journal receivers use

Reduce the size of journal entries by methods such as journaling after-images only, or specifying certain journaling options including the Fixed Length Data (FIXLENDTA) option on the **Create Journal (CRTJRN)** and **Change Journal (CHGJRN)** commands.

Methods to reduce the storage needed for journaling are as follows:

Journal after-images only

Unless you are using commitment control, after-images are sufficient for your recovery needs. When you start journaling, the default is to journal after-images only. You can use the **Change Journal Object (CHGJRNOBJ)** command to stop journaling before-images without ending journaling for that object.

Omit the journal entries for open, close or force operations to journaled objects

You can omit these journal entries with the OMTJRNE parameter on the **Start Journal Physical file (STRJRNPF)** or **Start Journal (STRJRN)** command. For database files (tables), you can select **Exclude open and close entries** when you start journaling with System i Navigator. For integrated file system objects, ensure that **Include open, close, and synchronization entries** is not selected when you start journaling with System i Navigator. You can also use the **CHGJRNOBJ** command to start omitting these journal entries for objects that you are currently journaling.

Omitting these journal entries can have a noticeable effect on both space and performance if an application opens, closes, or forces objects frequently. Also, any time one looks up an object in a directory, that can cause an open and close entry to occur for that directory. This can be a lot of additional journal entries if they are not omitted from the directory objects. However, if you omit the journal entries for opening and closing objects, you cannot perform the following tasks:

- Use open and close boundaries when applying or removing journal changes (the TOJOB0 and TOJOB0C parameters).
- Audit which users open particular objects.

Swap journal receivers, save them, and free storage more frequently

Frequently saving and freeing storage for journal receivers help reduce the auxiliary storage that the receivers use. However, moving journal receivers off-line increases your recovery time because receivers have to be restored before journal changes can be applied.

Specify receiver size options that can decrease journal receiver size

Specifying the following receiver size options can help reduce journal receivers size:

- Remove internal entries. This causes the system to periodically remove internal entries that it no longer needs, such as access path entries.
- Minimize the fixed-length portion the journal entry. This causes the system to no longer deposit all of the data selectable by the FIXLENDTA parameter in the journal entry, thus reducing the size of the entries. However, if you require this journal entry information for audit or other uses, you cannot use this storage saving technique. Additionally, it reduces the options available as selection criteria used on the following commands and API:
 - **Display Journal (DSPJRN)** command
 - **Receiver Journal Entry (RCVJRNE)** command
 - **Retrieve Journal Entry (RTVJRNE)** command
 - **Compare Journal Images (CMPJRNIMG)** command
 - **Apply Journaled Changes (APYJRNCHG)** command
 - **Apply Journaled Changes Extend (APYJRNCHGX)** command
 - **Remove Journaled Changes (RMVJRNCHG)** command

– Retrieve Journaled Entries (QjoRetrieveJournalEntries) API

Minimized entry-specific data for journals

Minimizing entry-specific data allows the system to write data to the journal entries in a minimized format.

Select the fixed-length options for data carefully

Fixed-length options can quickly increase the size of your journal receiver. The journal receiver calculator can help you determine the effect of fixed-length options on your auxiliary storage.

If you are journaling a physical file, specify SHARE(*YES) for the file.

You can do this using the **Create Physical File (CRTPF)** command or the **Change Physical File (CHGPF)** command. The system writes a single open and close entry regardless of how often the shared open data path (ODP) is opened or closed within a routing step.

Related concepts

Receiver size options for journals

A journal receiver holds journal entries that you might use for recovery and entries that the system might use for recovery. For example, you might use record level entries, such as database record changes, and file level entries, such as the entry for opening or closing a file. Also, the system writes entries that you never see or use, such as entries for explicitly journaled access paths, for SMAPP, or for commitment control.

Fixed-length options for journal entries

You can use the Fixed Length Data (FIXLENTA) parameter of Create Journal (CRTJRN) and Change Journal (CHGJRN) commands to audit security related activity for journaled objects on your system. The IBM Navigator for i equivalent function is **Fixed length data to include** on the **Create Journal** and **Change Receivers** dialogs.

Determining the type of disk pool in which to place journal receivers

Use disk pools (auxiliary storage pool) to control which objects are allocated to which groups of disk units. If you are journaling many active objects to the same journal, the journal receiver can become a performance bottleneck. One way to minimize the performance impact of journaling is to put the journal receiver in a separate disk pool. This also provides additional protection because your objects are on different disk units from the journal receiver, which contains a copy of changes to the objects.

There are several types of disk pools:

System disk pool

The system disk pool contains the operating system. It can also contain user libraries and objects. The system disk pool is always disk pool number 1.

Basic disk pool

Basic disk pools are disk pool numbers 2 through 32. A basic disk pool can be a library or a non library disk pool. The differences are as follows:

- A library disk pool contains one or more user libraries or user-defined file systems. It does not contain the operating system. This is the current recommended method of configuring user disk pools.
- A non library disk pool contains no user libraries or user-defined file systems. It may contain journals, journal receivers, and save files. If you place a journal receiver in a non library basic disk pool, the journal must be in either the system disk pool or the same non library disk pool. The journaled objects must be in the system disk pool.

Independent disk pool

Independent disk pools are disk pools 33 through 255. If you use independent disk pools, you can only put journals and journal receivers on independent disk pools that are library capable. If you are going to place the journal receiver in a switchable independent disk pool, the journal receiver, the journal, and journaled object must be in the same disk pool group (though they do not have to be in the same disk pool).

When disk pools were first introduced, they were called auxiliary storage pools (ASPs). Only non library user ASPs were available. Many systems still have this type of ASP. However, recovery steps are more

complex for non library user ASPs. Therefore, for systems implementing journaling for the first time, library disk pools are recommended.

Journal management and independent disk pools has more specific information about using journaling with independent disk pools. Manage disk units in disk pools has specific information about disk pools. The Independent disk pools topic has detailed information about setting up independent disk pools.

Related concepts

[Journal management and independent disk pools](#)

[Independent disk pools are disk pools 33 through 255. Independent disk pools can be user-defined file system \(UDFS\) independent disk pools or library-capable independent disk pools.](#)

[Managing independent disk pools](#)

[Independent disk pools](#)

Related information

[Journaling – User ASPs Versus the System ASP](#)

[Journaling – Configuring for Your Fair Share of Write Cache](#)

Journal management and independent disk pools

Independent disk pools are disk pools 33 through 255. Independent disk pools can be user-defined file system (UDFS) independent disk pools or library-capable independent disk pools.

UDFS and library-capable independent disk pools

UDFS independent disk pools are independent disk pools that only have a user-defined file system. UDFS independent disk pools cannot store journals and receivers. In contrast to UDFS disk pools, library-capable independent disk pools have libraries and are capable of storing journals and receivers. If you plan to journal objects on an independent disk pool, you must use a library-capable independent disk pool.

Note: A library-capable independent disk pool can have integrated file system objects. You can also journal integrated file system objects on a library-capable independent disk pool.

You cannot journal objects on a UDFS independent disk pool.

Switchable and dedicated independent disk pools

Independent disk pools can also be switchable or dedicated. Dedicated independent disk pools are used on only one system. Switchable independent disk pools can be switched between systems. If they are library-capable, you can journal objects on either switchable or dedicated independent disk pools.

Disk pool groups

You can group switchable independent disk pools into disk pool groups. Disk pool groups consist of one primary disk pool and one or more secondary disk pools. If you are going to journal an object in a disk pool group, the object and the journal must be in the same disk pool. The journal receiver can be in a different disk pool, but must be in the same disk pool group as the journal and journaled object.

Rules for journaling objects on independent disk pools

Use the following rules when journaling objects on independent disk pools:

- The disk pool must be available on the system on which you are working.
- The disk pool must be a library-capable disk pool. You cannot journal an object on a UDFS independent disk pool.
- In a disk pool group, the journaled object and the journal must be in the same disk pool.
- In a disk pool group, the journal receiver can be in a different disk pool, but must be in the same disk pool group.

Manage disk units in disk pools has information about managing disk pools. The Independent disk pools topic has information about setting up and managing independent disk pools.

Related concepts

[User-defined file system](#)

[Disk management](#)

[Independent disk pools](#)

Planning setup for journal receivers

The following topics provide information to plan configuration for journal receivers. They provide information about each option that you can select for journal receivers.

Disk pool assignment for journal receivers

Placing journal receivers in a different disk pool from the journaled objects may prevent performance bottlenecks.

Before you place the journal receiver in a library basic disk pool, you must first create the library for the journal receiver in the disk pool.

You can only place a journal receiver in an independent disk pool if the independent disk pool is library capable. If you are placing the journal receiver in a switchable independent disk pool, you must place it in the same disk pool group as the journal and the object you are journaling. Manage disk units in disk pools has more information about disk pools. The Independent disk pools topic has detailed information about independent disk pools.

If you are creating the journal receiver with the Create Journal Receiver (CRTJRNRCV) command, you can use the ASP parameter to allocate storage space for the journal receiver in a different disk pool (ASP) than the library to which you assigned the journal receiver. Do this only if the disk pool is a basic nonlibrary disk pool.

Related concepts

[Managing independent disk pools](#)

[Independent disk pools](#)

Related reference

[Create Journal Receiver \(CRTJRNRCV\) command](#)

Library assignment for journal receivers

When you create a journal receiver, you specify a qualified name that includes the library for the receiver. The library must exist before you create the journal receiver.

You can assign a library from either the **New Journal** dialog in System i Navigator or with the Create Journal Receiver (CRTJRNRCV) command.

Your journals and journal receivers can be in different libraries. If they are, you must ensure that the library that will contain the journal receivers is on the system before restoring the journal. Ensuring this will also ensure that the journal receiver is created in the desired library, since a journal receiver is created when the journal is restored. Only the library needs to be on the system, not the journal receivers in that library. Also, you will want to save the library with the journal receivers last (after all journaled objects have been saved) to ensure that all the journal entries recording the object saves will be on media.

Refer to the Correct order for restoration of journaled objects link below for additional considerations.

Related tasks

[Correct order for restoration of journaled objects](#)

You must restore journals and their associated objects in the correct order when not using deferred journaling support.

Related reference

[Create Journal Receiver \(CRTJRNRCV\) command](#)

Naming conventions for journal receivers

When you create a journal receiver either with System i Navigator or the Create Journal Receiver (CRTJRNRCV) command, you assign a name to the journal receiver.

When you use System i Navigator or the Change Journal (CHGJRN) command to detach the current journal receiver and create and attach a new receiver, you can assign a name or have the system generate one. If you use system journal-receiver management, the system generates the name when it detaches a receiver and creates and attaches a new one.

If you plan to have more than one journal on your system, use a naming convention that links each journal with its associated receiver.

To simplify recovery and avoid confusion, make each journal receiver name unique for your entire system, not unique within a library. If you have two journal receivers with the same name in different libraries and they both become damaged, the reclaim storage operation renames both journal receivers when they are placed in the QRCL library. When you use the Move Object (MOV OBJ) command for a journal or journal receiver in the QRCL library, you can move an object from QRCL back to its original library. You cannot change the name of the journal or the journal receiver.

When you detach the receiver from the journal and attach a new one, you can have the system generate the name for the new receiver by incrementing the previous receiver name. If you use system change-journal management by specifying MNGRCV(*SYSTEM) for the journal, the system also generates a new receiver name when it changes journal receivers. The default for the Create Journal (CRTJRN) command is to use system change-journal management.

The following table shows the rules the system uses to generate a new receiver name. It applies these rules in the sequence shown in the table.

| Current name | System action | Example |
|---|---|-------------------------|
| Last 4 characters are numeric. | Adds 1 | DSTR0001 to DSTR0002 |
| Last character is not numeric. | Truncates the name to 6 characters, if necessary. Adds 0001 | DSTRCVR to DSTRCV0001 |
| Last character is numeric. Last non-numeric character is in position 5 or less. | Adds 1 | DSTR01 to DSTR02 |
| Last character is numeric. Last non-numeric character is in position 6 or higher. | Truncates to 6 characters, if necessary. Adds 0001. | DSTRCVR01 to DSTRCV0001 |

If you restore a journal to your system, the system creates a new journal receiver and attaches it to the journal. The system generates a name for the new journal receiver based on the name of the journal receiver that was attached when the journal was saved. The following table shows the rules the system uses to generate a new receiver name when you restore a journal:

| Current name | System action | Example |
|---|--|-------------------------|
| Last 4 or more characters are numeric. | Adds 1 to the leftmost digit of the numeric portion. | DSTR0001 to DSTR1001 |
| Last character is not numeric. | Truncates to six characters, if necessary. Adds 1000. | DSTRCVR to DSTRCV1000. |
| Ending numeric portion is less than 4 digits. | Pads the left portion of the numeric portion with zeroes to create a 4-digit suffix. Adds 1 to the leftmost digit. | DSTRCV01 to DSTRCV1001. |

If the name generated by the system is the same as the name of a journal receiver already on the system, the system adds 1 to the name until it creates a name that is not a duplicate. For example, assume a journal receiver named RCV1 was attached when the journal was saved. When the journal is restored, the system attempts to create a new journal receiver named RCV1001. If that name already exists, the system tries the name RCV1002.

The following table shows examples of how the system generates new receiver names:

| Last journal receiver known to the system ¹ | Created by change journal ² | Created by restoring journal |
|---|--|------------------------------|
| A | A0001 | A1000 |
| ABCDEF | ABCDEF0001 | ABCDEF1000 |
| ABCDEFG | ABCDEF0001 ³ | ABCDEF1000 ³ |
| ABCDEF1234 | ABCDEF1235 | ABCDEF2234 |
| A0001 | A0002 | A1001 |
| A1 | A2 | A1001 |
| A9 | A10 | A1009 |
| ABCDEF7 | ABCDEF0001 ³ | ABCDEF1007 ³ |
| ABCDEF9999 | Error ⁴ | ABCDEF0999 |
| A1B15 | A1B16 | A1B1015 |
| <p>Notes:</p> <p>¹If the journal exists on the system, the last journal receiver known to the system is the journal receiver that is currently attached. If the journal does not exist, the last journal receiver known to the system is the journal receiver that was attached when the journal was saved.</p> <p>²Either when a user issues the CHGJRN command with JRNRCV(*GEN) or when the journal is changed by system change-journal management.</p> <p>³The last character of the current name is dropped because it exceeds 6 characters.</p> <p>⁴If the journal is set up as MNGRCV(*SYSTEM), the receiver name wraps around to 0's (ABCDEF0000). If the journal is set up as MNGRCV(*USER), an error occurs because adding 1 to 9999 causes an overflow condition.</p> | | |

Related concepts

Manual versus system journal-receiver management

When you create a journal with System i Navigator or the Create Journal (CRTJRN) command, you can select to have either system managed or user managed journal receivers.

Threshold (disk space) for journal receivers

When you create a journal receiver with System i Navigator or the Create Journal Receiver (CRTJRNRCV) command, you specify a disk space threshold that indicates when you want the system to warn you or take action.

On the CHGJRN command, you can use the Journal Receiver Threshold (THRESHOLD) parameter to change the next receiver's threshold when specified in combination with JRNRCV(*GEN).

When the receiver reaches that threshold, the system takes the action specified in the manage receiver (MNGRCV) parameter for the journal. The default storage threshold is 1 500 000 KB.

In specifying a storage threshold, you need to balance the amount of space that you have available with the additional system resources that are used to change journal receivers frequently.

Related concepts

Receiver size options for journals

A journal receiver holds journal entries that you might use for recovery and entries that the system might use for recovery. For example, you might use record level entries, such as database record changes, and file level entries, such as the entry for opening or closing a file. Also, the system writes entries that you never see or use, such as entries for explicitly journaled access paths, for SMAPP, or for commitment control.

Manual versus system journal-receiver management

When you create a journal with System i Navigator or the Create Journal (CRTJRN) command, you can select to have either system managed or user managed journal receivers.

Related tasks

Methods to estimate the size of a journal receiver

You can estimate the effect that a journal receiver has on auxiliary storage.

Related reference

Create Journal Receiver (CRTJRNRCV) command

Basing the size on your available auxiliary storage

This topic lists the steps necessary to determine a receiver threshold, based on the amount of auxiliary storage available for use.

Base the size on your available auxiliary storage:

1. Calculate the amount of auxiliary storage space that you have available in the user ASP for the journal receiver.
2. Assign a receiver threshold that is 75 to 80 percent of that space.

Basing the size on how often you want to change journal receivers

This topic lists the steps necessary to determine a receiver threshold, based on how often you want to change journal receivers.

Base the size on how often you want to change journal receivers:

1. Use the one of the methods described in Methods to estimate the size of a journal receiver to calculate how large your receiver can be for a day. If you are just journaling database physical files, you can use the Journal receiver calculator to estimate the size of your journal receiver.
2. Determine how many times a day you will detach and save the journal receiver.
3. Divide the result of step 1 by the result of step 2. This is your receiver threshold.

Do not make the journal receiver size too small, or the system will spend too much resource changing journal receivers or sending threshold messages. To avoid possible problems with a journal receiver exceeding the maximum size allowed on the system, specify a threshold for the receiver of no more than 900 000 000 KB if you specify a maximum receiver-size option for the associated journal. Otherwise, specify a threshold of no more than 1 441 000 KB.

Manual versus system journal-receiver management discusses options for managing your journal receivers.

Security for journal receivers

If a journal receiver has confidential data, someone with authority to that journal receiver could possibly display that confidential data.

When you create a journal receiver, you specify the authority that all users on the system have to access it (public authority). The default authority for the **Create Journal Receiver (CRTJRNRCV)** command is *LIBCRTAUT, which means the system uses the value of the create authority (CRTAUT) parameter for the journal receiver's library.

Journal receivers contain copies of changes from all objects being journaled. Someone with access to the journal receiver could display confidential data. The authority to a journal receiver must be as strict as the authority for the most confidential object that is being journaled.

You do not need any authority to the journal or to the journal receiver to use an object that is journaled. Authority to the journal receiver is checked only when using commands that operate directly on the receiver. The authority you set for the journal receiver has no effect on the people using the journaled objects.

Related concepts

[Security](#)

Related reference

[Create Journal Receiver \(CRTJRNRCV\) command](#)

Related information

[Security Reference](#)

Planning setup for journals

The following topics provide information to plan configuration for journals. They provide information about each option that you can select for journal.

Disk pool assignment for journals

If you want to place the journal in a library basic disk pool, you must first create the library for the journal in the disk pool. If you use a library basic disk pool, the journal and all the objects you are journaling to it must be in the same library basic disk pool.

You can only place a journal in an independent disk pool if the independent disk pool is library capable. If you are placing the journal in a switchable independent disk pool, you must place it in the same disk pool group as the journal receiver associated with the journal. Manage disk units in disk pools has more information about disk pools. The Independent disk pools topic has information about independent disk pools.

If you want to place the journal in a non library basic disk pool, you must first create the library for the journal in the system disk pool. If the journal is in a non library basic disk pool, all the objects being journaled to it must be in the system disk pool.

If you are creating the journal with the Create Journal (CRTJRN) command, you can use the ASP parameter to allocate storage space for the journal in a different disk pool (ASP) than the library to which you assigned the journal. Do this only if the disk pool is a basic nonlibrary disk pool.

Related concepts

[Managing independent disk pools](#)

[Independent disk pools](#)

Related reference

[Create Journal \(CRTJRN\) command](#)

Library assignment for journals

When you create a journal, you specify a qualified name that includes the library for the journal. The library must exist before you create the journal.

You can assign a library from either System i Navigator or with the Create Journal (CRTJRN) command.

Related reference

[Create Journal \(CRTJRN\) command](#)

Naming conventions for journals

When you create a journal with System i Navigator or the Create Journal (CRTJRN) command, you assign a name to it. If you plan to have more than one journal on your system, use a naming convention that links each journal with its associated receiver.

To simplify recovery and avoid confusion, make each journal name unique for your entire system, not unique within a library. If you have two journals with the same name in different libraries and they both become damaged, the reclaim storage operation renames both journals when they are placed in the QRCL library. When you use the Move Object (MOV OBJ) command for a journal in the QRCL library, you can

change the name of the library back to the original library name. You cannot change the name of the journal itself. In this case, you would not be able to recover your journal from QRCL since its name has been changed.

Naming conventions to ensure restore sequence

Name the libraries for the journals, objects, and journal receivers to ensure that the objects are restored in the correct order. A naming convention will ensure that the system automatically starts journaling after a restore operation. To ensure that journaling is automatically started again, the journals must be restored before the objects being journaled, unless defer object journaling during restore is specified. (If the journals and associated objects are in the same library, then the system automatically restores the objects in the correct order.)

If you start the name of the library for the journal with a special character, such as #, \$, or @, the system will restore the library for the journal before the library for the objects. This is because in normal sort sequence, special characters appear before alphabetic characters.

When the journals and associated objects are in different libraries, you must ensure that the objects are restored in the correct order.

Since independent file system objects do not exist in a library, your restore processing must ensure the objects are restored in the correct order. That is, you must restore your libraries which contain the journals before restoring the independent file system objects that were journaled to that journal.

Related concepts

[Deferring object journaling during restore](#)

Using deferred journaling support allows the system to manage the reestablishment of journaling of objects after a restore.

Related reference

[Create Journal \(CRTJRN\) command](#)

Journal and journal receiver association

When you create a journal, you must specify the name of the journal receiver to be attached to it. If you are using the Create Journal (CRTJRN) command to create the journal, the journal receiver must exist before you can create the journal.

The receiver that you attach may not have been previously attached to a different journal or have been interrupted while being attached to any journal. You can specify up to two journal receivers, but the system ignores the second receiver.

With System i Navigator, you simply create the journal. When you create the journal, System i Navigator creates the journal receiver in the library you specify in the **New Journal** dialog.

Related reference

[Create Journal \(CRTJRN\) command](#)

Journal message queue

When you create or change a journal, you can specify where the system sends messages that are associated with the journal. In addition, you can create a program to monitor this message queue and handle any messages associated with the journal. The system also sends messages that are related to the remote journal function to this message queue.

A common use for this message queue is to handle threshold messages. When you create a journal receiver, you can specify a storage threshold. If you choose to change journal receivers yourself, you can specify where the system sends messages when the journal receiver exceeds its storage threshold. You can create a special message queue for this purpose and create a program to monitor the message queue for message CPF7099. When the message is received, the program can, for example, detach the receiver and save it.

If you specify that the system manages the journal receiver, the system does not send a threshold message. Instead, when the system automatically changes the journal receiver, it sends message CPF7020, which indicates that it successfully detached the journal receiver.

There are other messages which are sent to this journal message queue related to processing for the Delete Receiver (DLTRCV) option of the Create Journal (CRTJRN) command.

For IBM Navigator for i, you select the message queue in the **Journal Properties** dialog. For the character-based interface, you can select the message queue with the Create Journal (CRTJRN) or Change Journal (CHGJRN) command.

Related concepts

[Threshold \(disk space\) for journal receivers](#)

When you create a journal receiver with System i Navigator or the Create Journal Receiver (CRTJRNRCV) command, you specify a disk space threshold that indicates when you want the system to warn you or take action.

[Manual versus system journal-receiver management](#)

When you create a journal with System i Navigator or the Create Journal (CRTJRN) command, you can select to have either system managed or user managed journal receivers.

Related tasks

[Deleting journal receivers](#)

Journal receivers can quickly use a lot of auxiliary storage space. Therefore an important journal management task is to delete journal receivers after you no longer need them.

Related reference

[Create Journal \(CRTJRN\) command](#)

[Change Journal \(CHGJRN\) command](#)

Manual versus system journal-receiver management

When you create a journal with System i Navigator or the Create Journal (CRTJRN) command, you can select to have either system managed or user managed journal receivers.

The default for the CRTJRN command is to have the system manage the journal receivers.

User journal-receiver management

If you specify user journal receiver management, you are responsible for changing the journal receiver when it approaches its storage threshold. If you choose this option, you can have the system send a message to a message queue when the journal receiver approaches its storage threshold.

System journal-receiver management

If you use system journal-receiver management, you can avoid having to do some journal management chores. However, if you are journaling for recovery purposes, you need to ensure that you save all journal receivers that have not been saved, not just the currently attached receiver. Also, if you are journaling for recovery purposes, be sure to specify that the system does not automatically delete receivers when no longer needed. Automatic deletion of journal receivers describes this option.

If you use system journal-receiver management, you must ensure that your environment is suitable and that you regularly check the QSYSOPR message queue and the message queues assigned to your journals.

If the system cannot complete the change journal operation because it cannot obtain the necessary locks, it retries every 10 minutes (or as specified by the MNGRCVDLY parameter). It sends messages (CPI70E5) to the journal's message queue and to the QSYSOPR message queue. If this occurs, you may want to determine why the operation cannot be performed and either correct the condition or swap the journal receiver your self with System i Navigator or the CHGJRN command.

If the system cannot complete the change journal operation for any reason other than lock conflicts, it temporarily discontinues system journal-receiver management for that journal and sends a message

(CPI70E3) to the message queue assigned to the journal or to the QSYSOPR message queue. This might occur because a journal receiver already exists with the name that it would generate. Look at the messages in the QHST job log to determine the problem. After you correct the problem, perform a swap journal operation to do the following:

- Create a new journal receiver
- Detach the current receiver and attach a new journal receiver
- The system then resumes system journal-receiver management.

System journal-receiver management when you restart the system

When you restart the system or vary on an independent disk pool, the system performs a CHGJRN command to change the journal receiver and reset the journal sequence number.

Note: If the journal has *MAXOPT3 specified as a receiver size option, the sequence number is not reset when you restart the system or vary on an independent disk pool unless the sequence number is approaching the maximum sequence number allowed.

Also, if the journal is attached while a maximum receiver-size option is specified, the system attempts to perform a CHGJRN command to reset the sequence number when the following is true:

- When the sequence number exceeds 9 900 000 000 if RCVSIZOPT(*MAXOPT1) or RCVSIZOPT(*MAXOPT2) is in effect for the journal.
- When the sequence number exceeds 18 446 644 000 000 000 000 if RCVSIZOPT(*MAXOPT3) is in effect for the journal.

For all other journal receivers, the system attempts this CHGJRN when the sequence number exceeds 2 147 000 000.

The system does not reset the journal sequence number when you restart the system or vary on an independent disk pool if the entries in the receiver may be needed for commitment control recovery.

Delaying automatic journal change

If you use the CRTJRN or CHGJRN command, you can use the Manage Receiver Delay Time (MNGRCVDLY) parameter. When you use system journal-receiver management for a journal, if the system cannot allocate an object needed to attach a new journal receiver to the journal, it will wait the length of time that you specify in the MNGRCVDLY parameter before its next attempt to attach the new journal receiver. If you do not specify this parameter, the system will wait ten minutes, which is the default.

The following topics have information related to management of journal receivers:

- Automatic deletion of journal receivers
- Threshold (disk space) for journal receivers
- Swap journal receivers
- Receiver size options for journals

Related concepts

Automatic deletion of journal receivers

If you choose system journal receiver management, you can also have the system delete journal receivers that are no longer needed for recovery. You can only specify this if you are using system journal receiver management.

Threshold (disk space) for journal receivers

When you create a journal receiver with System i Navigator or the Create Journal Receiver (CRTJRNRCV) command, you specify a disk space threshold that indicates when you want the system to warn you or take action.

Receiver size options for journals

A journal receiver holds journal entries that you might use for recovery and entries that the system might use for recovery. For example, you might use record level entries, such as database record changes, and

file level entries, such as the entry for opening or closing a file. Also, the system writes entries that you never see or use, such as entries for explicitly journaled access paths, for SMAPP, or for commitment control.

Related tasks

Swapping journal receivers

An important task for journal management is to swap journal receivers. You typically swap journal receivers when they reach their storage threshold. You can swap journal receivers either with IBM Navigator for i or with the Change Journal (CHGJRN) command. If you use system journal-receiver management, the system changes journal receivers for you.

Related reference

Create Journal (CRTJRN) command

Automatic deletion of journal receivers

If you choose system journal receiver management, you can also have the system delete journal receivers that are no longer needed for recovery. You can only specify this if you are using system journal receiver management.

The system can only evaluate whether a receiver is needed for its own recovery functions, such as recovering access paths or rolling back committed changes. It cannot determine whether a receiver is needed to apply or remove journaled changes.

Note: Use automatic deletion of journal receivers with care if you use save-while-active operations to save objects before they reach a commitment boundary. Ensure that you save the journal receivers before the system deletes them. If an object is saved before it reaches a commitment boundary it can have partial transactions. To avoid data loss you must have access to the journal receivers that were attached during the save-while-active operation when you restore the objects with partial transactions.

The system will automatically delete journal receivers if you do one of the following:

- Specify **Delete receivers when no longer needed** in the IBM Navigator for i **Change Receivers** or **Journal Properties** dialogs.
- Specify DLTRCV (*YES) in the Create Journal (CRTJRN) or Change journal (CHGJRN) commands.

However, even if you select one of the previous items, the system cannot delete the journal receiver if any of the following conditions is true:

- An exit program that is registered for the Delete Journal Receiver exit point (QIBM_QJO_DLT_JRNRCV) indicates that the receiver is not eligible for deletion.
- A journal has remote journals associated with it, and one or more of the associated remote journals does not have a full copy of this receiver.
- The system could not get the appropriate locks that are required to complete the operation.
- The exit program registration facility was not available to determine if any exit programs were registered.

If you use system delete-receiver support, you must ensure that your environment is suitable. You must also regularly check the QSYSOPR message queue and the message queues that are assigned to your journals.

- If the system cannot complete the DLTJRNRCV command for any of the above reasons, it retries every 10 minutes (or the value you specify on the DLTRCVDLY parameter). It sends a CPI70E6 message to the journal's message queue, and to QSYSOPR message queue. If this occurs, you might want to determine why the operation cannot be performed and either correct the condition or run the DLTJRNRCV command.
- If the system cannot complete the command for any other reason, it sends a CPI70E1 message to the message queue that is assigned to the journal. If you have not specifically assigned a message queue to the journal, the message will be sent to the QSYSOPR message queue. Look at the messages in QHST to determine the problem. After you correct the problem, use the DLTJRNRCV command on the specific journal receiver.

Do not select to have the detached journal receiver deleted if you might need it for recovery or if you want to save it before it is deleted. The system does not save the journal receiver before deleting it. The system does not issue the warning message (CPA7025) that it sends if a user tries to delete a receiver that has not been saved.

Examples of when you might specify automatic journal deletion include:

- You are journaling only because it is required to use commitment control.
- You are journaling for explicit access-path protection.
- You are replicating the journal receiver to another system through the remote journal function, and that system is providing the backup copy of the journal receiver.

Delaying the next attempt to delete a journal receiver

If you are using the CRTJRN or CHGJRN command, you can use the Delete Receiver Delay Time (DLTRCVDLY) parameter. The system waits the time you specify (in minutes) with the DLTRCVDLY parameter before its next attempt to delete a journal receiver that is associated with the journal when one of the following is true:

- The system cannot allocate a needed object.
- You are using an exit program, and the exit program votes no.
- You are using remote journaling and the receiver has not been replicated to all the remote journals.

If you do not specify this parameter, the system waits ten minutes, which is the default.

Save your system while it is active has instructions for saving an object with transactions in a partial state. Example: Recover objects with partial transactions has instructions for recovering objects with partial transactions.

Related concepts

[Manual versus system journal-receiver management](#)

When you create a journal with System i Navigator or the Create Journal (CRTJRN) command, you can select to have either system managed or user managed journal receivers.

Related tasks

[Save your server while it is active](#)

[Example: Recovering objects with partial transactions](#)

If you restore an object that was saved with a save-while-active operation that specified that the object can be saved before it reaches a commitment boundary, it can have partial transactions. To recover objects that are in a partial state you must perform an apply or a remove journaled changes operation.

Related reference

[Create Journal \(CRTJRN\) command](#)

[Change journal \(CHGJRN\) command](#)

[Delete Journal Receiver exit point \(QIBM_QJO_DLT_JRNRCV\) API](#)

Receiver size options for journals

A journal receiver holds journal entries that you might use for recovery and entries that the system might use for recovery. For example, you might use record level entries, such as database record changes, and file level entries, such as the entry for opening or closing a file. Also, the system writes entries that you never see or use, such as entries for explicitly journaled access paths, for SMAPP, or for commitment control.

When you create a journal with the Create Journal (CRTJRN) command, the Change Journal (CHGJRN) command, or IBM Navigator for i, you can specify options that limit the data that gets deposited into these journal entries, or increases the maximum allowable size for the journal receiver. These options are as follows:

- The RCVSIZOPT parameter of the CRTJRN command
- The RCVSIZOPT parameter of the CHGJRN command

- The **Change Receivers** dialog box of Navigator for i
- The **Journal Properties** dialog box of Navigator for i

Note: Specifying *SYSDFT for the RCVSIZOPT parameter is the same as specifying RCVSIZOPT(*MAXOPT2 *RMVINTENT).

The following subtopics explain the benefits of some of the values for receiver size options.

Remove internal entries

When you specify to remove internal entries the system periodically removes internal journal entries from the attached journal receiver when it no longer needs them for recovery purposes. Removing internal entries might have a slight impact on system performance, because the system has to manage these internal entries separately and periodically remove them.

To remove internal entries specify the RCVSIZOPT(*RMVINTENT) parameter. The Navigator for i equivalent to the RCVSIZOPT(*RMVINTENT) parameter is **Remove internal entries** in the **Change Receivers** or **Journal Properties** dialog box.

Specifying to remove internal entries has these benefits:

- It reduces the impact that SMAPP might have on journal receivers for user-created journals.
- It reduces the size of journal receivers that are on the system.
- It reduces the amount of time and media required to save journal receivers, because unnecessary entries are not saved.
- It reduces the time that it takes to apply journal entries, because the system does not have to evaluate unnecessary entries.
- It reduces the communications impact if the remote journal function is being used because unnecessary entries are not sent.

Minimize fixed-length portion of entries

Minimizing the fixed-length portion of entries has the following effects:

- All information selectable by the FIXLENTA parameter is not deposited in the entries.
- Minimizing the fixed-length portion of entries reduces auxiliary storage space and some CPU time as well.
- When you view journal entries with this information removed, the displayed value is *OMITTED, blanks, or zeros, depending on the type of data.
- To determine if a journal receiver was attached to a journal while minimizing the fixed-length portion of entries, use the Display Journal Receiver Attributes DSPJRNRCVA command display.
- Do not use minimize the fixed-length portion of entries if you require an audit trail.
- Minimizing the fixed-length portion of entries limits the selection criteria you can use on these commands and APIs:
 - Apply Journalized Changes (APYJRNCHG) command
 - Apply Journalized Changes Extend (APYJRNCHGX) command
 - Compare Journal Images (CMPJRNIMG) command
 - Display Journal (DSPJRN) command
 - Receive Journal Entry (RCVJRNE) command
 - Remove Journalized Changes (RMVJRNCHG) command
 - Retrieve Journal Entry (RTVJRNE) command
 - Retrieve Journal Entries (QjoRetrieveJournalEntries) API
- Minimizing the fixed-length portion of entries reduces the communications impact if the remote journal function is being used because unnecessary data is not sent.

To minimize the fixed-length portion of entries specify RCVSIZOPT(*MINFIXLEN). The Navigator for i equivalent to RCVSIZOPT(*MINFIXLEN) is **Minimize fixed portion of entries** in the **Create Journal** or **Change Receivers** dialog.

If you are using minimizing the fixed-length portion of entries, you cannot use the FIXLENDTA parameter. See Fixed-length options for journal entries for more information about the FIXLENDTA parameter.

Maximum receiver-size options

Use the following options to specify the maximum allowable size for your journal receivers and to specify the largest allowable sequence numbers for journal entries. The Navigator for i equivalent is **Receiver Maximum Options** in the **Create Journal** or **Change Receivers** dialog.

RCVSIZOPT(*SYSDFT)

Using RCVSIZOPT(*SYSDFT) is currently the same as specifying RCVSIZOPT(*RMVINTENT *MAXOPT2). This is the default.

RCVSIZOPT(*MAXOPT1)

Use RCVSIZOPT(*MAXOPT1) to set the maximum size of a journal receiver attached to your journal to approximately one terabyte (1 099 511 627 776 bytes) and a maximum sequence number of 9 999 999 999. Additionally, the maximum size of the journal entry which can be deposited is 15 761 440 bytes.

RCVSIZOPT(*MAXOPT2)

Use RCVSIZOPT(*MAXOPT2) to set the maximum size of a journal receiver attached to your journal to approximately one terabyte (1 099 511 627 776 bytes) and a maximum sequence number of 9 999 999 999. However, with RCVSIZOPT(*MAXOPT2), the system can deposit a journal entry as large as 4 000 000 000 bytes.

RCVSIZOPT(*MAXOPT3)

Use RCVSIZOPT(*MAXOPT3) to set the maximum size of a journal receiver attached to your journal to approximately one terabyte (1 099 511 627 776 bytes). In addition, with RCVSIZOPT(*MAXOPT3) the journal receiver can have a maximum sequence number of 18 446 744 073 709 551 600. With RCVSIZOPT(*MAXOPT3), the system can deposit a journal entry as large as 4 000 000 000 bytes. You cannot save or restore these journal receivers to any releases before V5R3M0. Nor can you replicate them to any remote journals on any systems at a release before V5R3M0.

If you use RCVSIZOPT(*MAXOPT3) you must use the FROMENTLRG and TOENTLRG parameters to specify a journal entry sequence number larger than 9 999 999 999 when you perform the following commands:

- APYJRNCHG
- APYJRNCHGX
- CMPJRNIMG
- DSPJRN
- RCVJRNE
- RMVJRNCHG
- RTVJRNE

Related concepts

[Fixed-length options for journal entries](#)

You can use the Fixed Length Data (FIXLENDTA) parameter of Create Journal (CRTJRN) and Change Journal (CHGJRN) commands to audit security related activity for journaled objects on your system. The IBM Navigator for i equivalent function is **Fixed length data to include** on the **Create Journal** and **Change Receivers** dialogs.

Related reference

[Create Journal \(CRTJRN\) command](#)

[Change Journal \(CHGJRN\) command](#)

[Change Journal Attributes \(CHGJRNA\) command](#)

[Display Journal Receiver Attributes \(DSPJRNRCVA\) command](#)
[Apply Journalized Changes \(APYJRNCHG\) command](#)
[Apply Journalized Changes Extend \(APYJRNCHGX\) command](#)
[Compare Journal Images \(CMPJRNIMG\) command](#)
[Display Journal \(DSPJRN\) command](#)
[Receive Journal Entry \(RCVJRNE\) command](#)
[Remove Journalized Changes \(RMVJRNCHG\) command](#)
[Retrieve Journal Entry \(RTVJRNE\) command](#)
[Retrieve Journal Entries \(QjoRetrieveJournalEntries\) API](#)

Journal object limit

The journal object limit (JRNOBJLMT) parameter allows you to set the maximum number of objects that will be allowed to be journalized to the journal.

The journalized object limit is the maximum number of objects that can be journalized to one journal. You can set the journal object limit to either 250 000 or 10 000 000. Use the Journal Object Limit (JRNOBJLMT) parameter on the Create Journal (CRTJRN) or Change Journal (CHGJRN) command to set the maximum number of journalized objects.

The value *MAX10M can only be specified for the Journal Object Limit (JRNOBJLMT) parameter if the Receiver Size Option (RCVSIZOPT) parameter has one of the receiver maximum values specified, or if RCVSIZOPT is *SYSDFT.

Some factors to consider in determining the journal object limit are:

- Number of objects that would be actively changing at any given time
- The impact journaling has on the performance of your system
- Importance in being able to get some parallelism at IPL, run-time, hot-site apply, and high-availability (HA) replay time
- Complexity of managing your journal environment with multiple journals
- Complexity of your hot-site recovery procedures if you have dependencies between objects journalized to different journals
- Number of objects you may need to journal in the future
- A journal employing the *MAX10M attribute cannot be saved and restored to any releases prior to V5R4 and it can not be replicated to any remote journals on any systems prior to V5R4.
- Once you have chosen the *MAX10M option, you cannot switch back to the *MAX250K value.
- If you choose the *MAX10M option, remote journaling will be ended for any remote journal on a release prior to V5R4 and you will **not** be able to restart it.
- Increasing the quantity of objects associated with a single journal may increase your IPL time, independent ASP vary on time, or disaster recovery time. As a general rule, if the number of actively changing objects is likely to be greater than 5 000, consider journaling some of these objects to a separate journal. The larger the number of actively changing objects for a given journal at system termination, the longer it will take to recover the journal at IPL or vary on of an independent ASP.

***MAX250K**

The maximum number of objects that can be journalized to one journal is 250 000. This is the default value.

***MAX10M**

The maximum number of objects that can be journalized to a single journal is 10 000 000.

If the number of currently journalized objects is greater than the maximum number of journalized objects, a start journal request will fail.

Note: A new receiver must be attached at the same time as this value is changed.

Minimized entry-specific data for journal entries

On the Create Journal (CRTJRN) and Change Journal (CHGJRN) commands, you can specify to allow for the deposit of minimized journal entries. This will decrease the size of your journal entries.

When you specify the Minimized Entry Specific Data (MINENTDTA) parameter for an object type, the entry-specific data for the entries of those object types can be minimized. You can minimize journal entries for database physical files and data areas.

The system only minimizes entries if the minimized entry is smaller in size than a complete journal entry deposit. Therefore, even if you specify this option, not all entries that are deposited will be minimized. The Display Journal (DSPJRN) command, Receiver Journal Entry (RCVJRNE) command, Retrieve Journal Entry (RTVJRNE) command, and QjoRetrieveJournalEntries API return data that indicates whether the entry is actually minimized.

The *FILE, *DTAARA, and *FLDBDY values are allowed on the MINENTDTA parameter for the CRTJRN and CHGJRN commands and indicate the following:

***FILE**

Journalized files may have journal entries deposited with minimized entry specific data. The minimizing will not occur on field boundaries, and the entry specific data may not be viewable and may not be used for auditing purposes. This value cannot be specified if *FLDBDY is specified.

***FLDBDY**

Journalized files may have journal entries deposited with minimized entry specific data. The minimizing will occur on field boundaries, and the entry specific data will be viewable and may be used for auditing purposes.

- The DSPJRN command always displays the entries which have been minimized on field boundaries with formatting.
- The *FLDBDY value is not available in releases prior to V5R4.

***DTAARA**

Journalized data areas may have journal entries deposited with minimized entry specific data.

Note: You cannot save or restore a journal receiver with minimized journal entries to any release prior to V5R1M0, nor can they be replicated to any remote journal on a system at a release prior to V5R1M0.

The IBM Navigator for i equivalent is **Minimized entry data** on the **Create Journal** and **Change Receivers** dialogs.

An optional parameter, Format minimized data (FMTMINDTA), is available on the Retrieve Journal Entries (RTVJRNE) command, the Receive Journal Entries (RCVJRNE) command, and the Retrieve Journal Entries (QjoRetrieveJournalEntries) API. This parameter allows you to specify whether entry specific data which has been minimized on field boundaries will be returned in a readable format, which allows you to determine what changes have been made. The possible values for the FMTMINDTA parameter are *NO or *YES, with the default being *NO. By default, the methods used by these commands provide the data in their raw format. The RTVJRNE command will indicate whether or not *FLDBDY has been specified for Minimized entry specific data with a value of '2' in the already existing "MINIMIZED ENTRY DATA" field for the appropriate entry formats. *FILE and *DTAARA will appear as '1' in their fields.

Using the Display Journal (DSPJRN) command, entries are viewable to the screen, an outfile, or printed output. The DSPJRN command will also indicate whether or not the *FLDBDY value has been specified for Minimized entry specific data on the "Display Journal Entry" panel and will indicate a value of '2' in the "Minimized entry specific data" field of the *OUTFILE and in the "Min" field of the printed output. *FILE and *DTAARA will appear as '1' in their fields.

Related concepts

[Considerations for entries which contain minimized entry-specific data](#)

Reduce the size of journal receivers by specifying minimized entry-specific data on the Create Journal (CRTJRN) and Change Journal (CHGJRN) commands.

Related reference

[Create Journal \(CRTJRN\) command](#)

Change Journal (CHGJRN) command

Related information

[Journal code finder](#)

*Example: MINENTDTA (*FLDBDY)*

The following SQL script provides an example of the of the *FLDBDY value used with the Minimized entry specific data (MINENTDTA) parameter for the CRTJRN and CHGJRN commands.

Note: By using the code examples, you agree to the terms of the [Code license and disclaimer information](#).

```
/* Setup of environment */
create collection payroll
create table payroll/wages (employee int, wages char(10),
    startdate date, benefits char(50))
create index payroll/wageix on payroll/wages (employee)
CL:STRJRNAP FILE(PAYROLL/WAGEIX) JRN(PAYROLL/QSQJRN)
CL:CHGJRN payroll/QSQJRN jrnrcv(*GEN) minentdta(*FLDBDY)

/* Changes against files to be audited */
insert into payroll/wages values (1001, '22.00/hour',
    '01/01/2003', 'Qualifies for health benefits, 401k match')
insert into payroll/wages values (1002, '18.00/hour',
    '10/01/2004', 'Qualifies for health benefits')
update payroll/wages set wages = '24.50/hour' where employee = 1001
update payroll/wages set wages = '19.00/hour' where employee = 1002

/* Auditing procedure */
CL:DSPJRN JRN(PAYROLL/QSQJRN) JRNCDE((R)) OUTPUT(*OUTFILE) OUTFILFMT(*TYPE5)
    OUTFILE(PAYROLL/DSPJRNOUT) ENDTALEN(*CALC) NULLINDLEN(4)
create table payroll/auditfile (fixeddata char(555), nvi char(4),
    employee int, wages char(10), startdate char(10), benefits char(50))
CL:CPYF FROMFILE(PAYROLL/DSPJRNOUT) TOFILE(PAYROLL/AUDITFILE)
    MBROPT(*ADD) OUTFMT(*HEX) FMTOPT(*NOCHK)
select nvi, employee, wages, startdate, benefits
    from payroll/auditfile
```

Note: the NVI (Null value indicator) field houses metadata which reveals which columns residing within the journal entry were collected and what variety of data they house. Some columns will house null values for fields which were collected, some will house a copy of the data deposited during the update operation, while others will house filler values representing the default value for that column. Such filler values will appear on behalf of those columns whose contents were not changed and were not required to be collected. These are the same columns which did not consume space within the journal entry because a copy of their value was not collected. In order to recognize the difference between these three varieties, refer to the table below. The first NVI character corresponds to the first field (EMPLOYEE), the second NVI character corresponds to the second field (WAGES), etc. When the NVI value is a '0', it signifies that an exact copy of the field is present. When the NVI value is a '1', the corresponding field houses a null. When the NVI value is a '9', the corresponding field was not collected (because it was minimized) and, therefore, what will be displayed is the default value.

| NVI | EMPLOYEE | WAGES | STARTDATE | BENEFITS |
|------|----------|------------|------------|---|
| 0000 | 1,001 | 22.00/hour | 2004-01-01 | Qualifies for health benefits, 401k match |
| 0000 | 1,002 | 18.00/hour | 2004-10-01 | Qualifies for health benefits |
| 0099 | 1,001 | 22.00/hour | 0001-01-01 | |
| 0099 | 1,001 | 24.50/hour | 0001-01-01 | |
| 0099 | 1,002 | 18.00/hour | 0001-01-01 | |
| 0099 | 1,002 | 19.00/hour | 0001-01-01 | |

The first 2 entries are for the inserts. The second 2 entries are the update before image and update after image for the first update. The last 2 entries are the update before image and update after image for the final update. Notice that the update entries have real data for the first 2 fields and default data for the second 2 fields as indicated by the null value indicators. The first field is collected because it is a key field for a journaled IX over this table. The second field is collected because the data within the field has changed. Any of the **fixed** journal entry information (for example, sequence number, journal code) can also be included by either substringing the **fixed** field in the audit file or creating the audit file with fields formatted such as the *TYPE5 outfile.

Customization of the journal recovery count

This topic is about using the Journal Recovery Count (JRNRCYCNT) parameter in the CHGJRN command to set the journal recovery ratio for each journal. The IBM Navigator for i equivalent function is the **Journal recovery count** on the **Journal Properties** dialog box.

This parameter will indicate how many journal entries can exist between the last deposited entry and the oldest forced entry for a journaled object. A value between 10 000 and 2 000 000 000 will be allowed. A value of *SYSDFT will also be allowed to reset the journal's recovery count to the system default journal recovery count.

The journal recovery count allows you to choose between faster abnormal IPL recovery and decreased run time processing. Specifying a smaller value decreases the number of changes that would need to be recovered from this journal during an abnormal IPL by increasing the frequency with which changed objects are forced. Specifying a larger value increases the number of changes that would need to be recovered for this journal during an abnormal IPL by decreasing the frequency with which changed objects are forced.

Note: Changing the journal recovery count value may affect overall system performance as it affects the utilization of auxiliary storage devices.

The WRKJRNA command indicates the Journal Recovery Count on the panel display and in the printed output. A value of *SYSDFT displays if the system default journal recovery count is being used. All journals are created with the system default journal recovery count, and if a value other than the system default (*SYSDFT) is specified, the system default journal recovery count will no longer be in effect for the journal. The [Retrieve Journal Information API](#) will also return the Journal Recovery Count.

The operating system is shipped with a system default journal recovery count of 250 000. The QJOCHRVC API changes the system default journal recovery count for all newly created journals on the system and all existing journals that have the system default (*SYSDFT) specified for their journal recovery count.

For additional information on Journal Recovery Count customization see:

- [Change Journal Attributes \(CHGJRNA\)](#) command
- [Change Journal Recovery Count \(QJOCHRVC\)](#) API

Fixed-length options for journal entries

You can use the Fixed Length Data (FIXLENDTA) parameter of Create Journal (CRTJRN) and Change Journal (CHGJRN) commands to audit security related activity for journaled objects on your system. The IBM Navigator for i equivalent function is **Fixed length data to include** on the **Create Journal** and **Change Receivers** dialogs.

With the FIXLENDTA parameter, you can elect to include security related information in the fixed-length portion of the journal entries. You cannot use the FIXLENDTA parameter and Minimize fixed-length portion of entries at the same time.

Fixed-length options

With the FIXLENDTA parameter, you can specify that the following data is included in the journal entries that are deposited into the attached journal receiver:

Job name

Use the *JOB value to specify the job name.

User profile name

Use the *USR value to specify the effective user profile name.

Program name

Use the *PGM value to specify the program name.

Program library name

Use the *PGMLIB value to specify the program library name and the auxiliary storage pool device name that contains the program library.

System sequence number

Use the *SYSSEQ value to specify the system sequence number. The system sequence number gives a relative sequence to all journal entries in all journal receivers on the system.

Remote address

Use the *RMTADR value to specify the remote address, the address family and the remote port.

Thread identifier

Use the *THD value to specify the thread identifier. The thread identifier helps distinguish between multiple threads running in the same job.

Logical unit of work identifier

Use the *LUW value to specify the logical unit of work identifier. The logical unit of work identifies work related to specific commit cycles.

Transaction identifier

Use the *XID value to specify the transaction identifier. The transaction identifier identifies transactions related to specific commit cycles.

Related conceptsReceiver size options for journals

A journal receiver holds journal entries that you might use for recovery and entries that the system might use for recovery. For example, you might use record level entries, such as database record changes, and file level entries, such as the entry for opening or closing a file. Also, the system writes entries that you never see or use, such as entries for explicitly journaled access paths, for SMAPP, or for commitment control.

Related reference

Create Journal (CRTJRN) command

Change Journal (CHGJRN) command

Journal cache

Journal caching is a separately chargeable feature with which you can specify that the system cache journal entries in main storage, before writing them to disk. Journal caching is option 42 of the IBM i operating system.

After you have purchased journal caching, you can specify it with the JRNCACHE parameter on the Create Journal (CRTJRN) or Change Journal (CHGJRN) commands. The IBM Navigator for i equivalent function is the **Cache journal entries** option on the **Create Journal** and **Journal Properties** dialogs.

Journal caching provides significant performance improvement for batch applications which perform large numbers of changes to the data portion of the journaled objects. The actions that show a performance improvement if journal caching is enabled are as follows:

- Changes to database files from add, update, or delete operations
- Changes to data areas from uses of the change data area command or API
- Changes to data queues from uses of the send data queue API or the receive data queue API
- Changes to integrated file system objects from various write and fclear operations on journaled stream files

Applications using commitment control will see less improvement (commitment control already performs some journal caching).

Journal caching modifies the behavior of traditional noncached journaling in batch. Without journal caching, a batch job waits for each new journal entry to be written to disk. Journal caching allows most operations to no longer be held up waiting for synchronous disk writes to the journal receiver.

Journal caching is especially useful for situations where journaling is being used to enable replication to a second system.

It is not recommended to use journal caching if it is unacceptable to lose even one recent change in the event of a system failure where the contents of main memory are not preserved. This type of journaling

is directed primarily toward batch jobs and may not be suitable for interactive applications where single system recovery is the primary reason for using journaling.

Furthermore, the results from the following commands or API will not display the journal entries in the cache:

- Display Journal (DSPJRN) command
- Retrieve Journal Entry (RTVJRNE) command
- Receive Journal Entry (RCVJRNE) command
- Retrieve Journal Entries (QjoRetrieveJournalEntries) API

The Display Journal Receiver Attributes (DSPJRNRCVA) Command and the Retrieve Journal Receiver Information (QjoRtvJrnReceiverInformation) API show the total number of journal entries in a journal receiver. However if some of those entries are in the cache, you cannot see these journal entries using the DSPJRN, RTVJRNE, and RCVJRNE commands, and the QjoRetrieveJournalEntries API. For example, if there are 100 journal entries in a journal receiver, the DSPJRNRCVA command and QjoRtvJrnReceiverInformation API show that the total number of entries is 100. However, if the last 25 entries are in the journal cache, you can only view the first 75 entries.

Journal caching also affects remote journaling. Journal entries are not sent to the remote system until they are written from the cache to disk. Since journal entries are not sent to the target system right away, the number of journal entries that are not confirmed are always greater than if you are not using journal caching.

The Change Journal Attributes (CHGJRNA) command can be used to set the maximum time that the system waits before writing journal entries to disk when journal caching is used. Setting the CACHEWAIT time limits the loss of lingering changes when there is a lull in journal entry arrival.

Contact your service representative for more information about ordering journal caching.

Related reference

- [Create Journal \(CRTJRN\) command](#)
- [Change Journal \(CHGJRN\) command](#)
- [Change Journal Attributes \(CHGJRNA\) command](#)

Object assignment to journals

You can use one journal to manage all the objects you are journaling. Or, you can set up several journals if groups of objects have different backup and recovery requirements. Every journal has a single attached receiver. All journal entries for all objects being managed by the journal are written to the same journal receiver.

When deciding how many journals to use and how to assign objects to journals, consider the following:

- Using one journal (and journal receiver) is the simplest method for managing both daily operations and recovery.
- There is a limit of 10 000 000 objects that can be journaled to a single journal.
- If using a single journal receiver causes a performance bottleneck, you can alleviate this by placing the journal receiver in a separate disk pool from the objects that you are journaling.
- To simplify recovery, assign objects that are used together in the same application to the same journal.
- If you are journaling database files, all the physical files underlying a logical file must be assigned to the same journal.
- Files opened under the same commitment definition within a job can be journaled to different journals. In commitment control, each journal is considered a local location.
- If your major applications have completely separate objects and backup schedules, separate journals for the applications may simplify operating procedures and recovery.
- If you journal different objects for different reasons; such as recovery, auditing, or transferring transactions to another system; you may want to separate these functions into separate journals. However, you can assign an object to only one journal.

- If the security of certain objects requires that you exclude their backup and recovery procedures from the procedures for other objects, assign them to a separate journal, if possible.
- If you have basic disk pools with libraries, all objects assigned to a journal must be in the same disk pool as the journal. The journal receiver may be in a different disk pool. If you place a journal in a disk pool without libraries (non library disk pool), objects being journaled must be in the system disk pool. The journal receiver may be in either the system disk pool or the non library disk pool with the journal.
- If you have independent disk pools, they must be library capable in order to journal objects on them. You cannot journal objects on User-Defined File System (UDFS) independent disk pools.

Related concepts

Determining the type of disk pool in which to place journal receivers

Use disk pools (auxiliary storage pool) to control which objects are allocated to which groups of disk units. If you are journaling many active objects to the same journal, the journal receiver can become a performance bottleneck. One way to minimize the performance impact of journaling is to put the journal receiver in a separate disk pool. This also provides additional protection because your objects are on different disk units from the journal receiver, which contains a copy of changes to the objects.

Setting up journaling

This topic provides instructions on how to set up journals and journal receivers.

Setting up journaling consists of creating a journal and a journal receiver. When you create a journal, you need the following information:

- The name of the journal.
- The library assignment of the journal.
- The journal receiver name to associate with the journal.
- Which disk pool to assign storage space for the journal (only if you are using the ASP parameter in the CRTJRN command).
- The journal message queue.
- Whether or not to use manual or system journal-receiver management.
- Whether or not to have automatic deletion of the journal receiver.
- The receiver size options for the journal.
- The journal object limit for the journal.
- Who has authority to the journal.
- Whether or not to minimize entry-specific data (character-based interface only).
- Whether or not to use journal caching (character-based interface only).
- Whether or not to delay the next attempt to automatically change the journal receiver (character-based interface only).
- Whether or not to delay the next attempt to automatically delete the journal receiver (character-based interface only).
- Whether or not to include fixed-length data in the journal entries (character-based interface only).

When you create a journal receiver, you need the following information:

- The name of the journal receiver
- The disk pool assignment for journal receiver
- The storage threshold for the journal receiver
- Who has authority to the journal receiver

You can choose one of the following methods to set up journaling. For information about the difference between the two methods, see [“IBM Navigator for i versus the character-based interface for journaling objects” on page 17](#).

- To set up journaling with Navigator for i, follow these steps.

1. With Navigator for i connect to the system that contains the objects you wish to journal.
 2. Expand **Journal Management**.
 3. Select **Create a journal**.
 4. Start journaling for each object that you plan to journal.
- To set up journaling with the character-based interface, follow these steps.
 1. Create the journal receiver using the Create Journal Receiver (CRTJRNRCV) command.
 2. Create the journal using the Create Journal (CRTJRN) command.
 3. Start journaling for each object that you plan to journal.

Related concepts

Planning setup for journals

The following topics provide information to plan configuration for journals. They provide information about each option that you can select for journal.

IBM Navigator for i versus the character-based interface for journaling objects

There are two environments that you can use for journal management: IBM Navigator for i and the character-based interface. Navigator for i provides a graphical interface for journaling that is easy to use and does not require the use of control language (CL) commands. The character-based interface requires the use of CL commands or APIs, but has more functionality than Navigator for i. Some of this function is also available through the System i Navigator.

Starting and ending journaling and changing journaling attributes

This topic provides instructions on how to start and end journaling for all of the object types that journaling supports.

Related reference

[Create Journal Receiver \(CRTJRNRCV\) command](#)

[Create Journal \(CRTJRN\) command](#)

Example: Setting up journaling

This topic provides several examples of setting up journaling in the character-based interface. The first example sets up journaling with the both the journal and receiver in the system disk pool. The second and third examples set up journaling with the journal and journal receiver in separate basic disk pools.

Note: By using the code examples, you agree to the terms of the [Code license and disclaimer information](#).

Journal and receiver in system disk pool

In this example, the library \$DSTJRN is in the system disk pool and has the following description:

- Type: PROD
- Disk pool of library: 1
- Create authority: *EXCLUDE

1. The \$DSTJRN library already exists in the system disk pool.
2. The Create Journal Receiver (CRTJRNRCV) command creates journal receiver RCV DST1 in the \$DSTJRN library:

```
CRTJRNRCV JRNRCV($DSTJRN/RCVDST1) THRESHOLD(1500000)
TEXT('RECEIVER FOR $DSTJRN JOURNAL')
```

3. The journal receiver is placed in the system disk pool with the library because *LIBASP is the default value for the ASP parameter on the CRTJRNRCV command.
4. Public authority for the journal receiver is *EXCLUDE because the **Create authority** value for the library is *EXCLUDE and the default for the authority (AUT) parameter is *LIBCRTAUT.
5. The Create Journal (CRTJRN) command creates the associated local journal:

```
CRTJRN JRN($DSTJRN/JRNLA) JRNRCV($DSTJRN/RCVDST1)
MNGRCV(*USER)
```

The receiver size option is *MAXOPT2 and *RMVINTENT since the RCVSIZOPT(*SYSDFT) is the default for the CRTJRN command.

Journal receiver in a nonlibrary basic disk pool

In this example, the journal receiver is in a nonlibrary basic disk pool and the journal is in the system disk pool.

1. The CRTJRNRCV command creates journal receiver RCV DST2 in a nonlibrary basic disk pool

```
CRTJRNRCV JRNRCV($DSTJRN/RCVDST2) THRESHOLD(1000000)
ASP(2) TEXT('RECEIVER FOR $DSTJRN JOURNAL')
```

2. The CRTJRN command creates the local journal in the system disk pool:

```
CRTJRN JRN($DSTJRN/JRNLB) JRNRCVR($DSTJRN/RCVDST2)
MSGQ($DSTJRN/JRNLBMSG)
MNGRCV(*USER)
```

3. When the receiver RCV DST2 exceeds 1 024 000 000 bytes of storage, a message (CPF7099) is sent to the JRNLBMSG message queue in the \$DSTJRN library.
4. The objects to be journaled must also be in the system disk pool.

Journal and journal receiver in basic disk pools

In this example, the libraries ARLIBR and ARLIB are in basic library disk pools and have the following description:

ARLIBR

- Type: PROD
- Disk pool of library: 3
- Create authority: *USE
- Text description: A/R Receiver LIB

ARLIB

- Type: PROD
- Disk pool of library: 4
- Create authority: *USE
- Text description: A/R Receiver LIB

1. The CRTJRNRCV command creates journal receiver RCV DST3 in the library basic disk pool

```
CRTJRNRCV JRNRCV(ARLIBR/RCVDST3) THRESHOLD(1500000)
TEXT('RECEIVER FOR ARJRN JOURNAL')
```

2. Because public authority is not specified, the public authority is set to *USE (the **Create authority** value for the ARLIBR library).
3. The CRTJRN command creates the local journal that is associated with the RCV DST3 journal receiver:

```
CRTJRN JRN(ARLIB/ARJRN) JRNRCV(ARLIBR/RCVDST3)
```

When the RCV DST3 journal receiver exceeds 1 536 000 000 bytes of storage, the system creates a new journal receiver named RCV DST4, attaches it to the journal, and sends message CPF7020 (journal receiver detached) to the QSYSOPR message queue (the default queue).

4. All objects journaled to the ARJRN journal must be in ASP 4 because the journal is in ASP 4.

5. In this case, the database files and journal are in the same library. The journal receivers are in a library that is saved and restored after the journal library if a single command is used, because ARLIBR comes after ARLIB in a normal sort sequence.

Related reference

[Create Journal Receiver \(CRTJRNRCV\) command](#)

[Create Journal \(CRTJRN\) command](#)

Starting and ending journaling and changing journaling attributes

This topic provides instructions on how to start and end journaling for all of the object types that journaling supports.

Why you must save objects after you start journaling

After you start journaling, it is essential that you save objects that you are journaling.

It is critical to save the journaled object after journaling is started to be able to apply journaled changes. When you start journaling an object, the system assigns a unique **journal identifier** (JID) to that object. If the object is a physical database file, each member is also assigned a unique JID. If you start journaling on a distributed file, the piece on each system has its own unique JID. The JID is part of every journal entry added to the journal receiver for a given object. The system uses the JID to associate the journal entry with the corresponding journaled object. The copy of the object on the save media that was saved before it was journaled does not have the journal identifier saved with it. Therefore, if this copy of the object is restored to the system, the journal entries cannot be associated with the object and cannot be applied.

After you start journaling an object, do the following:

- Save the object immediately after you have started journaling it, before any changes have occurred.
- Save a physical file or a logical file after you start journaling access paths for the file. This ensures that when you restore the file, journaling access paths is started automatically.
- If you are using distributed files, save the file separately on the systems in the node group after starting journaling for the distributed file.

Saving these objects ensures that you can completely recover all the objects by using your saved copy and your journal receivers.

Updating the history

If you are not using the save-while-active function, update the history for the object when you save it so that processing for applying and removing journaled changes will have the best information for verification. If you save the object using the SAV command, change the UPDHST value to something other than *NO. The default value for the SAV command is to not preserve the update history. For the other Save related commands, the default value is to preserve the update history. When you use the save-while-active function, you do not need to update the history for the object for verification when you apply and remove journaled changes. When you use the save-while-active function, information is saved on the media with the object and restored when the object is restored. This extra information provides the last save information for applying and removing journaled changes.

Saving queue contents

- To save the contents of the queue as well, one must specify QDTA((*DTAQ)) on the **save** commands.

The JID and other journaling operations

Not only do you need the JID to apply journaled changes, other journaling operations use the JID. All formats, except the *TYPE1, *TYPE2, and *TYPE3 formats, for the Display Journal (DSPJRN), Receive Journal Entry (RCVJRNE), or Retrieve Journal Entry (RTVJRNE) command include the JID for the object.

The JID is also included with the *TYPEPTR and *JRNENTFMT format for the RCVJRNE command, as well as the Retrieve Journal Entries (QjoRetrieveJournalEntries) API. You can use the Retrieve JID Information (QJORJIDI) API to retrieve an object's name (for an object not in the integrated file system) or the file identifier (for an object in the integrated file system), if you know its JID.

Commands for saving objects

You can use one of the following commands to save journaled objects:

Physical database files, data areas, and data queues

- Save Changed Objects (SAVCHGOBJ) and specify OBJTYPE(*object-type) OBJJRN(*YES)
- Save Object (SAVOBJ)
- Save Library (SAVLIB)
- Save (SAV)

Integrated file system objects

- SAV

See the Manually saving parts of your system topic for more information about saving journaled objects.

Related tasks

[Manually saving parts of your server](#)

Starting journaling

This topic provides information about how to start journaling for all object types.

After you have created the journal and journal receiver, you can start journaling. When journaling has been started for an object, the system writes journal entries for all changes to the object.

The start journal command must obtain an exclusive lock on the object. However, for database physical files and integrated file system objects, you can start journaling even if an object is open. The recommended procedure for starting journaling is:

1. Start journaling the object.
2. Save the object. If the object is open for changing, this will be a save-while-active type save.

If you are not using the save-while-active function, it is highly recommended that you update the history for the object when you save it so that processing for applying and removing journaled changes will have the best information for verification. If you saved the object using the SAV command, the default value is to not preserve the update history. Therefore, change the UPDHST value to something other than *NO.

For the other save related commands, the default value is to preserve the update history. When using save-while-active, updating the history for the object is not needed for verification when applying and removing journaled changes. In this case, information is saved on media with the object, and restored when the object is restored. This extra information provides the last save information for applying and removing journaled changes.

Normally, only the definition of a data queue is saved, not its contents. To save the contents of the queue as well, one must specify QDTA(*DTAQ) on the save commands.

The maximum number of objects that can be associated with one journal is either 250 000 or 10 000 000. The option of setting the journal object limit to 10 000 000 simplifies journaling because there are fewer journals to manage, but allows for less parallelism during IPL and disaster recovery. You can also have all objects created within a subdirectory start journaling automatically without having to be broken up when you reach the 250 000 limit. The value *MAX10M can only be specified for the Journal Object Limit (JRNOBJLMT) parameter if the Receiver Size Option (RCVSIZOPT) parameter has one of the *MAXOPT values specified or if RCVSIZOPT is *SYSDFE.

The following links provide instructions to start journaling for each object type:

Journaling libraries

Allows you to start journaling changes to a library and automatically journal any objects created, moved, or restored into a library.

Use the Start Journal Library (STRJRNLIB) command to enable the library journaling functions. STRJRNLIB starts journaling changes (made to a library or list of libraries) to a specific journal, and optionally starts journaling changes to objects within the library or list of libraries. To start journaling for a library using IBM Navigator for i follow these steps.

1. With Navigator for i connect to the system that contains the library that you want to journal.
2. Expand **File Systems**
3. Select **Integrated File System**
4. Select **QSYS.LIB**
5. Select the library you want to journal and the **Journaling** action.

After journaling begins for the object, save the journaled object to preserve its journal attribute information. Also, the object must be saved because, for example, journaled changes cannot be applied to a version of the object that was saved before journaling was in effect.

Objects created, moved, and restored into the library that are eligible for journaling can automatically start journaling to the same journal as the library. Which objects inherit the journal state of the library and what journaling attributes they start journaling with are determined by the inherit journaling attributes of the library. The inherit rules allow for objects to inherit the journal state of the library based on the name of the object being added to the library. Objects with names that begin with specified characters, can be selected to start journaling or omitted from starting journaling. With this capability, work files created in production libraries can be prevented from starting journaling while production files can still have journaling started.

See [Start Journal Library \(STRJRNLIB\)](#) for details on enabling library journaling.

Journaling database physical files (tables)

When you start journaling a physical file (table), you specify whether you want after-images saved, or both before-images and after-images.

To reduce the number of journal entries, you can omit entries for open operations and close operations for the file. To omit open and close entries from being journaled, select the **Exclude open and close entries** in IBM Navigator for i. Or you can Specify OMTJRNE (*OPNCLO) on the Start Journal Physical File (STRJRNPFF) command. If you choose to omit open journal entries and close journal entries, be aware that:

- You cannot use the journal to audit who has accessed the file.
- You cannot apply or remove journal changes to open boundaries and close boundaries using the TOJOB0 and TOJOB C parameters.

To start journaling for physical database files, follow these steps.

1. With Navigator for i, connect to the system with the object you want to journal.
2. Expand **Databases**
3. Click **Set Database/Schema to use with Database Tasks** and set the database and schema that contain the object you want to journal.
4. Click **Tables**.
5. Select the table that you want to journal and select the **Journaling** action.

You can also use the STRJRNPFF command to start journaling physical database files.

Related concepts

[Reasons to journal before-images](#)

When you journal an object, the system always writes an after-image for every change that is made. You can request that the system write before-image journal entries for database files and data areas. All other

object types only journal after-images. This significantly increases the auxiliary storage requirements for journaling.

Related reference

[Start Journal Physical File \(STRJRNPf\) command](#)

Related information

[DB2 Universal Database](#)

Journal DB2 Multisystem files

When you successfully start journaling on a distributed file, the system distributes the start journal request to the other servers in the node group.

All servers are attempted even if there is a failure at any one server. Once journaling is started on a server in the node group, it stays started even if there is a failure at any of the other servers.

The journal has to exist with the same name on all servers in the node group. The journal itself is not distributed, only the Start Journal Physical File (STRJRNPf) command.

The journal and its receiver are associated only with the changes made to the file on the one server. If you have two servers in the node group and a file is updated on both servers, the update on server A is only in server A's journal and receiver and the update on system B is only in system B's journal and receiver.

The journal identifier (JID) is different on each piece of the distributed file. Each server piece has its own JID. This means that you cannot use the journal entries that are deposited on one server to apply or remove journaled changes to a different piece of the file on another server.

Related concepts

[Distributed database administration](#)

Related reference

[Start Journal Physical File \(STRJRNPf\) command](#)

Logical file journaling

The system automatically starts journaling logical files built over a journaled physical file when it finds a need to. This is referred to as covert journaling. The result is journal entries recording things like authority changes for logical files. Any access path associated with the logical file is not covertly journaled.

The covertly journaled logical files show as journaled objects when viewing objects journaled to a journal. They also report as being journaled when using the Display Object Description (DSPOBJD) command and other interfaces that return similar information.

If the based on physical file ends journaling, then any covert journaling of the logical files built over the physical file also ends.

Journaling integrated file system objects

You can journal integrated file system objects if they are in the "root"(/), QOpenSys, and user-defined file systems.

The following integrated file system objects can be journaled:

- Stream files (*STMF)
- Directories (*DIR)
- Symbolic links (*SYMLNK)

When you use the SAV command to save an integrated file system object, the default is to not update the history information for the object. If you plan to apply journaled changes to the objects you are journaling, and you are not using the save-while-active function, specify to preserve the update history information about the SAV command.

If you are journaling *DIR or *STMF objects, you can reduce the number of journal entries in the journal receiver. In IBM Navigator for i, if you ensure that **Include open, close, and synchronization entries** is deselected, or specify OMTJRNE(*OPNCLOSYN) on the Start Journal (STRJRN) command, you can omit

entries for open operations, close operations, and force entries for the object. If you choose not to journal these entries be aware of the following:

- You cannot use the journal to audit who has accessed the object for opens, closes, and forces.
- If an object is journaled, it cannot be memory mapped.
- You cannot apply journal changes to open boundaries and close boundaries using the TOJOB0 and TOJOB0C parameters.
- This option is only valid for *DIR and *STMF objects.

If you are journaling symbolic links, the system does not follow the symbolic link to determine what to journal. That is, the system only journals the actual symbolic link. If you want to journal the end object, you must journal the end object directly.

If you are journaling a directory and select **Journal new files and folders** in IBM Navigator for i (INHERIT(*YES) on the STRJRN command), then objects created into that directory will be automatically journaled to the same journal. Therefore use caution because you can journal more objects than you realize. Also, even if this option is on, if an object is restored to the directory, it keeps the journaling attributes it had before the restore operation (when it was saved), unless it has never previously been journaled. In that case, the object will be journaled. For example, if you restore a stream file that is journaled to Journal X, but the directory you restore the stream file to is being journaled to Journal Y, the stream file will still be journaled to Journal X, even if the directory has the inherit option on.

Note: If you end journaling for an object and then rename that object in the same directory in which it currently resides, journaling is not started for the object, even if the directory has the inherit option on.

If you select **Current folder and all subfolders** in Navigator for i (SUBTREE(*ALL) on the STRJRN command), journaling only starts on objects that exist in the subtree when the STRJRN command is executed. To start journaling on objects that are added to the subtree after this point you have three options:

- You can start journaling for each object after it is created.
- You can select **Journal new files and folders** (INHERIT option) on the original start journal request.
- After journaling is started you can use the Change Journaled Objects (CHGJRNOBJ) command and specify INHERIT(*YES).

If you select to journal the current folder and all subfolders, and there are object types in the subtree that are not supported for journaling, the unsupported object types are skipped over so that only object types that are supported for journaling get journaled.

Restrictions for journaling integrated file system objects are as follows:

- You cannot journal files which are memory mapped. The Memory Map a File (mmap()) API documentation has information about memory mapping.
- IBM i systems allocate disk space for Integrated xSeries servers as virtual disk drives. From the perspective of the IBM i system, virtual drives appear as byte stream files within the integrated file system. You cannot journal these byte stream files. See the Windows environment on IBM i topic for more information about Integrated xSeries servers.
- Virtual volume files cannot be journaled.
- Temporary user-defined file systems cannot be journaled.

To start journaling for integrated file system objects, do the following steps:

1. With IBM Navigator for i, connect to the system on which the object that you want to journal is located.
2. Expand File Systems.
3. Select Integrated File Systems.
4. Expand the file system with the object you want to journal.
5. If you are journaling a directory, select the directory and the **Journaling** action.
6. If you are journaling an object in a directory, expand the directory and select that object and the **Journaling** action.

You can also use the STRJRN command or Start Journal (QjoStartJournal) API for integrated file system objects that you want to journal.

Related concepts

[Windows environment on System i](#)

[Integrated file system](#)

Related reference

[Memory Map a File \(mmap\(\)\) API](#)

[Start Journal \(STRJRN\) command](#)

[Start Journal \(QjoStartJournal\) API](#)

Journal access paths

After you have started journaling for physical files, you can set up explicit journaling of access paths.

You can use the Start Journal Access Path (STRJRNAP) command to start journaling access paths owned by physical files or logical files. When you start journaling access paths for a physical file, the system journals any of these, if they exist:

- Keyed access paths
- Access paths for primary key constraints
- Access paths for unique constraints
- Access paths for referential constraints
- Encoded vector access paths
- Many access paths with sort sequence tables

Some access paths that use an international component for Unicode (ICU) sort sequence table may be too complex to be journaled.

All underlying physical files must be journaled to the same journal before you can start journaling for an access path. The entries created when you journal an access path are used to recover the access path after the system ends abnormally. They are not used when you apply or remove journal entries. You can specify RCVSIZOPT(*RMVINTENT) for the journal to have the system remove these entries when they are no longer needed for recovery. This reduces the disk storage requirements for the journal receiver.

You cannot start journaling for an access path that is in use. The STRJRNAP command must obtain an *EXCL lock on the logical file.

The recommended procedure for starting access path journaling is as follows:

1. Use the STRJRNAP command to start journaling the access path.
2. Save all the underlying physical files, specifying ACCPTH(*YES).

If you have target recovery times for access paths set up on your system, you might not need to set up explicit journaling for access paths.

Related concepts

[Reasons to journal access paths](#)

If you journal access paths, the system can use the journal entries to recover access paths instead of rebuilding them completely.

Related reference

[Start Journal Access Path \(STRJRNAP\) command](#)

Journaling data areas and data queues

When you start journaling for a data area or a data queue, the system writes journal entries for all changes to the data area or data queue.

The following restrictions apply for journaling data areas and data queues:

- For data areas, only local external data area objects may be journaled. The special data areas (*LDA, *GDA, *PDA) and DDM data areas cannot be journaled.

- For data queues, only local data queues are supported. DDM data queues cannot be journaled.

When you start journaling a data area, you specify whether you want after-images saved, or both before-images and after-images.

To start journaling for data areas and data queues, follow these steps.

1. With IBM Navigator for i, connect to the system with the data area or data queue you want to journal.
2. Expand File Systems.
3. Expand Integrated File System.
4. Expand QSYS.LIB.
5. Select the library with the data area or data queue.
6. Select the data area or data queue you want to journal and select the **Journaling** action.

Or, after you have created the journal, use one of the following commands or API for each data area or data queue you want to journal:

- **Start Journal (STRJRN)** command
- **Start Journal Object (STRJRNOBJ)** command
- Start Journal (QjoStartJournal) API

Related reference

[Start Journal \(STRJRN\) command](#)

[Start Journal Object \(STRJRNOBJ\) command](#)

[Start Journal \(QjoStartJournal\) API](#)

Related information

[CL programming](#)

[Work Management](#)

Automatically starting journaling

You can automatically journal objects created into libraries or directories.

- Objects created in, moved into, or restored into a journaled library will automatically start journaling. To start library journaling, see [“Journaling libraries”](#) on page 53.
- Using a data area named QDFTJRN, you can automatically start journaling for a non-integrated file system object. The QDFTJRN data area must be created by the user.
- To automatically start journaling for integrated file system objects, see the discussion of journal inheritance in [“Journaling integrated file system objects”](#) on page 54.

Automatic journaling using QDFTJRN

Using data area named QDFTJRN, you can automatically start journaling when a non-integrated file system object (data area, data queue, or file) is created, moved, or restored into the library, thus, ensuring the very first change to the object will be recorded in the journal and that no lock on the user's part prevents journaling from starting in the library. The QDFTJRN data area must exist in the library where the object is being added.

If a data area called QDFTJRN exists 1) in the same library into which the data area, data queue, or physical file is created, or 2) in the same schema that the SQL table is created into, and 3) the user (in either instance) is authorized to the data area, journaling will be started to the journal named in the data area if all the following are true:

- The identified library for the data area, data queue, or physical file or identified schema for the SQL table must not be QSYS, QSYS2, QRECOVERY, QSPL, QPTFOBJ1, QPTFOBJ2, QRCL, QRPLOBJ, QGPL, QTEMP, or any of the independent auxiliary storage pool (IASP) equivalents to these libraries. (An iASP equivalent of QRPLOBJ, for example, is QRPLxxxx where 'xxxx' is the number of a primary auxiliary storage pool (ASP).)

- The journal specified in the data area must exist and the user must be authorized to start journaling to the journal.

See Table 1 on page 58 for a detailed description of the values within the data area. When creating SQL tables within a schema, the QSQJRN journal within the schema is used to start journaling the tables. To start journaling the tables to a different journal than QSQJRN within the schema, create the QDFTJRN data area in the schema and specify a different journal name inside the QDFTJRN data area.

| <i>Table 1. Formats of the QDFTJRN data area.</i> | | | |
|---|---|---------------|---|
| Offset | Field | Format | Description |
| 1 | Library name | Char (10) | Name of the library that contains the journal. |
| 11 | Journal name | Char (10) | Name of the journal to use to automatically start journaling. |
| 21 | Repeat the set of Object type and Option as needed: | | |
| | Object type | Char (10) | Object type value: *FILE = database files or SQL tables *DTAARA = data areas *DTAQ = data queues *ALL = all journal eligible objects which are not in an integrated file system *NONE = no objects |
| | Option | Char (10) | Option: *CREATE = Start journaling when an object is created into the library *MOVE = Start journaling when an object is moved into the library *RESTORE = Start journaling when an object is restored into the library *ALLOPR = Start journaling in all cases possible *RSTOVRJRN = Override the saved object's journal and start journaling to the journal name in this QDFTJRN data area when the object is restored into the library |

Note: The values in the data area must be in upper case.

Restore impacts for library-based objects

Library journaling and the QDFTJRN data area provide more options for journaling during the restore operation. When using the *RESTORE keyword, even if an object was not journaled at save time, the operating system automatically records the restore operation to the journal the library is journaled to, or to the journal specified in the QDFTJRN data area. However, if the object was journaled at save time and that journal still exists on the system, the library's journal and the journal specified in the QDFTJRN data area are ignored. In this case, the operating system still records the restore operation to the journal used at save time.

You can use the *RSTOVRJRN keyword to override the journal used at save time. After you specify the *RSTOVRJRN keyword, the operating system always records the restore operation to the library's journal or to the journal that is specified in the QDFTJRN data area. In this case, any journal used at save time is ignored.

If the object being restored still exists on the system, the *RSTOVRJRN keyword is ignored during the restore operation.

If you changed the journal of your object using the *RSTOVRJRN keyword, save your object as soon as possible to enable future recovery operations with the Apply Journalled Changes (APYJRNCHG), Apply Journalled Changes Extend (APYJRNCHGX), and Remove Journalled Changes (RMVJRNCHG) commands. The save operation records the journal receiver and the new journal as the journal receiver and journal to use for recovering your object from the point of its last save. The save operation also updates the last saved date of your object, if UPDHST(*YES) is specified on the save command.

See the Start Journal Library ([STRJRNLIB](#)) command for more information on using the *RSTOVRJRN keyword with library journaling.

To use the *RSTOVRJRN keyword to override the journal used at save time, position the *RSTOVRJRN keyword in the QDFTJRN data area before the references to the *ALLOPR or *RESTORE operation option. Here is an example.

For example, the files restored into library OVERRIDE are currently journalled to journal SAVEJRN in library SAVELIB. But you want the files to be journalled to journal OVERJRN in library JRNLIB, while you still want the restored data areas or data queues to be journalled to the save time journal. And you also want any new objects created into the library OVERRIDE to be journalled to journal OVERJRN in library JRNLIB. To achieve this, use the following commands to create the QDFTJRN data area.

```
CRTDTAARA DTAARA(OVERRIDE/QDFTJRN) TYPE(*CHAR) LEN(80)
CHGDTAARA DTAARA(OVERRIDE/QDFTJRN (1 10)) VALUE(JRNLIB)
CHGDTAARA DTAARA(OVERRIDE/QDFTJRN (11 10)) VALUE(OVERJRN)
CHGDTAARA DTAARA(OVERRIDE/QDFTJRN (21 10)) VALUE(*FILE)
CHGDTAARA DTAARA(OVERRIDE/QDFTJRN (31 10)) VALUE(*RSTOVRJRN)
CHGDTAARA DTAARA(OVERRIDE/QDFTJRN (41 10)) VALUE(*ALL)
CHGDTAARA DTAARA(OVERRIDE/QDFTJRN (51 10)) VALUE(*ALLOPR)
```

Note: The library and journal names in columns 1-20 must be in upper case.

Related tasks

[Journaling integrated file system objects](#)

You can journal integrated file system objects if they are in the "root"(/), QOpenSys, and user-defined file systems.

Changing journaling attributes of journalled objects without ending journaling

This topic provides information about how to change the journaling attributes of a journalled object without ending journaling.

Use the Change Journal Object (CHGJRNOBJ) command to change journaling attributes of journalled objects without ending and restarting journaling. You can use the CHGJRNOBJ command to do the following:

- Change whether you are journaling both before and after images or just after images.
- Change whether you are omitting open, close, and force journal entries from the journal receiver.
- Change whether you are journaling objects that are created in a directory.
- Remove the partial transaction state from a database file.
- Change what objects in libraries automatically start journaling.
- Change whether journal entries for an object are filtered by remote journal filtering by object.

Except for removing the partial transaction state from a database file, the objects whose attributes you are changing must currently be journalled. Also, you can only change one attribute at a time.

Before and after images

Use the Images (IMAGES) parameter to change if you are journaling only after images or both before and after images. The object whose journaling attributes you are changing must already be journalled. You can change this journaling attribute for the following object types:

- Database physical files
- Data areas

Omitting journal entries

Use the Omit Journal Entries (OMTJRNE) parameter to change whether to omit open, close, and force journal entries from the journal receiver. The object whose journaling attributes you are changing must already be journaled. You can change this journaling attribute for the following object types:

- Database physical files
- Integrated file system stream files
- Integrated file system directories

Journal new objects in a directory

Use the New Objects Inherit Journaling (INHERIT) parameter to change whether journaling starts automatically for objects that are created in a journaled integrated file system directory after the attribute is changed.

Partial transaction state

Note: Use of this parameter can result in loss of data. Use this parameter only as a last resort, if the appropriate journal receivers are unavailable to do an apply or remove journaled changes operation.

Use the Partial Transactions (PTLTNS) parameter to allow an object that contains partial transactions to be used. You use this parameter only for one of the following reasons:

- You are unable to apply or remove the journaled changes to complete or remove the transactions because the journal receivers are unavailable.
- The object was involved in a rollback operation that was ended early and there is no saved version of the object to use.

Only use this parameter as a last resort because the partial transactions remain within the object.

Inherit rules

Use the inherit rules (INHRULES) parameter to change which objects automatically start journaling when created, moved, or restored into a journaled library after the attribute is changed.

Remote journal filter

Use the remote journal filter (RMTJRNFTTR) parameter to change whether journal entries deposited for an object are eligible for remote journal filtering by object.

Consideration for distributed files

When you successfully change the journal attributes for a distributed file, the system distributes the request to change a journal attribute to the other servers in the group. All servers are attempted even if there is a failure at any one server. When the journaling attribute has been changed on a server in the node group, it remains that way even if there is a failure at any of the other servers.

Related tasks

Example: Recovering objects with partial transactions

If you restore an object that was saved with a save-while-active operation that specified that the object can be saved before it reaches a commitment boundary, it can have partial transactions. To recover objects that are in a partial state you must perform an apply or a remove journaled changes operation.

Related reference

[Change Journaled Object \(CHGJRNOBJ\) command](#)

Ending journaling

This topic provides information about how to end journaling and why ending journaling might be necessary.

You may need to end journaling for several reasons:

- If a journal is damaged and you need to delete it, you must first end journaling for all objects assigned to the journal.
- In some situations, you might want to end journaling before running a large batch application, if that application has exclusive use of the object. This is done either to improve the speed of the batch application or to reduce the auxiliary storage needed for the journal receiver. If you do this, use this method:
 1. End journaling for the objects.
 2. If journaling physical files save them specifying ACCPTH(*YES).
 3. If journaling other object types, save them.
 4. Run the batch application.
 5. Start journaling for the objects.
 6. Save the physical files, specifying ACCPTH(*YES).
 7. Save the other journaled objects.

To end journaling, proceed as follows:

1. End journaling for access paths with the **End Journal Access Path (ENDJRNAP)** command
2. With IBM Navigator for i, connect to the system with the object that you want stop journaling.
 - a) Expand **Journal Management**.
 - b) Select **Set Database/Library to use with Journal Tasks** and specify the database and library that contain the object you want to end journaling for.
 - c) Select **Journals**.
 - d) Select the journal to which the object is journaled and the **Show Journaled Objects** action.
 - e) Select the correct tab for the object type of the object you want to end journaling for.
 - f) Select the object and the **End Journaling** action.

Or, use the following commands or API to end journaling:

- **End Journal Library (ENDJRNLIB)** command for libraries
- **End Journal Access Path (ENDJRNAP)** command for access paths
- **End Journal Physical File (ENDJRNPF)** command for database files
- **End Journal (ENDJRN)** command for integrated file system objects
- **End Journal Object (ENDJRNOBJ)** command for other objects
- `End Journal (QjjoEndJournal)` API for integrated file system objects, data areas, and data queues.

You must end journaling for any access paths based on a physical file before you can end journaling for the physical file.

In the following cases, the system implicitly ends journaling:

- When you delete an object, journaling is ended for the object.
- When you remove a physical file member, journaling is ended for the member.
- When you remove a physical file member, journaling is ended for any access paths associated with the member unless an access path is shared and journaled by another file member.
- When you delete a file, journaling is ended for any access paths associated with the file unless an access path is shared and journaled by another file.

When you successfully end journaling on a distributed file, the system distributes the end journal request to the other systems in the node group. All systems are attempted even if there is a failure at any one system. Once journaling is ended on a system in the node group, it stays ended even if there is a failure at any of the other systems.

Even if a distributed file is not locally journaled, and if you specify the file name and the journal name on the **ENDJRNPF** command, the system will still attempt to distribute the end-journal request to the other systems in the file node group.

Related concepts

[Distributed database administration](#)

Related reference

[End Journal Access Path \(ENDJRNAP\) command](#)

[End Journal Physical File \(ENDJRNPF\) command](#)

[End Journal \(ENDJRN\) command](#)

[End Journal Object \(ENDJRNOBJ\) command](#)

[End Journal Library \(ENDJRNLIB\) command](#)

[End Journal \(QjoEndJournal\) API](#)

Managing journals

This topic provides instructions for managing your journaling environment.

Managing your journaling environment requires these basic tasks:

- Keep records of which objects you are journaling.
- Evaluate the impact on journaling when new applications or logical files are added.
- Regularly detach, save, and delete journal receivers.

Your journal receivers enable you to recover changes to your important objects. They also provide an audit trail of activity that occurs on your system.

Protect your journal receivers by regularly detaching them and saving them; or you can have the system take over the job of changing journal receivers by specifying system journal-receiver management.

Related concepts

[Manual versus system journal-receiver management](#)

When you create a journal with System i Navigator or the Create Journal (CRTJRN) command, you can select to have either system managed or user managed journal receivers.

Swapping, deleting, saving and restoring journals and receivers

The management tasks that you need to perform most often for journaling are swapping journal receivers and saving and deleting journal receivers.

Swapping journal receivers

An important task for journal management is to swap journal receivers. You typically swap journal receivers when they reach their storage threshold. You can swap journal receivers either with IBM Navigator for i or with the Change Journal (CHGJRN) command. If you use system journal-receiver management, the system changes journal receivers for you.

You can use Navigator for i or the Change Journal (CHGJRN) command to change the attributes of the journal. You can also use the Navigator for i or the CHGJRN command to change the receiver for a journal (detach the current receiver, create and attach a new receiver) and to reset the sequence number for journal entries.

When you swap a journal receiver, the old journal receiver becomes detached. When you detach a journal receiver, you cannot reattach it to any journal. You can do these things with a detached journal receiver:

- Save or restore it.

- Display entries.
- Retrieve entries.
- Receive entries.
- Use it to apply or remove journaled changes.
- Use it to compare journaled images.
- Display its status or position in a receiver chain.
- Delete it.
- Replicate it with the remote journal function.

You must swap journal receivers to change the following journaling attributes:

- Manual or system journal management (MNGRCV parameter)
- Receiver size options (RCVSIZOPT parameter)
- Minimized entry specific data (MINENTDTA parameter)
- Journal receiver threshold value (THRESHOLD parameter)
- Fixed-length data (FIXLENDTA parameter)
- Journal object limit (JRNOBJLMT parameter)
- Reset journal sequence numbers (SEQOPT parameter)

To use Navigator for i to swap a journal receiver, follow these steps:

1. With Navigator for i connect to the system you want to use.
2. Expand **Journal Management**.
3. Select **Set Database/Library to use with Journal Tasks** and specify the database/library that you want to work with.
4. Select **Journals**.
5. Select the journal you want to use and the **Change Receivers** action.
6. Optionally, you can change any options you want.
7. Click OK. The **Change Receivers** dialog closes. The new journal receiver is automatically created and attached.

You can also use JRNRCV(*GEN) on the **Change Journal (CHGJRN)** command to create the new receiver with the same attributes as the currently attached receiver, and in the same library. These attributes include the owner, private authorities, public authority, object auditing, ASP identifier, threshold, and text.

Note: The system will call all user exit programs registered on the QIBM_QJO_CHG_JRNRCV exit point whenever a journal receiver is detached from a journal. See [Change Journal Receiver Exit Program](#) for more information.



CAUTION: If you use save-while-active operations to save objects before they reach a commitment boundary, ensure that you save the journal receiver after you detach it. If you delete the journal receiver before it is saved, you can lose the ability to recover any pending transactions for those objects.

Related concepts

[Manual versus system journal-receiver management](#)

When you create a journal with System i Navigator or the Create Journal (CRTJRN) command, you can select to have either system managed or user managed journal receivers.

[Threshold \(disk space\) for journal receivers](#)

When you create a journal receiver with System i Navigator or the Create Journal Receiver (CRTJRNRCV) command, you specify a disk space threshold that indicates when you want the system to warn you or take action.

Related tasks

[Save your server while it is active](#)

Journal receiver chains

Journal receivers that are associated with a journal (that is presently or previously attached to the journal) are linked in one or more **receiver chains**. Each journal receiver, except the first one, has a previous receiver that was detached when the current receiver was attached. Each journal receiver, except the one that is currently attached, also has a next receiver.

The following figure illustrates the process by which journal receiver chains are created. If you leave the previously attached receivers RCVA7 through RCVA9 online, you can use them to apply changes, to remove changes, or to display journal entries without restoring them first.

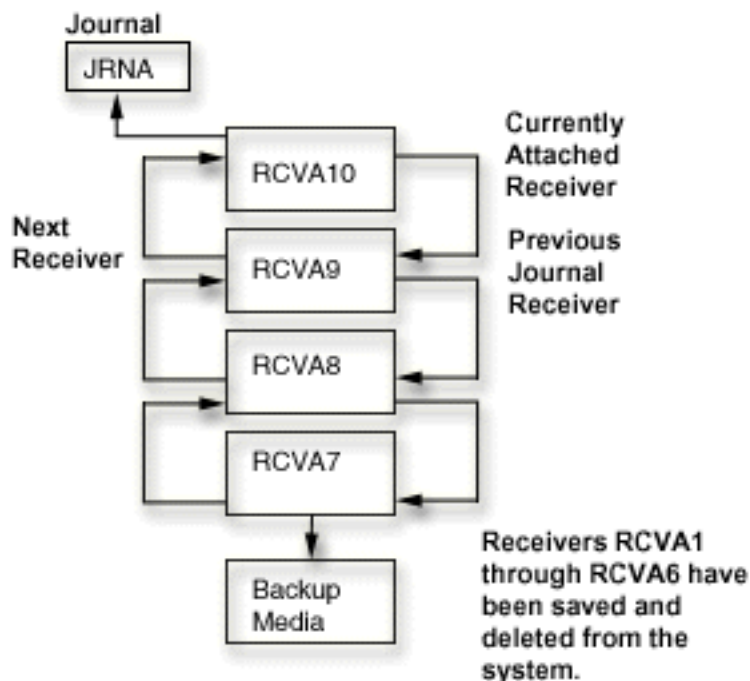

This figure shows four journal receivers for journal JRNA. Journal receivers RCVA7, RCVA8, and RCVA9 are online. Journal receiver RCVA10 is currently attached to journal JRNA. Journal receivers RCVA1 through RCVA6 are saved to backup media and are not on the system.

If a complete copy of a receiver is missing in a chain of journal receivers linked together in the previously described relationship, the result is a **chain break**. Avoid receiver chain breaks. A receiver chain break indicates that any changes made between the last entry in the last receiver in one chain and the first entry in the first receiver in the next chain are not available in any journal receiver on the system.

Note: If you use save-while-active operations to save objects before they reach a commitment boundary, it is crucial that you keep track of your journal receiver chains.

Using a save-while-active operation to save objects before they reach a commitment boundary can result in objects saved to the media that have partial transactions. A break in a journal receiver chain can prevent you from recovering these objects with partial transactions.

A set of receivers for a journal that has one or more receiver chain breaks has multiple receiver chains. Receiver chain breaks result from the following:

- You restored an old journal receiver and its next receiver is not on the system.

- A journal receiver was saved while it was attached, a partial receiver is restored, and no complete copy of the receiver is on the system or restored.
- A receiver that has not had its storage freed by a save operation is restored, and the next receiver has had its storage freed by a save operation.
- The journal is restored. All journal receivers associated with the previous copy of the journal (before the journal was deleted and restored) will not be in the same receiver chain as the currently attached journal receiver.
- The user or the system deleted a damaged or destroyed journal receiver from the middle of a chain.
- A journal receiver from another system is restored. The journal receiver will be associated with a journal at restore time if the associated library and journal on the source system had the same library name and journal name as the library and journal on the target system.
- You chose to replicate specific receivers instead of all receivers in the receiver directory chain. This occurred while replicating journal receivers from a source system to a target system.

You cannot use the following commands and API across multiple receiver chains:

- [Apply Journalized Changes \(APYJRNCHG\) command](#)
- [Apply Journalized Changes Extend \(APYJRNCHGX\) command](#)
- [Remove Journalized Changes \(RMVJRNCHG\) command](#)
- [Receive Journal Entries \(RCVJRNE\) command](#)
- [Display Journal \(DSPJRN\) command](#)
- [Retrieve Journal Entries \(RTVJRNE\) command](#)
- [Compare Journal Images CMPJRNIMG command](#)
- [Retrieve Journal Entries \(QjoRetrieveJournalEntries\) API](#)

If multiple receiver chains exist, you need to determine:

- Whether any journal entries are missing.
- Whether your data will be valid if you use more than one receiver chain.

If you decide to proceed, you must run a separate command for each receiver chain.

You can use the Work with Journal Attributes (WRKJRNA) command to display the receiver chain (F15) and work with journal receivers.

Related tasks

[Displaying information for journaled objects, journals, and receivers](#)

IBM Navigator for i, Control Language commands, and APIs provide several ways for you to display information about journaled objects, journals, and journal receivers.

[Save your server while it is active](#)

[Example: Recovering objects with partial transactions](#)

If you restore an object that was saved with a save-while-active operation that specified that the object can be saved before it reaches a commitment boundary, it can have partial transactions. To recover objects that are in a partial state you must perform an apply or a remove journaled changes operation.

Resetting the sequence number of journal entries

Normally, when you change journal receivers, you continue the sequence number of journal entries. When the sequence number becomes very large, consider resetting the sequence to start the numbering at 1. You can reset the sequence number only when all changes are forced to auxiliary storage for all journaled objects and commitment control is not active for the journal. Resetting the sequence number has no effect on how the new journal receiver is named.

Some conditions prevent you from resetting the sequence number, such as an active commit cycle. If the system cannot reset the sequence number, you receive message CPF7018.

If you use system journal-receiver management for a journal and RCVSIZOPT(*MAXOPT3) is not specified, the sequence number for the journal is reset to 1 whenever you restart the system or vary on the

independent disk pool containing the journal. When you restart the system or vary on an independent disk pool, the system performs the change journal operation for every journal on the system or disk pool that specifies system journal-receiver management. The operation that the system performs is equivalent to `CHGJRN JRN(xxx) JRNRCV(*GEN) SEQOPT(*RESET)`. The sequence number is not reset if journal entries exist that are needed for commitment control IPL recovery. When `RCVSIZOPT(*MAXOPT3)` is specified, the sequence number is only reset when you restart your system or vary on an independent disk pool if it is approaching the maximum value.

If you specify `RCVSIZOPT(*MAXOPT1)`, `RCVSIZOPT(*MAXOPT2)`, or `RCVSIZOPT(*SYSDFT)` for the journal to which you attached the receiver, the maximum sequence number is 9 999 999 999. If you specify `RCVSIZOPT(*MAXOPT3)`, the maximum sequence number is 18 446 744 073 709 551 600. If you do not specify a receiver-size option, the maximum sequence number is 2 147 483 136. If these numbers are reached, journaling stops for that journal. Whenever you change journal receivers, the system tells you what the starting sequence number is through message CPF7019. Also, when you are approaching the sequence number limit, CPF7019 is additionally sent to the QSYSOPR message queue every time you change journal receivers.

The system sends a warning message (CPI70E7) to the journal's message queue when the sequence number exceeds 2 147 000 000. If you specified `RCVSIZOPT(*MAXOPT1)`, `RCVSIZOPT(*MAXOPT2)`, or `RCVSIZOPT(*SYSDFT)` for the journal that you attached the receiver to, the system sends the warning message when the sequence number exceeds 9 900 000 000. If you specified `RCVSIZOPT(*MAXOPT3)`, the system sends the warning message when the sequence number exceeds 18 446 644 000 000 000 000. If you use system change-journal management support (`MNGRCV(*SYSTEM)`) for the journal, the system attempts to change the journal and reset the sequence number one time. The message is sent only if the attempt is not successful.

To reset the sequence numbers for journal entries proceed as follows:

1. With IBM Navigator for i, connect to the system you want to use.
2. Expand **Journal Management**.
3. Select **Set Database/Library to use with Journal Tasks** and specify the database and library that you want to work with.
4. Select **Journals**.
5. Select the journal you want to use.
6. Select the **Change Receivers** action and click **Reset sequence number**.
7. Click **OK**. The **Change Receivers** dialog closes. The new journal receiver is automatically created and attached.

Note: If you attempt to use the **CHGJRN** command with the same journal receiver name and `SEQOPT(*CONT)`, you might receive the message CPF701A. To recover, delete the journal receiver and use the **CHGJRN** command again.

To change the sequence number with the **Change Journal (CHGJRN)** command, specify the `SEQOPT(*RESET)` parameter.

Related reference

[Change Journal \(CHGJRN\) command](#)

Deleting journal receivers

Journal receivers can quickly use a lot of auxiliary storage space. Therefore an important journal management task is to delete journal receivers after you no longer need them.

When you determine whether to delete a journal receiver, consider the following:

- Journal receivers you need for recovery

Do not delete a journal receiver that has not been saved if you need that journal for recovery. Any journal receiver that you need to perform an apply or remove journaled changes operation is needed for recovery.

Note: Use care when you delete journal receivers if you use save-while-active operations to save objects before they reach a commitment boundary. Ensure that you save the journal receivers before you delete them. If an object is saved before it reaches a commitment boundary it can have partial transactions. If you need to restore objects with partial transactions, you must have access to the journal receivers that were attached during the partial transactions to avoid data loss.

To determine if a journal receiver has been saved, in IBM Navigator for i select the journal receiver, and select the **Properties** action. If the **Saved** field shows no date, then you have not saved the journal receiver.

If you have saved the journal receiver, but the journaled objects are not saved, then you still need that journal receiver for recovery. If you have space on your system, wait to delete journal receivers until it is unlikely that you need them for a recovery. (You saved the journaled object). Restoring journal receivers before applying or removing journaled changes may significantly increase your recovery time.

Although it is not recommended, the system does not prevent you from deleting a receiver you detached and is not saved or that is required to provide adequate recovery. If you try to delete a journal receiver that was once attached but has not been saved, the system issues an inquiry message. You can then continue or cancel the delete operation. You can use the system reply list to specify the reply the system is to send for this inquiry message (rather than explicitly responding to each inquiry message).

- Journal receivers you do not need for recovery

If you are journaling only for access path protection or commitment control, most likely you do not need the journal receivers to recover journaled changes. You do not need to save these journal receivers before deleting them.

To make your journaling tasks easier, you can even automate the deletion of these journal receivers by specifying the following:

- Specify system journal-receiver management.
- Specify automatic deletion of journal receivers.

When you specify automatic deletion of journal receivers, the system does not send a message when it deletes a journal receiver. By specifying automatic deletion for journal receivers, you indicate that you do not need the journal receivers for user recovery.

- Where the journal receiver is in the receiver chain

To ensure logical recovery, the system does not allow you to delete a journal receiver from the middle of the receiver chain unless one of the following conditions exists:

- The journal is using automatic deletion of journal receivers.
- The journal is a remote journal.

However, if a journal receiver is damaged, you can delete it from the middle of the chain. If an attached journal receiver is damaged, you must perform a change journal operation to detach the damaged receiver before you can delete it.

The rules for deleting journal receivers are as follows:

- You cannot delete a journal receiver that is attached to a local journal. You must perform a change journal operation to detach a journal receiver before you delete it.
- You must delete journal receivers in the same order they were attached to a journal.
- You can delete a damaged or inoperable receiver regardless of the previous restriction. However, if an attached receiver is damaged, you must detach it before you delete it.
- You cannot delete a journal receiver that is attached to a remote journal if the remote journal has a journal state of active. If you attempt to delete a receiver that is attached to a remote journal, the system sends the inquiry message CPA705E. The results of the reply to the message are the same as those that occur with message CPA7025.

To delete journal receivers, take the following steps.

1. With Navigator for i, connect to the system you want to use.
2. Expand **Journal Management**.
3. **Set Database/Library to use with Journal Tasks** and specify the database and library that you want to work with.
4. Click **Show All Journal Tasks**.
5. Select the journal receivers list.
6. Select the journal receiver you want to delete and click Delete.
7. At the **Confirm Object Deletion** dialog click **Delete**.

You can also use the **Delete Journal Receiver (DLTJRNRCV)** command to delete journal receivers. If you use the **DLTJRNRCV** command, an exit point is available to use with an exit program to help automate journal receiver deletion.

One example of using this exit point is a situation where your application is using the data in the journal receiver. The application is dependent on the journal receiver being present until your application processing is complete. By registering an exit program with the QIBM_QJO_DLT_JRNRCV exit point, the program will be called every time a journal receiver is deleted from the system. If your program determines that your application is not yet done with the receiver, it can indicate that the journal receiver is not eligible for deletion.

If you must delete the receiver regardless of what an exit program indicates, you can specify ***IGNEXITPGM** for the DLTOPT parameter on the DLTJRNRCV command. This parameter value requests that any user exit programs that are registered for QIBM_QJO_DLT_JRNRCV exit point be ignored.

You can also use the following values for the DLTOPT parameter:

***IGNTGTRCV**

Ignore target receiver. If you specify this value, the system does not verify that all remote journals that are associated with this journal, and are immediately downstream on a target system, have full copies of this journal receiver. The delete operation will continue, even if a remote journal does not have a full copy.

***IGNINQMSG**

Ignore inquiry message. Inquiry message CPA7025 will not be presented, even if this receiver has not been fully saved. Also, inquiry message CPA705E is not presented to the user even if the receiver is attached to a remote journal. The delete operation continues.

Related concepts

Manual versus system journal-receiver management

When you create a journal with System i Navigator or the Create Journal (CRTJRN) command, you can select to have either system managed or user managed journal receivers.

Automatic deletion of journal receivers

If you choose system journal receiver management, you can also have the system delete journal receivers that are no longer needed for recovery. You can only specify this if you are using system journal receiver management.

Related tasks

Inactivating the replication of journal entries to a remote journal

When you end replication of journal entries to a remote journal, it is recommended that the replication of entries be ended from the source system whenever possible, rather than from the target system. Usually, ending replication from the target system for a remote journal is only necessary when the source system has failed, and the system has not ended the remote journal function.

Related reference

QIBM_QJO_DLT_JRNRCV exit point

Deleting journals

Each journal on the system causes additional time and resource to be used when you restart the system or vary on an independent disk pool after an abnormal end. If you no longer need a journal, you can delete it.

The system does not allow you to delete a journal if any of the following conditions exist:

- You are journaling objects to it.
- Commitment control is active, and the journal is associated with a commitment definition.

Note: If you have certain types of referential constraints defined, the system starts commitment control if it is not already started. For example, if you have defined a cascaded delete constraint for an object, the system starts commitment control if you open the object for a delete operation. The default commitment definition that is created is active until the job ends.

- Any of the associated remote journals have a journal state *ACTIVE.

If you no longer need a journal and its associated receivers, perform the following steps:

1. Use the Work with Journal Attributes (WRKJRNA) command to determine the following:
 - Which objects are being journaled to this journal.
 - Whether or not commitment control is active and the journal is associated with it.
2. If commitment control is active and the journal is associated with it, end commitment control with the End Commitment Control (ENDCMTCTL) command.
3. End journaling for all objects associated with the journal.
4. If any commitment definitions are active that use this journal as the default journal, use the ENDJOB command to end the jobs that are using the commitment definitions. This includes commitment control that is started because of a referential constraint.
5. If any remote journals have a journal state of *ACTIVE, inactivate them.
6. Delete the journal by doing the following steps:
 - a) With IBM Navigator for i, connect to the system you want to use.
 - b) Expand **Journal Management**.
 - c) Select **Set Database/Library to use with Journal Tasks** and specify the database and library that you want to work with.
 - d) Select **Journals..**
 - e) Select the journal you want to delete and the **Delete** action.
 - f) At the **Confirm Object Deletion** dialog click **Delete**.
7. Delete the journal receiver.

You can also use the Delete Journal (DLTJRN) command to delete the journal and the Delete Journal Receiver (DLTJRNCV) command to delete the journal receiver.

Related tasks

Ending journaling

This topic provides information about how to end journaling and why ending journaling might be necessary.

Inactivating the replication of journal entries to a remote journal

When you end replication of journal entries to a remote journal, it is recommended that the replication of entries be ended from the source system whenever possible, rather than from the target system. Usually, ending replication from the target system for a remote journal is only necessary when the source system has failed, and the system has not ended the remote journal function.

Deleting journal receivers

Journal receivers can quickly use a lot of auxiliary storage space. Therefore an important journal management task is to delete journal receivers after you no longer need them.

Related reference

[Delete Journal \(DLTJRN\) command](#)

[Delete Journal Receiver \(DLTJRRCV\) command](#)

Saving and restoring journals and journal receivers

You must save the journal receivers when they are no longer attached, so that you have all the journal entries saved.

Using a save-while-active operation to save objects before they reach a commitment boundary can result in objects that are saved with partial transactions. Saving journal receivers ensures that they are available to recover objects that are restored with partial transactions.

When you save a journal receiver that is no longer attached, you can free storage. However, a journal receiver whose storage has been freed must be restored before you can use it for recovery.

Notes:

- Saving journals and journal receivers in the [Back up your server](#) topic provides more information about saving journals and journal receivers. Example: Recover objects with partial transactions has instructions for recovering objects with partial transactions.
- Read the Code example disclaimer for important legal information.

Related concepts

[Back up your server topic](#)

Related tasks

Example: Recovering objects with partial transactions

If you restore an object that was saved with a save-while-active operation that specified that the object can be saved before it reaches a commitment boundary, it can have partial transactions. To recover objects that are in a partial state you must perform an apply or a remove journaled changes operation.

Using SAVCHGOBJ to save journal receivers

One technique for saving journal receivers is to use the Save Changed Object (SAVCHGOBJ) command. When you use the SAVCHGOBJ command to save journal receivers, ensure that you omit the attached journal receiver.

In the following example, all your journal receivers are in a library called RCVLIB. The currently attached journal receiver is MYJRCV0004.

```
SAVCHGOBJ OBJ(*ALL) OMITOBJ(MYJRCV0004) LIB(RCVLIB) OBJTYPE(*JRRCV)
          DEV(media-device-name) ENDOPT(*LEAVE)
```

This example saves all journal receivers that have any new entries since the entire library was saved but omits the currently attached journal receiver MYJRCV0004.

A possible disadvantage to using the SAVCHGOBJ command to save journal receivers is that you can accidentally save the journal receivers that are currently attached. Those journal receivers are saved as partial receivers. If you need to do a recovery, you may need to handle the error condition that occurs when you attempt to restore the partial receiver over the receiver that is currently on the system and has not yet been saved. Also, partial journal receivers make tasks such as displaying entries and performing apply and remove journaled changes operations more difficult. Therefore you must avoid saving attached journal receivers.

Note: Read the Code example disclaimer for important legal information.

Related reference

[Save Changed Objects \(SAVCHGOBJ\) command](#)

Methods to save journal receivers

Following are three methods to save journal receivers. The first method saves journal receivers individually. The two other methods save the journal receiver automatically.

Saving journal receivers individually

Use the Work with Journal Attributes (WRKJRNA) command to display the receiver directory for each journal. The receiver directory tells which journal receivers have not yet been saved. Then use the Save Object (SAVOBJ) command to save them.

The advantage to using this technique is that each journal receiver is saved only once. You will not have problems with duplicate names and partial receivers if you need to restore. The disadvantage to this technique is that it requires manual effort to determine the names of the journal receivers to be saved.

Saving journal receivers by name - Automated method 1

You can use a combination of system journal-receiver management and a control language (CL) program to automate most journal management tasks. Do the following:

- Specify a threshold size for the journal receiver.
- Specify MNGRCV(*SYSTEM), DLTRCV(*NO), and a message queue for the journal.
- Use a CL program to monitor the journal message queue for the message (CPF7020) that indicates that the system has successfully detached the journal receiver.
- Your CL program can then save the receiver that was detached and optionally delete it.

Saving journal receivers by name - Automated method 2

An alternate method of automatically saving journal receivers is to use a high level language program that uses the Retrieve Journal Information (QjoRetrieveJournalInformation) API. The program can use this API to determine the journal receiver directory and which receivers are not saved. The program can then save the journal receivers that are not marked as saved. You can set up this program to run on a regular basis or as part of normal processing.

Related information

[CL Programming](#)

Correct order for restoration of journaled objects

You must restore journals and their associated objects in the correct order when not using deferred journaling support.

For the system to automatically reestablish your journaling environment when not using deferred journaling support, objects must be restored in this sequence:

1. Journals
2. Based-on physical files
3. Dependent logical files
4. Other journaled object types
5. Journal receivers

You can restore journal receivers at any point after you restore the journals. You do not need to restore them after the journaled objects.

When these objects are in the same library, the system restores them in the correct sequence. When these objects are in different libraries or directories, you must restore them in the correct sequence, or you must manually reestablish your journaling environment after the restore operation.

You can restore journal receivers in any sequence. After restoring them, use option 9 (Associate receivers with journal) from the **Work with Journal (WRKJRN)** command display to build the receiver chain in the correct sequence. You can also use Option 9 to build the receiver chain if you restore the journal after the journal receivers. The journal must be on the system for the receiver chain to be built.

If you restore journaled objects before restoring the journal, you must start journaling again.

Your journals and journal receivers can be in different libraries. If this is true, you must ensure that the library that will contain the journal receivers is on the system before restoring the journal. Ensuring this will also ensure that the journal receiver is created in the desired library, since a journal receiver is created when the journal is restored. Only the library needs to be on the system, not the journal receivers in that library. If you do not ensure this, you may need to create a journal receiver in the desired journal receiver library. You would then have to run the **Change Journal (CHGJRN)** command to attach the new receiver to your journal.

Related concepts

Journal receiver chains

Journal receivers that are associated with a journal (that is presently or previously attached to the journal) are linked in one or more **receiver chains**. Each journal receiver, except the first one, has a previous receiver that was detached when the current receiver was attached. Each journal receiver, except the one that is currently attached, also has a next receiver.

Deferring object journaling during restore

Using deferred journaling support allows the system to manage the reestablishment of journaling of objects after a restore.

Related tasks

Starting journaling

This topic provides information about how to start journaling for all object types.

Related reference

Change Journal (CHGJRN) command

Related information

Backup and Recovery

Deferring object journaling during restore

Using deferred journaling support allows the system to manage the reestablishment of journaling of objects after a restore.

Previously, restoring journaled objects from multiple libraries or from a library other than the library of the dependent journal was difficult to manage. If a journaled object was restored before the library of the journal, the object was not journaled. After the journal was restored, the user had to manually start journaling for each of the restored objects. With deferred journaling, the journaling of objects during restore can be deferred when there is a dependency on a journal in a library that does not yet exist. The journal information is cached and used to start journaling after the journal becomes available. This eliminates the manual effort that is required to restart journaling.

To defer the journaling of objects on restore when the journal does not yet exist, specify the **Defer ID (DFRID)** parameter on the **Restore Library (RSTLIB)** or **Restore Object (RSTOBJ)** command. Specifying the same defer ID for multiple restore operations provides an association between the deferred journaling information and the dependent journal.

When the journal becomes available, the **Restore Deferred Objects (RSTDFROBJ)** command can be used with the previously specified defer ID to start journaling using the deferred journaling information.

After the deferred journaling operation completes, use the **Remove Defer ID (RMVDFRID)** command to remove the deferred journaling information from the cache.

When journaling is started for the object because of a **RSTDFROBJ**, the restore and create journal entries for these objects will not be generated because the object which deferred start journaling was created before the creation of the journals.

If a user has save system (*SAVSYS) special authority and uses the **RSTLIB** command and specifies the *NONSYS, *ALLUSR, or *IBM values for the **Saved Library (SAVLIB)** parameter and specifying *DFT for the **DFRID** parameter, the system manages the deferred journaling information. In all other cases, if the user omits the **DFRID** parameter, the user must manage the start journaling requests.

Multiple restore operations can run concurrently using the same defer ID. It is best to wait until all of the restore operations are complete for that defer ID before issuing the **RSTDFROBJ** or **RMVDFRID** commands. Issuing the **RSTDFROBJ** command while restores are still running can cause extra work in processing. Issuing the **RMVDFRID** command while restores are still running can cause deferred journaling information to be lost.

If a journaled object is restored with either the **RSTLIB** or **RSTOBJ** with a defer ID specified and the object is renamed or moved to a different library before the issuance of the **RSTDFROBJ** command, journaling will not be started for that object.

When an object is restored into a journaled library with a *RESTORE inherit rule defined and a Defer ID specified, the Defer ID takes precedence. If the journal the object was journaled to at save time does not exist a deferral record is written and the object is not journaled to the journal specified by the *RESTORE inherit rule.

When restoring an object into a journaled library that has a *RSTOVRJRN inherit rule defined, the object attempts to automatically start journaling to the journal used by the library, regardless of whether the object was journaled when it was saved, what the journal target was at save time, or if a defer id was specified on the restore.

When restoring an object into a library that contains a data area named QDFTJRN that has a *RSTOVRJRN rule defined, the object attempts to automatically start journaling to the journal specified in the QDFTJRN data area, regardless of whether the object was journaled when it was saved, what the journal target was at save time, or if a defer id was specified on the restore. If the journal specified in the QDFTJRN data area does not exist and a defer id was specified on the restore, the start of journaling is deferred.

Deferred restore examples

This command restores all the saved non-system libraries to the system from tape. The system manages the deferred journaling for objects that are restored before their journal is restored. The system attempts to automatically start journaling of the dependent objects when the journal is finally restored.

```
RSTLIB SAVLIB(*NONSYS) DEV(TAP01) DFRID(*DFT)
```

The next examples show libraries that are being restored using a DFRID. Library JRNLIB contains the journals that the objects in library OBJLIB were journaled to. The objects in OBJLIB cannot start journaling until after the journals in JRNLIB are restored. A defer ID is specified, so the start journaling requests are deferred. Use the **RSTDFROBJ** command to start journaling these files. The **RMVDFRID** command removes information about objects that were deferred during the restore operation.

```
RSTLIB SAVLIB(OBJLIB) DEV(TAPE01) ENDOPT(*LEAVE) DFRID(ABC)
```

```
RSTLIB SAVLIB(JRNLIB) DEV(TAPE01) ENDOPT(*LEAVE) DFRID(ABC)
```

```
RSTDFROBJ DFRID(ABC)
```

```
RMVDFRID DFRID(ABC)
```

Related reference

[Restore Library \(RSTLIB\) command](#)

[Restore Deferred Objects \(RSTDFROBJ\) command](#)

[Remove Defer ID \(RMVDFRID\) command](#)

Evaluation of how system changes affect journal management

After you have established your journaling environment, you need to keep up with changes that occur on your system.

When you add new applications, evaluate whether to journal the objects.

If you use SMAPP, the system automatically considers new access paths when deciding how to meet your target recovery times for access paths.

Journaling places some limits on what changes you can make. For example:

- You cannot protect a logical file, either explicitly or with SMAPP, if the underlying physical files are journaled to different journals.
- You cannot move an object to a different disk pool from the disk pool of the library that contains its journal.

Keeping records of journaled objects

You must always have a current list of objects that you are journaling and their assigned journals. Print a new list whenever you add or remove objects from the journal.

To print a list, follow these steps:

1. Type WRKJRN.
2. Specify *ALL for both the **Journal** and **Library** fields.
3. Press **Enter** twice.
4. Write down the names of all the journals or use the PRINT key for each panel of the display.
5. For each journal in the list that is used to journal objects, type WRKJRNA JRN(*library-name/journal-name*) OUTPUT(*PRINT). Additionally, the WRKJRNA command can send the journaled objects to an outfile. The print and outfile option on the WRKJRNA command also allows subsetting the output of the journaled object types.

Keep the lists with your most recent set of backup media that you used to save the entire system. You can also use the Retrieve Journal Information (QjoRetrieveJournalInformation) API to retrieve information about your journaling environment.

You might need this list for the following reasons:

- You need to recover your journaling environment; for example, if the journal is damaged or deleted. Although you can recover your journaling environment by restoring the objects, in many cases starting journaling for the objects is a quicker and safer method.
- You create new access paths. The system cannot protect access paths, either explicitly or by using SMAPP, if the underlying physical files are not journaled to the same journal.
- You want to move objects to another disk pool. Journaled objects must be in the same disk pool as the journal, unless the objects are in the system disk pool and the journal is in a nonlibrary basic disk pool.

Choose the method for saving journal receivers that works best for your organization. Then be sure to keep track of what you do. Label your save media so that you know which journal receiver media volumes are required to apply journal changes to the last complete saved copy of the journaled objects.

Think through possible recovery scenarios. For example, assume this is your save procedure:

- You save all user libraries and directories on Sunday evening.
- You save changed objects every evening.
- You save journal receivers every 2 hours during normal business hours.

Given the preceding list, what are your recovery steps if you lose a journaled object at 3 p.m. on Thursday?

Related concepts

[Plan a backup and recovery strategy](#)

Related reference

[Retrieve Journal Information \(QjoRetrieveJournalInformation\) API](#)

Security management for journals

You can use journal management to provide an audit trail of changes that were made to your objects. You can determine which program or user made changes to objects by using the journal entries.

By specifying the FIXLENDTA parameter of the Change Journal (CHGJRN) or Create Journal (CRTJRN) commands you can specify that the following data is included in the journal entry:

- The job name.
- The effective user profile name.
- The program name.
- The program library name and the auxiliary storage pool device name that contains the program library.
- The system sequence number. The system sequence number gives a relative sequence to all journal entries in all journal receivers on the system.
- The remote address, the address family and the remote port.
- The thread identifier. The thread identifier helps distinguish between multiple threads running in the same job.
- The logical unit of work identifier. The logical unit of work identifies work related to specific commit cycles.
- The transaction identifier. The transaction identifier identifies transactions related to specific commit cycles.

For database physical files, you can determine what changes were made to specific records by using the **Compare Journal Images (CMPJRNIMG)** command. However, you cannot use the **CMPJRNIMG** command for journal entries that have minimized entry-specific data. If you specified the **MINENTDTA(*FILE)** or **MINENTDTA(*FLDBDY)** parameter on the **Create Journal (CRTJRN)** or **Change Journal (CHGJRN)** commands, you might have minimized entry-specific data.

Use Journal management to provide an audit trail because of the following reasons:

- No one, even the security officer, can remove or change the journal entries.
- Journal entries represent a chronological sequence of events.
- Each journal entry in the system is sequentially numbered without gaps until the CHGJRN command resets the sequence number.

Note: When you display the journal entries, there can be gaps in the sequence numbers because some journal entries are only used internally by the system. These gaps occur if you are using commitment control, database file journaling, or access-path journaling. To view the entries in the gaps, you can use the **INCHIDENT** parameter on the **Display Journal (DSPJRN)** command.

- The journal contains entries that indicate when each journal receiver was changed and the name of the next journal receiver in the chain.
- Whenever journaling for an object is ended or whenever an object is restored an entry is written.

Remember that the date and time recorded in the journal entries depends on the date and time entered during an IPL and therefore, may not represent the actual date and time. Also, if you use shared files, the program name that appears in the journal entry is the name of the program that first opened the shared file.

A special journal, that is called the audit (QAUDJRN) journal, can provide a record of many security-relevant events that occur on the system.

Related concepts

[Security](#)

Related information

[Security Reference](#)

Displaying information for journaled objects, journals, and receivers

IBM Navigator for i, Control Language commands, and APIs provide several ways for you to display information about journaled objects, journals, and journal receivers.

You can use Navigator for i to display information such as whether the object is journaled, the name of the object's journal, what library the object's journal is in, and which journaling options are being used. You can use Navigator for i to display journaling information for the following object types:

- Tables (database files)

- Libraries (through the QSYS.LIB file system)
- Data Areas (through the QSYS.LIB file system)
- Data Queues (through the QSYS.LIB file system)
- Integrated file system directories
- Integrated file system stream files
- Integrated file system symbolic links

Using Navigator for i, you can get information about one object at a time using the **Journaling** action, or about groups of objects journaled to a given journal using the **Show Journaled Objects** action. Use the following commands and APIs to get information about journaled objects:

- [Display File Description \(DSPFD\) command](#)
- [Display Object Description \(DSPOBJD\) command](#)
- [Display Object Links \(DSPLNK\) command](#)
- [Get Attributes \(Qp0lGetAttr\(\)\) API](#)
- [List Objects \(QUSLOBJ\) API](#)
- [Open List of Objects \(QGYOLOBJ\) API](#)
- [Work with Object Links \(WRKLNK\)](#)

Ways that you can display information about journal receivers are as follows:

- IBM Navigator for i **Journal Receivers properties** dialog
- [Display Journal Receiver Attributes \(DSPJRNRCVA\) command](#)
- [Retrieve Journal Information \(QjoRetrieveJournalInformation\) API](#)
- [Work with Journal Attributes \(WRKJRNA\) command](#)
- [Retrieve Journal Receiver Information \(QjoRtvJrnReceiverInformation\) API](#)

These methods can identify:

- The journal receivers currently attached to the journal.
- A directory of the journal receivers still on the system that are associated with the journal.
- The names of all of the objects that are being journaled instead of the journal.
- The commitment control uses of this journal.
- The attributes of the journal.
- Information about all remote journals that are associated with the journal.
- Fixed-length data
- ASP of the journal receiver
- Minimized entry data
- The next and previous journal receiver information

You can find the status of a journal receiver by using the WRKJRNA command, then pressing F15 (Receiver directory) from the Work with Journal Attributes display. You can also use the DSPJRNRCVA command. Or in Navigator for i, you can find the status of a journal receiver by doing the following steps:

1. With Navigator for i, connect to the system with the journal receiver
2. Expand **Journal Management**.
3. Select **Set Database/Library to use with Journal Tasks** and specify the database and library that you want to work with.
4. Click **Show All Journal Tasks**.
5. Select the **Journal Receivers** list.
6. Select the journal receiver, and the **Properties** action.

When the journal receiver is in partial status, the **partial** status of a journal receiver indicates the following:

- The disk unit on which the journal receiver is stored is damaged. No more journal entries can be recorded.
- A journal receiver was saved while it was attached to the journal. This means that additional entries may have been recorded in the journal receiver after the save operation occurred. The receiver was later restored, and no complete version is available.
- The journal receiver is associated with a remote journal. It does not contain all the journal entries that are in the associated journal receiver that is attached to the source journal.
- A partial receiver does not contain all the entries that are recorded in the journal while this receiver was attached. It does contain entries that are recorded up to the last save operation.
- The most complete version of the journal receiver is no longer on the system because it was destroyed during a failure.
- You have restored an older, partial version.

Working with inoperable journal receivers

If you have specified journaling for any objects, the system ensures that you have corrected problems that affect journaling before continuing with operations on those objects. If the attached journal receiver becomes inoperable, the operation that writes a journal entry is interrupted and the system sends an inquiry message that notifies the system operator.

The operator can swap the journal receiver with System i Navigator or the Change Journal (CHGJRN) command. You can then respond to the inquiry message. A receiver can become inoperable if the receiver is damaged, the maximum sequence number has been reached, or there is no more space.

Related tasks

Swapping journal receivers

An important task for journal management is to swap journal receivers. You typically swap journal receivers when they reach their storage threshold. You can swap journal receivers either with IBM Navigator for i or with the Change Journal (CHGJRN) command. If you use system journal-receiver management, the system changes journal receivers for you.

Related reference

[Change Journal \(CHGJRN\) command](#)

Comparing journal images

You can use the Compare Journal Images (CMPJRNIMG) command to compare and list the differences between the before-image of a record and the after-image of that record, or the after-image of a record with the previous after-image of that record.

Note: If you are using maximum receiver-size option RCVSIZOPT(*MAXOPT3) and your entry sequence numbers exceed 9 999 999 999, specify the FROMENTLRG and TOENTLRG parameters when you use the CMPJRNIMG command.

You can only use the CMPJRNIMG command for journaled physical database files. You cannot use the CMPJRNIMG command for journal entries that have minimized entry-specific data. If you specified the minimized entry-specific data (MINENTDTA(*FILE) or MINENTDTA(*FLDBDY) parameter on the Create Journal (CRTJRN) or Change Journal (CHGJRN) commands, the journal entries might have minimized entry-specific data, preventing you from being able to compare journaled images.

If the journaled files have null-capable fields, the null value indicators corresponding to the fields in the before-image of the record are compared with the null value indicators corresponding to the fields in the after-image of the record. A field-by-field basis compare does this.

The printed output from the CMPJRNIMG command shows the before-images and after-images of a record followed by a line that indicates (with asterisks) the specific change in the record on a character-

by-character basis. If you compare the after-images, the output shows the previous after-image of the record and the current after-image of the record, followed by a line indicating the changes.

If you use this command to compare journal images for a file that contains any fields of data type BLOB (binary large object), CLOB (character large object), or DBCLOB (double-byte character large object), these fields are not included in the comparison. All other fields in the file are compared.

Working with IBM-supplied journals

The operating system and some licensed programs use journals to provide audit trails and assist with recovery.

The following table lists some of the IBM-supplied journals:

| Journal name | Library name | Description |
|--------------|--------------|---|
| QACGJRN | QSYS | Keeps job accounting information. Job Accounting in the Work Management topic describes the use of this optional journal. |
| QAOSDIAJRN | QUSRSYS | Provides recovery for the document library files and the distribution files. Used by Integrated xSeries Server. |
| QASOSCFG | QUSRSYS | The journal for the QASOSCFG physical file. The QASOSCFG file stores secure client SOCKets Secure (SOCKS) configuration data. The Client SOCKS support topic provides more information about SOCKS. |
| QAUDJRN | QSYS | Keeps an audit record of security-relevant activity on the system. The Security Reference describes this optional journal. |
| QCQJMJRN | QUSRSYS | Provides an audit trail for Managed System Services. |
| QDSNX | QUSRSYS | Provides an audit trail for DSNX activity. |
| QIPFILTER | QUSRSYS | Provides information for troubleshooting and auditing IP filter rules. See the IP filtering and network address translation topic for more information about IP filtering rules. |
| QIPNAT | QUSRSYS | Provides information for troubleshooting and auditing network address translation (NAT). See the IP filtering and network address translation topic for more information about NAT. |
| QLYJRN | QUSRSYS | Keeps a log of transactions made to the Application Development Manager datastore files. |
| QLYPRJLOG | QUSRSYS | Keeps the project logs for the Application Development Manager licensed program. Used by the system if recovery is necessary. |
| QLZALOG | QUSRSYS | Used by the licensed management program to log requests that exceed the usage limit of a license. |
| QPFRADJ | QSYS | Keeps a log of dynamic performance tuning information. Job Accounting in the Work Management topic describes using this optional journal. |

| Journal name | Library name | Description |
|--------------|--------------|--|
| QPMCCCAJRN | QUSRSYS | A system managed journal used internally by performance data collectors to insure the integrity of their database transactions. |
| QSNADS | QUSRSYS | Provides an audit trail for SNADS activity. |
| QSZAIR | QUSRSYS | A journal for Storage Management Services (SMS) |
| QSNMP | QUSRSYS | Provides an audit trail for network management information. Simple Network Management Protocol (SNMP) describes using this journal. |
| QSXJRN | QUSRSYS | Provides a log of the activity that occurs in the database files for service-related activity. Keep the information in this journal for 30 days. |
| QTOVDBJRN | QUSRSYS | A journal for virtual private networking (VPN). |
| QVPN0001 | QUSRSYS | Provides an audit trail for Virtual Private Networking (VPN) connections. TCP/IP Configuration and Reference describes this journal. |
| QYPSDBJRN | QUSRSYS | A journal for the systems management platform |
| QZCAJRN | QUSRSYS | Contains a record for each SNMP PDU in and out of the SNMP agent, by PDU type (SNMP GET, SNMP GETNEXT, SNMP SET, SNMP TRAP). |
| QZMF | QUSRSYS | Provides an audit trail for the mail server framework. AnyMail/400 Mail Server Framework Support provides more information about this journal. |

If you are using licensed programs or system functions that require these journals, consult the documentation for those functions for instructions on how to manage the journals and journal receivers.

In general, you swap journal receivers to detach the journal receiver and create and attach a new receiver on a regular basis. You may need to save detached receivers before deleting them, or you may be able to delete them without saving them. This depends on how the journal receivers are being used and whether the journal is using system journal-receiver management.

In some cases, you can use the automatic cleanup function of Operational Assistant to remove detached journal receivers that are no longer needed.

Related concepts

[Manual versus system journal-receiver management](#)

When you create a journal with System i Navigator or the Create Journal (CRTJRN) command, you can select to have either system managed or user managed journal receivers.

Related tasks

[Swapping journal receivers](#)

An important task for journal management is to swap journal receivers. You typically swap journal receivers when they reach their storage threshold. You can swap journal receivers either with IBM

Navigator for i or with the Change Journal (CHGJRN) command. If you use system journal-receiver management, the system changes journal receivers for you.

Sending your own journal entries

You can use the Send Journal Entry (SNDJRNE) command or the Send Journal Entry (QJOSJRNE) API to add your own entries to a journal. The system places these entries in the journal's attached journal receiver along with the system-created journal entries.

To help identify your entries, you can associate each entry with a particular journaled object. If you use the QJOSJRNE API, you can include the commit cycle identifier with the journal entry and send a larger amount of entry-specific data.

You may add entries to the journal to identify significant events (such as a checkpoint) or to help in the recovery of your applications. On the SNDJRNE command, the data specified on the ENTDTA parameter becomes the **Entry-Specific Data** field in the journal entry, and the TYPE parameter value becomes the **entry type** field. On the QJOSJRNE API, you use the entry data parameter to specify the entry-specific data and the journal entry type parameter to specify the entry type. For both the command and API deposits, the entries journal code is 'U'.

The maximum user entry data size for the QJOSJRNE API is 15 MB, which is the maximum journal entry size for a journal that does not have one of the receiver maximums chosen (RCVSIZOPT(*MAXOPT1/*MAXOPT2/*MAXOPT3)). If the length of the entry data is greater than 32KB, then a pointer to the entry data will be returned when retrieving the entry. If the retrieve interface is expecting pointers, the data can be accessed through the pointer returned on the retrieve. Otherwise, the data returned by the retrieve interface will be *POINTER.

The QJOSJRNE API optionally returns the following values in the location specified by the receiver variable:

- Number of bytes returned in the receiver variable
- Number of bytes available that could have been returned in the receiver variable
- Sequence number of the journal entry that was just deposited
- Journal receiver name
- Journal receiver library
- Independent Auxiliary Storage Pool (IASP) name

Changing the state of local journals

Local journals can be in one of two states, active or standby. When the journal state of a local journal is active, journal entries are allowed to be deposited to the journal receiver.

Journal standby state is a separately purchased feature that prevents most journal entries from being deposited into the journal. Standby state is enabled by option 42 of the IBM i operating system. You can start or end journaling objects while the journal is in standby. However, when a journal is in standby state, you cannot use explicit commitment control. Also, records within database files that have referential integrity constraints cannot be modified, when the underlying journal is in standby state unless RESTRICT is specified on the ON UPDATE or ON DELETE attribute for the constraint. Additionally, records within database files that have data links defined cannot be modified when the underlying journal is in standby state.

An example of when you might want to put a journal into standby state is if the journal is on a backup system and you want the replicated copies of your objects on that system to incur very low overhead until role swap time. By having the journal in standby state until role swap time, a switchover to the target system can be accomplished more quickly because all objects on the backup system can remain journaled thus allowing the switchover processing to skip the costly step of starting journaling for all objects. Until the journal leaves standby state and reverts to active state the backup system is not incurring the overhead of journaling because most journal entries are not deposited when the journal is in standby state.

If there is an attempt to deposit a journal entry when the journal is in standby state, no entry is deposited, nor are any error messages sent to the application. In order to flag the transitions in and out of standby state, journal codes 'J' and entry types 'SI' and 'SX' are deposited when the local journal is put into and out of standby. Even though the journal state is standby, and most journal entries are not deposited, there are a few critical journal entries that will be deposited in a journal. Use the Journal entry information finder to see if a journal entry is still deposited even though the journal is in standby state.

Additionally, when a journal is in standby state the system elects not to provide System-Managed Access-Path Protection (SMAPP) for any access paths built over files journaled to the journal and flags the access paths as not eligible for SMAPP protection. These access paths remain not eligible until the underlying journal leaves standby state and reverts to active state. Because the access paths are not eligible for protection, in some select instances system performance may be negatively impacted when a journal is changed to standby state. This would most likely occur if the access paths are large and are actively being changed. Under those conditions the underlying SMAPP mechanism attempts to compensate by enabling SMAPP protection for multiple small access paths whose keys are changing and whose underlying physical files are not associated with journals in standby state.

Also, abnormal IPL duration or the vary on of an independent Auxiliary Storage Pool (ASP) duration may be affected if standby state is chosen because some access paths that are no longer eligible for protection may need to be rebuilt.

If performance degrades after switching to standby state, then some investigation should be done to determine if standby state is a primary contributing factor. To reduce any potential performance impact, INCACCPH(*ELIGIBLE) can be specified on the Change Recovery for Access Paths (CHGRCYAP) command. Specifying INCACCPH(*ELIGIBLE) will reduce potential overhead but will expose you to a potentially longer IPL or vary on of an independent ASP. As with many other options, deciding to use standby state is a trade off between run time performance and IPL or independent ASP vary on duration.

To ensure that switching to standby state is not causing undo IPL or independent ASP vary on concerns, use the Display Recovery for Access paths (DSPRCYAP) command periodically to display the estimated access path recovery time. If this value is much larger than the target access path recovery time and the total not eligible recovery time is greater than zero, then use F13 (Display Not Eligible Access Paths) to display a list of the not eligible access paths. This will identify the access paths not eligible for SMAPP protection along with a reason for their not eligible status. If the access paths with the highest estimated rebuild times are not eligible due to standby, then you may wish to reconsider your standby choice. In lieu of standby, you may want to consider journal caching, which often provides nearly as much performance relief.

When a local journal is created, the journal state of that journal is *ACTIVE. This means that journal entries can be deposited to the local journal. If a local journal is in standby state, journal entries with journal code 'J' and entry type 'LA' are deposited when the local journal is activated.

If a local journal has been put in standby state, activate it by doing the following:

1. With IBM Navigator for i connect to the system you want to use.
2. Expand **Journal Management**.
3. Select **Set Database/Library to use with Journal Tasks** and specify the database and library you want to work with.
4. Select **Journals**.
5. Select the journal, and select **Properties**.
6. On the **Journal Properties** dialog select **Active for the Journal State**.

You can also use the Change Journal State (QjoChangeJournalState) API or Change Journal (CHGJRN) command to activate the local journal.

Related reference

[Change Journal State \(QjoChangeJournalState\) API](#)

[Change Journal \(CHGJRN\) command](#)

Related information

[Journal entry information finder](#)

Work with messages on the journal message queue

The journal message queue is used to communicate information about the journal environment. This will include messages for normal journal processing and error situations. You may wish to monitor the journal message queue for messages. The **Work with Journal Attributes (WRKJRNA)** command indicates the message queue associated with the journal. The **Display message queue (DSPMSGQ)** command can be used to display the messages on the queue.

The messages that are sent to the journal message queue are listed as follows:

CPI6956

Not able to call exit programs registered for the QIBM_QJO_CHG_JRNRCV related exit point. The system will retry.

CPI7019

Journal &1 approaching limit of journaled objects.

CPI7020

A journal's recovery count is being exceeded. This may affect system performance.

CPI70B7

Changes for a journaled object could not be forced to disk. User action may be required.

CPI70E1

The system was not able to delete a journal receiver due to an unexpected exception. You should investigate why this error occurred.

CPI70E3

A system managed change journal operation to attach a new journal receiver could not be accomplished. User action is required to attach a new journal receiver at this time.

CPI70E5

A system managed change journal operation could not be accomplished because a journal or journal receiver was not available. No user action is required, the system will retry the operation when the specified manage receiver delay time has passed.

CPI70E6

A journal receiver was not available. If the system is to delete the journal receiver, it will try again when the delete receiver delay time has passed. The reason code on this message may indicate that an exit program is preventing the deletion of the journal receiver. If this condition persists you may need to investigate why the message is being issued.

CPI70E7

The sequence number for a journal is approaching its maximum allowed value. The sequence number for the journal should be reset via a change journal command. Journaling will stop if the sequence number is not reset and the maximum sequence number is reached.

CPF7020

A journal receiver was detached from a journal. No action is required, but you may wish to save off the journal receiver at this time.

CPF7099

The threshold has been reached for a journal receiver that is attached to a user managed journal. You should attach a new journal receiver at this time.

Scenario: Journal management

This topic provides the steps that a fictitious company, JKL Toy company, takes as it implements journal management.

Sharon Jones, the system administrator for the JKL Toy Company, is responsible for backing up their servers and making sure that their servers can be recovered in the event of a natural disaster or system failure. As security officer, she is also responsible for ensuring the security of the servers.

The JKL Toy Company has a network that consists of a development server, a production server, and an HTTP server. The following diagram shows the network layout:

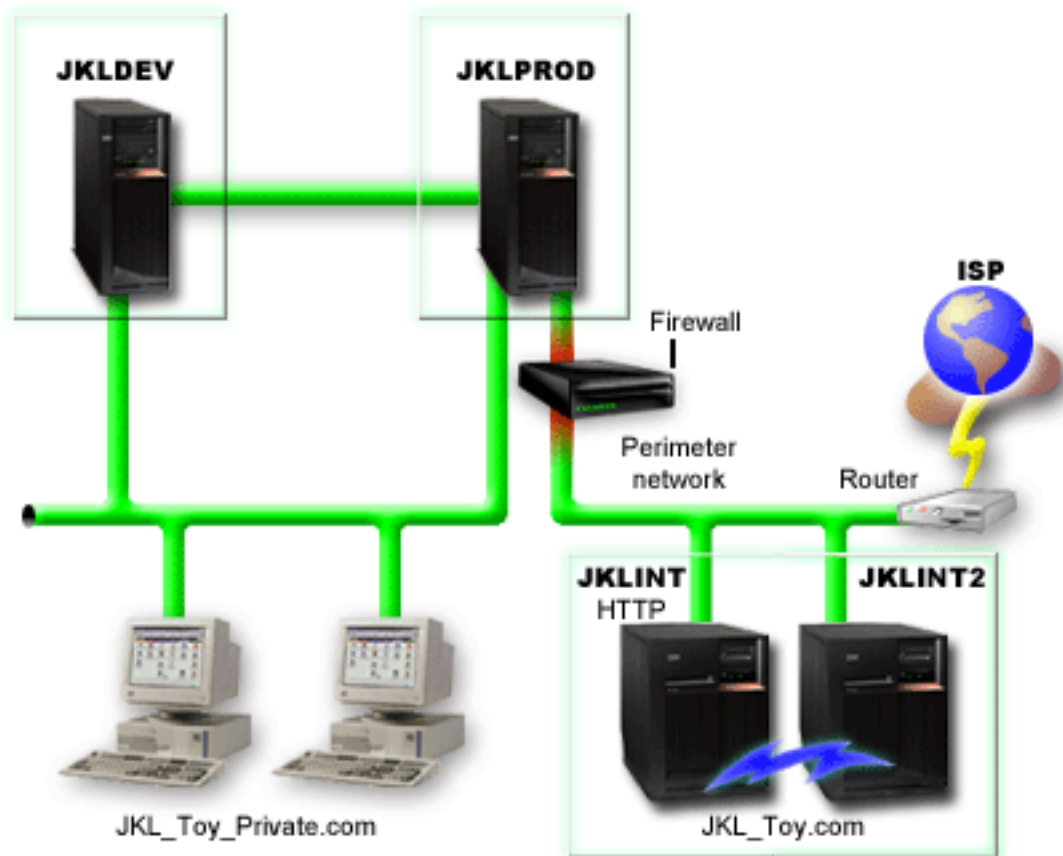

Related tasks

Scenario: Backup using BRMS

JKLPROD

JKLPROD is the system that JKL uses for all of their customer orders and where their business applications are installed (inventory control, customer orders, contracts and pricing, accounts receivable). The information about this server is extremely critical to their business and changes often.

Also, there are several users who have remote access to the system from home connection. In addition, even though the company's web site is static, the company has plans to establish a transactional site. Because of the importance of the information about JKLPROD, Sharon wants to be able to audit the activity that occurs on the system.

JKLPROD journaling strategy

Since the objects on JKLPROD are crucial to JKL, and since they change often, Sharon has decided that they are good candidates for journaling.

- Since there are access paths that are critical to her operation, Sharon journals access paths.
- Sharon already separates the information about JKLPROD on separate disk pools:
 - Disk pool 2 - inventory control
 - Disk pool 3 - customer orders
 - Disk pool 4 - contracts and pricing
 - Disk pool 5 - accounts receivable

Since the journal and the journaled objects must be in the same disk pool, Sharon creates four journals.

- Since she wants to audit the activity that occurs on the system, and since people have remote access to the system, Sharon journals fixed-length data using the following values:

- Job name (*JOB)
- User profile (*USR)
- Program name (*PGM)
- Remote address (*RMTADR)
- Since Sharon is using the FIXLENDTA parameter, she cannot minimize the fixed-length portion of the journal entries.
- Because she is using the FIXLENDTA parameter for all of the journals, and since she is journaling access paths Sharon uses the character-based interface to set up journaling.

Related concepts

Planning which objects to journal

When you plan which objects to journal, consider the following:

Reasons to journal access paths

If you journal access paths, the system can use the journal entries to recover access paths instead of rebuilding them completely.

IBM Navigator for i versus the character-based interface for journaling objects

There are two environments that you can use for journal management: IBM Navigator for i and the character-based interface. Navigator for i provides a graphical interface for journaling that is easy to use and does not require the use of control language (CL) commands. The character-based interface requires the use of CL commands or APIs, but has more functionality than Navigator for i. Some of this function is also available through the System i Navigator.

JKLINT

JKLINT is the system that JKL uses for their Web site and e-mail. While this data is critical to their business, it is fairly static.

They need 24x7 availability for the critical data on this server, and they accomplish that by having a second server, JKLINT2, that shadows JKLINT. They use a high availability replication solution to copy the data from JKLINT to JKLINT2. Then, if JKLINT goes down, they can switch to JKLINT2.

Since Sharon is using a high availability solution she uses remote journaling with the two servers.

Scenarios: Remote journal management and recovery description shows the different ways that Sharon can set up remote journaling between JKLINT and JKLINT2.

Related information

Scenarios: Remote journal management and recovery

These scenarios describe the possible ways that JKL Toy Company can use remote journal management. JKL Toy Company uses the server JKLINT as their web server.

JKLDEV

JKLDEV is JKL's development server. Though it does not require 24x7 availability, the data on it represent many person hours of work by the developers. Therefore it is important that in the event of a crash, the system be brought to a current state. Also, since it is a development server, changes to the data occur often.

JKLDEV is used by both web and database developers. So several different types of data are stored on this server, including stream files and database files.

JKLDEV journaling strategy

Since many of the objects on JKLDEV are important and changes often, Sharon has decided that they are good candidates for journaling.

JKLDEV is used by both web and database developers, so there are several physical files, and many stream files that she wants to journal. Sharon has decided to do the following:

- Since none of the access paths are critical to her operation, Sharon does not journal access paths.

- To simplify setup and recovery, Sharon assigns all of the objects to one journal.
- Since there are many stream files to journal, Sharon journals the integrated file system directories, in addition to individual files. She elects to use the **Current folder and all subfolders** option and **Journal new files and folders** option. This choice ensures that the objects currently in the directory and in any subfolders are journaled and objects that are created in the future are also journaled.
- Since journaling with the **Journal new files and folders** option can quickly make the journal receiver size grow quickly, she uses system journal-receiver management.
- Because it supports all of the options she has chosen, Sharon sets up journaling on System i Navigator.

Related concepts

Planning which objects to journal

When you plan which objects to journal, consider the following:

Reasons to journal access paths

If you journal access paths, the system can use the journal entries to recover access paths instead of rebuilding them completely.

Object assignment to journals

You can use one journal to manage all the objects you are journaling. Or, you can set up several journals if groups of objects have different backup and recovery requirements. Every journal has a single attached receiver. All journal entries for all objects being managed by the journal are written to the same journal receiver.

Manual versus system journal-receiver management

When you create a journal with System i Navigator or the Create Journal (CRTJRN) command, you can select to have either system managed or user managed journal receivers.

Recovery operations for journal management

This topic provides instructions about how to use journaling to recover data on your system.

You can perform recovery tasks if you have an abnormal system end, need to recover a damaged journal, journal receiver, or journaled object.

Determining recovery needs using journal status

You can use the Work with Journal (WRKJRN) command to display the damage status of a journal and display whether or not the last IPL was normal.

Option 5 on the Work with Journal display shows the current status of the journal. It shows if the last system end was Normal or Abnormal, and if the journal is damaged. The damage status is None or Full.

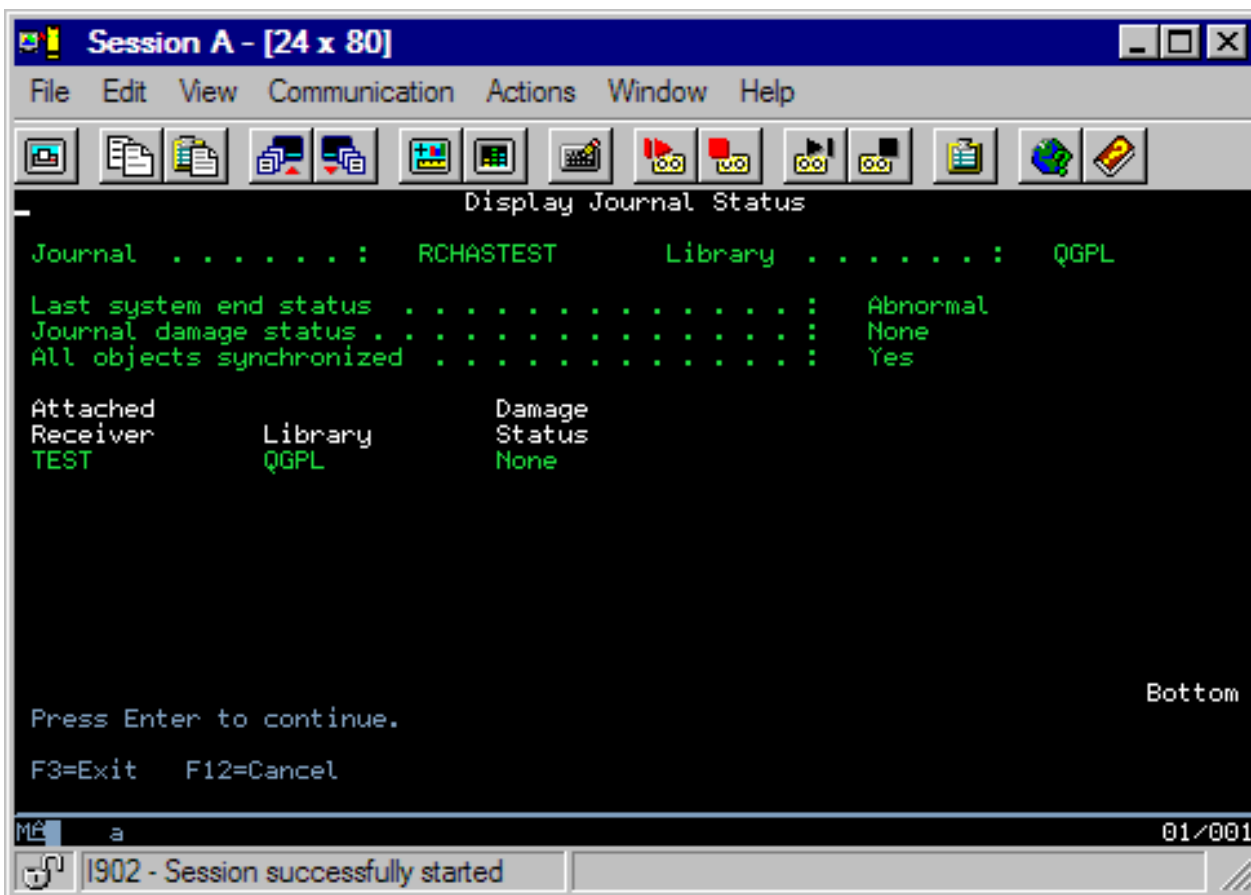

If the last system end was abnormal, this display indicates whether the system synchronized the journaled objects or not. This indicates if the system synchronized each object in use during the abnormal end to match the entries in the attached journal receiver during the previous initial program load (IPL) or vary on of an independent disk pool.

If the last system end was normal, the display indicates that all objects are synchronized with the journal. If the journal is damaged, the display indicates that the system was unable to determine whether or not all objects are synchronized.

The display also presents information about the currently attached receiver and its damage status. The damage status of the receiver can be None, Partial, or Full. If the journal damage is such that the system cannot determine the status of the attached journal receiver, no attached receiver shows on the display.

If some objects are not synchronized or damage has been detected, a message appears indicating the form of recovery that you must perform.

Recovery for journal management after abnormal system end

This topic describes the recovery actions that take place in the event of an abnormal system end.

If the system abnormally ends while you are journaling objects, the system does the following:

1. Brings all journals, journal receivers, and objects you are journaling to a usable and predictable condition during the IPL or vary on of an independent disk pool, including any access paths being journaled and in use at the time the system abnormally ended.
2. Checks all recently recorded entries in the journal receivers that were attached to a journal.
3. Places an entry in the journal to indicate that an abnormal system end occurred. When the system completes the IPL or vary on of an independent disk pool, all entries are available for processing.
4. Checks that the journal receivers attached to journals can be used for normal processing of the journal entries. If some of the objects you are journaling could not be synchronized with the journal, the

system sends message CPF3172 to the history log (QHST) that identifies the journals that could not be synchronized. If a journal or a journal receiver is damaged, the system sends a message to the history log identifying the damage that occurred (message CPF3171 indicates that the journal is damaged, and messages CPF3173 or CPF3174 indicate that the journal receiver is damaged). If a journal or journal receiver is found to no longer exist within a library, the system sends message CPI70EE to the history log.

5. Recovers each object that was in use at the time the system ended abnormally, using the normal system recovery procedures for objects.

In addition, if an object being journaled was opened for output, update, or delete operations, the system performs the following functions so changes to that object will not be lost:

1. Ensures that the changes appear in the object. Changes that do not appear in the journal receiver are not in the object.
2. Places an entry in the journal receiver that indicates whether the object was synchronized with the journal. For database files, if the file could not be synchronized with the journal, the system places message CPF3175 in the history log identifying the failure, and you must correct the problem. For other journaled objects, the system places message CPF700C in the history log identifying the failure, and you must correct the problem.

A synchronization failure can occur if the data portion of the object is damaged, a journal receiver required to perform the synchronization is damaged, or the journal is inoperable.

After an abnormal system end, perform the following steps:

1. Perform a manual IPL.
2. Check the history log to determine if there are any damaged objects, objects that are not synchronized, or any damaged journals or journal receivers.
3. If necessary, recover the damaged journals or journal receivers as described in *Recover a damaged journal receiver* and *Recover a damaged journal*.
4. If there is a damaged object:
 - a) Delete the object.
 - b) Restore the object from the latest saved version.
 - c) Allocate the object so no one else can access it.
 - d) Restore the needed journal receivers if they are not online. Journal receivers do not need to be restored in a particular sequence. The system establishes the receiver chains correctly when they are restored.
 - e) Use the APYJRNCHG or APYJRNCHGX command to apply the changes to the object.
 - f) Deallocate the object.
5. If an object could not be synchronized, use the information in the history log and in the journal to determine why the object could not be synchronized and how to proceed with recovery. For example, you may need to use the DFU or a user-written program to bring a database file to a usable condition.
6. Determine which applications or programs were active, and determine where to restart the applications from the information in the history log and in the journal.

If a journaled access path is in use during an abnormal system end, that access path does not appear on the Edit Rebuild Access Path display.

If the maintenance for the access path is immediate or delayed, the system automatically recovers the access path during IPL or vary on of an independent disk pool. A status message is displayed for each access path whose maintenance is immediate or delayed as it is being recovered during an IPL or vary on of an independent disk pool. The system places message CPF3123 in the system history log for each access path that is recovered through the journal during the IPL or vary on of an independent disk pool. This message appears for access paths that are explicitly journaled and for access paths that are protected by SMAPP.

Related tasks

Recovering from a damaged journal receiver

If a journal receiver becomes damaged, the system sends message CPF8136 or message CPF8137 to the system operator and the job log.

Recovering a damaged journal

If a journal becomes damaged, the system sends message CPF8135 to the system operator and to the job log.

Recovering from a damaged journal receiver

If a journal receiver becomes damaged, the system sends message CPF8136 or message CPF8137 to the system operator and the job log.

If a journal receiver becomes damaged, there are two ways you can recover from it:

- Recover from a damaged receiver manually
 1. If the damaged receiver is currently attached to a journal, swap the journal receiver to attach a new receiver and detach the damaged receiver.
 2. If the journal receiver is not currently attached to a journal and you have a complete saved copy of the receiver (that is, one that was saved after the receiver was detached), then delete the journal receiver and restore a previously saved copy. If no complete saved copy of the journal receiver exists, then you may wish to read as many entries as possible before deleting the journal receiver.
 3. If the journal receiver was never attached to a journal, delete the receiver and create it again or restore it.

If the journal receiver is partially damaged, all journal entries except those in the damaged portion of the journal receiver can be viewed using the Display Journal (DSPJRN) command. Using this list, you can determine what you need to do to recover your objects. Applying or removing journal changes cannot be done with a partially damaged journal receiver.

- Recover from a damaged receiver with the Work with Journal (WRKJRN) command. It is recommended that you use the WRKJRN command.

To use the Work with Journals display to recover damaged journal receivers, use Option 7 (Recover damaged journal receivers). Option 7 checks to determine which journal receivers that are associated with the specified journal are damaged. If none are damaged, a message appears.

If there are damaged journal receivers associated with the specified journal, the Recover Damaged Journal Receivers display appears and lists those receivers.

The status fields initially show a value of Damaged. After recovery has been successfully completed, the status shows a value of Recovered (receiver recovered).

To view the online help, type WRKJRN at a command line, and press F1. The online help also contains a description of the journal menus.

Recovery for a damaged journal receiver guides you through the following steps:

1. If the attached receiver is damaged, you must run a Change Journal (CHGJRN) command to attach a new receiver.

Indicate that you want to create a new receiver. The system presents the Create Journal Receiver (CRTJRNRCV) command prompt for receiver name and attributes. After you create the new receiver, the system shows the CHGJRN command prompt.

If the attached receiver is not damaged, the preceding step is omitted.

2. The damaged journal receiver is deleted.
3. A prompt for the restore of the damaged journal receiver is shown. Any of the values on the prompt can be changed except the receiver name. Save information in the prompt is provided by the system.

Related tasks

Swapping journal receivers

An important task for journal management is to swap journal receivers. You typically swap journal receivers when they reach their storage threshold. You can swap journal receivers either with IBM Navigator for i or with the Change Journal (CHGJRN) command. If you use system journal-receiver management, the system changes journal receivers for you.

Deleting journal receivers

Journal receivers can quickly use a lot of auxiliary storage space. Therefore an important journal management task is to delete journal receivers after you no longer need them.

Related reference

Work with Journal (WRKJRN) command

Display Journal (DSPJRN) command

Change Journal (CHGJRN) command

Create Journal Receiver (CRTJRNRCV) command

Recovering a damaged journal

If a journal becomes damaged, the system sends message CPF8135 to the system operator and to the job log.

You can use the Work with Journals (WRKJRN) command to recover a damaged journal, or you can perform the following steps:

1. End journaling for all libraries by using the End Journal Library (ENDJRNLIB) command.
2. End journaling for all access paths associated with the journal by using the End Journal Access Path (ENDJRNAP) command.
3. End journaling for all physical files associated with the journal by using the End Journal Physical File (ENDJRNPF) command.
4. End journaling for all integrated file system objects by using the End Journal (ENDJRN) command.
5. End journaling for all other object types by using the End Journal Object (ENDJRNOBJ) command.
6. Delete the damaged journal by using the Delete Journal (DLTJRN) command.
7. Create a journal receiver (CRTJRNRCV command) and create a journal (CRTJRN command) with the same name and in the same library as the damaged journal, or restore the journal from a previously saved version.

Note: If you have remote journals associated with this journal, it is suggested that you restore a previously saved version of the journal rather than creating the journal.

8. Start journaling the physical files that were journaled by using the Start Journal Physical File (STRJRNPF) command.
9. Start journaling the access paths that were journaled by using the Start Journal Access Path (STRJRNAP) command.
10. Start journaling integrated file system objects with the Start Journal (STRJRN) command.
11. Start journaling other new object types with the Start Journal Object (STRJRNOBJ) command.

Note: You can also restore your journaling environment by deleting and restoring all the objects that were being journaled. Objects that were journaled at the time of their save automatically begin journaling at restore time if the journal is online.

12. Start journaling libraries with the Start Journal Library (STRJRNLIB) command
13. Save the journaled objects to allow for later recovery.
14. Associate the old journal receivers with the new journal. Do the following:
 - a) Type WRKJRN and press the Enter key.
 - b) On the prompt display, enter the name of the journal.
 - c) From the Work with Journals display, select option 9 (Associate receivers).
 - d) Press F12 to cancel the display.
 - e) Type WRKJRNA JRN(*library-name/journal-name*) and press the Enter key.

- f) From the Work with Journal Attributes display, press F15 to display the receiver directory.
- g) A new panel now gets displayed after selecting option 9. This new panel is called "Specify Journal Receivers". Fill in *ALL for journal receiver name and put in the specific library name that the receivers are located in. This is faster than searching the entire system looking at all receivers.
- h) After receivers are attached, then Press F12 to cancel out of the "Work with Journals" display.

Each time a journal is restored, a new receiver chain is started because the last journal receiver in the chain that existed prior to the restore process did not have the newly created receivers as its next receivers.

Note: If the damaged journal had any remote journals associated with it and a previously saved version of the journal was not restored, use the Add Remote Journal (QjoAddRemoteJournal) API or Add Remote Journal (ADDRMTJRN) command to reassociate those remote journals. See the Add remote journals link below for more information.

Related tasks

Adding remote journals

This topic provides instructions for adding a remote journal.

Associating receivers with journals

You can use Option 9 on the Work with Journals display if the journal was restored or created again. The system associates all applicable receivers with the restored or recreated journal so that a restore of these receivers is not necessary.

The system now displays the Specify Journal Receivers screen. There are new input lines so you can enter specific receivers, generic receivers or *ALL. Additionally, the second input line allows a library to be specified so the checking for valid receivers is now restricted to a specific library instead of searching the entire system to find all receivers and checking all of these receivers to see if they should be associated with this newly created journal. This new screen significantly speeds up the reassociation of receivers to a journal.

The system displays the Specify Journal Receivers screen. There are input lines so you can enter specific receivers, generic receivers or *ALL. Additionally, the second input line allows a library to be specified so the checking for valid receivers is restricted to a specific library instead of searching the entire system to find all receivers and checking all of these receivers to see if they should be associated with this journal. This screen significantly speeds up the reassociation of receivers to a journal.

A journal receiver is associated with a journal if the journal receiver appears in the journal receiver directory. A receiver that was previously attached to a journal but is not currently associated with a journal cannot be used with the journal commands, such as:

- Display Journal (DSPJRN)
- Receive Journal Entry (RCVJRNE)
- Retrieve Journal Entry (RTVJRNE)
- Retrieve Journal Entries (QjoRetrieveJournalEntries) API
- Apply Journalized Changes (APYJRNCHG)
- Apply Journalized Changes Extend (APYJRNCHGX)
- Remove Journalized Changes (RMVJRNCHG)

Related reference

Display Journal (DSPJRN) command

Receive Journal Entry (RCVJRNE) command

Retrieve Journal Entry (RTVJRNE) command

Retrieve Journal Entries (QjoRetrieveJournalEntries) API

Apply Journalized Changes (APYJRNCHG) command

Apply Journalized Changes Extend (APYJRNCHGX) command

Remove Journalized Changes (RMVJRNCHG) command

Recovering a damaged journal with the WRKJRN command

The **Work with Journal (WRKJRN)** command can be used to recover a damaged journal.

The WRKJRN command associates the receivers with the recovered journals without you having to delete and restore the receivers.

Option 6 on the Work with Journals display verifies that the journal is damaged before proceeding with recovery. If the journal is not damaged, an informational message appears.

For a description of the Work with Journals display, see the WRKJRN command in the online command help. To view the help, type WRKJRN on a command line, and press F1.

Recovery for a damaged journal guides you through the following steps:

1. The system attempts to determine which objects are currently being journaled to the indicated journal. If the system cannot successfully build this list, a message appears before the recovery operation begins. For each object type whose journaling is being ended, a status message is sent indicating how many objects have ended.
2. Journaling is ended for all access paths that are currently being journaled to the specified journal.
3. Journaling is ended for all database files that are currently being journaled to the specified journal. Journaling is ended for all objects.
4. The system deletes the journal.
5. The system presents the Recover Damaged Journal display, which asks you whether to restore or create the journal and what state to create the journal. The state is *ACTIVE or *STANDBY. If you have remote journals associated with your damaged journal it is suggested that you take the option to restore a previously saved version of the journal.
 - a) If the journal will be restored, the system prompts for the values that are needed for the restore operation.
 - b) If the journal will be created, the system prompts for the receiver name and attributes with the CRTJRNRCV command prompt. The system prompts for values needed to create the journal with the CRTJRN command prompt, with known values that are shown.
6. Journaling is restarted for all objects for which it was previously ended. The screen displays after each object type has been restarted. If there were no objects for a specific type, then that step is skipped. A status message is sent periodically while journaling is being started to update you on how many objects have started journaling.
7. The system now displays the Specify Journal Receivers screen. There are new input lines so you can enter specific receivers, generic receivers or *ALL. On the display you can enter a specific receiver, a generic name for journal receivers, or *ALL. Additionally, a library name can be specified to limit the search for receivers to only a specific library when finding receivers to associate with the newly created journal. Limiting the search to only certain receivers can significantly speed up the reassociation processing.

A journal receiver is associated with a journal if the journal receiver appears in the journal receiver directory. A receiver that was previously attached to a journal, but is not currently associated with a journal, cannot be used with the journal commands such as **Display Journal (DSPJRN)**, **Apply Journaled Changes (APYJRNCHG)**, **Apply Journaled Changes Extend (APYJRNCHGX)**, and **Remove Journaled Changes (RMVJRNCHG)**.

As the recovery of a damaged journal proceeds, the Display Journal Recovery Status display appears. The information about this display is updated as the operation progresses to indicate which steps have been completed, which steps have been bypassed, and which step will be run next. Whenever a user action is required, the status display is replaced by the appropriate prompt display.

The status field indicates the following operation status:

- Pending. The step has not been started.
- Next. The step will be performed next (after the Enter key is pressed).
- Bypassed. The step was not performed. (It was not necessary).
- Complete. The step has been performed.

- Error. The step has been performed, but errors were encountered.

The first display you usually see after the first status display is the Recover Damaged Journal display. Use this display to choose whether the journal is to be created or restored.

When the last step of the recovery process is complete, a message appears indicating that all objects for which journaling was started must be saved to establish a new recovery point.

If the damaged journal had any remote journals associated with it and a previously saved version of the journal was not restored, use the `Add Remote Journal (QjoAddRemoteJournal)` API or **Add Remote Journal (ADDRMTJRN)** command to reassociate those remote journals.

Related tasks

[Adding remote journals](#)

This topic provides instructions for adding a remote journal.

Related reference

[Work with Journal \(WRKJRN\) command](#)

[Display Journal \(DSPJRN\) command](#)

[Apply Journalized Changes \(APYJRNCHG\) command](#)

[Apply Journalized Changes Extend \(APYJRNCHGX\) command](#)

[Remove Journalized Changes \(RMVJRNCHG\) command](#)

[Add Remote Journal \(QjoAddRemoteJournal\) API](#)

[Add Remote Journal \(ADDRMTJRN\) command](#)

Recovery of journalized objects

One of the primary advantages of journaling is its ability to return a journalized object to its current state since the last save.

You can recover from many types of damage to journalized objects by using journalized changes. For example, an object is damaged and becomes unusable, an error in an application program caused records to be improperly updated, or incorrect data was used to update an object. In each of these instances, only restoring a saved version of the object can result in the loss of a significant amount of data.

If you use the **Apply Journalized Changes (APYJRNCHG)** or **Apply Journalized Changes Extend (APYJRNCHGX)** command to apply journalized changes, significantly less data may be lost. You can use the **Remove Journalized Changes (RMVJRNCHG)** command to recover from improperly updated records or incorrect data if before-images have been journalized. This command removes (or backs out) changes that were made to an object.

Use the `APYJRNCHG` command to apply changes to these object types:

- Library
- Database file
- Integrated file system object
- Data area
- Data queue

Use the **APYJRNCHGX** command to apply changes to database files.

Use the **RMVJRNCHG** command to remove changes that were made to these object types:

- Database file
- Data area

To recover an object by applying or removing journalized changes, the object must be currently journalized. The journal entries must have the same journal identifier (JID) as the object. To ensure the journal identifiers are the same, save the object immediately after journaling is started for the object.

To apply or remove journaled changes to or from a restored copy of the object, you must have already saved the object while it was being journaled. Why you must save objects after you start journaling has more information about saving journaled objects and about JIDs.

If you need to recover objects that were journaled to a journal that you deleted, restore the journal from a saved copy or create a new journal with the same name in the same library. Then restore the object and all the needed receivers before applying or removing journaled changes with that journal. You can use an option on the Work with Journals display to reassociate any journal receivers that are still on the system. To use the Work with Journals display, use the **Work with Journals (WRKJRN)** command.

Some types of entries in the journal receiver cause the apply or remove process to possibly stop. These entries are written by events that the system cannot reconstruct. Certain illogical conditions, such as a duplicate key in a database file defined as unique, can also cause processing to end.

Use the Object Error Option (OBJERROPT) of the APYJRNCHG, APYJRNCHGX, or RMVJRNCHG commands to determine how the system responds to an error. If you select OBJERROPT(*CONTINUE) and an error occurs, processing of journal entries stops only for the object associated with that error. Processing continues for the other objects. The system sends a diagnostic message indicating that the processing of journaled changes for that object was not successful. The system also places an indication that processing ended early for the specific object in any output file record. If you select OBJERROPT(*END), processing ends for all objects when an error occurs.

Using save-while-active to save your journaled objects can help you recover your objects more quickly when you need to apply or remove journaled changes specifying FROMENT(*LASTSAVE) or FROMENTLRG(*LASTSAVE). When you use the save-while-active function to save your journaled objects, the system saves and then restores information that indicates which starting journal sequence number is needed for the apply or remove operation. When this information is available for all objects to which you are applying or removing journaled changes, the system does not need to scan the journal receivers to determine this starting point. Scanning journal receiver data to find the starting points can be time consuming.

Also, using save-while-active when saving your objects allows you to restore a version of your object which was not from the last save and to still specify FROMENT(*LASTSAVE) or FROMENTLRG(*LASTSAVE) on the apply or remove command and successfully apply or remove changes.

Actions of applying or removing journaled changes by journal code shows how operations that apply and remove journaled changes handle journal entry types. It shows which entry types cause processing to end for an object and what processing is done when the entry is applied or removed.

You can use partial receivers to apply or remove changes from an object. If you attempt to restore a saved receiver while a more current version of the receiver is on the system, an escape message is sent to prevent you from restoring the receiver. The system makes sure that the most complete version is preserved.

You can use a partial receiver as the first receiver in the receiver chain for a RMVJRNCHG command only if you specify a sequence number for the FROMENT or FROMENTLRG parameter.

Related concepts

[Why you must save objects after you start journaling](#)

After you start journaling, it is essential that you save objects that you are journaling.

[Using SAVCHGOBJ to save journal receivers](#)

One technique for saving journal receivers is to use the Save Changed Object (SAVCHGOBJ) command. When you use the SAVCHGOBJ command to save journal receivers, ensure that you omit the attached journal receiver.

Applying journaled changes

If an object becomes damaged or is not usable you can recover the object using the **Apply Journaled Changes (APYJRNCHG)** or **Apply Journaled Changes Extend (APYJRNCHGX)** command. If you

restore an object that was saved with partial transactions, then you must apply journaled changes to that object before it is usable.

Difference between APYJRNCHG and APYJRNCHGX

There are slight differences between the **Apply Journaled Changes (APYJRNCHG)** command and the **Apply Journaled Changes Extend (APYJRNCHGX)** command. The **APYJRNCHGX** command only applies entries for database files and requires entries to be applied for all files in a library. The **APYJRNCHG** command also applies entries for non-database objects.

Applying journaled changes to all objects

You can apply journaled changes to all objects that are journaled to the journal by specifying **OBJ(*ALLJRNOBJ)** on the **APYJRNCHG** command.

Applying journaled changes and commitment control

You can ensure that commitment transaction boundaries are honored during the apply journaled changes operations by using the commitment boundary (**CMTBDY**) parameter. The default value for the **CMTBDY** parameter is ***YES**. If the system encounters a journal entry that causes the apply or remove process to stop for the object, the commitment boundary might not be honored.

Note: Regardless of the **CMTBDY** parameter value, any database file object-level operations that were originally performed under commitment control are also performed under commitment control during the apply. If the commitment control transaction was originally committed, the object-level operations are committed when the corresponding commit entry is applied. If the commitment control transaction was originally rolled back, the object-level operations are rolled back when the corresponding rollback entry is applied. **If the commitment control operation does not end within the range of journal entries being applied, then the changes are rolled back.**

Error handling

When the system encounters a journal entry it cannot process, it ends apply processing either for that specific object or for the entire apply operation. You can specify how the system behaves when it encounters a journal entry it cannot process with the Object Error Option (**OBJERROPT**) parameter on the **APYJRNCHG** or **APYJRNCHGX** command. If you specify **OBJERROPT(*CONTINUE)**, the system ends apply processing for the specific object that has an error, but it continues apply processing for the other objects in the apply operation. If you specify **OBJERROPT(*END)**, the system ends processing for the entire apply operation. The **OBJERROPT** parameter is also available for the **Remove Journaled Changes (RMVJRNCHG)** command. Actions of applying or removing journaled changes by journal code shows which entry types cause processing to end for an object.

Before you start applying changes

You must first reestablish the object to a condition that you know is undamaged.

- To reestablish the object, restore the last saved copy of the object. The object must have been saved while it was being journaled.
- If you saved a database physical file by using the **Copy File (CPYF)** command, use the **CPYF** command to restore the member by overlaying the contents of the existing object with the old values.
- If the member of a database physical file was just initialized, initialize the member again using the **Initialize Physical File Member (INZPFM)** command or a user-created application program.
- If a member of a database physical file was just reorganized, reorganize the member again using the **Reorganize Physical File Member (RGZPFM)** command.

You must restore the needed journal receivers if any of the following are true:

- If the journal receivers were deleted since the object was last staved (or some other point).

- If the journal receivers were saved with their storage freed.

When you apply journaled changes to an object, the object cannot be in use by anyone else.

Starting and stopping points for applying journaled changes

When the condition of the object has been established, use the APYJRNCHG or APYJRNCHGX command to apply the changes that are recorded in the journal to the object.

The system applies the changes to the object in the same order as they were originally made. You must plan where you want to start and stop applying changes. Use the **Display Journal (DSPJRN)** command to identify the desired starting and ending points. If you use a control language (CL) program for your recovery procedures, use the following:

- **Receive Journal Entry (RCVJRNE)** command to receive journal entries as they are written to the journal receiver.
- **Retrieve Journal Entry (RTVJRNE)** command to retrieve a journal entry and place it in program variables.

You can also use the `QjoRetrieveJournalEntries` API to retrieve the information into a High Level Language (HLL) program.

Starting applying journal entries

On the APYJRNCHG or APYJRNCHGX command, specify the first journal entry to be applied to the object. This entry can be selected from any of the following points:

- After the last save of the object
- From the first journal entry
- From an identified sequence number that corresponds to a date and time stamp
- From an identified sequence number that corresponds to the start or end of a particular job's use of the object provided that you did not specify one of the following:
 - OMTJRNE(*OPNCLO) when starting journaling or changing the journaling attributes for object.
 - OMTJRNE(*OPNCLOSYN) when starting journaling or changing the journaling attributes for a directory or stream file.
 - RCVSIZOPT(*MINFIXLEN) for the journal at any time while the object was journaled.
 - A FIXLENDTA option that omitted the job name.
- A specific sequence number

Note: If an object was restored with partial transactions, then you must specify FROMENT(*LASTSAVE) or FROMENTLRG (*LASTSAVE).

Stopping applying journal entries

You can stop applying the journal entries at the following:

- The end of the data in the last journal receiver in the receiver range
- A particular entry in the journal
- A date and time stamp
- A commitment boundary
- The start or end of a particular job's use of the data in the object, provided you did not specify the following:
 - OMTJRNE(*OPNCLO) when starting journaling or changing the journaling attributes for the object.
 - OMTJRNE(*OPNCLOSYN) when starting journaling or changing the journaling attributes for a directory or stream file.

- RCVSIZOPT(*MINFIXLEN) for the journal at any time while the object was journaled.
- A FIXLENDTA option that omitted the job name.
- The journal entry that indicates when the object was last restored
- A specific sequence number

The apply and remove journaled changes output file

It is highly recommended that you use the apply and remove journaled changes output file when you apply journaled changes. The output file contains a record for each object that the apply operation processes. It contains a record for each object created and each object deleted during the apply. This output file is especially useful when the apply ends early. It is much easier to query the output file for the status of each object rather than searching through the job log messages. Also the messages are limited to 512 while the output file is not limited.

Considerations for applying changes

Considerations for applying changes are as follows:

- When you apply journaled changes to integrated file system objects, you need to be aware of integrated file system considerations.
- If you need to apply entries for less than 300 objects, and your database files have only one member, or you will be applying changes to all members of the files, then you may wish to use the Forward Recovery option through the **Work with Journals (WRKJRN)** command.

Related concepts

[Actions of applying or removing journaled changes by journal code](#)

The following table shows the actions that are taken by the Apply Journaled Changes (APYJRNCHG), Apply Journaled Changes Extend (APYJRNCHGX), or Remove Journaled Changes (RMVJRNCHG) command by journal code and entry type.

[Use of the QAJRNCHG file](#)

You can use the apply and remove journaled changes output (QAJRNCHG) file to make a record of all the activity that occurs when you perform an apply or remove journaled changes operation.

Related reference

[Apply Journaled Changes \(APYJRNCHG\) command](#)

[Apply Journaled Changes Extend \(APYJRNCHGX\) command](#)

[Copy File \(CPYF\) command](#)

[Initialize Physical File Member \(INZPFM\) command](#)

[Reorganize Physical File Member \(RGZPFM\) command](#)

[Display Journal \(DSPJRN\) command](#)

[Receive Journal Entry \(RCVJRNE\) command](#)

[Retrieve Journal Entry \(RTVJRNE\) command](#)

[Retrieve Journal Entries \(QjoRetrieveJournalEntries\) API](#)

Integrated file system considerations for applying journaled changes

If there is a create entry or delete entry in the range of journal entries to which you are applying journaled changes, changes to a directory can cause the creation or deletion of an object.

If you are journaling a directory using the **Journal new files and folders** (INHERIT(*YES)) option and an object is created into that directory, the system automatically starts journaling that new object and deposits associated create and start journal object journal entries. The apply of these create and start journal entries during the apply operation on the directory then creates the objects and starts journaling for them during the apply operation. For any subsequent journaled entries for that object, the apply operation applies any entries that it encounters for that object as well. Similarly, if an entry is encountered which deletes (unlinks) an integrated file system object, that object is actually deleted as part of the apply operation.

Additionally, the apply operation will start journaling for any integrated file system journal entry that adds a link to the journaled directory, such as moving a nonjournaled object into the journaled directory, or adding a new hard link to a nonjournaled object into this journaled directory. However, no entries will be applied to these objects since the state of those objects is not fully known during the apply.

As objects are created, they are included in the maximum number of objects which can be applied as part of one Apply Journaled Changes (APYJRNCHG) request.

Error handling considerations

When you apply journaled changes, you can use the Object Error Option (OBJERROPT) of the APYJRNCHG command to specify how the system responds to errors. If you specify *CONTINUE, the system stops applying changes to the object that encounters an error, but continues the apply operation for the remaining objects.

For integrated file system objects, the system processes errors for directory-level operations separately from object-level operations. For example, you perform an apply journaled changes operation for a directory and a stream file in that directory. During the apply operation, an error occurs for the stream file and the apply process ends for that stream file. You might expect some operations that are associated with that stream file, such as remove link, to end also. But since remove link is a directory level operation, the remove link operation still occurs, even though the apply operation ended for that stream file.

Therefore even though object-level operations for an object might end, directory-level operations that are associated with that object still occur.

Commitment control considerations

Many journaled integrated file system operations use system initiated commitment control for the duration of the operation. These operations are not considered completed successfully unless the commitment control cycle is committed. Commitment control, here, refers to commitment control that the system initiates. Integrated file system operations cannot be included in a user initiated commitment control cycle.

For integrated file system journal entries that are part of a commitment control cycle, do not apply individual entries from within the cycle without applying the entire commit cycle. Using the Commit Boundary (CMTBDY(*YES)) parameter on the APYJRNCHG command can help enforce this. If you do not use this option and choose a specific starting point, start from the Start of commit cycle (C SC) entry for that cycle. Likewise, if you choose to end applying a journaled change at a specific point, end on the Commit (C CM) or Rollback (C RB) entry for that cycle.

Related concepts

[Actions of applying or removing journaled changes by journal code](#)

The following table shows the actions that are taken by the Apply Journaled Changes (APYJRNCHG), Apply Journaled Changes Extend (APYJRNCHGX), or Remove Journaled Changes (RMVJRNCHG) command by journal code and entry type.

Applying journaled changes with the WRKJRN command

The **Work with Journal (WRKJRN)** command can be used to recover any journaled object. When you select option 2, you choose from a list of object types for recovery. Choose an object type to view the journaled objects of that type and the current status for each object.

The status field for each object indicates the following:

- Not journaled
- Different journal
- Not found
- Damaged
- Not Synchronized
- Restore complete

- Recovered
- Deleted
- Database files

Note: The WRKJRN command support should be considered only if you are applying changes for less than 300 objects.

You can use the Work With Forward Recovery display to perform the following tasks:

Add object to list

To add an object to the list on the display, use Option 1 (Add member to list). Do this if you want to restore those objects. This task is not available for Integrated File System objects.

Apply journaled changes

To apply journaled changes to an object, use Option 2 (Apply journaled changes). This option applies journaled changes and changes the status to Recovered (if the apply operation was successful). If the apply operation was not successful, messages appear indicating why and the last successful status is displayed. If any required receivers are missing or damaged while running the **APYJRNCHG** command, the system prompts for the restore of the missing or damaged receivers.

If any of the objects in the list have a status of Damaged, the system prompts you with the command necessary to recover the object. For objects that are damaged, recovery involves deleting the object, a restore of the last save of the object, followed by the **Apply Journaled Changes (APYJRNCHG)** command. The system guides you through the recovery of physical files as follows:

Note: The recovery is similar for data areas, data queues, and integrated file system objects, except for the dependent logical files references. Also, the restore command names are different for integrated file systems it is RST, but for all others its RSTOBJ.

- For physical files, the system identifies all the logical files dependent on the specified damaged file. The Dependent Logical Files display appears identifying these files.
- The dependent logical files are deleted.
- The system deletes the files to be recovered (or restored).
- The system displays prompts for the restore of files to be recovered. After all restores are completed successfully, the files to be recovered are allocated exclusively to prevent any other processing. This allocation is maintained until the recovery procedures are complete.
- The system displays prompts for the restores of the dependent logical files.
- An APYJRNCHG command is prompted.
- If the APYJRNCHG command encounters a required journal receiver that is not online, the system prompts for the restore of the required receiver and again starts the APYJRNCHG command.

When the recovery process is complete, the status field for the member indicates Recovered (if the operation was successful). If the operation failed, the status field remains unchanged, and messages appear indicating why the operation failed.

Restore objects

If you wish to restore any objects, use Option 3 (Restore). This is particularly useful for objects with a status of Not Found. Objects that are restored successfully have a status of Restore Complete. Objects that are not restored keep their old status. A message is sent indicating that the restore did not complete successfully. All objects that are restored are included in the list of objects to recover.

Note: The last save information is provided for the restore operation. If either of the following are true, then you must use the RSTOBJ command instead of Option 3 (Restore):

- The device provided is tape, diskette, or optical and you choose to restore from a save file (*SAVF).
- The device provided is a save file (*SAVF) and you choose to restore from tape, diskette, or optical media.

If you choose option 3 to restore a damaged object, the restore process involves deleting the object prior to prompting to restore the object. The process is similar for all object types except there are

extra steps if restoring damaged physical files that have dependent logical files. The system guides you through the restore process of damaged physical files as follows:

- The system identifies all the logical files dependent on the specified damaged physical file.
- The Dependent Logical Files display appears identifying these logical files.
- The system deletes the files to be restored.
- The system then prompts with a restore command for the physical files.
- Once the physical files are restored, the system prompts with a restore command to restore the logical files.

Remove object from list

To remove an object from the list, use Option 4 (Remove object or member from list). Option 4 removes objects from the list of objects to be recovered.

Removing journaled changes

Depending on the type of damage to the journaled object and the amount of activity since the object was last saved, removing changes from the object can be easier than applying changes to the object. Use the Remove Journaled Changes (RMVJRNCHG) command to remove changes from an object if you are journaling before-images.

The RMVJRNCHG command removes changes in reverse chronological order, starting with the most recent change.

On the RMVJRNCHG command, you identify the first journal entry to be removed from the object. This entry can be from:

- The last journal entry that is contained within the range of journal receivers specified.
- The entry that corresponds to the last save of the object.
- An identified sequence number.

You can control the changes that are removed from the object. For example, assume that an application updated data incorrectly for a period of time. In this case, you can remove the changes from the object until that application first opened the object.

You can stop removing journaled changes at:

- The start of the commit cycle for a transaction.
- The end of data in the journal receivers. This corresponds to the first journal entry that was recorded on the range of journal receivers that are specified.
- An identified sequence number that corresponds to a particular entry in the journal.
- The start of a particular job's use of the object. You can only specify this if you did not specify any the following:
 - To exclude open and close journal entries (OMTJRNE(*OPNCLO)) when starting journaling for the file
 - To minimize fixed-length entries RCVSIZOPT(*MINFIXLEN) for the journal at any time while the object was journaled.
 - To omit a FIXLENDTA option that includes the job name.

You can ensure that commitment transaction boundaries are honored on the remove journaled changes operations by using the CMTBDY parameter on these commands.

If the system encounters a journal entry that causes the apply or remove process to stop, the commitment boundary may not be honored.

Error handling

When the system encounters a journal entry it cannot process, it ends remove processing either for that specific object or for the entire remove operation. You can specify how the system behaves when it encounters a journal entry it cannot process with the Object Error Option (OBJERROPT) on the Remove

Journalized Changes (RMVJRNCHG) command. If you specify OBJERROPT(*CONTINUE), the system ends remove processing for the specific object, but it continues remove processing for the other objects in the remove operation. If you specify OBJERROPT(*END), the system ends processing for the entire remove operation. Actions of applying or removing journalized changes by journal code shows which entry types cause processing to end for an object.

Starting and ending points

Use the Display Journal (DSPJRN) command to identify the required starting and ending points. If you use a control language (CL) program for your recovery procedures, use the following:

- Receive Journal Entry (RCVJRNE) command to receive journal entries as they are written to the journal receiver.
- Retrieve Journal Entry (RTVJRNE) command to retrieve a journal entry and place it in program variables.

You can also use the Retrieve Journal Entries (QjoRetrieveJournalEntries) API to retrieve the information into a High Level Language (HLL) program.

Another way to remove journalized changes is to Remove journalized changes with the WRKJRN command and follow the command prompts.

The apply and remove journalized changes output file

It is highly recommended that you use the apply and remove journalized changes output file when you remove journalized changes. The output file contains a record for each object that the remove operation processes. It contains a record for each object created and each object deleted during the remove. This output file is especially useful when the remove ends early. It is much easier to query the output file for the status of each object rather than searching through the job log messages. Also the messages are limited to 512 while the output file is not limited.

Related concepts

[Actions of applying or removing journalized changes by journal code](#)

The following table shows the actions that are taken by the Apply Journalized Changes (APYJRNCHG), Apply Journalized Changes Extend (APYJRNCHGX), or Remove Journalized Changes (RMVJRNCHG) command by journal code and entry type.

[Use of the QAJRNCHG file](#)

You can use the apply and remove journalized changes output (QAJRNCHG) file to make a record of all the activity that occurs when you perform an apply or remove journalized changes operation.

Removing journalized changes with the WRKJRN command

Remove journalized changes with the **Work With Journal (WRKJRN)** command by selecting Option 3 (Backout recovery).

After selecting Option 3 , a menu display gives you the option to select either physical files or data areas as the object type. Then, after selecting one of the object types, a list of the journalized objects of that type is displayed.

The Work with Backout Recovery display is useful because the system guides you through the process. However, it can be used for journalizing access paths, database files, and data areas only.

The same options on the Work with Forward Recovery display are available on the Work with Backout Recovery display, except the option to restore the object. However, the option to restore the object is not valid for backout recovery. The status field that is shown on the Work with Backout Recovery display is either blank or it indicates the same status as for forward recovery, except for Restore Complete.

The status field for each object indicates the following:

- Not found
- Damaged
- Not synchronized

- Recovered
- Not journaled
- Different journal

Tasks with the Work With Backout Recovery display

You can use the Work With Backout Recovery display to perform the following tasks:

Add object to list

To add an object to the list select Option 1 (Add object to list).

Remove journaled changes

To remove journaled changes, select Option 2 (Remove journaled changes). Option 2 shows the Remove Journaled Changes (RMVJRNCHG) command prompt, removes the journaled changes, and changes the status to Recovered (if the operation was successful). If any required journal receivers are missing or damaged while the RMVJRNCHG command is running, the system displays prompts for the necessary restore procedures for the missing or damaged receivers. If the remove operation was not successful, messages appear indicating why the status remains the same.

If any objects in the list have a status of Not Found or Damaged when on the Work with Backout Recovery display, the operation is not allowed. These objects must be recovered in a forward fashion after they have been restored. Forward recovery of specific files must be used for this type of recovery.

Remove object from list

Use Option 4 (Remove object from list) to remove objects from the list.

Related tasks

[Applying journaled changes with the WRKJRN command](#)

The **Work with Journal (WRKJRN)** command can be used to recover any journaled object. When you select option 2, you choose from a list of object types for recovery. Choose an object type to view the journaled objects of that type and the current status for each object.

Use of the QAJRNCHG file

You can use the apply and remove journaled changes output (QAJRNCHG) file to make a record of all the activity that occurs when you perform an apply or remove journaled changes operation.

When you specify to create the output file, the system uses the QAJRNCHG output file in the QSYS library with the format name QJOAPYRM as a model.

The words in parenthesis in the Field column indicate the column heading used in the output file.

See the following commands for the all of the parameters used with this output file:

- **Apply Journaled Changes (APYJRNCHG)** command
- **Apply Journaled Changes Extend (APYJRNCHGX)** command
- **Remove Journaled Changes (RMVJRNCHG)** command

The following table describes the fields that the output file creates.

| Relative offset | Field | Format | Description |
|---|------------------|-----------|--|
| Fields defining the header information | | | |
| 1 | Command (QJOCMD) | Char (10) | Indicates if APYJRNCHG, APYJRNCHGX, or RMVJRNCHG was used. |

| Relative offset | Field | Format | Description |
|---|----------------------------|-----------|--|
| 11 | Detail option (QJODET) | Char (1) | Specifies the level of detail that was selected for this output file: A = DETAIL(*ALL) The file contains information about the command and an entry for each object that was applied to, whether it existed when the apply command started or it was created during the apply. E = DETAIL(*ERR) The file contains information about the command and an entry only for each object that was not successfully applied to. If the apply ends early for an object an entry is included for it. |
| 12 | System (QJOSYS) | Char (8) | The name of the system where the apply or remove journaled changes operation was performed. |
| 20 | Release (QJOSRL) | Char (6) | The release of i5/OS that the system performing the apply or remove operation uses. |
| 26 | Journal name (QJOJRN) | Char (10) | The name of the journal. |
| 36 | Library name (QJOJLB) | Char (10) | The name of the library for the journal. |
| 46 | ASP device (QJOASP) | Char (10) | The name of the auxiliary storage pool (ASP) device for the library. |
| 56 | Commit boundary (QJOCMT) | Char (1) | Indicates if a commit boundary was used in the apply or remove operation. Y = CMTBDY(*YES) was specified N = CMTBDY(*NO) was specified |
| 57 | Reserved (QJORS1) | Char (30) | Reserved |
| Results summary fields | | | |
| 87 | Number of objects (QJONOB) | Char (10) | Total number of objects processed during the apply or remove operation. |
| 97 | Total entries (QJONEN) | Char (20) | Total number of entries processed during the apply or remove operation. |
| 117 | Last entry (QJOLST) | Char (20) | Last entry examined in the apply or remove operation. |
| 137 | End partial LUW (QJOLUW) | Char (1) | At least one transaction was omitted because CMTBYD(*YES) was specified and the ending sequence number was not at a commit boundary. Y = Yes N = No |
| 138 | Reserved (QJORS2) | Char (20) | Reserved |
| Object apply or remove information | | | |

| Relative offset | Field | Format | Description |
|-----------------|---------------------------------------|-----------|---|
| 158 | Object deleted (QJOOSD) | Char (1) | Indicates if the object was deleted during the apply or remove operation. Y = Yes N = No |
| 159 | Object created (QJOOSC) | Char (1) | Indicates if the object was created during the apply or remove operation. Y = Yes N = No |
| 160 | Early end (QJOOSE) | Char (1) | Indicates if the apply or remove operation ended early for this object. Y = Yes N = No |
| 161 | Change not made (QJOOSU) | Char (1) | Indicates that a change was found for this object after an early end to the apply operation. Y = Yes N = No |
| 162 | End reason code (QJORCD) | Hex (1) | Reason code for early end. See message MCH4801 for the possible values. |
| 163 | End message ID (QJOMID) | Char (7) | Message identifier associated with an early end to the apply operation. |
| 170 | Error condition (QJOENO) | Hex (4) | Error condition associated with an early end to the apply operation. |
| 174 | Partial transactions remain (QJOPTL) | Char (1) | Changes for partial transactions remain for this object. Y = Yes N = No |
| 175 | Partial transactions removed (QJOPTR) | Char (1) | Indicates whether partial transactions were removed for this object. Y = Yes N = No |
| 176 | Reserved (QJORS3) | Char (20) | Reserved |
| 196 | Starting sequence number (QJOSSN) | Char (20) | Specified starting sequence number for the apply or remove operation. |
| 216 | Starting receiver name (QJOSRC) | Char (10) | The name of the first receiver from which entries were applied or removed. |
| 226 | Receiver library (QJOSLB) | Char (10) | The library for the starting journal receiver. |
| 236 | Ending sequence number (QJOESN) | Char (20) | Specified ending sequence number for the apply or remove operation. |
| 256 | Ending receiver name (QJOERC) | Char (10) | The name of the last or ending receiver from which entries were applied or removed. |

| Relative offset | Field | Format | Description |
|--|---|-----------|---|
| 266 | Library name (QJOERL) | Char (10) | The library for the ending journal receiver. |
| 276 | First entry applied or removed (QJOASN) | Char (20) | The first entry of the apply or remove operation. |
| 296 | Last entry applied or removed (QJOAEN) | Char (20) | The last entry of the apply or remove operation. |
| 316 | Number of entries (QJONUM) | Char (20) | The number of journal entries that were applied or removed. |
| 336 | Partial transaction starting sequence number (QJOBSN) | Char (20) | Starting sequence number for any partial transactions that were removed. For integrated file system objects, this field is always zero. |
| 356 | Partial transaction ending sequence number (QJOBEN) | Char (20) | Ending sequence number for any partial transactions that were removed. For integrated file system objects and data areas, this field is always zero. |
| 376 | Number of partial transaction removed (QJOBNM) | Char (20) | Count of number of entries removed for partial transactions. For integrated file system objects and data areas, this number is always zero. |
| 396 | No entries applied indicator (QJONAIN) | Char (1) | Indicates why no entries were applied to the object. 1 = The object was created during apply, but did not get journaled or can never be journaled. 2 = The object existed before the apply and was journaled as a result of the apply. However, no entries were applied because it could not be determined that the correct version of the object was on the server at the time of the apply. |
| 397 | Reserved (QJORS4) | Char (19) | Reserved |
| Object identification information | | | |
| 416 | Object type (QJOOTP) | Char (10) | The type of object. |
| 426 | Object name (QJOONM) | Char (10) | The name of the object. |
| 436 | Object library (QJOO LB) | Char (10) | The object's library. |
| 446 | Member name (QJOOMB) | Char (10) | Member name. |
| 456 | FID (QJOOFD) | Char (16) | The file identifier of an integrated file system object. |

| Relative offset | Field | Format | Description |
|-----------------|---------------------------------|-------------|---|
| 472 | Path indicator (QJOAPI) | Char (1) | The absolute or relative path indicator. The possible values for this field are: 0 = The path contains an absolute path name. The Relative directory FID field is hex zeros. 1 =The path contains a relative path name. The Relative directory FID field is valid and can be used to form a complete path name. This field only applies to integrated file system objects. |
| 473 | Relative directory FID (QJORPI) | Char (16) | The path contains a relative path name. The Relative directory FID field is valid and can be used to form a complete path name. This field only applies to integrated file system objects. |
| 489 | Path name CCSID (QJOPCC) | Hex (4) | The coded character set identifier (CCSID) for the path name. This field only applies to integrated file system objects. |
| 493 | Path name region ID (QJOPRE) | Char (2) | The region or country identifier for national language support. This field only applies to integrated file system objects. |
| 495 | Path name language ID (QJOPLN) | Char (3) | The language identifier national language support. This field only applies to integrated file system objects. |
| 498 | Reserved (QJORS5) | Char (3) | Reserved |
| 501 | Path name type (QJOPNT) | Hex (4) | The possible values for this field are: 0 = The path name is a character string with a one byte delimiter. 2 = The path name is a character string with a two byte delimiter. This field only applies to integrated file system objects. |
| 505 | Path name length (QJOPNL) | Hex (4) | The length of the path name. This field only applies to integrated file system objects. |
| 509 | Path name delimiter (QJOPND) | Char (2) | The path name delimiter. This field only applies to integrated file system objects. |
| 511 | Reserved (QJORS6) | Char (8) | Reserved |
| 519 | Path name (QJOPNM) | Char (5000) | The path name. The length of this field is variable, depending on the path name. This field only applies to integrated file system objects. |

Related reference

[Apply Journalled Changes \(APYJRNCHG\) command](#)

[Apply Journalled Changes Extend \(APYJRNCHGX\) command](#)

[Remove Journalled Changes \(RMVJRNCHG\) command](#)

Journalled changes with trigger programs

The system does not call trigger programs when it is applying or removing journal entries.

If an event occurs that would normally cause a trigger program to run, it is up to you to ensure that the processing performed by the trigger program is recovered correctly.

Normal recovery processing will work correctly if all of the following are true:

- The trigger program only performs processing on object types which can be journalled and applied.
- The processed object types are journalled.
- Journalled changes are applied to or are removed from all the objects that are affected by the trigger program.

If additional work is performed by the trigger program or objects other than object types which can be journalled and applied are updated, you must use user-written programs to recover the work performed by the trigger program.

If you use trigger programs to perform these actions, consider using the Send Journal Entry (QJOSJRNE) API to send journal entries when trigger programs are called. To help with recovery, you can develop a program to retrieve these entries and perform the same operations.

The output format for journal entries (except the *TYPE1, *TYPE2, and *TYPE3 formats) and the QjoRetrieveJournalEntries API interface include information about whether a journal entry was created because of actions that were performed when a trigger program was called.

Related concepts

[Sending your own journal entries](#)

You can use the Send Journal Entry (SNDJRNE) command or the Send Journal Entry (QJOSJRNE) API to add your own entries to a journal. The system places these entries in the journal's attached journal receiver along with the system-created journal entries.

Related reference

[Work with triggers and constraints](#)

[Send Journal Entry \(QJOSJRNE\) API](#)

[Retrieve Journal Entries \(QjoRetrieveJournalEntries\) API](#)

Journalled changes with referential constraints

When you apply or remove journalled changes, journal management does not support referential constraints.

In the following cases, files may be in CHECK PENDING status after you have applied or removed journalled changes:

- When you restore a file that already exists, the referential constraints for the system copy of the file are used. Some of the journalled changes that you apply may have been valid with the referential constraints that were associated with the saved copy. However, they are not necessarily valid with the current referential constraints. If you have changed the referential constraints on the file, considering doing one of the following before applying or removing journalled changes:
 - Deleting the system copy and then restoring the file
 - Recreating the changes to the referential constraints

When you apply or remove journalled changes, the system attempts to verify the referential constraints at the end of the command, before returning control to you. This may result in a CHECK PENDING status.

- Some referential constraints cause an action to another file. You may define a constraint so that deleting a record in one file causes a related record to be deleted in another file. Because referential constraints are not enforced when you apply journalled changes, the second delete operation does not happen automatically. However, if you are journaling both files and applying journalled changes to both files, the system applies the journal entry for the second file when it encounters it.

If one of the files in a referential constraint was not journaled or is not included when you apply or remove journaled changes, the referential constraint will probably be put in CHECK PENDING status.

The output format for journal entries (except the *TYPE1, *TYPE2, and *TYPE3 formats) and the QjoRetrieveJournalEntries API interface include information about whether a journal entry was created because of changes that occurred to a record that was part of a referential constraint.

Related concepts

[Work with triggers and constraints](#)

Related reference

[Retrieve Journal Entries \(QjoRetrieveJournalEntries\) API](#)

Actions of applying or removing journaled changes by journal code

The following table shows the actions that are taken by the Apply Journaled Changes (APYJRNCHG), Apply Journaled Changes Extend (APYJRNCHGX), or Remove Journaled Changes (RMVJRNCHG) command by journal code and entry type.

If All is specified for the **Entry Type**, it indicates that all entry types for that journal code have the specified actions taken by the APYJRNCHG, APYJRNCHGX, or RMVJRNCHG command.

When the system ends applying or removing journaled changes has detailed information about when an apply or remove journaled changes action ends automatically.

Actions by journal code and entry type

| Journal code | Entry type | Operation | APYJRNCHG | APYJRNCHGX | RMVJRNCHG |
|--------------|------------|---------------------------------------|-----------------------------------|------------|-----------|
| A | All | | Ignores | Ignores | Ignores |
| B | AA | Change audit attribute | Attribute is changed | Ignores | Ignores |
| B | AJ | Start of apply | Ends for this object ³ | Ignores | Ignores |
| B | AT | End of apply | Ends for this object ³ | Ignores | Ignores |
| B | BD | Integrated file system object deleted | Ignores | Ignores | Ignores |
| B | B0 | Begin create | Ignores | Ignores | Ignores |
| B | B1 | Create summary | Object is created and linked | Ignores | Ignores |
| B | B2 | Link to existing object | Object is linked | Ignores | Ignores |
| B | B3 | Rename, move object | Object is moved or renamed | Ignores | Ignores |
| B | B4 | Remove link (parent directory) | Object link is removed | Ignores | Ignores |
| B | B5 | Remove link (link) | Object link is removed | Ignores | Ignores |
| B | B6 | Bytes cleared, after-image | Object is updated | Ignores | Ignores |
| B | B7 | Created object authority information | Authority is changed | Ignores | Ignores |

| Journal code | Entry type | Operation | APYJRNCHG | APYJRNCHGX | RMVJRNCHG |
|--------------|------------|--|-----------------------------------|---------------------|-----------|
| B | CS | Integrated file system object closed | Ignores | Ignores | Ignores |
| B | ET | End journaling for object | Ends for this object ³ | Ignores | Ignores |
| B | FA | Integrated file system object attribute changed | Attribute is changed | Ignores | Ignores |
| B | FC | Integrated file system object forced | Ignores | Ignores | Ignores |
| B | FF | Storage for object freed | Ignores | Ignores | Ignores |
| B | FR | Integrated file system object restored | Ends for this object ³ | Ignores | Ignores |
| B | FS | Integrated file system object saved | Ignores | Ignores | Ignores |
| B | FW | Start of save | Ignores | Ignores | Ignores |
| B | JA | Change journaled objects attribute | Journal attribute changed | Ignores | Ignores |
| B | JT | Start journaling for object | Ignores | Ignores | Ignores |
| B | OA | Change object authority | Authority is changed | Ignores | Ignores |
| B | OF | Integrated file system object opened | Ignores | Ignores | Ignores |
| B | OG | Change primary group | Primary group is changed | Ignores | Ignores |
| B | OI | Object in use at abnormal end, object is synchronized ¹ | Ignores | Ignores | Ignores |
| B | OI | Object in use at abnormal end, object is not synchronized ¹ | Ends for this object ³ | Ignores | Ignores |
| B | OO | Change Object Owner | Owner is changed | Ignores | Ignores |
| B | RN | Rename file identifier | File identifier renamed | Ignores | Ignores |
| B | TR | Integrated file system object truncated | Object is truncated | Ignores | Ignores |
| B | WA | Write, after-image | Object is updated | Ignores | Ignores |
| C | All | | Ignores | Ignores | Ignores |
| D | AC | Add RI constraint | Constraint is added | Constraint is added | Ignores |
| D | CG | Change file | File is changed | File is changed | Ignores |
| D | CT | Create database file | Ignores | File is created | Ignores |

| Journal code | Entry type | Operation | APYJRNCHG | APYJRNCHGX | RMVJRNCHG |
|---------------------|-------------------|------------------------------------|---|---|------------------|
| D | DC | Remove RI constraint | Constraint is removed | Constraint is removed | Ignores |
| D | DD | End of apply | Ends for this object ³ | Ends for this object ³ | Ignores |
| D | DF | Delete file | Ignores | Ignores | Ignores |
| D | DG | Start of Apply | Ends for this object ³ | Ends for this object ³ | Ignores |
| D | DH | File saved | Ignores | Ignores | Ignores |
| D | DJ | Changed journaled object attribute | Journal attribute changed | Ignores | Ignores |
| D | DT | Delete file | File is deleted | File is deleted | Ignores |
| D | DW | Start of save | Ignores | Ignores | Ignores |
| D | DZ | File restored | Ends for this object ³ | Ends for this object ³ | Ignores |
| D | EF | End journal for file | Ends for this object ³ | Ends for this object ³ | Ignores |
| D | FM | File moved | File is moved ⁶ | File is moved | Ignores |
| D | FN | File renamed | File is renamed | File is renamed | Ignores |
| D | GC | Change constraint | Constraint is changed | Constraint is changed | Ignores |
| D | GO | Change owner | Owner is changed | Owner is changed | Ignores |
| D | GT | Grant authority | Authority is granted | Authority is granted | Ignores |
| D | ID | File in use | Ignores | Ignores | Ignores |
| D | JF | Start journaling file | Ignores | Ignores | Ignores |
| D | LF | Logical file association | Apply list updated | Apply list updated | Ignores |
| D | MA | Member added | List of objects being applied is updated. | List of objects being applied is updated. | Ignores |
| D | RV | Revoke authority | Authority is revoked | Authority is revoked | Ignores |
| D | TC | Create trigger | Trigger is created | Trigger is created | Ignores |
| D | TD | Remove trigger | Trigger is removed | Trigger is removed | Ignores |
| D | TG | Change trigger | Trigger is changed | Trigger is changed | Ignores |
| D | TQ | Refresh table | Table is refreshed | Table is refreshed | Ignores |

| Journal code | Entry type | Operation | APYJRNCHG | APYJRNCHGX | RMVJRNCHG |
|--------------|------------|--|-----------------------------------|-------------------|-----------------------------------|
| D | ZB | Change Object Attribute | Attribute Changed | Attribute Changed | Ignores |
| E | EA | Update data area, after image | Data area modified | Ignores | Ignores |
| E | EB | Update data area, before image | Ignores | Ignores | Data area modified |
| E | ED | Data area is deleted | Ends for this object ³ | Ignores | Ends for this object ³ |
| E | EE | Create data area | Data area is created | Ignores | Ignores |
| E | EG | Start journal for data area | Ignores | Ignores | Ends for this object ³ |
| E | EH | End journal for data area | Ends for this object ³ | Ignores | Ignores |
| E | EI | Data area in use, object synchronized ¹ | Ignores | Ignores | Ignores |
| E | EI | Data area in use, object not synchronized ¹ | Ends for this object ³ | Ignores | Ends for this object ³ |
| E | EK | Change journaled objects attribute | Attribute changed | Ignores | Ignores |
| E | EL | Data area restored | Ends for this object ³ | Ignores | Ends for this object ³ |
| E | EM | Data area moved | Data area is moved | Ignores | Ignores |
| E | EN | Data area renamed | Data area is renamed | Ignores | Ignores |
| E | EQ | Data area changes applied | Ends for this object ³ | Ignores | Ends for this object ³ |
| E | ES | Data area saved | Ignores | Ignores | Ignores |
| E | EU | RMVJRNCHG command started | Ends for this object ³ | Ignores | Ends for this object ³ |
| E | EW | Start of save for data area | Ignores | Ignores | Ignores |
| E | EX | Data area changes removed | Ends for this object ³ | Ignores | Ends for this object ³ |
| E | EY | APYJRNCHG command started | Ends for this object ³ | Ignores | Ends for this object ³ |
| E | ZA | Change authority | Object authority changed | Ignores | Ignores |
| E | ZB | Change object attribute | Attribute changed | Ignores | Ignores |
| E | ZO | Change owner | Owner changed | Ignores | Ignores |

| Journal code | Entry type | Operation | APYJRNCHG | APYJRNCHGX | RMVJRNCHG |
|--------------|------------|---|---|---|---|
| E | ZP | Change primary group | Primary group changed | Ignores | Ignores |
| E | ZT | Change audit attribute | Audit attribute changed | Ignores | Ignores |
| F | AY | Journalized changes applied | Ends for this object ³ | Ends for this object ³ | Ends for this object ³ |
| F | CB | Change File member | Member is changed | Member is changed | Ignores |
| F | CE | Change end of data | Member end of data changed ² | Member end of data changed ² | Ends for this object ³ |
| F | CH | File changed | Ignores | Ignores | Ignores |
| F | CL | Member closed | Ignores | Ignores | Ignores |
| F | CR | Member cleared | Member cleared of all records ² | Member cleared of all records ² | Ends for this object ³ |
| F | C1 | End Rollback | IF CMTBDY(*NO) is selected, ends for this object. If CMTBDY(*YES) is selected, ignores. | IF CMTBDY(*NO) is selected, ends for this object. If CMTBDY(*YES) is selected, ignores. | IF CMTBDY(*NO) is selected, ends for this object. If CMTBDY(*YES) is selected, ignores. |
| F | DE | Member deleted record count | Ignores | Ignores | Ignores |
| F | DM | Delete member | Member is deleted | Member is deleted | Ignores |
| F | EJ | End journaling | Ends for this object ³ | Ends for this object ³ | Ignores |
| F | EP | End journaling access paths | Ignores | Ignores | Ignores |
| F | FD | Member forced to auxiliary storage | Ignores | Ignores | Ignores |
| F | FI | Internal format information | Ignores | Ignores | Ignores |
| F | IU | Member in use at abnormal end, object synchronized ¹ | Ignores | Ignores | Ignores |
| F | IU | Member in use at abnormal end, object not synchronized ¹ | Ends for this object | Ends for this object | Ends for this object |
| F | IT | Identity Value | File identity changed | File identity changed | Ignores |
| F | IZ | Member initialized | Initialized records inserted in member | Initialized records inserted in member | Initialized records deleted from member |
| F | JC | Change journal attribute | Ignores | Ignores | Ignores |

| Journal code | Entry type | Operation | APYJRNCHG | APYJRNCHGX | RMVJRNCHG |
|--------------|------------------------|--|-----------------------------------|-----------------------------------|-----------------------------------|
| F | JM | Start journaling member | Ignores | Ignores | Ends for this object ³ |
| F | JP | Start journaling access paths | Ignores | Ignores | Ignores |
| F | MC | Create member | Member is created | Member is created | Ignores |
| F | MD | Member deleted | Ignores | Ignores | Ends for this object ³ |
| F | MF | Member saved with storage freed | Ends for this object ³ | Ends for this object ³ | Ends for this object ³ |
| F | MM | Member moved | Member is moved | Member is moved | Ignores |
| F | MN | Member renamed | Member is renamed | Member is renamed | Ignores |
| F | MO | Member changed | Ends for this object ³ | Ends for this object ³ | Ends for this object ³ |
| F | MR | Member restored | Ends for this object ³ | Ends for this object ³ | Ends for this object ³ |
| F | MS | Member saved | Ignores | Ignores | Ignores |
| F | OP | Member opened | Ignores | Ignores | Ignores |
| F | PD | Access path deleted | Ignores | Ignores | Ignores |
| F | PM | Logical owning member of access path moved | Ignores | Ignores | Ignores |
| F | PN | Logical owning member of access path renamed | Ignores | Ignores | Ignores |
| F | RC | Journalled changes removed | Ends for this object ³ | Ends for this object ³ | Ends for this object ³ |
| F | RG | Member reorganized | Ignores | Ignores | Ends for this object ³ |
| F | RM | Member reorganized | Member is reorganized | Member is reorganized | Ignores |
| F | SA | Start of APYJRNCHG | Ends for this object ³ | Ends for this object ³ | Ends for this object ³ |
| F | SR | Start of RMVJRNCHG | Ends for this object ³ | Ends for this object ³ | Ends for this object ³ |
| F | SS | Start of save active | Ignores | Ignores | Ignores |
| I | All | | Ignores | Ignores | Ignores |
| J | All (Except SI and SX) | | Ignores | Ignores | Ignores |

| Journal code | Entry type | Operation | APYJRNCHG | APYJRNCHGX | RMVJRNCHG |
|--------------|------------|---------------------------------------|-----------------------------------|----------------------|-----------|
| J | SI | Enter JRNSTATE(*STANDBY) | Ends | Ignores | Ignores |
| J | SX | Exit JRNSTATE(*STANDBY) | Ignores | Ignores | Ends |
| L | All | | Ignores | Ignores | Ignores |
| M | All | | Ignores | Ignores | Ignores |
| P | All | | Ignores | Ignores | Ignores |
| Q | QA | Create data queue | Data queue is created | Ignores | Ignores |
| Q | QB | Start data queue journaling | Ignores | Ends for this object | Ignores |
| Q | QC | Data queue cleared, no key | Data queue is cleared | Ignores | Ignores |
| Q | QD | Data queue deleted | Data queue is deleted | Ignores | Ignores |
| Q | QE | End data queue journaling | Ends for this object ⁴ | Ignores | Ignores |
| Q | QF | Change journaled object attribute | Attribute changed | Ignores | Ignores |
| Q | QG | Data queue attributes changed | Data queue attributes changed | Ignores | Ignores |
| Q | QH | Data queue changes applied | Ends for this object ⁴ | Ignores | Ignores |
| Q | QI | Queue in use, object synchronized | Ignores | Ignores | Ignores |
| Q | QI | Queue in use, object not synchronized | Ends for this object ⁴ | Ignores | Ignores |
| Q | QJ | Data queue cleared, has key | Data queue is cleared | Ignores | Ignores |
| Q | QK | Send data queue entry, has key | Entry is sent | Ignores | Ignores |
| Q | QL | Receive data queue entry, has key | Entry is received | Ignores | Ignores |
| Q | QM | Data queue moved | Data queue is moved ⁶ | Ignores | Ignores |
| Q | QN | Data queue renamed | Data queue is renamed | Ignores | Ignores |
| Q | QR | Receive data queue entry, no key | Entry is received | Ignores | Ignores |
| Q | QS | Send data queue entry, no key | Entry is sent | Ignores | Ignores |

| Journal code | Entry type | Operation | APYJRNCHG | APYJRNCHGX | RMVJRNCHG |
|--------------|------------|---|-----------------------------------|---------------------------------|----------------------------------|
| Q | QW | APYJRNCHG command started | Ends for this object ⁴ | Ignores | Ignores |
| Q | QX | Start of save for data queue | Ignores | Ignores | Ignores |
| Q | QY | Data queue saved | Ignores | Ignores | Ignores |
| Q | QZ | Data queue restored | Ends for this object ⁴ | Ignores | Ignores |
| Q | VE | Internal entry | Ignores | Ignores | Ignores |
| Q | VQ | Internal entry | Ends for this object ⁴ | Ignores | Ignores |
| Q | VW | Internal entry | Entries resequenced | Ignores | Ignores |
| Q | ZA | Change authority | Object authority changed | Ignores | Ignores |
| Q | ZB | Object attribute change | Attribute changed | Ignores | Ignores |
| Q | ZO | Change owner | Owner changed | Ignores | Ignores |
| Q | ZP | Change primary group | Primary group changed | Ignores | Ignores |
| Q | ZT | Change audit attribute | Audit attribute changed | Ignores | Ignores |
| R | BR | Before-image updated for rollback operation | Ignores | Ignores | Record updated with before-image |
| R | DL | Record deleted | Record deleted | Record deleted | Record updated with before-image |
| R | DR | Record deleted for rollback operation | Record deleted | Record deleted | Record updated |
| R | IL | Increment record limit | Ignores | Ignores | Ignores |
| R | PT | Record written to member | Record written to member | Record written to member | Record deleted from member |
| R | PX | Record added directly to member | Record added | Record added | Record deleted from member |
| R | UB | Record updated (before-image) | Ignores | Ignores | Record updated with before-image |
| R | UP | Record updated (after-image) | Record updated with after-image | Record updated with after-image | Ignores |
| R | UR | After-image updated for rollback operation | Record updated with after-image | Record updated with after-image | Ignores |
| S | All | | Ignores | Ignores | Ignores |
| T | All | | Ignores | Ignores | Ignores |

| Journal code | Entry type | Operation | APYJRNCHG | APYJRNCHGX | RMVJRNCHG |
|---------------------|-------------------|--|-----------------------------------|-------------------|------------------|
| U | User-specified | User entry | Ignores | Ignores | Ignores |
| Y | LF | Logical file association | Apply list updated | Ignores | Ignores |
| Y | YA | Change library attributes | Library attributes are changed | Ignores | Ignores |
| Y | YB | Start library journaling | Ignores | Ignores | Ignores |
| Y | YD | Library deleted | Library is deleted | Ignores | Ignores |
| Y | YE | End library journaling | Ends for this object ³ | Ignores | Ignores |
| Y | YH | Library changes applied | Ends for this object ³ | Ignores | Ignores |
| Y | YI | Library in use, object synchronized ¹ | Ignores | Ignores | Ignores |
| Y | YI | Library in use, object not synchronized ¹ | Ends for this object ³ | Ignores | Ignores |
| Y | YK | Change journal attribute | Attribute is changed | Ignores | Ignores |
| Y | YN | Library renamed | Library is renamed | Ignores | Ignores |
| Y | YO | Object added | Apply list updated | Ignores | Ignores |
| Y | YS | Library saved | Ignores | Ignores | Ignores |
| Y | YW | Start of save for library | Ignores | Ignores | Ignores |
| Y | YY | APYJRNCHG command started | Ends for this object ³ | Ignores | Ignores |
| Y | YZ | Library restored | Ends for this object ³ | Ignores | Ignores |
| Y | ZA | Change authority | Object authority is changed | Ignores | Ignores |
| Y | ZB | Object attribute change | Attribute is changed | Ignores | Ignores |
| Y | ZO | Change owner | Owner is changed | Ignores | Ignores |
| Y | ZP | Change primary group | Primary group is changed | Ignores | Ignores |
| Y | ZT | Change audit attribute | Audit attribute is changed | Ignores | Ignores |

| Journal code | Entry type | Operation | APYJRNCHG | APYJRNCHGX | RMVJRNCHG |
|---|------------|-----------|-----------|------------|-----------|
| <p>Notes:</p> <p>¹The Flag field in the journal entry indicates whether the object is synchronized (0 = object was synchronized; 1 = object was not synchronized).</p> <p>²Applying journaled changes stops at this entry if referential constraints that this entry violates are active during the apply operation.</p> <p>³Any changes found for the object that follow this entry are not applied. If any additional changes are found for this object an indication will be returned in the end of apply or remove journal entry, and in any output file generated. If you specify *END for the Object Error Option (OBJERROPT) when you issue the apply or remove journaled changes command, the entire apply or remove operation ends.</p> <p>⁴Any changes found for the object that follow this entry will NOT be applied when OBJERROPT(*CONTINUE) is specified. If any additional changes are found for this object, an indication will be returned in the end of apply/remove journal entry and in any outfile generated.</p> <p>⁵If the attribute change is to add before images, then the apply ends for the object.</p> <p>⁶If this entry was cut as part of automatically starting journaling the object due to library inheritance, then the apply ends for this object.</p> | | | | | |

Related concepts

[Journal entry information](#)

This topic provides information and tasks for working with journal entries.

Related tasks

[When the system ends applying or removing journaled changes](#)

The system ends applying or removing journaled changes as a result from one of the following items:

Related reference

[Apply Journaled Changes \(APYJRNCHG\) command](#)

[Apply Journaled Changes Extend \(APYJRNCHGX\) command](#)

[Remove Journaled Changes \(RMVJRNCHG\) command](#)

When the system ends applying or removing journaled changes

The system ends applying or removing journaled changes as a result from one of the following items:

- Certain journaled entries
- A format error for a database physical file (such as an undefined entry for that file member)
- A logical error for a database physical file (such as updating a record that has not been inserted or a duplicate key exception)
- A logical error for a data queue (such as inserting a keyed entry into a non-keyed queue)
- Unexpected error processing an entry

When one of the previous items occur, the apply or remove journaled changes action can end either for the object or for the entire apply or remove operation. You can determine this behavior by using the Object Error Option (OBJERROPT) parameter on the Apply Journaled Changes (APYJRNCHG), Apply Journaled Changes Extend (APYJRNCHGX), or Remove Journaled Changes (RMVJRNCHG) commands.

When OBJERROPT(*END) is specified, for entries that end applying or removing journaled changes, a message identifying the reason for the end is placed in the job log, and the corresponding change is not made to the object. The message contains the sequence number of the journal entry on which the failing condition was detected. When OBJERROPT(*CONTINUE) is specified, message CPD7016 indicates what entry the apply or removed stopped at, and the reason code. This information is also available in the output file if one was generated. To correct the problem do the following:

1. Analyze the error.

2. Make the necessary correction.
3. Start applying or removing journal changes again using the appropriate sequence number.

For example, if the entry that causes a RMVJRNCHG command to end is entry code F of type RG, you must reorganize the physical file member referred to in the journal entry. Use the same options that were originally specified on the reorganize request when the journal entry was recorded in the journal receiver. Resume removing journal changes by starting with the journal entry that follows the 'F RG' reorganize physical file member journal entry.

When you apply or remove journaled changes you also have the option to have the system send information about the operation to an output file. You can specify whether information is sent about all objects in the operation or only objects that have errors. To specify that the system sends information to an output file use the Output (OUTPUT) option on the APYJRNCHG, APYJRNCHGX, or RMVJRNCHG commands.

The APYJRNCHG, APYJRNCHGX, and RMVJRNCHG commands send an escape message and ends the operation if any required journal receiver defined by the RCVRNG parameter is not on the system and associated with the journal. Use the WRKJRNA command to select the Work with journal receiver directory display, to see which journal receivers are on the system and associated with the journal. The escape message contains the name of the required journal receiver if the reason code of message CPF7053 is 1 or if message CPF9801 is sent.

When the processing of applying or removing journaled changes ends with an escape message, the objects can be partially changed. To determine how many changes were applied or removed for each object do one of the following:

- Review the diagnostic messages in the job log prior to the final escape message for each object.
- Use the DSPJRN command to display the journal entries indicating completion of the command.
- If you specified to have the system send information to an output file, review the output file. The output file contains a record for each object that was processed. You can view that object's record to determine if processing completed successfully for that object.

The command completion journal entries by object type are as follows:

Database physical file members

F journal code and an entry type of AY or RC D journal code and entry type of DD

Integrated file system objects

B journal code and entry type of AJ

Data area objects

E journal code and entry type of EQ or EX

Data queue objects

Q journal code and entry type of QH

Library objects

Y journal code and entry type of YH

The **Count** field in the journal entry contains the number of journal entries that are applied or removed.

The system puts out a maximum of 512 diagnostic messages from Apply or Remove Journaled Changes. Therefore, it is recommended that you create an output file to determine how many changes were applied or removed for each object.

Related concepts

Use of the QAJRNCHG file

You can use the apply and remove journaled changes output (QAJRNCHG) file to make a record of all the activity that occurs when you perform an apply or remove journaled changes operation.

Example: Applying journaled changes

This topic provides examples of the Apply Journaled Changes (APYJRNCHG) command applied to a database physical file, integrated file system object, data queues, and data area.

The following examples show database physical files, data areas, and integrated file system objects being processed separately. However, you can use one APYJRNCHG command if you use the OBJ parameter for files and data areas, and the OBJPATH parameter for the integrated file system objects on one command call.

Note: By using the code examples, you agree to the terms of the [Code license and disclaimer information](#).

All journaled objects

This example recovers all objects that are journaled to the journal JRN2 in one apply operation. For this example, assume that journal JRN2 is using the receiver size-option RCVSIZOPT(*MAXOPT3). Since the ending sequence number is greater than 9 999 999 999, the TOENTLRG parameter is required. The example starts applying journaled changes from the last save of the objects, to entry sequence number 500 000 000 000.

By default, the system honors the commitment boundaries. So if there is an object whose commitment boundary ends after sequence number 500 000 000 000, the the apply operations will not apply any changes to that object for any commit cycles that end after sequence number 500 000 000 000. The apply operation continues for the other objects that are journaled to the journal.

```
APYJRNCHG JRN(JRN2) OBJ(*ALLJRNOBJ)
          FROMENTLRG(*LASTSAVE) TOENTLRG(500000000000)
          RCVRNG(*LASTSAVE)
```

Database physical file

The following command applies the changes in journal JRNA to all the members of all files in the library DSTPRODLIB that are being journaled to journal JRNA.

```
APYJRNCHG JRN(JRNLIB/JRNA) FILE((DSTPRODLIB/*ALL))
          FROMENTLRG(*LASTSAVE) TOENTLRG(*LASTRST)
```

Because the RCVRNG parameter is not specified, the system determines the range of journal receivers to use as a result of the save information for the files. The FROMENTLRG parameter defaults to apply the changes that begin with the first journal entry after the save of the object. The earliest required receiver is the receiver that contains the D DW journal entry indicating the earliest start of save entry for any file in DSTPRODLIB.

If the file was last saved with the save-while-active function, the saved copy of each file member includes all object-level changes in the journal entries up to the corresponding F SS journal entry. In this case, the system applies changes that begin with the first journal entry that follows the F SS entry.

If the file was last saved when it was not in use (normal save), the saved copy of each member includes all object-level changes in the journal entries up to the corresponding F MS member saved journal entry. In this case, the system applies changes that begin with the first journal entry that follows the F MS entry.

The following command applies the changes to the file from the journal receiver that is currently attached to the journal:

```
APYJRNCHG JRN(JRNLIB/JRNA) FILE((LIBA/FILEA MBR1))
          RCVRNG(*CURRENT) FROMENTLRG(*FIRST)
          TOENTLRG(*LASTRST) OUTPUT(*OUTFILE)
          OUTFILE(MYFILE) DETAIL(*ERR)
```

The *CURRENT journal receiver is the journal receiver that is attached to journal JRNA at the beginning of the operation. The system applies the changes from the first journal entry in this receiver to the entry before the object was last restored. Changes are applied to member MBR1 of the file FILEA.

Because OUTPUT(*OUTFILE) is specified, an output file with the name MYFILE is created. The output file contains a record for each object, if any, for which the apply ends early because DETAIL(*ERR) is specified.

The following command applies the changes in the journal JRNA to all members of the file FILEA beginning with the first journal entry after the file member was last saved:

```
APYJRNCHG JRN(JRNLIB/JRNA) FILE((LIBA/FILEA *ALL))
          TOJOB(000741/USERP/WORKSTP)
```

The operation continues until the specified job closes any of the members in the file that it opened. The operation is not restricted only to those journal entries that are recorded by the specified job.

Note: This example works only if you do not specify OMTJRNE (*OPNCLO) when starting journaling for the file and you did not specify RCVSIZOPT(*MINFIXLEN) or you did not use a FIXLENDTA option that would have omitted the job name for the journal at any time while the file was journaled).

Integrated file system object

The following command applies the changes in journal JRNA to the objects in the directory MyDirectory, and its subdirectories, that are being journaled to journal JRNA:

```
APYJRNCHG JRN(JRNLIB/JRNA) OBJPATH('/MyDirectory') SUBTREE(*ALL)
```

Because the RCVRNG parameter is not specified, the system determines the range of journal receivers to use as a result of the save information for the objects. Because the FROMENT or the FROMENTLRG parameters are not specified, the system applies the changes that begin with the journal entry for the last save of each of the objects.

If the object was last saved with the save-while-active function, the saved copy of each object includes all changes in the journal entries up to the corresponding B FW journal entry. In this case, the system applies changes that begin with the first journal entry that follows the B FW entry.

If the object was last saved when it was not in use (normal save), the saved copy of each object includes all changes in the journal entries up to the corresponding B FS saved journal entry. In this case, the system applies changes that begin with the first journal entry that follows the B FS entry.

Data area

The following command applies the changes to the data area DATA1 from the journal receiver that is currently attached to the journal:

```
APYJRNCHG JRN(JRNLIB/JRNA) OBJ((LIBA/DATA1 *DTAARA))
          RCVRNG(*CURRENT) FROMENTLRG(*FIRST)
          TOENTLRG(*LASTRST)
```

The *CURRENT journal receiver is the journal receiver that is attached to journal JRNA at the beginning of the operation. The system applies the changes from the first journal entry in this receiver to the entry before the object was last restored. Changes are applied to data area DATA1.

Note: Read the Code example disclaimer for important legal information.

Related reference

[Apply Journaled Changes \(APYJRNCHG\) command](#)

Example: Removing journaled changes

Even though the following examples show database physical files and data areas being processed separately, you can do them with one Remove Journaled Changes (RMVJRNCHG) command if you use the OBJ parameter for both object types.

Note: By using the code examples, you agree to the terms of the [Code license and disclaimer information](#).

Database physical file

The following command removes the changes in journal JRNA from the all the members of FILEA:

```
RMVJRNCHG JRN(JRNLIB/JRNA) FILE(DSTPRODLIB/FILEA)
          FROMENT(*LAST) TOENT(*FIRST)
          RCVRNG(*CURRENT)
```

The *CURRENT journal receiver is the journal receiver that is attached to journal JRNA at the beginning of the operation. The system starts removing the changes beginning with the latest entry for that member in this receiver and continues to the earliest entry for that member in this receiver.

The following command removes the changes in journal JRNA from all the members of FILEA:

```
RMVJRNCHG JRN(JRNLIB/JRNA) FILE(DSTPRODLIB/FILEA)
          FROMENT(*LAST) TOENT(*FIRST)
          RCVRNG(JRNLIB/RCVA10 JRNLIB/RCVA8)
          OUTPUT(*OUTFILE) OUTFILE(MYFILE)
```

The system starts removing the changes beginning with the last entry (the latest entry) for that member in journal receiver RCVA10 and continues to the first entry (the earliest entry) for that member on journal receiver RCVA8.

Because OUTPUT(*OUTFILE) is specified, an output file with the name MYFILE is created. The output file contains a record for each object that the remove operation processes. See [Use the apply and remove journaled changes output file](#) for an explanation of each field in the record.

Data area

The following removes the changes in JRNA from data area DATA1 from the last save entry to entry number 1003.

```
RMVJRNCHG JRN(JRNLIB/JRNA) OBJ((LIBA/DATA1 *DTAARA))
          RCVRNG(*CURRENT) FROMENT(*LASTSAVE) TOENT(1003)
```

If the last save operation used the save-while-active function, the system starts by removing changes from the entry preceding the last E EW start of save entry. If the last save operation was a normal save operation, the system starts by removing changes from the entry that precedes the last E ES data area saved entry. In the example, journaled changes are removed back to entry 1003.

Note: Read the Code example disclaimer for important legal information.

Related concepts

[Use of the QAJRNCHG file](#)

You can use the apply and remove journaled changes output (QAJRNCHG) file to make a record of all the activity that occurs when you perform an apply or remove journaled changes operation.

Related reference

[Remove Journaled Changes \(RMVJRNCHG\) command](#)

Example: Recovering objects with partial transactions

If you restore an object that was saved with a save-while-active operation that specified that the object can be saved before it reaches a commitment boundary, it can have partial transactions. To recover objects that are in a partial state you must perform an apply or a remove journaled changes operation.

Another reason that an object can have partial transactions is if a long-running rollback was forced to end. However, if an object has partial transactions because of a long-running rollback, you cannot recover it with an apply or remove journaled changes operation.

If you perform save-while-active operations that can result in objects that are saved with partial transaction, it is recommended that you use Backup, Recovery, and Media Services (BRMS). You can use BRMS to automate your backup and recovery operations. BRMS automatically applies changes to objects with partial transactions and restores them to a usable state. For more detailed information see the BRMS topic.

When you recover objects with partial transactions, all of the journal receivers that are required for the recovery operation must be on the system. The recovery operation might require more journal receivers than just the last one you detached. The system looks for the last journal receiver with an journal entry for the object that indicates one of the following:

- The last regular save.
 - The last save-while-active in which the object was saved without any partial transactions.
 - The earliest SC (start commit) entry for any open transactions that affect the saved object for a save with partial transactions.
1. Starting with receiver MYRCV05 the apply journaled changes operation starts.
 2. The systems finds the SS entry that indicates the object was saved with partial transactions.
 3. If journal receiver MYRCV05 has the CM entry that indicates the transaction for the object was committed, the apply journaled changes operation applies the changes.
 4. If journal receiver MYRCV05 does not have the CM entry, the system looks back to previous journal receivers.
 5. Since the SC entry is not in MYRCV04, the system looks in MYRCV03.
 6. The system finds the SC entry in MYRCV03 and the transaction is rolled back to that point.

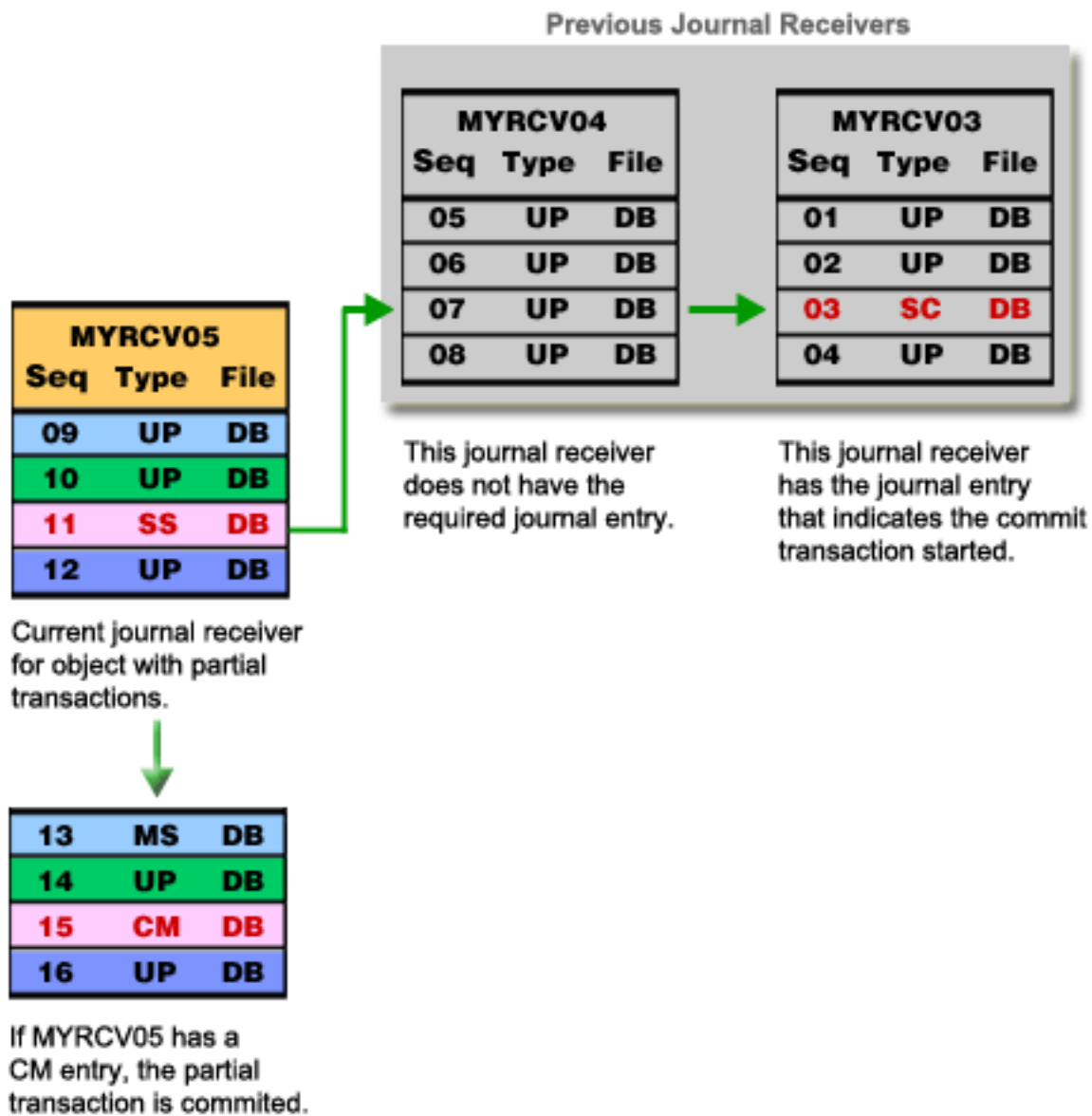

As the figure shows, even if you are performing an apply journaled changes operation, it is still possible that the transaction can be rolled back and you will need previous journal receivers.

Here is an example of restoring a single object with partial transactions. In this example, an object, OBJ1 in library LIB1, was saved with a save-while-active operation while it had pending transactions. The save-while-active operation is the object's most recent save. Journaled changes start from the last save and end at the last sequence number in the journal receiver.

One way to restore OBJ1 is to use the Apply Journaled Changes (APYJRNCHG) command. The default value for FROMENT is *LASTSAVE. The TOENT parameter uses the *LASTRST value to apply journaled changes up to the journal entry when the object was last restored.

```
APYJRNCHG JRN(JRN1) FILE(LIB1/OBJ1)
          FROMENT(*LASTSAVE) TOENT(*LASTRST)
          RCVRNG(*LASTSAVE)
```

Another way to restore OBJ1 is to use the Remove Journaled Changes (RMVJRNCHG) command. The command removes the changes in journal JRN1 from the all the members of OBJ1. Starting with the last save journal entry, only changes for journal entries for any partial transactions are removed, back to the start of the commit transaction.

```
RMVJRNCHG JRN(JRNA1) FILE(LIB1/OBJ1)
FROMENT(*LASTSAVE) TOENT(*COMMITSTART)
RCVRNG(*LASTSAVE)
```

Here is another example showing how to remove partial transaction status from an object with partial transactions. This example uses the Change Journal Object (CHGJRNOBJ) command, because the journal receivers are not available to perform an apply or remove journaled changes operation. The Partial Transactions (PTLTNS) parameter allows the object to be used, but does not complete the transactions. The object, BRKNOBJ, still has changes caused by the partial transactions, but you are able to open the file.

```
CHGJRNOBJ OBJECT(LIB1/BRKNOBJ *FILE) PTLTNS(*ALWUSE)
```



Attention: Only use the following command as a last resort. You **will lose data** if you use this command. You should only use this command for the following reasons:

- You have objects with partial transaction as a result of the termination of a long-running rollback and you have no saved version to restore.
- You have objects with partial transactions as a result of a save-while-active operation, and the journal receivers required to apply or remove journaled changes have been lost, destroyed, or damaged beyond repair.

Related concepts

[BRMS topic](#)

Journal entry information

This topic provides information and tasks for working with journal entries.

The system creates different types of journal entries in the journal receiver for different kinds of activities. You cannot access the information in journal receivers directly. Several system commands provide formatted information from a journal receiver:

- Use the **Display Journal (DSPJRN)** command to display entries, print them, or write them to an output file.
- Use the **Receive Journal Entry (RCVJRNE)** command to specify an exit program. When entries are added to the journal receiver, they are also passed to the exit program. The exit program can, for example, write entries to save media or send them to another system.
- Use the **Retrieve Journal Entry (RTVJRNE)** command to retrieve journal entries to a CL program.
- Use the `Retrieve Journal Entries (QjoRetrieveJournalEntries)` API to retrieve journal entries into a high level language program.

Note: When working with multiple journal entries, the RCVJRNE command is usually the most efficient interface to get the journal entry information.

When the system formats journal entries for you with the DSPJRN and RTVJRNE commands, it uses one of several layouts. These layouts include a fixed-length portion and a variable-length portion. The variable-length portion includes entry-specific data and null value indicators, if applicable. The fixed-length portion of the journal entry appears as separate fields in these layouts.

- Journal entry information finder - The Journal code finder shows all the journal codes and entry types for journal entries. You can search for individual codes, display codes by category, or display all journal codes.
- Journal code descriptions
- Fixed-length portion of the journal entry
- Variable-length portion of the journal entry
- Work with journal entry information

Note: For information about which journal codes are affected by applying or removing journaled changes see Actions of applying or removing journaled changes by journal code.

Related concepts

[Actions of applying or removing journaled changes by journal code](#)

The following table shows the actions that are taken by the Apply Journaled Changes (APYJRNCHG), Apply Journaled Changes Extend (APYJRNCHGX), or Remove Journaled Changes (RMVJRNCHG) command by journal code and entry type.

Journal code descriptions

This topic provides a description of all of the journal codes and categories.

Following are descriptions of all the possible journal codes or categories of journal entries.

Journal Code A - System Accounting Entry

Journal entries with a journal code of A contain information about job accounting. See [Job Accounting](#) in the Work Management topic for a detailed description of the contents of converted journal entries with journal code A.

Journal Code B - Integrated File System

Journal entries with a journal code of B contain information about changes to integrated file system objects. The only integrated file system objects that are supported are those with an object of type *STMF, *DIR or *SYMLNK. These objects must be in the "root"(/), QOpenSys, and User-defined file systems. See the [Integrated file system](#) topic for more information about file systems.

Journal Code C - Commitment Control Operation

Journal entries with a journal code of C contain commitment control information.

Journal Code D - Database File Operation

Journal entries with a journal code of D contain file level information about changes for a physical file, not an individual member.

Journal Code E - Data Area Operation

Journal entries with a journal code of E contain information about changes to journaled data areas. See Work Management on the V5R1 Supplemental Manuals Web site for more information about data areas.

Journal Code F - Database File Member Operation

Journal entries with a journal code of F contain file level information about changes for a physical file member that are being journaled to this journal. (If you use a logical file in a program, the file level information reflects the physical file on which the logical file is based.) Journal entries with journal code F can also contain file level information for access paths that are associated with physical or logical file members that are being journaled to this journal.

Journal Code I - Internal Operation

Journal entries with a journal code of I contain information about access paths or indexes or other internal operations. Entries with a journal code of I are displayed only if JRN(*INTSYSJRN) is specified or INCHIDENT(*YES) is specified on the DSPJRN command.

Journal Code J - Journal or Receiver Operation

Journal entries with a journal code of J contain information about the journal and the journal receivers.

Journal Code L - License Management

Journal entries with a journal code of L contain information about license management, such as changes to the usage limit and usage limit violations.

Journal Code M - Network Management Data

Journal entries with a journal code of M contain information about Network Management, including TCP/IP.

Journal Code P - Performance Tuning Entry

Journal entries with a journal code of P contain information about performance. For the description of the layout of these entries, see Work Management on the V5R1 Supplemental Manuals Web site.

Journal Code Q - Data Queue Operation

Journal entries with a journal code of Q contain information about changes to journaled data queues. See [CL Programming: Communicate between programs and procedures](#) for more information about data queues.

Journal Code R - Operation on Specific Record

Journal entries with a journal code of R contain information about a change to a specific record in the physical file member that is being journaled to the journal. For a given physical file member, the record-level journal entries appear in the journal in the order that the changes were made to the file.

Journal Code S - Distributed Mail Services

Journal entries with a journal code of S contain information about SNA distribution services (SNADS), X.400, and mail server framework.

Journal Code T - Audit Trail Entry

Journal entries with a journal code of T contain auditing information.

Journal Code U - User-Generated Entry

Journal entries with a code of U are sent to the journal receiver by the **Send Journal Entry (SNDJRNE)** command or by the Send Journal Entry (QJOSJRNE) API.

Journal Code Y - Library Entry

Journal entries with a journal code of Y contain information about changes to libraries.

Related concepts

[Sending your own journal entries](#)

You can use the Send Journal Entry (SNDJRNE) command or the Send Journal Entry (QJOSJRNE) API to add your own entries to a journal. The system places these entries in the journal's attached journal receiver along with the system-created journal entries.

All journal entries by code and type

| Journal code | Entry type | Description | Notes |
|--------------|------------|---------------------------|--|
| A | DP | Direct print information | See Work Management for the layout of the entry specific data. |
| A | JB | Job resource information | See Work Management for the layout of the entry specific data. |
| A | SP | Spooled print information | See Work Management for the layout of the entry specific data. |
| B | AA | Change audit attribute | The entry-specific data for these journal entries is laid out in the QSYSINC include file, QP0LJRN.L.H. See the layout for the “Integrated file system change audit attribute (B AA) journal entry” on page 236 . |
| B | AJ | Start of apply | |
| B | AT | End of apply | The entry-specific data for these journal entries is laid out in the QSYSINC include file, QP0LJRN.L.H. See the layout for the “APYJRNCHG (B AT, D DD, E EQ, F AY, Q QH, Y YH) and RMVJRNCHG (E EX, F RC) journal entries” on page 194. |

| Journal code | Entry type | Description | Notes |
|--------------|------------|---------------------------------------|---|
| B | BD | Integrated file system object deleted | <p>Even if this journal has a journal state of *STANDBY, this entry type will still be deposited in the journal receiver.</p> <p>The entry-specific data for these journal entries is laid out in the QSYSINC include file, QPOLJRN.L.H.</p> <p>See the layout for the “Integrated file system object deleted (B BD) journal entry” on page 246 .</p> |
| B | B0 | Begin create | <p>The entry-specific data for these journal entries is laid out in the QSYSINC include file, QPOLJRN.L.H.</p> <p>See the layout for the “Integrated file system begin create (B B0) journal entry” on page 236.</p> |
| B | B1 | Create summary | <p>The entry-specific data for these journal entries is laid out in the QSYSINC include file, QPOLJRN.L.H.</p> <p>See the layout for the “Integrated file system create-summary (B B1) journal entry” on page 242 .</p> |
| B | B2 | Link to existing object | <p>The entry-specific data for these journal entries is laid out in the QSYSINC include file, QPOLJRN.L.H.</p> <p>See the layout for the “Integrated file system link to existing object (B B2) journal entry” on page 244.</p> |
| B | B3 | Rename, move object | <p>Even if this journal has a journal state of *STANDBY, this entry type will still be deposited in the journal receiver.</p> <p>The entry-specific data for these journal entries is laid out in the QSYSINC include file, QPOLJRN.L.H.</p> <p>See the layout for the “Integrated file system rename, move object (B B3) journal entry” on page 248.</p> |
| B | B4 | Remove link (parent directory) | <p>The entry-specific data for these journal entries is laid out in the QSYSINC include file, QPOLJRN.L.H.</p> <p>See the layout for the “Integrated file system remove link (parent directory) (B B4) journal entry” on page 247.</p> |
| B | B5 | Remove link (link) | <p>The entry-specific data for these journal entries is laid out in the QSYSINC include file, QPOLJRN.L.H.</p> <p>See the layout for the “Integrated file system remove link (link) (B B5) journal entry” on page 247.</p> |
| B | B6 | Bytes cleared, after-image | <p>The entry-specific data for these journal entries is laid out in the QSYSINC include file, QPOLJRN.L.H.</p> |

| Journal code | Entry type | Description | Notes |
|--------------|------------|---|--|
| | | | See the layout for the “ Integrated file system bytes cleared, after-image (B B6) journal entry ” on page 236. |
| B | B7 | Created object authority information. | <p>The entry-specific data for these journal entries is laid out in the QSYSINC include file, QPOLJRN.L.H.</p> <p>This journal entry may have data which can only be accessed by using either the QjoRetrieveJournalEntries API or the RCVJRNE command. For the RCVJRNE command, use the ENTFMT(*TYPEPTR) or ENTFMT(*JRNENTFMT) parameters. In all other interfaces, if the data is not visible, the incomplete data indicator will be on and *POINTER will appear in the Entry Specific Data. For more information, refer to “Working with pointers in journal entries” on page 313</p> <p>See the layout for the “Integrated file system created object authority (B B7) journal entry” on page 241.</p> |
| B | CS | Integrated file system object closed | <p>The entry-specific data for these journal entries is laid out in the QSYSINC include file, QPOLJRN.L.H.</p> <p>See the layout for the “Integrated file system object closed (B CS) journal entry” on page 246.</p> |
| B | ET | End journaling for object | <p>Even if this journal has a journal state of *STANDBY, this entry type will still be deposited in the journal receiver.</p> <p>The entry-specific data for these journal entries is laid out in the QSYSINC include file, QPOLJRN.L.H.</p> <p>See the layout for the “Integrated file system end journaling for object (B ET) journal entry” on page 244.</p> |
| B | FA | Integrated file system object attribute changed | <p>The entry-specific data for these journal entries is laid out in the QSYSINC include file, QPOLJRN.L.H.</p> <p>See the layout for the “Integrated file system object attribute changed (B FA) journal entry” on page 245.</p> |
| B | FC | Integrated file system object forced | <p>The entry-specific data for these journal entries is laid out in the QSYSINC include file, QPOLJRN.L.H.</p> <p>See the layout for the “Integrated file system object forced (B FC) journal entry” on page 246.</p> |
| B | FF | Storage for object freed | These entries do not indicate that they occurred as the result of a trigger program, even if a trigger program caused the event. That information is not available at the time the entry is written to the journal. |

| Journal code | Entry type | Description | Notes |
|--------------|------------|--|---|
| | | | <p>The entry-specific data for these journal entries is laid out in the QSYSINC include file, QPOLJRN.L.H.</p> <p>See the layout for the “Integrated file system storage for object freed (B FF) journal entry” on page 250.</p> |
| B | FR | Integrated file system object restored | <p>These entries do not indicate that they occurred as the result of a trigger program, even if a trigger program caused the event. That information is not available at the time the entry is written to the journal.</p> <p>Even if this journal has a journal state of *STANDBY, this entry type will still be deposited in the journal receiver.</p> <p>The entry-specific data for these journal entries is laid out in the QSYSINC include file, QPOLJRN.L.H.</p> <p>See the layout for the “Object restored (B FR, D DZ, E EL, F MR, J RR, Q QZ, Y YZ) and receiver saved (J RS) journal entries” on page 289.</p> |
| B | FS | Integrated file system object saved | <p>These entries do not indicate that they occurred as the result of a trigger program, even if a trigger program caused the event. That information is not available at the time the entry is written to the journal.</p> <p>The entry-specific data for these journal entries is laid out in the QSYSINC include file, QPOLJRN.L.H.</p> <p>See the layout for the “Object saved (B FS, D DH, E ES, F MS, Q QY, Y YS) journal entries” on page 291.</p> |
| B | FW | Start of save for save-while-active | <p>These entries do not indicate that they occurred as the result of a trigger program, even if a trigger program caused the event. That information is not available at the time the entry is written to the journal.</p> <p>The entry-specific data for these journal entries is laid out in the QSYSINC include file, QPOLJRN.L.H.</p> <p>See the layout for the “Start of save-while-active (B FW, D DW, E EW, F SS, Q QX, Y YW) journal entries” on page 296.</p> |
| B | JA | Change journaled object attribute | <p>The entry-specific data for these journal entries is laid out in the QSYSINC include file, QPOLJRN.L.H.</p> <p>See the layout for the “Change journaled object attributes (B JA, D DJ, E EK, F JC, Q QF, Y YK) journal entries” on page 201.</p> |

| Journal code | Entry type | Description | Notes |
|--------------|------------|---|--|
| B | JT | Start journaling for object | <p>Even if this journal has a journal state of *STANDBY, this entry type will still be deposited in the journal receiver.</p> <p>The entry-specific data for these journal entries is laid out in the QSYSINC include file, QPOLJRN.L.H.</p> <p>See the layout for the “Start journal (B JT, D JF, E EG, F JM, Q QB) journal entries” on page 297.</p> |
| B | OA | Change object authority | <p>The entry-specific data for these journal entries is laid out in the QSYSINC include file, QPOLJRN.L.H.</p> <p>See the layout for the “Integrated file system change object authority (B OA) journal entry” on page 237.</p> |
| B | OF | Integrated file system object opened | <p>The entry-specific data for these journal entries is laid out in the QSYSINC include file, QPOLJRN.L.H.</p> <p>See the layout for the “Integrated file system object opened (B OF) journal entries” on page 246.</p> |
| B | OG | Change primary group | <p>The entry-specific data for these journal entries is laid out in the QSYSINC include file, QPOLJRN.L.H.</p> <p>See the layout for the “Integrated file system change primary group (B OG) journal entry” on page 239.</p> |
| B | OI | Object in use at abnormal end | <p>See the layout for the “IPL (J IA, J IN) and in-use (B OI, C BA, D ID, E EI, F IU, I DA, J JI, Q QI) journal entries” on page 253.</p> |
| B | OO | Change object owner | <p>The entry-specific data for these journal entries is laid out in the QSYSINC include file, QPOLJRN.L.H.</p> <p>See the layout for the “Integrated file system change object owner (B OO) journal entry” on page 239.</p> |
| B | RN | Rename file identifier | <p>The entry-specific data for these journal entries is laid out in the QSYSINC include file, QPOLJRN.L.H.</p> <p>See the layout for the “Integrated file system rename file identifier (B RN) journal entry” on page 248.</p> |
| B | TR | Integrated file system object truncated | <p>The entry-specific data for these journal entries is laid out in the QSYSINC include file, QPOLJRN.L.H.</p> <p>See the layout for the “Integrated file system object truncated (B TR) journal entry” on page 247.</p> |
| B | WA | Write, after-image | <p>The entry-specific data for these journal entries is laid out in the QSYSINC include file, QPOLJRN.L.H.</p> |

| Journal code | Entry type | Description | Notes |
|--------------|------------|--|--|
| | | | <p>This journal entry may have data which can only be accessed by using either the QjoRetrieveJournalEntries API or the RCVJRNE command. For the RCVJRNE command, use the ENTFFMT(*TYPEPTR) or ENTFFMT(*JRNENTFFMT) parameters. In all other interfaces, if the data is not visible, the incomplete data indicator will be on and *POINTER will appear in the Entry Specific Data. For more information, refer to “Working with pointers in journal entries” on page 313</p> <p>See the layout for the “Integrated file system write, after-image (B WA) journal entry” on page 250.</p> |
| C | BA | Commit in use at abnormal end | See the layout for the “IPL (J IA, J IN) and in-use (B OI, C BA, D ID, E EI, F IU, I DA, J JI, Q QI) journal entries” on page 253 . |
| C | BC | Start commitment control (STRCMTCTL) | Even if this journal has a journal state of *STANDBY, this entry type will still be deposited in the journal receiver. |
| C | CM | Set of record changes committed (COMMIT) | See the layout for the “COMMIT (C CM) journal entry” on page 206 . |
| C | CN | Rollback ended early | See the layout for the “Rollback ended early (C CN, F C1) journal entries” on page 294. |
| C | DB | Internal entry | Even if this journal has a journal state of *STANDBY, this entry type will still be deposited in the journal receiver. |
| C | EC | End commitment control (ENDCMTCTL) | Even if this journal has a journal state of *STANDBY, this entry type will still be deposited in the journal receiver. |
| C | LW | A logical unit of work (LUW) has ended | <p>See the layout for the “Logical unit of work (C LW) journal entry” on page 256 and the following:</p> <ul style="list-style-type: none"> • “Logical unit of work (C LW) journal entry - header record” on page 266 • “Logical unit of work (C LW) journal entry - local record” on page 276 • “Logical unit of work (C LW) journal entry - API record” on page 257 • “Logical unit of work (C LW) journal entry - DDL record” on page 260 • “Logical unit of work (C LW) journal entry - RMT record” on page 278 • “Logical unit of work (C LW) journal entry - DDM record” on page 263 |

| Journal code | Entry type | Description | Notes |
|--------------|------------|--|--|
| C | PC | Prepare commit block | See the layout for the “Prepare commit (C PC) journal entries” on page 293. |
| C | RB | Set of record changes rolled back (ROLLBACK) | See the layout for the “ROLLBACK (C RB) journal entry” on page 293. |
| C | R1 | Rollback started | |
| C | SB | Start of savepoint | This is the start of the savepoint or nested commit cycle where it is written to the journal and occurs when the application creates an SQL SAVEPOINT. The system can also create an internal nested commit cycle to handle a series of database functions as a single operation. The entry-specific data for this journal entry is all internal data. |
| C | SC | Commit transaction started | See the layout for the “Start of commit cycle (C SC) journal entry” on page 296. |
| C | SQ | Release of savepoint | This is the release of the savepoint or commit of nested commit cycle. Entries are written to the journal when the application releases an SQL SAVEPOINT or when the system commits an internal nested commit cycle. See the layout for the “Savepoint released (C SQ) and savepoint rolled back (C SU) journal entries” on page 294. |
| C | SU | Rollback of save point | This is the release of the savepoint or commit of nested commit cycle. Entries are written to the journal when the application releases an SQL SAVEPOINT or when the system commits an internal nested commit cycle. See the layout for the “Savepoint released (C SQ) and savepoint rolled back (C SU) journal entries” on page 294. |
| D | AC | Add referential integrity constraint | See the layout for the “Object level (D AC, D CG, D CT, D DC, D DT, D GC, D GO, D GT, D M1, D M2, D M3, D P1, D P2, D P3, D RV, D TC, D TD, D TG, D TQ, F CB, F DM, F MC) journal entries” on page 286. |
| D | CG | Change file | See the layout for the “Object level (D AC, D CG, D CT, D DC, D DT, D GC, D GO, D GT, D M1, D M2, D M3, D P1, D P2, D P3, D RV, D TC, D TD, D TG, D TQ, F CB, F DM, F MC) journal entries” on page 286. |
| D | CT | Create database file | See the layout for the “Object level (D AC, D CG, D CT, D DC, D DT, D GC, D GO, D GT, D M1, D M2, D M3, D P1, D P2, D P3, D RV, D TC, D TD, D TG, D TQ, F CB, F DM, F MC) journal entries” on page 286. |

| Journal code | Entry type | Description | Notes |
|--------------|------------|---|---|
| D | DC | Remove referential integrity constraint | See the layout for the “Object level (D AC, D CG, D CT, D DC, D DT, D GC, D GO, D GT, D M1, D M2, D M3, D P1, D P2, D P3, D RV, D TC, D TD, D TG, D TQ, F CB, F DM, F MC) journal entries” on page 286. |
| D | DD | End of apply or remove | See the layout for the “APYJRNCHG (B AT, D DD, E EQ, F AY, Q QH, Y YH) and RMVJRNCHG (E EX, F RC) journal entries” on page 194. |
| D | DF | File was deleted | Even if this journal has a journal state of *STANDBY, this entry type will still be deposited in the journal receiver. |
| D | DG | Start of apply or remove | |
| D | DH | File saved | These entries do not indicate that they occurred as the result of a trigger program, even if a trigger program caused the event. That information is not available at the time the entry is written to the journal. See the layout for the “Object saved (B FS, D DH, E ES, F MS, Q QY, Y YS) journal entries” on page 291. |
| D | DJ | Change journaled object attribute | See the layout for the “Change journaled object attributes (B JA, D DJ, E EK, F JC, Q QF, Y YK) journal entries” on page 201. |
| D | DT | Delete file | Even if this journal has a journal state of *STANDBY, this entry type will still be deposited in the journal receiver. See the layout for the “Object level (D AC, D CG, D CT, D DC, D DT, D GC, D GO, D GT, D M1, D M2, D M3, D P1, D P2, D P3, D RV, D TC, D TD, D TG, D TQ, F CB, F DM, F MC) journal entries” on page 286. |
| D | DW | Start of save-while-active save | These entries do not indicate that they occurred as the result of a trigger program, even if a trigger program caused the event. That information is not available at the time the entry is written to the journal. See the layout for the “Start of save-while-active (B FW, D DW, E EW, F SS, Q QX, Y YW) journal entries” on page 296. |
| D | DZ | File restored | These entries do not indicate that they occurred as the result of a trigger program, even if a trigger program caused the event. That information is not available at the time the entry is written to the journal. Even if this journal has a journal state of *STANDBY, this entry type will still be deposited in the journal receiver. |

| Journal code | Entry type | Description | Notes |
|--------------|------------|--|--|
| | | | See the layout for the “Object restored (B FR, D DZ, E EL, F MR, J RR, Q QZ, Y YZ) and receiver saved (J RS) journal entries” on page 289. |
| D | EF | Journaling for a physical file ended (ENDJRNPf) | Even if this journal has a journal state of *STANDBY, this entry type will still be deposited in the journal receiver. |
| D | FM | File moved to a different library (MOVObj or RNMOBJ OBJTYPE(*LIB)) | Even if this journal has a journal state of *STANDBY, this entry type will still be deposited in the journal receiver. See the layout for the “Moving and renaming objects (D FM, D FN, E EM, E EN, F MM, F MN, F PM, F PN, J MJ, Q QM, Q QN) journal entries” on page 284. |
| D | FN | File renamed (RNMOBJ) | Even if this journal has a journal state of *STANDBY, this entry type will still be deposited in the journal receiver. See the layout for the “Moving and renaming objects (D FM, D FN, E EM, E EN, F MM, F MN, F PM, F PN, J MJ, Q QM, Q QN) journal entries” on page 284. |
| D | GC | Change constraint | See the layout for the “Object level (D AC, D CG, D CT, D DC, D DT, D GC, D GO, D GT, D M1, D M2, D M3, D P1, D P2, D P3, D RV, D TC, D TD, D TG, D TQ, F CB, F DM, F MC) journal entries” on page 286. |
| D | GO | Change owner | See the layout for the “Object level (D AC, D CG, D CT, D DC, D DT, D GC, D GO, D GT, D M1, D M2, D M3, D P1, D P2, D P3, D RV, D TC, D TD, D TG, D TQ, F CB, F DM, F MC) journal entries” on page 286. |
| D | GT | Grant authority | See the layout for the “Object level (D AC, D CG, D CT, D DC, D DT, D GC, D GO, D GT, D M1, D M2, D M3, D P1, D P2, D P3, D RV, D TC, D TD, D TG, D TQ, F CB, F DM, F MC) journal entries” on page 286. |
| D | ID | File in use | See the layout for the “IPL (J IA, J IN) and in-use (B OI, C BA, D ID, E EI, F IU, I DA, J JI, Q QI) journal entries” on page 253. |
| D | JF | Journaling for a physical file started (STRJRNPf (JRNPf)) | Even if this journal has a journal state of *STANDBY, this entry type will still be deposited in the journal receiver. See the layout for the “Start journal (B JT, D JF, E EG, F JM, Q QB) journal entries” on page 297. |
| D | LF | Logical file associated with based on physical file | The entry-specific data for these journal entries is laid out in the QSYSINC include file, QLIJRN.L.H. |

| Journal code | Entry type | Description | Notes |
|--------------|------------|----------------------|---|
| | | | See the layout for the “Logical file associated with the library or based on physical file (D LF, Y LF) journal entry” on page 255. |
| D | M1 | Create mask | See the layout for the “Object level (D AC, D CG, D CT, D DC, D DT, D GC, D GO, D GT, D M1, D M2, D M3, D P1, D P2, D P3, D RV, D TC, D TD, D TG, D TQ, F CB, F DM, F MC) journal entries” on page 286. |
| D | M2 | Drop mask | See the layout for the “Object level (D AC, D CG, D CT, D DC, D DT, D GC, D GO, D GT, D M1, D M2, D M3, D P1, D P2, D P3, D RV, D TC, D TD, D TG, D TQ, F CB, F DM, F MC) journal entries” on page 286. |
| D | M3 | Alter mask | See the layout for the “Object level (D AC, D CG, D CT, D DC, D DT, D GC, D GO, D GT, D M1, D M2, D M3, D P1, D P2, D P3, D RV, D TC, D TD, D TG, D TQ, F CB, F DM, F MC) journal entries” on page 286. |
| D | MA | Member added to file | |
| D | P1 | Create permission | See the layout for the “Object level (D AC, D CG, D CT, D DC, D DT, D GC, D GO, D GT, D M1, D M2, D M3, D P1, D P2, D P3, D RV, D TC, D TD, D TG, D TQ, F CB, F DM, F MC) journal entries” on page 286. |
| D | P2 | Drop permission | See the layout for the “Object level (D AC, D CG, D CT, D DC, D DT, D GC, D GO, D GT, D M1, D M2, D M3, D P1, D P2, D P3, D RV, D TC, D TD, D TG, D TQ, F CB, F DM, F MC) journal entries” on page 286. |
| D | P3 | Alter permission | See the layout for the “Object level (D AC, D CG, D CT, D DC, D DT, D GC, D GO, D GT, D M1, D M2, D M3, D P1, D P2, D P3, D RV, D TC, D TD, D TG, D TQ, F CB, F DM, F MC) journal entries” on page 286. |
| D | RV | Revoke authority | See the layout for the “Object level (D AC, D CG, D CT, D DC, D DT, D GC, D GO, D GT, D M1, D M2, D M3, D P1, D P2, D P3, D RV, D TC, D TD, D TG, D TQ, F CB, F DM, F MC) journal entries” on page 286. |
| D | TC | Add trigger | See the layout for the “Object level (D AC, D CG, D CT, D DC, D DT, D GC, D GO, D GT, D M1, D M2, D M3, D P1, D P2, D P3, D RV, D TC, D TD, D TG, D TQ, F CB, F DM, F MC) journal entries” on page 286. |
| D | TD | Remove trigger | See the layout for the “Object level (D AC, D CG, D CT, D DC, D DT, D GC, D GO, D GT, D M1, D M2, D M3, D P1, D P2, D P3, D RV, D TC, D TD, D TG, D TQ, F CB, F DM, F MC) journal entries” on page 286. |
| D | TG | Change trigger | See the layout for the “Object level (D AC, D CG, D CT, D DC, D DT, D GC, D GO, D GT, D M1, D M2, D |

| Journal code | Entry type | Description | Notes |
|--------------|------------|--------------------------------|--|
| | | | M3, D P1, D P2, D P3, D RV, D TC, D TD, D TG, D TQ, F CB, F DM, F MC) journal entries” on page 286. |
| D | TQ | Refresh table | See the layout for the “Object level (D AC, D CG, D CT, D DC, D DT, D GC, D GO, D GT, D M1, D M2, D M3, D P1, D P2, D P3, D RV, D TC, D TD, D TG, D TQ, F CB, F DM, F MC) journal entries” on page 286. |
| D | ZB | Change object attribute | The entry-specific data for these journal entries is laid out in the QSYSINC include file, QP0LJRN.L.H. See the layout for the “Change object attribute (E ZB, D ZB, J ZB, Q ZB, Y ZB) journal entry” on page 202. |
| E | EA | Update data area, after image | Neither the before-image nor after-image is deposited into the journal if the after-image is exactly the same as the before-image. This entry may have minimized entry specific data (ESD). It will have minimized ESD if its corresponding object type deposits minimized journal entries through the MINENTDTA parameter for this journal or journal receiver. The entry-specific data for these journal entries is laid out in the QSYSINC include file, QWCJRN.L.H. See the layout for the “Update data area (E EA, E EB) journal entries” on page 299. |
| E | EB | Update data area, before image | Neither the before-image nor after-image is deposited into the journal if the after-image is exactly the same as the before-image. This entry may have minimized entry specific data (ESD). It will have minimized ESD if its corresponding object type deposits minimized journal entries through the MINENTDTA parameter for this journal or journal receiver. The entry-specific data for these journal entries is laid out in the QSYSINC include file, QWCJRN.L.H. See the layout for the “Update data area (E EA, E EB) journal entries” on page 299. |
| E | ED | Data area deleted | Even if this journal has a journal state of *STANDBY, this entry type will still be deposited in the journal receiver. |
| E | EE | Create data area | The entry-specific data for these journal entries is laid out in the QSYSINC include file, QWCJRN.L.H. See the layout for the “Create data area (E EE) journal entry” on page 211. |

| Journal code | Entry type | Description | Notes |
|--------------|------------|-----------------------------------|--|
| E | EG | Start journal for data area | <p>Even if this journal has a journal state of *STANDBY, this entry type will still be deposited in the journal receiver.</p> <p>See the layout for the “Start journal (B JT, D JF, E EG, F JM, Q QB) journal entries” on page 297.</p> |
| E | EH | End journal for data area | <p>Even if this journal has a journal state of *STANDBY, this entry type will still be deposited in the journal receiver.</p> |
| E | EI | Data area in use | |
| E | EK | Change journaled object attribute | <p>The entry-specific data for these journal entries is laid out in the QSYSINC include file, QWCJRN.L.H.</p> <p>See the layout for the “Change journaled object attributes (B JA, D DJ, E EK, F JC, Q QF, Y YK) journal entries” on page 201.</p> |
| E | EL | Data area restored | <p>These entries do not indicate that they occurred as the result of a trigger program, even if a trigger program caused the event. That information is not available at the time the entry is written to the journal.</p> <p>The entry-specific data for these journal entries is laid out in the QSYSINC include file, QWCJRN.L.H.</p> <p>See the layout for the “Object restored (B FR, D DZ, E EL, F MR, J RR, Q QZ, Y YZ) and receiver saved (J RS) journal entries” on page 289.</p> |
| E | EM | Data area moved | <p>Even if this journal has a journal state of *STANDBY, this entry type will still be deposited in the journal receiver.</p> <p>The entry-specific data for these journal entries is laid out in the QSYSINC include file, QWCJRN.L.H.</p> <p>See the layout for the “Moving and renaming objects (D FM, D FN, E EM, E EN, F MM, F MN, F PM, F PN, J MJ, Q QM, Q QN) journal entries” on page 284.</p> |
| E | EN | Data area renamed | <p>Even if this journal has a journal state of *STANDBY, this entry type will still be deposited in the journal receiver.</p> <p>The entry-specific data for these journal entries is laid out in the QSYSINC include file, QWCJRN.L.H.</p> <p>See the layout for the “Moving and renaming objects (D FM, D FN, E EM, E EN, F MM, F MN, F PM, F PN, J MJ, Q QM, Q QN) journal entries” on page 284.</p> |

| Journal code | Entry type | Description | Notes |
|--------------|------------|--|---|
| E | EQ | Data area changes applied | The entry-specific data for these journal entries is laid out in the QSYSINC include file, QWCJRN.L.H. See the layout for the “ APYJRNCHG (B AT, D DD, E EQ, F AY, Q QH, Y YH) and RMVJRNCHG (E EX, F RC) journal entries” on page 194. |
| E | ES | Data area saved | These entries do not indicate that they occurred as the result of a trigger program, even if a trigger program caused the event. That information is not available at the time the entry is written to the journal. The entry-specific data for these journal entries is laid out in the QSYSINC include file, QWCJRN.L.H. See the layout for the “ Object saved (B FS, D DH, E ES, F MS, Q QY, Y YS) journal entries” on page 291. |
| E | EU | Remove journaled changes (RMVJRNCHG) command started | |
| E | EW | Start of save for data area | These entries do not indicate that they occurred as the result of a trigger program, even if a trigger program caused the event. That information is not available at the time the entry is written to the journal. The entry-specific data for these journal entries is laid out in the QSYSINC include file, QWCJRN.L.H. See the layout for the “ Start of save-while-active (B FW, D DW, E EW, F SS, Q QX, Y YW) journal entries” on page 296. |
| E | EX | Data area changes removed | The entry-specific data for these journal entries is laid out in the QSYSINC include file, QWCJRN.L.H. See the layout for the “ APYJRNCHG (B AT, D DD, E EQ, F AY, Q QH, Y YH) and RMVJRNCHG (E EX, F RC) journal entries” on page 194. |
| E | EY | Apply journaled changes (APYJRNCHG) command started | |
| E | ZA | Change authority | The entry-specific data for these journal entries is laid out in the QSYSINC include file, QWCJRN.L.H. See the layout for the “ Change authority (E ZA, J ZA, Q ZA, Y ZA) journal entry” on page 196. |
| E | ZB | Change object attribute | The entry-specific data for these journal entries is laid out in the QSYSINC include file, QWCJRN.L.H. |

| Journal code | Entry type | Description | Notes |
|--------------|------------|--|--|
| | | | See the layout for the “Change object attribute (E ZB, D ZB, J ZB, Q ZB, Y ZB) journal entry” on page 202. |
| E | ZO | Ownership change | The entry-specific data for these journal entries is laid out in the QSYSINC include file, QWCJRN.L.H. See the layout for the “Ownership change (E ZO, J ZO, Q ZO, Y ZO) journal entries” on page 292. |
| E | ZP | Change primary group | The entry-specific data for these journal entries is laid out in the QSYSINC include file, QWCJRN.L.H. See the layout for the “Change primary group (E ZP, J ZP, Q ZP, Y ZP) journal entry” on page 203. |
| E | ZT | Auditing change | The entry-specific data for these journal entries is laid out in the QSYSINC include file, QWCJRN.L.H. See the layout for the “Auditing Change (E ZT, J ZT, Q ZT, Y ZT) journal entries” on page 196. |
| F | AY | Journalized changes applied to a physical file member (APYJRNCHG) | See the layout for the “APYJRNCHG (B AT, D DD, E EQ, F AY, Q QH, Y YH) and RMVJRNCHG (E EX, F RC) journal entries” on page 194. |
| F | CB | Physical file member changed | See the layout for the “Object level (D AC, D CG, D CT, D DC, D DT, D GC, D GO, D GT, D M1, D M2, D M3, D P1, D P2, D P3, D RV, D TC, D TD, D TG, D TQ, F CB, F DM, F MC) journal entries” on page 286. |
| F | CE | Change end of data for physical file member | See the layout for the “Change end of data (F CE) journal entry” on page 201. |
| F | CH | Change file | As of V5R1M0, the journal entry D CG is also being sent for the change file operations. IBM strongly recommends that you do your processing based on the D CG entry instead of the F CH entry because the F CH entry may be retired in a future release. |
| F | CL | Physical file member closed (for shared files, a close entry is made for the last close operation of the file) | See the layout for the “Database file OPEN (F OP) and database file CLOSE (F CL) journal entries” on page 223. |
| F | CR | Physical file member cleared (CLRPFM) | |
| F | C1 | Rollback ended early | See the layout for the “Rollback ended early (C CN, F C1) journal entries” on page 294. |
| F | DE | Physical file member deleted record count | |

| Journal code | Entry type | Description | Notes |
|--------------|------------|---|--|
| F | DM | Delete member | Even if this journal has a journal state of *STANDBY, this entry type will still be deposited in the journal receiver. See the layout for the “Object level (D AC, D CG, D CT, D DC, D DT, D GC, D GO, D GT, D M1, D M2, D M3, D P1, D P2, D P3, D RV, D TC, D TD, D TG, D TQ, F CB, F DM, F MC) journal entries” on page 286. |
| F | EJ | Journaling for a physical file member ended (ENDJRNPFF) | Even if this journal has a journal state of *STANDBY, this entry type will still be deposited in the journal receiver. |
| F | EP | Journaling access path for a database file member ended (ENDJRNPAP) | Even if this journal has a journal state of *STANDBY, this entry type will still be deposited in the journal receiver. |
| F | FD | Physical file member forced (written) to auxiliary storage | See the layout for the “Force data to auxiliary storage (F FD) journal entry” on page 235. |
| F | FI | System-generated journal entry format information | |
| F | IT | Identity value | See the layout for the “Identity Value (F IT) journal entries” on page 250. |
| F | IU | Physical file member in use at the time of abnormal system end | See the layout for the “IPL (J IA, J IN) and in-use (B OI, C BA, D ID, E EI, F IU, I DA, J JI, Q QI) journal entries” on page 253. |
| F | IZ | Physical file member initialized (INZPFM) | This journal entry may have data which can only be accessed by using either the QjoRetrieveJournalEntries API or the RCVJRNE command. For the RCVJRNE command, use the ENTFMT(*TYPEPTR) or ENTFMT(*JRNENTFMT) parameters. In all other interfaces, if the data is not visible, the incomplete data indicator will be on and *POINTER will appear in the Entry Specific Data. For more information, refer to “Working with pointers in journal entries” on page 313. See the layout for the “INZPFM (F IZ) journal entry” on page 251. |
| F | JC | Change journaled object attribute | See the layout for the “Change journaled object attributes (B JA, D DJ, E EK, F JC, Q QF, Y YK) journal entries” on page 201. |
| F | JM | Journaling for a physical file member started (STRJRNPFF) | Even if this journal has a journal state of *STANDBY, this entry type will still be deposited in the journal receiver. |

| Journal code | Entry type | Description | Notes |
|--------------|------------|--|--|
| | | | See the layout for the “Start journal (B JT, D JF, E EG, F JM, Q QB) journal entries” on page 297. |
| F | JP | Journaling access path for a database file member started (STRJRNP) | Even if this journal has a journal state of *STANDBY, this entry type will still be deposited in the journal receiver. |
| F | MC | Create member | See the layout for the “Object level (D AC, D CG, D CT, D DC, D DT, D GC, D GO, D GT, D M1, D M2, D M3, D P1, D P2, D P3, D RV, D TC, D TD, D TG, D TQ, F CB, F DM, F MC) journal entries” on page 286. |
| F | MD | Physical file member deleted. This entry is created when you remove the member (RMVM) or delete the file (DLTF) containing the member. | Even if this journal has a journal state of *STANDBY, this entry type will still be deposited in the journal receiver. |
| F | MF | Physical file member saved with storage freed (SAVOBJ, SAVCHGOBJ, or SAVLIB) | These entries do not indicate that they occurred as the result of a trigger program, even if a trigger program caused the event. That information is not available at the time the entry is written to the journal. |
| F | MM | Physical file containing the member moved to a different library (MOVOBJ or RNMOBJ OBJTYPE(*LIB)) | Even if this journal has a journal state of *STANDBY, this entry type will still be deposited in the journal receiver. See the layout for the “Moving and renaming objects (D FM, D FN, E EM, E EN, F MM, F MN, F PM, F PN, J MJ, Q QM, Q QN) journal entries” on page 284. |
| F | MN | Physical file containing the member renamed (RNMM or RNMOBJ) | Even if this journal has a journal state of *STANDBY, this entry type will still be deposited in the journal receiver. See the layout for the “Moving and renaming objects (D FM, D FN, E EM, E EN, F MM, F MN, F PM, F PN, J MJ, Q QM, Q QN) journal entries” on page 284. |
| F | MO | Allow use with partial transactions | See the layout for the “Allow use with partial transactions (F MO) journal entry” on page 193. |
| F | MR | Physical file member restored (RSTOBJ or RSTLIB) | These entries do not indicate that they occurred as the result of a trigger program, even if a trigger program caused the event. That information is not available at the time the entry is written to the journal. |

| Journal code | Entry type | Description | Notes |
|--------------|------------|--|---|
| | | | See the layout for the “Object restored (B FR, D DZ, E EL, F MR, J RR, Q QZ, Y YZ) and receiver saved (J RS) journal entries” on page 289. |
| F | MS | Physical file member saved (SAVOBJ, SAVLIB, or SAVCHGOBJ) | These entries do not indicate that they occurred as the result of a trigger program, even if a trigger program caused the event. That information is not available at the time the entry is written to the journal. See the layout for the “Object saved (B FS, D DH, E ES, F MS, Q QY, Y YS) journal entries” on page 291. |
| F | OP | Physical file member opened (for shared files, an open entry is added for the first open operation for the file) | See the layout for the “Database file OPEN (F OP) and database file CLOSE (F CL) journal entries” on page 223. |
| F | PD | Database file member's access path deleted (this entry is created when you remove the member (RMVM) or delete the file (DLTF) containing the member) | Even if this journal has a journal state of *STANDBY, this entry type will still be deposited in the journal receiver. The object name for this entry might be misleading. It is the original name the path had when journaling started. The name is not updated if the access path is moved, renamed, or if it is implicitly shared by another logical file. See the layout for the “Delete access path (F PD) journal entry” on page 223. |
| F | PM | The logical owner of a journaled access path was moved (MOVOBJ or RNMOBJ OBJTYPE(*LIB)) | After you have installed V4R2M0 or a later release, this journal type is no longer generated. See the layout for the “Moving and renaming objects (D FM, D FN, E EM, E EN, F MM, F MN, F PM, F PN, J MJ, Q QM, Q QN) journal entries” on page 284. |
| F | PN | The logical owner of a journaled access path was renamed (RNMOBJ or RNMM) | After you have installed V4R2M0 or a later release, this journal type is no longer generated. See the layout for the “Moving and renaming objects (D FM, D FN, E EM, E EN, F MM, F MN, F PM, F PN, J MJ, Q QM, Q QN) journal entries” on page 284. |
| F | RC | Journaled changes removed from a physical file member (RMVJRNCHG) | See the layout for the “APYJRNCHG (B AT, D DD, E EQ, F AY, Q QH, Y YH) and RMVJRNCHG (E EX, F RC) journal entries” on page 194. |
| F | RG | Physical file member reorganized (RGZPFM) | See the layout for the “RGZPFM (F RG) journal entry” on page 294. |
| F | RM | Member reorganized | |

| Journal code | Entry type | Description | Notes |
|--------------|------------|--|--|
| F | SA | The point at which the APYJRNCHG command started running | |
| F | SR | The point at which the RMVJRNCHG command started running | |
| F | SS | The start of the save of a physical file member using the save-while-active function | These entries do not indicate that they occurred as the result of a trigger program, even if a trigger program caused the event. That information is not available at the time the entry is written to the journal. See the layout for the “Start of save-while-active (B FW, D DW, E EW, F SS, Q QX, Y YW) journal entries” on page 296. |
| I | DA | Directory in use at abnormal end | See the layout for the “IPL (J IA, J IN) and in-use (B OI, C BA, D ID, E EI, F IU, I DA, J JI, Q QI) journal entries” on page 253. |
| I | DK | Internal entry | |
| I | IB | Internal recovery | |
| I | IC | Access path protection | |
| I | IE | Directory recovery | |
| I | IF | Access path protection | |
| I | IG | Access path restored | |
| I | IH | Access path protection | |
| I | II | Access path in use at abnormal end | |
| I | IK | Access path protection | |
| I | IO | Access path protection | |
| I | IQ | Access path protection | |
| I | IV | Access path protection | |
| I | IW | Access path protection | |
| I | IX | Start of save for access path | |
| I | IY | Access path saved | |
| I | UE | Unknown entry type | |
| J | CI | Journal caching started | Even if this journal has a journal state of *STANDBY, this entry type will still be deposited in the journal receiver. |

| Journal code | Entry type | Description | Notes |
|--------------|------------|--|---|
| J | CX | Journal caching ended | Even if this journal has a journal state of *STANDBY, this entry type will still be deposited in the journal receiver. |
| J | EZ | End journaling for journal receiver | Even if this journal has a journal state of *STANDBY, this entry type will still be deposited in the journal receiver. |
| J | IA | System IPL after abnormal end | See the layout for the “IPL after abnormal end (J IA) journal entries” on page 251. |
| J | IN | System IPL after normal end | See the layout for the “IPL after normal end (J IN) journal entries” on page 251. |
| J | JI | Journal receiver in use at abnormal end | See the layout for the “IPL (J IA, J IN) and in-use (B OI, C BA, D ID, E EI, F IU, I DA, J JI, Q QI) journal entries” on page 253. |
| J | JQ | Journal quiesce ASP activity | Even if this journal has a journal state of *STANDBY, this entry type will still be deposited in the journal receiver. See the layout for the “Quiesce ASP activity (J JQ) journal entries” on page 251. |
| J | JR | Start journaling for journal receiver | Even if this journal has a journal state of *STANDBY, this entry type will still be deposited in the journal receiver. |
| J | KR | Keep journal receivers for recovery | |
| J | LA | Activate local journal | Even if this journal has a journal state of *STANDBY, this entry type will still be deposited in the journal receiver. |
| J | LI | Inactivate local journal | Even if this journal has a journal state of *STANDBY, this entry type will still be deposited in the journal receiver. |
| J | MJ | Journal receiver moved | Even if this journal has a journal state of *STANDBY, this entry type will still be deposited in the journal receiver. The entry-specific data for these journal entries is laid out in the QSYSINC include file, QWCJRNL.H. See the layout for the “Moving and renaming objects (D FM, D FN, E EM, E EN, F MM, F MN, F PM, F PN, J MJ, Q QM, Q QN) journal entries” on page 284. |
| J | NK | Do not keep journal receivers for recovery | |

| Journal code | Entry type | Description | Notes |
|--------------|------------|--|---|
| J | NR | Identifier for the next journal receiver (the receiver that was attached when the indicated receiver was detached) | Even if this journal has a journal state of *STANDBY, this entry type will still be deposited in the journal receiver. See the layout for the “ CHGJRN (J NR, J PR) journal entries ” on page 206. |
| J | PR | Identifier for the previous journal receiver (the receiver that was detached when the indicated receiver was attached) | Even if this journal has a journal state of *STANDBY, this entry type will still be deposited in the journal receiver. See the layout for the “ CHGJRN (J NR, J PR) journal entries ” on page 206. |
| J | RD | Deletion of a journal receiver (DLTJRNRCV) | Even if this journal has a journal state of *STANDBY, this entry type will still be deposited in the journal receiver. See the layout for the “ Delete receiver (J RD, J RF) journal entries ” on page 223. |
| J | RF | Storage for a journal receiver freed (SAVOBJ, SAVCHGOBJ, or SAVLIB) | See the layout for the “ Delete receiver (J RD, J RF) journal entries ” on page 223. |
| J | RR | Restore operation for a journal receiver (RSTOBJ or RSTLIB) | These entries do not indicate that they occurred as the result of a trigger program, even if a trigger program caused the event. That information is not available at the time the entry is written to the journal. See the layout for the “ Object restored (B FR, D DZ, E EL, F MR, J RR, Q QZ, Y YZ) and receiver saved (J RS) journal entries ” on page 289. |
| J | RS | Save operation for a journal receiver (SAVOBJ, SAVCHGOBJ, or SAVLIB) | These entries do not indicate that they occurred as the result of a trigger program, even if a trigger program caused the event. That information is not available at the time the entry is written to the journal. See the layout for the “ Object restored (B FR, D DZ, E EL, F MR, J RR, Q QZ, Y YZ) and receiver saved (J RS) journal entries ” on page 289. |
| J | SI | Enter journal state (*STANDBY) | Even if this journal has a journal state of *STANDBY, this entry type will still be deposited in the journal receiver. |
| J | SL | Severed link | Even if this journal has a journal state of *STANDBY, this entry type will still be deposited in the journal receiver. This is the start of the savepoint or nested commit cycle where it is written to the journal and occurs when the application creates an SQL SAVEPOINT. The system can also create an internal nested |

| Journal code | Entry type | Description | Notes |
|--------------|------------|--|--|
| | | | commit cycle to handle a series of database functions as a single operation. The entry-specific data for this journal entry is all internal data. |
| J | SX | Exit journal state (*STANDBY) | Even if this journal has a journal state of *STANDBY, this entry type will still be deposited in the journal receiver. |
| J | UA | User independent auxiliary storage pool vary on abnormal | See the layout for the “User IASP vary on abnormal (J UA) journal entries” on page 299. |
| J | UN | User independent auxiliary storage pool vary on normal | See the layout for the “User IASP vary on normal (J UN) journal entries” on page 300. |
| J | XP | Internal entry | Even if this journal has a journal state of *STANDBY, this entry type will still be deposited in the journal receiver. |
| J | ZA | Change authority for journal receiver | The entry-specific data for these journal entries is laid out in the QSYSINC include file, QSYJRN.L.H. See the layout for the “Change authority (E ZA, J ZA, Q ZA, Y ZA) journal entry” on page 196. |
| J | ZB | Change attribute for journal receiver | The entry-specific data for these journal entries is laid out in the QSYSINC include file, QSYJRN.L.H. See the layout for the “Change object attribute (E ZB, D ZB, J ZB, Q ZB, Y ZB) journal entry” on page 202. |
| J | ZO | Change owner for journal receiver | The entry-specific data for these journal entries is laid out in the QSYSINC include file, QSYJRN.L.H. See the layout for the “Ownership change (E ZO, J ZO, Q ZO, Y ZO) journal entries” on page 292. |
| J | ZP | Change primary group for journal receiver | The entry-specific data for these journal entries is laid out in the QSYSINC include file, QSYJRN.L.H. See the layout for the “Change primary group (E ZP, J ZP, Q ZP, Y ZP) journal entry” on page 203. |
| J | ZT | Change audit attribute for journal receiver | The entry-specific data for these journal entries is laid out in the QSYSINC include file, QSYJRN.L.H. See the layout for the “Auditing Change (E ZT, J ZT, Q ZT, Y ZT) journal entries” on page 196. |
| L | LK | License key is not valid | See the layout for the “License key not valid (L LK) journal entry” on page 255. |
| L | LL | Usage limit changed | See the layout for the “Usage limit changed (L LL) journal entry” on page 298. |

| Journal code | Entry type | Description | Notes |
|--------------|------------|---|---|
| L | LU | Usage limit exceeded | See the layout for the “Usage limit exceeded (L LU) journal entry” on page 299. |
| M | MP | Modification of QoS policies | |
| M | SN | Simple Network Management Protocol (SNMP) information | See Simple Network Management Protocol (SNMP) Support  for information about the entry specific data for SNMP journal entries. |
| M | TF | IP filter rules actions | See the layout for the “IP Packet Filter (M TF) journal entry” on page 253. |
| M | TN | IP NAT rules actions | See the layout for the “IP NAT rules actions (M TN) journal entry” on page 252. |
| M | TS | Virtual private networking (VPN) information | |
| P | TP | Performance shared pool change | See Work Management for the layout of the entry specific data. |
| Q | QA | Create data queue | The entry-specific data for these journal entries is laid out in the QSYSINC include file, QMHQJRN.L.H. See the layout for the “Create data queue (Q QA) journal entry” on page 217. |
| Q | QB | Start data queue journaling | Even if this journal has a journal state of *STANDBY, this entry type will still be deposited in the journal receiver. The entry-specific data for these journal entries is laid out in the QSYSINC include file, QMHQJRN.L.H. See the layout for the “Start journal (B JT, D JF, E EG, F JM, Q QB) journal entries” on page 297. |
| Q | QC | Data queue cleared, no key | See the layout for the “Database file OPEN (F OP) and database file CLOSE (F CL) journal entries” on page 223. |
| Q | QD | Data queue deleted | Even if this journal has a journal state of *STANDBY, this entry type will still be deposited in the journal receiver. There is no entry-specific data for this entry. |
| Q | QE | End data queue journaling | Even if this journal has a journal state of *STANDBY, this entry type will still be deposited in the journal receiver. There is no entry-specific data for this entry. |
| Q | QF | Change journal object attribute | The entry-specific data for these journal entries is laid out in the QSYSINC include file, QMHQJRN.L.H. |

| Journal code | Entry type | Description | Notes |
|--------------|------------|-----------------------------------|---|
| | | | See the layout for the “Change journaled object attributes (B JA, D DJ, E EK, F JC, Q QF, Y YK) journal entries” on page 201. |
| Q | QG | Data queue attributes changed | The entry-specific data for these journal entries is laid out in the QSYSINC include file, QMHQJRN.L.H. See the layout for the “Data queue attributes changed (Q QG) journal entry” on page 222. |
| Q | QH | Data queue changes applied | The entry-specific data for these journal entries is laid out in the QSYSINC include file, QMHQJRN.L.H. See the layout for the “APYJRNCHG (B AT, D DD, E EQ, F AY, Q QH, Y YH) and RMVJRNCHG (E EX, F RC) journal entries” on page 194. |
| Q | QI | Queue in use at abnormal end | There is no entry-specific data for this entry. |
| Q | QJ | Data queue cleared, has key | The entry-specific data for these journal entries is laid out in the QSYSINC include file, QMHQJRN.L.H. See the layout for the “Data queue cleared, has key (Q QJ) journal entry” on page 222. |
| Q | QK | Send data queue entry, has key | This journal entry may have data which can only be accessed by using either the QjoRetrieveJournalEntries API or the RCVJRNE command. For the RCVJRNE command, use the ENTFMT(*TYPEPTR) or ENTFMT(*JRNENTFMT) parameters. In all other interfaces, if the data is not visible, the incomplete data indicator will be on and *POINTER will appear in the Entry Specific Data. For more information, refer to “Working with pointers in journal entries” on page 313. The entry-specific data for these journal entries is laid out in the QSYSINC include file, QMHQJRN.L.H. See the layout for the “Send data queue, has key (Q QK) journal entry” on page 294. |
| Q | QL | Receive data queue entry, has key | The entry-specific data for these journal entries is laid out in the QSYSINC include file, QMHQJRN.L.H. See the layout for the “Received data queue, has key (Q QL) journal entry” on page 293. |
| Q | QM | Data queue moved | Even if this journal has a journal state of *STANDBY, this entry type will still be deposited in the journal receiver. The entry-specific data for these journal entries is laid out in the QSYSINC include file, QMHQJRN.L.H. See the layout for the “Moving and renaming objects (D FM, D FN, E EM, E EN, F MM, F MN, F |

| Journal code | Entry type | Description | Notes |
|--------------|------------|---|--|
| | | | PM, F PN, J MJ, Q QM, Q QN) journal entries” on page 284 . |
| Q | QN | Data queue renamed | <p>Even if this journal has a journal state of *STANDBY, this entry type will still be deposited in the journal receiver.</p> <p>The entry-specific data for these journal entries is laid out in the QSYSINC include file, QMHQJRN.L.H.</p> <p>See the layout for the “Moving and renaming objects (D FM, D FN, E EM, E EN, F MM, F MN, F PM, F PN, J MJ, Q QM, Q QN) journal entries” on page 284.</p> |
| Q | QR | Receive data queue entry, no key | This entry only has entry-specific data which the system uses for internal processing. There is no structure for it in the QSYSINC include file, QMHQJRN.L.H. |
| Q | QS | Send data queue entry, no key | <p>This journal entry may have data which can only be accessed by using either the QjoRetrieveJournalEntries API or the RCVJRNE command. For the RCVJRNE command, use the ENTFFMT(*TYPEPTR) or ENTFFMT(*JRNENTFFMT) parameters. In all other interfaces, if the data is not visible, the incomplete data indicator will be on and *POINTER will appear in the Entry Specific Data. For more information, refer to “Working with pointers in journal entries” on page 313.</p> <p>The entry-specific data for these journal entries is laid out in the QSYSINC include file, QMHQJRN.L.H.</p> <p>See the layout for the “Send data queue, no key (Q QS) journal entry” on page 295.</p> |
| Q | QW | Apply journaled changes (APYJRNCHG) command started | The entry specific data for this entry varies, and only represents data required internally by the operation system. Therefore, the entry layout is not documented. |
| Q | QX | Start of save for data queue | <p>These entries do not indicate that they occurred as the result of a trigger program, even if a trigger program caused the event. That information is not available at the time the entry is written to the journal.</p> <p>The entry-specific data for these journal entries is laid out in the QSYSINC include file, QMHQJRN.L.H.</p> <p>See the layout for the “Start of save-while-active (B FW, D DW, E EW, F SS, Q QX, Y YW) journal entries” on page 296.</p> |
| Q | QY | Data queue saved | These entries do not indicate that they occurred as the result of a trigger program, even if a trigger |

| Journal code | Entry type | Description | Notes |
|--------------|------------|-------------------------|---|
| | | | <p>program caused the event. That information is not available at the time the entry is written to the journal.</p> <p>The entry-specific data for these journal entries is laid out in the QSYSINC include file, QMHQJRN.L.H.</p> <p>See the layout for the “Object saved (B FS, D DH, E ES, F MS, Q QY, Y YS) journal entries” on page 291.</p> |
| Q | QZ | Data queue restored | <p>These entries do not indicate that they occurred as the result of a trigger program, even if a trigger program caused the event. That information is not available at the time the entry is written to the journal.</p> <p>The entry-specific data for these journal entries is laid out in the QSYSINC include file, QMHQJRN.L.H.</p> <p>See the layout for the “Object restored (B FR, D DZ, E EL, F MR, J RR, Q QZ, Y YZ) and receiver saved (J RS) journal entries” on page 289.</p> |
| Q | VE | Internal entry | This is an internal entry. No layout of entry-specific data is provided. |
| Q | VQ | Internal entry | This is an internal entry. No layout of entry-specific data is provided. |
| Q | VW | Internal entry | This is an internal entry. No layout of entry-specific data is provided. |
| Q | ZA | Change authority | <p>The entry-specific data for these journal entries is laid out in the QSYSINC include file, QSYJRN.L.H.</p> <p>See the layout for the “Change authority (E ZA, J ZA, Q ZA, Y ZA) journal entry” on page 196.</p> |
| Q | ZB | Change object attribute | <p>The entry-specific data for these journal entries is laid out in the QSYSINC include file, QLIJRN.L.H.</p> <p>See the layout for the “Change object attribute (E ZB, D ZB, J ZB, Q ZB, Y ZB) journal entry” on page 202.</p> |
| Q | ZO | Ownership change | <p>The entry-specific data for these journal entries is laid out in the QSYSINC include file, QSYJRN.L.H.</p> <p>See the layout for the “Ownership change (E ZO, J ZO, Q ZO, Y ZO) journal entries” on page 292.</p> |
| Q | ZP | Change primary group | <p>The entry-specific data for these journal entries is laid out in the QSYSINC include file, QSYJRN.L.H.</p> <p>See the layout for the “Change primary group (E ZP, J ZP, Q ZP, Y ZP) journal entry” on page 203.</p> |
| Q | ZT | Auditing change | The entry-specific data for these journal entries is laid out in the QSYSINC include file, QLIJRN.L.H. |

| Journal code | Entry type | Description | Notes |
|--------------|------------|--|---|
| | | | See the layout for the “ Auditing Change (E ZT, J ZT, Q ZT, Y ZT) journal entries ” on page 196. |
| R | BR | Before-image of record updated for rollback operation | <p>This journal entry may have data which can only be accessed by using either the QjoRetrieveJournalEntries API or the RCVJRNE command. For the RCVJRNE command, use the ENTFMT(*TYPEPTR) or ENTFMT(*JRNENTFMT) parameters. In all other interfaces, if the data is not visible, the incomplete data indicator will be on and *POINTER will appear in the Entry Specific Data. For more information, refer to Work with pointers in journal entries.</p> <p>This entry may have minimized entry specific data (ESD). It will have minimized ESD if its corresponding object type deposits minimized journal entries through the MINENTDTA parameter for this journal or journal receiver.</p> <p>See the layout for the “Journal code R, all journal entry types except IL” on page 254.</p> |
| R | DL | Record deleted in the physical file member | <p>This journal entry may have data which can only be accessed by using either the QjoRetrieveJournalEntries API or the RCVJRNE command. For the RCVJRNE command, use the ENTFMT(*TYPEPTR) or ENTFMT(*JRNENTFMT) parameters. In all other interfaces, if the data is not visible, the incomplete data indicator will be on and *POINTER will appear in the Entry Specific Data. For more information, refer to “Working with pointers in journal entries” on page 313</p> <p>See the layout for the “Journal code R, all journal entry types except IL” on page 254.</p> |
| R | DR | Record deleted for rollback operation | <p>This journal entry may have data which can only be accessed by using either the QjoRetrieveJournalEntries API or the RCVJRNE command. For the RCVJRNE command, use the ENTFMT(*TYPEPTR) or ENTFMT(*JRNENTFMT) parameters. In all other interfaces, if the data is not visible, the incomplete data indicator will be on and *POINTER will appear in the Entry Specific Data. For more information, refer to “Working with pointers in journal entries” on page 313.</p> <p>See the layout for the “Journal code R, all journal entry types except IL” on page 254.</p> |
| R | IL | Increment record limit | These entries have entry-specific data which the system uses for internal processing. |
| R | PT | Record added to a physical file member. If the file is set up to reuse | This journal entry may have data which can only be accessed by using either the QjoRetrieveJournalEntries API or the RCVJRNE |

| Journal code | Entry type | Description | Notes |
|--------------|------------|--|---|
| | | deleted records, then you may receive either a PT or PX journal entry for the change | <p>command. For the RCVJRNE command, use the ENTFFMT(*TYPEPTR) or ENTFFMT(*JRNENTFFMT) parameters. In all other interfaces, if the data is not visible, the incomplete data indicator will be on and *POINTER will appear in the Entry Specific Data. For more information, refer to “Working with pointers in journal entries” on page 313.</p> <p>See the layout for the “Journal code R, all journal entry types except IL” on page 254.</p> |
| R | PX | Record added directly by RRN (relative record number) to a physical file member. If the file is set up to reuse deleted records, then you may receive either a PT or PX journal entry for the change | <p>This journal entry may have data which can only be accessed by using either the QjoRetrieveJournalEntries API or the RCVJRNE command. For the RCVJRNE command, use the ENTFFMT(*TYPEPTR) or ENTFFMT(*JRNENTFFMT) parameters. In all other interfaces, if the data is not visible, the incomplete data indicator will be on and *POINTER will appear in the Entry Specific Data. For more information, refer to “Working with pointers in journal entries” on page 313.</p> <p>This entry may have minimized entry specific data (ESD). It will have minimized ESD if its corresponding object type deposits minimized journal entries through the MINENTDTA parameter for this journal or journal receiver.</p> <p>See the layout for the “Journal code R, all journal entry types except IL” on page 254.</p> |
| R | UB | Before-image of a record that is updated in the physical file member (this entry is present only if IMAGES(*BOTH) is specified on the STRJRNPf command) | <p>Neither the before-image nor after-image is deposited into the journal if the after-image is exactly the same as the before-image.</p> <p>This journal entry may have data which can only be accessed by using either the QjoRetrieveJournalEntries API or the RCVJRNE command. For the RCVJRNE command, use the ENTFFMT(*TYPEPTR) or ENTFFMT(*JRNENTFFMT) parameters. In all other interfaces, if the data is not visible, the incomplete data indicator will be on and *POINTER will appear in the Entry Specific Data. For more information, refer to “Working with pointers in journal entries” on page 313.</p> <p>This entry may have minimized entry specific data (ESD). It will have minimized ESD if its corresponding object type deposits minimized journal entries through the MINENTDTA parameter for this journal or journal receiver.</p> <p>See the layout for the “Journal code R, all journal entry types except IL” on page 254.</p> |
| R | UP | After-image of a record that is updated in the physical file member | <p>Neither the before-image nor after-image is deposited into the journal if the after-image is exactly the same as the before-image.</p> |

| Journal code | Entry type | Description | Notes |
|--------------|------------|--|--|
| | | | <p>This journal entry may have data which can only be accessed by using either the QjoRetrieveJournalEntries API or the RCVJRNE command. For the RCVJRNE command, use the ENTFFMT(*TYPEPTR) or ENTFFMT(*JRNENTFFMT) parameters. In all other interfaces, if the data is not visible, the incomplete data indicator will be on and *POINTER will appear in the Entry Specific Data. For more information, refer to “Working with pointers in journal entries” on page 313.</p> <p>This entry may have minimized entry specific data (ESD). It will have minimized ESD if its corresponding object type deposits minimized journal entries through the MINENTDTA parameter for this journal or journal receiver.</p> <p>See the layout for the “Journal code R, all journal entry types except IL” on page 254.</p> |
| R | UR | After-image of a record that is updated for rollback information | <p>This journal entry may have data which can only be accessed by using either the QjoRetrieveJournalEntries API or the RCVJRNE command. For the RCVJRNE command, use the ENTFFMT(*TYPEPTR) or ENTFFMT(*JRNENTFFMT) parameters. In all other interfaces, if the data is not visible, the incomplete data indicator will be on and *POINTER will appear in the Entry Specific Data. For more information, refer to “Working with pointers in journal entries” on page 313 .</p> <p>This entry may have minimized entry specific data (ESD). It will have minimized ESD if its corresponding object type deposits minimized journal entries through the MINENTDTA parameter for this journal or journal receiver.</p> <p>See the layout for the “Journal code R, all journal entry types except IL” on page 254.</p> |
| S | AL | SNA alert focal point information | |
| S | CF | Mail configuration information | See the layout for the “Change distribution queues (S CF) journal entry” on page 198. |
| S | DX | X.400 process debug entry | |
| S | ER | Mail error information | See the layout for the “Distribution errors (S ER) journal entry” on page 224. |
| S | LG | Mail logging table information | See the layout for the “Completed distributions (S LG) journal entry” on page 207. |
| S | MX | A change was made to X.400 MTA configuration | |

| Journal code | Entry type | Description | Notes |
|--------------|------------|--|---|
| S | NX | A change was made to X.400 delivery notification | |
| S | RT | Mail routing information | See the layout for the “Change routing table and secondary system name table (S RT) journal entries” on page 204. |
| S | RX | A change was made to X.400 route configuration | |
| S | SY | Mail system information | See the layout for the “Mail server framework system level events (S SY) journal entry” on page 283. |
| S | UX | A change was made to X.400 ^(R) user or probe | |
| S | XE | DSNX error entry | See the layout for the “Distribution errors (S XE) journal entries” on page 232. |
| S | XL | DSNX logging entry | See the layout for the “DSNX log (S XL) journal entries” on page 233. |
| S | XX | An error was detected by the X.400 process | |
| T | AD | A change was made to the auditing attribute | See the layout for the Security Reference: Layout of audit journal entries. |
| T | AF | All authority failures | See the layout for the Security Reference: Layout of audit journal entries. |
| T | AP | A change was made to program adopt | See the layout for the Security Reference: Layout of audit journal entries. |
| T | AU | Attribute change | See the layout for the Security Reference: Layout of audit journal entries. |
| T | AX | Row and column access control | See the layout for the Security Reference: Layout of audit journal entries. |
| T | CA | Changes to object authority (authorization list or object) | See the layout for the Security Reference: Layout of audit journal entries. |
| T | CD | A change was made to a command string | See the layout for the Security Reference: Layout of audit journal entries. |
| T | CO | Create object | See the layout for the Security Reference: Layout of audit journal entries. |
| T | CP | Create, change, restore user profiles | See the layout for the Security Reference: Layout of audit journal entries. |

| Journal code | Entry type | Description | Notes |
|--------------|------------|--|---|
| T | CQ | A change was made to a change request descriptor | See the layout for the Security Reference: Layout of audit journal entries. |
| T | CU | Cluster operation | See the layout for the Security Reference: Layout of audit journal entries. |
| T | CV | Connection verification | See the layout for the Security Reference: Layout of audit journal entries. |
| T | CY | Cryptographic configuration | See the layout for the Security Reference: Layout of audit journal entries. |
| T | DI | Directory services | See the layout for the Security Reference: Layout of audit journal entries. |
| T | DO | All delete operations on the system | See the layout for the Security Reference: Layout of audit journal entries. |
| T | DS | DST security officer password reset | See the layout for the Security Reference: Layout of audit journal entries. |
| T | EV | Environment variable | See the layout for the Security Reference: Layout of audit journal entries. |
| T | GR | General purpose audit record | See the layout for the Security Reference: Layout of audit journal entries. |
| T | GS | A descriptor was given | See the layout for the Security Reference: Layout of audit journal entries. |
| T | IM | Intrusion monitor | See the layout for the Security Reference: Layout of audit journal entries. |
| T | IP | Inter-process communication event | See the layout for the Security Reference: Layout of audit journal entries. |
| T | IR | IP rules actions | See the layout for the Security Reference: Layout of audit journal entries. |
| T | IS | Internet security management | See the layout for the Security Reference: Layout of audit journal entries. |
| T | JD | Changes to the USER parameter of a job description | See the layout for the Security Reference: Layout of audit journal entries. |
| T | JS | A change was made to job data | See the layout for the Security Reference: Layout of audit journal entries. |
| T | KF | Key ring file name | See the layout for the Security Reference: Layout of audit journal entries. |

| Journal code | Entry type | Description | Notes |
|--------------|------------|--|--|
| T | LD | A link, unlink, or lookup operation to a directory | See the layout for the Security Reference: Layout of audit journal entries . |
| T | ML | A change was made to office services mail | See the layout for the Security Reference: Layout of audit journal entries . |
| T | NA | Changes to network attributes | See the layout for the Security Reference: Layout of audit journal entries . |
| T | ND | Directory search violations | See the layout for the Security Reference: Layout of audit journal entries . |
| T | NE | End point violations | See the layout for the Security Reference: Layout of audit journal entries . |
| T | OM | Object management change | See the layout for the Security Reference: Layout of audit journal entries . |
| T | OR | Object restored | See the layout for the Security Reference: Layout of audit journal entries . |
| T | OW | Changes to object ownership | See the layout for the Security Reference: Layout of audit journal entries . |
| T | O1 | Single optical object access | See the layout for the Security Reference: Layout of audit journal entries . |
| T | O2 | Dual optical object access | See the layout for the Security Reference: Layout of audit journal entries . |
| T | O3 | Optical volume access | See the layout for the Security Reference: Layout of audit journal entries . |
| T | PA | Changes to programs (CHGPGM) that will now adopt the owner's authority | See the layout for the Security Reference: Layout of audit journal entries . |
| T | PF | PTF operations | See the layout for the Security Reference: Layout of audit journal entries . |
| T | PG | Changes to an object's primary group | See the layout for the Security Reference: Layout of audit journal entries . |
| T | PO | A change was made to printed output | See the layout for the Security Reference: Layout of audit journal entries . |
| T | PS | Profile swap | See the layout for the Security Reference: Layout of audit journal entries . |
| T | PU | PTF object changes | See the layout for the Security Reference: Layout of audit journal entries . |

| Journal code | Entry type | Description | Notes |
|--------------|------------|--|---|
| T | PW | Passwords used that are not valid | See the layout for the Security Reference: Layout of audit journal entries. |
| T | RA | Restore of objects when authority changes | See the layout for the Security Reference: Layout of audit journal entries. |
| T | RJ | Restore of job descriptions that contain user profile names | See the layout for the Security Reference: Layout of audit journal entries. |
| T | RO | Restore of objects when ownership information changes | See the layout for the Security Reference: Layout of audit journal entries. |
| T | RP | Restore of programs that adopt their owner's authority | See the layout for the Security Reference: Layout of audit journal entries. |
| T | RQ | A change request descriptor was restored | See the layout for the Security Reference: Layout of audit journal entries. |
| T | RU | Restore of authority for user profiles | See the layout for the Security Reference: Layout of audit journal entries. |
| T | RZ | The primary group for an object was changed during a restore operation | See the layout for the Security Reference: Layout of audit journal entries. |
| T | SD | A change was made to the system directory | See the layout for the Security Reference: Layout of audit journal entries. |
| T | SE | Changes to subsystem routing | See the layout for the Security Reference: Layout of audit journal entries. |
| T | SF | A change was made to a spooled output file | See the layout for the Security Reference: Layout of audit journal entries. |
| T | SG | Asynchronous signals | See the layout for the Security Reference: Layout of audit journal entries. |
| T | SK | Secure sockets connection | See the layout for the Security Reference: Layout of audit journal entries. |
| T | SM | A change was made by system management | See the layout for the Security Reference: Layout of audit journal entries. |
| T | SO | A change was made by server security | See the layout for the Security Reference: Layout of audit journal entries. |
| T | ST | A change was made by system tools | See the layout for the Security Reference: Layout of audit journal entries. |
| T | SV | Changes to system values | See the layout for the Security Reference: Layout of audit journal entries. |

| Journal code | Entry type | Description | Notes |
|---------------------|-------------------|--|---|
| T | VA | Changes to access control list | See the layout for the Security Reference: Layout of audit journal entries. |
| T | VC | Connection started or ended | See the layout for the Security Reference: Layout of audit journal entries. |
| T | VF | Server files were closed | See the layout for the Security Reference: Layout of audit journal entries. |
| T | VL | An account limit was exceeded | See the layout for the Security Reference: Layout of audit journal entries. |
| T | VN | A logon or logoff operation on the network | See the layout for the Security Reference: Layout of audit journal entries. |
| T | VO | Actions on validation lists | See the layout for the Security Reference: Layout of audit journal entries. |
| T | VP | A network password error | See the layout for the Security Reference: Layout of audit journal entries. |
| T | VR | A network resources was accessed | See the layout for the Security Reference: Layout of audit journal entries. |
| T | VS | A server session started or ended | See the layout for the Security Reference: Layout of audit journal entries. |
| T | VU | A network profile was changed | See the layout for the Security Reference: Layout of audit journal entries. |
| T | VV | Service status was changed | See the layout for the Security Reference: Layout of audit journal entries. |
| T | XD | Extension of the directory services entry | See the layout for the Security Reference: Layout of audit journal entries. |
| T | X0 | Network authentication | See the layout for the Security Reference: Layout of audit journal entries. |
| T | X1 | Identity token | See the layout for the Security Reference: Layout of audit journal entries. |
| T | X2 | Query manager profile changes | See the layout for the Security Reference: Layout of audit journal entries. |
| T | X3 | Reserved for future audit entry | See the layout for the Security Reference: Layout of audit journal entries. |
| T | X4 | Reserved for future audit entry | See the layout for the Security Reference: Layout of audit journal entries. |

| Journal code | Entry type | Description | Notes |
|--------------|------------|---|---|
| T | X5 | Reserved for future audit entry | See the layout for the Security Reference: Layout of audit journal entries . |
| T | X6 | Reserved for future audit entry | See the layout for the Security Reference: Layout of audit journal entries . |
| T | X7 | Reserved for future audit entry | See the layout for the Security Reference: Layout of audit journal entries . |
| T | X8 | Reserved for future audit entry | See the layout for the Security Reference: Layout of audit journal entries . |
| T | X9 | Reserved for future audit entry | See the layout for the Security Reference: Layout of audit journal entries . |
| T | YC | A change was made to DLO change access | See the layout for the Security Reference: Layout of audit journal entries . |
| T | YR | A change was made to DLO read access | See the layout for the Security Reference: Layout of audit journal entries . |
| T | ZC | A change was made to object change access | See the layout for the Security Reference: Layout of audit journal entries . |
| T | ZR | A change was made to object read access | See the layout for the Security Reference: Layout of audit journal entries . |
| U | | User-specified. The Entry-specific data is the value specified on the ENTDTA parameter of the SNDJRNE command or with the entry data parameter for the QJOSJRNE API | Even if this journal has a journal state of *STANDBY, this entry type will still be deposited in the journal receiver. |
| Y | LF | Logical file associated with the library | The entry-specific data for these journal entries is laid out in the QSYSINC include file, QLIJRN.L.H. See the layout for the “Logical file associated with the library or based on physical file (D LF, Y LF) journal entry” on page 255. |
| Y | YA | Change library attributes | The entry-specific data for these journal entries is laid out in the QSYSINC include file, QLIJRN.L.H. See the layout for the “Change library attributes (Y YA) journal entry” on page 202. |
| Y | YB | Journaling for library started | Even if this journal has a journal state of *STANDBY, this entry type will still be deposited in the journal receiver. The entry-specific data for these journal entries is laid out in the QSYSINC include file, QLIJRN.L.H. |

| Journal code | Entry type | Description | Notes |
|--------------|------------|-----------------------------------|--|
| | | | See the layout for the “Journaling for library started (Y YB) journal entry” on page 254. |
| Y | YD | Library deleted | Even if this journal has a journal state of *STANDBY, this entry type will still be deposited in the journal receiver. There is no entry-specific data for this entry. |
| Y | YE | Journaling for library ended | Even if this journal has a journal state of *STANDBY, this entry type will still be deposited in the journal receiver. There is no entry-specific data for this entry. |
| Y | YH | Library changes applied | The entry-specific data for these journal entries is laid out in the QSYSINC include file, QLIJRN.L.H. See the layout for the “APYJRNCHG (B AT, D DD, E EQ, F AY, Q QH, Y YH) and RMVJRNCHG (E EX, F RC) journal entries” on page 194. |
| Y | YI | Library in use at abnormal end | There is no entry-specific data for this entry. |
| Y | YK | Change journaled object attribute | The entry-specific data for these journal entries is laid out in the QSYSINC include file, QLIJRN.L.H. See the layout for the “Change journaled object attributes (B JA, D DJ, E EK, F JC, Q QF, Y YK) journal entries” on page 201. |
| Y | YN | Library renamed | Even if this journal has a journal state of *STANDBY, this entry type will still be deposited in the journal receiver. The entry-specific data for these journal entries is laid out in the QSYSINC include file, QLIJRN.L.H. See the layout for the “Library renamed (Y YN) journal entry” on page 255. |
| Y | YO | Object added to library | The entry-specific data for these journal entries is laid out in the QSYSINC include file, QLIJRN.L.H. See the layout for the “Object added to library (Y YO) journal entry” on page 285. |
| Y | YS | Library saved | These entries do not indicate that they occurred as the result of a trigger program, even if a trigger program caused the event. That information is not available at the time the entry is written to the journal. The entry-specific data for these journal entries is laid out in the QSYSINC include file, QLIJRN.L.H. |

| Journal code | Entry type | Description | Notes |
|--------------|------------|---------------------------|--|
| | | | See the layout for the “Object saved (B FS, D DH, E ES, F MS, Q QY, Y YS) journal entries” on page 291. |
| Y | YW | Start of save for library | <p>These entries do not indicate that they occurred as the result of a trigger program, even if a trigger program caused the event. That information is not available at the time the entry is written to the journal.</p> <p>The entry-specific data for these journal entries is laid out in the QSYSINC include file, QLIJRN.L.H.</p> <p>See the layout for the “Start of save-while-active (B FW, D DW, E EW, F SS, Q QX, Y YW) journal entries” on page 296.</p> |
| Y | YY | Apyjrnchg command started | |
| Y | YZ | Library restored | <p>These entries do not indicate that they occurred as the result of a trigger program, even if a trigger program caused the event. That information is not available at the time the entry is written to the journal.</p> <p>The entry-specific data for these journal entries is laid out in the QSYSINC include file, QLIJRN.L.H.</p> <p>See the layout for the “Object restored (B FR, D DZ, E EL, F MR, J RR, Q QZ, Y YZ) and receiver saved (J RS) journal entries” on page 289.</p> |
| Y | ZA | Change authority | <p>The entry-specific data for these journal entries is laid out in the QSYSINC include file, QSYJRN.L.H.</p> <p>See the layout for the “Object restored (B FR, D DZ, E EL, F MR, J RR, Q QZ, Y YZ) and receiver saved (J RS) journal entries” on page 289.</p> |
| Y | ZB | Object attribute change | <p>The entry-specific data for these journal entries is laid out in the QSYSINC include file, QLIJRN.L.H.</p> <p>See the layout for the “Change object attribute (E ZB, D ZB, J ZB, Q ZB, Y ZB) journal entry” on page 202.</p> |
| Y | ZO | Change owner | <p>The entry-specific data for these journal entries is laid out in the QSYSINC include file, QSYJRN.L.H.</p> <p>See the layout for the “Ownership change (E ZO, J ZO, Q ZO, Y ZO) journal entries” on page 292.</p> |
| Y | ZP | Change primary group | <p>The entry-specific data for these journal entries is laid out in the QSYSINC include file, QSYJRN.L.H.</p> <p>See the layout for the “Change primary group (E ZP, J ZP, Q ZP, Y ZP) journal entry” on page 203.</p> |

| Journal code | Entry type | Description | Notes |
|--------------|------------|------------------------|---|
| Y | ZT | Change audit attribute | The entry-specific data for these journal entries is laid out in the QSYSINC include file, QSYJRNL.H. See the layout for the “Auditing Change (E ZT, J ZT, Q ZT, Y ZT) journal entries” on page 196. |

Fixed-length portion of the journal entry

This topic provides the layouts of the fixed-length portion of the journal entries.

When you use the Display Journal (DSPJRN) command, Receive Journal Entry (RCVJRNE) command, Retrieve Journal Entry (RTVJRNE) command, or the Retrieve Journal Entries (QjoRetrieveJournalEntries) API you can select one of the formats in which to receive the layout for the fixed-length portion of the journal entry:

- *TYPE1
- *TYPE2
- *TYPE3
- *TYPE4
- *TYPE5

*TYPE1 format

The *TYPE1 format shows the fields that are common for all journal entry types. These fields are shown when you request *TYPE1 for the output file format or the entry type format.

*TYPE2 format

If you request OUTFILFMT(*TYPE2) on the DSPJRN command, or ENTFMT(*TYPE2) on the RCVJRNE or RTVJRNE command, then the fixed-length portion of each converted journal entry is the same as the format in *TYPE1, except for the information that follows the commit cycle identifier field. The fields of the prefix that follow the commit cycle identifier are shown in *TYPE2 field descriptions.

TYPE3 field descriptions

A third value, *TYPE3, is supported on the OUTFILFMT parameter for the DSPJRN command, and the ENTFMT parameter for the RCVJRNE and RTVJRNE commands. If either OUTFILFMT(*TYPE3) is specified on the DSPJRN command or ENTFMT(*TYPE3) is specified on the RCVJRNE or RTVJRNE command, the information in the prefix portion of a converted journal entry is shown in *TYPE3 field descriptions. *TYPE3 has the same information as the *TYPE1 and *TYPE2 formats, except that it has a different date format and a null-values indicator.

*TYPE4 field descriptions

A fourth value, *TYPE4, is supported on the OUTFILFMT parameter for the DSPJRN command and the ENTFMT parameter for the RCVJRNE and RTVJRNE commands. If either OUTFILFMT(*TYPE4) is specified on the DSPJRN command or ENTFMT(*TYPE4) is specified on the RCVJRNE or RTVJRNE command, the information in the prefix portion of a converted journal entry is shown in Table 4. *TYPE4 output includes all of the *TYPE3 information, plus information about journal identifiers, triggers, and referential constraints and entries which will be ignored by the APYJRNCHG or RMVJRNCHG commands.

*TYPE5 field descriptions

The *TYPE5 format is only available with the DSPJRN and RTVJRNE commands. The *TYPE5 format is supported on the OUTFILFMT parameter for the DSPJRN command and ENTFMT parameter of the RTVJRNE command. If you specify OUTFILFMT(*TYPE5) on the DSPJRN command or ENTFMT(*TYPE5) on the RTVJRNE command, the information in the prefix portion of a converted journal entry is shown in Table 5. *TYPE5 output includes all of the *TYPE4 information, plus information about the following:

- System sequence number
- Thread identifier

- Remote address
- Address family
- Remote port
- Arm number
- Receiver name
- Receiver library name
- Receiver library ASP device name
- Program library name
- Program library ASP device name
- Program library ASP number
- Logical unit of work
- Transaction identifier
- Receiver library ASP number
- Object type
- File type
- Nested commit level

The RCVJRNE command also supports the *TYPEPTR and *JRNENTFMT formats. The layout of the journal entry data for the *TYPEPTR interface is the same as the RJNE0100 format which is described in the QjoRetrieveJournalEntries API.

The layout of the journal entry data for the *JRNENTFMT interface is the same as either the RJNE0100 format or the RJNE0200 format of the QjoRetrieveJournalEntries API. You can select which format to use by selecting the RJNE0100 or the RJNE0200 value for the Journal Entry Format (JRNENTFMT) parameter of the RCVJRNE command.

You can find the field descriptions for layouts *TYPE1, *TYPE2, *TYPE3, *TYPE4, and *TYPE5 in the Journal entry information finder.

Related reference

[Retrieve Journal Entries \(QjoRetrieveJournalEntries\) API](#)

Related information

[Journal entry information finder](#)

Layouts for the fixed-length portion of journal entries

Use this topic to determine layouts for the fixed-length portion of journal entries.

TYPE1 field descriptions of the fixed-length portion of a journal entry

These fields are shown when you request *TYPE1 for the output file format or the entry type format. The uppercase field names shown in parentheses are used in the system-supplied output file QSYS/QADSPJRN. The field names that are in italics are the variable names for these fields in the QjoRetrieveJournalEntries API header file. These variables are under the type definition for the RJNE0100 format. The QjoRetrieveJournalEntries API header is in the QJOURNAL.H file of the QSYSINC library.

| Relative offset | Field | Format | Description |
|-----------------|--|--------------|--|
| 1 | Entry length (JOENTL) | Zoned (5,0) | <p>Specifies the length of the journal entry including the entry length field, all subsequent positions of the journal entry, and any portion of the journal entry that was truncated if the length of the output record is less than the length of the record created for the journal entry.</p> <p>If the journal entry has the incomplete data indicator on, then this length does not include that additional data which could be pointed to. This length includes the length of the data that is actually returned, which includes entry specific data of up to 32 766 bytes.</p> |
| 6 | Sequence number (JOSEQN, <i>Seq_Number</i>) | Zoned (10,0) | <p>Assigned by the system to each journal entry. It is initially set to 1 for each new or restored journal and is incremented until you request that it be reset when you attach a new receiver. There are occasional gaps in the sequence numbers because the system uses internal journal entries for control purposes. These gaps occur if you use commitment control, journal physical files, or journal access paths.</p> <p>This field can contain a -1 if receiver-size option RCVSIZOPT(*MAXOPT3) is selected and the actual value of the sequence number is larger than 9 999 999 999.</p> |
| 16 | Journal code (JOCODE, <i>Jrn_Code</i>) | Char (1) | <p>Identifies the primary category of the journal entry:</p> <ul style="list-style-type: none"> A = System accounting entry B = Integrated file system operation C = Commitment control operation D = Database file operation E = Data area operation F = Database file member operation I = Internal operation J = Journal or receiver operation L = License management M = Network management data P = Performance tuning entry Q = Data queue operation R = Operation on a specific record S = Distributed mail services T = Audit trail entry U = User-generated entry (added by the SNDJRNE command or QJOSJRNE API) <p>The journal codes are described in more detail in Journal code descriptions.</p> |

| Relative offset | Field | Format | Description |
|-----------------|---|-------------|---|
| 17 | Entry type (JOENTT, <i>Entry_Type</i>) | Char (2) | Further identifies the type of user-created or system-created entry. See the Journal code finder for descriptions of the entry types. |
| 19 | Date stamp (JODATE) | Char (6) | Specifies the system date when the entry was added and is in the format of the job attribute DATFMT. The system cannot assure that the date stamp is always in ascending order for sequential journal entries because you can change the value of the system date. |
| 25 | Time stamp (JOTIME) | Zoned (6,0) | Corresponds to the system time (in the format hhmmss) when the entry was added. The system cannot assure that the time stamp is always in ascending order for sequential journal entries because you can change the value of the system time. |
| 31 | Job name (JOJOB, <i>Job_Name</i>) | Char (10) | Specifies the name of the job that added the entry. Notes: 1. If a RCVSIZOPT or a FIXLENDTA option was specified that omitted the collection of this information, then *OMITTED is given for the job name. 2. If the job name was not available when the journal entry was deposited, then *NONE is written for the job name. |
| 41 | User name (Jouser, <i>User_Name</i>) | Char (10) | Specifies the user profile name of the user that started the job. Note: If a RCVSIZOPT or a FIXLENDTA option was specified that omitted the collection of this information, then blanks are written for the user name. |
| 51 | Job number (JONBR, <i>Job_Number</i>) | Zoned (6,0) | Specifies the job number of the user that started the job. Note: If a RCVSIZOPT or a FIXLENDTA option was specified that omitted the collection of this information, then zeroes are written for the job number. |

| Relative offset | Field | Format | Description |
|-----------------|--|-----------|---|
| 57 | Program name (JOPGM, <i>Program_Name</i>) | Char (10) | <p>Specifies the name of the program that added the entry. If an application or CL program did not add the entry, the field contains the name of a system-supplied program such as QCMD or QPGMMENU. If the program name is the special value *NONE, then one of the following is true:</p> <ul style="list-style-type: none"> • The program name does not apply to this journal entry. • The program name was not available when the journal entry was made. <p>For example, the program name is not available if the program was destroyed.</p> <p>Notes:</p> <ol style="list-style-type: none"> 1. If the program that deposited the journal entry is an original program model program, this data will be complete. Otherwise, this data will be unpredictable. 2. If a RCVSIZOPT or a FIXLENDTA option was specified that omitted the collection of this information, *OMITTED is given for the program name. |
| 67 | Object name (JOOBJ, <i>Object</i>) | Char (10) | <p>Specifies the name of the object for which the journal entry was added.¹ This is blank for some entries.</p> <p>If the journaled object is an integrated file system object, then this field is the first 10 bytes of the file identifier.</p> |
| 77 | Library name (JOLIB) | Char (10) | <p>Specifies the name of the library containing the object¹.</p> <p>If the journaled object is an integrated file system object, then the first 6 characters of this field are the last 6 bytes of the file identifier.</p> |
| 87 | Member name (JOMBR) | Char (10) | <p>Specifies the name of the physical file member or is blank if the object is not a physical file¹.</p> |

| Relative offset | Field | Format | Description |
|-----------------|--|--------------|---|
| 97 | Count/relative record number (JOCTRR, <i>Count_Rel_Rec_Num</i>) | Zoned (10,0) | <p>Contains either the relative record number (RRN) of the record that caused the journal entry or a count that is pertinent to the specific type of journal entry. The following tables show specific values for this field, if applicable:</p> <ul style="list-style-type: none"> • APYJRNCHG and RMVJRNCHG journal entries • Change end of data journal entry • CHGJRN journal entries • COMMIT journal entry • INZPFM journal entry <p>This field can contain a -1 if receiver-size option RCVSIZOPT(*MAXOPT3) is selected and the actual value of the count or relative record number is larger than 9 999 999 999.</p> |
| 107 | Indicator flag (JOFLAG, <i>Indicator_Flag</i>) | Char (1) | <p>Contains an indicator for the operation. The following tables show specific values for this field, if applicable:</p> <ul style="list-style-type: none"> • APYJRNCHG and RMVJRNCHG journal entries • COMMIT journal entry • INZPFM journal entry • IPL and in-use journal entries • Journal code R (all journal entry types except IL) • ROLLBACK journal entry • Start-journal journal entries |
| 108 | Commit cycle identifier (JOCCID, <i>Commit_Cycle_Id</i>) | Zoned (10,0) | <p>Contains a number that identifies the commit cycle. A commit cycle is from one commit or rollback operation to another.</p> <p>The commit cycle identifier is found in every journal entry that is associated with a commitment transaction. If the journal entry was not made as part of a commitment transaction, this field is zero.</p> <p>This field can contain a -1 if receiver-size option RCVSIZOPT(*MAXOPT3) is selected and the actual value of the commit cycle identifier is larger than 9 999 999 999.</p> |

| Relative offset | Field | Format | Description |
|-----------------|---|----------|---|
| 118 | Incomplete data (JOINCDAT, <i>Incomplete_Data</i>) | Char (1) | <p>Indicates whether this entry has data that is not being retrieved for one of the following reasons:</p> <ul style="list-style-type: none"> • The length of the entry-specific data exceeds 32 766 bytes. • The entry is associated with a database file that has one or more fields of data type BLOB (binary large object), CLOB (character large object), or DBCLOB (double-byte character large object). <p>The possible values are:</p> <p>0 = This entry has all possible data 1 = This entry has incomplete data.</p> <p>Any data which is marked as incomplete, can only be viewed by using either the QjoRetrieveJournalEntries API, or the command RCVJRNE with any of the following parameters:</p> <ul style="list-style-type: none"> • ENTFMT(*TYPEPTR) • ENTFMT(*JRNENTFMT) • RTNPNTR (with any value specified other than *NONE) |
| 119 | Minimized entry specific data (JOMINESD, <i>Min_ESD</i>) | Char (1) | <p>Indicates whether this entry has minimized entry specific data.</p> <p>The possible values are:</p> <p>0 = This entry has all possible data 1 = This entry has incomplete data. 2 = This entry has entry specific data that has been minimized on field boundaries.</p> |
| 120 | Reserved field (JORES) | Char (6) | Always contains zeros. Contains hexadecimal zeros in the output file. |

Note:

¹If the journal receiver was attached prior to installing V4R2M0 on your system, then the following items are true:

- If *ALLFILE is specified for the FILE parameter on the **DSPJRN**, **RCVJRNE**, or **RTVJRNE** command, then the fully qualified name is the most recent name of the file when the newest receiver in the receiver range was the attached receiver and when the file was still being journaled.
- If a file name is specified or if library *ALL is specified on the FILE parameter, the current fully qualified name of the file appears in the converted journal entry.

If the journal receiver was attached while V4R2M0 or a later release was running on the system, the fully qualified name is the name of the object at the time the journal entry was deposited.

*TYPE2 field descriptions of the fixed-length portion of a journal entry

These fields are shown when you request *TYPE2 for the output file format or the entry type format. The uppercase field names shown in parentheses are used in the system-supplied output file QSYS/QADSPJR2. The field names that are in italics are the variable names for these fields in the QjoRetrieveJournalEntries API header file. These variables are under the type definition for the RJNE0100 format. The QjoRetrieveJournalEntries API header is in the QJOURNAL.H file of the QSYSINC library.

| Offset | Field | Format | Description |
|--------|--|--------------|---|
| 1 | Entry length (JOENTL) | Zoned (5,0) | <p>Specifies the length of the journal entry including the entry length field, all subsequent positions of the journal entry, and any portion of the journal entry that was truncated if the length of the output record is less than the length of the record created for the journal entry.</p> <p>If the journal entry has the incomplete data indicator on, then this length does not include that additional data which could be pointed to. This length includes the length of the data that is actually returned, which includes entry specific data of up to 32 766 bytes.</p> |
| 6 | Sequence number (JOSEQN, <i>Seq_Number</i>) | Zoned (10,0) | <p>Assigned by the system to each journal entry. It is initially set to 1 for each new or restored journal and is incremented until you request that it be reset when you attach a new receiver. There are occasional gaps in the sequence numbers because the system uses internal journal entries for control purposes. These gaps occur if you use commitment control, journal physical files, or journal access paths.</p> <p>This field can contain a -1 if receiver-size option RCVSIZOPT(*MAXOPT3) is selected and the actual value of the sequence number is larger than 9 999 999 999.</p> |

| Offset | Field | Format | Description |
|--------|--|-------------|--|
| 16 | Journal code (JOCODE, <i>Jrn_Code</i>) | Char (1) | <p>Identifies the primary category of the journal entry:</p> <ul style="list-style-type: none"> A = System accounting entry B = Integrated file system operation C = Commitment control operation D = Database file operation E = Data area operation F = Database file member operation I = Internal operation J = Journal or receiver operation L = License management M = Network management data P = Performance tuning entry Q = Data queue operation R = Operation on a specific record S = Distributed mail services T = Audit trail entry U = User-generated entry (added by the SNDJRNE command or QJOSJRNE API) <p>The journal codes are described in more detail in Journal code descriptions.</p> |
| 17 | Entry type (JOENTT, <i>Entry_Type</i>) | Char (2) | Further identifies the type of user-created or system-created entry. See the Journal code finder for descriptions of the entry types. |
| 19 | Date stamp (JODATE) | Char (6) | Specifies the system date when the entry was added and is in the format of the job attribute DATFMT. The system cannot assure that the date stamp is always in ascending order for sequential journal entries because you can change the value of the system date. |
| 25 | Time stamp (JOTIME) | Zoned (6,0) | Corresponds to the system time (in the format hhmmss) when the entry was added. The system cannot assure that the time stamp is always in ascending order for sequential journal entries because you can change the value of the system time. |
| 31 | Job name (JOJOB, <i>Job_Name</i>) | Char (10) | <p>Specifies the name of the job that added the entry.</p> <p>Notes:</p> <ol style="list-style-type: none"> 1. If a RCVSIZOPT or a FIXLENDTA option was specified that omitted the collection of this information, then *OMITTED is given for the job name. 2. If the job name was not available when the journal entry was deposited, then *NONE is written for the job name. |

| Offset | Field | Format | Description |
|--------|---|-------------|---|
| 41 | User name (JOUSER, <i>User_Name</i>) | Char (10) | Specifies the user profile name of the user that started the job. Note: If a RCVSIZOPT or a FIXLENDTA option was specified that omitted the collection of this information, then blanks are written for the user name. |
| 51 | Job number (JONBR, <i>Job_Number</i>) | Zoned (6,0) | Specifies the job number of the user that started the job. Note: If a RCVSIZOPT or a FIXLENDTA option was specified that omitted the collection of this information, then zeroes are written for the job number. |
| 57 | Program name (JOPGM, <i>Program_Name</i>) | Char (10) | Specifies the name of the program that added the entry. If an application or CL program did not add the entry, the field contains the name of a system-supplied program such as QCMD or QPGMMENU. If the program name is the special value *NONE, then one of the following is true: <ul style="list-style-type: none"> • The program name does not apply to this journal entry. • The program name was not available when the journal entry was made. For example, the program name is not available if the program was destroyed. Notes: <ol style="list-style-type: none"> 1. If the program that deposited the journal entry is an original program model program, this data will be complete. Otherwise, this data will be unpredictable. 2. If a RCVSIZOPT or a FIXLENDTA option was specified that omitted the collection of this information, *OMITTED is given for the program name. |
| 67 | Object name (JOOBJ, <i>Object</i>) | Char (10) | Specifies the name of the object for which the journal entry was added. ¹ This is blank for some entries. If the journaled object is an integrated file system object, then this field is the first 10 bytes of the file identifier. |
| 77 | Library name (JOLIB) | Char (10) | Specifies the name of the library containing the object ¹ . If the journaled object is an integrated file system object, then the first 6 characters of this field are the last 6 bytes of the file identifier. |

| Offset | Field | Format | Description |
|--------|--|--------------|---|
| 87 | Member name (JOMBR) | Char (10) | Specifies the name of the physical file member or is blank if the object is not a physical file ¹ . |
| 97 | Count/relative record number (JOCTRR, <i>Count_Rel_Rec_Num</i>) | Zoned (10,0) | <p>Contains either the relative record number (RRN) of the record that caused the journal entry or a count that is pertinent to the specific type of journal entry. The following tables show specific values for this field, if applicable:</p> <ul style="list-style-type: none"> • APYJRNCHG and RMVJRNCHG journal entries • Change end of data journal entry • CHGJRN journal entries • COMMIT journal entry • INZPFM journal entry <p>This field can contain a -1 if receiver-size option RCVSIZOPT(*MAXOPT3) is selected and the actual value of the count or relative record number is larger than 9 999 999 999.</p> |
| 107 | Indicator flag (JOFLAG, <i>Indicator_Flag</i>) | Char (1) | <p>Contains an indicator for the operation. The following tables show specific values for this field, if applicable:</p> <ul style="list-style-type: none"> • APYJRNCHG and RMVJRNCHG journal entries • COMMIT journal entry • INZPFM journal entry • IPL and in-use journal entries • Journal code R (all journal entry types except IL) • ROLLBACK journal entry • Start-journal journal entries |
| 108 | Commit cycle identifier (JOCCID, <i>Commit_Cycle_Id</i>) | Zoned (10,0) | <p>Contains a number that identifies the commit cycle. A commit cycle is from one commit or rollback operation to another.</p> <p>The commit cycle identifier is found in every journal entry that is associated with a commitment transaction. If the journal entry was not made as part of a commitment transaction, this field is zero.</p> <p>This field can contain a -1 if receiver-size option RCVSIZOPT(*MAXOPT3) is selected and the actual value of the commit cycle identifier is larger than 9 999 999 999.</p> |

| Offset | Field | Format | Description |
|--------|--|-----------|---|
| 118 | User profile (JOUSPF, <i>User_Profile</i>) | Char (10) | Specifies the name of the user profile under which the job was running when the entry was created. Note: If a RCVSIZOPT or a FIXLENDTA option was specified that omitted the collection of this information, then *OMITTED is given for the user profile. |
| 128 | System name (JOSYNM, <i>System_Name</i>) | Char (8) | Specifies the name of the system on which the entry is being displayed, printed, retrieved, or received if the journal receiver was attached prior to installing V4R2M0 on the system. If the journal receiver was attached while the system was running V4R2M0 or a later release, the system name is the system where the journal entry was actually deposited. |
| 136 | Incomplete data (JOINCDAT, <i>Incomplete_Data</i>) | Char (1) | Indicates whether this entry has data that is not being retrieved for one of the following reasons: <ul style="list-style-type: none"> • The length of the entry-specific data exceeds 32 766 bytes. • The entry is associated with a database file that has one or more fields of data type BLOB (binary large object), CLOB (character large object), or DBCLOB (double-byte character large object). The possible values are: <ul style="list-style-type: none"> 0 = This entry has all possible data 1 = This entry has incomplete data Any data which is marked as incomplete, can only be viewed by using either the QjRetrieveJournalEntries API, or the command RCVJRNE with any of the following parameters: <ul style="list-style-type: none"> • ENTFMT(*TYPEPTR) • ENTFMT(*JRNENTFMT) • RTNPTR (with any value specified other than *NONE) |
| 137 | Minimized entry specific data (JOMINESD, <i>Min_ESD</i>) | Char (1) | Indicates whether this entry has minimized entry specific data. The possible values are: <ul style="list-style-type: none"> 0 = This entry has complete entry specific data. 1 = This entry has minimized entry specific data. 2 = This entry has entry specific data that has been minimized on field boundaries. |

| Offset | Field | Format | Description |
|--------|------------------------|-----------|---|
| 138 | Reserved field (JORES) | Char (18) | Always contains zeros. Contains hexadecimal zeros in the output file. |

Note:

¹ If the journal receiver was attached prior to installing V4R2M0 on your system, then the following items are true:

- If *ALLFILE is specified for the FILE parameter on the **DSPJRN**, **RCVJRNE**, or **RTVJRNE** command, then the fully qualified name is the most recent name of the file when the newest receiver in the receiver range was the attached receiver and when the file was still being journaled.
- If a file name is specified or if library *ALL is specified on the FILE parameter, the current fully qualified name of the file appears in the converted journal entry.

If the journal receiver was attached while V4R2M0 or a later release was running on the system, the fully qualified name is the name of the object at the time the journal entry was deposited.

***TYPE3 field descriptions of the fixed-length portion of a journal entry**

These fields are shown when you request *TYPE3 for the output file format or the entry type format. The uppercase field names shown in parentheses are used in the system-supplied output file QSYS/QADSPJR3. The field names that are in italics are the variable names for these fields in the QjoRetrieveJournalEntries API header file. These variables are under the type definition for the RJNE0100 format. The QjoRetrieveJournalEntries API header is in the QJOURNAL.H file of the QSYSINC library.

| Offset | Field | Format | Description |
|--------|--|----------------------|--|
| 1 | Entry length (JOENTL) | Zoned (5,0) | Specifies the length of the journal entry including the entry length field, all subsequent positions of the journal entry, and any portion of the journal entry that was truncated if the length of the output record is less than the length of the record created for the journal entry. If the journal entry has the incomplete data indicator on, then this length does not include that additional data which could be pointed to. This length includes the length of the data that is actually returned, which includes entry specific data of up to 32 766 bytes. |
| 6 | Sequence number (JOSEQN, <i>Seq_Number</i>) | Zoned decimal (10,0) | Assigned by the system to each journal entry. It is initially set to 1 for each new or restored journal and is incremented until you request that it be reset when you attach a new receiver. There are occasional gaps in the sequence numbers because the system uses internal journal entries for control purposes. These gaps occur if you use commitment control, journal physical files, or journal access paths. This field can contain a -1 if receiver-size option RCVSIZOPT(*MAXOPT3) is selected and the actual value of the sequence number is larger than 9 999 999 999. |

| Offset | Field | Format | Description |
|--------|--|-----------|--|
| 16 | Journal code (JOCODE, <i>Jrn_Code</i>) | Char (1) | <p>Identifies the primary category of the journal entry:</p> <ul style="list-style-type: none"> A = System accounting entry B = Integrated file system operation C = Commitment control operation D = Database file operation E = Data area operation F = Database file member operation I = Internal operation J = Journal or receiver operation L = License management M = Network management data P = Performance tuning entry Q = Data queue operation R = Operation on a specific record S = Distributed mail services T = Audit trail entry U = User-generated entry (added by the SNDJRNE command or QJOSJRNE API) <p>The journal codes are described in more detail in Journal code descriptions.</p> |
| 17 | Entry type (JOENTT, <i>Entry_Type</i>) | Char (2) | Further identifies the type of user-created or system-created entry. See the Journal code finder for descriptions of the entry types. |
| 19 | Time stamp (JOTMST, <i>Time_Stamp</i>) | Char (26) | Corresponds to the system date and time when the journal entry was added in the journal receiver. The time stamp is in SAA format. The system cannot assure that the time stamp is always in ascending order for sequential journal entries because you can change the value of the system time. |
| 45 | Job name (JOJOB, <i>Job_Name</i>) ¹ | Char (10) | <p>Specifies the name of the job that added the entry.</p> <p>Notes:</p> <ol style="list-style-type: none"> 1. If a RCVSIZOPT or a FIXLENDTA option was specified that omitted the collection of this information, then *OMITTED is given for the job name. 2. If the job name was not available when the journal entry was deposited, then *NONE is written for the job name. |
| 55 | User name (Jouser, <i>User_Name</i>) | Char (10) | <p>Specifies the user profile name of the user that started the job.</p> <p>Note: If a RCVSIZOPT or a FIXLENDTA option was specified that omitted the collection of this information, then blanks are written for the user name.</p> |

| Offset | Field | Format | Description |
|--------|---|-------------|---|
| 65 | Job number (JONBR, <i>Job_Number</i>) | Zoned (6,0) | Specifies the job number of the user that started the job. Note: If a RCVSIZOPT or a FIXLENDTA option was specified that omitted the collection of this information, then zeroes are written for the job number. |
| 71 | Program name (JOPGM, <i>Program_Name</i>) | Char (10) | Specifies the name of the program that added the entry. If an application or CL program did not add the entry, the field contains the name of a system-supplied program such as QCMD or QPGMMENU. If the program name is the special value *NONE, then one of the following is true: <ul style="list-style-type: none"> • The program name does not apply to this journal entry. • The program name was not available when the journal entry was made. For example, the program name is not available if the program was destroyed. Notes: <ol style="list-style-type: none"> 1. If the program that deposited the journal entry is an original program model program, this data will be complete. Otherwise, this data will be unpredictable. 2. If a RCVSIZOPT or a FIXLENDTA option was specified that omitted the collection of this information, *OMITTED is given for the program name. |
| 81 | Object name (JOOBJ, <i>Object</i>) | Char (10) | Specifies the name of the object for which the journal entry was added. ¹ This is blank for some entries. If the journaled object is an integrated file system object, then this field is the first 10 bytes of the file identifier. |
| 91 | Library name (JOLIB) | Char (10) | Specifies the name of the library containing the object ¹ . If the journaled object is an integrated file system object, then the first 6 characters of this field are the last 6 bytes of the file identifier. |
| 101 | Member name (JOMBR) | Char (10) | Specifies the name of the physical file member or is blank if the object is not a physical file ¹ . |

| Offset | Field | Format | Description |
|--------|--|--------------|--|
| 111 | Count/relative record number (JOCTRR, <i>Count_Rel_Rec_Num</i>) | Zoned (10,0) | <p>Contains either the relative record number (RRN) of the record that caused the journal entry or a count that is pertinent to the specific type of journal entry.</p> <ul style="list-style-type: none"> • APYJRNCHG and RMVJRNCHG journal entries • Change end of data journal entry • CHGJRN journal entries • COMMIT journal entry • INZPFM journal entry <p>This field can contain a -1 if receiver-size option RCVSIZOPT(*MAXOPT3) is selected and the actual value of the count or relative record number is larger than 9 999 999 999.</p> |
| 121 | Indicator flag (JOFLAG, <i>Indicator_Flag</i>) | Char (1) | <p>Contains an indicator for the operation. The following tables show specific values for this field, if applicable:</p> <ul style="list-style-type: none"> • APYJRNCHG and RMVJRNCHG journal entries • COMMIT journal entry • INZPFM journal entry • IPL and in-use journal entries • Journal code R (all journal entry types except IL) • ROLLBACK journal entry • Start-journal journal entries |
| 122 | Commit cycle identifier (JOCCID, <i>Commit_Cycle_Id</i>) | Zoned (10,0) | <p>Contains a number that identifies the commit cycle. A commit cycle is from one commit or rollback operation to another.</p> <p>The commit cycle identifier is found in every journal entry that is associated with a commitment transaction. If the journal entry was not made as part of a commitment transaction, this field is zero.</p> <p>This field can contain a -1 if receiver-size option RCVSIZOPT(*MAXOPT3) is selected and the actual value of the commit cycle identifier is larger than 9 999 999 999.</p> |
| 132 | User profile (JOUSPF, <i>User_Profile</i>) | Char (10) | <p>Specifies the name of the user profile under which the job was running when the entry was created.</p> <p>Note: If a RCVSIZOPT or a FIXLENDTA option was specified that omitted the collection of this information, then *OMITTED is given for the user profile.</p> |

| Offset | Field | Format | Description |
|--------|--|-----------|---|
| 142 | System name (JOSYNM, <i>System_Name</i>) | Char (8) | Specifies the name of the system on which the entry is being displayed, printed, retrieved, or received if the journal receiver was attached prior to installing V4R2M0 on the system. If the journal receiver was attached while the system was running V4R2M0 or a later release, the system name is the system where the journal entry was actually deposited. |
| 150 | Incomplete data (JOINCDAT, <i>Incomplete_Data</i>) | Char (1) | <p>Indicates whether this entry has data that is not being retrieved for one of the following reasons:</p> <ul style="list-style-type: none"> • The length of the entry-specific data exceeds 32 766 bytes. • The entry is associated with a database file that has one or more fields of data type BLOB (binary large object), CLOB (character large object), or DBCLOB (double-byte character large object). <p>The possible values are:</p> <p>0 = This entry has all possible data 1 = This entry has incomplete data.</p> <p>Any data which is marked as incomplete, can only be viewed by using either the <code>QjoRetrieveJournalEntries</code> API, or the command RCVJRNE with any of the following parameters:</p> <ul style="list-style-type: none"> • ENTFMT(*TYPEPTR) • ENTFMT(*JRMENTFMT) • RTNPNTR (with any value specified other than *NONE) |
| 151 | Minimized entry specific data (JOMINESD, <i>Min_ESD</i>) | Char (1) | <p>Indicates whether this entry has minimized entry specific data.</p> <p>The possible values are:</p> <p>0 = This entry has complete entry specific data. 1 = This entry has minimized entry specific data. 2 = This entry has entry specific data that has been minimized on field boundaries.</p> |
| 152 | Reserved field (JORES) | Char (18) | Always contains zeros. Contains hexadecimal zeros in the output file. |

| Offset | Field | Format | Description |
|--|-------|--------|-------------|
| Note: | | | |
| <p>¹If the journal receiver was attached prior to installing V4R2M0 on your system, then the following items are true:</p> <ul style="list-style-type: none"> • If *ALLFILE is specified for the FILE parameter on the DSPJRN, RCVJRNE, or RTVJRNE command, then the fully qualified name is the most recent name of the file when the newest receiver in the receiver range was the attached receiver and when the file was still being journaled. • If a file name is specified or if library *ALL is specified on the FILE parameter, the current fully qualified name of the file appears in the converted journal entry. <p>If the journal receiver was attached while V4R2M0 or a later release was running on the system, the fully qualified name is the name of the object at the time the journal entry was deposited.</p> | | | |

*TYPE4 field descriptions of the fixed-length portion of a journal entry

These fields are shown when you request *TYPE4 for the output file format or the entry type format. The uppercase field names shown in parentheses are used in the system-supplied output file QSYS/QADSPJR4. The field names which are in italics are the variable names for these fields in the QjoRetrieveJournalEntries API header file. These variables are under the type definition for the RJNE0100 format. The QjoRetrieveJournalEntries API header is in the QJOURNAL.H file of the QSYSINC library.

| Offset | Field | Format | Description |
|--------|--|----------------------|---|
| 1 | Entry length (JOENTL) | Zoned (5,0) | <p>Specifies the length of the journal entry including the entry length field, all subsequent positions of the journal entry, and any portion of the journal entry that was truncated if the length of the output record is less than the length of the record created for the journal entry.</p> <p>If the journal entry has the incomplete data indicator on, then this length does not include that additional data which could be pointed to. This length includes the length of the data that is actually returned, which includes entry specific data of up to 32 766 bytes.</p> |
| 6 | Sequence number (JOSEQN, <i>Seq_Number</i>) | Zoned decimal (10,0) | <p>Assigned by the system to each journal entry. It is initially set to 1 for each new or restored journal and is incremented until you request that it be reset when you attach a new receiver. There are occasional gaps in the sequence numbers because the system uses internal journal entries for control purposes. These gaps occur if you use commitment control, journal physical files, or journal access paths.</p> <p>This field can contain a -1 if receiver-size option RCVSIZOPT(*MAXOPT3) is selected and the actual value of the sequence number is larger than 9 999 999 999.</p> |

| Offset | Field | Format | Description |
|--------|--|-----------|--|
| 16 | Journal code (JOCODE, <i>Jrn_Code</i>) | Char (1) | <p>Identifies the primary category of the journal entry:</p> <ul style="list-style-type: none"> A = System accounting entry B = Integrated file system operation C = Commitment control operation D = Database file operation E = Data area operation F = Database file member operation I = Internal operation J = Journal or receiver operation L = License management M = Network management data P = Performance tuning entry Q = Data queue operation R = Operation on a specific record S = Distributed mail services T = Audit trail entry U = User-generated entry (added by the SNDJRNE command or QJOSJRNE API) <p>The journal codes are described in more detail in Journal code descriptions.</p> |
| 17 | Entry type (JOENTT, <i>Entry_Type</i>) | Char (2) | Further identifies the type of user-created or system-created entry. See the Journal code finder for descriptions of the entry types. |
| 19 | Time stamp (JOTMST, <i>Time_Stamp</i>) | Char (26) | Corresponds to the system date and time when the journal entry was added in the journal receiver. The time stamp is in SAA format. The system cannot assure that the time stamp is always in ascending order for sequential journal entries because you can change the value of the system time. |
| 45 | Job name (JOJOB, <i>Job_Name</i>) ¹ | Char (10) | <p>Specifies the name of the job that added the entry.</p> <p>Notes:</p> <ol style="list-style-type: none"> 1. If a RCVSIZOPT or a FIXLENDTA option was specified that omitted the collection of this information, then *OMITTED is given for the job name. 2. If the job name was not available when the journal entry was deposited, then *NONE is written for the job name. |
| 55 | User name (Jouser, <i>User_Name</i>) | Char (10) | <p>Specifies the user profile name of the user that started the job.</p> <p>Note: If a RCVSIZOPT or a FIXLENDTA option was specified that omitted the collection of this information, then blanks are written for the user name.</p> |

| Offset | Field | Format | Description |
|--------|---|-------------|---|
| 65 | Job number (JONBR, <i>Job_Number</i>) | Zoned (6,0) | Specifies the job number of the user that started the job. Note: If a RCVSIZOPT or a FIXLENDTA option was specified that omitted the collection of this information, then zeroes are written for the job number. |
| 71 | Program name (JOPGM, <i>Program_Name</i>) | Char (10) | Specifies the name of the program that added the entry. If an application or CL program did not add the entry, the field contains the name of a system-supplied program such as QCMD or QPGMMENU. If the program name is the special value *NONE, then one of the following is true: <ul style="list-style-type: none"> • The program name does not apply to this journal entry. • The program name was not available when the journal entry was made. For example, the program name is not available if the program was destroyed. Notes: <ol style="list-style-type: none"> 1. If the program that deposited the journal entry is an original program model program, this data will be complete. Otherwise, this data will be unpredictable. 2. If a RCVSIZOPT or a FIXLENDTA option was specified that omitted the collection of this information, *OMITTED is given for the program name. |
| 81 | Object name (JOOBJ, <i>Object</i>) | Char (10) | Specifies the name of the object for which the journal entry was added. ¹ This is blank for some entries. If the journaled object is an integrated file system object, then this field is the first 10 bytes of the file identifier. |
| 91 | Library name (JOLIB) | Char (10) | Specifies the name of the library containing the object ¹ . If the journaled object is an integrated file system object, then the first 6 characters of this field are the last 6 bytes of the file identifier. |
| 101 | Member name (JOMBR) | Char (10) | Specifies the name of the physical file member or is blank if the object is not a physical file ¹ . |

| Offset | Field | Format | Description |
|--------|--|--------------|--|
| 111 | Count/relative record number (JOCTRR, <i>Count_Rel_Rec_Num</i>) | Zoned (10,0) | <p>Contains either the relative record number (RRN) of the record that caused the journal entry or a count that is pertinent to the specific type of journal entry.</p> <ul style="list-style-type: none"> • APYJRNCHG and RMVJRNCHG journal entries • Change end of data journal entry • CHGJRN journal entries • COMMIT journal entry • INZPFM journal entry <p>This field can contain a -1 if receiver-size option RCVSIZOPT(*MAXOPT3) is selected and the actual value of the count or relative record number is larger than 9 999 999 999.</p> |
| 121 | Indicator flag (JOFLAG, <i>Indicator_Flag</i>) | Char (1) | <p>Contains an indicator for the operation. The following tables show specific values for this field, if applicable:</p> <ul style="list-style-type: none"> • APYJRNCHG and RMVJRNCHG journal entries • COMMIT journal entry • INZPFM journal entry • IPL and in-use journal entries • Journal code R (all journal entry types except IL) • ROLLBACK journal entry • Start-journal journal entries |
| 122 | Commit cycle identifier (JOCCID, <i>Commit_Cycle_Id</i>) | Zoned (10,0) | <p>Contains a number that identifies the commit cycle. A commit cycle is from one commit or rollback operation to another.</p> <p>The commit cycle identifier is found in every journal entry that is associated with a commitment transaction. If the journal entry was not made as part of a commitment transaction, this field is zero.</p> <p>This field can contain a -1 if receiver-size option RCVSIZOPT(*MAXOPT3) is selected and the actual value of the commit cycle identifier is larger than 9 999 999 999.</p> |
| 132 | User profile (JOUSPF, <i>User_Profile</i>) | Char (10) | <p>Specifies the name of the user profile under which the job was running when the entry was created.</p> <p>Note: If a RCVSIZOPT or a FIXLENDTA option was specified that omitted the collection of this information, then *OMITTED is given for the user profile.</p> |

| Offset | Field | Format | Description |
|--------|---|----------|---|
| 142 | System name (JOSYNM, <i>System_Name</i>) | Char (8) | Specifies the name of the system on which the entry is being displayed, printed, retrieved, or received if the journal receiver was attached prior to installing V4R2M0 on the system. If the journal receiver was attached while the system was running V4R2M0 or a later release, the system name is the system where the journal entry was actually deposited. |
| 150 | Journal identifier (JOJID, <i>Jid</i>) | Char(10) | Specifies the journal identifier (JID) for the object. When journaling is started for an object, the system assigns a unique JID to that object. The JID remains constant even if the object is renamed or moved. However, if journaling is stopped, there is no guarantee that the JID will be the same if journaling is started again for the same object. If no JID is associated with the entry, this field has hexadecimal zeros. |
| 160 | Referential constraint (JORCST, <i>Referential_Constraint</i>) | Char(1) | Indicates whether this entry was recorded for actions that occurred on records that are part of a referential constraint. The possible values are: 0 = This entry was not created as part of a referential constraint. 1 = This entry was created as part of a referential constraint. |
| 161 | Trigger (JOTGR, <i>Trigger</i>) | Char(1) | Indicates whether this entry was created as result of a trigger program. The possible values are: 0 = This entry was not created as the result of a trigger program. 1 = This entry was created as the result of a trigger program. |

| Offset | Field | Format | Description |
|--------|--|----------|--|
| 162 | Incomplete data (JOINCDAT, <i>Incomplete_Data</i>) | Char (1) | <p>Indicates whether this entry has data that is not being retrieved for one of the following reasons:</p> <ul style="list-style-type: none"> • The length of the entry-specific data exceeds 32 766 bytes. • The entry is associated with a database file that has one or more fields of data type BLOB (binary large object), CLOB (character large object), or DBCLOB (double-byte character large object). <p>The possible values are:</p> <p>0 = This entry has all possible data. 1 = This entry has incomplete data.</p> <p>Any data which is marked as incomplete, can only be viewed by using either the <code>QjoRetrieveJournalEntries</code> API, or the command RCVJRNE with any of the following parameters:</p> <ul style="list-style-type: none"> • ENTFMT(*TYPEPTR) • ENTFMT(*JRNENTFMT) • RTNPNTR (with any value specified other than *NONE) |
| 163 | Ignored by APYJRCHG or RMVJRCHG (JOIGNAPY, <i>Ignore_during_APYRMV</i>) | Char (1) | <p>Indicates whether this journal entry will be ignored by the execution of the APYJRCHG or RMVJRCHG commands, even though normally this journal entry type has an effect during those command invocations.</p> <p>The possible values are:</p> <p>0 = This entry is not ignored by the APYJRCHG or RMVJRCHG commands. 1 = This entry is ignored by the APYJRCHG or RMVJRCHG commands.</p> |
| 164 | Minimized entry specific data (JOMINESD, <i>Min_ESD</i>) | Char (1) | <p>Indicates whether this entry has minimized entry specific data.</p> <p>The possible values are:</p> <p>0 = This entry has complete entry specific data. 1 = This entry has minimized entry specific data. 2 = This entry has entry specific data that has been minimized on field boundaries.</p> |
| 165 | Reserved area (JORES) | Char (5) | Always contains zeros. Contains hexadecimal zeros in the output file. |

| Offset | Field | Format | Description |
|---|-------|--------|-------------|
| <p>Note: ¹If the journal receiver was attached prior to installing V4R2M0 on your system, then the following items are true:</p> <ul style="list-style-type: none"> • If *ALLFILE is specified for the FILE parameter on the DSPJRN, RCVJRNE, or RTVJRNE command, then the fully qualified name is the most recent name of the file when the newest receiver in the receiver range was the attached receiver and when the file was still being journaled. • If a file name is specified or if library *ALL is specified on the FILE parameter, the current fully qualified name of the file appears in the converted journal entry. <p>If the journal receiver was attached while V4R2M0 or a later release was running on the system, the fully qualified name is the name of the object at the time the journal entry was deposited.</p> | | | |

*TYPE5 field descriptions of the fixed-length portion of a journal entry

These fields are shown when you request *TYPE5 for the output file format or the entry type format. The uppercase field names shown in parentheses are used in the system-supplied output file QSYS/QADSPJR5. The field names that are italics are the variable names for these fields in the QjoRetrieveJournalEntries API header file. These variables are under the type definition for the RJNE0200 format. The QjoRetrieveJournalEntries API header is in the QJOURNAL.H file of the QSYSINC library.

| Offset | Field | Format | Description |
|--------|--|-------------|--|
| 1 | Entry length (JOENTL) | Zoned (5,0) | <p>Specifies the length of the journal entry including the entry length field, all subsequent positions of the journal entry, and any portion of the journal entry that was truncated if the length of the output record is less than the length of the record created for the journal entry.</p> <p>If the journal entry has the incomplete data indicator on, then this length does not include that additional data which could be pointed to. This length includes the length of the data that is actually returned, which includes entry specific data of up to 32 766 bytes.</p> |
| 6 | Sequence number (JOSEQN, <i>Seq_Number</i>) | Char (20) | <p>Assigned by the system to each journal entry. It is initially set to 1 for each new or restored journal and is incremented until you request that it be reset when you attach a new receiver. There are occasional gaps in the sequence numbers because the system uses internal journal entries for control purposes. These gaps occur if you use commitment control, journal physical files, or journal access paths.</p> |

| Offset | Field | Format | Description |
|--------|---|-----------|--|
| 26 | Journal code (JOCODE, <i>Jrn_Code</i>) | Char (1) | <p>Identifies the primary category of the journal entry:</p> <ul style="list-style-type: none"> A = System accounting entry B = Integrated file system operation C = Commitment control operation D = Database file operation E = Data area operation F = Database file member operation I = Internal operation J = Journal or receiver operation L = License management M = Network management data P = Performance tuning entry Q = Data queue operation R = Operation on a specific record S = Distributed mail services T = Audit trail entry U = User-generated entry (added by the SNDJRNE command or QJOSJRNE API) <p>The journal codes are described in more detail in Journal code descriptions.</p> |
| 27 | Journal entry type (JOENTT, <i>Entry_Type</i>) | Char (2) | Further identifies the type of user-created or system-created entry. See the Journal code finder for descriptions of the entry types. |
| 29 | Time stamp (JOTSTP) | Char (26) | Corresponds to the system date and time when the journal entry was added in the journal receiver. The time stamp is in SAA format. The system cannot assure that the time stamp is always in ascending order for sequential journal entries because you can change the value of the system time. |
| 55 | Job name (JOJOB, <i>Job_Name</i>) | Char (10) | <p>Specifies the name of the job that added the entry.</p> <p>Notes:</p> <ol style="list-style-type: none"> 1. If a RCVSIZOPT or a FIXLENDTA option was specified that omitted the collection of this information, then *OMITTED is given for the job name. 2. If the job name was not available when the journal entry was deposited, then *NONE is written for the job name. |
| 65 | User name (Jouser, <i>User_Name</i>) | Char (10) | <p>Specifies the user profile name of the user that started the job.</p> <p>Note: If a RCVSIZOPT or a FIXLENDTA option was specified that omitted the collection of this information, then blanks are written for the user name.</p> |

| Offset | Field | Format | Description |
|--------|--|--------------|---|
| 75 | Job number (JONBR, <i>Job_Number</i>) | Zoned (6, 0) | Specifies the job number of the user that started the job. Note: If a RCVSIZOPT or a FIXLENDTA option was specified that omitted the collection of this information, then zeroes are written for the job number. |
| 81 | Program name (JOPGM, <i>Program_Name</i>) | Char (10) | Specifies the name of the program that added the entry. If an application or CL program did not add the entry, the field contains the name of a system-supplied program such as QCMD or QPGMMENU. If the program name is the special value *NONE, then one of the following is true: <ul style="list-style-type: none"> • The program name does not apply to this journal entry. • The program name was not available when the journal entry was made. For example, the program name is not available if the program was destroyed. Notes: <ol style="list-style-type: none"> 1. If the program that deposited the journal entry is an original program model program, this data will be complete. Otherwise, this data will be unpredictable. 2. If a RCVSIZOPT or a FIXLENDTA option was specified that omitted the collection of this information, *OMITTED is given for the program name. |
| 91 | Program library name (JOPGMLIB, <i>Program_Library_Name</i>) | Char (10) | The name of the library that contains the program that added the library. If a RCVSIZOPT or a FIXLENDTA option was specified that omitted the collection of this information, then *OMITTED will be returned for the program library name. IF *NONE is returned for Program name, then *NONE is also returned for the program library name. |
| 101 | Program library ASP device name (JOPGMDEV, <i>Program_ASP_Device_Name</i>) | Char (10) | The name of the ASP device that contains the program. If a RCVSIZOPT or a FIXLENDTA option was specified that omitted the collection of this information, then *OMITTED will be returned for the program library ASP device name. IF *NONE is returned for Program name, then *NONE is also returned for the program library ASP device name. |

| Offset | Field | Format | Description |
|--------|---|-------------|--|
| 111 | Program library ASP number (JOPGMASP, <i>Program_ASP</i>) | Zoned (5,0) | The number for the auxiliary storage pool that contains the program that added the journal entry. If a RCVSIZOPT or a FIXLENDTA option was specified that omitted the collection of this information, then hexadecimal 0 will be returned for the program library ASP number. |
| 116 | Object name (JOOBJ, <i>Object</i>) | Char (10) | Specifies the name of the object for which the journal entry was added. ¹ This is blank for some entries. If the journaled object is an integrated file system object, then this field is the first 10 bytes of the file identifier. |
| 126 | Object library (JOLIB) | Char (10) | Specifies the name of the library containing the object ¹ . If the journaled object is an integrated file system object, then the first 6 characters of this field are the last 6 bytes of the file identifier. |
| 136 | Member name (JOMBR) | Char (10) | Specifies the name of the physical file member or is blank if the object is not a physical file ¹ . |
| 146 | Count or relative record number (JOCTRR, <i>Count_Rel_Rec_Num</i>) | Char (20) | Contains either the relative record number (RRN) of the record that caused the journal entry or a count that is pertinent to type of journal entry. |
| 166 | Indicator flag (JOFLAG, <i>Indicator_Flag</i>) | Char (1) | Contains an indicator for the operation. The following tables show specific values for this field, if applicable: <ul style="list-style-type: none"> • APYJRNCHG and RMVJRNCHG journal entries • COMMIT journal entry • INZPFM journal entry • IPL and in-use journal entries • Journal code R (all journal entry types except IL) • ROLLBACK journal entry • Start-journal journal entries |
| 167 | Commit control ID (JOCCID, <i>Commit_Cycle_Identifier</i>) | Char (20) | Contains a number that identifies the commit cycle. A commit cycle is from one commit or rollback operation to another. The commit cycle identifier is found in every journal entry that is associated with a commitment transaction. If the journal entry was not made as part of a commitment transaction, this field is zero. |

| Offset | Field | Format | Description |
|--------|---|-----------|---|
| 187 | User profile (JOUSPF, <i>User_profile</i>) | Char (10) | Specifies the name of the user profile under which the job was running when the entry was created. Note: If a RCVSIZOPT or a FIXLENDTA option was specified that omitted the collection of this information, then *OMITTED is given for the user profile. |
| 197 | System name (JOSYNM, <i>System_Name</i>) | Char (8) | Specifies the name of the system on which the entry is being displayed, printed, retrieved, or received if the journal receiver was attached prior to installing V4R2M0 on the system. If the journal receiver was attached while the system was running V4R2M0 or a later release, the system name is the system where the journal entry was actually deposited. |
| 205 | Journal identifier (JOJID, <i>Jid</i>) | Char (10) | Specifies the journal identifier (JID) for the object. When journaling is started for an object, the system assigns a unique JID to that object. The JID remains constant even if the object is renamed or moved. However, if journaling is stopped, there is no guarantee that the JID will be the same if journaling is started again for the same object. If no JID is associated with the entry, this field has hexadecimal zeros. |
| 215 | Referential constraint (JORCST, <i>Referential_Constraint</i>) | Char (1) | Indicates whether this entry was recorded for actions that occurred on records that are part of a referential constraint. The possible values are: 0 = This entry was not created as part of a referential constraint. 1 = This entry was created as part of a referential constraint. |
| 216 | Trigger (JOTGR, <i>Trigger</i>) | Char (1) | Indicates whether this entry was created as result of a trigger program. The possible values are: 0 = This entry was not created as the result of a trigger program. 1 = This entry was created as the result of a trigger program. |

| Offset | Field | Format | Description |
|--------|--|----------|--|
| 217 | Incomplete data (JOINCDAT, <i>Incomplete_Data</i>) | Char (1) | <p>Indicates whether this entry has data that is not being retrieved for one of the following reasons:</p> <ul style="list-style-type: none"> • The length of the entry-specific data exceeds 32 766 bytes. • The entry is associated with a database file that has one or more fields of data type BLOB (binary large object), CLOB (character large object), or DBCLOB (double-byte character large object). <p>The possible values are:</p> <p>0 = This entry has all possible data 1 = This entry has incomplete data.</p> <p>Any data which is marked as incomplete, can only be viewed by using either the QjoRetrieveJournalEntries API, or the command RCVJRNE with any of the following parameters:</p> <ul style="list-style-type: none"> • ENTFMT(*TYPEPTR) • ENTFMT(*JRNENTFMT) • RTNPNTR (with any value specified other than *NONE) |
| 218 | Ignored by APYJRNCHG or RMVJRNCHG (JOIGNAPY, <i>Ignore_during_APYRMV</i>) | Char (1) | <p>Indicates whether this journal entry will be ignored by the execution of the APYJRNCHG or RMVJRNCHG commands, even though normally this journal entry type has an effect during those command invocations.</p> <p>The possible values are:</p> <p>0 = This entry is not ignored by the APYJRNCHG or RMVJRNCHG commands. 1 = This entry is ignored by the APYJRNCHG or RMVJRNCHG commands.</p> |
| 219 | Minimized entry-specific data (JOMINESD, <i>Min_ESD</i>) | Char (1) | <p>Indicates whether this entry has minimized entry specific data.</p> <p>The possible values are:</p> <p>0 = This entry has complete entry specific data. 1 = This entry has minimized entry specific data. 2 = This entry has entry specific data that has been minimized on field boundaries.</p> |

| Offset | Field | Format | Description |
|--------|---|-----------------|---|
| 220 | Object indicator (JOOBJIND, <i>Object_Name_Indicator</i>) | Char (1) | An indicator with respect to the information in the object field ² . The valid values are: 0 = Either the journal entry has no object information or the object information in the journal entry header does not necessarily reflect the name of the object at the time the journal entry was deposited into the journal. 1 = The object information in the journal entry header reflects the name of the object at the time the journal entry was deposited into the journal. 2 = The object information in the journal entry header does not necessarily reflect the name of the object at the time the journal entry was deposited into the journal. The object information may be returned as a previously known name for the object prior to the journal entry being deposited into the journal or be returned as *UNKNOWN. |
| 221 | System sequence number (JOSYSSEQ, <i>System_Sequence_Number</i>) | Char (20) | The system sequence number indicates the relative sequence of when this journal entry was deposited into the journal. You can use the sequence number to sequentially order journal entries that are in separate journal receivers. If a RCVSIZOPT or a FIXLENDTA option was specified that omitted the collection of this information, then hexadecimal 0 will be returned for the system sequence number. |
| 241 | Receiver name (JORCV) | Char (10) | The name assigned to the journal receiver |
| 251 | Receiver library name (JORCVLIB) | Char (10) | The name of the library in which the journal receiver resides. |
| 261 | Receiver library ASP device name (JORCVDEV) | Char (10) | The name of the ASP device for journal receivers that reside on an independent disk pool |
| 271 | Receiver library ASP number (JORCVASP) | Zoned (5,0) | The number of the ASP on which the journal receiver resides. |
| 276 | Arm number (JOARM, <i>Arm_Number</i>) | Zoned (5,0) | The number of the disk arm that contains the journal entry. |
| 281 | Thread identifier (JOTHDX, <i>Thread_ID</i>) | Hexadecimal (8) | Identifies the thread within the process that added the journal entry. If a RCVSIZOPT or a FIXLENDTA option was specified that omitted the collection of this information, then hexadecimal 0 will be returned for the thread identifier. |
| 289 | Thread identifier formatted (JOTHD) | Char (16) | See Thread identifier. |

| Offset | Field | Format | Description |
|--------|--|--------------|---|
| 305 | Address family (JOADF, <i>Address_Family</i>) | Char (1) | The address family identifies the format of the remote address for this journal entry. If a RCVSIZOPT or a FIXLENDTA option was specified that omitted the collection of this information, then 0 will be returned for the address family. The possible values are: 0 = This entry was not associated with any remote address. 4 = The format of the remote address is Internet protocol version 4. 6 = The format of the remote address is Internet protocol version 6. |
| 306 | Remote port (JORPORT) | Zoned (5, 0) | The remote port of a the journal entries. If a RCVSIZOPT or a FIXLENDTA option was specified that omitted the collection of this information, then hexadecimal 0 will be returned for the remote port. |
| 311 | Remote address (JORADR) | Char (46) | The remote address of a the journal entries. If a RCVSIZOPT or a FIXLENDTA option was specified that omitted the collection of this information, then hexadecimal 0 will be returned for the remote address. |
| 357 | Logical unit of work (JOLUW) | Char (39) | The logical unit of work identifies entries to be associated with a given unit of work, usually within a commit cycle. If a RCVSIZOPT or a FIXLENDTA option was specified that omitted the collection of this information, then blanks will be returned for the logical unit of work. |
| 396 | Transaction identifier (JOXID) | Char (140) | See the QSYSINC/H.XA header file for the layout of this data. If a RCVSIZOPT or a FIXLENDTA option was specified that omitted the collection of this information, then the displacement to the transaction identifier is 0 and no transaction identifier is returned. |
| 536 | Object type (JOOBJTYP) | Char (7) | The type of object associated with this entry. (*FILE, *DTAARA, etc) |
| 543 | File type indicator (JOFILTYP) | Char (1) | The type of object associated with this entry. ('0' is physical, '1' is logical) |
| 544 | Nested commit level (JOCMTLVL) | Char (7) | The nested transaction level at which this entry was deposited. |
| 551 | Reserved | Char (5) | Reserved area. It always contains hexadecimal zeros. |

| Offset | Field | Format | Description |
|--|-------|--------|-------------|
| Notes: | | | |
| <p>¹If the journal receiver was attached prior to installing V4R2M0 on your system, then the following items are true:</p> <ul style="list-style-type: none"> • If *ALLFILE is specified for the FILE parameter on the DSPJRN, RCVJRNE, or RTVJRNE command, then the fully qualified name is the most recent name of the file when the newest receiver in the receiver range was the attached receiver and when the file was still being journaled. • If a file name is specified or if library *ALL is specified on the FILE parameter, the current fully qualified name of the file appears in the converted journal entry. <p>If the journal receiver was attached while V4R2M0 or a later release was running on the system, the fully qualified name is the name of the object at the time the journal entry was deposited.</p> <p>²This value will be returned only when retrieving journal entries from a remote journal and the remote journal is currently being caught up from its source journal. A remote journal is being caught up from its source journal when the Change Remote Journal (CHGRMTJRN) command or Change Journal State (QjoChangeJournalState) API is called and is currently replicating journal entries to the remote journal. After the call to the CHGRMTJRN command or QjoChangeJournalState API returns, the remote journal is maintained with a synchronous or asynchronous delivery mode, and the remote journal is no longer being caught up.</p> | | | |

Related concepts

[Journal code descriptions](#)

This topic provides a description of all of the journal codes and categories.

Related information

[Journal entry information finder](#)

Variable-length portion of the journal entry

This topic provides the layouts of the variable-length portion of the journal entries.

For output formats *TYPE1 and *TYPE2, the variable length portion of the journal entry includes just the **Entry-specific data** field. The contents of the Entry-specific data field depends on the journal entry code and entry type. For the layout of the output format *TYPEPTR or *JRNENTFMT, see the QjoRetrieveJournalEntries API. For all other output formats, the variable-length portion of the converted journal entry potentially has two fields:

- Null value indicators
- Entry-specific data

The Null Value Indicators field, contains relevant information only for entries with journal code R. Null value indicators are present in journal entries for record level operations as follows:

- The corresponding physical file has null capable fields.
- The record image has been minimized in the entry specific data.

Otherwise, it contains blanks. If the record image has not been minimized in the entry specific data, the Null Value Indicators field is a character string with one character for each field in the physical file that has record images appearing in the journal. Each character has the following interpretation:

- 0 = corresponding field in the record is not NULL.
- 1 = corresponding field in the record is NULL.

If the record image was minimized on field boundaries (MINENTDTA(*FLDBDY), and it has been formatted when reading (FMTMINDTA(*YES)) then each character has the following interpretation:

- 0 = The corresponding field was recorded and is not NULL.
- 1 = The corresponding field was recorded and is NULL.

- 9 = The corresponding field was not recorded and its default value was returned.

System-supplied output files

The following system-supplied output files define the Null Value Indicators and Entry-Specific Data fields as variable-length character fields:

- QSYS/QADSPJR3
- QSYS/QADSPJR4
- QSYS/QADSPJR5

For additional details regarding the *TYPE3, *TYPE4, and *TYPE5 formats and the exact layout of these two fields, see the following commands:

- Display Journal (DSPJRN)
- Receive Journal Entry (RCVJRNE)
- Retrieve journal entry (RTVJRNE)

Layouts for journal entry types

Use the Journal entry information finder to find the layout for the variable-length portion of the journal entry. Some one journal entry types are described in other places than this topic. The Journal entry information finder indicates those journal entries.

Some journal entry types are documented in QSYSINC library includes, as indicated in the Journal code finder. Some entry types do not have entry-specific data.

These layouts include specific values for fields in the fixed-length portion of the entry and the fields in the entry-specific portion of the entry. The offsets show the relative offset within the Entry-specific data field. The beginning position of the Entry-specific data field depends on the format type that you specify. You can also use the Journal entry information finder to see these layouts.

Related reference

[Retrieve Journal Entries \(QjoRetrieveJournalEntries\) API](#)

[Display Journal \(DSPJRN\) command](#)

[Receive Journal Entry \(RCVJRNE\) command](#)

[Retrieve journal entry \(RTVJRNE\) command](#)

Layouts for variable-length portion of journal entries

The following tables contain the variable-length portion of the layouts for journal entries.

Allow use with partial transactions (F MO) journal entry

| Relative offset | Field | Format | Description |
|--|-------------------|-----------|--|
| Entry-specific data. This data appears as one field in the standard output formats: | | | |
| 1 | Reason code | Char (1) | 01 = Partial transactions exist due to restore. 02 = Partial transactions exist because a rollback was ended early. |
| 2 | Reserved | Char (3) | Reserved. Set to zeros. |
| 5 | Number commit IDs | Bin (32) | The number of commit identifiers. |
| 9 | Reserved | Char (72) | Reserved. Set to zeros. |

| Relative offset | Field | Format | Description |
|-----------------|------------|--------------|---|
| 81 | Commit IDs | Bin (64) [*] | The array of commit cycle identifiers for partial transactions that remain in the object. |

APYJRNCHG (B AT, D DD, E EQ, F AY, Q QH, Y YH) and RMVJRNCHG (E EX, F RC) journal entries

| Relative offset | Field | Format | Description |
|--|--|--------------|---|
| Specific values for this entry type: | | | |
| | Count or Relative Record Number (JOCTRR) | Zoned (10,0) | Contains the number of journal entries applied or removed. For *TYPE5 output files, the format of this field is Char (20). |
| | Flag (JOFLAG) | Char (1) | The results of the apply or remove operation: 0 = Command completed normally. 1 = Command completed abnormally. |
| Entry-specific data. This data appears as one field in the standard output formats: | | | |
| 1 | First entry applied or removed | Zoned (10,0) | The sequence number of the first entry actually applied or removed. This field is set to -1 if the actual value is larger than 9 999 999 999. See the First entry applied or removed--large field for the actual value. |
| 11 | Last entry applied or removed. | Zoned (10,0) | The sequence number of the last entry actually applied or removed. This field is set to -1 if the actual value is larger than 9 999 999 999. See the Last entry applied or removed--large field for the actual value. |
| 21 | Starting receiver name | Char (10) | The name of the first receiver from which entries were applied or removed. |
| 31 | Library name | Char (10) | The name of the library for the starting journal receiver. |
| 41 | Ending receiver name | Char (10) | The name of the last or ending receiver from which entries were applied or removed. |
| 51 | Library name | Char (10) | The library for the ending journal receiver. |
| 61 | Starting sequence number | Char (10) | The specified starting sequence number for the apply or remove operation. This field is set to -1 if the actual value is larger than 9 999 999 999. See the Starting sequence number--large field for the actual value. |
| 71 | Ending sequence number | Char (10) | The specified ending sequence number for the apply or remove operation. This field is set to -1 if the actual value is larger than 9 999 999 999. See the Ending sequence number--large field for the actual value. |

| Relative offset | Field | Format | Description |
|-----------------|--|-----------|--|
| 81 | Incomplete commit transaction not applied or removed | Char (1) | <p>0 = Indicates that either CMTBDY(*NO) was specified or CMTBDY(*YES) was specified and no partial commitment control transactions were found in the range specified by the starting and ending sequence numbers</p> <p>1 = Indicates that CMTBDY(*YES) was specified and one or more partial commitment control transactions were found in the range specified by the starting and ending sequence numbers</p> |
| 82 | First entry applied or removed--large | Char (20) | The sequence number of the first entry actually applied or removed. This field always contains a sequence number. |
| 102 | Last entry applied or removed--large | Char (20) | The sequence number of the last entry actually applied or removed. This field always contains a sequence number. |
| 122 | Starting sequence number--large | Char (20) | The specified starting sequence number for the apply or remove operation. This field always contains a sequence number. |
| 142 | Ending sequence number--large | Char (20) | The specified ending sequence number for the apply or remove operation. This field always contains a sequence number. |
| 162 | Number of entries | Char (20) | The number of entries that were applied or removed. |
| 182 | Partial transaction starting sequence number | Char (20) | Starting sequence number for any partial transactions that were removed. For integrated file system objects and data areas, this field is always zero. |
| 202 | Partial transaction ending sequence number | Char (20) | Ending sequence number for any partial transactions that were removed. For integrated file system objects and data areas, this field is always zero. |
| 222 | Number of partial transaction removed | Char (20) | Count of number of entries removed for partial transactions. For integrated file system objects and data areas, this number is always zero. |
| 242 | Object deleted | Char (1) | <p>Indicates that the object was deleted during the apply or remove operation.</p> <p>Y = Yes N = No</p> |
| 243 | Object created | Char (1) | <p>Indicates that the object was created during the apply operation.</p> <p>Y = Yes N = No</p> |

| Relative offset | Field | Format | Description |
|-----------------|------------------------------|----------|---|
| 244 | Early end | Char (1) | Indicates if the apply or remove operation ended early for this object. Y = Yes N = No |
| 245 | Change not made | Char (1) | Indicates that a change was found for this object after an early end to the apply operation. Y = Yes N = No |
| 246 | End reason code | Char (1) | Reason code for early end. See message MCH4801 for the possible values. |
| 247 | End message ID | Char (7) | The message identifier associated with an early end to the apply operation. |
| 254 | Error condition | Bin (31) | The error condition code associated with an early end to the apply operation. |
| 258 | Partial transactions remain | Char (1) | Indicates that partial transactions remain for this object. Y = Yes N = No |
| 259 | Partial transactions removed | Char (1) | Indicates that at least some partial transactions were removed during the apply operation. Y = Yes N = No |

Auditing Change (E ZT, J ZT, Q ZT, Y ZT) journal entries

| Relative offset | Field | Format | Description |
|--|-------------|-----------|--------------------|
| Entry-specific data. This data appears as one field in the standard output formats: | | | |
| 1 | Audit value | Char (10) | Object audit value |

Change authority (E ZA, J ZA, Q ZA, Y ZA) journal entry

| Relative offset | Field | Format | Description |
|---|----------------------------|-----------|--|
| Specific values for this entry type: | | | |
| 1 | User | Char (10) | The user profile or REFUSER on GRTUSRAUT command. |
| 11 | Authorization list | Char (10) | The name of the authorization list name. |
| 21 | Object existence authority | Char (1) | Y = User has *OBJEXIST authority to the object. blank = User does not have *OBJEXIST authority to the object. |

| Relative offset | Field | Format | Description |
|-----------------|---|----------|--|
| 22 | Object management authority | Char (1) | Y = User has *OBJMGT authority to the object. blank = User does not have *OBJMGT authority to the object. |
| 23 | Object operational authority | Char (1) | Y = User has *OBJOPR authority to the object. blank = User does not have *OBJOPR authority to the object. |
| 24 | Authorization list management authority | Char (1) | Blank if user does not have authorization list management authority to the object. |
| 25 | Authorization list *PUBLIC authority | Char (1) | Y = User has *PUBLIC authority to the object. blank = User does not have *PUBLIC authority to the object. |
| 26 | Read authority | Char (1) | Y = User has *READ authority to the object. blank = User does not have *READ authority to the object. |
| 27 | Add authority | Char (1) | Y = User has *ADD authority to the object. blank = User does not have *ADD authority to the object. |
| 28 | Update authority | Char (1) | Y = User has *UPD authority to the object. blank = User does not have *UPD authority to the object. |
| 29 | Delete authority | Char (1) | Y = User has *DLT authority to the object. blank = User does not have *DLT authority to the object. |
| 30 | Exclude authority | Char (1) | Y = User has *EXCLUDE authority to the object. blank = User does not have *EXCLUDE authority to the object. |
| 31 | Execute authority | Char (1) | Y = User has *EXECUTE authority to the object. blank = User does not have *EXECUTE authority to the object. |
| 32 | Object alter authority | Char (1) | Y = User has *OBJALTER authority to the object. blank = User does not have *OBJALTER authority to the object. |
| 33 | Object reference authority | Char (1) | Y = User has *OBJREF authority to the object. blank = User does not have *OBJREF authority to the object. |
| 34 | Reserved | Char (4) | Reserved. |

| Relative offset | Field | Format | Description |
|-----------------|----------------|----------|---|
| 38 | Operation type | Char (3) | Possible values are: GRT = Grant. RPL = Grant with replace. RVK = Revoke. |

Change distribution queues (S CF) journal entry

| <i>Table 2. SNADS entries</i> | | | |
|-------------------------------|--------------------|-------------|--|
| Relative offset | Field | Format | Description |
| 1 | Entry length | Zoned(5,0) | Total length of the journal entry including the entry length field. |
| 6 | Sequence number | Zoned(10,0) | Applied to each journal entry. Initially set to 1 for each new or restored journal. Reset when a new receiver is attached. |
| 16 | Journal code | Char(1) | Always S for QSNADS journal. |
| 17 | Entry type | Char(2) | Always CF for distribution queue change. |
| 19 | Date stamp | Char(6) | The system date that the entry was made. |
| 25 | Time stamp | Zoned(6,0) | The system time that the entry was made. |
| 31 | (Reserved area) | Char(95) | |
| 126 | Job name | Char(10) | The name of the job that caused the entry to occur. |
| 136 | User name | Char(10) | The user profile name associated with the job. |
| 146 | Job number | Zoned(6,0) | The job number. |
| 152 | Distribution queue | Char(16) | The distribution queue that was added, changed, or removed during configuration. |
| 168 | Network identifier | Char(8) | The system name of the remote system to which the distributions are sent. |
| 176 | Remote location | Char(8) | The name of the logical location in an APPN communications route where distributions are sent to a remote system. |
| 184 | Mode | Char(8) | The mode name further qualifies the remote location name. |
| 192 | Queue type | Char(2) | <ul style="list-style-type: none"> • SN = *SNADS • DL = *DLS • RS = *RPDS • SV = *SVDS The default is *NETATR. |
| 194 | Local location | Char(8) | Name used to identify your system to remote systems in the network. |
| 202 | Send queue | Char(1) | Specifies whether, when a SNADS receiver becomes active, a SNADS sender is started on the same connection (Y or N). |
| 203 | (Reserved area) | Char(6) | |

| Relative offset | Field | Format | Description |
|-----------------|---------------------------------|-------------|---|
| 209 | Normal from time | Char(4) | The time specified to start sending distributions from the normal priority queue. |
| 213 | Normal to time | Char(4) | The time specified to stop sending distributions from the normal priority queue. |
| 217 | Normal force time | Char(4) | The time specified to send any distributions from the normal priority queue regardless of the queue depth. |
| 221 | Normal send depth | Char(3) | The queue depth specified to start sending distributions from the normal priority queue when that many distributions are queued. |
| 224 | High from time | Char(4) | The time specified to start sending distributions from the high priority queue. |
| 228 | High to time | Char(4) | The time specified to stop sending distributions from the high priority queue. |
| 232 | High force time | Char(4) | The time specified to send any distributions from the high priority queue regardless of queue depth. |
| 236 | High send depth | Char(3) | The queue depth specified to start sending distributions from the high priority queue when that many distributions are queued. |
| 239 | Function | Char(1) | Function (distribution queue change) that was entered: A A queue was added C A queue was changed D A queue was deleted |
| 240 | Number of tries | Zoned (4,0) | The number of times the system should try to resend the distribution. |
| 244 | Number of minutes between tries | Zoned (4,0) | The elapsed time that should occur between retries. |
| 248 | (Reserved area) | Char(9) | |

| Relative offset | Field | Format | Description |
|-----------------|-----------------|-------------|--|
| 1 | Entry length | Zoned(5,0) | Total length of the journal entry, including the entry length field. |
| 6 | Sequence number | Zoned(10,0) | Applied to each journal entry. Initially set to 1 for each new or restored journal. Reset when a new receiver is attached. |
| 16 | Journal code | Char(1) | Always S for MSF entries. |
| 17 | Entry type | Char(2) | Always CF for MSF configuration change entries. |

Table 3. MSF configuration change entry (continued)

| Relative offset | Field | Format | Description |
|-----------------|---------------------|------------|---|
| 19 | Date stamp | Char(6) | The system date that the entry was made. |
| 25 | Time stamp | Zoned(6,0) | The system time that the entry was made. |
| 31 | (Reserved area) | Char(95) | |
| 126 | Job name | Char(10) | The name of the job that caused the entry to occur. |
| 136 | User name | Char(10) | The user profile name associated with the job. |
| 146 | Job number | Zoned(6,0) | The job number. |
| 152 | Program name | Char(8) | The name of the MSF program that made the journal entry. |
| 160 | Function identifier | Char(1) | <p>Function that was being performed when the entry was made. The possible values are:</p> <p>1 MSF data type configured added to configuration database by QZMFCOPN program. MSF type tables initialized with shipped type definitions.</p> <p>2 Reserved.</p> <p>3 Added configuration to the configuration database. New MSF data type defined by using the QzmfAddMailCfg API.</p> <p>4 Configuration removed from the configuration database. MSF data type removed by using the QzmfRmvMailCfg API.</p> <p>5 Exit program removed from MSF exit point.</p> <p>6 Exit program added to MSF exit point, except QIBM_QZMFMSF_VLD_TYP and QIBM_QZMFMSF_TRK_CHG.</p> <p>7 Exit program added to QIBM_QZMFMSF_VLD_TYP or QIBM_QZMFMSF_TRK_CHG.</p> <p>A Install program started.</p> <p>B Install program ended.</p> <p>C Type not deleted during install.</p> <p>D Type not added during install.</p> <p>E Exit point program not deleted during install.</p> <p>F Exit point program not added during install.</p> |

Table 3. MSF configuration change entry (continued)

| Relative offset | Field | Format | Description |
|-----------------|-------------|------------|--|
| 161 | Data length | Zoned(5,0) | The length of the logged data. |
| 166 | Logged data | Char(256) | The data logged by MSF when the function identifier is: 1 The record for the MSF data type that was added. 3 The record for the MSF data type that was added. 4 The record for the MSF data type that was removed. 5 The information about the MSF exit point program that was removed during install. 6 The information about the MSF exit point program that was added during install. 7 The information about the MSF exit point program that was added during install. C The record for the MSF data type that the install program failed to delete. D The record for the MSF data type that the install program failed to add. E The information about the MSF exit point program that the install program failed to delete. F The information about the MSF exit point program that the install program failed to add. |

Change end of data (F CE) journal entry

| Relative offset | Field | Format | Description |
|---|--|--------------|---|
| Specific values for this entry type: | | | |
| | Count or relative record number (JOCTRR) | Zoned (10,0) | The relative record number of the last record kept in the physical file member. |

Change journaled object attributes (B JA, D DJ, E EK, F JC, Q QF, Y YK) journal entries

| Relative offset | Field | Format | Description |
|--|-------|--------|-------------|
| Entry-specific data. This data appears as one field in the standard output formats: | | | |

| Relative offset | Field | Format | Description |
|--|-------------------------------|--------------------------------------|---|
| 1 | Attribute changed | Char (1) | Identifies which journal attribute was changed: 1 = IMAGES 2 = OMTJRNE 3 = INHERIT 4 = INHRULES 5 = RMTJRNFTTR |
| 2 | New attributes value | Char (10) | The new value for the attribute that changed. The valid values for each attribute are as follows: <ul style="list-style-type: none"> • IMAGES(*BOTH) • IMAGES(*AFTER) • OMTJRNE(*NONE) • OMTJRNE(*OPNCLOSYN) • INHERIT(*YES) • INHERIT(*NO) • RMTJRNFTTR(*YES) • RMTJRNFTTR(*NO) Note: Only the characters in the parenthesis appear in this field. |
| 12 | Displacement to inherit rules | Bin(16) unsigned short integer | Displacement to inheritance rules, 0 if Attribute changed field is not '4'. |
| Offset determined by Displacement to Inherit Rules | Inherit Rules | | See Journal Inherit Rules |

Change library attributes (Y YA) journal entry

| Relative offset | Field | Format | Description |
|--|------------------------|-----------|-----------------|
| Entry-specific data. This data appears as one field in the standard output formats: | | | |
| 1 | Library type | Char (10) | blanks if *SAME |
| 11 | Create authority | Char (10) | blanks if *SAME |
| 21 | Create object auditing | Char (10) | blanks if *SAME |

Change object attribute (E ZB, D ZB, J ZB, Q ZB, Y ZB) journal entry

| Relative offset | Field | Format | Description |
|--|-------------------|---------|--|
| Entry-specific data. This data appears as one field in the standard output formats: | | | |
| 1 | Number of records | Bin (4) | The number of variable length records that follow. |

| Relative offset | Field | Format | Description |
|-----------------|----------------|----------|--|
| 5 | Key | Bin (4) | The field of an object attribute to change. See Change Object Description (QLICOBJD) API . |
| 9 | Length of data | Bin (4) | The length of the data used to change a specific field of an object attribute. |
| 13 | Data | Char (*) | The data used to change a specific field of an object attribute. |

Change primary group (E ZP, J ZP, Q ZP, Y ZP) journal entry

| Relative offset | Field | Format | Description |
|--|-------------------------------|-----------|--|
| Entry-specific data. This data appears as one field in the standard output formats: | | | |
| 1 | Old group | Char (10) | The name of the old primary group. |
| 11 | New group | Char (10) | The name of the new primary group. |
| 21 | Object existence authority | Char (1) | Y = *PUBLIC has *OBJEXIST authority to the object. blank = *PUBLIC does not have *OBJEXIST authority to the object. This field is only used when Authorization list *PUBLIC is blank. |
| 22 | Object management authority | Char (1) | Y = *PUBLIC has *OBJMGT authority to the object. blank = *PUBLIC does not have *OBJMGT authority to the object. This field is only used when Authorization list *PUBLIC is blank. |
| 23 | Object operational authority | Char (1) | Y = *PUBLIC has *OBJOPR authority to the object. blank = *PUBLIC does not have *OBJOPR authority to the object. This field is only used when Authorization list *PUBLIC is blank. |
| 24 | Object alter authority | Char (1) | Y = *PUBLIC has *OBJALTER authority to the object. blank = *PUBLIC does not have *OBJALTER authority to the object. This field is only used when Authorization list *PUBLIC is blank. |
| 25 | Object reference authority | Char (1) | Y = *PUBLIC has *OBJREF authority to the object. blank = *PUBLIC does not have *OBJREF authority to the object. This field is only used when Authorization list *PUBLIC is blank. |
| 26 | Reserved | Char (10) | Reserved. Set to blank. |
| 36 | Authorization list management | Char (1) | Blank if user does not have authorization list management authority to the object. |

| Relative offset | Field | Format | Description |
|-----------------|-------------------|-----------|--|
| 37 | Read authority | Char (1) | Y = *PUBLIC has *READ authority to the object. blank = *PUBLIC does not have *READ authority to the object. This field is only used when Authorization list *PUBLIC is blank. |
| 38 | Add authority | Char (1) | Y = *PUBLIC has *ADD authority to the object. blank = *PUBLIC does not have *ADD authority to the object. This field is only used when Authorization list *PUBLIC is blank. |
| 39 | Update authority | Char (1) | Y = *PUBLIC has *UPD authority to the object. blank = *PUBLIC does not have *UPD authority to the object. This field is only used when Authorization list *PUBLIC is blank. |
| 40 | Delete authority | Char (1) | Y = *PUBLIC has *DLT authority to the object. blank = *PUBLIC does not have *DLT authority to the object. This field is only used when Authorization list *PUBLIC is blank. |
| 41 | Execute authority | Char (1) | Y = *PUBLIC has *EXECUTE authority to the object. blank = *PUBLIC does not have *EXECUTE authority to the object. This field is only used when Authorization list *PUBLIC is blank. |
| 42 | Reserved | Char (10) | Reserved. Set to blank. |
| 52 | Exclude authority | Char (1) | Y = *PUBLIC has *EXCLUDE authority to the object. blank = *PUBLIC does not have *EXCLUDE authority to the object. This field is only used when Authorization list *PUBLIC is blank. |
| 53 | Revoke | Char (1) | Y = The previous primary group authority to the object was revoked. blank = The previous primary group authority to the object was not revoked. |

Change routing table and secondary system name table (S RT) journal entries

| Relative offset | Field | Format | Description |
|-----------------|-----------------|-------------|--|
| 1 | Entry length | Zoned(5,0) | Total length of the journal entry including the entry length field. |
| 6 | Sequence number | Zoned(10,0) | Applied to each journal entry. Initially set to 1 for each new or restored journal. Reset when a new receiver is attached. |
| 16 | Journal code | Char(1) | Always S for QSNADS journal. |

| Relative offset | Field | Format | Description |
|-----------------|------------------------------------|------------|---|
| 17 | Entry type | Char(2) | Always RT for routing or secondary system name table change. |
| 19 | Date stamp | Char(6) | The system date that the entry was made. |
| 25 | Time stamp | Zoned(6,0) | The system time that the entry was made. |
| 31 | (Reserved area) | Char(95) | |
| 126 | Job name | Char(10) | The name of the job that caused the entry to occur. |
| 136 | User name | Char(10) | The user-profile name associated with the job. |
| 146 | Job number | Zoned(6,0) | The job number. |
| 152 | Destination system name | Char(16) | The system name of the destination system that is routed to using this entry. If this entry is a secondary system name table change, this is the name of the secondary system name. |
| 168 | Service priority (see note) | Char(1) | The value that indicates the service level priority value. This is currently used to maintain sequential ordering of service level. The possible values are: X'F0' Fast X'D0' Status X'60' Data high X'20' Data low |
| 169 | Service level (see note) | Char(8) | The service level for which the entry was made. When a routing table entry is added or changed, one entry will be made for each service level. The possible values are: FAST Fast STATUS Status DATAHIGH Data high DATALOW Data low |
| 177 | Distribution queue name (see note) | Char(16) | The name of the distribution queue used to forward distributions to the destination system using the service level specified by this routing table entry. |
| 193 | Hop count (see note) | Zoned(4,0) | The hop count specified to be assigned to an originating distribution. If this value is *DFT, then the current system default hop count at the time of the distribution is used. |
| 197 | Description | Char(50) | Text description of this routing or secondary system name table entry. |

| Relative offset | Field | Format | Description |
|-----------------|-----------------|----------|---|
| 247 | Table | Char(1) | The table that was changed when this entry was made. S Secondary system name table R Routing table |
| 248 | Function | Char(1) | Function (routing or secondary system name table change) that was entered: A An entry was added C An entry was changed D An entry was deleted |
| 249 | (Reserved area) | Char(25) | |

CHGJRN (J NR, J PR) journal entries

| Relative offset | Field | Format | Description |
|--|--|--------------|---|
| Specific values for this entry type: | | | |
| | Count or relative record number (JOCTRR) | Zoned (10,0) | Contains the number of receivers attached or detached. |
| Entry-specific data. This data appears as one field in the standard output formats: | | | |
| 1 | First receiver name | Char (10) | The name of the first receiver that is attached or detached. |
| 11 | First receiver library name | Char (10) | The name of the library for the first receiver that is attached or detached. |
| 21 | Dual receiver name | Char (10) | The name of the dual receiver that is attached or detached. Blank if only one receiver is used for the journal. |
| 31 | Dual receiver library name | Char (10) | The name of the library for the dual receiver that is attached or detached. Blank if only one receiver is used for the journal. |

COMMIT (C CM) journal entry

| Relative offset | Field | Format | Description |
|---|--|--------------|---|
| Specific values for this entry type: | | | |
| | Count or relative record number (JOCTRR) | Zoned (10,0) | Contains the length of the commit identification. |

| Relative offset | Field | Format | Description |
|--|---------------|----------|---|
| | Flag (JOFLAG) | Char (1) | Whether the commit operation was initiated by the system or the user: 0 = All record-level changes were committed for a commit operation initiated by a user. 2 = All record-level changes were committed for a commit operation initiated by the operating system. 3 = All changes were committed for a commit operation initiated by a user but the commit was not durable. 4 = All changes were committed for a commit operation initiated by the operating system but the commit was not durable. |
| Entry-specific data. This data appears as one field in the standard output formats: | | | |
| 1 | Commit ID | Char (*) | Contains the commit identification specified by the operation. The Count field specifies the length of this field. |

Completed distributions (S LG) journal entry

| <i>Table 4. SNADS entries</i> | | | |
|-------------------------------|--------------------------|-------------|---|
| Relative offset | Field | Format | Description |
| 1 | Entry length | Zoned(5,0) | Total length of the journal entry including the entry length field. |
| 6 | Sequence number | Zoned(10,0) | Applied to each journal entry. Initially set to 1 for each new or restored journal. Reset when a new receiver is attached. |
| 16 | Journal code | Char(1) | Always S for QSNADS journals |
| 17 | Entry type | Char(2) | Always LG for SNADS distributions entered. |
| 19 | Date stamp | Char(6) | The system date that the entry was made. |
| 25 | Time stamp | Zoned(6,0) | The system time that the entry was made. |
| 31 | (Reserved area) | Char(95) | |
| 126 | Program name | Char(8) | The name of the program that made the journal entry. |
| 134 | Job name | Char(10) | The name of the job that caused the entry to occur. |
| 144 | User name | Char(10) | The user-profile name associated with the job. |
| 154 | Job number | Zoned(6,0) | The job number. |
| 160 | Origin system name/group | Char(16) | The system name/group of the system that the distribution originated on. |
| 176 | Origin user ID/address | Char(16) | The user ID/address that originated the distribution. This is not set if the distribution is a status distribution caused by a SNADS error. |
| 192 | Sequence number | Zoned(4,0) | The sequence number of the distribution entry. This is 0000 if the distribution is a status distribution. |

Table 4. SNADS entries (continued)

| Relative offset | Field | Format | Description |
|-----------------|-----------------------|----------|--|
| 196 | Date/time stamp | Char(8) | A representation of the date and time of origin of the distribution. |
| 204 | Correlation ID | Char(44) | The correlation ID of the distribution. |
| 248 | Prefix correlation ID | Char(16) | The prefix correlation ID of the distribution. |
| 264 | Priority | Char(1) | The priority of the queue that the distribution is on (N for normal or P for high queue). Not used if function is X'01'. |
| 265 | Destination TP Name | Char(64) | The destination transaction program name of the distribution entered. X'20F0F0F0' Personal Services/Office X'30F0F0F2' Object Distribution X'23F0F0F0' SNA/MS Change Management |

Table 4. SNADS entries (continued)

| Relative offset | Field | Format | Description |
|-----------------|----------------------|--------------|---|
| 329 | Function | Char(1) | <p>Function that was being performed when the error entry was made. The possible values are:</p> <p>X'01' SNADS router</p> <p>X'02' SNADS sender</p> <p>X'03' SNADS receiver</p> <p>X'04' SNADS remove entry (DSPDSTSTS)</p> <p>X'05' SNADS reroute queue (DSPDSTSTS)</p> <p>X'06' SNADS reroute entry (DSPDSTSTS)</p> <p>X'07' SNADS gateway queue entry dequeued</p> <p>X'08' SNADS gateway entry received</p> <p>X'09' VM/MVS bridge outbound transform completed</p> <p>X'0A' VM/MVS bridge inbound transform completed</p> <p>X'0B' SNADS originator</p> <p>X'0C' SNADS receiver of local distributions</p> <p>X'0D' SNADS distribution queue cleared</p> <p>X'0E' SNADS distribution queue initialized</p> <p>X'0F' SNADS distribution queue removed</p> |
| 330 | Number of recipients | Zoned(5,0) | The number of recipients for the distribution. This is set only when function is equal to X'01' (SNADS router). |
| 335 | Number of errors | Zoned(5,0) | The number of recipients that resulted in errors for the distribution. This is set only when function is equal to X'01' (SNADS router). There should be an ER type entry in the QSNADS journal for every recipient that caused an error during routing. |
| 340 | Send size | Char(4) | The total number of bytes sent when the distribution was sent to another system. The number has a 4-byte, unsigned binary format. |
| 344 | Queue name | Char(17) | The distribution queue name. |
| 361 | Send size packed | Packed(15,0) | |

| <i>Table 4. SNADS entries (continued)</i> | | | |
|---|------------------------------|---------------|---|
| Relative offset | Field | Format | Description |
| 376 | Distribution type | Char(1) | The distribution type of the distribution being sent. 'F2'X SVDS distributions '40'X or 'F1'X All other distributions |
| 377 | Extension offset | Char(2) | The offset to the log entry extension. The number has a 2-byte, signed format. |
| 379 | Internal sequence number | Char(4) | The internal sequence number of the distribution entry. This number applies only to *SVDS distributions. The number has a 4-byte, signed binary format. |
| 383 | Message unit ID | Char(4) | The message unit ID assigned by the transport layer to *SVDS distributions. The number has a 4-byte, signed binary format. |
| 387 | Message unit instance number | Char(2) | The instance number assigned by the transport layer to *SVDS distributions only. The number has a 2-byte, signed binary format. |
| 389 | Number of logged recipients | Zoned(5,0) | The number of recipients that are logged (up to 10). |
| 394 | (Reserved area) | Char(320) | |

| <i>Table 5. MSF Message entries</i> | | | |
|-------------------------------------|-----------------|---------------|--|
| Relative offset | Field | Format | Description |
| 1 | Entry length | Zoned(5,0) | Total length of the journal entry, including the entry length field. |
| 6 | Sequence number | Zoned(10,0) | Applied to each journal entry. Initially set to 1 for each new or restored journal. Reset when a new receiver is attached. |
| 16 | Journal code | Char(1) | Always S for MSF entries. |
| 17 | Entry type | Char(2) | Always LG for MSF message entries. |
| 19 | Date stamp | Char(6) | The system date that the entry was made. |
| 25 | Time stamp | Zoned(6,0) | The system time that the entry was made. |
| 31 | (Reserved area) | Char(95) | |
| 126 | Job name | Char(10) | The name of the job that caused the entry to occur. |
| 136 | User name | Char(10) | The user profile name associated with the job. |
| 142 | Job number | Zoned(6,0) | The job number. |
| 150 | Program name | Char(8) | The name of the MSF program that made the journal entry. |

Table 5. MSF Message entries (continued)

| Relative offset | Field | Format | Description |
|-----------------|----------------------|------------|---|
| 158 | Function identifier | Char(1) | Function that was being performed when the entry was made. The possible values are: 1 MSF message created log entry 2 MSF message ended normally 3 MSF message reset by STRMSF command (STRMSF MSGOPT (*RESET)) 4 MSF message removed by STRMSF command (STRMSF MSGOPT (*CLEAR)) 5 MSF message acted on by address switcher |
| 159 | MSF message ID | Char(32) | The MSF message ID logged. |
| 191 | Length of entry data | Zoned(5,0) | The length of the logged data. |
| 196 | Logged data | Char(256) | The data logged by MSF when the function identifier is: 2 Data is three Zoned(5,0) numbers. The first number is the number of entries in the recipient list when the message was created. The second number is the number of entries in the recipient list when processing was completed for the message. The third number is the number of recipients that had a non-deliverable status when processing was completed for the message. 5 Data is two Zoned(5,0) numbers. The first number is the number of recipients that had their address switched by program QZMFSNPA. The second number is the total number of recipients that were in the recipient list of the MSF message processed by QZMFSNPA. |

Create data area (E EE) journal entry

| Relative offset | Field | Format | Description |
|--|-----------------------------|-----------|--|
| Entry-specific data. This data appears as one field in the standard output formats: | | | |
| 1 | Create time of day and date | Char (8) | The date and timestamp when the data area was created. |
| 9 | Data area name | Char (10) | The data area name. |
| 19 | Data area library name | Char (10) | The data area library name. |

| Relative offset | Field | Format | Description |
|-----------------|-------------------------------|-------------|---|
| 29 | Data area type | Char (5) | The created data area type. The valid types are: <ul style="list-style-type: none"> *CHAR - character *DEC - decimal *LOG - logical |
| 34 | Reserved | Char (3) | The filler to maintain alignment. |
| 37 | Number of elements | Bin (32) | The number of elements. If the type is *CHAR or *LGL, only Length will contain a value. If the type is *DEC, both Length and Fraction length will contain values. |
| 41 | Length | Bin (32) | The declared length. |
| 45 | Fraction length | Bin (32) | The decimal positions. |
| 49 | Actual value length | Bin (32) | The length of entered data as seen by the user. |
| 53 | Value | Char (2000) | The data or value. |
| 2053 | Public authority | Char (10) | The public authority. The valid authorities are: <ul style="list-style-type: none"> *LIBCRTAUT *CHANGE *ALL *EXCLUDE *NAME |
| 2063 | Text description | Text (50) | The description or text. |
| 2113 | Owner | Char (10) | Object owner. |
| 2123 | Object existence authority | Char (1) | Y = *PUBLIC has *OBJEXIST authority to the object. blank = *PUBLIC does not have *OBJEXIST authority to the object. |
| 2124 | Object management authority | Char (1) | Y = *PUBLIC has *OBJMGT authority to the object. blank = *PUBLIC does not have *OBJMGT authority to the object. |
| 2125 | Object operational authority | Char (1) | Y = *PUBLIC has *OBJOPR authority to the object. blank = *PUBLIC does not have *OBJOPR authority to the object. |
| 2126 | Reserved | Char (4) | Reserved. Set to blank. |
| 2130 | Authorization list management | Char (1) | Y = Object is secured by an authorization list. The authorization list name can be found in the Resulting authority field later in this journal entry. blank = Object is not secured by an authorization list. |

| Relative offset | Field | Format | Description |
|-----------------|----------------------------|----------|--|
| 2131 | Read authority | Char (1) | Y = *PUBLIC has *READ authority to the object. blank = *PUBLIC does not have *READ authority to the object. |
| 2132 | Add authority | Char (1) | Y = *PUBLIC has *ADD authority to the object. blank = *PUBLIC does not have *ADD authority to the object. |
| 2133 | Update authority | Char (1) | Y = *PUBLIC has *UPD authority to the object. blank = *PUBLIC does not have *UPD authority to the object. |
| 2134 | Delete authority | Char (1) | Y = *PUBLIC has *DLT authority to the object. blank = *PUBLIC does not have *DLT authority to the object. |
| 2135 | Exclude authority | Char (1) | Y = *PUBLIC has no authority to the object. blank = *PUBLIC has authority to the object. |
| 2136 | Execute authority | Char (1) | Y = *PUBLIC has *EXECUTE authority to the object. blank = *PUBLIC does not have *EXECUTE authority to the object. |
| 2137 | Object alter authority | Char (1) | Y = *PUBLIC has *OBJALTER authority to the object. blank = *PUBLIC does not have *OBJALTER authority to the object. |
| 2138 | Object reference authority | Char (1) | Y = *PUBLIC has *OBJREF authority to the object. blank = *PUBLIC does not have *OBJREF authority to the object. |

| Relative offset | Field | Format | Description |
|--|------------------------------|-----------|--|
| 2139 | Resulting authority | Char (10) | <p>The public authority resulting from the processing of the Create Data Area (CRTDTAARA) command. The value can be *CHANGE, *ALL, *USE, *EXCLUDE, or an authorization list name if the Authorization list management field in this journal entry is Y.</p> <p>For example, if *LIBCRTAUT was specified for the AUTHORITY keyword on the CRTDTAARA command, the value *LIBCRTAUT would be in the Public authority field and a value such as *USE could be found in this Resulting authority field. And the *USE value in this field could be specified for the AUTHORITY keyword on a subsequent CRTDTAARA command.</p> <p>If an error occurred, this field could be blank or a value that could not be specified for the AUTHORITY keyword on the CRTDTAARA command.</p> |
| 2149 | Reserved | Char(2) | |
| The following authority fields pertain to the object owner's authority for the data area associated with this journal entry. | | | |
| 2151 | Object existence authority | Char(1) | <p>Y = Object owner has *OBJEXIST authority to the object. blank = Object owner does not have *OBJEXIST authority to the object.</p> |
| 2152 | Object management authority | Char (1) | <p>Y = Object owner has *OBJMGT authority to the object. blank = Object owner does not have *OBJMGT authority to the object.</p> |
| 2153 | Object operational authority | Char (1) | <p>Y = Object owner has *OBJOPR authority to the object. blank = Object owner does not have *OBJOPR authority to the object.</p> |
| 2154 | Reserved | Char (2) | |
| 2156 | Read authority | Char (1) | <p>Y = Object owner has *READ authority to the object. blank = Object owner does not have *READ authority to the object.</p> |
| 2157 | Add authority | Char (1) | <p>Y = Object owner has *ADD authority to the object. blank = *Object owner does not have *ADD authority to the object.</p> |

| Relative offset | Field | Format | Description |
|---|------------------------------|-----------|--|
| 2158 | Update authority | Char (1) | Y = Object owner has *UPD authority to the object. blank = Object owner does not have *UPD authority to the object. |
| 2159 | Delete authority | Char (1) | Y = Object owner has *DLT authority to the object. blank = Object owner does not have *DLT authority to the object. |
| 2160 | Exclude authority | Char (1) | Y = Object owner has no authority to the object. blank = Object owner has authority to the object. |
| 2161 | Execute authority | Char (1) | Y = Object owner has *EXECUTE authority to the object. blank = Object owner does not have *EXECUTE authority to the object. |
| 2162 | Object alter authority | Char (1) | Y = Object owner has *OBJALTER authority to the object. blank = Object owner does not have *OBJALTER authority to the object. |
| 2163 | Object reference authority | Char (1) | Y = Object owner has *OBJREF authority to the object. blank = Object owner does not have *OBJREF authority to the object. |
| 2164 | Reserved | Char(2) | |
| The following authority fields pertain to the primary group's authority for the data area associated with this journal entry. If the primary group is *NONE the following authority fields will be blank. | | | |
| 2166 | Primary group | Char (10) | This will be *NONE if there is no primary group associated with the object. |
| 2167 | Object existence authority | Char(1) | Y = Object primary group has *OBJEXIST authority to the object. blank = Object primary group does not have *OBJEXIST authority to the object. |
| 2168 | Object management authority | Char (1) | Y = Object primary group has *OBJMGT authority to the object. blank = Object primary group does not have *OBJMGT authority to the object. |
| 2169 | Object operational authority | Char (1) | Y = Object primary group has *OBJOPR authority to the object. blank = Object primary group does not have *OBJOPR authority to the object. |
| 2170 | Reserved | Char (2) | |

| Relative offset | Field | Format | Description |
|--|----------------------------|-----------|--|
| 2172 | Read authority | Char (1) | Y = Object primary group has *READ authority to the object. blank = Object primary group does not have *READ authority to the object. |
| 2173 | Add authority | Char (1) | Y = Object primary group has *ADD authority to the object. blank = *Object primary group does not have *ADD authority to the object. |
| 2174 | Update authority | Char (1) | Y = Object primary group has *UPD authority to the object. blank = Object primary group does not have *UPD authority to the object. |
| 2175 | Delete authority | Char (1) | Y = Object primary group has *DLT authority to the object. blank = Object primary group does not have *DLT authority to the object. |
| 2176 | Exclude authority | Char (1) | Y = Object primary group has no authority to the object. blank = Object primary group has authority to the object. |
| 2177 | Execute authority | Char (1) | Y = Object primary group has *EXECUTE authority to the object. blank = Object primary group does not have *EXECUTE authority to the object. |
| 2178 | Object alter authority | Char (1) | Y = Object primary group has *OBJALTER authority to the object. blank = Object primary group does not have *OBJALTER authority to the object. |
| 2179 | Object reference authority | Char (1) | Y = Object primary group has *OBJREF authority to the object. blank = Object primary group does not have *OBJREF authority to the object. |
| 2180 | Reserved | Char(2) | |
| The following fields are used when replaying an E EE (create) journal entry. If the journal ID and name/library are not available in the entry-specific data when an entry is replayed, then the object would be created but journaling would not automatically be started for the object. | | | |
| 2182 | Journal identifier (JOJID) | Char (10) | Journal identifier for the data area associated with this journal entry. |
| 2192 | Journal name | Char (10) | The journal name. |
| 2202 | Journal library | Char (10) | The journal library. |

| Relative offset | Field | Format | Description |
|-----------------|-----------------------|----------|---|
| 2203 | Images | Char (1) | Images value that the data area received when it started journaling '0' - *AFTER '1' - *BOTH |
| 2204 | Remote journal filter | Char (1) | Remote journal filter value that the data area received when it started journaling '0' - *NO '1' - *YES |

Create data queue (Q QA) journal entry

| Relative offset | Field | Format | Description |
|--|-----------------------------|-----------|---|
| Entry-specific data. This data appears as one field in the standard output formats: | | | |
| 1 | Create time of day and date | Char (8) | The date and timestamp when the data queue was created. |
| 9 | Data queue name | Char (10) | The data queue name. |
| 19 | Data queue library | Char (10) | The library containing the data queue. |
| 29 | Maximum entry length | Bin (32) | Maximum entry length. Possible values are 1 through 64512. |
| 33 | Force auxiliary storage | Char (1) | Force queue to auxiliary storage on send and receive: N = Force is not done Y = Force is done |
| 34 | Reserved | Char (8) | Reserved. |
| 42 | Sequence | Char (1) | Sequence in which entries are received from the data queue: F = FIFO queue K = Keyed queue L = LIFO queue |
| 43 | Key length | Bin (16) | Key length of a keyed queue. Possible values are 1 through 256. |
| 45 | Include sender ID | Char (1) | Attach a sender ID to each entry sent to the queue: N = Do not include ID Y = Include ID |
| 46 | Queue type | Char (1) | Type of data queue: S = Standard data queue Note: DDM data queues cannot be journaled |
| 47 | Reserved | Bin (32) | Reserved. This field is set to zero. |

| Relative offset | Field | Format | Description |
|-----------------|-------------------------------|------------|---|
| 51 | Queue size maximum entries | Bin (32) | The maximum number of entries to allow: -1 = *MAX16MB -2 = *MAX2GB |
| 55 | Queue size initial entries | Bin (32) | Initial number of entries to allocate. Note: The default on the CRTDTAQ command is 16. |
| 59 | Automatic reclaim | Char (1) | The settings for this field are: 0 = no storage released 1 = storage is released |
| 60 | Reserved | Char (481) | Reserved. This field is set to zero. |
| 541 | Public authority | Char (10) | The public authority to the data queue. |
| 551 | Text | Char (50) | Text description. |
| 601 | Owner | Char (10) | Object owner. |
| 611 | Object existence authority | Char (1) | Y = *PUBLIC has *OBJEXIST authority to the object. blank = *PUBLIC does not have *OBJEXIST authority to the object. |
| 612 | Object management authority | Char (1) | Y = *PUBLIC has *OBJMGT authority to the object. blank = *PUBLIC does not have *OBJMGT authority to the object. |
| 613 | Object operational authority | Char (1) | Y = *PUBLIC has *OBJOPR authority to the object. blank = *PUBLIC does not have *OBJOPR authority to the object. |
| 614 | Reserved | Char (4) | Reserved. Set to blank. |
| 618 | Authorization list management | Char (1) | Y = Object is secured by an authorization list. The authorization list name can be found in the Resulting authority field later in this journal entry. blank = Object is not secured by an authorization list. |
| 619 | Read authority | Char (1) | Y = *PUBLIC has *READ authority to the object. blank = *PUBLIC does not have *READ authority to the object. |
| 620 | Add authority | Char (1) | Y = *PUBLIC has *ADD authority to the object. blank = *PUBLIC does not have *ADD authority to the object. |

| Relative offset | Field | Format | Description |
|--|----------------------------|-----------|---|
| 621 | Update authority | Char (1) | Y = *PUBLIC has *UPD authority to the object. blank = *PUBLIC does not have *UPD authority to the object. |
| 622 | Delete authority | Char (1) | Y = *PUBLIC has *DLT authority to the object. blank = *PUBLIC does not have *DLT authority to the object. |
| 623 | Exclude authority | Char (1) | Y = *PUBLIC has no authority to the object. blank = *PUBLIC has authority to the object. |
| 624 | Execute authority | Char (1) | Y = *PUBLIC has *EXECUTE authority to the object. blank = *PUBLIC does not have *EXECUTE authority to the object. |
| 625 | Object alter authority | Char (1) | Y = *PUBLIC has *OBJALTER authority to the object. blank = *PUBLIC does not have *OBJALTER authority to the object. |
| 626 | Object reference authority | Char (1) | Y = *PUBLIC has *OBJREF authority to the object. blank = *PUBLIC does not have *OBJREF authority to the object. |
| 627 | Resulting authority | Char (10) | The public authority resulting from the processing of the Create Data Queue (CRTDTAQ) command. The value can be *CHANGE, *ALL, *USE, *EXCLUDE, or an authorization list name if the Authorization list management field in this journal entry is Y . For example, if *LIBCRTAUT was specified for the AUTHORITY keyword on the CRTDTAQ command, the value *LIBCRTAUT would be in the Public authority field and a value such as *USE could be found in this Resulting authority field. And the *USE value in this field could be specified for the AUTHORITY keyword on a subsequent CRTDTAQ command. If an error occurred, this field could be blank or a value that could not be specified for the AUTHORITY keyword on the CRTDTAQ command. |
| The following authority fields pertain to the object owner's authority for the data area associated with this journal entry. | | | |
| 2151 | Object existence authority | Char(1) | Y = Object owner has *OBJEXIST authority to the object. blank = Object owner does not have *OBJEXIST authority to the object. |

| Relative offset | Field | Format | Description |
|-----------------|------------------------------|----------|--|
| 2152 | Object management authority | Char (1) | Y = Object owner has *OBJMGT authority to the object. blank = Object owner does not have *OBJMGT authority to the object. |
| 2153 | Object operational authority | Char (1) | Y = Object owner has *OBJOPR authority to the object. blank = Object owner does not have *OBJOPR authority to the object. |
| 2154 | Reserved | Char (2) | |
| 2156 | Read authority | Char (1) | Y = Object owner has *READ authority to the object. blank = Object owner does not have *READ authority to the object. |
| 2157 | Add authority | Char (1) | Y = Object owner has *ADD authority to the object. blank = *Object owner does not have *ADD authority to the object. |
| 2158 | Update authority | Char (1) | Y = Object owner has *UPD authority to the object. blank = Object owner does not have *UPD authority to the object. |
| 2159 | Delete authority | Char (1) | Y = Object owner has *DLT authority to the object. blank = Object owner does not have *DLT authority to the object. |
| 2160 | Exclude authority | Char (1) | Y = Object owner has no authority to the object. blank = Object owner has authority to the object. |
| 2161 | Execute authority | Char (1) | Y = Object owner has *EXECUTE authority to the object. blank = Object owner does not have *EXECUTE authority to the object. |
| 2162 | Object alter authority | Char (1) | Y = Object owner has *OBJALTER authority to the object. blank = Object owner does not have *OBJALTER authority to the object. |
| 2163 | Object reference authority | Char (1) | Y = Object owner has *OBJREF authority to the object. blank = Object owner does not have *OBJREF authority to the object. |
| 2164 | Reserved | Char(2) | |

| Relative offset | Field | Format | Description |
|---|------------------------------|-----------|--|
| The following authority fields pertain to the primary group's authority for the data area associated with this journal entry. If the primary group is *NONE the following authority fields will be blank. | | | |
| 2166 | Primary group | Char (10) | This will be *NONE if there is no primary group associated with the object. |
| 2167 | Object existence authority | Char(1) | Y = Object primary group has *OBJEXIST authority to the object. blank = Object primary group does not have *OBJEXIST authority to the object. |
| 2168 | Object management authority | Char (1) | Y = Object primary group has *OBJMGT authority to the object. blank = Object primary group does not have *OBJMGT authority to the object. |
| 2169 | Object operational authority | Char (1) | Y = Object primary group has *OBJOPR authority to the object. blank = Object primary group does not have *OBJOPR authority to the object. |
| 2170 | Reserved | Char (2) | |
| 2172 | Read authority | Char (1) | Y = Object primary group has *READ authority to the object. blank = Object primary group does not have *READ authority to the object. |
| 2173 | Add authority | Char (1) | Y = Object primary group has *ADD authority to the object. blank = *Object primary group does not have *ADD authority to the object. |
| 2174 | Update authority | Char (1) | Y = Object primary group has *UPD authority to the object. blank = Object primary group does not have *UPD authority to the object. |
| 2175 | Delete authority | Char (1) | Y = Object primary group has *DLT authority to the object. blank = Object primary group does not have *DLT authority to the object. |
| 2176 | Exclude authority | Char (1) | Y = Object primary group has no authority to the object. blank = Object primary group has authority to the object. |
| 2177 | Execute authority | Char (1) | Y = Object primary group has *EXECUTE authority to the object. blank = Object primary group does not have *EXECUTE authority to the object. |

| Relative offset | Field | Format | Description |
|---|----------------------------|-----------|--|
| 2178 | Object alter authority | Char (1) | Y = Object primary group has *OBJALTER authority to the object. blank = Object primary group does not have *OBJALTER authority to the object. |
| 2179 | Object reference authority | Char (1) | Y = Object primary group has *OBJREF authority to the object. blank = Object primary group does not have *OBJREF authority to the object. |
| 2180 | Reserved | Char(2) | |
| The following fields are used when replaying a Q QA (create) journal entry. If the journal ID and name/library are not available in the entry-specific data when an entry is replayed, then the object would be created but journaling would not automatically be started for the object. | | | |
| 2182 | Journal identifier (JOJID) | Char (10) | Journal identifier for the data area associated with this journal entry. |
| 2192 | Journal name | Char (10) | The journal name. |
| 2202 | Journal library | Char (10) | The journal library. |
| 2212 | Remote journal filter | Char (1) | Remote journal filter value that the data area received when it started journaling '0' - *NO '1' - *YES |

Data queue attributes changed (Q QG) journal entry

| Relative offset | Field | Format | Description |
|--|--------------------------|---------|---|
| Entry-specific data. This data appears as one field in the standard output formats: | | | |
| 1 | Enforce data queue locks | Char(1) | Identifies whether IBM-supplied data queue operations will enforce a lock on the data queue. Possible values are: '0' = Data queue changed to ignore locks '1' = Data queue changed to enforce locks ' ' = Attribute was not changed |
| 2 | Automatic reclaim | Char(1) | Identifies whether allocated storage is automatically reclaimed (released) when the queue is empty: '0' = No storage released '1' = Storage is released ' ' = Attribute was not changed |

Data queue cleared, has key (Q QJ) journal entry

| Relative offset | Field | Format | Description |
|--|-------|--------|-------------|
| Entry-specific data. This data appears as one field in the standard output formats: | | | |

| Relative offset | Field | Format | Description |
|-----------------|------------|----------|---|
| 1 | Reserved | Char (2) | Reserved for future use. |
| 3 | Key length | Bin (16) | The number of characters in the key. |
| 5 | Key order | Char (2) | The Key order is as follows: GT = Greater than LT = Less than NE = Not equal EQ = Equal GE = Greater than or equal LE = Less than or equal |
| 7 | Key | Char (*) | The data to be used to remove a message from the data queue. |

Delete access path (F PD) journal entry

| Relative offset | Field | Format | Description |
|---|----------------------------|-----------|--|
| Specific values for this entry type: | | | |
| | Journal identifier (JOJID) | Char (10) | The JID is not provided with the *TYPE1, *TYPE2, and *TYPE3 formats. It can be used with the QJORJIDI API. |

Delete receiver (J RD, J RF) journal entries

| Relative offset | Field | Format | Description |
|---|----------------------------|-----------|--|
| Specific values for this entry type: | | | |
| | Journal identifier (JOJID) | Char (10) | The JID is not provided with the *TYPE1, *TYPE2, and *TYPE3 formats. It can be used with the QJORJIDI API. |

Database file OPEN (F OP) and database file CLOSE (F CL) journal entries

| Relative offset | Field | Format | Description |
|--|--------------|-----------|---|
| Entry-specific data. This data appears as one field in the standard output formats. | | | |
| 1 | File name | Char (10) | The name of the file that was opened or closed. If a physical file is opened, this field and the JOOBJ field are the same. If a logical file is opened, this field contains the name of the logical file. JOOBJ field contains the name of the physical file. |
| 11 | Library name | Char (10) | The library containing the file. |

| Relative offset | Field | Format | Description |
|-----------------|--------------|-----------|--|
| 21 | Member name | Char (10) | The file member that was opened or closed. |
| 31 | Open options | Char (4) | Only used for file open (entry type OP). Values of the bytes follow: |
| 31 | Input | Char (1) | Whether the file was opened for input: I = File opened for input blank = Input not specified |
| 32 | Output | Char (1) | Whether the file was opened for output: O = File opened for output blank = Output not specified |
| 33 | Update | Char (1) | Whether the file was opened for update: U = File opened for update blank = Update not specified |
| 34 | Delete | Char (1) | Indicates if the file was opened for delete: D = File opened for delete blank = Delete not specified |

Distribution errors (S ER) journal entry

| <i>Table 6. SNADS entries</i> | | | |
|-------------------------------|--------------------------|-------------|---|
| Relative offset | Field | Format | Description |
| 1 | Entry length | Zoned(5,0) | Total length of the journal entry including the entry length field. |
| 6 | Sequence number | Zoned(10,0) | Applied to each journal entry. Initially set to 1 for each new or restored journal. Reset when a new receiver is attached. |
| 16 | Journal code | Char(1) | Always S for QSNADS journal. |
| 17 | Entry type | Char(2) | Always ER for SNADS errors entered. |
| 19 | Date stamp | Char(6) | The system date that the entry was made. |
| 25 | Time stamp | Zoned(6,0) | The system time that the entry was made. |
| 31 | (Reserved area) | Char(95) | |
| 126 | Job name | Char(10) | The name of the job that caused the entry to occur. |
| 136 | User name | Char(10) | The user-profile name associated with the job. |
| 146 | Job number | Zoned(6,0) | The job number. |
| 152 | Origin system name/group | Char(16) | The system name/group of the system that the distribution originated on. |
| 168 | Origin user ID/address | Char(16) | The user ID/address of the user that originated the distribution. This is not set if the distribution is a status distribution caused by a SNADS error. |

Table 6. SNADS entries (continued)

| Relative offset | Field | Format | Description |
|-----------------|-----------------------|------------|--|
| 184 | Sequence number | Zoned(4,0) | The sequence number of the distribution entered. This is 0000 if the distribution is a status distribution. |
| 188 | Date/time stamp | Char(8) | A representation of the date and time of origin of the distribution. |
| 196 | Correlation ID | Char(44) | The correlation ID of the distribution. |
| 200 | Prefix correlation ID | Char(16) | The prefix correlation ID of the distribution. |
| 216 | Error queue | Char(17) | The SNADS queue that the distribution was on when the error occurred. |
| 233 | Exception class | Char(1) | <p>Class of the exception that occurred.</p> <p>Note: Applies only to errors entered by SNADS sender and receiver jobs.</p> <p>The possible values are:</p> <p>X'C2' Syntax error</p> <p>X'C3' Semantic error</p> <p>X'C4' Process error</p> <p>X'C5' Catastrophic sender error</p> |

Table 6. SNADS entries (continued)

| Relative offset | Field | Format | Description |
|-----------------|----------------|---------|---|
| 234 | Condition code | Char(1) | <p>Code that provides additional qualification pertaining to the exception class. These apply only to errors entered by SNADS sender and receiver jobs. The possible values are:</p> <p>X'01' Function not supported</p> <p>X'02' Data not supported</p> <p>X'04' Resource not available</p> <p>X'06' Processing stopped</p> <p>X'07' Data not found</p> <p>X'08' Segmentation error</p> <p>X'0A' Sequence error</p> <p>X'0B' I/O error</p> <p>X'0C' ID not valid</p> <p>X'0E' Format not valid</p> <p>X'0F' Length not valid</p> <p>X'10' Indicator not valid</p> <p>X'11' Range exceeded</p> <p>X'15' Subfield length not valid</p> <p>X'16' Subfield length type not valid</p> <p>X'17' Parameters not valid</p> <p>X'18' Content error</p> |

Table 6. SNADS entries (continued)

| Relative offset | Field | Format | Description |
|-----------------|------------------|---------|---|
| 235 | Exception object | Char(1) | <p>Code that indicates what part of a DIU was being sent or received when the error that is entered occurred.</p> <p>Note: Applies only to errors entered by SNADS sender and receiver jobs.</p> <p>The possible values are:</p> <p>X'01' Prefix</p> <p>X'02' IU identifier</p> <p>X'07' Command</p> <p>X'08' Command operand</p> <p>X'09' Operand value</p> <p>X'13' Suffix</p> <p>X'14' Segment</p> <p>X'16' Unsupported subfield</p> <p>X'17' Unknown subfield</p> <p>X'1A' Data object prefix</p> <p>X'1B' Data object data</p> |

Table 6. SNADS entries (continued)

| Relative offset | Field | Format | Description |
|-----------------|------------------------|---------|--|
| 236 | Status condition codes | Char(2) | <p>These condition codes identify errors that occur during the handling of a distribution.</p> <p>(Hex) Code Condition</p> <p>X'01' The distribution could not be routed through the network.</p> <p>X'02' A distribution contained a destination user ID that was not valid.</p> <p>X'03' A distribution was canceled because it attempted to pass through more systems than specified by the hop count.</p> <p>X'04' An error was detected in the format of the DIU used to transmit information on the APPC session.</p> <p>X'05' The distribution requested a function that is not supported by the receiving system.</p> <p>X'06' A permanent error occurred in the system program used to store transaction program data at the receiving system.</p> <p>X'07' The system program to be used to store transaction program data is not supported by the receiving system.</p> <p>X'08' The parameters for the system program used to store transaction program data are not valid.</p> <p>X'09' The transaction program that is to receive the distribution is not supported on the receiving system.</p> <p>X'0A' The destination system has received the distribution (SNADS confirmation of the receive function is not supported).</p> |

Table 6. SNADS entries (continued)

| Relative offset | Field | Format | Description |
|-----------------|------------------------------------|-----------|---|
| 238 | Status condition codes (continued) | Char(2) | <p>These condition codes identify errors that occur during the handling of a distribution.</p> <p>(Hex) Code Condition</p> <p>X'0B' The distribution has been received and forwarded by an intermediate system (SNADS confirmation of the forwarding function is not supported).</p> <p>X'0C' A distribution request was deleted because it could not be processed, or it was canceled by the system operator or a user.</p> <p>X'0D' One or more user ID/addresses in the destination list were lost (This condition not likely to occur.)</p> <p>X'0E' The system resource needed to process the distribution is not available.</p> <p>X'0F' A system error of an unknown nature occurred.</p> <p>X'10' A temporary error occurred in the system program used to store transaction program data on the receiving system.</p> <p>X'11' An irrecoverable I/O error occurred during the processing of the distribution (This condition not likely to occur.)</p> <p>X'12' An error occurred while the sender was processing the recipient's acknowledgement.</p> <p>X'13' The size of the transaction program data being transmitted is larger than the maximum size allowed by the service level.</p> |
| 240 | Receiving system name/group | Char(16) | The system name/group of the SNADS node that was receiving a DIU when the error occurred. This applies only to errors entered by SNADS sender and receiver jobs. |
| 256 | Exception data | Char(247) | If the entry was made by the SNADS router, this field contains the distribution recipient's system name/group and user ID/address and the recipient will not receive the distribution. Otherwise this may contain data that is associated with the error entered. |

Table 6. SNADS entries (continued)

| Relative offset | Field | Format | Description |
|-----------------|-------------------|---------|--|
| 503 | Function | Char(1) | <p>Function that was being performed when the error occurred. The possible values are:</p> <p>X'01' SNADS router</p> <p>X'02' SNADS sender put its queues on hold as a result of an error</p> <p>X'03' SNADS receiver</p> <p>X'04' SNADS asynchronous feedback creation</p> <p>X'05' SNADS enqueue function</p> <p>X'06' SNADS dequeue function</p> <p>X'07' SNADS time of starting</p> <p>X'08' SNADS recovery</p> <p>X'09' SNADS sender deleted a distribution due to an error</p> <p>X'0A' SNADS sender was parsing a negative acknowledgement</p> <p>X'0B' SNADS gateway outbound error</p> <p>X'0C' SNADS gateway inbound error</p> <p>X'0D' VM/MVS bridge function outbound transform error</p> <p>X'0E' VM/MVS bridge function inbound transform error while parsing a SNADS ID</p> <p>X'0F' VM/MVS bridge function inbound transform error</p> <p>X'11' Temporary SNADS sender error</p> |
| 504 | Destination TPN | Char(8) | The destination transaction program name of the distribution entered. |
| 512 | Distribution type | Char(1) | <p>The distribution type of the distribution being sent.</p> <p>'F2'X SVDS distributions</p> <p>'40'X or 'F1'X All other distributions</p> |

Table 6. SNADS entries (continued)

| Relative offset | Field | Format | Description |
|-----------------|------------------------------|---------|--|
| 513 | Program name | Char(8) | The name of the SNADS program that made the journal entry. |
| 521 | Internal sequence number | Char(4) | The internal sequence number of the distribution entry. This number applies only to *SVDS distributions. The number has a 4-byte signed binary format. |
| 525 | Message unit ID | Char(4) | The message unit ID assigned by the transport layer to *SVDS distributions only. The number has a 4-byte signed binary format. |
| 529 | Message unit instance number | Char(2) | The instance number assigned by the transport layer to *SVDS distributions only. The number has a 2-byte signed binary format. |
| 531 | SNA response code | Char(4) | The SNA response code for an *SVDS distribution. See the <i>SNA/Distribution Services Reference</i> for possible values. |

Table 7. MSF message errors entries

| Relative offset | Field | Format | Description |
|-----------------|-----------------|-------------|---|
| 1 | Entry length | Zoned(5,0) | Total length of the journal entry, including the entry length field. |
| 6 | Sequence number | Zoned(10,0) | Applied to each journal entry. Initially set to 1 for each new or restored journal. Reset when a new receiver is attached. |
| 16 | Journal code | Char(1) | Always S for MSF entries. |
| 17 | Entry type | Char(2) | Always ER for MSF message error entries. |
| 19 | Date stamp | Char(6) | The system date that the entry was made. |
| 25 | Time stamp | Zoned(6,0) | The system time that the entry was made. |
| 31 | (Reserved area) | Char(95) | |
| 126 | Job name | Char(10) | The name of the job that caused the entry to occur. |
| 136 | User name | Char(10) | The user profile name associated with the job. |
| 142 | Job number | Zoned(6,0) | The job number. |
| 150 | Program name | Char(8) | The name of the MSF program that made the journal entry. |
| 158 | Error ID | Char(1) | The MSF error ID. The possible values are: 2 MSF message ended by an exit program 3 QMSF job ended by an exit program 4 An exit program returned data that was not valid 5 An exit program failed |
| 159 | MSF message ID | Char(32) | The MSF message ID logged. |

Table 7. MSF message errors entries (continued)

| Relative offset | Field | Format | Description |
|-----------------|-------------|-----------|--|
| 191 | Data length | Char(5) | The length of the logged data. |
| 196 | Logged data | Char(256) | The data logged by MSF when the error ID is: 2 Exit program name char(10) and library char(10) 3 Exit program name char(10) and library char(10) 4 Exit program name char(10) and library char(10) 5 Exit program name char(10) and library char(10) |

Distribution errors (S XE) journal entries

| Relative offset | Field | Format | Description |
|-----------------|-----------------|-------------|---|
| 1 | Length of Entry | Zoned(5,0) | Total length of the journal entry including the entry length field. |
| 5 | Sequence Number | Zoned(10,0) | Applied to each journal entry. Initially set to 1 for each new or restored journal. Reset to 1 when a new receiver is attached. |
| 16 | Journal Code | Char(1) | Always S. |
| 17 | Entry Type | Char(2) | Always XE for DSNX-logged errors. |
| 19 | Date of Entry | Char(6) | The system date that the entry was made. |
| 25 | Time of Entry | Zoned(6,0) | The system time that the entry was made. |
| 31 | (Reserved Area) | Char(95) | |
| 126 | Program Name | Char(8) | The name of the DSNX program that made the journal entry. |
| 134 | Name of Job | Char(10) | The name of the job that caused the entry to be generated. |
| 144 | User Name | Char(10) | The user profile name associated with the job. |
| 154 | Job Number | Zoned(6,0) | The job number. |

| Relative offset | Field | Format | Description |
|-----------------|----------------|-----------|--|
| 160 | Function | Char(1) | <p>DSNX function that was being performed when the logged entry was made. The possible values are:</p> <p>Hex</p> <p>Function</p> <p>11 Host interface receive.</p> <p>12 Object distribution error, host interface distribute through SNADS to destination node.</p> <p>13 NetView® DM protocol error, host interface receive.</p> <p>14 Host interface initialization or router errors.</p> <p>15 Response indicates SNADS error detected.</p> <p>16 Request processor could not run NetView DM function.</p> <p>17 Host interface send.</p> <p>18 Object distribution error for local distribution.</p> <p>1A DSNX/ in send mode.</p> <p>1B DSNX/ in receive mode.</p> <p>1C Unexpected condition detected in host interface.</p> <p>1D Unexpected SNUF major/minor return code detected in host interface.</p> <p>1E Object distribution detected a SNADS-generated error.</p> <p>1F Object distribution error detected by DSNX.</p> |
| 161 | Correlation ID | Char(44) | Identifier of the logged DSNX distribution. |
| 205 | Exception Data | Char(297) | |

DSNX log (S XL) journal entries

| Relative offset | Field | Format | Description |
|-----------------|-----------------|------------|---|
| 1 | Length of Entry | Zoned(5,0) | Total length of the journal entry including the entry length field. |

| Relative offset | Field | Format | Description |
|------------------------|-----------------|---------------|---|
| 6 | Sequence Number | Zoned(10,0) | Applied to each journal entry. Initially set to 1 for each new or restored journal. Reset to 1 when a new receiver is attached. |
| 16 | Journal Code | Char(1) | Always S. |
| 17 | Entry Type | Char(2) | Always XL for DSNX-logged event. |
| 19 | Date of Entry | Char(6) | The system date that the entry was made. |
| 25 | Time of Entry | Zoned(6,0) | The system time that the entry was made. |
| 31 | (Reserved Area) | Char(95) | |
| 126 | Program Name | Char(8) | The name of the DSNX program that made the journal entry. |
| 134 | Name of Job | Char(10) | The name of the job that caused the entry to be generated. |
| 144 | User Name | Char(10) | The user profile name associated with the job. |
| 154 | Job Number | Zoned(6,0) | The job number. |

| Relative offset | Field | Format | Description |
|-----------------|----------------|-----------|---|
| 160 | Function | Char(1) | <p>DSNX function that was being performed when the logged entry was made. The possible values are:</p> <p>Hex</p> <p>Function</p> <p>03 A DSNX reply distribution was received at the host interface.</p> <p>04 Request processor ran the NetView DM request.</p> <p>05 Value for host interface receiver entry when a NetView DM request header is received.</p> <p>06 Value for host interface query response when a delayed ACK response is completed to the NetView DM host.</p> <p>07 Value for host interface response when a data set ready response is completed to the NetView DM host.</p> <p>08 Value for host interface response when a NetView DM resynchronization is completed.</p> <p>09 Value for host interface remote distribution.</p> <p>0A Value for host interface local distribution.</p> <p>0B Entry deleted from DSNX/PC queue via WRKDPCQ command.</p> <p>0C Value for DSNX/ in send mode.</p> <p>0D Value for DSNX/ in receive mode.</p> |
| 161 | Correlation ID | Char(44) | Identifier of the logged DSNX distribution. |
| 205 | Logged Data | Char(100) | |

Force data to auxiliary storage (F FD) journal entry

| Relative offset | Field | Format | Description |
|---|----------------------|-------------|--|
| Specific values for this entry type: | | | |
| | Job name (JOJOB) | Char (10) | Blank if the entry is written during IPL or vary on of an independent disk pool. |
| | Job number (JONBR) | Zoned (6,0) | Zero if entry is written during IPL or vary on of an independent disk pool. |
| | Program name (JOPGM) | Char (10) | Blank if the entry is written during IPL or vary on of an independent disk pool. |

Integrated file system begin create (B B0) journal entry

| Relative offset | Field | Format | Description |
|--|----------------------------|----------|---|
| Entry-specific data. This data appears as one field in the standard output formats: | | | |
| 1 | Object name offset | Bin (32) | The offset from the beginning of the entry-specific data to the beginning of the Object name field. |
| 5 | Object type | Char (7) | The object type that was created. |
| 12 | Start journaling indicator | Char (1) | Indicates whether journaling will be started. Y = Journaling will be started blank = Journaling will not be started |
| 13 | Reserved | Bin (32) | Reserved. This field is set to zero. |
| 17 | Object name | Char (*) | See the Object name table for the layout of this field. |

Integrated file system bytes cleared, after-image (B B6) journal entry

| Relative offset | Field | Format | Description |
|--|-------------|-----------|---|
| Entry-specific data. This data appears as one field in the standard output formats: | | | |
| 1 | Object FID | Char (16) | The file identifier of the object. |
| 17 | Data length | Bin (64) | The length of the data. |
| 25 | Offset | Bin (64) | The offset to begin write of hex zeros (clear). |
| 33 | Reserved | Char (16) | Reserved. Set to zeros. |

Integrated file system change audit attribute (B AA) journal entry

| Relative offset | Field | Format | Description |
|--|----------------|------------|---|
| Entry-specific data. This data appears as one field in the standard output formats: | | | |
| 1 | Entry type | Char (1) | The type of entry is as follows: D = Changed DLO authority O = Changed object authority |
| 2 | Object name | Char (10) | The name of the object for which the auditing attributes were changed. *N if the object is not in a library. |
| 12 | Library name | Char (10) | The name of the library for the object. *N if the object is not in a library. |
| 22 | Object type | Char (8) | The type of object. |
| 30 | Auditing value | Char (10) | The new value specified on the <u>Change Auditing Value</u> CHGAUD command. |
| 40 | Reserved | Char (135) | Reserved. This field is set to blanks. |

| Relative offset | Field | Format | Description |
|-----------------|-------------------|-----------|---|
| 175 | Object name CCSID | Bin (31) | The coded character set identifier (CCSID) for the object name. |
| 179 | Reserved | Char (8) | Reserved. This field is set to blanks. |
| 187 | Parent FID | Char (16) | The file identifier of the parent directory. |
| 203 | Object FID | Char (16) | The file identifier of the object. |

Integrated file system change object authority (B OA) journal entry

| Relative offset | Field | Format | Description |
|--|--------------------------------------|-----------|--|
| Entry-specific data. This data appears as one field in the standard output formats: | | | |
| 1 | Entry type | Char (1) | The type of entry. A = Change authorization. |
| 2 | Object name | Char (10) | The object name. *N if the object is not in a library. |
| 12 | Library name | Char (10) | The library name. *N if the object is not in a library. |
| 22 | Object type | Char (8) | The type of object. |
| 30 | User name | Char (10) | The name of the user profile whose authorization is being granted or revoked. |
| 40 | Authorization list name | Char (10) | The name of the authorization list. |
| 50 | Object existence authority | Char (1) | Y = User has *OBJEXIST authority to the object. blank = User does not have *OBJEXIST authority to the object. |
| 51 | Object management authority | Char (1) | Y = User has *OBJMGT authority to the object. blank = User does not have *OBJMGT authority to the object. |
| 52 | Object operational authority | Char (1) | Y = User has *OBJOPR authority to the object. blank = User does not have *OBJOPR authority to the object. |
| 53 | Authorization list management | Char (1) | Blank if user does not authorization list management to the object. |
| 54 | Authorization list *PUBLIC authority | Char (1) | Y = User has *PUBLIC authority to the object. blank = User does not have *PUBLIC authority to the object. |
| 55 | Read authority | Char (1) | Y = User has *READ authority to the object. blank = User does not have *READ authority to the object. |

| Relative offset | Field | Format | Description |
|-----------------|------------------------|------------|--|
| 56 | Add authority | Char (1) | Y = User has *ADD authority to the object. blank = User does not have *ADD authority to the object. |
| 57 | Update authority | Char (1) | Y = User has *UPD authority to the object. blank = User does not have *UPD authority to the object. |
| 58 | Delete authority | Char (1) | Y = User has *DLT authority to the object. blank = User does not have *DLT authority to the object. |
| 59 | Exclude authority | Char (1) | Y = User has *EXCLUDE authority to the object. blank = User does not have *EXCLUDE authority to the object. |
| 60 | Execute authority | Char (1) | Y = User has *EXECUTE authority to the object. blank = User does not have *EXECUTE authority to the object. |
| 61 | Object alter authority | Char (1) | Y = User has *OBJALTER authority to the object. blank = User does not have *OBJALTER authority to the object. |
| 62 | Object reference | Char (1) | Y = User has *OBJREF authority to the object. blank = User does not have *OBJREF authority to the object. |
| 63 | Reserved | Char (4) | Reserved. Set to blanks. |
| 67 | Operation type | Char (3) | Possible values are: GRT = Grant RPL = Grant with replace RVK = Revoke |
| 70 | Reserved | Char (149) | Reserved. Set to blanks. |
| 19 | Object name CCSID | Bin (31) | The coded character set identifier (CCSID) for the object name. |
| 223 | Reserved | Char (8) | Reserved. Set to blanks. |
| 231 | Parent FID | Char (16) | The file identifier of the parent directory. This field is not set or used. |
| 247 | Object FID | Char (16) | The file identifier of the object. |

Integrated file system change object owner (B OO) journal entry

| Relative offset | Field | Format | Description |
|--|-------------------|------------|---|
| Entry-specific data. This data appears as one field in the standard output formats: | | | |
| 1 | Entry type | Char (1) | The type of entry. A = Change owner |
| 2 | Object name | Char (10) | The object name. *N if object is not in a library. |
| 12 | Library name | Char (10) | The library name. *N if object is not in a library. |
| 22 | Object type | Char (8) | The object type. |
| 30 | Old owner | Char (10) | The old owner. |
| 40 | New owner | Char (10) | The new owner. |
| 50 | Reserved | Char (143) | Reserved. Set to blanks. |
| 193 | Object name CCSID | Bin (31) | The coded character set identifier (CCSID) for the object name. |
| 197 | Reserved | Char (8) | Reserved. Set to blanks. |
| 205 | Parent FID | Char (16) | The file identifier of the parent directory. |
| 221 | Object FID | Char (16) | The file identifier of the object. |

Integrated file system change primary group (B OG) journal entry

| Relative offset | Field | Format | Description |
|--|-----------------------------|-----------|--|
| Entry-specific data. This data appears as one field in the standard output formats: | | | |
| 1 | Entry type | Char (1) | Type of entry A = Change primary group profile |
| 2 | Object name | Char (10) | The object name. *N if object is not in a library. |
| 12 | Library name | Char (10) | The library name. *N if object is not in a library. |
| 22 | Object type | Char (8) | The type of object. |
| 30 | Old primary group | Char (10) | The old primary group. |
| 40 | New primary group | Char (10) | The new primary group. |
| 50 | Object existence authority | Char (1) | Y = New primary group has *OBJEXIST authority to the object. blank = New primary group does not have *OBJEXIST authority to the object. |
| 51 | Object management authority | Char (1) | Y = New primary group has *OBJMGT authority to the object. blank = New primary group does not have *OBJMGT authority to the object. |

| Relative offset | Field | Format | Description |
|-----------------|-------------------------------|-----------|--|
| 52 | Object operational authority | Char (1) | Y = New primary group has *OBJOPR authority to the object. blank = New primary group does not have *OBJOPR authority to the object. |
| 53 | Object alter authority | Char (1) | Y = New primary group has *OBJALTER authority to the object. blank = New primary group does not have *OBJALTER authority to the object. |
| 54 | Object reference authority | Char (1) | Y = New primary group has *OBJREF authority to the object. blank = New primary group does not have *OBJREF authority to the object. |
| 55 | Reserved | Char (10) | Reserved. Set to blanks. |
| 65 | Authorization list management | Char (1) | Blank if new primary group does not authorization list management to the object. |
| 66 | Read authority | Char (1) | Y = New primary group has *READ authority to the object. blank = New primary group does not have *READ authority to the object. |
| 67 | Add authority | Char (1) | Y = New primary group has *ADD authority to the object. blank = New primary group does not have *ADD authority to the object. |
| 68 | Update authority | Char (1) | Y = New primary group has *UPD authority to the object. blank = New primary group does not have *UPD authority to the object. |
| 69 | Delete authority | Char (1) | Y = New primary group has *DLT authority to the object. blank = New primary group does not have *DLT authority to the object. |
| 70 | Execute authority | Char (1) | Y = New primary group has *EXECUTE authority to the object. blank = New primary group does not have *EXECUTE authority to the object. |
| 71 | Reserved | Char (10) | Reserved. Set to blanks. |
| 81 | Exclude authority | Char (1) | Y = New primary group has *EXCLUDE authority to the object. blank = New primary group does not have *EXCLUDE authority to the object. |

| Relative offset | Field | Format | Description |
|-----------------|---|-----------|--|
| 82 | Revoke previous primary group authority | Char (1) | Y = The previous primary group authority to the object was revoked. blank = The previous primary group authority to the object was not revoked. |
| 83 | Reserved | Char 143 | Reserved. Set to blanks. |
| 226 | Object name CCSID | Bin (31) | The coded character set identifier (CCSID) for the object name. |
| 230 | Reserved | Char (8) | Reserved. Set to blanks. |
| 238 | Parent FID | Char (16) | The file identifier of the parent directory. |
| 254 | Object FID | Char (16) | The file identifier of the object. |

Integrated file system created object authority (B B7) journal entry

| Relative offset | Field | Format | Description |
|--|---------------------------------|-----------|---|
| Entry-specific data. This data appears as one field in the standard output formats: | | | |
| 1 | Object FID | Char (16) | The file identifier of the created object. |
| 17 | Number of authorities | Bin (32) | The number of private authorities in this entry. |
| 21 | Offset to object name | Bin (32) | The offset from the beginning of the entry-specific data to the beginning of the Object name field. |
| 25 | Offset to path name | Bin (32) | The offset from the beginning of the entry-specific data to the beginning of the Path name field. |
| 29 | Offset to authority information | Bin (32) | The offset from the beginning of the entry-specific data to the beginning of the Authority information field. |
| 33 | Format indicator | Char (1) | The format indicator is set to the following: 0 = The original layout of this journal entry (FORMAT1) |
| 34 | Reserved | Char (15) | Reserved. Set to zeros. |
| * | Object name | Char (*) | See the Object name table for the layout of this field. |
| * | Path name | Char (*) | See the Path name table for the layout of this field. |
| * | Authority information | Char (*) | The array of private authority information that has been set for the created object. See the Private authority table for the layout of one array element in this field. If the incomplete data indicator is off, the information is a character string. Otherwise, it is a pointer to the actual data. See “Working with pointers in journal entries” on page 313 for more information. |

Integrated file system create-summary (B B1) journal entry

| Relative offset | Field | Format | Description |
|--|---|-----------|--|
| Entry-specific data. This data appears as one field in the standard output formats: | | | |
| 1 | Offset to name | Bin (32) | The offset from the beginning of the entry-specific data to the beginning of the Object name field. |
| 5 | Offset to path name | Bin (32) | The offset from the beginning of the entry-specific data to the beginning of the Path name field. |
| 9 | Offset to symbolic link contents field. | Bin (32) | The offset from the beginning of the entry-specific data to the beginning of the Symbolic link contents field. |
| 13 | Object type | Char (7) | The object type that was created. |
| 20 | Scan attribute | Char (1) | If the new object is a stream file (*STMF), this field is the scan (QPOL_ATTR_SCAN) attribute as described in the Set Attributes (Qp01SetAttr()) API. If the new object is a directory (*DIR), this field is the create object scanning (QPOL_ATTR_CRTOBJSCAN) attribute of the Qp01SetAttr() API. |
| 21 | File ID of object | Char (16) | The new object file identifier. |
| 37 | Owner name | Char (10) | The user profile name of the owner. |
| 47 | Group name | Char (10) | The primary group profile name. |
| 57 | Auditing value | Char (10) | The auditing value of the new object. |
| 67 | Object CCSID | Bin (16) | The coded character set identifier (CCSID) for the object. |
| 69 | Owner private authority | Char (12) | Private authorities assigned to the owner. See the Private authority information table. |
| 81 | Primary group private authority | Char (12) | Private authorities assigned to the primary group. See the Private authorities for specified profile table. |
| 93 | *PUBLIC private authority | Char (12) | Private authorities assigned to the *PUBLIC. See the Private authorities for specified profile table.. |
| 105 | Authorization list name | Char (10) | The authorization list name for the new object. |
| 115 | Authorization list *PUBLIC | Char (1) | The authorization List *PUBLIC authority. Possible values are Y or blank. |

| Relative offset | Field | Format | Description |
|-----------------|------------------------|-----------|---|
| 116 | Format indicator | Char (1) | <p>The format indicator is set to one of the following values:</p> <ul style="list-style-type: none"> • 0 = The original layout of this journal entry (FORMAT1) • 1 = The layout of FORMAT1 plus the Device id field is set appropriately (FORMAT2) • 2 = The layout for all of FORMAT2 plus the following fields are set appropriately (FORMAT3) <ul style="list-style-type: none"> – Scan attribute – Create object auditing – S_ISVTX value – S_ISUID value – S_ISGID value my first point <p>For information about the values in this field see the Get Attributes (Qp01GetAttr()) API.</p> |
| 117 | PC read-only | Char (1) | <p>The PC read Only flag. For information about the values in this field see the Get Attributes (Qp01GetAttr()) API.</p> |
| 118 | PC hidden | Char (1) | <p>The PC hidden flag. For information about the values in this field see the Get Attributes (Qp01GetAttr()) API.</p> |
| 119 | PC system | Char (1) | <p>The PC System file flag. For information about the values in this field see the Get Attributes (Qp01GetAttr()) API.</p> |
| 120 | PC changed | Char (1) | <p>The PC changed flag. For information about the values in this field see the Get Attributes (Qp01GetAttr()) API..</p> |
| 121 | Journal information | Char (36) | <p>The journaling information for the new object. This field indicates if journaling is now active on the new object. If so, it also contains the information the information used to start journaling. See the Journal information table for the layout of this field.</p> |
| 157 | Device ID | Bin (64) | <p>This field is only valid when the object type is *CHRSF.</p> |
| 165 | Create object auditing | Char (10) | <p>The create object auditing value. This value only applies to directories (*DIR).</p> |
| 175 | S_ISVTX value | Char (1) | <p>The restricted rename and unlink (S_ISVTX) mode bit. For information about the values in this field see the Get Attributes (Qp01GetAttr()) API.</p> |
| 176 | S_ISUID value | Char (1) | <p>The S_ISUID mode bit. For information about the values in this field see the Get Attributes (Qp01GetAttr()) API.</p> |

| Relative offset | Field | Format | Description |
|-----------------|------------------------|----------|--|
| 177 | S_ISGID value | Char (1) | The S_ISGID mode bit. For information about the values in this field see the Get Attributes (Qp01GetAttr()) API. |
| 178 | Object name | Char (*) | See the Object name table for the layout of this field. |
| * | Path name | Char (*) | See the Path name table for the layout of this field. |
| * | Symbolic link contents | Char (*) | See the Symbolic link contents table for the layout of this field. |

Integrated file system end journaling for object (B ET) journal entry

| Relative offset | Field | Format | Description |
|--|------------|-----------|------------------------------------|
| Entry-specific data. This data appears as one field in the standard output formats: | | | |
| 1 | Object FID | Char (16) | The file identifier of the object. |

Integrated file system link to existing object (B B2) journal entry

| Relative offset | Field | Format | Description |
|--|------------------|-----------|--|
| Entry-specific data. This data appears as one field in the standard output formats: | | | |
| 1 | Object FID | Char (16) | The file identifier of the existing object. |
| 17 | Link offset | Bin (32) | The offset from beginning of this entry-specific data to the beginning of the Link name field. |
| 21 | Path offset | Bin (32) | The offset from beginning of this entry-specific data to the beginning of the Path name field. |
| 25 | Start journaling | Char (1) | The start journaling indicator. Y = Journaling starts on the existing object as a result of this operation. The Journal information field has start journaling information. blank = Journaling is not started on the existing object as a result of this operation. The Journal information field contains all hex zeros. |

| Relative offset | Field | Format | Description |
|-----------------|---------------------|-----------|---|
| 26 | Summary | Char (1) | The summary record indicator. Y = This journal entry was deposited after the actual operation was completed. If the Start journaling field is Y , then the Journal information field contains the actual information related to starting journaling on the target object. If the Start journaling field is blank, then the Journal information field contains all hex zeros. blank = This journal entry was deposited before the actual operation was attempted. If the Start journaling field is Y , then the Journal information field contains the journal information inherited from its new parent. This information is used to attempt a start journaling operation. If the Start journaling field is blank, then the Journal information field contains all hex zeros. |
| 27 | Reserved | Char (2) | Reserved. Set to zero. |
| 29 | Journal information | Char (36) | The journaling information for the new object. This field is defined in the Journal information table. |
| 65 | Link name | Char (*) | The name of the new link to the object. See the Object name table for the layout of this field. |
| * | Path name | Char (*) | The existing object path name. If this B2 journal entry was deposited as a result of a rollback of a B5 entry, then this will actually be the path to the parent directory to which the link is being added. See the Path name table for the layout of this field. |

Integrated file system object attribute changed (B FA) journal entry

| Relative offset | Field | Format | Description |
|--|-----------------------|-----------|--|
| Entry-specific data. This data appears as one field in the standard output formats: | | | |
| 1 | Object FID | Char (16) | The file identifier of the object. |
| 17 | Parent FID | Char (16) | The file identifier of the parent directory. |
| 33 | Object type | Char (7) | The type of object. |
| 40 | Reserved | Char (9) | Reserved. This field is set to hex zeros. |
| 49 | Next attribute offset | Bin (32) | The offset to the next attribute. All of the offsets 49, 53, 57, 61, and 65 will repeat for each attribute set for this entry. |

| Relative offset | Field | Format | Description |
|-----------------|----------------------|-----------|--|
| 53 | Attribute identifier | Bin (32) | The attribute identifier. See the Set Attributes (Qp0lSetAttr()) API for information about the structure and content of this field. All of the offsets 49, 53, 57, 61, and 65 will repeat for each attribute set for this entry. |
| 57 | Attribute data size | Char (32) | Size of attribute data in bytes. All of the offsets 49, 53, 57, 61, and 65 will repeat for each attribute set for this entry. |
| 61 | Reserved | Char (4) | Reserved. All of the offsets 49, 53, 57, 61, and 65 will repeat for each attribute set for this entry. |
| 65 | Changed data | Char (*) | The data that was changed. All of the offsets 49, 53, 57, 61, and 65 will repeat for each attribute set for this entry. |

Integrated file system object closed (B CS) journal entry

| Relative offset | Field | Format | Description |
|--|------------|----------|--|
| Entry-specific data. This data appears as one field in the standard output formats: | | | |
| 1 | Open flags | Bin (31) | Open flags. See the Open API for a description of these flags. |

Integrated file system object deleted (B BD) journal entry

| Relative offset | Field | Format | Description |
|--|------------|-----------|------------------------------------|
| Entry-specific data. This data appears as one field in the standard output formats: | | | |
| 1 | Object FID | Char (16) | The file identifier of the object. |

Integrated file system object forced (B FC) journal entry

| Relative offset | Field | Format | Description |
|--|------------|-----------|------------------------------------|
| Entry-specific data. This data appears as one field in the standard output formats: | | | |
| 1 | Object FID | Char (16) | The file identifier of the object. |

Integrated file system object opened (B OF) journal entries

| Relative offset | Field | Format | Description |
|--|------------|----------|--|
| Entry-specific data. This data appears as one field in the standard output formats: | | | |
| 1 | Open flags | Bin (31) | Open flags. See the Open API for a description of these flags. |

Integrated file system object truncated (B TR) journal entry

| Relative offset | Field | Format | Description |
|--|------------|-----------|--|
| Entry-specific data. This data appears as one field in the standard output formats: | | | |
| 1 | Object FID | Char (16) | The file identifier of the object. |
| 17 | Old size | Bin (64) | The size of the object in bytes before it was truncated. |
| 25 | New size | Bin (64) | The size of the object in bytes after it was truncated. |

Integrated file system remove link (link) (B B5) journal entry

| Relative offset | Field | Format | Description |
|--|----------------------|-----------|--|
| Entry-specific data. This data appears as one field in the standard output formats: | | | |
| 1 | Object FID | Char (16) | The file identifier of the existing object. |
| 17 | Parent FID | Char (16) | The file identifier of the object parent directory. |
| 33 | Link offset | Bin (32) | The offset from beginning of this entry-specific data to the beginning of the Link name field. |
| 37 | Parent path offset | Bin (32) | The offset from beginning of this entry-specific data to the beginning of the Parent path field. |
| 41 | Parent directory JID | Char (10) | The journal identifier of parent directory. |
| 51 | Object type | Char (7) | The type of the object. |
| 58 | Reserved | Char (3) | Reserved. Set to zero. |
| 61 | Internal data offset | Bin (32) | The offset from beginning of this field to the beginning of Internal data field. |
| 65 | Link name | Char (*) | The name of link. See the Object name layout of this field. |
| * | Parent path | Char (*) | The path to the parent that used to contain this link. See the Path name layout of this field. |
| * | Internal data | Char (*) | Internal data. |

Integrated file system remove link (parent directory) (B B4) journal entry

| Relative offset | Field | Format | Description |
|--|-------------|-----------|--|
| Entry-specific data. This data appears as one field in the standard output formats: | | | |
| 1 | Object FID | Char (16) | The file identifier of the existing object. |
| 17 | Parent FID | Char (16) | The parent directory of the link file identifier. |
| 33 | Link offset | Bin (32) | The offset from beginning of this entry-specific data to the beginning of the Link name field. |
| 37 | Object JID | Char (10) | The journal identifier of the object. |
| 47 | Object type | Char (7) | The type of the object. |

| Relative offset | Field | Format | Description |
|-----------------|---------------|----------|--|
| 54 | Reserved | Char (7) | Reserved. Set to zero. |
| 61 | System offset | Bin (32) | The offset from beginning of this entry-specific data to the beginning of Internal data. |
| 65 | Link name | Char (*) | The name of link. See the Object name layout of this field. |
| * | Internal data | Char (*) | Internal data. |

Integrated file system rename file identifier (B RN) journal entry

| Relative offset | Field | Format | Description |
|--|----------|-----------|--|
| Entry-specific data. This data appears as one field in the standard output formats: | | | |
| 1 | Old FID | Char (16) | The file identifier of the object before the rename operation. |
| 17 | Reserved | Char (14) | Reserved. Set to blanks. |
| 31 | New FID | Char (16) | The file identifier of the object after the rename operation. |
| 47 | Reserved | Char (14) | Reserved. Set to blanks. |

Integrated file system rename, move object (B B3) journal entry

| Relative offset | Field | Format | Description |
|--|----------------------|-----------|---|
| Entry-specific data. This data appears as one field in the standard output formats: | | | |
| 1 | Object FID | Char (16) | The file identifier of the object for the renamed link. |
| 17 | Source parent FID | Char (16) | The file identifier of the source object directory. |
| 33 | Target parent FID | Char (16) | The file identifier of the target object directory. |
| 49 | Replaced object FID | Char (16) | The file identifier of the object that was replaced by this operation. This field contains all hex zeros if no object was replaced. |
| 65 | Source offset | Bin (32) | The offset from beginning of this entry-specific data to the beginning of the Source name field. |
| 69 | Target offset | Bin (32) | The offset from beginning of this entry-specific data to the beginning of the Target name field. |
| 73 | Source parent offset | Bin (32) | The offset from beginning of this entry-specific data to the beginning of the Source parent path field. |
| 77 | Target parent offset | Bin (32) | The offset from beginning of this entry-specific data to the beginning of the Target parent path field. |

| Relative offset | Field | Format | Description |
|-----------------|---------------------|-----------|--|
| 81 | Start journaling | Char (1) | The start journaling indicator: Y = Journaling starts on the existing object as a result of this operation. The Journal information field contains the information used to start journaling. blank = Journaling does not start on the existing object as a result of this operation. The Journal information field contains all hex zeros. |
| 82 | Summary | Char (1) | The summary record indicator: Y = This journal entry was deposited after the actual operation was completed. If the Start journaling field is also Y , then the Journal information field contains the actual information related to starting journaling on the target object. If the Start journaling field is blank, then the Journal information record will contain all hex zeros. blank = This journal entry was deposited before the actual operation was attempted. If Start journaling is Y , then the Journal information field contains the journal information inherited from its new parent. That information is used to attempt a start journaling operation. If the Start journaling field is blank, then the Journal information field contains all hex zeros. |
| 83 | Replace | Char (1) | The replace indicator. Indicates if the target was replaced as a result of this operation. Y = Indicates that the target was replaced. blank = Indicates that the target did not exist before this operation. |
| 84 | Journal entry flags | Bin (32) | The fields for journal entry flags are as follows: Both journaled Bit(0)--1 = Indicates that this entry is one of a pair of B3 entries sent for this move operation. This occurs when both the source and target parent directories are journaled at the time of the move operation. Source entry Bit(1)--1 = Indicates that this entry was deposited because the source parent was journaled. Reserved Bits(2-7)--Reserved. Set to zero. |
| 88 | Reserved | Char (4) | Reserved field. |
| 92 | Journal information | Char (37) | The journaling information for the new object. This field is defined in Journal information. |

| Relative offset | Field | Format | Description |
|-----------------|--------------------|----------|---|
| 129 | System offset | Bin (32) | The offset from beginning of this entry-specific data to the beginning of Internal data field. |
| 133 | Source name | Char (*) | The name of object being renamed or moved. See the Object name layout of this field. |
| * | Target name | Char (*) | The new name of object after being renamed or moved. See the Object name layout. |
| * | Source parent path | Char (*) | The path to the parent directory from which the object previously belonged. See Path name for the layout of this field. |
| * | Target parent path | Char (*) | The path to the parent directory to which the object now belongs. See Path name for the layout of this field. |
| * | Internal data | Char (*) | Internal data. |

Integrated file system storage for object freed (B FF) journal entry

| Relative offset | Field | Format | Description |
|--|------------|-----------|------------------------------------|
| Entry-specific data. This data appears as one field in the standard output formats: | | | |
| 1 | Object FID | Char (16) | The file identifier of the object. |
| 17 | Old size | Bin (64) | The old size of the object. |

Integrated file system write, after-image (B WA) journal entry

| Relative offset | Field | Format | Description |
|--|-------------|-----------|--|
| Entry-specific data. This data appears as one field in the standard output formats: | | | |
| 1 | Object FID | Char (16) | The file identifier of the object. |
| 17 | Data length | Bin (64) | Length of the data. |
| 25 | Offset | Bin (64) | The offset to begin write. |
| 33 | Reserved | Char (16) | Reserved. |
| 49 | Data | Char (*) | The actual data that was written. If the incomplete data indicator is off, the information is a character string. Otherwise, it is a pointer to the actual data. See Work with pointers in journal entries for more information. |

Identity Value (F IT) journal entries

| Relative offset | Field | Format | Description |
|--|---------|---------|----------------|
| Entry-specific data. This data appears as one field in the standard output formats: | | | |
| 1 | Version | Bin(15) | Version number |

| Relative offset | Field | Format | Description |
|-----------------|----------------|---------------|--|
| 3 | Identity Value | DECIMAL(31,0) | The last identity value allocated in the current CACHE |

INZPFM (F IZ) journal entry

| Relative offset | Field | Format | Description |
|--|--|--------------|--|
| Specific values for this entry type: | | | |
| | Count or relative record number (JOCTRR) | Zoned (10,0) | Contains the number of records specified on the TOTRCDS parameter of the Initialize Physical File Member (INZPFM) command. |
| | Flag (JOFLAG) | Char (1) | Indicates the type of record initialization that was done: 0 = *DFT (default) 1 = *DLT (delete) |
| Entry-specific data. This data appears as one field in the standard output formats: | | | |
| 1 | Entry-specific data | | If the member is initialized with default records, this field contains the default record image. |

IPL after abnormal end (J IA) journal entries

| Relative offset | Field | Format | Description |
|--|-------------|----------|---------------------------|
| Entry-specific data. This data appears as one field in the standard output formats: | | | |
| 1 | System name | Char (8) | Name of the system IPLed. |

IPL after normal end (J IN) journal entries

| Relative offset | Field | Format | Description |
|--|-------------|----------|---------------------------|
| Entry-specific data. This data appears as one field in the standard output formats: | | | |
| 1 | System name | Char (8) | Name of the system IPLed. |

Quiesce ASP activity (J JQ) journal entries

| Relative offset | Field | Format | Description |
|--|-------------|----------|------------------------|
| Entry-specific data. This data appears as one field in the standard output formats: | | | |
| 1 | System name | Char (8) | Name of the system xxx |

IP NAT rules actions (M TN) journal entry

| Relative offset | Field | Format | Description |
|-----------------|-----------------------------|-------------|--|
| 1 | Entry length | Zoned(5,0) | Total length of the journal entry including the entry length field. |
| 6 | Sequence number | Zoned(10,0) | Applied to each journal entry. Initially set to 1 for each new or restored journal. Reset when a new receiver is attached. |
| 16 | Journal code | Char(1) | Always "M" |
| 17 | Entry type | Char(2) | Always "TN" |
| 19 | Date stamp | Char(6) | The system date that the entry was made. |
| 25 | Time stamp | Zoned(6,0) | The system time that the entry was made. |
| 31 | (Reserved area) | Char(95) | |
| 126 | Line description | Char(10) | "*ALL" if TFREVT is "U*". Blank if TFREVT is "L*". Line name if TFREVT is "L". |
| 136 | Rule Event | Char(2) | "L*" or "L" when rules are loaded. "U*" when rules are unloaded. "A" when filter action. |
| 138 | IP Packet Direction | Char(1) | "O" is outbound. "I" is inbound. |
| 139 | Rule Number | Char(5) | Applies to the rule number in the active rules file. |
| 144 | Transport Protocol | Char(4) | 1 is ICMP 6 is TCP 17 is UDP |
| 149 | Source IP Address | Char(15) | |
| 164 | Source Port | Char(5) | |
| 169 | Destination IP Address | Char(15) | |
| 184 | Destination Port | Char(5) | |
| 189 | Translated IP Address | Char(15) | |
| 204 | Translated source port | Char(5) | |
| 209 | Translated Destination IP | Char(15) | |
| 224 | Translated Destination Port | Char(5) | |
| 229 | Text Information | Char(76) | Contains description if TFREVT = "L*" or "L" or "U*" |

IP Packet Filter (M TF) journal entry

| Relative offset | Field | Format | Description |
|-----------------|------------------------|-------------|--|
| 1 | Entry length | Zoned(5,0) | Total length of the journal entry including the entry length field. |
| 6 | Sequence number | Zoned(10,0) | Applied to each journal entry. Initially set to 1 for each new or restored journal. Reset when a new receiver is attached. |
| 16 | Journal code | Char(1) | Always "M" |
| 17 | Entry type | Char(2) | Always "TF" |
| 19 | Date stamp | Char(6) | The system date that the entry was made. |
| 25 | Time stamp | Zoned(6,0) | The system time that the entry was made. |
| 31 | (Reserved area) | Char(95) | |
| 126 | Line description | Char(10) | "*ALL" if TFREVT is "U*". Blank if TFREVT is "L*". Line name if TFREVT is "L". |
| 136 | Rule Event | Char(2) | "L*" or "L" when rules are loaded. "U" when rules unloaded. "A" when filter action. |
| 138 | IP Packet Direction | Char(1) | "O" is outbound. "I" is inbound. |
| 139 | Rule Number | Char(5) | Applies to the rule number in the active rules file. |
| 144 | Filter Action Taken | Char(6) | "PERMIT" or "DENY" |
| 148 | Transport Protocol | Char(4) | 1 is ICMP 6 is TCP 17 is UDP |
| 152 | Source IP Address | Char(15) | |
| 157 | Source Port | Char(5) | Garbage if TFPROT =1 (ICMP) |
| 162 | Destination IP Address | Char(15) | |
| 177 | Destination Port | Char(5) | Garbage if TFPROT =1 (ICMP) |
| 182 | Additional Text | Char(76) | Contains description if TFRVET = "L*" or "L" or "U" |

IPL (J IA, J IN) and in-use (B OI, C BA, D ID, E EI, F IU, I DA, J JI, Q QI) journal entries

| Relative offset | Field | Format | Description |
|---|---------------------|-------------|--|
| Specific values for this entry type: | | | |
| | Time stamp (JOTIME) | Zoned (6,0) | The timestamp created at IPL is read from the battery-powered clock. If the battery-powered clock cannot be read, the time is that of the system power down, not the time of the IPL, because the system time has not yet been updated at the time the journal entry is written. |

| Relative offset | Field | Format | Description |
|-----------------|---------------|----------|---|
| | Flag (JOFLAG) | Char (1) | For in-use entries, indicates whether the object was synchronized with the journal: 0 = Object was synchronized with journal 1 = Object was not synchronized with journal |

Journal code R, all journal entry types except IL

| Relative offset | Field | Format | Description |
|---|----------------------------|-----------|---|
| Specific values for this entry type: | | | |
| | Flag (JOFLAG) | Char (1) | Whether a before-image is present ¹ : 0 = Before-image is not present. If before-images are being journaled, this indicates that an update operation or delete operation is being requested for a record that has already been deleted. 1 = Before-image is present. |
| | Journal identifier (JOJID) | Char (10) | The JID is not provided with the *TYPE1, *TYPE2, and *TYPE3 formats. It can be used with the QJORJIDI API. |
| Entry-specific data. This data appears as one field in the standard output formats: | | | |
| 1 | Entry-specific data | Char (*) | After-image of the record for entry types PT, PX, UP, or UR. Before-image of the record for entry types UB, DL, BR, or DR if before-images are being journaled and the record was not previously deleted. |
| Note: ¹ The flag does not apply to these entry types: PT, PX, UP, and UR. | | | |

Journaling for library started (Y YB) journal entry

| Relative offset | Field | Format | Description |
|--|--------------------------------|----------|---|
| Entry-specific data. This data appears as one field in the standard output formats: | | | |
| 1 | Omit journal entries | Char (1) | Identifies whether entries are to be omitted from journaling: '0' = no entries are to be omitted '1' = entries are to be omitted |
| 2 | New objects inherit journaling | Char (1) | Identifies whether new objects created within a library or directory should inherit journaling '0' = no, or inherit does not apply to this object '1' = yes, new objects inherit journaling |
| 3 | Reserved | Char(4) | |

| Relative offset | Field | Format | Description |
|---|--|--------------------------------|---|
| 6 | Displacement to additional information | Bin(16) unsigned short integer | |
| Offset determined by Displacement to additional information | Version | Bin(32) unsigned integer | Version number for this structure |
| | Displacement to Inherit Rules | Bin(32) unsigned integer | Displacement to Inherit Rules information from the beginning of the Version field |
| Offset determined by Displacement to Inherit Rules | Inherit Rules | | See Journal Inherit Rules |

License key not valid (L LK) journal entry

| Relative offset | Field | Format | Description |
|--|-----------------|-------------|--|
| Entry-specific data. This data appears as one field in the standard output formats: | | | |
| 1 | Product ID | Char (7) | The ID of the product whose license key was not valid. |
| 8 | License term | Char (6) | The term of the license. |
| 14 | Feature | Char (4) | The product feature code. |
| 18 | Usage limit | Zoned (6,0) | The usage limit for the product. |
| 24 | License key | Char (18) | The license key for the product. |
| 42 | Expiration date | Char (7) | The expiration date for the license key. |
| 49 | Vendor data | Char (8) | Data placed in the entry by the product vendor. |
| 57 | Processor group | Char (3) | The processor group for the license key. |

Library renamed (Y YN) journal entry

| Relative offset | Field | Format | Description |
|--|------------------|----------|-------------|
| Entry-specific data. This data appears as one field in the standard output formats: | | | |
| 1 | Old library name | Char(10) | |
| 11 | Reserved | Char(20) | |
| 31 | New library name | Char(10) | |
| 41 | Reserved | Char(20) | |

Logical file associated with the library or based on physical file (D LF, Y LF) journal entry

| Relative offset | Field | Format | Description |
|--|-------|--------|-------------|
| Entry-specific data. This data appears as one field in the standard output formats: | | | |

| Relative offset | Field | Format | Description |
|-----------------|---------------------------------|----------|-------------|
| 1 | Logical file name | Char(10) | |
| 11 | Logical file library name | Char(10) | |
| 21 | Logical file journal identifier | Char(10) | |

Logical unit of work (C LW) journal entry

| Relative offset | Field | Format | Description |
|--|--------------------|--------|---|
| Entry-specific data. This data appears as one field in the standard output formats: | | | |
| 1 | LUW header portion | 416 | The header portion of the entry-specific data contains general information about the logical unit of work (LUW). The layout for the “Logical unit of work (C LW) journal entry - header record” on page 266 describes the contents of the header portion. |
| After the header portion | LUW local portion | 80 | Information about local resources that participated in the LUW. The entry might have 0 to n records for local locations. Each local record is 48 characters long. The layout for the “Logical unit of work (C LW) journal entry - local record” on page 276 describes the local record. |
| After the local portion | LUW API portion | 112 | Information about API resources that participated in the LUW. The entry might have 0 to n records for API resources. Each API resource record is 80 characters long. The layout for the “Logical unit of work (C LW) journal entry - API record” on page 257 describes the API record. |
| After the API portion | LUW DDL portion | 96 | Information about DDL resources that participated in the LUW. The entry might have 0 to n records for DDL resources. Each DDL resource record is 80 characters long. The layout for the “Logical unit of work (C LW) journal entry - DDL record” on page 260 describes the DDL record. |
| After the DDL portion | LUW remote portion | 128 | Information about remote locations that participated in the LUW. The entry might have 0 to n records for remote locations. Each remote location record is 128 characters long. The layout for the “Logical unit of work (C LW) journal entry - RMT record” on page 278 describes the remote record. |
| After the remote portion | LUW DDM portion | 96 | Information about DDM resources that participated in the LUW. The entry might have 0 to n records for DDM resources. Each DDM resource record is 96 characters long. The layout for the “Logical unit of work (C LW) journal entry - DDM record” on page 263 describes the DDM record. |

Logical unit of work (C LW) journal entry - API record

| Relative offset | Field | Format | Description |
|-----------------|----------------------------|------------------|---|
| 1 | Record type | Char (4) | Type of record: API = API Commitment resource record |
| 5 | Record length | Bin (15) | Length of record. Currently 80 for API record. |
| 7 | Record position | (4) ¹ | This identifies the position in the LUW journal entry where this record starts. It is made up of two numbers: <ul style="list-style-type: none"> • Bin (15): The relative number of the journal entry that contains this record. If the LUW journal entry is greater than 32K-1 bytes, multiple entries are actually sent to the journal. This number represents which of these actual journal entries contains this record (1 for the first, 2 for the second, and so on). Note that this is <u>not</u> the actual journal entry sequence number. • Bin (15): The offset where this record starts within this journal entry. This is the number of bytes past the beginning of the entry where this record starts. For example, 0 means the first byte in the entry. |
| 11 | Resource location position | (4) ¹ | This identifies the position in the LUW journal entry where the LCL record starts for this API resource's location. It is made up of two numbers: <ul style="list-style-type: none"> • Bin (15): The relative number of the journal entry that contains the record. If the LUW journal entry is greater than 32K-1 bytes, multiple entries are actually sent to the journal. This number represents which of these actual journal entries contains the record (1 for the first, 2 for the second, and so on). Note that this is <u>not</u> the actual journal entry sequence number. • Bin (15): The offset where the record starts within this journal entry. This is the number of bytes past the beginning of the entry where the record starts. For example, 0 means the first byte in the entry. |

| Relative offset | Field | Format | Description |
|-----------------|------------------------|------------------|---|
| 15 | Next resource position | (4) ¹ | <p>This identifies the position in the LUW journal entry where the next API or DDL record starts for this API resource's location. It is made up of two numbers:</p> <ul style="list-style-type: none"> • Bin (15): The relative number of the journal entry that contains the record. If the LUW journal entry is greater than 32K-1 bytes, multiple entries are actually sent to the journal. This number represents which of these actual journal entries contains the record (1 for the first, 2 for the second, and so on). Note that this is <u>not</u> the actual journal entry sequence number. • Bin (15): The offset where the record starts within this journal entry. This is the number of bytes past the beginning of the entry where the record starts. For example, 0 means the first byte in the entry. <p>Position 0 0 indicates that this is the last resource for this API resource's location.</p> |
| 19 | API resource | Char (10) | Name of API resource. |
| 29 | API program | Char (20) | <p>Name of the exit program for the API resource:</p> <ul style="list-style-type: none"> • Char (10): exit program name • Char (10): exit program library |
| 49 | Journal | Char (20) | <p>Journal related to the location for this resource:</p> <ul style="list-style-type: none"> • Char (10): Journal name (blank if this resource belongs to the location with no journal) • Char (10): Journal library (blank if this resource belongs to the location with no journal) |
| 69 | Commit cycle ID | Bin (31) | The commit cycle identifier for the journal. This is 0 if this resource belongs to the location with no journal. This is -1 if the actual commit cycle identifier value is larger than 2 147 483 647. The Commit cycle ID Long field always contains the correct value. |
| 73 | Commit protocol | Char (1) | <p>The commit protocol for this resource:</p> <p>2 = This is a two-phase resource (API resources are always two-phase resources).</p> |

| Relative offset | Field | Format | Description |
|--|------------------------|--------------|--|
| 74 | Resource usage | Char (2) | The currently allowed access for this resource. The allowed access for some resources can change from one LUW to another depending on whether one-phase resources are registered: RO = This resource is currently read-only. Updates were not made during the LUW. UP = This resource is currently able to be updated. Updates might or might not have been made during the LUW. |
| 76 | API state | Char (2) | Indicates whether the API resource was committed or rolled back successfully: CS = This resource was committed successfully. RS = This resource was rolled back successfully. CF = An attempt to commit this resource failed. RF = An attempt to rollback this resource failed. |
| 78 | API last agent flag | Char (1) | Whether this resource is to be selected as the last agent during all commit requests: Y = This resource is to be selected as the last agent. N = This resource is <u>not</u> to be selected as the last agent. |
| 79 | Allow remote resources | Char (1) | Whether remote resources are allowed to participate in a LUW with this resource: Y = Remote resources are allowed with this resource. N = Remote resources are <u>not</u> allowed with this resource. |
| 80 | Save while active flag | Char (1) | Whether this resource will hold out a save-while-active request until a commitment boundary is reached: Y = This resource will hold save-while-active requests. N = This resource will <u>not</u> hold save-while-active requests. |
| 81 | Commit cycle ID long | Zoned (20,0) | The commit cycle identifier for the journal. This is 0 if this resource belongs to the location with no journal. |
| 101 | Reserved | Char (12) | Reserved for future use. |
| Note: ¹ The format for this field is in the description. | | | |

Logical unit of work (C LW) journal entry - DDL record

| Relative offset | Field | Format | Description |
|-----------------|----------------------------|------------------|---|
| 1 | Record type | Char (4) | Type of record: DDL = SQL Object Change record. |
| 5 | Record length | Bin (15) | Length of record. Currently 624 for DDL record. |
| 7 | Record position | (4) ¹ | This identifies the position in the LUW journal entry where this record starts. It is made up of two numbers: <ul style="list-style-type: none"> • Bin (15): The relative number of the journal entry that contains this record. If the LUW journal entry is greater than 32K-1 bytes, multiple entries are actually sent to the journal. This number represents which of these actual journal entries contains this record (1 for the first, 2 for the second, and so on). Note that this is <u>not</u> the actual journal entry sequence number. • Bin (15): The offset where this record starts within this journal entry. This is the number of bytes past the beginning of the entry where this record starts. For example, 0 means the first byte in the entry. |
| 11 | Resource location position | (4) ¹ | This identifies the position in the LUW journal entry where the LCL record starts for this DDL resource's location. It is made up of two numbers: <ul style="list-style-type: none"> • Bin (15): The relative number of the journal entry that contains the record. If the LUW journal entry is greater than 32K-1 bytes, multiple entries are actually sent to the journal. This number represents which of these actual journal entries contains the record (1 for the first, 2 for the second, and so on). Note that this is <u>not</u> the actual journal entry sequence number. • Bin (15): The offset where the record starts within this journal entry. This is the number of bytes past the beginning of the entry where the record starts. For example, 0 means the first byte in the entry. |

| Relative offset | Field | Format | Description |
|-----------------|------------------------|------------------|---|
| 15 | Next resource position | (4) ¹ | <p>This identifies the position in the LUW journal entry where the next API or DDL record starts for this DDL resource's location. It is made up of two numbers:</p> <ul style="list-style-type: none"> • Bin (15): The relative number of the journal entry that contains the record. If the LUW journal entry is greater than 32K-1 bytes, multiple entries are actually sent to the journal. This number represents which of these actual journal entries contains the record (1 for the first, 2 for the second, and so on). Note that this is <u>not</u> the actual journal entry sequence number. • Bin (15): The offset where the record starts within this journal entry. This is the number of bytes past the beginning of the entry where the record starts. For example, 0 means the first byte in the entry. <p>Position 0 0 indicates that this is the last resource for this DDL resource's location.</p> |

| Relative offset | Field | Format | Description |
|-----------------|--------------------------|-----------|--|
| 19 | DDL resource information | Char (29) | <p>Object identification and operation performed on object:</p> <ul style="list-style-type: none"> • Char (10): First 10 characters of object name. The object name field always contains the full object name. • Char (10): Object library name • Char (7): Object type (*FILE, *LIB or *SQLPKG) • Char (2): Object operation <p>The possible object operations and their meanings are the following:</p> <p>AC = Add PF Constraint CC = Create Collection CF = Create File CG = Create Program CM = Create Member CP = Create SQL Package CS = Create Service Program CT = Create User Defined Type DC = Delete Collection DF = Delete File DG = Drop Program DP = Delete SQL Package DS = Drop Service Program DT = Drop User Defined Type FC = Change File FR = Rename File GF = Grant Files GG = Grant Program GP = Grant to SQL Package GR = Grant Java™ Routine GS = Grant Service Program GT = Grant User Defined Type OP = COMMENT ON SQL Package OT = COMMENT User Defined Type RC = Remove PF Constraint RG = Revoke Program RF = Revoke Files RP = Revoke from SQL Package RR = Revoke Java Routine RS = Revoke Service Program RT = Revoke User Defined Type TA = Add PF Trigger TR = Remove PF Trigger UL = Unlink Datalink XF = Transfer Files</p> |
| 48 | Reserved | Char (1) | Reserved for future use. |

| Relative offset | Field | Format | Description |
|--|----------------------|--------------|---|
| 49 | Journal | Char (20) | Journal related to the location for this resource: <ul style="list-style-type: none"> Char (10): Journal name (blank if this resource belongs to the location with no journal) Char (10): Journal library (blank if this resource belongs to the location with no journal) |
| 69 | Commit cycle ID | Bin (31) | The commit cycle identifier for the journal. This is 0 if this resource belongs to the location with no journal. This is -1 if the actual commit cycle identifier value is larger than 2 147 483 647. The Commit cycle ID Long field always contains the correct value. |
| 73 | Commit protocol | Char (1) | The commit protocol for this resource: 2 = This is a two-phase resource (DDL resources are always two-phase resources). |
| 74 | DDL state | Char (2) | Indicates whether the DDL resource was committed or rolled back successfully: CS = This resource was committed successfully. RS = This resource was rolled back successfully. CF = An attempt to commit this resource failed. RF = An attempt to rollback this resource failed. |
| 76 | Commit cycle ID long | Zoned (20,0) | The commit cycle identifier for the journal. This is 0 if this resource belongs to the location with no journal. |
| 96 | Object name | Char (288) | The full object name. |
| 384 | Reserved | Char (1) | Reserved for future use. |
| Note: ¹ The format for this field is in the description. | | | |

Logical unit of work (C LW) journal entry - DDM record

| Relative offset | Field | Format | Description |
|-----------------|---------------|----------|--|
| 1 | Record type | Char (4) | Type of record: DDM = Remote Database file record. |
| 5 | Record length | Bin (15) | Length of record. Currently 96 for DDM record. |

| Relative offset | Field | Format | Description |
|-----------------|----------------------------|------------------|--|
| 7 | Record position | (4) ¹ | <p>This identifies the position in the LUW journal entry where this record starts. It is made up of two numbers:</p> <ul style="list-style-type: none"> • Bin (15): The relative number of the journal entry that contains this record. If the LUW journal entry is greater than 32K-1 bytes, multiple entries are actually sent to the journal. This number represents which of these actual journal entries contains this record (1 for the first, 2 for the second, and so on). Note that this is <u>not</u> the actual journal entry sequence number. • Bin (15): The offset where this record starts within this journal entry. This is the number of bytes past the beginning of the entry where this record starts. For example, 0 means the first byte in the entry. |
| 11 | Resource location position | (4) ¹ | <p>This identifies the position in the LUW journal entry where the RMT record starts for this DDM file's location. It is made up of two numbers:</p> <ul style="list-style-type: none"> • Bin (15): The relative number of the journal entry that contains the record. If the LUW journal entry is greater than 32K-1 bytes, multiple entries are actually sent to the journal. This number represents which of these actual journal entries contains the record (1 for the first, 2 for the second, and so on). Note that this is <u>not</u> the actual journal entry sequence number. • Bin (15): The offset where the record starts within this journal entry. This is the number of bytes past the beginning of the entry where the record starts. For example, 0 means the first byte in the entry. |

| Relative offset | Field | Format | Description |
|-----------------|-----------------------------|------------------|--|
| 15 | Next resource position | (4) ¹ | <p>This identifies the position in the LUW journal entry where the next DDM record starts for this DDM file's location. It is made up of two numbers:</p> <ul style="list-style-type: none"> • Bin (15): The relative number of the journal entry that contains the record. If the LUW journal entry is greater than 32K-1 bytes, multiple entries are actually sent to the journal. This number represents which of these actual journal entries contains the record (1 for the first, 2 for the second, and so on). Note that this is <u>not</u> the actual journal entry sequence number. • Bin (15): The offset where the record starts within this journal entry. This is the number of bytes past the beginning of the entry where the record starts. For example, 0 means the first byte in the entry. <p>Position 0 0 indicates that this is the last resource for this DDM file's location.</p> |
| 19 | DDM file | Char (20) | <p>Name of the DDM file and library for the open remote file:</p> <ul style="list-style-type: none"> • Char (10): DDM file name • Char (10): DDM file library name |
| 29 | Remote position information | Char (54) | <p>Identification of the remote location and communication information for this resource's location:</p> <ul style="list-style-type: none"> • Char (10): Remote position name • Char (10): Device name • Char (10): Mode • Char (8): Remote network ID • Char (8): Conversation correlator network ID • Char (8): Transaction program name |
| 93 | Open flag | Char (1) | <p>Whether the DDM file was open or closed when this LUW ended:</p> <p>O = The DDM file was open. C = The DDM file was closed.</p> |
| 94 | Commit protocol | Char (1) | <p>The commit protocol for this resource:</p> <p>1 = This is a one-phase resource. 2 = This is a two-phase resource.</p> |

| Relative offset | Field | Format | Description |
|--|----------------|----------|---|
| 95 | Resource usage | Char (2) | <p>The currently allowed access for this resource. The allowed access for some resources can change from one LUW to another depending on whether one-phase resources are registered:</p> <p>RO = This resource is currently read-only. Updates were not made during the LUW.</p> <p>UP = This resource is currently able to be updated. Updates might or might not have been made during the LUW.</p> <p>Note: This does <u>not</u> indicate whether updates were actually made during the LUW. It only indicates whether updates are allowed, given the other resources currently registered.</p> |
| Note: ¹ The format for this field is in the description. | | | |

Logical unit of work (C LW) journal entry - header record

| Relative offset | Field | Format | Description |
|-----------------|---------------------------|------------------|---|
| 1 | Record type | Char (4) | <p>Type of record:</p> <p>HDR = Header record.</p> |
| 5 | Record length | Bin (15) | Length of record. Currently 400 for HDR record. |
| 7 | Record position | (4) ¹ | <p>This identifies the position in the LUW journal entry where this record starts. It is made up of two numbers:</p> <ul style="list-style-type: none"> • Bin (15): The relative number of the journal entry that contains this record. If the LUW journal entry is greater than 32K-1 bytes, multiple entries are actually sent to the journal. This number represents which of these actual journal entries contains this record (1 for the first, 2 for the second, and so forth). Note that this is <u>not</u> the actual journal entry sequence number. • Bin (15): The offset where this record starts within this journal entry. This is the number of bytes past the beginning of the entry where this record starts. For example, 0 means the first byte in the entry. Because they always start at the beginning of the journal entry, this offset is always 0 for HDR records. |
| 11 | Number of journal entries | Bin (15) | The number of actual journal entries sent for this LUW journal entry. This is 1 unless the LUW journal entry is greater than 32K-1 bytes. |

| Relative offset | Field | Format | Description |
|-----------------|--------------------------------------|------------------|---|
| 13 | position with no journal position | (4) ¹ | <p>This identifies the position in the LUW journal entry where the LCL record starts for the local location with no journal. It is made up of two numbers:</p> <ul style="list-style-type: none"> • Bin (15): The relative number of the journal entry that contains the record. If the LUW journal entry is greater than 32K-1 bytes, multiple entries are actually sent to the journal. This number represents which of these actual journal entries contains the record (1 for the first, 2 for the second, and so forth). Note that this is not the actual journal entry sequence number. • Bin (15): The offset where the record starts within this journal entry. This is the number of bytes past the beginning of the entry where the record starts. For example, 0 means the first byte in the entry. <p>Position 0 0 means that there is no local location that does not have a journal.</p> |
| 17 | First location with journal position | (4) ¹ | <p>This identifies the position in the LUW journal entry where the LCL record starts for the first local location with a journal. It is made up of two numbers:</p> <ul style="list-style-type: none"> • Bin (15): The relative number of the journal entry that contains the record. If the LUW journal entry is greater than 32K-1 bytes, multiple entries are actually sent to the journal. This number represents which of these actual journal entries contains the record (1 for the first, 2 for the second, and so on). Note that this is <u>not</u> the actual journal entry sequence number. • Bin (15): The offset where the record starts within this journal entry. This is the number of bytes past the beginning of the entry where the record starts. For example, 0 means the first byte in the entry. <p>Position 0 0 means that there are no local locations with a journal.</p> |

| Relative offset | Field | Format | Description |
|-----------------|---|------------------|--|
| 21 | First remote location position | (4) ¹ | <p>This identifies the position in the LUW journal entry where the RMT record starts for the first remote location. It is made up of two numbers:</p> <ul style="list-style-type: none"> • Bin (15): The relative number of the journal entry that contains the record. If the LUW journal entry is greater than 32K-1 bytes, multiple entries are actually sent to the journal. This number represents which of these actual journal entries contains the record (1 for the first, 2 for the second, and so on). Note that this is <u>not</u> the actual journal entry sequence number. • Bin (15): The offset where the record starts within this journal entry. This is the number of bytes past the beginning of the entry where the record starts. For example, 0 means the first byte in the entry. <p>Position 0 0 means there are no remote locations.</p> |
| 25 | LUW operation | Char (2) | <p>The operation that was performed to end this LUW:</p> <p>CM = A commit operation was performed. This does not necessarily mean that the resources were committed. In some cases a commit operation is changed to a rollback operation with respect to two-phase commit rules.</p> <p>RB = A rollback operation was performed. An attempt was made to roll back all resources.</p> |
| 27 | Protected logical unit of work identifier (LUWID) | Char (41) | <p>The format for the LUWID is:</p> <ul style="list-style-type: none"> • Bin (15): The total length of the LUWID not including this field • Char (0 to 8): The network ID • Char (1): The separator character . • Char (0 to 8): The local location name • Char (3): The separator characters .X' • Char (12): The hex value of the instance number converted to character • Char (2): The separator characters '. • Char (5): The hex value of the sequence number converted to decimal |
| 68 | Unprotected logical unit of work identifier | Char (41) | <p>The format for the LUWID for unprotected conversations is the same as for protected conversations.</p> |

| Relative offset | Field | Format | Description |
|-----------------|----------------------------------|-----------|---|
| 109 | Default journal commit cycle ID | Bin (31) | The commit cycle identifier for the default journal for this LUW. This is 0 if no commit cycle was started for this journal during this LUW. This is -1 if the actual commit cycle identifier value is larger than 2 147 483 647. The Default Journal Commit cycle ID Long field always contains the correct value. |
| 113 | Commitment definition name | Char (10) | The name of the commitment definition for which this LUW took place. |
| 123 | Commitment definition identifier | Char (10) | The commitment definition identifier of the commitment definition. This is not useful to the user. |
| 133 | Qualified job name | Char (26) | The job that created the commitment definition. |
| 159 | Reserved | Char (1) | Reserved for future use. Currently always blank. |
| 160 | Commitment definition scope | Char (1) | The scope of the commitment definition: A = Activation group level commitment definition. E = Explicitly named commitment definition. J = JOB commitment definition. |
| 161 | Activation group mark | Bin (31) | The activation group mark for the commitment definition: 0 = This is the *JOB or an explicitly named commitment definition. 2 = This is the *DFACTGRP commitment definition. # = The number of the activation group for this activation group level commitment definition. |
| 165 | Notify object | Char (37) | The notify object for the commitment definition: <ul style="list-style-type: none"> • Char (10) - Object name • Char (10) - Object library • Char (10) - Object member (blank if object is not a file) • Char (7) - Object type (*MSGQ, *DTAARA or *FILE) |
| 202 | Default journal | Char (20) | The default journal for the commitment definition: <ul style="list-style-type: none"> • Char (10): Journal name • Char (10): Journal library |

| Relative offset | Field | Format | Description |
|-----------------|-----------------|----------|---|
| 222 | Initiation type | Char (1) | <p>Whether this commit or rollback operation was initiated by the user or by the system:</p> <p>E = Explicit commit or rollback operation initiated by the user.</p> <p>I = Implicit commit or rollback operation due to activation group end, job end, or system end.</p> <p>If the LUW was finished after a system end, this is set to I, even if an explicit commit or rollback operation was running at the time the system ended.</p> |
| 223 | LUW end status | Char (1) | <p>Indication of when this LUW ended with respect to the job that created the commitment definition for which this LUW took place:</p> <p>N = The LUW ended while the job was running normally.</p> <p>E = The LUW ended during job end. This means that the LUW was still pending when a request was made to end the job. If the requested operation is CM, then a commit request had started before the request to end the job and was finished during the job-end phase.</p> <p>I = The LUW ended during the IPL following a system end. If the requested operation is CM, then a commit request was started before the system end and was finished during the IPL.</p> <p>P = The LUW ended after the IPL following a system end. In this case, the requested operation is CM and the LUW was prepared pending the commit/rollback decision from the initiator or last agent when the system ended. During the IPL, local resources were brought back to a prepared state in a system database server job. After resynchronization was performed to learn the commit/rollback decision, the LUW ended by committing or rolling back the local resources in that same system database server job.</p> |
| 224 | Sync-point role | Char (1) | <p>The sync-point role played by this location during a commit operation:</p> <p>I = Initiator: the root of the sync-point tree.</p> <p>C = Cascaded initiator: an intermediate location in the sync-point tree.</p> <p>A = Agent: a leaf location in the sync-point tree.</p> <p>blank = This LUW ended in a rollback request.</p> |

| Relative offset | Field | Format | Description |
|-----------------|--------------|----------|---|
| 225 | Partner role | Char (1) | <p>The partner role played by this location during a commit:</p> <p>I = Initiator: the root of the sync-point tree.</p> <p>N = Not-last agent: a prepare request was sent to this location during the prepare wave.</p> <p>L = Last agent: a prepare request was not sent to this location during the prepare wave. Instead, a request was made to this location during the committed wave to attempt a full commit operation before reporting results back to its initiator.</p> <p>blank = This LUW ended in a rollback request</p> |

| Relative offset | Field | Format | Description |
|-----------------|-----------------|----------|---|
| 226 | LUW disposition | Char (2) | <p>The overall disposition of the LUW:</p> <p>RO = This location and all downstream locations voted read-only. These resources were not committed or rolled back because they were not changed during the LUW. It is not known whether the other locations in the sync-point tree committed or rolled back.</p> <p>CM = All resources committed. No errors have been detected to this point. If the Resync In Progress indicator field is N, the LUW has completely committed. Otherwise, resynchronization is still going on to assure this location that other locations committed completely.</p> <p>CF = An attempt was made to commit all resources, but one or more errors have occurred. The job log, QHST, and QSYSOPR *MSGQ can be checked to determine the errors.</p> <p>RB = All resources rolled back successfully.</p> <p>RF = An attempt was made to roll back all resources, but one or more errors have occurred. The job log, QHST, and QSYSOPR *MSGQ can be checked to determine the errors.</p> <p>HD = Heuristic damage has occurred. This means one of two things:</p> <ol style="list-style-type: none"> 1. Some of the resources at this location or downstream locations committed while others rolled back because an operator performed a heuristic commit operation or rollback operation. 2. An unexpected error occurred while committing or rolling back resources at this location or downstream locations due to a hardware or software problem. <p>When heuristic damage occurs, the following LUW journal entry records can be checked to learn the status of the changes made during the LUW to individual resources:</p> <p>LCL = The Record I/O State field indicates the status of the record I/O performed on files journaled to the journal related to that location.</p> <p>API = The API State field indicates the status of that API Commitment resource.</p> <p>DDL = The DDL State field indicates the status of that SQL Object Change.</p> <p>RMT = The Resource State field indicates the status of the resources at the remote location.</p> |

| Relative offset | Field | Format | Description |
|-----------------|-------------------------------|----------|---|
| 228 | Heuristic operation indicator | Char (1) | <p>Whether a heuristic commit or rollback operation occurred at this location while a commit request was being performed for this LUW:</p> <p>blank = No heuristic operation occurred. C = A heuristic commit operation occurred. R = A heuristic rollback operation occurred.</p> <p>A heuristic commit operation or rollback operation means that the operator took explicit action (while this location was waiting for the commit or rollback decision from the initiator or the last agent) to commit or to roll back the resources at this location and all prepared downstream locations. Heuristic operations can result in some resources committing while others roll back. The LUW Disposition field can be checked to see if this has happened (it would be HD). The Resync In Progress indicator field can also be checked. If it is O, heuristic damage might have occurred or it might still occur because the state of the resources at the locations where resynchronization is still going on is unknown. Messages are written to the history log and to the system database server job logs when the resynchronization processes complete to indicate whether damage occurred. If damage occurs, messages are also sent to the system operator when it is detected.</p> |
| 229 | Resync in progress indicator | Char (1) | <p>Whether resync to one or more remote locations was still ongoing when the LUW ended:</p> <p>N = Either no resynchronization was required during this LUW, or it was required and completed before the LUW ended. O = Resynchronization was going on with one or more of the locations. This can occur only if the WAIT_FOR_OUTCOME synchronization point option is NO, or if the LUW was interrupted by job or system end.</p> |

| Relative offset | Field | Format | Description |
|-----------------|--------------------------|----------|---|
| 230 | Wait for outcome | Char (1) | <p>The value of the Wait for outcome commitment option. This indicates whether to wait for resynchronization to complete if a communication or system failure occurs during a commit or rollback.</p> <p>Y = Wait for outcome. L = Wait for outcome during commits initiated by this commitment definition or during commits initiated at a system that does not support presumed abort. Inherit the initiator's wait for outcome value during commits initiated at a system that supports presumed abort. N = Do not wait for outcome. U = Do not wait for outcome during commits initiated by this commitment definition or during commits initiated at a system that does not support presumed abort. Inherit the initiator's wait for outcome value during commits initiated at a system that supports presumed abort.</p> |
| 231 | Action if problems | Char (1) | <p>The value of the Action if problems commitment option. This indicates whether to commit or rollback when problems occur during a two-phase commit.</p> <p>R = Rollback if problems occur. C = Commit if problems occur.</p> |
| 232 | Vote read-only permitted | Char (1) | <p>The value of the Vote read-only permitted commitment option. This indicates whether this commitment definition is allowed to return a read-only vote to a remote initiator during a two-phase commit.</p> <p>N = Do not allow a read-only vote. Y = Allow a read-only vote.</p> |
| 233 | Action if ENDJOB | Char (1) | <p>The value of the Action if ENDJOB commitment option. This indicates the action to take for changes associated with the LUW when the job the LUW is a part of is ended.</p> <p>W = Wait to allow normal processing of the LUW to complete. R = Rollback during ENDJOB. C = Commit during ENDJOB.</p> |

| Relative offset | Field | Format | Description |
|-----------------|---------------------------------|-----------|--|
| 234 | OK to leave out | Char (1) | <p>The value of the OK to leave out commitment option. This indicates whether this location is allowed to be left out during the next commit/rollback if no activity occurred to this location during the LUW.</p> <p>N = Do not leave this location out of the next commit or rollback operation. Y = It is OK to leave this location out of the next commit or rollback operation.</p> |
| 235 | Last agent permitted | Char (1) | <p>The value of the Last agent permitted commitment option. This indicates whether last agent optimization may be used.</p> <p>S = The system is allowed to select a last agent. N = The system is not allowed to select a last agent.</p> |
| 236 | Accept vote reliable | Char (1) | <p>The value of the Accept vote reliable commitment option. This indicates whether the vote reliable indicator received from agents during a commit operation is accepted by this location. If an agent votes reliable, and this location accepts it, control is returned to the application before the committed wave is completed for that agent. If this location does not accept vote reliable, control is returned to the application only after the LUW is completely committed or rolled back.</p> <p>Y = Accept the vote reliable indicator from agents during commit operations. N = Do not accept the vote reliable indicator from agents during commit operations.</p> |
| 237 | Resolved wait for outcome value | Char (1) | <p>This indicates the actual wait for outcome value that was used during the commit or rollback of this LUW. If the Wait for outcome commitment option is L or U, this value might have been inherited from this location's initiator.</p> <p>Y = Wait for outcome of resynchronization. N = Do not wait for outcome of resynchronization.</p> |
| 238 | XA transaction manager | Char (10) | <p>If this was an X/Open transaction, this is the name of the XA Transaction Manager that was specified on the db2xa_open API. This field will be hex zeros if this was not an XA transaction.</p> |

| Relative offset | Field | Format | Description |
|--|--------------------------------------|--------------|--|
| 248 | XID | Char (140) | <p>If this was an X/Open Transaction, this is the X/Open Transaction Identifier associated with this transaction. This field will be hex zeros if this was not an X/Open transaction, or if it was an X/Open local transaction. The format of this field is as follows:</p> <pre> Bin(31) format identifier Bin(31) global transaction identifier length Bin(31) branch qualifier length Char (128) XID value </pre> |
| 388 | Default journal commit cycle ID long | Zoned (20,0) | The commit cycle identifier for the default journal for this LUW. This is 0 if no commit cycle was started for this journal during this LUW. |
| 408 | Reserved | Char (9) | Reserved for future use. |
| Note: ¹ The format for this field is in the description. | | | |

Logical unit of work (C LW) journal entry - local record

| Relative offset | Field | Format | Description |
|-----------------|-----------------|------------------|--|
| 1 | Record type | Char (4) | Type of record: LCL = Local location record. |
| 5 | Record length | Bin (15) | Length of record. Currently 48 for LCL record. |
| 7 | Record position | (4) ¹ | <p>This identifies the position in the LUW journal entry where this record starts. It is made up of two numbers:</p> <ul style="list-style-type: none"> • Bin (15): The relative number of the journal entry that contains this record. If the LUW journal entry is greater than 32K-1 bytes, multiple entries are actually sent to the journal. This number represents which of these actual journal entries contains this record (1 for the first, 2 for the second, and so on). Note that this is <u>not</u> the actual journal entry sequence number. • Bin (15): The offset where this record starts within this journal entry. This is the number of bytes past the beginning of the entry where this record starts. For example, 0 means the first byte in the entry. |

| Relative offset | Field | Format | Description |
|-----------------|------------------------------|------------------|--|
| 11 | Next local location position | (4) ¹ | <p>This identifies the position in the LUW journal entry where the next LCL record starts. It is made up of two numbers:</p> <ul style="list-style-type: none"> • Bin (15): The relative number of the journal entry that contains the record. If the LUW journal entry is greater than 32K-1 bytes, multiple entries are actually sent to the journal. This number represents which of these actual journal entries contains the record (1 for the first, 2 for the second, and so on). Note that this is <u>not</u> the actual journal entry sequence number. • Bin (15): The offset where the record starts within this journal entry. This is the number of bytes past the beginning of the entry where the record starts. For example, 0 means the first byte in the entry. <p>Position 0 0 indicates that this is the last local location.</p> |
| 15 | First resource position | (4) ¹ | <p>This identifies the position in the LUW journal entry where the first API or DDL record starts for this location. It is made up of two numbers:</p> <ul style="list-style-type: none"> • Bin (15): The relative number of the journal entry that contains the record. If the LUW journal entry is greater than 32K-1 bytes, multiple entries are actually sent to the journal. This number represents which of these actual journal entries contains the record (1 for the first, 2 for the second, and so on). Note that this is <u>not</u> the actual journal entry sequence number. • Bin (15): The offset where the record starts within this journal entry. This is the number of bytes past the beginning of the entry where the record starts. For example, 0 means the first byte in the entry. |

| Relative offset | Field | Format | Description |
|--|----------------------|--------------|--|
| 19 | Record I/O state | Char (2) | Indicates whether the record I/O performed during this LUW for files journaled to the journal related to this location was committed or rolled back successfully: CS Record I/O for this location was committed successfully. RS = Record I/O for this location was rolled back successfully. CF = An attempt to commit record I/O for this location failed. RF = An attempt to rollback record I/O for this location failed. blank = This is the location with no journal so there is no record I/O associated with it. |
| 21 | Journal | Char (20) | Journal related to this location: <ul style="list-style-type: none"> Char (10): Journal name (blank if this is the location with no journal) Char (10): Journal library (blank if this is the location with no journal) |
| 41 | Commit cycle ID | Bin (31) | The commit cycle identifier for the journal. This is 0 for the location with no journal. It might be 0 for the location related to the default journal if there were no resources for that location during this LUW. This is -1 if the actual commit cycle identifier value is larger than 2 147 483 647. The Default Journal Commit cycle ID Long field always contains the correct value. |
| 45 | Default journal flag | Char (1) | Indicates whether the journal related to this location is the default journal: Y = It is the default journal. N = It is not the default journal. |
| 46 | Commit cycle ID Long | Zoned (20,0) | The commit cycle identifier for the journal. This is 0 for the location with no journal. It might be 0 for the location related to the default journal if there were no resources for that location during this LUW. |
| 66 | Reserved | Char (15) | Reserved for future use. |
| Note: ¹ The format for this field is in the description. | | | |

Logical unit of work (C LW) journal entry - RMT record

| Relative offset | Field | Format | Description |
|-----------------|---------------|----------|-------------------------------|
| 1 | Record type | Char (4) | Remote position (RMT) record. |
| 5 | Record length | Bin (15) | RMT record is currently 128. |

| Relative offset | Field | Format | Description |
|-----------------|--------------------------------|------------------|---|
| 7 | Record position | (4) ¹ | <p>This identifies the position in the LUW journal entry where this record starts. It is made up of two numbers:</p> <ul style="list-style-type: none"> • Bin (15): The relative number of the journal entry that contains this record. If the LUW journal entry is greater than 32K-1 bytes, multiple entries are actually sent to the journal. This number represents which of these actual journal entries contains this record (1 for the first, 2 for the second, and so on). Note that this is <u>not</u> the actual journal entry sequence number. • Bin (15): The offset where this record starts within this journal entry. This is the number of bytes past the beginning of the entry where this record starts. For example, 0 means the first byte in the entry. |
| 11 | Next Rremote location position | (4) ¹ | <p>This identifies the position in the LUW journal entry where the next RMT record starts. It is made up of two numbers:</p> <ul style="list-style-type: none"> • Bin (15): The relative number of the journal entry that contains the record. If the LUW journal entry is greater than 32K-1 bytes, multiple entries are actually sent to the journal. This number represents which of these actual journal entries contains the record (1 for the first, 2 for the second, and so on). Note that this is <u>not</u> the actual journal entry sequence number. • Bin (15): The offset where the record starts within this journal entry. This is the number of bytes past the beginning of the entry where the record starts. For example, 0 means the first byte in the entry. <p>Position 0 0 indicates that this is the last remote location.</p> |

| Relative offset | Field | Format | Description |
|-----------------|--------------------------------|------------------|--|
| 15 | First resource position | (4) ¹ | <p>This identifies the position in the LUW journal entry where the first DDM record starts for this location. It is made up of two numbers:</p> <ul style="list-style-type: none"> • Bin (15): The relative number of the journal entry that contains the record. If the LUW journal entry is greater than 32K-1 bytes, multiple entries are actually sent to the journal. This number represents which of these actual journal entries contains the record (1 for the first, 2 for the second, and so on). Note that this is <u>not</u> the actual journal entry sequence number. • Bin (15): The offset where the record starts within this journal entry. This is the number of bytes past the beginning of the entry where the record starts. For example, 0 means the first byte in the entry. <p>Position 0 0 indicates that there are no DDM records for this location.</p> |
| 19 | Remote position information | Char (54) | <p>Identification of the remote location and communication information for this location:</p> <ul style="list-style-type: none"> • Char (10): Remote position name • Char (10): Device name • Char (10): Mode • Char (8): Remote network ID • Char (8): Conversation correlator network ID • Char (8): Transaction program name |
| 73 | Relational database name | Char (18) | The name of the relational database opened at this remote location (blank if no relational database has been opened). |
| 91 | Conversation deallocation flag | Char (1) | <p>Whether the conversation was deallocated because of this LUW:</p> <p>N = This conversation is still active. Y = This conversation was deallocated because the LUW committed, the system ended, a resource failed, or an unbind was performed.</p> |
| 92 | Commit protocol | Char (1) | <p>The commit protocol for the resources at this location:</p> <p>1 = The resources are one-phase. 2 = The resources are two-phase.</p> |

| Relative offset | Field | Format | Description |
|-----------------|----------------|----------|--|
| 93 | Resource usage | Char (2) | <p>The currently allowed access for this resource. The allowed access for some resources can change from one LUW to another depending on whether one-phase resources are registered:</p> <p>RO = This resource is currently read-only. Updates were not made during the LUW.</p> <p>UP = This resource is currently able to be updated. Updates might or might not have been made during the LUW.</p> <p>Note: This does <u>not</u> indicate whether updates were actually made during the LUW. It indicates only whether updates are allowed, given the other resources currently registered.</p> |
| 95 | Resource state | Char (2) | <p>The state of the resources at this location:</p> <p>CS = The resources were committed successfully.</p> <p>CF = An attempt to commit the resources failed. This value is only used for one-phase locations.</p> <p>RS = The resources were rolled back successfully.</p> <p>RF = An attempt to rollback the resources failed. This value is only used for one-phase locations.</p> <p>NC = The resources had no changes for the current transaction.</p> <p>FC = A communications failure occurred for this location. It is not known whether resources at the location committed or rolled back.</p> <p>HC = The resources were heuristically committed.</p> <p>HR = The resources were heuristically rolled back.</p> <p>HM = Heuristic damage was detected at this location. Some of the resources at the location, or locations further downstream, committed while others rolled back.</p> <p>ER = An unexpected error occurred while communicating with this location. This is due to a hardware or software problem. The state of the resources is unknown.</p> <p>RI = We have not yet learned the state of the resources because resync is still ongoing.</p> |
| 97 | Allocator flag | Char (1) | <p>Indicates whether this is the allocator location, for example, the location that called the transaction program running on this system:</p> <p>Y = This location is the allocator.</p> <p>N = This location is <u>not</u> the allocator.</p> |

| Relative offset | Field | Format | Description |
|-----------------|------------------------|----------|---|
| 98 | Remote last agent flag | Char (1) | <p>Indicates whether this location was selected as the last agent if a commit request was performed to end this LUW:</p> <p>Y = This is the last agent. N = This is <u>not</u> the last agent.</p> <p>Note: A last agent will not be selected at this location unless the Partner Role field in the HDR record is I or L.</p> |
| 99 | Two-phase protocol | Char (1) | <p>The two-phase commit protocol options supported at this location.</p> <p>0 = Two-phase commit protocols are not supported. 1 = Two-phase commit presumed nothing protocols are supported. 2 = Two-phase commit presumed abort protocols are supported.</p> |
| 100 | Resync initiator | Char (1) | <p>If resync with this location is still ongoing (the Resource State field is RI), this value indicates whether the local location is initiating the resync attempts.</p> <p>I = The local system is initiating resync with this remote location. N = Resync is not being performed with this remote location. W = The local system is waiting for resync to be initiated from this remote location.</p> |
| 101 | Voted reliable | Char (1) | <p>Whether this location voted reliable during the commit of this LUW.</p> <p>Y = The location voted reliable. N = The location did not vote reliable.</p> |
| 102 | OK to leave out | Char (1) | <p>Whether this location indicated it may be left out of the next commit or rollback operation if no communications flows occur to that location during the next LUW.</p> <p>Y = The location indicated it may be left out. N = The location indicated it may not be left out.</p> |
| 103 | Left out | Char (1) | <p>Whether this location was left out of the LUW that was just committed or rolled back.</p> <p>Y = The location was left out. N = The location was not left out.</p> |

| Relative offset | Field | Format | Description |
|--|----------------|-----------|--|
| 104 | Initiator flag | Char (1) | Indicates whether this location is the initiator location, i.e. the location that sent the commit or rollback request to this system. Y = The location is the initiator. N = The location is <u>not</u> the initiator. Note: The system cannot determine the initiator location if the initiator does not support two-phase commit protocols. This field will always be set to N for locations that do not support two-phase commit protocols. |
| 105 | Reserved | Char (24) | Reserved for future use. |
| Note: ¹ The format for this field is in the description. | | | |

Mail server framework system level events (S SY) journal entry

| Relative offset | Field | Format | Description |
|-----------------|-----------------|-------------|--|
| 1 | Entry length | Zoned(5,0) | Total length of the journal entry, including the entry length field. |
| 6 | Sequence number | Zoned(10,0) | Applied to each journal entry. Initially set to 1 for each new or restored journal. Reset when a new receiver is attached. |
| 16 | Journal code | Char(1) | Always S for MSF entries. |
| 17 | Entry type | Char(2) | Always SY for MSF system level events entries. |
| 19 | Date stamp | Char(6) | The system date that the entry was made. |
| 25 | Time stamp | Zoned(6,0) | The system time that the entry was made. |
| 31 | (Reserved area) | Char(95) | |
| 126 | Job name | Char(10) | The name of the job that caused the entry to occur. |
| 136 | User name | Char(10) | The user-profile name associated with the job. |
| 146 | Job number | Zoned(6,0) | The job number. |
| 152 | Program name | Char(8) | The name of the MSF program that made the journal entry. |

| Relative offset | Field | Format | Description |
|-----------------|---------------------|------------|--|
| 160 | Function identifier | Char(1) | Function that was being performed when the entry was made. The possible values are: 1 STRMSF command started (QMSF jobs) 2 Internal tables initialized (part of STRMSF command function) 3 Internal queues initialized (part of STRMSF command function) 4 Space pool index created and initialized 5 ENDMSF command started (ended QMSF jobs) 6 Damaged or destroyed internal space found 7 Message destroyed by using DATAAREA QZMFKQ value 8 Abnormal IPL destroyed in internal MSF space index 9 MSF clean up functions (part of Reclaim Storage (RCLSTG) command) started A MSF space clean up function started B MSF clean up functions completed C MSF reclaim storage function ended |
| 161 | Data length | Zoned(5,0) | The length of the logged data. |
| 166 | Logged data | Char(256) | The data logged by MSF when the function identifier is: 6 32 character MSF message ID 7 32 character MSF message ID followed by total number of internal entries destroyed |

Moving and renaming objects (D FM, D FN, E EM, E EN, F MM, F MN, F PM, F PN, J MJ, Q QM, Q QN) journal entries

| Relative offset | Field | Format | Description |
|---|-------|--------|-------------|
| Specific values for this entry type: | | | |

| Relative offset | Field | Format | Description |
|--|----------------------------|-----------|--|
| | Journal identifier (JOJID) | Char (10) | Records for the entries will have a journal identifier. The JID is not provided with the *TYPE1, *TYPE2, and *TYPE3 formats. It can be used with the QJORJIDI API. |
| | Flag (JOFLAG) | Char (1) | The status of the object's library: 0 = The object's library is not journaled or is journaled to a different journal. 1 = The object's library is journaled to the same journal as the object. |
| Entry-specific data. This data appears as one field in the standard output formats: | | | |
| 1 | Object name before | Char (10) | The name of the object before the object was moved or renamed. |
| 11 | Library name before | Char (10) | The name of the library before the object was moved or renamed. |
| 21 | Member name before | Char (10) | The name of the member before it was moved or renamed. This field is blank if the object is not a physical database file. |
| 31 | Object name after | Char (10) | The name of the object after the object was moved or renamed. |
| 41 | Library name after | Char (10) | The name of the library after the object was moved or renamed. |
| 51 | Member name after | Char (10) | The name of the member after it was moved or renamed. This field is blank if the object is not a physical database file. |
| 61 | Internal data | Char (*) | Internal system information. Note: This field does not apply to E EM, E EN, Q QM, or Q QN entries. |

Object added to library (Y YO) journal entry

| Relative offset | Field | Format | Description |
|--|------------------|-----------|--|
| Entry-specific data. This data appears as one field in the standard output formats: | | | |
| 1 | Object name | Char (10) | |
| 11 | Object type | Char (10) | |
| 21 | Reserved | Char (20) | |
| 31 | Insert operation | Char (1) | Insert operation: 'C' - create 'M' - move 'R' - restore |
| 41 | Object JID | Char (10) | Object's journal identifier |

| Relative offset | Field | Format | Description |
|-----------------|--------------------|----------|--|
| 51 | Inherit journaling | Char (1) | Did object inherit journaling from library: '0' - No '1' - Yes |

Object level (D AC, D CG, D CT, D DC, D DT, D GC, D GO, D GT, D M1, D M2, D M3, D P1, D P2, D P3, D RV, D TC, D TD, D TG, D TQ, F CB, F DM, F MC) journal entries

| Relative offset | Field | Format | Description |
|--|--------------------|-----------|--|
| Entry-specific data. This data appears as one field in the standard output formats: | | | |
| 1 | Object name | Char (10) | The name of the object that was operated on. |
| 11 | Library name | Char (10) | The name of the library for the object that was operated on. |
| 21 | Member name | Char (10) | The name of the member that was operated on, if applicable. This field is blank if it does not apply. |
| 31 | New Object name | Char (10) | The new name of the file if this is a rename file, rename member or move file operation. This field is blank if it does not apply. |
| 41 | New object library | Char (10) | The new name of the lib if this is a move file, rename file or rename member operation. This field is blank if it does not apply. |
| 51 | New member name | Char (10) | The new name of the member if this is a rename member operation. This field is blank if it does not apply. |
| 61 | Reserved | Char (12) | Reserved |
| 73 | Apply length | Bin (31) | The length of the extra ESD data pointed to by the teraspace pointer if the incomplete flag is on. |
| 77 | Reserved | Char (32) | Reserved |

| Relative offset | Field | Format | Description |
|-----------------|-------------------|----------|--|
| 109 | Change field type | Char (1) | <p>If the journal entry is CG, the following subtype values are returned:</p> <ul style="list-style-type: none"> 0 = SQL ALTER TABLE 1 = CHGPF, CHGLF, or CHGSRCPF CL command 2 = Miscellaneous change file operations 3 = SQL DELETE FROM table (without a WHERE clause) 4 = Restore deferred MQT 5 = Internal change file operation 6 = Internal change file operation 7 = Create/Replace SQL view 8 = SQL TRUNCATE TABLE J = Activate/Deactivate row and column access control <p>If the journal entry is TG the following subtype values are returned:</p> <ul style="list-style-type: none"> 4 = Disable Trigger 5 = Enable Trigger 6 = Miscellaneous change trigger operations 7 = Change trigger to secured 8 = Change trigger to unsecured <p>If the journal entry is CT or MC, these subtype values are returned:</p> <ul style="list-style-type: none"> 7 = Restore 8 = CPYF CRTFILE(*YES) or CRTDUPOBJ 9 = Other Create <p>If the journal entry is CB, the following subtype values are returned:</p> <ul style="list-style-type: none"> A = CHGPFM or CHGLFM B = CHGDBMI macro C = Statistics request D = Increment request <p>If the journal entry is GC, the following subtype values are returned:</p> <ul style="list-style-type: none"> G = Comment or label on constraint H = Enable constraint checked I = Enable constraint unchecked 'XX'x = Internal <p>If the journal entry is M3, the following subtype values are returned:</p> <ul style="list-style-type: none"> 4 = Disable mask 5 = Enable mask 6 = Miscellaneous change mask operations 7 = Regenerate |

| Relative offset | Field | Format | Description |
|--------------------|---|-----------|---|
| 109 (continued) | Change field type | Char (1) | <p>If the journal entry is P3, the following subtype values are returned:</p> <ul style="list-style-type: none"> 4 = Disable permission 5 = Enable permission 6 = Miscellaneous change permission operations 7 = Regenerate <p>If the journal entry is RM, the following subtype values are returned:</p> <ul style="list-style-type: none"> E = Classic RGZPFM F = Concurrent RGZPFM <p>This field is not applicable if the entry type is not CG, CT, MC, M3, P3, RM, TG, CB, or GC.</p> |
| 110 | State | Char (1) | <p>New state of the constraint (GC entry only)</p> <ul style="list-style-type: none"> 0 - Not applicable 1 - Enabled 2 - Disabled x00 - Not GC entry |
| 111 | Reserved | Char (2) | Reserved. |
| 113 | Length of trigger library name | Bin (15) | The length of the trigger library name for a Change Trigger operation. Contains 0 if the Change Trigger operation includes multiple triggers. This field is not applicable if the entry type is not TG. |
| 115 | Offset to trigger library name | Bin (31) | The offset to the trigger library name for a Change Trigger operation from the beginning of the journal entry specific data. Contains hex zeros if the Change Trigger operation includes multiple triggers. This field is not applicable if the entry type is not TG. |
| 119 | Length of trigger name | Bin (15) | Length of the trigger name for a Change Trigger operation. Contains 0 if the Change Trigger operation includes multiple triggers. This field is not applicable if the entry type is not TG. |
| 121 | Offset to trigger name | Bin (31) | The offset to the trigger name for a Change Trigger operation from the beginning of the journal entry specific data. Contains hex zeros if the Change Trigger operation includes multiple triggers. This field is not applicable if the entry type is not TG. |
| | These fields only exist in V5R4 or later journal entries. | | |
| 125 | Object attribute | Char (10) | OIR attribute of the object (for example: PF, LF, etc.) |

| Relative offset | Field | Format | Description |
|-----------------|--|----------|---|
| 135 | Number of based on physical files | Bin (15) | Number of based on physical files. This field is only applicable to logical file CT entries. |
| 137 | Offset to name of first based on physical file | Bin (31) | Offset to 20 byte field consisting of a 10 byte file name followed by 10 byte library name. The file name is the first based on physical file of the logical file. The offset is from the beginning of the journal entry specific data. Note: This field is only applicable for logical file CT entries. |
| 141 | Next offset | Bin (15) | Offset from start of prior based on file name to the next based on file name. Note: This field is only applicable for logical file CT entries. |
| 143 | Not logged indicator | Char (1) | This entry applies only to CT (create database file) and CG (change database file) entries. 0 = Not logged was not requested on either the CREATE or ALTER operation. 1 = NOT LOGGED request For a CT entry, journaling will be started for the members when the transaction is committed. For a CG entry, journaling was ended for the members and will be restarted when the transaction is committed or rolled back. |
| 144 | Source file indicator | Char (1) | 0 = Not a source file 1 = Source file |
| 145 | Internal data | Char(*) | Internal system information |

Notes:

1. This data does not apply to integrated file system objects.
2. If the data for these entries exceeds 32 KB, then a pointer is returned to the actual data when the entry is retrieved using an option to return pointers. If the return pointer option is not used, then *POINTER is returned for the entry-specific data.

Object restored (B FR, D DZ, E EL, F MR, J RR, Q QZ, Y YZ) and receiver saved (J RS) journal entries

| Relative offset | Field | Format | Description |
|---|-------|--------|-------------|
| Specific values for this entry type: | | | |

| Relative offset | Field | Format | Description |
|--|------------------------------------|-----------------------|--|
| | Journal identifier (JOJID) | Char (10) | Records for the entries will have a journal identifier. The JID is not provided with the *TYPE1, *TYPE2, and *TYPE3 formats. It can be used with the QJORJIDI API. |
| Entry-specific data. This data appears as one field in the standard output formats: | | | |
| 1 | Media type | Char (3) | The type of media used for the save or restore operation: DKT = Diskette OPT = Optical SAV = Save file TAP = Tape |
| 4 | First volume ID | Char (6) | The ID of the first volume used. The optical volume ID might contain up to 32 characters of which the first six characters are displayed. |
| 10 | Start save or restore date | Char (6) ¹ | The date the save or restore operation was started. The date is in the format of the DATFMT attribute of the job that performed the save or restore operation. |
| 16 | Start save or restore time | Zoned (6,0) | The time the save or restore operation was started. |
| 22 | Update history | Char (1) | Whether the save history is updated: 0 = UPDHST(*NO) specified on save command. 1 = UPDHST(*YES) specified on save command. |
| 23 | Save file name | Char (10) | The name of the save file used for the operation. This field is blank if a save file was not used. |
| 33 | Save file library | Char (10) | The name of the library for the save file. This field is blank if a save file was not used. |
| 43 | Media file identifier ² | Char (16) | File identifier for the integrated file system object on the media. This applies only to B FR entries. |
| 59 | Restored file identifier | Char (16) | File identifier for the restored integrated file system object. This applies only to B FR entries. |
| 75 | Restored over file identifier | Char (16) | File identifier for the integrated file system object that was restored over. This applies only to B FR entries. |
| <p>Note:</p> <ol style="list-style-type: none"> See the “Layouts for the fixed-length portion of journal entries” on page 162 of the journal entry for any information pertaining to the century of this date. In place of the media finder, the Q QZ entry has a 1-byte character (Char (1)) field with the following possible values to indicate if the contents of the data queue were restored: 0 = No 1 = Yes | | | |

Object saved (B FS, D DH, E ES, F MS, Q QY, Y YS) journal entries

| Relative offset | Field | Format | Description |
|--|--------------------------|-----------------------|--|
| Entry-specific data. This data appears as one field in the standard output formats: | | | |
| 1 | Media type | Char (3) | The type of media used to save the object: DKT = Diskette OPT = Optical SAV = Save file TAP = Tape |
| 4 | First volume ID | Char (6) | The ID of the first volume used to save the object. The optical volume ID might contain up to 32 characters of which the first six characters are displayed. |
| 10 | Start save date | Char (6) ¹ | The date the save operation was started. The date is in the format of the DATFMT attribute of the job that saved the object. |
| 16 | Start save time | Zoned (6,0) | The time the save operation was started. |
| 22 | Update history | Char (1) | Whether the save history is updated: 0 = UPDHST(*NO) specified on save command. 1 = UPDHST(*YES) specified on save command. |
| 23 | Save file name | Char (10) | The name of the save file used for the operation. This field is blank if a save file was not used. |
| 33 | Save file library | Char (10) | The name of the library for the save file. This field is blank if a save file was not used. |
| 43 | Save active value | Char (10) | The value specified for the SAVACT parameter on the SAVOBJ, SAVCHGOBJ, SAV, or SAVLIB command. |
| 53 | Start save active date | Char (6) ¹ | For a save-while-active operation, this is the date when checkpoint processing was completed for the object. For a normal save operation, this is the same as the start date. |
| 59 | Start save active time | Zoned (6,0) | For a save-while-active operation, this is the time when checkpoint processing was completed for the object. For a normal save operation, this is the same as the start time. |
| 65 | Primary receiver name | Char (10) | The name of the first of dual receivers that contains the start-of-save entry. |
| 75 | Primary receiver Library | Char (10) | The name of the library containing the primary receiver. |
| 85 | Dual receiver name | Char (10) | The name of the second of dual receivers that contains the start-of-save entry. This entry is blank if only a single receiver was used when the start-of-save entry was added. |

| Relative offset | Field | Format | Description |
|-----------------|---|---------------|---|
| 95 | Dual receiver library | Char (10) | The name of the library containing the dual receiver. This entry is blank if only a single receiver was used when the start-of-save entry was added. |
| 105 | Sequence number of matching start-of-save entry | Zoned (10, 0) | For a save-while-active operation, the sequence number of the corresponding start-of-save entry. For a normal save operation, this is the sequence number of the current object saved entry. A -1 is returned if the sequence number is greater than 9 999 999 999. If -1, see Large sequence number of matching start-of-save entry. |
| 115 | File ID of object or reserved | Char (16) | The file identifier for the object for B FS entries, otherwise blank. ⁴ |
| 131 | Large sequence number of matching start-of-save entry | Char (20) | For a save-while-active operation, the sequence number of the corresponding start-of-save entry. For a normal save operation, this is the sequence number of the current object saved entry. |
| 151 | Library ASP device | Char (10) | The ASP device on which the library that contains the primary receiver resides. |
| 161 | Contents saved | Char(1) | Whether the contents of the data queue were saved: 0 = No 1 = Yes Note: This field only applies to Q QY entries. |

Notes:

1. See the fixed-length portion of the journal entry for any information pertaining to the century of this date.
2. If an object was saved using the save-while-active function, the saved copy of the object includes all of the changes found in the journal entries up to the corresponding object start of save-while-active entry. For more information see the layout for the [“Start of save-while-active \(B FW, D DW, E EW, F SS, Q QX, Y YW\) journal entries”](#) on page 296.
3. If an object was NOT saved using the save-while-active function, the saved copy of the object includes all of the changes found in the journal entries up to the corresponding object saved entry. For more information see the layout for [“Object saved \(B FS, D DH, E ES, F MS, Q QY, Y YS\) journal entries”](#) on page 291.

Ownership change (E ZO, J ZO, Q ZO, Y ZO) journal entries

| Relative offset | Field | Format | Description |
|--|-----------|-----------|----------------------------|
| Entry-specific data. This data appears as one field in the standard output formats: | | | |
| 1 | Old owner | Char (10) | The name of the old owner. |
| 11 | New owner | Char (10) | The name of the new owner. |

Prepare commit (C PC) journal entries

| Relative offset | Field | Format | Description |
|-----------------|---------------|----------|--|
| 1 | Reserved | Char (1) | Reserved field |
| 2 | Journal count | Bin (16) | The number of journals on this system that participated in the transaction |

Received data queue, has key (Q QL) journal entry

| Relative offset | Field | Format | Description |
|--|------------|-----------|--|
| Entry-specific data. This data appears as one field in the standard output formats: | | | |
| 1 | Reserved | Char (18) | Reserved for future use. |
| 19 | Key length | Bin (16) | The number of characters in the key. |
| 21 | Key order | Char (2) | The Key order is as follows: GT = Greater than LT = Less than NE = Not equal EQ = Equal GE = Greater than or equal LE = Less than or equal |
| 23 | Key | Char (*) | The data to be used to receive a message from the data queue. |

ROLLBACK (C RB) journal entry

| Relative offset | Field | Format | Description |
|---|----------------------|-----------|--|
| Specific values for this entry type: | | | |
| | Job name (JOJOB) | Char (10) | Blank if the entry was added during an IPL vary on of an independent disk pool. |
| | Program name (JOPGM) | Char (10) | Blank if the entry was added during an IPL or vary on of an independent disk pool. |
| | Flag (JOFLAG) | Char (1) | How the rollback operation was initiated and whether it was successful: 0 = All record-level changes were rolled back for a rollback operation initiated by a user. 1 = Not all record-level changes were successfully rolled back for a rollback operation initiated by a user. 2 = All record-level changes were rolled back for a rollback operation initiated by the operating system. 3 = Not all record-level changes were rolled back for a rollback operation initiated by the operating system. |

Rollback ended early (C CN, F C1) journal entries

| Relative offset | Field | Format | Description |
|--|--------------|-----------|--|
| Entry-specific data. This data appears as one field in the standard output formats: | | | |
| 1 | User profile | Char (10) | The user profile that requested to end the rollback. |
| 11 | Process | Char (26) | The process that requested to end the rollback. |

RGZPFM (F RG) journal entry

| Relative offset | Field | Format | Description |
|--|--------------|-----------|---|
| Entry-specific data. This data appears as one field in the standard output formats: | | | |
| 1 | File name | Char (10) | The name of the file specified for the KEYFILE parameter on the RGZPFM command. If KEYFILE(*NONE) was specified, this field is blank. |
| 11 | Library name | Char (10) | The name of the library specified in the KEYFILE parameter of the RGZPFM command. If KEYFILE(*NONE) was specified, this field is blank. |
| 21 | Member name | Char (10) | The name of the member specified in the KEYFILE parameter of the RGZPFM command. If KEYFILE(*NONE) was specified, this field is blank. |

Savepoint released (C SQ) and savepoint rolled back (C SU) journal entries

| Relative offset | Field | Format | Description |
|--|-----------------|-----------|---|
| Entry-specific data. This data appears as one field in the standard output formats: | | | |
| 1 | Sequence number | Char (20) | The sequence number where the savepoint was established |

Send data queue, has key (Q QK) journal entry

| Relative offset | Field | Format | Description |
|--|-------------|----------|--|
| Entry-specific data. This data appears as one field in the standard output formats: | | | |
| 1 | Data length | Bin (32) | The length of the Data field (which is the last field in the ESD of this journal entry). When replicating a data queue entry with this journal entry, this length field should be specified on the QSNDTAQ API in association with the Data field below. See the details in the description of the Data field. |

| Relative offset | Field | Format | Description |
|-----------------|----------------|----------|--|
| 5 | Offset to data | Bin (32) | Offset to the Data field (which is the last field in the ESD of this journal entry). The offset is calculated from the beginning of the entry-specific data (ESD). |
| 9 | Reserved | Char (2) | Reserved for future use. |
| 11 | Key length | Bin (16) | The number of characters in a key. |
| 13 | Reserved | Char (4) | Reserved for future use. |
| 17 | Key | Char (*) | A prefix added to an entry by its sender. |
| | Reserved | Char (*) | Padding to align fields. |
| Offset to data | Data | Char (*) | The data that was placed on the data queue. If the journal entry is marked as having 'incomplete data' in the journal entry header, then this field is returned as a pointer. Otherwise, it is returned as a character string. For either type of entry, the Data length field contains the length of the data. The first 16 bytes of the Data field are API information required by the Send Data Queue (QSNDDTAQ) API. When replicating a data queue entry with this journal entry, this entire Data field (including the 16 bytes of API information) must be passed to the QSNDDTAQ API when it is called with parameter eight (Data is from a journal entry) set to *YES. These 16 bytes are not placed on the data queue. The remainder of the Data field is placed on the data queue. |

Send data queue, no key (Q QS) journal entry

| Relative offset | Field | Format | Description |
|--|-------------|-----------|---|
| Entry-specific data. This data appears as one field in the standard output formats: | | | |
| 1 | Reserved | Char (28) | Reserved for future use. |
| 29 | Data length | Bin (32) | The length of the Data field (which is the last field in the ESD of this journal entry). When replicating a data queue entry with this journal entry, this length field should be specified on the QSNDDTAQ API in association with the Data field below. See the details in the description of the Data field. |

| Relative offset | Field | Format | Description |
|-----------------|-------|----------|--|
| 33 | Data | Char (*) | The data that was placed on the data queue. If the journal entry is marked as having 'incomplete data' in the journal entry header, then this field is returned as a pointer. Otherwise, it is returned as a character string. For either type of entry, the Data length field contains the length of the data. The first 16 bytes of the Data field are API information required by the Send Data Queue (QSNDDTAQ) API. When replicating a data queue entry with this journal entry, this entire Data field (including the 16 bytes of API information) must be passed to the QSNDDTAQ API when it is called with parameter eight (Data is from a journal entry) set to *YES. These 16 bytes are not placed on the data queue. The remainder of the Data field is placed on the data queue. |

Start of commit cycle (C SC) journal entry

| Relative offset | Field | Format | Description |
|-----------------------------|---------------|----------|--|
| Entry-specific data: | | | |
| | Flag (JOFLAG) | Char (1) | Indicates whether the commit cycle was on behalf of an X/Open global transaction or not: 0 = The commit cycle is not on behalf of an X/Open global transaction. 1 = The commit cycle is on behalf of an X/Open global transaction. |

Start of save-while-active (B FW, D DW, E EW, F SS, Q QX, Y YW) journal entries

| Relative offset | Field | Format | Description |
|--|-----------------|-----------------------|---|
| Entry-specific data. This data appears as one field in the standard output formats: | | | |
| 1 | Media type | Char (3) | The type of media used to save the object: DKT = Diskette OPT = Optical SAV = Save file TAP = Tape |
| 4 | First volume ID | Char (6) | The ID of the first volume used to save the object. The optical volume ID might contain up to 32 characters of which the first six characters are displayed. This field will be blank for the Y YW entry. |
| 10 | Start save date | Char (6) ¹ | The date the save operation was started. The date is in the format of the DATFMT attribute of the job that saved the object. |

| Relative offset | Field | Format | Description |
|-----------------|-----------------------------|-----------------------|---|
| 16 | Start save Time | Zoned (6,0) | The time the save operation was started. |
| 22 | Update history | Char (1) | Whether the save history is updated: 0 = UPDHST(*NO) specified on the save command. 1 = UPDHST(*YES) specified on the save command. |
| 23 | Save file name | Char (10) | The name of the save file used for the operation. This field is blank if a save file was not used. |
| 33 | Save file library | Char (10) | The name of the library for the save file. This field is blank if a save file was not used. |
| 43 | Save active value | Char (10) | The value specified for the SAVACT parameter on the SAVOBJ, SAVCHGOBJ, SAV, or SAVLIB command. |
| 53 | Save active date | Char (6) ¹ | For a save-while-active operation, this is the date when checkpoint processing was completed for the object. For a normal save operation, this is the same as the start date. |
| 59 | Save active Time | Char (6) | For a save-while-active operation, this is the time when checkpoint processing was completed for the object. For a normal save operation, this is the same as the start time. |
| 65 | Object file ID ⁴ | Char (16) | The file identifier of the integrated file system object. This applies only to B FW entries. |

Notes:

1. See the fixed-length portion of the journal entry for any information pertaining to the century of this date.
2. If an object was saved using the save-while-active function, the saved copy of the object includes all of the changes found in the journal entries up to the corresponding object start of save-while-active entry. For more information see the layout for “Start of save-while-active (B FW, D DW, E EW, F SS, Q QX, Y YW) journal entries” on page 296.
3. If an object was NOT saved using the save-while-active function, the saved copy of the object includes all of the changes found in the journal entries up to the corresponding object saved entry. See the entry-specific data for “Object saved (B FS, D DH, E ES, F MS, Q QY, Y YS) journal entries” on page 291.
4. In place of the Object file ID, the Q QY entry has a 1-byte character (Char(1)) field with the following possible values to indicate if the contents of the data queue were saved:

0 = No
1 = Yes

Start journal (B JT, D JF, E EG, F JM, Q QB) journal entries

| Relative offset | Field | Format | Description |
|---|-------|--------|-------------|
| Specific values for this entry type: | | | |

| Relative offset | Field | Format | Description |
|--|-------------------------------|-----------|---|
| | Flag (JOFLAG) | Char (1) | Indicates the type of images selected: 0 = After images are journaled. 1 = Before and after images are journaled. |
| Entry-specific data. This data appears as one field in the standard output formats: | | | |
| 1 | Omit journal entry | Char (1) | Indicates the value of the OMTJRNE parameter on the Start Journal command. 0 = No entries are omitted from journaling. 1 = Open and Close (*FILE), or Open, Close, and Force (*DIR or *STMF) entries are not journaled. |
| 2 | New object inherit journaling | Char (1) | Specifies whether journaling starts automatically for new objects created in the directory. 0 = No or does not apply 1 = Yes |
| 3 | Remote journal filter | Char (1) | 0 = No, entries are not eligible for remote journal filtering by object or does not apply 1 = Yes, entries are eligible for remote journal filtering by object |
| 4 | Reserved | Char (5) | Reserved field |
| 9 | File identifier | Char (16) | The file identifier for the integrated file system object. This only applies to B JT entries. |
| 25 | Path name | Char (*) | The path name information optionally follows the file identifier. This only applies to BJT entries. |

Usage limit changed (L LL) journal entry

| Relative offset | Field | Format | Description |
|--|----------------------|-------------|--|
| Entry-specific data. This data appears as one field in the standard output formats: | | | |
| 1 | Product ID | Char (7) | The ID of the product whose usage limit was changed. |
| 8 | License term | Char (6) | The term of the license. |
| 14 | Feature | Char (4) | The product feature code. |
| 18 | Previous usage limit | Zoned (6,0) | The usage limit before the change. |
| 24 | Current usage limit | Zoned (6,0) | The usage limit after the change. |
| 30 | Old expiration date | Char (7) | The expiration date before the change. |
| 37 | New expiration date | Char (7) | The expiration date after the change. |

Usage limit exceeded (L LU) journal entry

| Relative offset | Field | Format | Description |
|--|--------------------------|-----------------|---|
| Entry-specific data. This data appears as one field in the standard output formats: | | | |
| 1 | Product ID | Char (7) | The ID of the product whose usage limit was exceeded. |
| 8 | License term | Char (6) | The term of the license. |
| 14 | Feature | Char (4) | The product feature code. |
| 18 | Usage limit | Zoned (6,0) | The usage limit for the product. |
| 24 | Request flag | Char (1) | Whether the request was successful: 0 = License request was successful. 1 = License request was not successful. |
| 25 | Number of licensed users | Zoned (6,0) | The number of users currently licensed for the product. |
| 31 | Licensed user name | Char (26) x 100 | The names of up to 100 users who are licensed for the product. |

Update data area (E EA, E EB) journal entries

| Relative offset | Field | Format | Description |
|--|-----------------------|-----------|---|
| Entry-specific data. This data appears as one field in the standard output formats: | | | |
| 1 | Starting position | Bin (32) | Starting position of change as specified by the user (1 for decimal). |
| 5 | Length of change | Bin (32) | Length of change to be applied as specified by the user. |
| 9 | Number | Bin (32) | Number of decimal positions as specified by the user. |
| 13 | Offset to change | Bin (32) | Offset to change value field from the beginning of the entry-specific data (ESD). |
| 17 | Type | Char (10) | Type of data area. Data area types are *CHAR, *DEC, and *LGL. |
| | Padding for alignment | Char (*) | Padding to align fields. |
| Offset to change | Change value | Char (*) | Value of the change. |

User IASP vary on abnormal (J UA) journal entries

| Relative offset | Field | Format | Description |
|--|-------------|----------|-----------------------------------|
| Entry-specific data. This data appears as one field in the standard output formats: | | | |
| 1 | System name | Char (8) | System name for the IASP vary-on. |

User IASP vary on normal (J UN) journal entries

| Relative offset | Field | Format | Description |
|--|-------------|----------|-----------------------------------|
| Entry-specific data. This data appears as one field in the standard output formats: | | | |
| 1 | System name | Char (8) | System name for the IASP vary-on. |

Common fields

The following tables contain fields of entry-specific data that are common to more than one journal entry layout.

Journal information

This table contains entry-specific data for journal information. For an explanation of these fields, see the [Get Attributes \(Qp0IGetAttr\(\)\) API](#).

| Relative offset | Field | Format | Description |
|-----------------|----------------------------------|-----------|--|
| 1 | Journaling status | Char (1) | Indicates whether the object is journaled. |
| 2 | Options | Char (1) | The journaling options or attributes. |
| 3 | JID | Char (10) | The journal identifier. |
| 13 | Journal name | Char (10) | The journal name. |
| 23 | Journal library | Char (10) | The journal library. |
| 33 | Time journaling was last started | Bin (32) | Time journaling was last started. |

Object name

This table contains entry-specific data for the name of an integrated file system object. For more information about the object name see [Path name format](#) in the API topic.

| Relative offset | Field | Format | Description |
|-----------------|-------------------------|----------|---|
| 1 | Length | Bin (32) | The length of the object name field. |
| 5 | Path name CCSID | Bin (31) | The coded character set identifier (CCSID) for the object name. |
| 9 | Object name country ID | Char (2) | The country identifier for national language support. |
| 11 | Object name language ID | Char (3) | The language identifier for national language support. |
| 14 | Reserved | Char (3) | Reserved. This field contains all hex zeros. |
| 17 | Object name | Char (*) | The object name. The field is of variable length. |

Path name

This table contains entry-specific data for the path name of an integrated file system object. For more information about the path name see [Path name format](#) in the API topic.

| Relative offset | Field | Format | Description |
|-----------------|------------------------|-----------|---|
| 1 | Path indicator | Char (1) | The absolute or relative path indicator. This field uses one of the following values: 0 = The path contains an absolute path name. The Relative directory FID field is hex zeros. 1 = The path contains a relative path name. The Relative directory FID field is valid and can be used to form a complete path name. |
| 2 | Relative directory FID | Char (16) | If the path indicator is 1, this is the file identifier for the directory that contains the object indicated in the path name field. Otherwise, this will be zeros. |
| 18 | Path name CCSID | Bin (31) | The coded character set identifier (CCSID) for the path name. |
| 22 | Path name country ID | Char (2) | The country identifier for national language support. |
| 24 | Path name language ID | Char (3) | The language identifier for national language support. |
| 27 | Reserved | Char (3) | Reserved. This field contains all hex zeros. |
| 30 | Path name type | Bin (32) | The path name type uses one of the following values: 0 = The path name is a character string with a one byte delimiter. 2 = The path name is a character string with a two byte delimiter. |
| 34 | Path length | Bin (31) | The path length. |
| 38 | Path name delimiter | Char (2) | The path name delimiter. |
| 40 | Reserved | Char (10) | Reserved. Set to blanks. |
| 50 | Path name | Char (*) | The object path name. This field is of variable length. |

Private authority information

This table contains entry-specific data for the private authority information that has been set for an integrated file system object when an object is created.

| Relative offset | Field | Format | Description |
|-----------------|-------------------|-----------|--|
| 1 | User name | Char (10) | The name of the user profile whose authority is being granted. |
| 11 | Operation type | Char (3) | GRT = Grant authority. |
| 14 | Reserved | Char (7) | Reserved. Set to zeros. |
| 21 | Private authority | Char (12) | Private authorities assigned to the given user profile. |

Private authorities for specified profile

| Relative offset | Field | Format | Description |
|-----------------|------------------------------|----------|--|
| 1 | Object existence authority | Char (1) | Y = The specified profile has *OBJEXIST authority to the object. blank = The specified profile does not have *OBJEXIST authority to the object. |
| 2 | Object management authority | Char (1) | Y = The specified profile has *OBJMGT authority to the object. blank = The specified profile does not have *OBJMGT authority to the object. |
| 3 | Object operational authority | Char (1) | Y = The specified profile has *OBJOPR authority to the object. blank = The specified profile does not have *OBJOPR authority to the object. |
| 4 | Object alter authority | Char (1) | Y = The specified profile has *OBJALTER authority to the object. blank = The specified profile does not have *OBJALTER authority to the object. |
| 5 | Object reference authority | Char (1) | Y = The specified profile has *OBJREF authority to the object. blank = The specified profile does not have *OBJREF authority to the object. |
| 6 | Read authority | Char (1) | Y = The specified profile has *READ authority to the object. blank = The specified profile does not have *READ authority to the object. |
| 7 | Add authority | Char (1) | Y = The specified profile has *ADD authority to the object. blank = The specified profile does not have *ADD authority to the object. |
| 8 | Update authority | Char (1) | Y = The specified profile has *UPD authority to the object. blank = The specified profile does not have *UPD authority to the object. |
| 9 | Delete authority | Char (1) | Y = The specified profile has *DLT authority to the object. blank = The specified profile does not have *DLT authority to the object. |
| 10 | Exclude authority | Char (1) | Y = The specified profile has *EXCLUDE authority to the object. blank = The specified profile does not have *EXCLUDE authority to the object. |

| Relative offset | Field | Format | Description |
|-----------------|-------------------|----------|--|
| 11 | Execute authority | Char (1) | Y = The specified profile has *EXECUTE authority to the object. blank = The specified profile does not have *EXECUTE authority to the object. |
| 12 | Reserved | Char (1) | Reserved. Set to blank. |

Symbolic link contents

| Relative offset | Field | Format | Description |
|-----------------|------------------------------|-----------|--|
| 1 | Contents included | Char (1) | Indicates if the entire symbolic link contents are included in the Contents field. The possible values are: 0 = The entire symbolic link contents cannot be included in the Contents field because the maximum possible has been exceeded. The symbolic link contents are truncated in this entry. 1 = The entire symbolic link contents are included in the Contents field. |
| 2 | Contents CCSID | Bin (31) | The coded character set identifier (CCSID) for the symbolic link contents. |
| 6 | Contents country ID | Char (2) | The country identifier for national language support for the symbolic link contents. |
| 8 | Contents language ID | Char (3) | The language identifier for national language support for the symbolic link contents. |
| 11 | Reserved | Char (3) | Reserved. This field contains all hex zeros. |
| 14 | Contents path type | Bin (32) | The possible values for the contents path type are: 0 = The path name is a character string with a one byte delimiter. 2 = The path name is a character string with a two byte delimiter. |
| 18 | Contents path length | Bin (31) | The path length for the symbolic link contents. |
| 22 | Contents path name delimiter | Char (2) | The path name delimiter for the symbolic link contents. |
| 24 | Reserved | Char (10) | Reserved. This field contains all hex zeros. |
| 34 | Symbolic link contents | Char (*) | The symbolic link contents. This field is of variable length. |

Related reference

[Set Attributes \(QpOlSetAttr\(\)\) API](#)
[Get Attributes \(QpOlGetAttr\(\)\) API](#)
[Send Data Queue \(QSNDTAQ\) API](#)
[Path name format](#)

Working with journal entry information

This topic provides ways that you can display, retrieve, and receive journal entries.

Every journal entry is stored internally in a compressed format and must be converted by the operating system to an external form before it can be shown to the user. You cannot change or access the journal entries directly. Not even the security officer can remove or change journal entries in a journal receiver.

You can use these journal entries to help you recover your objects or analyze changes that were made to the objects.

Following are the various ways that you can retrieve, display, and print journal entry information:

Note: Read the Code example disclaimer for important legal information.

Displaying and printing journal entries

You can use the **Display Journal (DSPJRN)** command to display journal entries. The entries are displayed at a work station, printed, or written to an output file. You cannot directly access the journal entries in the form in which they are contained in the journal receivers.

The Journal entry information finder describes each type of journal entry and the information that it contains. It also provides links for topics that provide the layouts for the fixed-length portion and the variable-length portion of the journal entry. See the **Display Journal (DSPJRN) Command Description** for complete layouts for the model database output files that are provided by the system.

Often, to prepare for a recovery, you display or print the journal entries first. The [Journal code descriptions](#) provides a description of each code. Use this list to help you analyze the journal entries and to do the following:

- Prepare for the recovery of a particular object. The list contains the information you need to specify the starting and ending points for applying and removing journaled changes.
- Determine the functions that have been performed on the objects that are being journaled (such as save and restore, clear, reorganize).
- Determine the functions that have been performed on the journal (such as attaching new journal receivers).
- Determine the functions that have been performed on the associated journal receivers (such as save and restore).
- Review the activity that has occurred on an object.
- Analyze journal entries for debugging or problem analysis.
- Analyze journal entries for an audit trail.

The **DSPJRN** command can either selectively list journal entries for a particular object or list entries for all objects within a particular library or directory subtree. You can further identify journal entries by specifying other selection criteria such as:

- Journal entries for specific entry types or journal codes, such as U (user-created entries)
- Journal entries for a particular job, program, or file
- Commit cycle identifier
- Date and time
- Dependent entries (referential integrity, triggers, and entries that will be ignored during an **Apply Journaled Changes (APYJRNCHG)** or **Remove Journaled Changes (RMVJRNCHG)** operation)
- Any combination of these

The online help describes all the parameters for the DSPJRN command. To view the help, type DSPJRN on a command line and press F1.

Specifying journal codes

You can display entries that have specific journal codes, such as all file-member-level entries (F), all record-level entries (R), or all security entries (T). You specify journal codes in paired values. The first value in the pair is the journal code. The second value indicates whether the object selections you have specified apply when deciding to display entries with the journal code.

Following is an example:

```
DSPJRN JRN($JRNLIB/JRNA) FILE(CUSTLIB/FILEA)
      JRNCDE((F *ALLSLT) (R *ALLSLT)
            (U *IGNFLSLT)) . . .
```

In this example, entries for the FILEA file with journal codes F and R are displayed if the entries meet all other selection criteria, such as date and time. Entries with journal code U are displayed regardless of whether they are for file FILEA, because ignore file selection (*IGNFLSLT) is specified for journal code U. Entries with journal code U must meet all other selection criteria, such as date and time, to be displayed.

Note: You can select similar entries for other object types using the OBJ or OBJPATH parameters and specifying *IGNOBJSLT for the second value of the journal code.

Related concepts

[Layouts for the fixed-length portion of journal entries](#)

Use this topic to determine layouts for the fixed-length portion of journal entries.

[Layouts for variable-length portion of journal entries](#)

The following tables contain the variable-length portion of the layouts for journal entries.

[Journal code descriptions](#)

This topic provides a description of all of the journal codes and categories.

Related reference

[Display Journal \(DSPJRN\) command](#)

Related information

[Journal entry information finder](#)

Output for journal entries directed to a workstation

If you direct the output from the Display Journal (DSPJRN) command to the requesting workstation, basic information about the journal entries appears. Use the roll key to display the next sequential set of entries.

If you specify a receiver range that includes an attached journal receiver, and you specify TOENT(*LAST) or TOENTLRG(*LAST), the display shows last journal entries in the journal. Press the Page Down key to see any new journal entries that are added to the attached receiver since the last time you pressed the Page Down key.

The attached journal receiver in receiver range refers to the journal receiver that was currently attached when the DSPJRN command was first issued. That journal receiver could be detached while you are looking at the data online. If that occurs, paging down does not display any entries added after that receiver was detached.

Related reference

[Display Journal \(DSPJRN\) command](#)

Output for journal entries directed to a database output file

If you direct the output from the Display Journal (DSPJRN) command to a database output file, you can further restrict the journal entries you want to process by creating logical files over the database output file.

Each journal entry occupies one record in the output file. Each has a fixed-length portion for standard files. Before-images and after-images occupy separate records. The ENTDTALEN parameter controls the length of the field that is used to contain the record image. The ENTDTALEN parameter also controls whether the field is a fixed or variable length field. If the journal entry is smaller than the output file

record, the journal entry is padded with blanks. If the journal entry is larger than the output file record, the remainder of the journal entry is truncated, and the system issues a warning message. To avoid truncation, specify the maximum record length in your files for the ENTDTALEN parameter on the DSPJRN command or specify *CALC for the ENTDTALEN parameter to allow the system to calculate the length of the specific data field so no entry is truncated.

If you write journal entries to a database output file, you can write application programs that will process the data to:

- Write your own apply program.
- Correct data that has been incorrectly updated.
- Remove or review all changes that were made by a particular program.

If you remove all changes that were made by a particular program, you could remove some valid updates. For example, assume that two work station users are using the same program to update an object, and one user enters some data that is not valid. If you remove all invalid data changes that are made by that program, you also remove the valid data that is entered by the other work station user.

Related reference

[Display Journal \(DSPJRN\) command](#)

Format of database output files

When you direct the output of the Display Journal (DSPJRN) command to a database file, the system creates the output file records in a standard format.

The system creates the database file in one of these standard formats that are determined by the value that is specified for the OUTFILFMT parameter:

- *TYPE1
- *TYPE2
- *TYPE3
- *TYPE4
- *TYPE5

Fixed-length portion of the journal entry has a complete description of these formats.

You can create an output file to hold the output from the DSPJRN command, but the format has to match the format of one of the IBM-supplied output files.

Processing journal entry data

There are many ways to work with the journal entry data, including the entry-specific data, depending on the command that you use to process the journal entry data.

- Use your high-level language (HLL) to subdivide the fields into subfields.
- Use the Retrieve Journal Entry (RTVJRNE) command and the substring built-in function.
- Use the Receive Journal Entry (RCVJRNE) command and the substring built-in function.
- Use the Retrieve Journal Entries (QjoRetrieveJournalEntries) API and map out the data that is returned.

Analyzing your journal activity

You can use the DSPJRN command to help analyze your journal entries. For example, you could determine how many of each type of entry (such as add or update) was done for a specific object or by a specific user.

Related concepts

[Layouts for the fixed-length portion of journal entries](#)

Use this topic to determine layouts for the fixed-length portion of journal entries.

Related reference

[Display Journal \(DSPJRN\) command](#)

[Retrieve Journal Entry \(RTVJRNE\) command](#)

[Receive Journal Entry \(RCVJRNE\) command](#)

[Retrieve Journal Entries \(QjoRetrieveJournalEntries\) API](#)

Displaying journal information for a table using IBM Navigator for i

You can get journal information for a table from IBM Navigator for i. This is the one interface where you can see the entry specific data for a database table row separated by columns.

To display journal information for a table, follow these steps:

1. From IBM Navigator for i, expand **your system** > **Databases**.
2. Expand the database that you want to work with.
3. Expand **Schemas** and the schema that contains the table for which you want to display journal information.
4. Click **Tables**.
5. Right-click the table for which you want to display journal information, and click **Journaling**.
6. If the table has never been journaled, you can specify the journal that you want to use by typing the journal and library names in the appropriate fields, or by clicking the **Browse** button and navigating to the location of the journal that you want to use for the table.
7. To journal before images, select the **Journal image before change** check box.
8. To omit open and close entries from being journaled, clear the **Include open and close entries** check box.

Displaying journal entry information using the Display_Journal table function

You can view journal entries in SQL by running a query using the table function QSYS2/Display_Journal.

Using the table function QSYS2/Display_Journal should be more efficient than displaying journal entries to an output file via the **Display Journal (DSPJRN)** command and then querying the resulting file for the data of interest. For more details on the Display_Journal table function see the [../rzajq/rzajqudfdisplayjournal.htm](#) topic.

Receiving journal entries in an exit program

You can write a program to receive journal entries as they are written to the journal receiver.

When you use the Receive Journal Entry (RCVJRNE) command, you can specify a user-defined program, called an **exit program**, to receive journal entries. The program can, for example, write the entries to tape or to an i5/OS intersystem communications function (ICF) file that sends them to a backup system. You can use the received entries to update a backup copy of the primary object on the backup system. You cannot use these received entries with system-supplied recovery commands (Apply Journaled Changes (APYJRNCHG) and Remove Journaled Changes (RMVJRNCHG)) to update your objects because the RCVJRNE command converts the entries to their external form. You must write your own program to apply the changes that are contained in the entries to the objects.

The RCVJRNE command supports the same selection criteria (database files, data areas, data queues, or integrated file system objects) as the Display Journal (DSPJRN) command. You can specify which entries go to the exit program.

For example, you can choose not to receive journal entries that are generated by the action of trigger programs or referential constraints. If you have a user-written program that updates the files on a second system with the journal entries, you probably want to specify DEPENT(*NONE). The actions performed by trigger programs or referential constraints are duplicated automatically on the second system if your database definitions are the same and you replay the original file operations.

You can specify DELAY(*NEXTENT) to have journal entries sent to your program as soon as they are written to the journal receiver. You can also specify a time interval. The exit program will be called

sometime within that time interval. Either new entries are sent or an indicator is sent that there are no new entries.

Related reference

[Receive Journal Entry \(RCVJRNE\) command](#)

[Display Journal \(DSPJRN\) command](#)

Exit program to receive journal entries

Use the parameters in this topic to determine how the exit program will receive journal entries.

You use two parameters to communicate between your exit program and the system when you are receiving journal entries. The system uses the first parameter for the contents of one or more journal entries that it is passing to the exit program. The exit program uses the first parameter to indicate the block length if the exit program requests block mode.

The system and the exit program use the second parameter to communicate about status changes, such as requesting block mode or ending the RCVJRNE command. The second parameter is a character field that is three bytes long. Following are the possible values for the first byte of the second parameter:

| Possible values for the first byte of the second parameter | |
|---|--|
| 0 | This value is passed from the system to the exit program. It indicates that no journal entry is being passed on this call of the exit program. |
| 1 | This value is passed from the system to the exit program. It indicates that a single journal entry is being passed on this call of the exit program. If the specified entry format is not *TYPEPTR or *JRNENTFMT, then the figure, First parameter of RCVJRNE command: Single-entry mode shows the layout of the first parameter. Otherwise, the layout is the same as returned to the Retrieve Journal Entries (QjoRetrieveJournalEntries) API interface. |
| 2 | This value is passed from the system to the exit program. It indicates that block mode is in effect. One or more journal entries are being passed on this call of the exit program. If the specified entry format is not *TYPEPTR or *JRNENTFMT, then the figure, First parameter of RCVJRNE command: Block mode shows the layout of the first parameter. Otherwise, the layout is the same as returned to the QjoRetrieveJournalEntries API interface. |
| 3 | This value is passed from the system to the exit program. It indicates that no journal entry is being passed on this call of the exit program because the journal receiver that was attached when the Receive Journal Entry (RCVJRNE) command was started is no longer attached. The system ends the RCVJRNE command after returning this value to the exit program. |
| 4 | No journal entry is passed on this call to the exit program, and no more entries can be passed unless the local or remote journal is activated. This value can only be passed to the exit program when receiving journal entries from the attached receiver of a local or remote journal. The journal state for the journal must be *INACTIVE. |
| 8 | This value is passed from the exit program to the system. It indicates that the system must begin block mode and pass multiple entries to the exit program. You can also specify block mode by using the BLKLEN parameter of the RCVJRNE command. If you specify a BLKLEN value other than *NONE, then specifying 8 in the first byte of the second parameter will have no impact and the first 5 bytes of the first parameter will be ignored. However even if BLKLEN(*NONE) is specified, the system will begin block mode if you specify 8 for the first byte of the second parameter. |
| 9 | This value is passed from the exit program to the system. It indicates that the RCVJRNE command will be ended. |

| Possible Values for the Second Byte of the Second Parameter: | |
|---|---|
| N | This value is passed from the system to the exit program. Additional journal entries are not currently available to be passed after this call of the exit program, or the RCVJRNE command will end after this call of the exit program. |
| Y | This value is passed from the system to the exit program. Additional journal entries are currently available to be passed after this call of the exit program. |

| Possible values for the third byte of the second parameter: | |
|--|---|
| '00' x | One or more journal entries are being passed to the exit program and the object names in the fixed-length portion of each journal entry do not necessarily reflect the name of the object at the time the journal entry was deposited into the journal. This value is only returned when receiving journal entries from a journal receiver that was attached to a journal prior to V4R2M0. |
| 0 | No journal entries are currently being passed, so the information that is normally returned in this byte is not applicable. |
| 1 | One or more journal entries are being passed to the exit program. The object names in the fixed-length portion of each journal entry reflect the name of the object at the time the journal entry was deposited into the journal. |
| 2 | One or more journal entries are being passed to the exit program. The object names in the fixed-length portion of each journal entry do not necessarily reflect the name of the object at the time the journal entry was deposited into the journal. The object name in the fixed-length portion of the journal entry may be returned as a known name for the object prior to the journal entry being deposited into the journal. The object name in the fixed-length portion of the journal entry may also be returned as *UNKNOWN. This value will only be returned when receiving journal entries from a remote journal and the remote journal is currently being caught up from its source journal. A remote journal is being caught up from its source journal when the Change Journal State (QjoChangeJournalState) API or Change Remote Journal (CHGRMTJRN) command is invoked and is currently replicating journal entries to the remote journal. After the call to the QjoChangeJournalState API or CHGRMTJRN command returns, the remote journal is maintained with a synchronous or asynchronous delivery mode, and the remote journal is no longer being caught up. Refer to Retrieve journal entries from a remote journal during the catch-up phase for more information. |

Any information that is passed from the exit program to the system in the second byte or third byte is ignored.

The second byte of the second exit program parameter is provided whether journal entries are being processed as a single journal entry per call of the exit program, or as a block of journal entries per call.

When an N is passed to the exit program in the second byte of the second parameter indicated that no additional journal entries are currently available, it does not necessarily mean that when the exit program returns, that the RCVJRNE command will have to wait for additional journal entries to be deposited into the journal. By the time the exit program returns, additional journal entries may already be available and depending upon what was specified on the DELAY parameter, may or may not be immediately passed to the exit program. If DELAY(N) was specified the system will wait N seconds before passing the journal entries to the exit program. If DELAY(*NEXTENT) was specified, the journal entries will immediately be passed to the exit program.

Related concepts

[Requesting block mode](#)

You can use block mode to specify whether the system will be sending one or more journal entries to the exit program and specifies the block length of the buffer passed to the exit program.

Retrieving journal entries from a remote journal during the catch-up phase

During the catch-up phase, journal entries that have been replicated to the target system can be retrieved from the remote journal.

Related reference

Retrieve Journal Entries (QjoRetrieveJournalEntries) API

Receive Journal Entry (RCVJRNE) command

Change Journal State (QjoChangeJournalState) API

Change Remote Journal (CHGRMTJRN) command

Requesting block mode

You can use block mode to specify whether the system will be sending one or more journal entries to the exit program and specifies the block length of the buffer passed to the exit program.

When you request block mode, the system sends more than one journal entry to the exit program at a time. You can request block mode at any time. There are two ways that you can request block mode:

- Specify the BLKLEN parameter on the Receive Journal Entry (RCVJRNE) command
- Specify 8 for the value of the first byte of the second parameter of the exit program

BLKLEN parameter of the RCVJRNE command

When you specify the BLKLEN parameter of the RCVJRNE command you can select one of three values:

***NONE**

At most one journal entry will be sent to the exit program.

***CALC**

One or more journal entries will be passed to the exit program in a block. The length of the block passed (the first parameter passed to the exit program) is determined by the system and will be optimal.

block-length

Specify the length in kilobytes of the buffer passed to the exit program (EXITPGM parameter). Valid values range from 32 to 4000

If you specify BLKLEN(*CALC) or BLKLEN(block-length), specifying 8 in the first byte of the second parameter will have no impact and the first 5 bytes of the first parameter will be ignored.

Specifying 8 for the value of the first byte of the second parameter of the exit program

When you specify 8 for the value of the first byte of the second parameter, you must specify the block length in the first 5 bytes of the first parameter as a zoned decimal (Zoned (5,0)) field. 99999 bytes is the maximum block size. After you have requested block mode, the system remains in block mode until the RCVJRNE processing is ended.

If you request block mode and the system is already using block mode, your request is ignored. You cannot change the size of the block from the size you specified when you first requested block mode.

Even if BLKLEN(*NONE) is specified, if you specify 8 for the value of the first byte of the second parameter, the system will use block mode.

Format of the first Parameter

If the specified entry format is not *TYPEPTR or *JRNENTFMT, and if you are using single-entry mode, the format of the first parameter looks like the following figure:

First parameter of RCVJRNE command: Single-entry mode



Legend: LnA = Length of Entry (Zoned 5,0)
 A = Entry
 00 000 = End of Record

The first 5 bytes contains the length of the entry. The last 5 bytes contains all zeroes. The length of the entry does not include the 5 bytes of zeroes at the end of the record.

If the specified entry format is not *TYPEPTR or *JRNENTFMT, and if you are using block mode, the format of the first parameter looks like the following figure:

First parameter of RCVJRNE command: Block mode

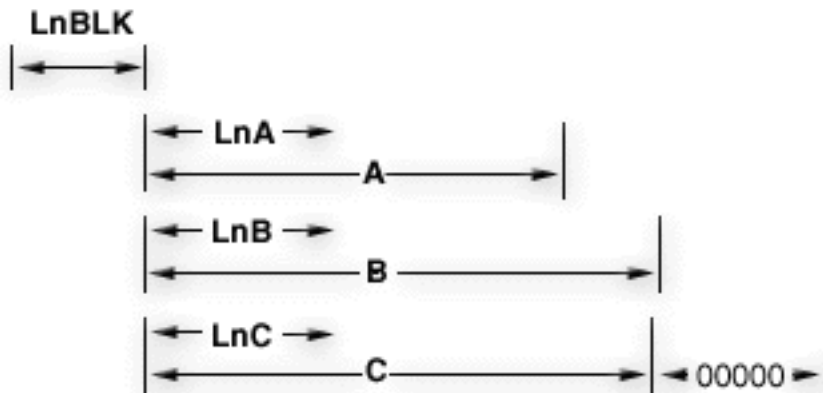

Legend: LnBlk = Length of the Block (Zoned 5,0)
 LnA, LnB, LnC = Length of the Entry (Zoned 5,0)
 A, B, C = Entry (including length of entry)
 00000 = End of Record

The first 5 bytes contains the total length of the block. This length includes the 5 bytes for the total block length, the 5 bytes of the End of Record field at the end of the block, and all of the length and data fields in between. If no entry is being passed, this Block Length field contains zeroes. The block always ends with a 5-byte End of Record field containing zeroes.

If you specify BLKLEN(*NONE), then the system fills the block with as many complete entries as it can fit within the block size that you specified. The system does not send a partial entry to fill the block size. If the specified entry format is not *TYPEPTR or *JRNENTFMT, the maximum number of bytes that are available for the journal entries is 99989 bytes. 10 bytes in each block are reserved for the Block Length field and for the End of Record field. If the specified entry format is *TYPEPTR or *JRNENTFMT, the maximum number of bytes that are available is 99999 bytes.

If you specify a block size that is not valid, the system begins block mode but it sends only one journal entry per block. The system sends message CPD7095 to indicate that you have specified a block size that is not valid. If you specify a block size that is not valid or too small for a single journal entry, the system still returns at least one journal entry to the exit program. If the specified entry format is *TYPEPTR or *JRNENTFMT, the block size must be at least 13 bytes to be considered valid.

When the System Sends a Record

When block mode is in effect, the system uses the following rules to determine when to call the exit program:

- If the block does not contain any entries but the next entry would exceed the maximum size for the block, then the entry is placed into the block. The exit program is called. The system always passes at least one complete journal entry to the exit program.
- If the next entry to be put into the block would exceed the maximum size for the block and the current block has entries in it, then the current block of entries is passed to the exit program.
- If the current block has one or more entries in it and no additional entries in the journal meet the selection criteria, the current block of entries is passed to the exit program.

When in block mode, the specification for the DELAY parameter is used only when the current block is empty and no entries are currently available to be returned to the exit program.

Using ENT_FMT(*TYPEPTR) or ENT_FMT(*JRNENT_FMT) with the RCVJRNE command

If the specified entry format is *TYPEPTR or *JRNENT_FMT, the layout of the journal entry data is the same as the layout that is described in the QjoRetrieveJournalEntries API interface. The layout is the same for both single entry and block entry mode when you specify *TYPEPTR or *JRNENT_FMT.

If you specify *TYPEPTR, the format will be the same as the RJNE0100 format of the QjoRetrieveJournalEntries API.

When you specify *TYPEPTR or *JRNENT_FMT, the journal entry data may have pointers that will point to additional entry-specific data.

Related concepts

[Working with pointers in journal entries](#)

Under certain conditions, not all of the journal entry data will be immediately retrievable from a journal entry. Instead, part of the journal entry information will include pointers to additional journal entry-specific data.

Related reference

[Receive Journal Entry \(RCVJRNE\) command](#)

[Retrieve Journal Entries \(QjoRetrieveJournalEntries\) API](#)

Retrieving journal entries in a program

Use the Retrieve Journal Entry (RTVJRNE) command or the Retrieve Journal Entries (QjoRetrieveJournalEntries) API in a program to retrieve a journal entry and place it in a variable in the program.

You can also use the QjoRetrieveJournalEntries API to retrieve a journal entry and return data which can include pointers.

RTVJRNE command

Use the RTVJRNE command in a program to retrieve a journal entry and place it in variables in the program. You can retrieve the following:

- Sequence number
- Journal code
- Entry type
- Journal receiver name
- Library name for the journal receiver
- Journal entry-specific data

You can use this method to create programs to automate recovery. For layout of the fixed-length portion and variable-length portion of a journal entry see the Journal entry information finder.

The RTVJRNE command supports the same selection criteria (database files, data areas, data queues, or integrated file system objects) as the Display Journal (DSPJRN) command. You can specify which entries go to the exit program. For the format of the record for the RTVJRNE command, see the Retrieve Journal Entry (RTVJRNE) Command Description.

The QjoRetrieveJournalEntries API

The QjoRetrieveJournalEntries API allows you to retrieve journal entries into a receiver variable. The available journal entry information is similar to what is provided by using the Display Journal (DSPJRN), Receive Journal Entry (RCVJRNE), and Retrieve Journal Entry (RTVJRNE) commands, but it also provides additional journal entry data that cannot be retrieved with the Display Journal (DSPJRN) or Retrieve Journal Entry (RTVJRNE) commands. This additional data is accessed using pointers. Refer to Working with pointers in journal entries for more information.

Related concepts

[Working with pointers in journal entries](#)

Under certain conditions, not all of the journal entry data will be immediately retrievable from a journal entry. Instead, part of the journal entry information will include pointers to additional journal entry-specific data.

Related reference

[Retrieve Journal Entry \(RTVJRNE\) command](#)

Related information

[Journal entry information finder](#)

Working with pointers in journal entries

Under certain conditions, not all of the journal entry data will be immediately retrievable from a journal entry. Instead, part of the journal entry information will include pointers to additional journal entry-specific data.

These pointers will only be retrieved if you use following:

- Retrieve Journal Entries (QjoRetrieveJournalEntries) API
- The *TYPEPTR format on the **Receive Journal Entry (RCVJRNE)** command
- The *JRNENTFMT format on the **RCVJRNE** command (you must also specify the RTNPTR parameter for the RCVJRNE command)

In all other retrievals of journal entry data, *POINTER would be in the field where a pointer could exist. An incomplete data indicator has been added to indicate if the journal entry-specific data has data missing which can only be retrieved through a pointer

If the QjoRetrieveJournalEntries API or the *TYPEPTR or *JRNENTFMT format on **RCVJRNE** command is used and the incomplete data indicator field is 1, the journal entry-specific data will contain pointers. For all other interfaces, if the incomplete data indicator is 1, the journal entry-specific data will have the character string *POINTER in the field where an actual pointer would be placed if the API or *TYPEPTR or *JRNENTFMT interfaces were used. The incomplete data indicator field could be set to 1 if the journal entry-specific data exceeds 32766 bytes, or if the journal entry is associated with a database file which has one or more fields of data type BLOB (binary large object), CLOB (character large object), or DBCLOB (double-byte character large object). Use the Journal entry information finder to find which journal entry types can set the incomplete data indicator on.

These pointers can only be used with the V4R4M0 and later versions of the following languages:

- ILE/COBOL
- ILE/RPG
- ILE/C if the TERASPACE parameter is used when compiling the program.

There are some considerations you need to be aware of when using the pointer data:

- The pointer can only be used by the process or job which retrieved or received the journal entry which contained the pointer. The pointer cannot be passed on to another job, nor can it be stored to use at a later date by a different job or process.
- The pointer will only give you read access to the additional data. Write operations to that pointer are not allowed.
- The data that is being pointed to actually resides in the journal receiver. Therefore, ensure that you protect the journal receiver from deletion until you use the data. To prevent a journal receiver from being deleted before the data is used, you can register an exit point for the **Delete Journal Receiver (DLTJRNRCV)** command.
- For files with fields of data type BLOB (binary large object), CLOB (character), or DBCLOB (double-byte character large object), use SQL to update the files.

If any journal entries are returned with pointers, the journal entry will also contain a pointer handle. This pointer handle must be used to free up any allocations associated with the pointer data once the pointer data has been used. The considerations for this pointer handle are as follows:

- Using the pointer data means any of the following:
 - Addressing the information and copying the addressed data to another object
 - Using the journal entry-specific data directly to modify another object. For example, using the data to update a database file with the journal entry which represents a database record update for a file which included LOBs.
 - Ignoring the additional data that is pointed to
- If you used the `QjoRetrieveJournalEntries` API, use the `Delete Pointer Handle (QjoDeletePointerHandle)` API to delete the pointer handle when you are done using it.
- If you use the **RCVJRNE** command with the `RTNPTR(*SYSMNG)` parameter, you must use the associated pointer prior to returning control from the exit program. The system will delete all pointer handles after the return from the exit program call.
- If you use the **RCVJRNE** command with the `RTNPTR(*USRMNG)` parameter, then it is your responsibility to use the `Delete Pointer Handle (QjoDeletePointerHandle)` API to delete the pointer handle when you are done using it.

Related tasks

[Deleting journal receivers](#)

Journal receivers can quickly use a lot of auxiliary storage space. Therefore an important journal management task is to delete journal receivers after you no longer need them.

Related reference

[Retrieve Journal Entries \(QjoRetrieveJournalEntries\) API](#)

[Receive Journal Entry \(RCVJRNE\) command](#)

[Delete Journal Receiver \(DLTJRNRCV\) command](#)

[Delete Pointer Handle \(QjoDeletePointerHandle\) API](#)

Related information

[Journal entry information finder](#)

Replaying a database operation from a single journal entry

Use the `Replay Database Operation (QDBRPLAY)` API to replay a database operation from a single journal entry. You can only use the `QDBRPLAY` API to replay journal entries for database file objects. Also, the API does not run under commitment control even if the original journal entry was performed as part of a committable transaction.

Since these database journal entries can be very large, be sure to retrieve the journal entries using an interface that supports pointers (either the `Retrieve Journal Entries (QjoRetrieveJournalEntries)` API or the **Receiver Journal Entry (RCVJRNE)** command).

You can use the `QDBRPLAY` API to replay the following journal entries. You can get more information about these journal entries in the [Journal entry information finder](#).

| Journal code | Entry type | Description |
|--------------|------------|-------------------|
| D | AC | Add Constraint |
| D | CG | Change File |
| D | CT | Create File |
| D | DC | Remove Constraint |
| D | DT | Delete File |
| D | FM | Move File |
| D | FN | Rename File |
| D | GC | Change Constraint |
| D | GO | Change Owner |
| D | GT | Grant File |
| D | RV | Revoke File |
| D | TC | Add Trigger |
| D | TD | Remove Trigger |
| D | TG | Change Trigger |
| D | TQ | Refresh Table |
| F | CB | Change Member |
| F | DM | Remove Member |
| F | MC | Add Member |
| F | MN | Rename Member |
| F | RM | Reorganize Member |

Renaming exit program

The QDBRPLAY API has an exit program that can change the names of the objects that are referenced in the journal entry. If a rename exit program is specified, each name referenced during the replay of the operation will be passed to the rename exit program. The names passed to the rename exit program might be short names or long SQL names. The same name might be passed to the exit program more than once if it is referenced in the internal journal entry specific data more than once. If the names are changed by the rename exit program, the names are case sensitive and must conform to any i5/OS and SQL rules for object names.

Related concepts

[Retrieving journal entries in a program](#)

Use the Retrieve Journal Entry (RTVJRNE) command or the Retrieve Journal Entries (QjoRetrieveJournalEntries) API in a program to retrieve a journal entry and place it in a variable in the program.

Related reference

[Replay Database Operation \(QDBRPLAY\) API](#)

[Retrieve Journal Entries \(QjoRetrieveJournalEntries\) API](#)

Related information

[Journal entry information finder](#)

Replaying a non-database operation from a single journal entry

Use the Replay Journal Entry (QjoReplayJournalEntry) API to replay an operation from a single journal entry.

You can use the QjoReplayJournalEntry API to replay the following journal entries. You can get more information about these journal entries in the Journal entry information finder.

| Journal code | Entry type | Description |
|---------------------|-------------------|-----------------------------------|
| E | EE | Create data area |
| Q | QA | Create data queue |
| Q | QL | Receive data queue entry, has key |
| Q | QR | Receive data queue entry, no key |

Like the QDBRPLAY API, the QjoReplayJournalEntry API also has an exit program that can change the names of the objects that are referenced in the journal entry.

Considerations for entries which contain minimized entry-specific data

Reduce the size of journal receivers by specifying minimized entry-specific data on the Create Journal (CRTJRN) and Change Journal (CHGJRN) commands.

If you have selected to use the MINENTDTA parameter for the journal, then some of your journal entries' entry-specific data will be minimized. The entries will only be minimized if the minimization technique will deposit a journal entry which is smaller in size than the complete entry would be. Use the Journal entry information finder to see which specific journal entry types can possibly be minimized. When the entry is minimized, the fixed-length portion of the journal entry will have the minimized entry-specific data indicator on. Currently, only data areas and database physical files can have their entry-specific data minimized.

Data area considerations

The layout of the data area entries which are minimized is exactly the same as the layout if the entry was not minimized. The only difference is that only the bytes which actually changed are deposited rather than depositing all the bytes on the change request.

Database physical file considerations

The layout of the minimized record changes entries is completely different than the layout when the entry is not minimized. If MINENTDTA(*FILE) is used, the data is not readable because sophisticated hash techniques are used in addition to only operating on actual changed bytes. Additionally, the Null-value-indicators field will be used, even if the file is not null capable, to provide additional information that can be used by database operations. Therefore, if you want to use the journal as an audit mechanism, you may not want to choose the MINENTDTA(*FILE) option for database physical files since you will not be able to read the actual change made.

If minimized journal entries are collected on field boundaries using the MINENTDTA(*FLDBDY) option, the data within the journal entries may be displayed in the recognizable record layout of the file. When this option is used, fields that were not collected will display default data and the null value indicator table will use a new value to indicate which fields are showing the actual data versus which ones are showing default data because the fields were not collected. A '9' in the null value field will indicate the data is not actual data and that it was filled in with default data.

Even if the file is not null capable, the Null value indicators field is used to provide additional information that can be used by database operations. Therefore, if you want to use the journal for auditing purposes, you may want to use the *FLDBDY value on the Minimized entry specific data (MINENTDTA) parameter for the CRTJRN and CHGJRN commands discussed below.

Viewing of minimized entry-specific data

The *FLDBDY value indicates that minimizing of record level changes should be done on field/column boundaries for all files journaled to the specified journal. Using the **Display Journal (DSPJRN)** command, entries are viewable to the screen, an outfile, or printed output. If a journal entry has been minimized on field boundaries, the value of 2 is returned in the Minimized entry specific data field of the *OUTFILE and in the Min field of the printed output. The **RCVJRNE** and **RTVJRNE** commands can also be used to view entries that were minimized on field boundaries by specifying *YES on the Format minimized data (FMTMINDTA) parameter. The QjoRetrieveJournalEntries API can be used to view entries that were minimized on field boundaries by specifying *YES for the Format minimized data (FMTMINDTA) key.

Related concepts

[Layouts for variable-length portion of journal entries](#)

The following tables contain the variable-length portion of the layouts for journal entries.

Related reference

[Create Journal \(CRTJRN\) command](#)

[Change Journal \(CHGJRN\) command](#)

Related information

[Journal entry information finder](#)

Remote journal management

Use remote journal management to establish journals and journal receivers on a remote system that are associated with specific journals and journal receivers on a local system. Remote journal management replicates journal entries from the local system to the journals and journal receivers that are located on the remote system after they have been established.

Remote journal management allows you to establish journals and journal receivers on a remote system or to establish journal and receivers on independent disk pools that are associated with specific journals and journal receivers on a local system. The remote journaling function can replicate journal entries from the local system to the journals and journal receivers that are located on the remote system or independent disk pools after they have been established.

Use the following information to set up remote journal management:

Remote journal concepts

Remote journal management helps to efficiently replicate journal entries to one or more systems. You can use remote journal management with application programs to maintain a **data replica**. A data replica is a copy of the **original data** that resides on another system or independent disk pool. The original data resides on a primary system. Applications make changes to the original data during normal operations.

Prior to V4R2M0, you could have accomplished a similar function by using the Receive Journal Entry (RCVJRNE) command. In that environment, the RCVJRNE exit program receives journal entries from a journal, and then sends the journal entries to the remote system by using whatever communications method is available. All of this processing occurs asynchronously to the operation that is causing the journal entry deposit and takes place at an application layer of the system.

The remote journal function, however, replicates journal entries to the remote system at the Licensed Internal Code layer. Moving the replication to this lower layer provides the following:

- The remote system handles more of the replication overhead
- Overall system performance and journal entry replication performance is improved
- Replication can (optionally) occur synchronously to the operation that is causing the journal entry deposit
- Journal receiver save operations can be moved to the remote system.

The figures below illustrate a comparison of a hot-backup environment with and without remote journal management. **Hot-backup** is the function of replicating an application's dependent data from a **primary**

system to a **backup system**. The primary system is the system where the original data resides. The backup system is the system where a replica of the original data is being maintained. In the event of a primary system failure, you can perform a switch-over to the backup system.

Hot-backup environment without remote journal function, and application-code based apply

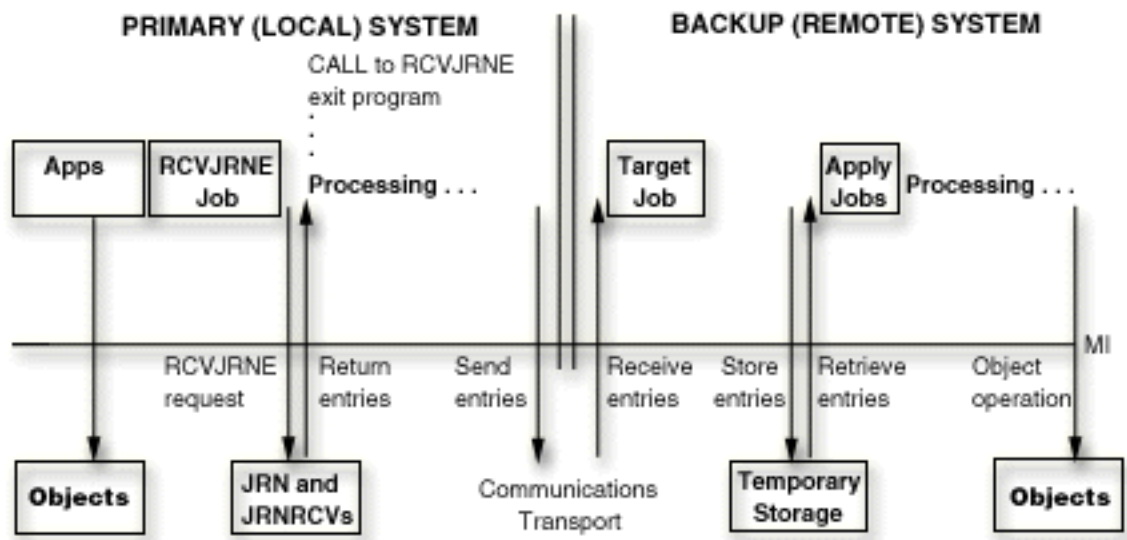

This figure above illustrates that processing with the RCVJRNE command occurs asynchronously to the operation that is causing the journal entry deposit. This processing requires more overhead than the remote journal function.

Hot-backup environment with remote journal function, and application-code based apply

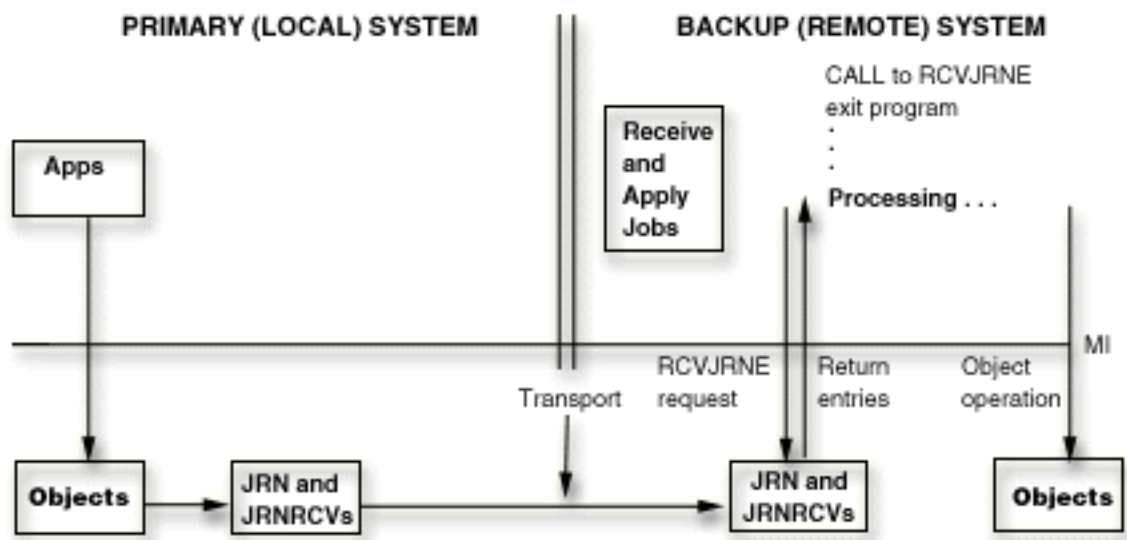

This figure above illustrates that processing with the remote journal function occurs synchronously to the operation that is causing the journal entry deposit. This processing requires less overhead than the RCVJRNE command.

The following topics provide more information about remote journaling:

Related reference

[Receive Journal Entry \(RCVJRNE\) command](#)

Network configurations for remote journals

This topic describes various network configuration for remote journals.

The following figure shows the two basic remote journal function configurations.

Broadcast Configuration

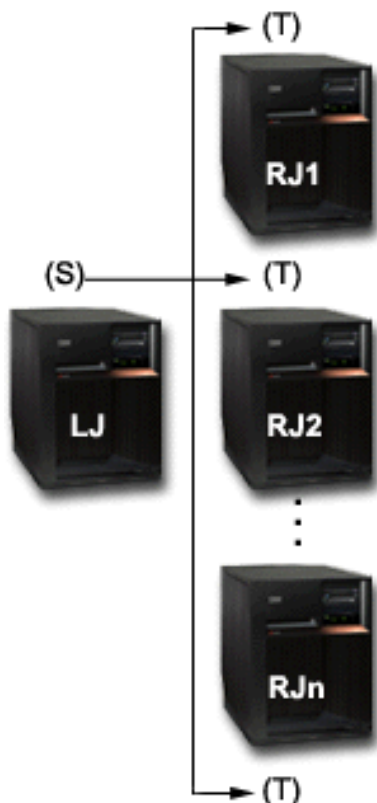

A local journal replicating journal entries to multiple remote journals.

Cascade Configuration

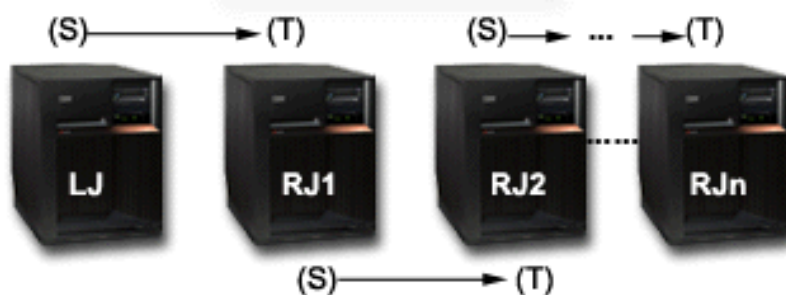

Remote journals that cascade to other remote journals.

A **broadcast** configuration is a journal that replicates its journal entries to one or more remote journals. A **cascade** configuration is a remote journal that replicates its journal entries to an additional remote journal. The additional remote journal can replicate the entries to yet another remote journal, and so on. The remote journal function configurations can stand alone or can be combined with one another. For example, one or more of the remote journals in the broadcast configuration could cascade down to several additional remote journals. Likewise, one or more remote journals in the cascade configuration could broadcast out to one or more remote journals.

A **local journal** is populated by applications that are depositing journal entries. A **remote journal** is populated by receiving its journal entries from either a local or another remote journal. The journals are paired, as depicted in the preceding figure where (S) represents a journal on a source system, and (T) represents a journal on a target system. In the cascade configuration, a remote journal can be a recipient of journal entries (a target), and a replicator of journal entries (a source) at the same time.

A **source system** is a system where a journal resides and is having its journal entries replicated to a remote journal on a target system.

Note: A source system is not necessarily the primary system. For example, a remote journal that is cascading its journal entries to another remote journal is said to reside on a source system.

A **target system** is a system where a remote journal resides and is receiving journal entries from a journal on a source system.

A **remote journal network** includes the local journal and all of the remote journals that are downstream from that local journal. You can set up the remote journal network in broadcast configuration, cascade configuration, or a combination of the two configurations.

In many environments, users attempt to minimize the amount of processing that the local or primary system performs by shifting as much of the processing as possible to other systems in the network. A combination of the broadcast and cascade configurations allows for this when replicating the journal entries from a single system to multiple other systems. For example, replicating a local journal to a single remote journal on a target system will minimize the replication cost on the primary system. Then, from the target system, the replicated journal can be asynchronously replicated by either a broadcast or cascade configuration to other remote journals on other systems. This allows all of the journal entries to be known to all desired systems, while requiring a minimal amount of processing on the primary system.

The following characteristics apply to local journals and to any journal receivers that were attached to local journals:

- Objects can be journaled to local journals.
- Journal entries can be directly deposited to local journals. For example, the Send Journal Entry (SNDJRNE) command or the Send Journal Entry (QJOSJRNE) API can be used to send journal entries directly to a local journal.

The following characteristics apply to remote journals and to any journal receivers that were attached to remote journals:

- Objects cannot be journaled to remote journals.
- Journal entries cannot be directly deposited to remote journals. For example, the Send Journal Entry (SNDJRNE) command or API (QJOSJRNE) cannot be used to send journal entries directly to a remote journal.
- Journal entries are only replicated to remote journals from an associated **source journal**. A source journal is the journal on the source system to which a remote journal has been added. A source journal can be either a local or a remote journal.
- The information in the journal entries such as time stamps, system name, and qualified journal receiver names reflect information as deposited in the local journal for this remote journal network.
- The information in the journal receiver such as attach time and detach time reflect the information as it is for the local journal for the remote journal network.
- Certain attributes of the remote journal are fixed and determined based on the source journal, such as the values for the journal receiver, manage receiver, manage receiver delay, receiver size options, journal cache, fix length data, threshold, journal object limit, and journal recovery count. These attributes cannot be changed because either they do not apply for a remote journal or they can only be changed by changing the attributes of the source journal.

Types of remote journals

The two types of remote journals are *TYPE1 and *TYPE2. The two types identify operational characteristics of a remote journal and its associated journal receivers. The following table is an overview of the different remote journal types and their characteristics. There are no performance differences between the types of remote journals.

For help in determining which remote journal to use see IBM Redbooks® technote [Remote Journaling on i5/OS - Are You Selecting the Right Type?](#) 

| | Local journal | *TYPE1 remote journal | *TYPE2 remote journal |
|--|---------------|-----------------------|-----------------------|
| Remote journal types that can be added | *TYPE1 *TYPE2 | *TYPE1 *TYPE2 | *TYPE2 |

| | Local journal | *TYPE1 remote journal | *TYPE2 remote journal |
|---|--|---|---|
| Remote journal name | N/A | Journal name must be the same as the local journal. | Journal name may be different from the source journal. |
| Journal library redirection | N/A | Journal library name may be redirected to a single different library from that of the local journal. Subsequent adds of *TYPE1 remote journals must specify the same library redirection that was specified on the previously added *TYPE1 remote journal. | A given redirected library may be specified when adding a remote journal. Subsequent adds of *TYPE2 remote journals may specify a different library redirection than was specified on any previously added remote journal. |
| Journal receiver library redirection | N/A | Receiver library name may be redirected to a single different library from that of the receivers associated with the local journal. Subsequent adds of *TYPE1 remote journals must specify the same library redirection that was specified on the previously added *TYPE1 remote journal. | A given redirected library may be specified when adding a remote journal. Subsequent adds of *TYPE2 remote journals may specify a different library redirection than was specified on any previously added remote journal. |
| Journal receiver library redirection used on activate | N/A | The target library used when replicating a receiver from the source journal to this remote journal will reflect the library redirection that was in place for the receiver, if any, at the time the receiver was attached to the source journal. ¹ | The target library used when replicating a receiver from the source journal to this remote journal will reflect the library redirection that is currently defined for the target journal. |
| Receiver restore characteristics ^{2, 3} | Receivers associated with the local journal can be saved and restored to the local system or to any of the systems for the *TYPE1 remote journals and be linked into the correct receiver chain of the local journal or the *TYPE1 remote journal. | Receivers associated with the local journal or any of the *TYPE1 remote journals can be saved and restored to the local system or to any of the systems where the *TYPE1 remote journals reside and be linked into the correct receiver chain of the journal. | Receivers associated with a given *TYPE2 remote journal can be saved and restored to the local system or to the same system where the *TYPE2 remote journal resides and be linked into the correct receiver chain of the journal. |

| | Local journal | *TYPE1 remote journal | *TYPE2 remote journal |
|---|---------------|-----------------------|-----------------------|
| <p>Notes:</p> <p>¹If the journal receiver was attached to a journal when no remote journals were added, then no library redirection is assumed for that journal receiver if that receiver is specified during activation. Therefore, the journal receiver will be created in the same library on the target system as it is on the local system.</p> <p>²A journal receiver from any system in the remote journal network may always be restored to any system if the receiver is being restored into the original or redirected receiver library. Otherwise, receivers can always be restored to any system and associated with a local journal if a local journal by the same name as the original local journal is found residing in the same named original local journal library.</p> <p>³If a journal receiver's original or redirected library exists in an independent disk pool, then the ASP group name for the independent disk pool is used in place of the system name when making restore decisions.</p> <p>See Considerations for save and restore operations with remote journals for more information.</p> | | | |

Related concepts

[Considerations for save and restore operations with remote journals](#)

The following information describes general considerations for save and restore operations with remote journals:

Filtered remote journals

Remote journal filtering allows for the journal receiver on the target system to not be a complete copy of the journal receiver on the source system. Filtering allows some number of journal entries to not be sent to the target system. Not sending all journal entries decreases the amount of data on the communication line. Care must be taken when defining remote journal filtering to ensure that critical data is not filtered.

Remote journal filtering is available under Option 42 of the IBM i Operating System, feature 5117 (HA Journal Performance). Three criteria can be used to filter entries sent to the remote system; before images, individual objects, and the name of the program that deposited the journal entry on the source system. The filtering criteria are specified when activating a remote journal. Different remote journals associated with the same local journal can have different filter criteria. Remote journal filtering can only be specified for asynchronous remote journal connections. Note: Since journal entries might be missing, filtered remote journal receivers cannot be used with the **Remove Journalled Changes (RMVJRNCHG)** command. Similarly, journal receivers that filtered journal entries by object or by program cannot be used with the **Apply Journalled Change (APYJRNCHG)** command or the **Apply Journalled Change Extend (APYJRNCHGX)** command.

Often, before images are captured on the source system to allow for debugging, or for commitment control purposes. Sometimes these entries are not required on the target system. All before images can easily be filtered from a remote journal.

In some environments, non-critical files are journaled on the source system because of commitment control requirements. The journal entries for these non-critical objects can be filtered out in a remote journal environment and not sent to the target system if they are not needed there. Each object that is to have journal entries filtered must be changed to contain the remote journal filter indication. The **Change Journalled Object (CHGJRNOBJ)** command can be used to set this remote journal filter indication. Objects that automatically start journaling due to library journaling can have the indication set when they start journaling based on the inherit rules defined for library journaling.

Occasionally, journal entries deposited on behalf of a given program are not needed on the target system. These journal entries can be omitted with remote journal program filtering. This filtering can only be specified by using the `QjoChangeJournalState` API.

See these commands and API for details on remote journal filtering:

- [Change Remote Journal \(CHGRMTJRN\)](#)
- [Change Journal State \(QjoChangeJournalState\) API](#)

- [Start Journal Library \(STRJRNLIB\)](#)

Journal state and delivery mode

The **journal state** describes an attribute for a journal. The attribute value can be *ACTIVE, *INACTIVE (remote journal only), or *STANDBY (local journal only). For a local journal, *ACTIVE indicates that journal entries are currently allowed to be deposited into the journal. *STANDBY indicates that most journal entries are not deposited.

You can view the journal state for a remote journal on a target system that is associated with a journal on a source system in one of two ways:

- When viewing the remote journal information of the local journal from the source, *ACTIVE indicates that journal entries are currently being replicated to that remote journal on the target system. *INACTIVE indicates that journal entries are not currently being replicated.
- When viewing the journal attributes of the remote journal from the target, *ACTIVE indicates that journal entries are currently being received from the journal on the source system. *INACTIVE indicates that the target journal is not ready to receive journal entries from the source journal.

The following table provides a summary of the journal type, delivery mode and journal state interactions.

| Journal type | Delivery mode | Journal state | Comments |
|--------------|----------------|---------------|---|
| *LOCAL | Not applicable | *ACTIVE | Objects journaled to the local journal can be changed, and entries can also be deposited into the local journal using the Send Journal Entry (SNDJRNE) command or the Send Journal Entry (QJOSJRNE) API interfaces. The currently attached journal receiver may or may not be currently replicated to one or more remote journals. This depends upon whether any remote journals have been added to the local journal's definition, and if so, the current journal state for each of those remote journals. |

| Journal type | Delivery mode | Journal state | Comments |
|--------------|----------------|---------------|--|
| *LOCAL | Not applicable | *STANDBY | <p>This is the state of a local journal after the Change Journal (CHGJRN) command specifying JRNSTATE(*STANDBY) is used to not allow deposits into the local journal. The local can journal can also be in *STANDBY state after an IPL if the local journal is in *STANDBY state when the system ends.</p> <p>Objects journaled to the local journal can be restored or changed, but most journal entries are not deposited until the journal state for the local journal is again changed to *ACTIVE. This can be performed by using the Change Journal (CHGJRN) command specifying JRNSTATE(*ACTIVE).</p> |
| *REMOTE | *SYNCPEND | *ACTIVE | <p>This is the state after a remote journal has been activated using the Change Journal State (QjoChangeJournalState) API or CHGRMTJRN command and the processing is still in the catch-up phase of remote journal activation. Synchronous delivery mode was requested on the API invocation.</p> |

| Journal type | Delivery mode | Journal state | Comments |
|---------------------|----------------------|----------------------|--|
| *REMOTE | *SYNC | *ACTIVE | This is the state after a remote journal has been activated using the Change Journal State (QjoChangeJournalState) API or CHGRMTJRN command, after catch-up has completed, and changes to the currently attached journal receiver for the journal on the source system are being replicated synchronously to the remote journal on the target system. |
| *REMOTE | *ASYNCPEND | *ACTIVE | This is the state after a remote journal has been activated using the Change Journal State (QjoChangeJournalState) API or CHGRMTJRN command and the processing is still in the catch-up phase of remote journal activation. Asynchronous delivery mode was requested on the API invocation. |
| *REMOTE | *ASYNC | *ACTIVE | This is the state after a remote journal has been activated using the Change Journal State (QjoChangeJournalState) API or CHGRMTJRN command, after catch-up has completed, and changes to the currently attached journal receiver for the journal on the source system are being replicated asynchronously to the remote journal on the target system. |

| Journal type | Delivery mode | Journal state | Comments |
|---------------------|----------------------|----------------------|---|
| *REMOTE | *SYNC | *INACTPEND | This is the state of a remote journal, viewed from the target system where some failure has occurred and either the system is in the process of inactivating the remote journal, or unconfirmed journal entries exist in the remote journal. See Confirmed and unconfirmed journal entries for more information. |
| *REMOTE | *ASYNC | *INACTPEND | This is the state of a remote journal, viewed from the target system where some failure has occurred and the system is in the process of inactivating the remote journal. |
| *REMOTE | *ASYNC | *CTLINACT | This is the state after a remote journal has been made inactive using the Change Journal State (QjoChangeJournalState) API or CHGRMTJRN command, a controlled deactivate was requested on that call and that controlled deactivate has not yet completed. |
| *REMOTE | Not applicable | *INACTIVE | This is the state after a remote journal has been added and associated with a journal on a source system. However, the journal state for the added remote journal has yet to be activated or has been made inactive using the Change Journal State (QjoChangeJournalState) API, CHGRMTJRN command, or by an IPL. No delivery mode is in effect for an inactive remote journal. |

Related concepts

Confirmed and unconfirmed journal entries

For a local journal, all entries are confirmed entries. There is no concept of unconfirmed entries.

Journal receivers associated with a remote journal

Journal receivers that are associated with a remote journal are exact replicas of the corresponding journal receivers that are associated with the journal on the source system. The one exception to this rule is filtered remote journal receivers. In that case the remote journal receiver may not contain all the journal entries that the local journal receiver contains.

The receiver directory for a remote journal is maintained in the same way as the receiver directory is maintained for the related source journal. Consecutive receivers associated with a remote journal are linked together to form a receiver chain. Receiver chain breaks are forced and maintained in a similar manner for local and remote journals.

However, the following are some other differences for remote journals and the journal receivers that were attached to remote journals:

- A remote journal does not have to have a currently attached journal receiver. However, if the remote journal is ready to receive journal entries, then it must have an attached receiver; all the journal entries will be replicated to that attached receiver.
- The receiver that is currently attached to a remote journal that is in the catch-up phase can be a different journal receiver than is currently attached to the source journal.
- The receiver that is currently attached to an asynchronously maintained remote journal can be a different journal receiver than is currently attached to the source journal.
- The receiver that is currently attached to a synchronously maintained remote journal is the same journal receiver as is currently attached to the source journal.
- You can delete the journal receiver that is attached to a remote journal if the journal state of that journal is not *ACTIVE.
- You can delete the journal receivers that are associated with a remote journal in any order, regardless of their position within the receiver directory chain.
- The creation date and time stamps for remote journals are always those of the system on which the journals were created by the remote journal function. This is also true for journal receivers that were attached to remote journals.
- The save and restore date and time stamps for remote journals are always those of the system on which the save or restore operation took place. This is also true for the journal receivers that are associated with the remote journals.
- The attach and detach time stamps for a journal receiver that was attached to a remote journal are always those of the attach and detach time stamps of the local journal receiver.
- When a journal receiver that is associated with a remote journal is saved, deleted or restored, the following journal entries are not deposited:
 - J RD - Journal receiver deleted
 - J RF - Journal receiver saved, storage freed
 - J RR - Journal receiver restored
 - J RS - Journal receiver saved

For more information about journal receiver directory chains, see [Keep track of journal receiver chains](#).

Related concepts

Journal receiver chains

Journal receivers that are associated with a journal (that is presently or previously attached to the journal) are linked in one or more **receiver chains**. Each journal receiver, except the first one, has a previous receiver that was detached when the current receiver was attached. Each journal receiver, except the one that is currently attached, also has a next receiver.

Process of adding remote journal

Adding a remote journal creates a remote journal on a target system or independent disk pool and associates that remote journal with the journal on the source system. This occurs if this is the first time the remote journal is being established for a journal. The journal on the source system can be either a local or remote journal.

If a remote journal environment has previously been established, adding a remote journal re-associates the remote journal on the target system with the journal on the source system.

You can establish and associate a remote journal on a target system with a journal on the source system by one of the following methods:

- System i Navigator.
- Add Remote Journal (QjoAddRemoteJournal) API on the source system.
- Add Remote Journal (ADDRMTJRN) command on the source system.

What happens during add remote journal processing

Some of the processing which takes place as part of adding a remote journal is as follows:

- A check is performed on the target system to verify that the user profile adding the remote journal exists. A user profile with the same name as the user profile which is adding a remote journal must exist on the target system. If the profile does not exist on the target system, then an exception is signaled, and the processing ends.
- A check is performed to verify that the target system has a library by the same name as the library for the journal on the source system. If the library does not exist on the target system, then an exception is signaled, and the processing ends.
- A check is performed on the target system to determine if a journal by the same qualified name as the journal on the source system already exists. If a journal already exists, it can be used for the remainder of the add remote journal processing if it meets the following conditions:
 1. It is a remote journal.
 2. It was previously associated with this same source journal or part of the same remote journal network.
 3. The type of the remote journal matches the specified remote journal type.
- If a journal was found, but does not meet the above criteria, then an exception is signaled, and the processing ends. Otherwise, the remote journal is used for the rest of the add remote journal processing.
- If no journal is found on the specified target system, then a remote journal is created on the target system. The new remote journal has the same configuration, authority, and audit characteristics of the source journal. The journal that is created has a journal type of *REMOTE.

The creation of the journal on the target system is performed as though the journal was being saved and restored to the target system. Therefore, the ownership of the journal on a target system will follow the same rules as with the existing save and restore functions. If the user profile which owns the journal on the source system is on the target system, then that profile will own the created journal on the target system. If the user profile does not exist on the target system, then the profile QDFTOWN will own the journal on the target system.

Additionally, if the remote journal is created, the values for the journal attributes of text, journal message queue, delete receivers value, and delete receiver delay time will be taken from what is specified on the API invocation. After the remote journal has been created, these values can be changed by using the Change Journal (CHGJRN) command for the remote journal on the remote system. After the remote journal is created, any changes to these attributes on the source journal will not cause equivalent changes to the remote journal.

When adding the remote journal, you must specify the type of remote journal to add. The remote journal type influences the library redirection rules and other operational characteristics for the journal.

Guidelines for adding a remote journal

Here are guidelines for adding a remote journal.

- You can only associate a remote journal with a single source journal.

Note: The same remote journal can then have additional remote journals that are associated with it that are located on other target systems. This is the cascade configuration that is shown in Network configurations for remote journals.

- The remote journal will only have its attached receiver populated with journal entries that are replicated from the corresponding journal receiver on the source system. No journal entries can be directly deposited to a remote journal.
- A maximum of 255 remote journals can be associated with a single journal on a source system. This can be any combination of asynchronously maintained or synchronously maintained remote journals.

Synchronous and asynchronous delivery mode has more information. Library redirection with remote journals and Remote journal attributes provide more concepts about the add remote journal process. Add remote journals provides the steps for adding a remote journal.

Related concepts

Types of remote journals

The two types of remote journals are *TYPE1 and *TYPE2. The two types identify operational characteristics of a remote journal and its associated journal receivers. The following table is an overview of the different remote journal types and their characteristics. There are no performance differences between the types of remote journals.

Network configurations for remote journals

This topic describes various network configuration for remote journals.

Synchronous and asynchronous delivery mode for remote journals

The terms **asynchronously maintained** and **synchronously maintained** both describe a remote journal function delivery mode for journal entry replication.

Related tasks

Adding remote journals

This topic provides instructions for adding a remote journal.

Library redirection with remote journals

Library redirection provides a means for remote journals and any of their associated journal receivers to optionally reside in differently named libraries on the target system from the corresponding local journal and journal receivers on the local system.

You can specify library redirection by using one of the following:

- System i Navigator
- Add Remote Journal (QjoAddRemoteJournal) API
- Add Remote Journal (ADDRMTJRN) command

When using the QjoAddRemoteJournal API, specify a different name in the Remote Journal Library name field or the Remote Journal Receiver Library field. When using the ADDRMTJRN command, specify a different name for the Target Journal Library parameter or the Remote Receiver Library parameter. When a remote journal is added, its journal type specification influences how much redirection you can specify.

Types of remote journals describes the various types of remote journals that can be added, as well as a description of their redirection characteristics.

If redirection is not specified, then the remote journal will reside in a library that has the same name as the library that contains the source journal.

Note: Library redirection for the journal object must be specified when replicating the journal entries to a target system for any journal starting with the letter Q in a library starting with Q. This does not apply to the QGPL library. This restriction prevents collisions between local and remote journals that are used

for system functions. One example of this is journal QAUDJRN in library QSYS which is used for security auditing.

If no redirection is specified for the journal receiver, then the remote journal receiver will reside in a library whose name is the same as the library for the source journal receiver. For example, the source journal has two receivers that are associated with it, receiver RCV0001 in library LIBA, and receiver RCV0002 in library LIBB. If no journal receiver library redirection is specified, then the journal entries in RCV0001 in library LIBA on the source will be replicated to RCV0001 in library LIBA on the target system. The journal entries in RCV0002 in library LIBB on the source will be replicated to RCV0002 in library LIBB on the target system. Therefore, both libraries, LIBA and LIBB, will need to exist on the target system prior to the invocation of the remote journal function. If journal receiver library redirection is specified with a redirected receiver library specification of RMTLIB, then both RCV0001 and RCV0002 would be in library RMTLIB on the target system.

For *TYPE1 remote journals, the library redirection or the selection of no library redirection for the journal and journal receivers can only be modified by doing the following:

- Remove all *TYPE1 remote journals.
- Change the local journal and attach a new journal receiver.
- Delete the remote journal from the target system.
- Add the *TYPE1 remote journal, specifying the new library redirection, if any.

For *TYPE2 remote journals, the library redirection or the selection of no library redirection for the journal and journal receivers can only be modified by doing the following:

- Remove the *TYPE2 remote journal.
- Delete the remote journal from the target system.
- Add the *TYPE2 remote journal, specifying the new library redirection, if any.

Independent disk pools and library redirection

If you want the remote journal on an independent disk pool on the target system, specify a library on the target system that is on an independent disk pool for that system and specify an RDB entry for the independent disk pool.

If you place your remote journal on an independent disk pool on the target system, the following rules apply:

- The independent disk pool on the target system must be varied on.
- The independent disk pool must be a library capable disk pool.
- The remote journal, the remote journal receiver, and the message queue must be in the same independent disk pool group.
- When TCP communications are being used to connect to an independent disk pool, the Relational Database (RDB) entry to the independent disk pool must have the Relational database value set to the target system's local RDB entry and the relational database alias value set to the independent disk pool's name.

Related concepts

Types of remote journals

The two types of remote journals are *TYPE1 and *TYPE2. The two types identify operational characteristics of a remote journal and its associated journal receivers. The following table is an overview of the different remote journal types and their characteristics. There are no performance differences between the types of remote journals.

Journal management and independent disk pools

Independent disk pools are disk pools 33 through 255. Independent disk pools can be user-defined file system (UDFS) independent disk pools or library-capable independent disk pools.

Remote journal attributes

When a remote journal is created by the add remote journal processing, the remote journal's initial attributes are defined by the add request and the source journal.

Various journal attributes for a remote journal are treated as follows:

Disk pool

If the library for the remote journal resides in a disk pool, the remote journal will be created in that disk pool.

Journal message queue

Defined on add request. Once the remote journal is created, the journal message queue, can be modified by using the Change Journal (CHGJRN) command on the remote journal on the remote system.

Delete receivers

Defined on add request. Once the remote journal is created, the delete receivers attribute can be modified by using the CHGJRN command on the remote journal on the remote system.

Manage receivers

Does not apply. The managing of the receivers for the remote journal is driven by the management of the source journal.

Minimize entry-specific data options

Does not apply. The minimize entry-specific data options in effect for the remote journal are driven by the minimize entry-specific data options in effect for the local journal.

Receiver size options

Does not apply. The receiver size options in effect for the remote journal are driven by the receiver size options in effect for the source journal.

Text

Defined on add request. Once the remote journal is created, the text can be modified by using the CHGJRN command on the remote journal on the remote system.

Manage receiver delay

The managing of the receivers for the remote journal is determined by the management of the source journal.

Delete receiver delay

Defined on add request. Once the remote journal is created, the delete receiver delay attribute can be modified by using the CHGJRN command on the remote journal on the remote system.

Fixed-length data

Does not apply. The fixed-length data options in effect for the remote journal are driven by the fixed-length data options in effect for the local journal.

Journal cache

Does not apply.

Journal object limit

Does not apply.

Journal recovery count

Does not apply.

Related reference

[Change Journal \(CHGJRN\) command](#)

Supported communications protocols for remote journals

The remote journal function supports the following communications protocols for replicating the journal entries to the remote systems:

- **OptiConnect for IBM i.** If you want to use the OptiConnect for IBM i support, you must purchase and install the required hardware and software for that support. Refer to [OptiConnect for IBM i](#) for more information.
- **Systems Network Architecture (SNA).** If you want to use SNA for the transport, there are no additional software considerations. The software support is in the base operating system. You must purchase whatever hardware is appropriate for your configuration. For more information, see the *SNA Distribution Services* manual in the IBM Publications Center at <http://www.elink.ibm.com/publications/servlet/pbi.wss?> .
- **Transmission Control Protocol/Internet Protocol(TCP/IP).** If you want to use TCP/IP for the transport, there are no additional software considerations. The software support is in the base operating system. You must purchase whatever hardware is appropriate for your configuration.

Note: All remote journal TCP connections use the TCP local port of 3777.

- **Data port.** Allows you to run remote journal over a cluster and specify up to four lines of communication, allowing for greater resiliency.
- **Sockets (IPv6).** Allows you to run remote journal over a Sockets IPv6 TCP/IP connection.

Note: All remote journal Sockets IPv6 connections use the TCP local port of 3888.

- **Secure Sockets (SSL).** Allows you to run remote journal over a Secure Sockets TCP/IP connection.

Note: All remote journal Secure Sockets connections default to using the TCP local port of 3889. If you want remote journal Secure Sockets connections to use a different port, you can remove the rmtjournal-ssl service table entry and add a rmtjournal-ssl service table entry with the port you want on both the source and target system using the **WRKSRVTBLE** command. Using Secure Sockets incurs a larger performance impact compared with any of the other supported communication protocols. The performance impact of Secure Sockets is dependent on the level of cipher/protocol chosen when configuring the remote journal application ID (QIBM_QJO_RMT_JRN_SRC and QIBM_QJO_RMT_JRN_TGT) using Digital Certificate Manager (DCM). For information on setting up SSL, see the configuring DCM topic [Configuring DCM](#)

Specifying a relational database (RDB) directory entry identifies the communications protocol that the remote journal function uses. The RDB that is specified must meet the following rules:

- The communications protocol must be one of the remote journal function supported protocols.
- The remote location name in the RDB cannot refer to the *LOCAL database.
- The RDB cannot use an application requester driver program (*ARDPGM) to locate the target system.
- When TCP communications are being used to connect to an independent disk pool, the Relational Database (RDB) entry to the independent disk pool must have the Relational database value set to the target system's local RDB entry and the relational database alias value set to the independent disk pool's name.

For more information about creating relational databases, refer to the [Distributed Database Programming](#) topic.

Security of the remote journal function is dependent on the communications protocol security. The remote journal function does not alter the security characteristics that are available.

When sending data to the target system using TCP (IPV4) or Sockets (IPV6) remote journal uses the greater value of 256 KB, or the size specified on **CHGTCPA** for TCP send buffer size (TCPSNDBUF) on the source system, or TCP receive buffer size (TCPRCVBUF) on the target system.

Implementing a Virtual Private Network (VPN) should provide a secure solution for the traffic between the VPN client and server in your remote journal environment. While VPN does not preclude data interception, use of VPN encryption does prevent the intercepted data from being interpreted or deciphered.

The communications function that is identified by the RDB can be shared by other activity. However, you may consider isolating the remote journal function activity in order to have the best performance.

Release-to-release considerations for remote journals

Release-to-release considerations for remote journals are discussed in this topic.

The release-to-release considerations for remote journals are:

- Information APAR II12556 contains a list of program temporary fixes (PTF) to apply for V5R1 support of remote journaling.
- If you specify RCVSIZOPT(*MAXOPT2) on the journal that you attach a journal receiver to, you cannot replicate the journal receivers to any remote journals on any systems at a release prior to V5R1M0.
- If you specify minimized-entry specific data (MINENTDTA) for either *FILE or *DTAARA on the journal to which you attached a journal receiver, you cannot replicate the journal receivers to any remote journals on any systems at a release before V5R1M0.
- If you specify minimized-entry specific data (MINENTDTA) for *FLDBDY on the journal to which you attached a journal receiver, you cannot replicate the journal receivers to any remote journals on any systems at a release before V5R4M0.
- If you specify RCVSIZOPT(*MAXOPT3) on the journal that you attach a journal receiver to, you cannot replicate the journal receivers to any remote journals on any systems at a release prior to V5R3M0.
- If JRNOBJLMT(*MAX10M) is specified for a local journal, the remote journal must exist on a system at a release of V5R4M0 or later.
- If remote journal filtering is used when activating the remote journal connection then the target system must be at release i 7.1 or later.

Planning for remote journals

This topic provide information for planning to set up remote journals.

Candidates for remote journal management

Journals that you are currently replicating, or that you plan to replicate to one or more systems, are excellent candidates for the remote journal function.

Journals with high activity that require frequent saves and deletes of the associated journal receivers during the day are also good candidates for the remote journal function. If you use remote journaling, you can specify that the backup system takes over the journal receiver save processing. Then the primary system can specify system journal-receiver management and automatic deletion of journal receivers. This frees up disk space on the primary system as quickly as possible. The backup system is the system where a replica of the original data is being maintained. The primary system is the system where the original data resides.

Also, you might have applications that are so critical to your business that any downtime will impact your operations. The **application dependent data** is a good candidate to protect with the remote journal function. Application dependent data is any data that a particular application depends on if that application is interrupted and has to be restarted.

For example, you may have a database that has a lot of query activity that impacts your system performance. That local database is a good candidate to replicate to another system so that the query activity moves from the local system to that remote system. The remote journal function can assist this process of replicating the database.

Related concepts

[Manual versus system journal-receiver management](#)

When you create a journal with System i Navigator or the Create Journal (CRTJRN) command, you can select to have either system managed or user managed journal receivers.

[Automatic deletion of journal receivers](#)

If you choose system journal receiver management, you can also have the system delete journal receivers that are no longer needed for recovery. You can only specify this if you are using system journal receiver management.

Synchronous and asynchronous delivery mode for remote journals

The terms **asynchronously maintained** and **synchronously maintained** both describe a remote journal function delivery mode for journal entry replication.

If a journal is asynchronously maintained, control is returned to the application generating the journal entry on the source system without waiting for the journal entry to be replicated to the remote journal. An asynchronously maintained remote journal might lag several journal entries behind the total number of journal entries in the journal on the source system. If a journal is synchronously maintained, control is not returned to the application generating the journal entry on the local system until the journal entry is replicated to the remote journal.

Synchronous delivery mode

Synchronous delivery means that the journal entry is replicated to the target system concurrently with the entry being written to the local receiver on the source system. The entry is known on the target system, in main storage, prior to returning control to the user application that deposited the journal entry on the source system. Therefore, the target system knows of all journal entries as they are being made in real-time on the source system. Using this mode allows for recovery without losing journal entries on the target system if the source system fails. Providing journal entries synchronously to a target system will have some affect to the journaling throughput on the local system.

Synchronous delivery mode is only supported when a remote journal is associated with a local journal.

There are certain circumstances, when using synchronous mode, when some journal entries are not immediately sent to the target system. These entries are either not necessary for recovery or the user did not specify that they be forced to disk. Journal entries are sent to the remote journal at the same time that they are forced to disk for the source journal. Since these entries are not forced to disk at deposit time, they are not sent to the remote system.

- Some entries that are not required for data recovery might not be immediately sent to the target system. For example, journal entries for a file close (journal code 'F', entry type 'CL') or a stream file open, (journal code 'B', entry type 'OF').
- User-generated journal entries that use the Send Journal Entry (SNDJRNE) command or the Send Journal Entry API (QJOSJRNE) might not be sent to the target system. If either you, or your application, do not request to force these user-generated entries they will only be replicated to the remote journal when some other action forces them. Therefore, periodically specify FORCE(*YES) when using the send journal entry functions.
- Journal entries that are associated with commitment control transactions might not be immediately sent to the remote system. These entries will be retrievable after the following journal entries have been deposited into the source journal:
 - Journal code 'C', journal entry type 'CM' (Commit)
 - Journal code 'C', journal entry type 'RB' (Rollback)
- See Remote journal considerations for retrieving journal entries when using commitment control for more information.
- When journal caching is being used (JRNCACHE(*YES) on the CHGJRN command), entries that exist only in the cache are not available on the target system. With journal caching, entries are not sent to the target system until they are written from the cache to disk on the source system.
- If the local journal is using journal caching, then journal entries will be bundled up before they are sent to the target.

Asynchronous delivery mode

Replicating a journal entry **asynchronously** means that the journal entry is replicated to the target system after control is returned to the application depositing the journal entry on the source system. Using this mode allows for recovery that might lose some journal entries if the source system fails. However, this mode has less affect to the journal throughput on the local system in comparison with the synchronous mode.

Journal entry latency might occur when remote journals are asynchronously maintained. Journal entry latency is the difference between the journal entries that exist in the remote journal on the target system from those residing in the journal on the source system. From a recovery standpoint, the source system might be some number of journal entries ahead of what journal entries are known on the target system.

Related concepts

Remote journal considerations for retrieving journal entries when using commitment control

Special performance related processing is done by the system when depositing entries that are associated with commitment control transactions to a local journal.

Communications protocol and delivery mode for remote journals

The greater the volume of traffic, that is the higher the rate of journal entry deposits, the faster communications method you must choose. If your traffic is minimal, then a slower communications method can be adequate.

The **delivery mode** defines how journal entries are replicated to a remote journal. The delivery mode only applies when actively replicating the journal entries from a journal on a source system to a remote journal on a target system. The delivery mode can be either synchronous or asynchronous.

If the application dependent data is critical and the loss of journal entries can impact your business, then use the synchronous delivery mode. Synchronous delivery mode is only valid when activating a remote journal that is associated with a local journal.

It may be acceptable that the remote system does not have all the journal entries as they are being deposited or replicated into the source journal. If this is true, the asynchronous delivery mode is a good choice to minimize the impact to the source journaling throughput.

The choice of delivery mode and communications protocol are closely linked. Since the synchronous delivery mode will affect the interactive users response time, the faster the communications protocol the better. This again will be dependent on the journal entry deposit rate.

Where the replication of journal entries start

When you specify a journal receiver for remote journaling, you are specifying where the replication of journal entries will start.

You can choose from the following options:

Attached receiver on target system

The replication of journal entries starts with the journal receiver that is currently attached to the remote journal on the target system. The journal entries are replicated from the corresponding journal receiver that is associated with the journal on the source system. The replication starts with the journal entries that follow the last journal entry that currently exists in the attached journal receiver on the target system.

The remote journal on the target system might not have an attached journal receiver. If this occurs, the journal receiver that is currently attached to the journal on the source system is created on the target system. That journal receiver is then attached to the remote journal on the target system. Then journal entries are replicated starting with the first journal entry in the journal receiver that is currently attached to the journal on the source system.

If the journal on the source system does not have an attached journal receiver, no journal entries can be replicated, and an error is returned. This is only possible in the case of a remote journal that is associated with another remote journal.

To use this option specify one of the following:

- Use the ***ATTACHED** special value for the Starting journal receiver (STRJRNRCV) parameter on the Change Remote Journal (CHGRMTJRN) command.
- Use the ***ATTACHED** special value for the Starting journal receiver (**STRJRNRCV**) parameter on the **Change Remote Journal (CHGRMTJRN)** command.

Attached receiver on source system only

The replication of journal entries starts with the journal receiver that is currently attached to the journal on the source system.

If the corresponding journal receiver exists and is attached to the remote journal on the target system, journal entries are replicated. Replication starts with the journal entries that follow the last journal entry that currently exists in the attached journal receiver on the target system. Otherwise, if the corresponding journal receiver exists but is not attached to the remote journal on the target system, no journal entries can be replicated. The system returns an error.

If the corresponding journal receiver does not exist on the target system, the journal receiver is created and attached to the remote journal on the target system. Journal entries then are replicated starting with the first journal entry in the journal receiver that is currently attached to the journal on the source system.

If the journal on the source system does not have an attached journal receiver, journal entries cannot be replicated, and the system returns an error. This is only possible in the case of a remote journal that is associated with another remote journal.

To use this option specify one of the following:

- Use the ***SRCSYS** special value for the Starting journal receiver (STRJRNRCV) parameter on the Change Remote Journal (CHGRMTJRN) command.
- **Use attached receiver on source system only** in the **Activate** dialog in System i Navigator.

Qualified journal receiver name

The replication of journal entries starts with the specified journal receiver name for the journal on the source system.

If the corresponding journal receiver exists and is attached to the remote journal on the target system, journal entries are replicated. Replication starts with the journal entries that follow the last journal entry that currently exists in the attached journal receiver on the target system. Otherwise, if the corresponding journal receiver exists but is not attached to the remote journal on the target system, no journal entries can be replicated. The system returns an error.

If the corresponding journal receiver does not exist on the target system, the journal receiver is created and attached to the remote journal on the target system. Journal entries then are replicated starting with the first journal entry in the specified journal receiver.

If the journal on the source system is not associated with the specified journal receiver, no journal entries can be replicated, and an error is returned.

The creation of any receiver on the target system by the change journal state processing is performed as though the receiver was being saved and restored to the target system. Therefore, the ownership of the receiver on a target system will follow the same rules as with the existing save and restore functions. If the user profile which owns the receiver on the source system is on the target system, then that profile will own the created receiver on the target system. If the user profile does not exist on the target system, then the profile QDFTOWN will own the receiver on the target system.

Additionally, information such as the audit attributes, public authority, and primary group of the source journal receiver at the time it was attached to the source journal will be incorporated into the created journal receiver on the target system. If the owner, owner's authority, public authority, primary group, or audit attributes of the source system's receiver are changed, those changes will be propagated to the

target system when the next receiver is attached to the target journal. Changes made to other private authorities of the source system's receiver must be maintained separately on the target system.

If the library for the journal receiver resides in an ASP, the journal receiver will be created in that ASP. The remote journal function does not support nonlibrary ASPs for the ASP of the remote journal receiver.

Related concepts

Journal receiver disk pool considerations

The **receiver configuration** is the disk pool the receiver resides in, and how the data for the receiver is spread across the disk arms within that disk pool.

Factors that affect remote journal performance

There are two main performance objectives for the remote journal function. To provide a timely delivery of journal entries to a target system and to minimize impacts to the journaling throughput on the source system.

Even though both aspects are very important for both synchronous and asynchronous delivery modes, each mode prioritizes the two in a different order. The top priority for synchronous delivery is to guarantee that the remote journal is always up to date with the source journal. For asynchronous delivery mode, the top priority is to minimize impacts to journaling throughput.

All performance considerations that are currently used for a local journal still apply and must continue to be employed. The following are additional factors that may affect the performance of the remote journal function. The factors are listed in the order of importance.

1. Transport method

Your choice of transport depends on the rate of the journal activity in your environment. Make special consideration for using a fast transport method when you use synchronous delivery mode. Weigh the response time impacts of the synchronous delivery mode in your environment against the communications overhead of the transport method you choose.

When replicating journal entries over a long distance, the most important performance factors regarding a communications transport method are the overall rated speed of the communications resource and any existing traffic already using the communications resource.

For more information about transport methods, see the Networking topic.

2. Network problems

Problems in the communication network can result in retransmissions of data, these retransmissions can affect remote journal performance. To see if retransmissions are occurring, use the **Work with TCP/IP Network Status (NETSTAT)** command to check the number of retransmissions. Ideally, you would see no retransmissions.

On the **Work with TCP/IP Network Status** menu, select the appropriate option for your remote journal connections: option 3 for IPV4 connection status, or option 6 for IPV6 connection status. On the **IPV4 connection status** panel, look for local ports with the value "rmtjour >" or 3777 or 3889. They are the remote journal connections. Option 5 displays the connection-specific information. The retransmission information is available on the resulting panels. On the **IPV6 connection status** panel, look for local ports with the value "rmtjo>" or 3888 or 3889. If there are a significant number of retransmissions, or if the count is changing, a communication network problem exists and could affect your remote journal performance.

3. Number of remote journals that are being maintained

With respect to the job performing the journal entry deposit, the impact of the remote journal function for asynchronously maintained journals is not noticeable. For synchronously maintained journals, the impact depends on the slowest connection rather than number of remote journals.

The impact to the job performing the journal entry deposit for an asynchronously maintained journal is significantly less than that for a synchronously maintained journal. Also, it is recommended that only one synchronous remote journal be maintained for a given local journal.

With respect to the system performance impacts, the processor use typically increases by less than an equal factor for each additional remote journal.

4. **Arrival rate of journal entries that are being deposited on the local system**

The higher the arrival rate of journal entries being deposited on the local system, the greater the chance journaling throughput will increase for synchronous or asynchronous delivery. A high arrival rate might cause asynchronous journaling to fall further behind.

5. **Batch versus interactive**

In general, higher local and remote journal throughput can be maintained when many interactive jobs generate the journal throughput rather than a single-threaded batch job. Journal caching can also increase this throughput for batch processing regardless of the number of jobs.

6. **Processor utilization on the source system**

The higher the processor utilization of the source system, the greater the chance of affecting journaling throughput for synchronous or asynchronous delivery. This may cause asynchronous journaling to fall further behind.

7. **Processor utilization on the target system**

The higher the processor utilization of the target system, the greater the chance of affecting journaling throughput for synchronous or asynchronous delivery. This may cause asynchronous journaling to fall further behind.

8. **The value set for the sending task priority when using the asynchronous delivery mode**

The larger the value, the smaller effect the remote journal function will have on the system, but the further the target system may lag behind the source system.

Performance considerations regarding the catch-up phase

Performance considerations regarding the catch-up phase when activating the remote journal function include the following in order of importance:

1. **Total number of bytes for all of the journal entries that need to be caught up**

The larger the total size, the longer the catch-up phase will run.

2. **Transport method**

Select a transport method that is appropriate for your remote journaling environment.

3. **Disk protection on the target system**

At high data transfer rates, disk units with device parity protection in the ASP on the target system can limit the performance of the catch-up phase, unless the target system has sufficient write cache configured in the I/O adaptors servicing the disk units that house the journal receiver. One example of this is when you use the OptiConnect for IBM i bus transport method. Having mirrored or unprotected disk units in the ASP on the target system would eliminate this effect.

4. **Processor utilization on the source system**

The higher the processor utilization of the source system, the greater the chance of affecting the performance for the catch-up phase.

5. **Processor utilization on the target system**

The higher the processor utilization of the target system, the greater the chance of affecting the performance for the catch-up phase.

6. **Delivery mode**

The performance of the catch-up phase does **not** depend on the delivery mode that was specified, synchronous or asynchronous.

Note: The catch-up processing that is performed by the remote journal function is the most efficient method of replicating the journal entries with the remote journal function.

How the journal attributes affect the remote journal performance

Reducing the size of the journal receivers on the source system will reduce the communications overhead of the remote journal function. Therefore, you may want to consider journaling *AFTER images and not journaling open, close, or force entries.

Some of the most common attributes you may want to use for auditing journal entries are the following:

- Maximum receiver size - RCVSIZOPT(*MAXOPT1, *MAXOPT2, or *MAXOPT3)
- Remove internal entries - RCVSIZOPT(*RMVINTENT)
- Minimized entry specific data - MINENTDTA(*FILE) or *FLDBDY

Attributes such as the FIXLENDTA can also cause minimal performance improvements.

Refer to the Remote journal attributes and Remote journals and auxiliary storage links below for more details about remote journal performance.

Related concepts

Journal management and system performance

Journal management prevents transactions from being lost if your system ends abnormally or has to be recovered. Journal management writes changes to journaled objects immediately to the journal receiver in auxiliary storage. Journaling increases the disk activity on your system and can have a noticeable affect on system performance.

Methods to reduce the storage that journal receivers use

Reduce the size of journal entries by methods such as journaling after-images only, or specifying certain journaling options including the Fixed Length Data (FIXLENDTA) option on the **Create Journal (CRTJRN)** and **Change Journal (CHGJRN)** commands.

Remote journal attributes

When a remote journal is created by the add remote journal processing, the remote journal's initial attributes are defined by the add request and the source journal.

Remote journals and auxiliary storage

Auxiliary storage will be required on both the source and target systems. The amount that is required will be about the same on both systems unless remote journal filtering is used. If remote journal filtering is used then the amount of storage used on the target system may be less than the storage required on the source system. The storage reduction depends on how many journal entries meet the filter criteria and are actually not sent to the target system.

Related information

Networking

Remote journals and auxiliary storage

Auxiliary storage will be required on both the source and target systems. The amount that is required will be about the same on both systems unless remote journal filtering is used. If remote journal filtering is used then the amount of storage used on the target system may be less than the storage required on the source system. The storage reduction depends on how many journal entries meet the filter criteria and are actually not sent to the target system.

Anything that is done to minimize the amount of auxiliary storage required on the source system will reduce the amount of auxiliary storage required on the target system. Additionally, the less auxiliary storage used, or smaller the journal receivers are, the less data is transmitted on the communications links. Therefore, the communications overhead will be reduced.

If the target system is not working for any extended period of time, enough auxiliary storage on the source system is needed to keep the journal receivers online. This will be required until the target system becomes available at which time the journal receivers can be replicated to the target and deleted from the source.

See Methods to reduce the storage that journal receivers use for more information about ways to reduce the auxiliary storage usage.

Related concepts

[Methods to reduce the storage that journal receivers use](#)

Reduce the size of journal entries by methods such as journaling after-images only, or specifying certain journaling options including the Fixed Length Data (FIXLENDTA) option on the **Create Journal (CRTJRN)** and **Change Journal (CHGJRN)** commands.

Journal receiver disk pool considerations

The **receiver configuration** is the disk pool the receiver resides in, and how the data for the receiver is spread across the disk arms within that disk pool.

A remote journal receiver has the same receiver configuration as its corresponding source receiver. When possible, the remote journal receiver is configured to use the same number of disk units as the source journal receiver. The remote journal receiver might be in a disk pool that has fewer disk units than the disk pool that contains the journal receiver on the source system. If this imbalance occurs, the remote journal receiver is configured to use the available disk units in the pool.

Note: If the remote journal receiver is in a disk pool with fewer disk arms than the source journal receiver, then performance may be impacted. Therefore, we recommend that the number of disk arms is the same on the source and remote journal receivers disk pools.

Likewise, the journal receiver on the source system may be in a disk pool that has fewer disk units than the disk pool that contains the remote journal receiver. If this occurs, the remote journal receiver will not take advantage of all possible disk units on the target system.

Independent disk pool considerations

The following considerations apply if the remote journal receiver is on an independent disk pool:

- If the local system has the journaling environment in a basic, system disk pool, or independent disk pool, the remote journal can be in an independent disk pool. Likewise, if the local system has the journaling environment in an independent disk pool, the remote journal can be in a basic, system disk pool, or independent disk pool.
- The independent disk pool on the remote system must be varied on.
- The independent disk pool must be a library capable independent disk pool.
- The remote journal and remote journal receiver must be in the same disk pool group.

Determine the type of disk pool in which to place journal receivers has more information about journal receivers and disk pools. The Independent disk pools topic has detailed information about independent disk pools.

Related concepts

[Determining the type of disk pool in which to place journal receivers](#)

Use disk pools (auxiliary storage pool) to control which objects are allocated to which groups of disk units. If you are journaling many active objects to the same journal, the journal receiver can become a performance bottleneck. One way to minimize the performance impact of journaling is to put the journal receiver in a separate disk pool. This also provides additional protection because your objects are on different disk units from the journal receiver, which contains a copy of changes to the objects.

[Independent disk pools](#)

Remote journals and main storage

Providing greater amounts of main storage in the *BASE main storage pool on the source system might improve remote journal performance. Improvements are most likely in environments with one or more asynchronously maintained remote journals.

Providing greater amounts of main storage in the *BASE main storage pool on the target system will improve remote journal performance. This is especially true in a remote journal network with a high volume of activity. The additional storage will keep the number of page faults to a minimum, and reduce the impacts to the target system.

Setting up remote journals

You can establish and maintain one remote journal that is associated with one local journal.

If you want to make a more complicated broadcast or cascade configuration, use the following steps for each of the remote journals in the configuration.

Preparing to use remote journals

This topic outlines the basic steps for preparing to use remote journals.

Before establishing the remote journal environment, complete the following steps:

1. Determine the extent of your remote journal network or environment.

See [Plan for remote journals](#).

2. Determine what **library redirection**, if any, you will be using for the remote journals and associated journal receivers. Library redirection is the ability to allow the remote journal and associated journal receivers to reside in different libraries on the target system from the corresponding source journal and its associated journal receivers.

See [Library redirection with remote journals](#).

3. Ensure that all selected libraries exist on the target systems. You will need to consider whether or not library redirection will be used when adding the remote journal.
4. Create the appropriate local journal if it does not already exist.

See [Set up journaling](#) for more information about creating local journals.

5. Configure and activate the communications protocol you have chosen to use.

See the [Supported communications protocols for remote journals](#) link below for more information.

After you have configured the communications protocol, it must be active while you are using the remote journal function. For example, if you are using the OptiConnect for IBM i bus transport method, then the OptiConnect for IBM i subsystem, QSOC, must be active. QSOC must be active for both the source system and the target system, and the appropriate controllers and devices must be varied on. If you are using a SNA communications transport, vary on the appropriate line, controller, and devices and ensure subsystem QCMN is active on both systems. If you are using TCP/IP or Sockets IPv6, you must start TCP/IP by using the Start TCP/IP (STRTCP) command, including the distributed data management (DDM) servers. If you are using data port, you must configure a cluster, make sure that the cluster is active, and start the internet Daemon (INETD) server using the Start TCP/IP Server (STRTCPSVR) command.

See the [Networking](#) topic and [OptiConnect for IBM i](#) for more detailed information.

6. If one does not already exist, create the appropriate relational database (RDB) directory entry that will be used to define the communications protocol for the remote journal environment. When TCP communications are being used to connect to an independent disk pool, the Relational Database (RDB) entry to the independent disk pool must have the Relational database value set to the target system's local RDB entry and the relational database alias value set to the independent disk pool's name.

Related concepts

[Planning for remote journals](#)

This topic provide information for planning to set up remote journals.

[Library redirection with remote journals](#)

Library redirection provides a means for remote journals and any of their associated journal receivers to optionally reside in differently named libraries on the target system from the corresponding local journal and journal receivers on the local system.

[Supported communications protocols for remote journals](#)

The remote journal function supports the following communications protocols for replicating the journal entries to the remote systems:

Related tasks

[Setting up journaling](#)

This topic provides instructions on how to set up journals and journal receivers.

Related information

[Networking](#)

[OptiConnect for i5/OS](#)

Adding remote journals

This topic provides instructions for adding a remote journal.

The following is the input that you must provide to add a remote journal to a source journal:

- The journal name and library on the source system to which the remote journal is being added.
- The remote journal name and library on the target system that is being added.
- A relational database directory entry, which identifies the target system and other necessary communications information.
- The type of remote journal to be added.
- Optionally, the journal or journal receiver library redirection.
- Optionally, the values for the journal message queue, text, delete receivers, and delete receiver delay attributes to be applied to any newly created remote journal.
- Optionally, the filtering criteria to be used.

If a different target journal library or remote receiver library is specified, then those libraries will be used to hold the remote journal and receivers on the target system. This is what is referred to as library redirection.

To add a remote journal, take the following steps:

1. Using IBM Navigator for i connect to the system you want to use.
2. Expand **Journal Management**.
3. Select **Set Database/Library to use with Journal Tasks** and specify the database and library you want to use.
4. Select **Journals**.
5. Select the journal you want to add a remote journal to and select the **Add remote journal** action.

Alternatively, you can use the Add Remote Journal (ADDRMTJRN) Command or the Add Remote Journal (QjoAddRemoteJournal) API to add a remote journal.

The remote journal does not have an attached journal receiver after the add remote journal processing completes. In addition, the journal state for the remote journal is set to *INACTIVE. A journal state of *INACTIVE means that the remote journal is not ready to receive any journal entries from the journal on the source system. During this time, journal entries can continue to be deposited or replicated into the journal on the source system. However, no entries are replicated to the newly added remote journal until you activate that remote journal. Refer to [Activate the replication of journal entries to a remote journal](#) for information about activating a remote journal.

Related tasks

[Activating the replication of journal entries to a remote journal](#)

In order to activate the replication of journal entries to a given remote journal, the following must be true:

Related reference

[Add Remote Journal \(ADDRMTJRN\) command](#)

[Add Remote Journal \(QjoAddRemoteJournal\) API](#)

Removing remote journals

You must be aware whether library redirection is in effect for the remote journal when you remove a remote journal. If it is in effect, any library name processing will substitute the redirected library name for the library name that is used for the operation on the target system.

You can also use one of the following to remove a remote journal:

- IBM Navigator for i
- System i Navigator
- Remove Remote Journal (QjoRemoveRemoteJournal) API
- Remove Remote Journal (RMVRMTJRN) command

You must start Navigator for i, System i Navigator, the QjoRemoveRemoteJournal API, or the RMVRMTJRN command on the source system for the journal on the source system identifying which remote journal to remove.

When using any of these methods, the replication of journal entries to the remote journal to be removed cannot be currently active. If the remote journal state is *ACTIVE, you must inactivate the replication of journal entries to the remote journal.

The remote journal, and any associated journal receivers, are not deleted from the target system when you remove a remote journal. Removing a remote journal does not initiate any processing on the target system. Once the remote journal is removed from the journal on the source system, you are responsible for deleting the remote journal and associated journal receivers, if desired.

You can add this remote journal back to the remote journal function definition for the journal on the source system.

Once a remote journal is removed, the journal receivers are no longer protected from deletion.

The following is the input that you must provide to remove a remote journal on a target system:

- The journal name and library on the source system from which the remote journal is being removed.
- The remote journal name and library on the target system that is being removed.
- A relational database directory entry, which identifies the target system and other necessary communications information.

To disassociate a remote journal on a target system from a journal on a source system with Navigator for i, do the following steps:

1. Using Navigator for i connect to the system you want to use.
2. Expand **Journal Management**.
3. Select **Set Database/Library to use with Journal Tasks** and specify the database and library you want to use.
4. Select **Journals**.
5. Select the journal from which you want to remove a remote journal and select the **Remote journals** action.
6. On the **Remote journals** list, select the remote journal to remove and select the **Remove** action.
7. On the **Remove remote journal** dialog, click **OK**.

Related tasks

[Inactivating the replication of journal entries to a remote journal](#)

When you end replication of journal entries to a remote journal, it is recommended that the replication of entries be ended from the source system whenever possible, rather than from the target system. Usually, ending replication from the target system for a remote journal is only necessary when the source system has failed, and the system has not ended the remote journal function.

[Adding remote journals](#)

This topic provides instructions for adding a remote journal.

Related reference

[Remove Remote Journal \(QjoRemoveRemoteJournal\) API](#)

[Remove Remote Journal \(RMVRMTJRN\) command](#)

Activating and inactivating remote journals

Activating a remote journal means starting and then maintaining the replication of journal entries from a source journal to a remote journal. Activating a remote journal always occurs from the source system.

Inactivating a remote journal means ending the replication of journal entries from the source journal to the remote journal. Inactivating a remote journal can be performed from the source or target systems. However, the preferred method is to inactivate from the source system.

If this is the first time the remote journal is being activated, activating a remote journal creates one or more journal receivers on the target system. Activating the remote journal also establishes the connection between the source and remote journal so that journal entry replication can begin.

If the remote journal has previously been activated, the system may or may not create additional receivers on the target system. This would occur prior to establishing the connection between the source and remote journal so that journal entry replication can resume.

You must be aware if library redirection is in effect for the remote journal when you activate or inactivate a remote journal. If it is in effect, any library name processing will substitute the redirected library name for the library name that is used for the operation on the target system.

Activating the replication of journal entries to a remote journal

In order to activate the replication of journal entries to a given remote journal, the following must be true:

- The remote journal that you wish to activate must not have a journal state of *ACTIVE. For instance, this might seem to be a reasonable request if you wanted to simply change the delivery mode from synchronous to asynchronous. However, the remote journal must be inactive before you can activate it.
- The remote journal that you wish to activate must not be actively replicating journal entries to other remote journals, as in a cascade configuration. You must inactivate the remote journals that are immediately downstream before activating the remote journal.

You need to provide the following input in order to activate the replication of journal entries to a remote journal on a target system:

- The journal name and library on the source system from which journal entries will be replicated.
- The remote journal name and library on the target system to which journal entries will be replicated.
- A relational database directory entry, which identifies the target system and other necessary communications information.
- The delivery mode to be used. Specify either synchronous or asynchronous delivery mode.
- The journal receiver from which to start journal entry replication which defines the starting point for journal entry replication.
- If an asynchronous delivery mode was specified, then the **sending task priority** may also be specified. If a value is not specified, the system selects a default priority, which is higher than what the user can specify for this value. Setting this value too large may cause a greater journal entry latency or lag.
- If synchronous delivery mode was specified, then a synchronous sending time-out value may be specified. If a value is not specified, then the system uses 60 seconds.
- Optionally, if validity checking should be enabled.
- Optionally, if the remote journal should try to automatically restart if the connection ends.
- Optionally, remote journal filtering criteria to be used for the remote journal.

To activate the remote journal, proceed as follows:

1. With IBM Navigator for i connect to the system you want to use.
2. Expand **Journal Management**.
3. Select **Set Database/Library to use with Journal Tasks** and specify the database and library that contains the journal.
4. Select **Journals**.
5. Select the journal, and select the **Remote journals** action.
6. On the **Remote journals** list, select the remote journal from the list of remote journals, and then select the **Activate** action to activate the selected remote journal.

You can also activate the replication of journal entries from a journal on a source system to a remote journal on a target system by using one of the following methods:

- The Change Journal State (QjoChangeJournalState) API
- The Change Remote Journal (CHGRMTJRN) command

Both the QjoChangeJournalState API and the CHGRMTJRN command must be issued from the source system.

The activation of the remote journal can be a long running process. This may occur if there are a large number of journal receivers and entries that initially must be caught-up in the remote journal.

Catch-up phase for remote journals has more detailed information about the catch-up phase.

For additional insight into activating remote journals see IBM Redbooks technote [Journaling - Common](#)

[Remote Journal Questions](#) 

Related concepts

[Synchronous and asynchronous delivery mode for remote journals](#)

The terms **asynchronously maintained** and **synchronously maintained** both describe a remote journal function delivery mode for journal entry replication.

[Where the replication of journal entries start](#)

When you specify a journal receiver for remote journaling, you are specifying where the replication of journal entries will start.

Related reference

[Change Journal State \(QjoChangeJournalState\) API](#)

[Change Remote Journal \(CHGRMTJRN\) command](#)

Catch-up phase for remote journals

Catch-up refers to the process of replicating journal entries that existed in the journal receivers of the source journal before the remote journal was activated.

The catch-up phase is the most efficient method of replicating journal entries to a remote journal. Control does not return to the requester of the activation of the remote journal until this catch-up processing has completed. You will want to consider this when deciding the starting point for journal entry replication.

Catch-up phase is initiated after the following actions occur:

- A request has been issued on the source system to activate a remote journal.
- The system has determined which journal receivers and journal entries to replicate to the target system.

There is a difference between the catch-up phase processing and the run-time synchronous or asynchronous processing. Catch-up processing replicates the following to the target system:

- Those journal entries that already exist in the journal on the source system.
- Those journal entries that are deposited or replicated to the source journal during the catch-up processing.

Run-time synchronous or asynchronous processing occurs as part of the actual deposit or replication of journal entries into the currently attached receiver on the source system. While in the catch-up phase,

the journal delivery mode will be either asynchronous pending (*ASYNCPEND) or synchronous pending (*SYNCPEND), depending on the delivery mode that was specified.

The catch-up phase is the most efficient method of transporting journal entries to a remote journal in bulk.

The following is a high-level overview of the catch-up phase and related processing:

1. The starting point in the journal receiver on the source system is determined.
2. If necessary, the system creates a receiver on the target system and attaches it to the remote journal.
3. The system replicates or completes replication for all of the journal entries that are contained in the receiver on the source system to the corresponding receiver on the target system.
4. If the receiver on the source system is the currently attached receiver, the system completes the catch-up processing by transitioning into synchronous or asynchronous remote journal delivery mode. Catch-up phase is complete, and control returns to the requester of the remote journal activation.

The remote journal will now be maintained synchronously or asynchronously as additional journal entries are deposited, or replicated, into the attached receiver on the source system.

5. If the receiver on the source system is not the currently attached receiver for the journal on the source system, one of the following steps are performed:
 - If there is a next receiver within the source journal's chain of receivers, go back to step 2. The system replicates journal entries by starting with the first entry in the next receiver.
 - If there is no next receiver, (which indicates that a receiver chain break exists), the catch-up phase is complete. Processing does not transition into synchronous or asynchronous mode and the change journal state processing ends. A final escape message is sent indicating that processing has ended.

After the system transitions a given remote journal to either the synchronous or asynchronous remote journal delivery mode, the system continues to maintain that mode. This continues until the remote journal function is inactivated for that remote journal by using the Change Journal State (QjoChangeJournalState) API or Change Remote Journal (CHGRMTJRN) command, or a failure occurs.

The replication of journal entries to an individual remote journal is performed independently from the replication of journal entries to any other defined remote journal. This is important if a given target system fails or if communications to a target system fails from a particular source system. If either one occurs, the remote journal function will end to those affected remote journals that reside on that target system and are maintained from the source system. All other remote journals that are being maintained from the source system will continue to function normally. For example, a source journal could have two remote journals on two different systems. In this situation, if the replication of entries from the source journal to the second remote journal ended, the replication of entries from the source journal to the first remote journal would not necessarily end. If a given remote journal has any type of failure, the system ends the remote journal function. Appropriate messages are signaled to either system or both systems involved, but the remote journal function for other remote journals would not be affected. Likewise, the communications line speed for a given asynchronously maintained remote journal will not affect the speed for another asynchronously maintained remote journal using a different physical transport.

Related concepts

Where the replication of journal entries start

When you specify a journal receiver for remote journaling, you are specifying where the replication of journal entries will start.

Journal receiver chains

Journal receivers that are associated with a journal (that is presently or previously attached to the journal) are linked in one or more **receiver chains**. Each journal receiver, except the first one, has a previous receiver that was detached when the current receiver was attached. Each journal receiver, except the one that is currently attached, also has a next receiver.

Working with remote journal error messages

Several different error conditions can occur when the remote journal function is active.

Related tasks

Inactivating the replication of journal entries to a remote journal

When you end replication of journal entries to a remote journal, it is recommended that the replication of entries be ended from the source system whenever possible, rather than from the target system. Usually, ending replication from the target system for a remote journal is only necessary when the source system has failed, and the system has not ended the remote journal function.

Relational database considerations for remote journal state

Once a remote journal is activated, the remote journal function will work with the communications configuration defined by the specified relational database (RDB) entry as long as the remote journal is active. However, the information will be taken from the RDB at the point in time when the remote journal was activated. Therefore, even if the definition of the RDB entry is changed while a remote journal has a journal state of *ACTIVE, none of those changes will take effect immediately.

If the remote journal is inactivated, and then activated again, the new RDB entry definition will take effect. When you view the remote journal information, the RDB entry information that is displayed represents the state of the RDB entry information when the remote journal was last activated.

Related tasks

Displaying remote journal function information

When you are working with the remote journal function, you will want to be able to view the remote journal network. You may also want to view the various attributes, journal states, or delivery modes. The status of the remote journal environment is also available to display.

Automatically restarting remote journal

Remote journaling is dependent on communications networks staying active. But, the reality is that remote journal connections can be dropped for various reasons. To help limit the effect of communications outages, remote journaling has an automatic restart capability. This restart capability is indicated when activating remote journaling.

During the activation of a remote journal connection, you can choose to use the automatic restart capability or not. When you choose to use the automatic restart capability, you specify the number of restart attempts to be made, and the amount of time to wait between each restart attempt.

When remote journaling ends for a recoverable error, a job is started in the QSYSWRK subsystem for the restart attempts. If the first attempt to restart fails, message CPI7027 is sent to QSYSOPR indicating when the next restart attempt will be made. If all restart attempts fail, or one of them fails for an unrecoverable error then message CPI7028 is sent.

These are the recoverable errors that will trigger an automatic restart:

These reason codes for message CPF70D5 (Remote journal environment ended for journal) indicate a recoverable error that will trigger an automatic restart:

- 4 - Communication line error or target system error.**
- 5 - Target system error.**
- 7 - Storage limit exceeded for system, user or group profile.**
- 11 - Time out waiting for a response from the target system.**
- 12 - Asynchronous remote journaling could not keep up.**
- 21 - Source system could not detect the target system.**
- 28 - Communication validity check failed.**

These reason codes for message CPF70C5 (Remote journal environment ended for journal) indicate a recoverable error that will trigger an automatic restart:

- 48 - Data port services error.**
- 49 - Node identifier &11 is unavailable for data port services.**
- 50 - Connections down for data port services.**
- 52 - Destination internet address unreachable for data port services.**
- 53 - Hardware error for data port services.**
- 54 - Insufficient memory to perform data port services request.**
- 55 - Client closed for data port services.**

Inactivating the replication of journal entries to a remote journal

When you end replication of journal entries to a remote journal, it is recommended that the replication of entries be ended from the source system whenever possible, rather than from the target system. Usually, ending replication from the target system for a remote journal is only necessary when the source system has failed, and the system has not ended the remote journal function.

If you are inactivating an asynchronously maintained remote journal, you can request that the remote journal function be ended immediately or in a controlled fashion. For an immediate end, any journal entries which have already been queued for replication will not be sent to the remote journal. For a controlled end, any journal entries which have already been queued for replication will be sent to the remote journal. When all queued entries have been sent to the target system, the system sends message CPF70D3 to the journal message queue. The message indicates that the remote journal function has been ended. If you are inactivating a synchronously maintained journal, the remote journal function is ended immediately, regardless of whether an immediate or controlled end was requested. Similarly, if the remote journal is in the catch-up phase of processing, the remote journal function is ended immediately. This is also regardless of whether an immediate or controlled end was requested.

To inactivate the replication of journal entries proceed as follows:

1. With IBM Navigator for i connect to the system you want to use.
2. Expand **Journal Management**.
3. Select **Set Database/Library to use with Journal Tasks** and specify the database and library that contains the journal.
4. Select **Journals**.
5. Select the journal, and select the **Remote Journals** action.
6. On the **Remote Journals** list, select the remote journal in the list of remote journals, and then select the **Deactivate** action to inactivate the selected remote journal.
7. Click OK on the **Deactivate** dialog.

You can also use the Change Journal State (QjoChangeJournalState) API and Change Remote Journal (CHGRMTJRN) command to inactivate the replication of journal entries to a remote journal. For this purpose, the API can be initiated from either the source system or the target system. The CHGRMTJRN command can only be initiated from the source system. You can also use the Change Journal (CHGJRN) command on the target system to inactivate the remote journal.

Related reference

[Change Journal State \(QjoChangeJournalState\) API](#)

[Change Remote Journal \(CHGRMTJRN\) command](#)

[Change Journal \(CHGJRN\) command](#)

Managing remote journals

Managing the remote journal function requires basic tasks such as:

- Keeping records of your remote journal network.
- Evaluating the impact on the remote journal network as new applications are added or the system workload grows.
- Considering the ramifications of journal receivers on two systems which require regular save and delete processing.
- Considering the save and restore implications of the remote journal network.

The following information describes the management tasks for remote journals:

Keeping records of your remote journal network

Always have a current list of the remote journals that are associated with local journals, and their associated communications information.

For each journal which has remote journals associated with it, use the following command: `WRKJRNA JRN(library-name/journal-name) OUTPUT(*PRINT)`.

To get only the remote journal information of a journal, use `WRKJNA` with `DETAIL(*RMTJRN)` as an added parameter.

Alternatively, you can use the Retrieve Journal Information (`QjoRetrieveJournalInformation`) API to retrieve the information and place it in a file.

To get the related relational database information, use the following command: `WRKRDBDIRE RDB(*ALL) OUTPUT(*PRINT)`.

Remember to do this for all cascaded remote journals as well, not just the local (or primary) system.

Related reference

[Retrieve Journal Information \(`QjoRetrieveJournalInformation`\) API](#)

Displaying remote journal function information

When you are working with the remote journal function, you will want to be able to view the remote journal network. You may also want to view the various attributes, journal states, or delivery modes. The status of the remote journal environment is also available to display.

To View the remote journal details from the source side, proceed as follows:

1. With IBM Navigator for i, connect to the system that contains the local journal.
2. Expand **Journal Management**.
3. Select **Set Database/Library to use with Journal Tasks** and specify the database and library that contains the local journal.
4. Select **Journals**.
5. Select the journal, and then select the **Remote Journals** action.
6. On the **Remote Journals** list, select the remote journal, and then select the **Properties** action to view the details about the remote journal connection

To view the remote journal details from the target side, proceed as follows:

1. With Navigator for i, connect to the system that contains the remote journal.
2. Expand **Journal Management**.
3. Select **Set Database/Library to use with Journal Tasks** and specify the database and library that contains the remote journal.
4. Select **Journals**.
5. Select the remote journal, and select the **Properties** action.

The **Work with Journal Attributes (`WRKJRNA`)** command display includes the list of all remote journals that are associated with a given journal. When looking at a specific journal, you can see information about the journal's source journal, if any. Additionally, you can see all remote journals which are immediately downstream from the specified journal. If those remote journals are cascaded to other remote journals, you will not be able to see any cascaded remote journal information. To see that information, you must invoke the **WRKJRNA** command for that remote journal on its own system. This information is also available through the Retrieve Journal Information (`QjoRetrieveJournalInformation`) API.

The remote journal information available with these interfaces includes latency information. From the source side, you can see how far the source system is behind in sending entries in an asynchronous remote journal environment. You can also see when remote journal was last activated and any filtering

criteria being used. From the target side, you can see when remote journal was last activated, an estimate of how many seconds behind the target system is, and any filtering criteria that is being used.

Additionally, the **Display Journal Receiver Attributes (DSPJRNRCVA)** command display provides additional information about the remote journal characteristics of the journal receivers. The **DSPJRNRCVA** command also has an API counterpart to allow program retrieval of the journal receiver information, the **Retrieve Journal Receiver Information (QjorTvjrnReceiverInformation)** API. The IBM Navigator for i equivalent information is available by selecting the **Properties** action for a journal receiver.

Evaluating how system changes affect your remote journal network

After you have initially established your remote journal network, you need to keep up with changes that occur on the system.

If the amount of work that is going to the journals which you are replicating increases, you may need to consider upgrading the communications method.

The traffic rate for work other than the remote journal function may increase on a communications method that is shared. If this occurs, you may need to consider separating the various pieces of communications traffic so that the remote journal function is not impaired. This is especially important if you are using the synchronous delivery mode.

An application that is being protected may become more critical to your business, where any time that the system is not working is considered disastrous. If this occurs, you may need to consider upgrading that application's remote journal to using the synchronous delivery mode so that no journal entries are lost.

Getting information about remote journal entries

Working with the journal entries in a remote journal is essentially the same as working with the journal entries in a local journal. But there are exceptions.

Note: The system name, date, and time stamp in the journal entries are based on the original local journal. They are not based on the system of the remote journal where the entries are viewed.

Related concepts

[Working with journal entry information](#)

This topic provides ways that you can display, retrieve, and receive journal entries.

Related tasks

[Displaying information for journaled objects, journals, and receivers](#)

IBM Navigator for i, Control Language commands, and APIs provide several ways for you to display information about journaled objects, journals, and journal receivers.

File identifier considerations for working with integrated file system entries

If you plan to replay the integrated file system operations in the remote journal to objects on the target system, and if you primed that target system with objects that were restored from the source system, then some additional considerations apply to replaying those journal entries.

Integrated file system journal entries on remote journals are only identified by the file identifier in the object name field. They are not identified by path name. When you restore an integrated file system object on a remote system, the remote system does not maintain the same file identifier that was used on the source system. It assigns that object a new file ID. However, the journal entries in the remote journal receiver refer to that object's original file ID. Therefore when you replay the journal entries you cannot use the file ID on the remote journal to find the path of the object. That file ID will either not exist or be the file ID for the wrong object.

To prevent potential problems, it is recommended that you create a table that maps the old and new file IDs with the object's path. The map can be something like the following table:

| Object path | Source file ID | Target file ID |
|------------------------------|----------------|----------------|
| /myFolder/subFolder/MyObject | 123456... | 789123... |

| Object path | Source file ID | Target file ID |
|---------------------------------------|----------------|----------------|
| /myNextFolder/anotherFolder/MyObject2 | 654321... | 321987... |

Collecting the information for mapping file IDs

You can use different methods to determine the file IDs:

- Use local journaling on the target system where you restore the object.
- Use the object's path to find its file ID with the Get Attributes (Qp0lGetAttr()) API on the source system.
- Use the object's file ID to find its path with the Get Path Name of Object from Its File ID (Qp0lGetPathFromFileID()) API on the source system.

Using local journaling on the target system

If an object is journaled when you restore it to the target system, a B FR journal entry is deposited on the target system's local journal receiver. The entry-specific data of the B FR journal entry contains the following:

- Media file identifier--the file ID of the object on the media. This file ID is the same as the object's file ID on the source system.
- Restored file identifier--the object's new file ID after it is restored to the target system.
- Restored over file identifier--the file ID of the object that was restored over.

If you are concerned about the demand that journaling puts on the remote system's resources and storage space, you can put the journal in *STANDBY state. Even though the journal is in standby state, the system still deposits B FR entries.

Using the object's path to find its file ID with the Qp0lGetAttr() API

On the source side, if you know the object's path but do not know its file ID, you can use the Qp0lGetAttr() API to get the file ID. This is especially helpful if you do not want to use journaling on the remote system. You then need to send that information over to the target system to update the table which must exist on the target system.

Using the object's file ID to find its path with the Qp0lGetPathFromFileID() API

On the source side, if you know the object's file ID, but do not know its path, you can find it using the Qp0lGetPathFromFileID() API. You can then use this path to replay the journal entries on the target system, assuming that the path on the target system is the same as the path on the source system. This API will only return an absolute path name of the object. If the object has more than one path name, the API only returns one path. You then need to send that information over to the target system to build the table which must exist on the target system.

Maintaining the table as the replicator job applies journal entries

Once you have the table created, you must keep it updated. One way to keep the table updated is to update the table as the replicator job applies journal entries. On the target system, when the replicator job applies entries to do operations such as creating objects, adding links, or removing links, the journal entry information in these entries has the path name and file ID in it at that time. As the operation is replayed you can use this information to build the table on the target system.

Related concepts

[Layouts for variable-length portion of journal entries](#)

The following tables contain the variable-length portion of the layouts for journal entries.

Related tasks

[Changing the state of local journals](#)

Local journals can be in one of two states, active or standby. When the journal state of a local journal is active, journal entries are allowed to be deposited to the journal receiver.

Related reference

[Get Attributes \(Qp0lGetAttr\(\)\) API](#)

[Get Path Name of Object from Its File ID \(Qp0lGetPathFromFileID\(\)\) API](#)

Confirmed and unconfirmed journal entries

For a local journal, all entries are confirmed entries. There is no concept of unconfirmed entries.

For a remote journal that is maintained asynchronously, all entries are confirmed entries. For a remote journal that is maintained synchronously, there are both confirmed and unconfirmed entries. Unconfirmed entries will only become important if you are using the remote journal support for a hot-backup or data replication environment, and the source system has a failure such that the target system will take over processing.

Confirmed journal entries are journal entries replicated to a target system, and the state of the I/O to auxiliary storage for the same journal entries on the primary system is known to have completed.

Unconfirmed journal entries are entries replicated to a target system, but the state of the I/O to auxiliary storage for the same journal entries on the primary system is not known. Unconfirmed entries only pertain to remote journals that are maintained synchronously. The remote I/O to the remote journal is overlapped with the local I/O to the local journal for better performance. Such journal entries on the target system are held in the data portion of the journal receiver. However, the journal entries are not officially included with the remainder of the journal entries until the confirmation of the I/O for the same entries is received from the primary system. For performance reasons, confirmation of these entries is not typically sent to the target system until some later delivery of journal data to the target system.

While the journal entries are unconfirmed on a target system, the entries typically cannot be retrieved from the remote journal. You can retrieve the journal entries by using the INCENT(*ALL) parameter on the following commands:

- Display Journal (DSPJRN)
- Retrieve Journal Entry (RTVJRNE)
- Receive Journal Entry (RCVJRNE)

You can also retrieve the journal entries by specifying *ALL for the include entries key for the Retrieve Journal Entries (QjoRetrieveJournalEntries) API. The INCENT(*ALL) parameter, or include entries key specification of *ALL, requests that all confirmed and unconfirmed entries are included. This means that for synchronous remote journal function, the last few journal entries are not immediately retrievable from the remote journal by using the default command invocations. This is true even though all journal entries physically reside in both the local journal and the remote journal. This is done so that application programs do not make decisions on the target system by using journal entries that may not end up being deposited into the local journal. This is because those journal entries would not cause a change to the original data.

With respect to a hot-backup application apply, in most circumstances only the confirmed journal entries in the remote journal are of interest. In the data replication environment, a hot-backup application apply would probably never want to apply any unconfirmed journal changes. This is because any subsequent activation of the remote journal will ensure that the journal entries in the remote journal will match the journal entries in the source journal. However, as described in Scenario: Recovery for remote journaling, knowledge of the unconfirmed journal entries is essential during the switch-over and switch-back processing for a hot-backup environment.

When a remote journal is inactivated, all unconfirmed entries are removed from the remote journal. It is important that those entries are retrieved prior to the remote journal being inactivated, if those entries are desired for additional processing on the backup system. The message that is sent to the journal message queue when the remote journal is inactivated by the system will indicate if the remote journal has any unconfirmed journal entries.

Related concepts

[Synchronous and asynchronous delivery mode for remote journals](#)

The terms **asynchronously maintained** and **synchronously maintained** both describe a remote journal function delivery mode for journal entry replication.

[Working with remote journal error messages](#)

Several different error conditions can occur when the remote journal function is active.

Related reference

[Retrieve Journal Entries \(QjoRetrieveJournalEntries\) API](#)

Related information

[Scenario: Recovery for remote journaling](#)

This scenario describes a hot-backup environment in which the local system, JKLINT fails. It is necessary to restore the local system, and synchronize it with the remote system, JKLINT2.

Journal entries from a remote journal with library redirection

All journal entries that are retrieved from a remote journal will have the object names as they exist on the local system.

The following journal entries will show the name of the journal receiver as it was on the local system even if the entry is displayed on a remote system. This is because these entries really apply to the version of the journal receiver that existed on the local system.

- J PR - Previous Receiver entry
- J NR - Next Receiver entry
- J RD - Receiver Deleted
- J RR - Receiver Restored
- J RS - Receiver Saved
- J RF - Receiver Saved with storage Freed
- Object saved entries - See the Journal entry information finder for a list of the possible entry types.
- Journal changes applied entries - See the Journal code finder for a list of the possible entry types.
- Journal changes removed entries - See the Journal code finder for a list of the possible entry types.

Related information

[Journal entry information finder](#)

Retrieving journal entries from a remote journal during the catch-up phase

During the catch-up phase, journal entries that have been replicated to the target system can be retrieved from the remote journal.

You can activate and inactivate the remote journal function while concurrently running the following commands to view journal entries on the target system:

- Display Journal (DSPJRN)
- Retrieve Journal Entry (RTVJRNE)
- Receive Journal Entry (RCVJRNE)
- Retrieve Journal Entries (QjoRetrieveJournalEntries) API

When the remote journal is in the process of being caught-up from the attached journal receiver on the source system, two things can happen with respect to objects and their names in the journal entries.

- If journaling is started for any objects on the source system, the object name that is given on the target system in the start journal entry may be *UNKNOWN.
- If any move or rename operations take place, the last object name that was known before the catch-up phase started is what will be given. The actual new name may not be available until the catch-up phase is complete.

If you are using the DSPJRN or RTVJRNE command, additional informational messages will indicate that this situation occurred. If you are using the RCVJRNE command, additional information is provided on the exit program interface to help distinguish these situations as well. If you are using the QjoRetrieveJournalEntries API, additional information is provided in the returned data to help distinguish these situations. When necessary, the system attempts to minimize the possibility of showing these inconsistencies by temporarily delaying the processing performed by these commands.

Once the catch-up phase is completed, these inconsistencies will be resolved, and complete information will again be available.

Related concepts

[Activating and inactivating remote journals](#)

Activating a remote journal means starting and then maintaining the replication of journal entries from a source journal to a remote journal. Activating a remote journal always occurs from the source system.

[Receiving journal entries in an exit program](#)

You can write a program to receive journal entries as they are written to the journal receiver.

Related reference

[Display Journal \(DSPJRN\) command](#)

[Retrieve Journal Entry \(RTVJRNE\) command](#)

[Receive Journal Entry \(RCVJRNE\) command](#)

[Retrieve Journal Entries \(QjoRetrieveJournalEntries\) API](#)

Remote journal considerations for retrieving journal entries when using commitment control

Special performance related processing is done by the system when depositing entries that are associated with commitment control transactions to a local journal.

When a job deposits a journal entry that is not associated with a commitment control transaction, that job waits for the local journal I/O to auxiliary storage to complete. After completion, control is given back to the application. A different technique is used for those journal entries that are associated with a commitment control transaction which results in the application being given control back before the local journal I/O is complete. This special processing has some ramifications when you retrieve journal entries from a remote journal.

For journal entries deposited related to a commitment control transaction, a job only waits for the local journal I/O to complete when the following journal entries are being deposited into the local journal:

- Journal code C, journal entry type CM (Commit)
- Journal code C, journal entry type RB (Rollback)

For remote journals, those journal entries that the job that is making the deposit does not wait for are not immediately replicated or scheduled to be replicated to the remote journal. Prior to the CM (Commit) or RB (Rollback) entry being deposited, there is no guarantee as to when the journal entries for open commitment control transactions will be retrievable from the remote journal.

After the commit or rollback operation is complete for a particular commitment control transaction, all journal entries associated with that transaction are immediately retrievable from an asynchronously maintained remote journal. However, there may be some journal entry delivery latency due to the transport method that is being used.

For a synchronously maintained remote journal, all journal entries associated with the commitment control transaction are assured to be retrievable after the CM (Commit) or RB (Rollback) entry is deposited.

Interspersed local journal I/O, for journal entries not associated with a commitment control transaction, can also affect when the journal entries associated with a commitment control transaction can be retrieved from the remote journal. In this I/O a job actually waits for the local journal I/O to complete. This interspersed local journal I/O will also cause the journal entries related to the commitment control transaction to be replicated to the remote journal. Once in the remote journal, and when later remote

journal I/O makes them confirmed, the journal entries that are related to the commitment control transaction are retrievable.

Note: These considerations also apply if you generated entries that use the Send Journal Entry (SNDJRNE) command or Send Journal Entry (QJOSJRNE) API. If the application or user never requests to force these user generated entries, they will only be replicated to the remote journal when some other action forces the journal entries. Therefore, you will wish to periodically specify FORCE(*YES) when using these send journal entry functions.

These considerations also apply to any database physical file open or close journal entries; or directory or stream file open, close, or force entries.

Related concepts

[Commitment control](#)

Related reference

[Send Journal Entry \(SNDJRNE\) command](#)

[Send Journal Entry \(QJOSJRNE\) API](#)

Remote journal considerations for retrieving journal entries when using journal caching

When you use journal caching for the local journal, the system performs special performance-related processing when it deposits journal entries.

With journal caching, the system waits longer to write journal entries to disk, leading to fewer but larger disk writes. This action helps performance, but also delays the journal entries from being sent to the target system, even if you are using synchronous remote journaling.

For more information about journal caching see IBM Redbooks Technote: [Journal Caching: Understanding the Risk of Data Loss](#) 

Journal receiver management with remote journals

As with local journals, regularly save and delete your journal receivers to minimize the amount of online auxiliary storage which is used by the journal receivers.

The swapping of journal receivers for a remote journal is driven by the swapping of journal receivers on the source journal.

If you plan to move the responsibility for storing journal receiver data from the primary system to the remote system, you can elect to quickly delete journal receivers from the primary system after they have been replicated to the backup system with automatic deletion of journal receivers. On your backup system, you can then select to not use the automatic deletion of journal receivers on the remote journal, and manage the receiver save processing as you did before. Remember that once you add a remote journal, you cannot delete the source journal receiver until it has been replicated to all associated remote journals. Any journal receivers that are attached subsequently are also protected. The protection is eliminated when you remove the remote journal. If you have cascaded remote journals, consider using automatic deletion of journal receivers on the local journal, and on the lowest level remote journal. You would then not use automatic deletion of journal receivers on the cascaded remote journal since you plan to do your save processing on that system.

The Delete Journal Receiver exit point, QIBM_QJO_DLT_JRNRCV can be of assistance as well. For example, you might want to add an exit program to QIBM_QJO_DLT_JRNRCV which verifies that the journal receiver is no longer needed for any hot-backup application apply processing before it can be deleted. Refer to Delete journal receivers for information about this exit program.

Related concepts

[Swapping journal receiver operations with remote journals](#)

To swap journal receivers on a remote journal, perform a swap journal receiver operation on the source system to attach a new receiver to a local journal. When this happens, the remote journal function

automatically attaches a new receiver to the remote journals that are currently being maintained synchronously or asynchronously.

Automatic deletion of journal receivers

If you choose system journal receiver management, you can also have the system delete journal receivers that are no longer needed for recovery. You can only specify this if you are using system journal receiver management.

Related tasks

Deleting journal receivers

Journal receivers can quickly use a lot of auxiliary storage space. Therefore an important journal management task is to delete journal receivers after you no longer need them.

Swapping journal receiver operations with remote journals

To swap journal receivers on a remote journal, perform a swap journal receiver operation on the source system to attach a new receiver to a local journal. When this happens, the remote journal function automatically attaches a new receiver to the remote journals that are currently being maintained synchronously or asynchronously.

If the journal sequence numbers were reset as part of the swap journal receiver operation performed for the local journal, the remote journal function will also reset the journal sequence number for each remote journal. This keeps the journal sequence numbers synchronized between the local journal and the remote journal. For remote journals that are being synchronously maintained, a coordinated swap journal receiver operation is performed for the local journal on the source system and the remote journals on the target systems. For asynchronously maintained remote journals, the new receiver is attached when the target system receives the journal entry with journal code 'J' and entry type 'PR' (previous receiver).

If the swap journal receiver operation fails on the target system, the remote journal function ends for that remote journal, and processing continues on the source system. The system sends a message to the journal message queue that indicates that the remote journal function failed. When applicable, the system sends remote journal failure type messages to the related journal message queues on both the affected source and target systems.

You cannot initiate a swap journal receiver operation to attach a new receiver directly for a remote journal. New journal receivers are always attached to the remote journal by the remote journal function as new receivers are attached to the local journal. However, you can perform a change journal operation on a remote journal to change several other attributes for the remote journal such as the journal message queue or delete receivers value.

A swap journal receiver operation to attach a new receiver to a local journal that has an associated remote journal in the catch-up phase can be performed. This is regardless of whether the remote journal is currently being caught-up from a detached or the currently attached receiver on the local system. The catch-up phase of processing will not transition into synchronous or asynchronous delivery mode until the end of the currently attached receiver for the local journal is reached.

Related concepts

Working with remote journal error messages

Several different error conditions can occur when the remote journal function is active.

Related tasks

Swapping journal receivers

An important task for journal management is to swap journal receivers. You typically swap journal receivers when they reach their storage threshold. You can swap journal receivers either with IBM

Navigator for i or with the Change Journal (CHGJRN) command. If you use system journal-receiver management, the system changes journal receivers for you.

Considerations for save and restore operations with remote journals

The following information describes general considerations for save and restore operations with remote journals:

- Rules for saving and restoring journals
- Rules for saving and restoring journal receivers
- File identifier considerations for working with integrated file system entries
- Considerations for restoring journaled objects
- Considerations for restoring objects saved with SAVSTG

Related concepts

File identifier considerations for working with integrated file system entries

If you plan to replay the integrated file system operations in the remote journal to objects on the target system, and if you primed that target system with objects that were restored from the source system, then some additional considerations apply to replaying those journal entries.

Rules for saving and restoring journals

It is recommended that you save the remote journal network after the addition of any and all remote journals that will be associated with the journal. This includes saving the local journal and any associated remote journals, as well as the journal receivers that are associated with the local journal.

Follow the basic save and restore rules for journals that are listed here:

- A saved local journal is always restored as a local journal.
- A saved remote journal is always restored as a remote journal.
- As with all prior save and restore support for journals, the support will not allow a restore-over operation for a journal. This is true for both local and remote journals.
- When restored, a local or remote journal is always restored to the library from which it was saved. For a local journal, this library is referred to as the original journal library. For a remote journal, this library is referred to as the redirected journal library.

For a remote journal, library redirection may not have been specified when adding the remote journal to the local journal's definition. If this occurs, then the redirected journal library name is the same name as the original journal library name.

Note: This is always true except in the case where the journal was saved from library QRCL. (The journal could reside in library QRCL due to prior Reclaim Storage processing.) In that case, the RSTLIB parameter must be specified on the restore request, and you must specify the library where the journal originally resided. For a local journal, this is existing support and is not new. For a local journal, the library that must be explicitly specified is the original library.

This support logically extends to remote journals. For a remote journal, the redirected library must be explicitly specified on the RSTLIB parameter of the restore request.

- If remote journals are associated with a journal when a journal is saved, the information that is related to the added remote journals is also saved.

When the journal is restored, the information that is saved about its remote journals is also restored if restored to the same system with the same name. If the system is different or the name of the system was changed since the save, the remote journal information will not be restored when the journal is restored. This information is included as part of that journal's definition. This is true whether the journal being saved is a local or a remote journal. When restored, the restored journal's definition will only include the saved, immediately downstream remote journal definitions.

Note: None of the actual downstream remote journals are actually verified as part of the restore operation. Any necessary validation of the remote journal information occurs when you activate that

particular remote journal by using the Change Journal State (QjoChangeJournalState) API or Change Remote Journal (CHGRMTJRN) command.

- Local journals are restored to the same state in which they are saved.

Related reference

[Change Journal State \(QjoChangeJournalState\) API](#)

[Change Remote Journal \(CHGRMTJRN\) command](#)

Rules for saving and restoring journal receivers

The restore relationships for journal receivers associated with remote journals are described in this topic.

The following figure illustrates the restore relationships for journal receivers that are associated with remote journals, based on the remote journal type.

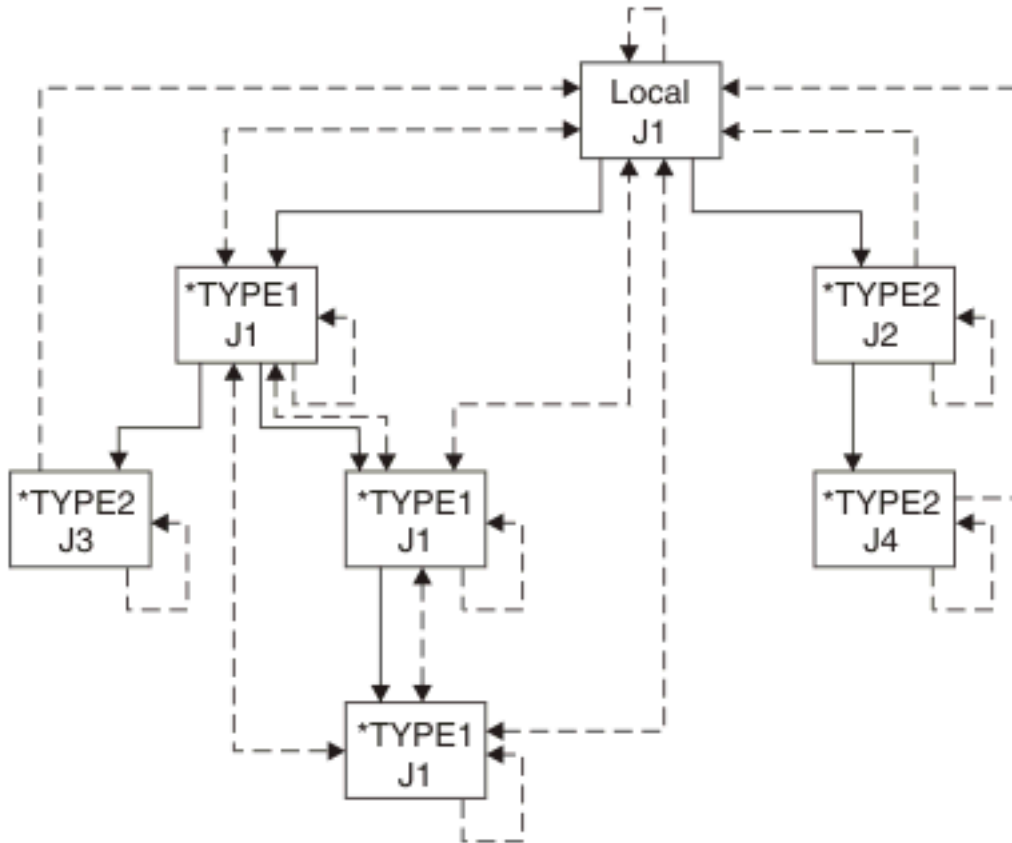

Key:

—→ Solid Arrow: Remote Journal association. Arrowhead points to added remote journal from source journal at arrow tail.

←—→ Dashed Arrow with Two Heads: Receivers can be saved from either journal and be restored and linked into the correct receiver chain of either journal.

- - → Dashed Arrow with One Head: Receivers can be saved from the journal at the tail of the arrow, and linked into the correct receiver chain of the journal at the head of the arrow.

RZAKI517-1

There are several unique rules which govern where the journal receivers that are associated with a remote journal can be restored. The rules also discuss the placement of the journal receivers in the receiver directory chain of a local or remote journal. These rules are influenced by the remote journal type of

the journal to which the journal receiver was attached. These rules are also influenced by the library redirection that was in effect when that receiver was attached. See Types of remote journals.

Note: You can always save receivers from a journal, and then restore the receivers to another local journal of the same name. However, they will be placed in their own separate receiver chain.

The following items describe the rules that the system uses when restoring journal receivers:

1. The system first attempts to find an appropriate remote journal. When searching for a remote journal, the system follows the following rules:
 - If the saved receiver was originally associated with a local or *TYPE1 remote journal, then the system searches for a *TYPE1 remote journal.
 - If a *TYPE1 remote journal was defined at the time this receiver was attached, then use the journal and receiver library redirection that was in effect and saved with the receiver. If no *TYPE1 remote journal was defined at the time this receiver was attached, then the original journal library and receiver library names will be used when searching for the *TYPE1 remote journal.
 - If a *TYPE1 remote journal is found, and the current receiver library redirection for the found *TYPE1 remote journal matches the library name where the receiver is being restored, the journal receiver will be associated with the found *TYPE1 remote journal.
 - If the receiver was originally associated with a *TYPE2 remote journal, then the system searches for a *TYPE2 remote journal. When searching for the *TYPE2 remote journal, a journal with the same name as the name that was saved with the receiver will be used. The journal receiver will be associated with a found *TYPE2 remote journal if the following conditions are met:
 - A *TYPE2 remote journal is found with the correct name in the correct library.
 - The found journal is in the exact same remote journal network as that of the saved receiver.
 - The receiver is being restored to the same named system or same named ASP group as the name of the system or ASP group at the time the receiver was saved.
2. If a remote journal was not found, then the system searches for a local journal. When searching for a local journal, the original journal and journal library names are used. The journal receiver will be associated with a found local journal if the following conditions are met:
 - A local journal is found by the correct name in the correct library.
 - The original journal receiver library name for the found journal matches the library name where the receiver is being restored.
3. If a local journal cannot be found, the restore operation will be allowed to proceed. The journal receiver will not be associated with any journal, if the receiver is being restored to the original or redirected receiver library.
4. Still honoring the previous receiver restore rules, the following must also be true if the receiver is being restored over an existing receiver:
 - If the receiver is not being associated with any journal (as previously determined from the prior receiver restored rules), then following items apply:
 - The receiver creation time stamps must match.
 - If the saved receiver was ever associated with a journal, then it must have been previously associated with a journal of the same type as that of the existing receiver.
 - If the saved receiver was ever associated with a remote journal network, then it must have been previously associated with the same remote journal network as that of the existing receiver.
 - The saved receiver must have at least as many entries as the existing receiver.
 - If the receiver is being associated with a local journal, then the following items apply:
 - If the saved receiver was originally associated with a local journal, then the receiver creation time stamps must match.

- If the saved receiver was not originally associated with a local journal, then the saved receiver must have been originally associated with the same remote journal network as that of the existing receiver.
- The saved receiver must have at least as many entries as the existing receiver.
- If the receiver is being associated with a *TYPE1 remote journal, then the receiver creation time stamps must match, and the saved receiver must have been originally associated with a local or *TYPE1 remote journal.
- If the receiver is being associated with a *TYPE2 remote journal, then the receiver creation time stamps must match, and the saved receiver must have been originally associated with the same *TYPE2 remote journal.

When receivers are saved from or restored to a target system and associated with a remote journal, no journal entries are deposited to indicate that the save or restore occurred. However, the object save and restored date and time stamps are updated accordingly.

Save and restore considerations

Considerations for remote journal receivers

Do not save the receiver while it is attached to the remote journal. If it is a long running save it can inhibit a change journal operation that was initiated by the source and the remote journaling environment can time out and fail.

Nonreplicated journal receiver protection considerations

The protection provided, which prevents journal receivers that are not fully replicated to all associated remote journals from being deleted, is removed when the journal receiver is restored.

Unconfirmed journal entries save considerations

When a journal receiver that is associated with a remote journal is saved, only those journal entries which have been confirmed are saved to the media. Therefore, no unconfirmed journal entries, nor any journal entries that would not survive any IPL journal recovery processing, will be saved.

Journal receivers saved with STG(*FREE) considerations

Even if a journal receiver has not been fully sent to all known remote journals, such a journal receiver can be saved with STG(*FREE). However, a diagnostic message is left in the job log indicating the freeing of the journal receiver storage without the journal receiver first being fully replicated to all downstream remote journals. This is in contrast to the default action taken when attempting to delete a receiver that has not been fully replicated to all downstream remote journals.

Related concepts

Types of remote journals

The two types of remote journals are *TYPE1 and *TYPE2. The two types identify operational characteristics of a remote journal and its associated journal receivers. The following table is an overview of the different remote journal types and their characteristics. There are no performance differences between the types of remote journals.

Considerations for restoring journaled objects

For an object that is restored and associated with a local journal in standby state, journaling starts for that object, but no restore entry is deposited in the journal receiver. If the object is being restored-over and is currently journaled to a local journal in standby state, the restore is not prevented, and no restore entry is deposited in the journal receiver.

The system will send a diagnostic message for any object in which the 'object restored' journal entry cannot be sent due to a problem with the journal or attached journal receiver, unless the journal is in standby state. The system always attempts to start journaling for an object that was journaled at save time to the same named journal, in the same named library, during a restore operation. This is still true, and there are no processing changes to note if a local journal is found by the restore processing. However, if a remote journal is found by the restore processing, the restore is completed successfully, but journaling is not started for the restored object. A diagnostic message is sent that indicates that a remote journal was found by the restore processing. This message is followed by the message that is already sent that indicates journaling was not started.

In a hot-backup configuration, a local journal is used on the backup system to capture the changes that are made to the objects on the remote system. This occurs when the remote system is logically promoted to assume the role of the primary system. The local journal that is being used on a backup system might not be in the exact same-named library as the journal that is being used for the object at save time. If this occurs, you are responsible for starting journaling for the restored objects. This is a fundamental reason to use library redirection for all defined remote journals.

Considerations for restoring objects saved with SAVSTG

If you restore a system from Save Storage (SAVSTG) media, the primary remote journal function concerns have to do with configuration changes involving additionally defined remote journals.

These remote journals were established after the SAVSTG media was produced. If a primary system is restored from SAVSTG media, journal receivers can be restored back to the primary system from versions saved from any of the associated remote journals in the remote journal environment. If a backup system is restored from SAVSTG media, then the catch-up phase for activating the remote journal can replicate all necessary journal receivers that are still online from the primary system to the restored backup system. Those journal receivers that are not online, and were attached to a *TYPE1 remote journal, can be restored back to the backup system. They can be restored from any saved versions of the journal receivers that were previously taken from one of the following:

- The primary system
- Any of the associated remote journals in the remote journal environment

See the Rules for saving and restoring journal receivers link below for the journal receiver restore rules which is typically used for this type of restore.

Another consideration occurs as part of the processing that is performed by the system when restoring journal receivers. Before associating a journal receiver with a local journal and retaining any remote journal information, the journal library name, and the system name or the independent disk pool name must be correct. This allows the system to differentiate between a local journal that was originally created and one that was restored to a different physical system using SAVSTG media. This case assumes that the user assigns a new system name as part of the SAVSTG procedure.

In one example case, the system was restored using SAVSTG media but was not restored to the same physical system. However, the restored system still had the same name as the system from where the media was produced. This situation can cause problems and should be avoided.

Related concepts

[Rules for saving and restoring journal receivers](#)

The restore relationships for journal receivers associated with remote journals are described in this topic.

Remote journal considerations when restarting the server

This topic discusses the considerations for remote journaling when you restart the server.

Considerations for restarting replication of journal entries

The replication of journal entries to each of the associated remote journals ends implicitly when the local system ends. To begin replicating journal entries to the remote journal, you must restart the remote journal on the target system. After an IPL or vary on operation, you are not required to reassociate the remote journals with the journal on the source system.

Considerations for main storage preservation

In addition to unconfirmed I/O for journal entries, you also need to consider the preservation of main storage for a failed system during recovery processing. Given certain system failures, main storage might or might not be preserved during the following IPL to recover from the system failure. Therefore, it is possible for journal entries to survive in a local journal after a system failure, even if the local or remote I/O was never performed for those journal entries.

Therefore, IPL recovery on a primary system might preserve changes that are not yet replicated to any of the remote journals, even the remote journals that are synchronously maintained. Scenario: Recovery for remote journaling demonstrates that you can use the remote journal function to account for journal entries that survive a system failure in this manner. These journal entries do not cause a total re-priming of the original data when switching back from a backup system which took over the role of the primary system.

In the scenario, when the system ends, the system does not return control to the application programs that are in the process of generating these surviving journal entries. Therefore, the application does not know whether or not any of operations completed when the system ends. Also, the application does not make dependencies or decisions on these operations. This includes dependencies or decisions by the application performing the operation or any other application that could be possibly dependent upon the data affected by the operation.

Because of this consideration, it is recommended that you journal both the before-images and after-images for any objects, if possible. With the before-images, the work can then be backed out after the IPL or vary on operation. If the data activity is not backed out after the IPL or vary on operation, the alternative is to re-prime the primary system data completely from the backup data which had assumed the role of the primary.

Considerations for when the target system ends

When remote journaling is active, if the target system ends whether normal or abnormal, journaling on the source system is not affected. The local system continues to deposit entries into the local journal without an error. The system sends a message to the message queue of the local journal to alert the operator that remote journaling ended. When the target is again available, you can reactivate remote journaling from the source system. When you activate remote journaling, the default is for the local system to start sending journal entries starting with the first entry the target system is missing. Additionally, you can specify that remote journaling automatically try to restart when the target system ends.

Considerations for commitment control

Commitment control, especially two-phase commitment control, can cause some additional considerations and potential complications. For example, if any of the entries that were preserved but not yet confirmed were a commit or a rollback operation, then the transaction will have to be reconciled accordingly between the primary system, and the backup system.

Considerations for journal caching

Journal caching affects remote journaling. Since journal entries are not sent to the target system right away, the number of journal entries that are not confirmed in a synchronous remote journal environment are always greater than if you are not using journal caching.

Related tasks

Inactivating the replication of journal entries to a remote journal

When you end replication of journal entries to a remote journal, it is recommended that the replication of entries be ended from the source system whenever possible, rather than from the target system. Usually, ending replication from the target system for a remote journal is only necessary when the source system has failed, and the system has not ended the remote journal function.

Activating the replication of journal entries to a remote journal

In order to activate the replication of journal entries to a given remote journal, the following must be true:

Related information

Scenario: Recovery for remote journaling

This scenario describes a hot-backup environment in which the local system, JKLINT fails. It is necessary to restore the local system, and synchronize it with the remote system, JKLINT2.

Working with remote journal error messages

Several different error conditions can occur when the remote journal function is active.

When an error condition is encountered, the system automatically ends the remote journal function on the source system to that remote journal. The system notifies you that a failure occurred. Failure notification is made on both the source system and the target system. Notification is made by sending a message to the journal message queues associated with the source and target journals as appropriate. If remote journal is to automatically restart then additional messages are sent to the journal message queue to indicate the restarting attempts have started, and to indicate that the final restart attempt was not successful.

For help determining why remote journaling ended, see IBM Redbooks technote [Journaling - Common](#)

[Remote Journal Questions](#) 

Additional messages can be sent to the journal message queue for normal remote journal processing. For example, if you requested a controlled inactivate of the remote journal, a message will be sent to the message queue when the inactivate processing has completed.

Even though the remote journal function has been ended, the local journal is not automatically inactivated. Therefore the local system journal entry deposits will continue normally.

The remote journal function messages that are sent to the journal message queue are listed as follows:

CPI7012

Recovery procedures for messages CPF70D4 and CPF70D5.

CPI7016

Recovery procedures for messages CPF70C4 and CPF70C5.

CPI7027

An attempt to restart remote journaling failed, another will be attempted.

CPI7028

Remote journaling could not be restarted because either an unrecoverable error was encountered, or the maximum restart attempts were made.

CPI7031

Additional recovery procedures for messages CPF70D4 and CPF70D5.

CPExxxx

When remote journaling ends due to communication errors, the communication messages are also sent to the journal message queue. These messages will help address communication related problems.

CPF70C4

The data port services remote journal function is no longer active due to various reasons. For a synchronously maintained remote journal, there may be unconfirmed entries which may need to be processed prior to the remote journal being inactivated.

CPF70C5

The data port services remote journal function is no longer active and has been ended due to various reasons. There are no unconfirmed entries.

CPF70D3

A controlled inactivate of a remote journal has completed.

CPF70D4

The remote journal function is no longer active due to various reasons. For a synchronously maintained remote journal, there may be unconfirmed entries which may need to be processed prior to the remote journal being inactivated.

CPF70D5

The remote journal function is no longer active and has been ended due to various reasons. There are no unconfirmed entries.

CPF70D6

The remote journal function was ended due to storage constraints.

CPF70D7

There was a problem on the target system while attempting to execute a change journal.

CPF70DB

A severe error has occurred with the remote journal function, and service must be notified.

CPF70DC

There was a timeout on the target system while attempting to attach a new journal receiver to the remote journal.

Display the messages on your system for more information.

Related concepts

[Confirmed and unconfirmed journal entries](#)

For a local journal, all entries are confirmed entries. There is no concept of unconfirmed entries.

Related reference

[Change Journal State \(QjoChangeJournalState\) API](#)

[Change Journal \(CHGJRN\) command](#)

Scenarios: Remote journal management and recovery

These scenarios describe the possible ways that JKL Toy Company can use remote journal management. JKL Toy Company uses the server JKLINT as their web server.

They need 24x7 availability for the critical data on this server, and they accomplish that by having a second server, JKLINT2, that shadows JKLINT. They use a high availability replication solution to copy the data from JKLINT to JKLINT2. Then, if JKLINT goes down, they can switch to JKLINT2.

The following scenarios describe two possible environments in which they can use remote journaling. The first scenario describes how JKL Toy Company can set up a data replication environment. The second scenario describes how they set up a hot-backup environment. The third scenario describes recovery steps if one of the servers fails.

Note: Scenario: Journal management contains a complete description of JKL Toy Company's network and their overall strategy for journaling.

Related information

[Scenario: Journal management](#)

This topic provides the steps that a fictitious company, JKL Toy company, takes as it implements journal management.

Scenario: Data replication environment for remote journals

In this scenario, JKLINT and JKLINT2 use remote journaling for data replication purposes only.

The following figure illustrates this remote journaling environment. **Data replication** is the function of maintaining a separate copy of data from an original copy, keeping the two copies consistent with each other.

Typical data replication environment with remote journal function

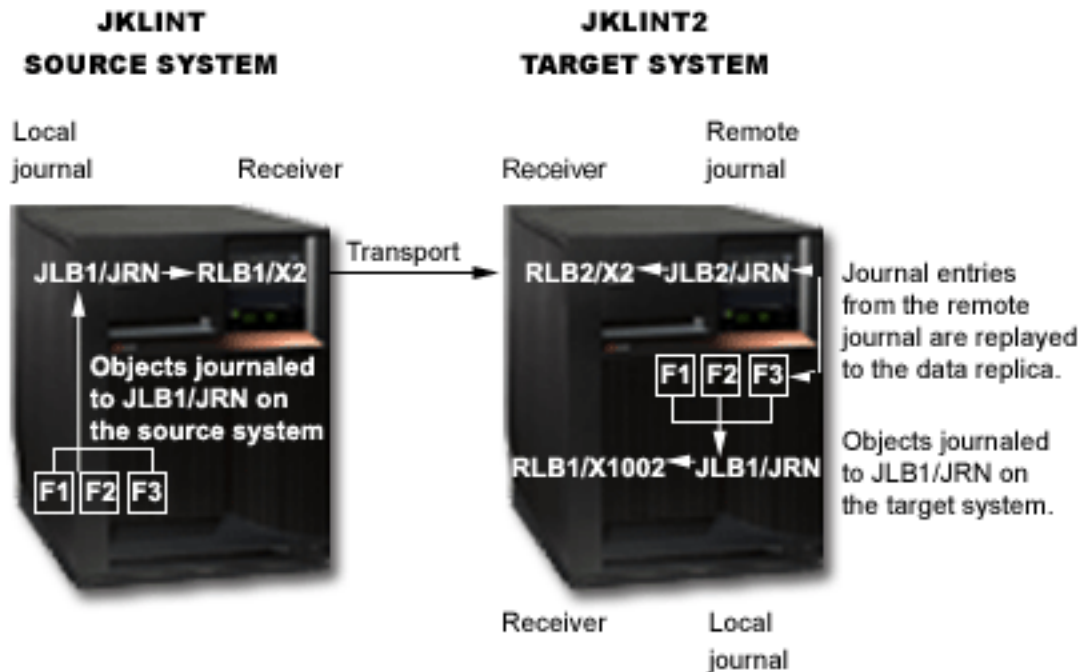

How the data replication environment works

Local objects, F1, F2, and F3, on JKLINT are journaled to local journal JRN in library JLB1. A remote journal is defined on JKLINT2, where JRN has been redirected to library JLB2. This remote journal receives journal entries from the local journal on JKLINT. A hot-backup application apply replays the changes to the data replica on system JKLINT2.

The data replica is journaled to a local journal, JRN in library JLB1, for system recovery purposes only, so this journal must be in active state. If system JKLINT2 fails, the system performs recovery for the objects by using this local journal.

A hot-backup application assists in replicating data from one system to another. The hot-backup application apply is only performing the replay of operations to the data replica on the target system.

Since this scenario is for a data replication environment, the hot-backup application does not perform a switch-over to the backup system. See Scenario: Hot-backup environment for more details about hot-backup applications applies and hot-backup switch-overs.

How to establish the data replication environment for JKLINT and JKLINT2

The objects and local journal on JKLINT are already assumed to exist. The journal state for the local journal is also assumed to be active. The communications environment and associated RDB entries already exist and are established.

Establishing the data replication environment for JKLINT and JKLINT2 requires the following:

1. Create the remote journal on JKLINT2, and specify library redirection. Library redirection indicates that the journal's library, JLB1 on JKLINT, is redirected to library JLB2 on JKLINT2. The journal receiver's library, RLB1 on JKLINT, is redirected to library RLB2 on JKLINT2.

After this step, the remote journal exists, but no receiver is currently attached.

2. To establish a clean breakpoint, perform a change journal operation to attach a new journal receiver at this time.

Note: The next step restores local journal JRN in library JLB1 and attaches receiver X1002 in library RLB1. It then restores the objects, and starts journaling for the objects to the restored local journal.

3. Save the local journal and objects from JKLINT and restore them to JKLINT2. This primes the data replica and establishes the local journaling environment on JKLINT2.
4. Activate the remote journal on system JKLINT2. Specify that the remote journal must start with the attached receiver. Since no receiver is attached to the remote journal, the receiver that is currently attached to the local journal on JKLINT (X2) is created on JKLINT2. This receiver is then attached to the remote journal. Journal entries are replicated, starting with the first journal entry in receiver X2.

An additional parameter on the Change Journal State (QjoChangeJournalState) API and Change Remote Journal (CHGRMTJRN) command indicates whether the remote journal function is to be maintained synchronously or asynchronously. Depending on how the remote journal is maintained, other parameters may also apply.
5. The hot-backup application apply process receives or retrieves journal entries from the remote journal, starting with the entries that were deposited after the data was saved and primed into the data replica. The process then starts replaying the changes that are contained in these journal entries to the data replica.

Normal run-time environment for the data replication environment

You can activate and inactivate the replication of journal entries to the remote journal as needed. Each time you activate the remote journal, *ATTACHED is specified as the point in the receiver chain to start receiving journal entries. The system checks the currently attached remote journal receiver for journal entries and replicates the next journal entry in sequence.

You must specify the delivery mode when activating the remote journal. If needed, the delivery mode can be different on each activation of the remote journal.

Change journal operations that attach a new receiver to the local journal on system JKLINT are performed by the remote journal function as required on the target system. The remote journal function attaches the associated receivers to the remote journal automatically. If the remote journal is being maintained synchronously, the change journal operation to attach a new receiver is essentially a coordinated operation between the source and target systems. If the remote journal is being maintained asynchronously, the change journal operation to attach a new receiver on the target system is performed differently. In this case, it is triggered when the journal entry with journal code 'J' and entry type 'PR' is received by the remote journal on the target system.

The hot-backup application apply continues to replay changes to the data replica as received or retrieved from the receivers associated with the remote journal.

If needed, you can delete the receivers that are associated with the local journal on JKLINT when each receiver is replicated to JKLINT2. Sharon can accomplish this by specifying automatic deletion of journal receivers or manually deleting the receivers on JKLINT.

You can save the receivers from JKLINT2. If necessary, you can use the receivers for recovery of the original data on system JKLINT at a later time.

Data replication recovery if JKLINT fails

Recovery for JKLINT and JKLINT2 is simpler than environments that involve hot-backup because the hot-backup application does not switch-over to the backup system. What prevents the complications is an assumption that the hot-backup application apply logic will not receive and replay unconfirmed journal entries to the data replica if system JKLINT2 loses communications with system JKLINT. Therefore, the data replica on system JKLINT2 can never get ahead of the data on system JKLINT. This greatly simplifies data synchronization.

Related concepts

[Where the replication of journal entries start](#)

When you specify a journal receiver for remote journaling, you are specifying where the replication of journal entries will start.

[Activating and inactivating remote journals](#)

Activating a remote journal means starting and then maintaining the replication of journal entries from a source journal to a remote journal. Activating a remote journal always occurs from the source system.

Automatic deletion of journal receivers

If you choose system journal receiver management, you can also have the system delete journal receivers that are no longer needed for recovery. You can only specify this if you are using system journal receiver management.

Related tasks

Adding remote journals

This topic provides instructions for adding a remote journal.

Activating the replication of journal entries to a remote journal

In order to activate the replication of journal entries to a given remote journal, the following must be true:

Related reference

Change Journal State (QjoChangeJournalState) API

Change Remote Journal (CHGRMTJRN) command

Related information

Scenario: Hot-backup environment

In this scenario, the remote journaling environment uses a hot-backup application that causes JKLINT2 to replace JKLINT in the case that JKLINT has a failure.

Scenario: Hot-backup environment

In this scenario, the remote journaling environment uses a hot-backup application that causes JKLINT2 to replace JKLINT in the case that JKLINT has a failure.

A **hot-backup application** typically performs the following:

1. If the primary system fails, it performs a switch-over to the backup system. This function then logically promotes the backup system to assume the role of the primary system.
2. After the failed primary system is restarted, it performs a switch-back operation so that the primary system can again assume the role of the primary system.

A **hot-backup application apply** defines the part of a hot-backup application that actually performs the replay operations to the data replica. This usually occurs on the backup system when maintaining a data replica.

The following figure describes a typical remote journal environment that is used for hot-backup purposes. The following occurs in this illustration:

- Server JKLINT is the primary server while JKLINT2 is the backup server.
- Server JKLINT journals objects to local journal JKL1/JRN.
- Changes to those journaled objects are also journaled to remote journal JLB2/JRN on server JKLINT2.
- On JKLINT2 a hot backup-apply replays changes to the data replica. When the hot backup-apply replays these changes, JKLINT2 journals the changes to its own local journal, JLB1/JRN.
- If JKLINT fails, JKLINT2 assumes the role of primary server and all local journaling of changes to the data replica (now acting as the original data) continue on JKLINT2's local journal, JLB1/JRN.
- When it is time to switch the role of primary server back to JKLINT, JKLINT2 sends changes from its local journal, JLB1/JRN, to remote journal JLB2/JRN on server JKLINT (the transport from JKLINT2 to JKLINT is only used for this purpose).
- JKLINT then uses its remote journal, JLB2/JRN, to replay changes to the original data.

Typical hot-backup environment with remote journal function

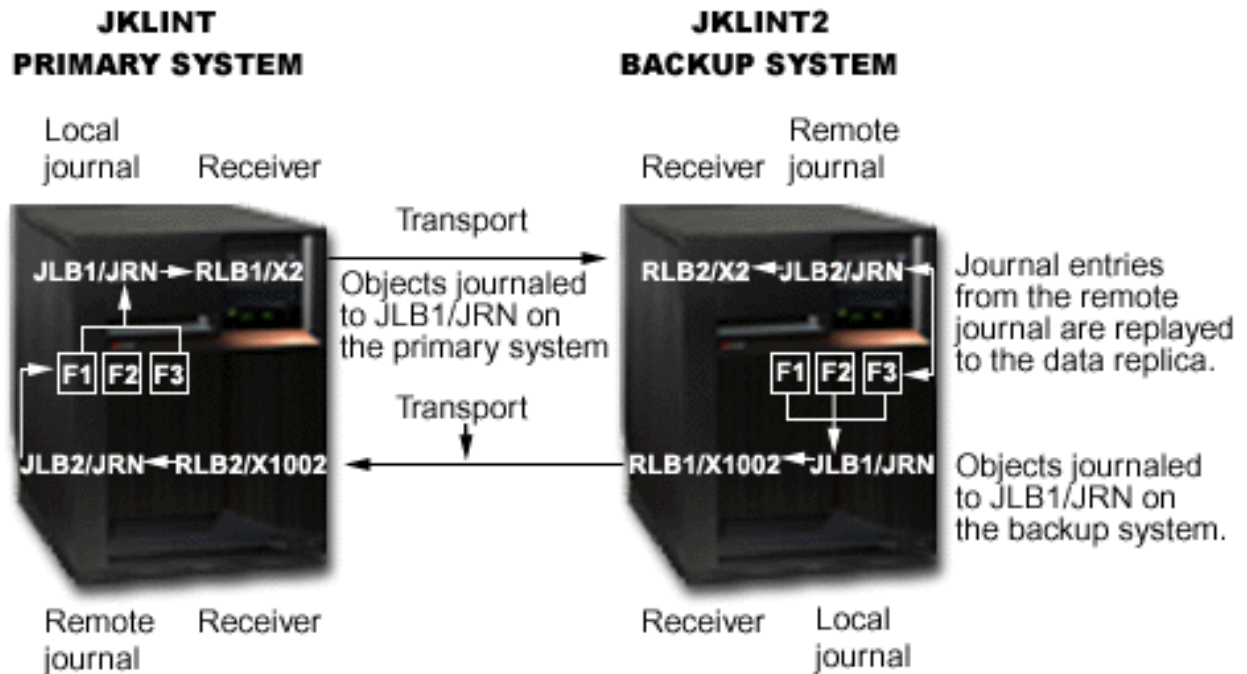

How to establish the hot-backup environment

The steps to establish a hot-backup environment are the same as establishing a data replication environment except for this additional last step:

Sharon also establishes a remote journal JKLINT that is associated with the local journal that she creates on JKLINT2. This remote journal receives or retrieves the journaled changes that are made when JKLINT2 assumes the role of the primary system. This local journal and remote journal pair will only be used when replicating changes back to the original data. During normal run-time processing, the remote journal, JLB2/JRN, that is defined on JKLINT is not active. When it is not active, it is not receiving or retrieving journal entries from the local journal, JLB1/JRN, on JKLINT2.

Normal run-time environment for the hot-backup environment

The details for the run-time environment for the hot-backup environment is the same as the data replication environment.

Hot-backup recovery if JKLINT fails

If you use a hot-backup application where the logical ownership of the data is given to JKLINT2, recovery is more complicated. In this case, the hot-backup application logically promotes JKLINT to assume the role of the primary system. Recovery is more complicated because after JKLINT has completed its IPL, the remote journal function catch-up phase from the local journal on system JKLINT to the remote journal on system JKLINT2 will always allow a resynchronization of the two sets of data.

Data resynchronization is recovery processing that is performed during switch-back processing by a hot-backup application. This processing ensures that the original data is consistent with the data replica, and contains all the correct changes. The main objective of this, besides assuring data consistency, is to eliminate re-priming the original data from the data replica.

Related information

Scenario: Data replication environment for remote journals

In this scenario, JKLINT and JKLINT2 use remote journaling for data replication purposes only.

Scenario: Recovery for remote journaling

This scenario describes a hot-backup environment in which the local system, JKLINT fails. It is necessary to restore the local system, and synchronize it with the remote system, JKLINT2.

Scenario: Recovery for remote journaling

This scenario describes a hot-backup environment in which the local system, JKLINT fails. It is necessary to restore the local system, and synchronize it with the remote system, JKLINT2.

Details: Recovery for remote journaling scenario has step-by-step instructions for recovering from this failure this scenario describes.

This scenario, and the details for this scenario, only discuss database physical files. All the concepts, however, apply to any journaled object type.

Example remote journal environment for hot-backup recovery

The following figure illustrates the hot-backup environment for JKLINT and JKLINT2. The following items list considerations for this environment:

- The remote journal BJ2 is only active after JKLINT fails. JKLINT2 assumes the role of primary system and JKLINT is running again (as the secondary system).
- Journal receivers are not specifically called out in the figure. They have been omitted in an attempt to simplify the scenario and to focus on the recovery steps for the database. Where necessary, processing specific to journal receivers is referred to in the scenario.
- Likewise, library redirection for the journals and journal receivers is not specifically called out in the figure. Again, this is omitted in an attempt to simplify the scenario. In the scenario, the libraries for any of the journals or journal receivers could be redirected to a library that is different from that being used for the corresponding objects on the other system.
- The figure simply refers to the original data in the figure as DB on the primary system JKLINT and DB' as the data replica on the backup system JKLINT2. DB can be one or more journaled objects, and DB' contains a replica for each of the journaled objects in DB.

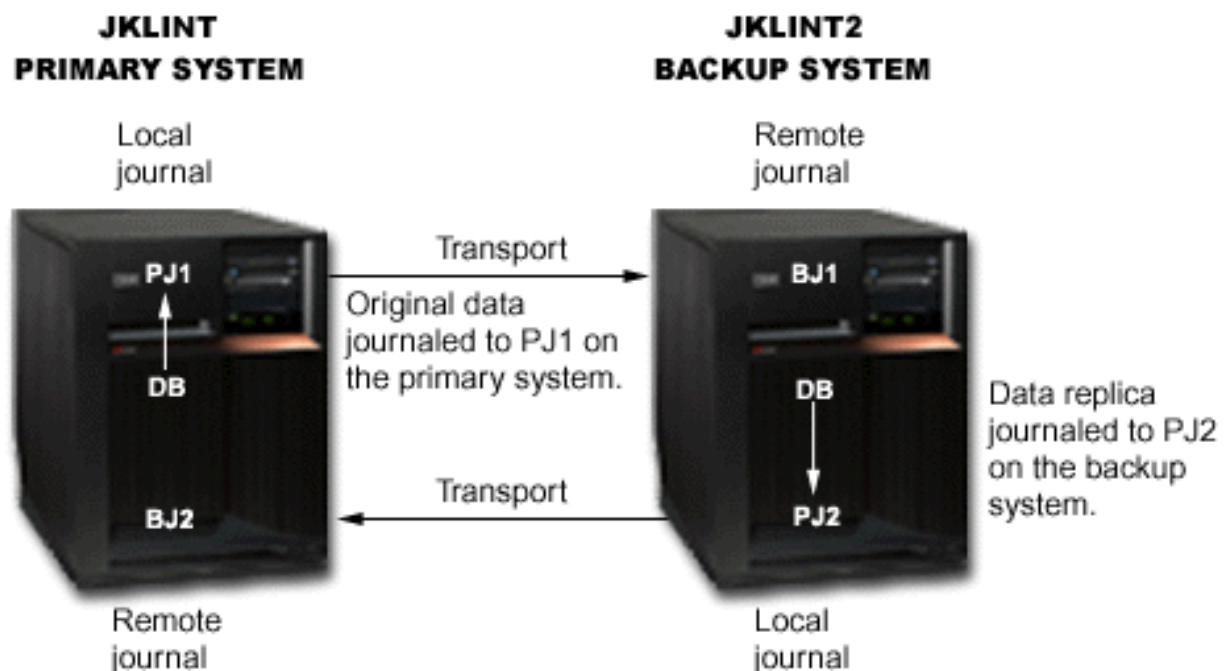

For simplicity, the scenario below treats DB as a single database file and DB' as its replica.

The following items describe the scenario at the time JKLINT fails:

- System JKLINT is the primary system.
- The original data that is denoted by DB is journaled to an active local journal PJ1.
- Remote journal BJ1 on backup system JKLINT2 is active, and unless otherwise noted, is synchronously receiving journal entries from journal PJ1.
- A hot-backup application apply, not shown in the diagram, is asynchronously replaying, or applying, the changes to the data replica, DB'.
- The data replica DB' is journaled to local journal PJ2 on system JKLINT2.

The journal state for journal PJ2 is *STANDBY.

- Remote journal BJ2 has a journal state of *INACTIVE (journal entries are not replicated to it). Remote journal BJ2 is only active when accepting the data changes back from system JKLINT2. This occurs after system JKLINT2 had been promoted to assume the role of the primary system due to a planned or unplanned outage of system JKLINT, and after system JKLINT has resumed operations.
- The primary system, JKLINT, has failed.
- The decision has been made to switch-over to the backup system, JKLINT2.

Related tasks

Details: Recovery for remote journaling scenario

This topic describes the details of the recovery process for remote journaling.

Details: Recovery for remote journaling scenario

This topic describes the details of the recovery process for remote journaling.

These details provide a step-by-step description of the process that occurs in Scenario: Recovery for remote journaling.

At the time of the system failure, the state of JKL and JKLINT is as follows:

- Journal entries 12-19 are already deposited into PJ1 and confirmed in BJ1.
- The corresponding data changes are also already reflected in the data replica, DB', on system JKLINT2.
- Journal entries 20-25 are built and validated in main storage on JKLINT and sent to BJ1, and then system JKLINT fails.
- Main storage is not preserved when JKLINT fails, so at the time of the failure, the last known confirmed sequence number in BJ1 is 19. Sequence numbers 20 through 25 are all unconfirmed.
- The last known sequence number in PJ1 will be 19 when system JKLINT restarts.

The hot-backup recovery strategy in these details does not require that both before-images and after-images are journaled to the local journal. However, the strategy would require before-images if, during the resynchronization process of the switch-back to the primary system, the strategy requires that the hot-backup application remove journaled changes.

To recover system JKLINT, the following steps are required:

1. Update DB' by using the hot-backup application to replay the unconfirmed journal entries.

- a) On system JKLINT2, allow the hot-backup application apply processing to complete the replay of confirmed operations as identified in journal BJ1. This is the first step of the switch-over processing. The apply processing includes replaying all journal entries up through and including sequence number 19.
- b) The hot-backup application does not replay sequence numbers 20-25 because the I/O for those journal entries is not yet confirmed from the local journal PJ1. The Receive Journal Entry (RCVJRNE) command or Retrieve Journal Entries (QjoRetrieveJournalEntries) API that is being used to retrieve the entries from the remote journal will not return sequence numbers 20-25 to the exit program, unless specifically requested to do so. To specify that sequence numbers 20 - 25 are returned to the exit program, use the INCENT(*ALL) parameter on the command. You can also request this by specifying *ALL for the include entries key on the API.

c) After the hot-backup application replays all confirmed journal entries, perform a change journal operation to attach a new journal receiver to local journal PJ2 on system JKLINT2 and change the state of journal PJ2 in *ACTIVE state. The change journal operation establishes a clean recovery point. It also makes clear what information needs to be sent back to system JKLINT later to replay back to the original data. Performing the change journal operation also prevents the remote journal function from having to re-replicate all of the journal entries that were previously generated into the currently attached journal receiver of PJ2. (The journal entries were generated into the receiver as part of replaying the database changes to the data replica on system JKLINT2.)

The following figure shows that more unconfirmed journal entries are present in BJ1 than are known in PJ1.

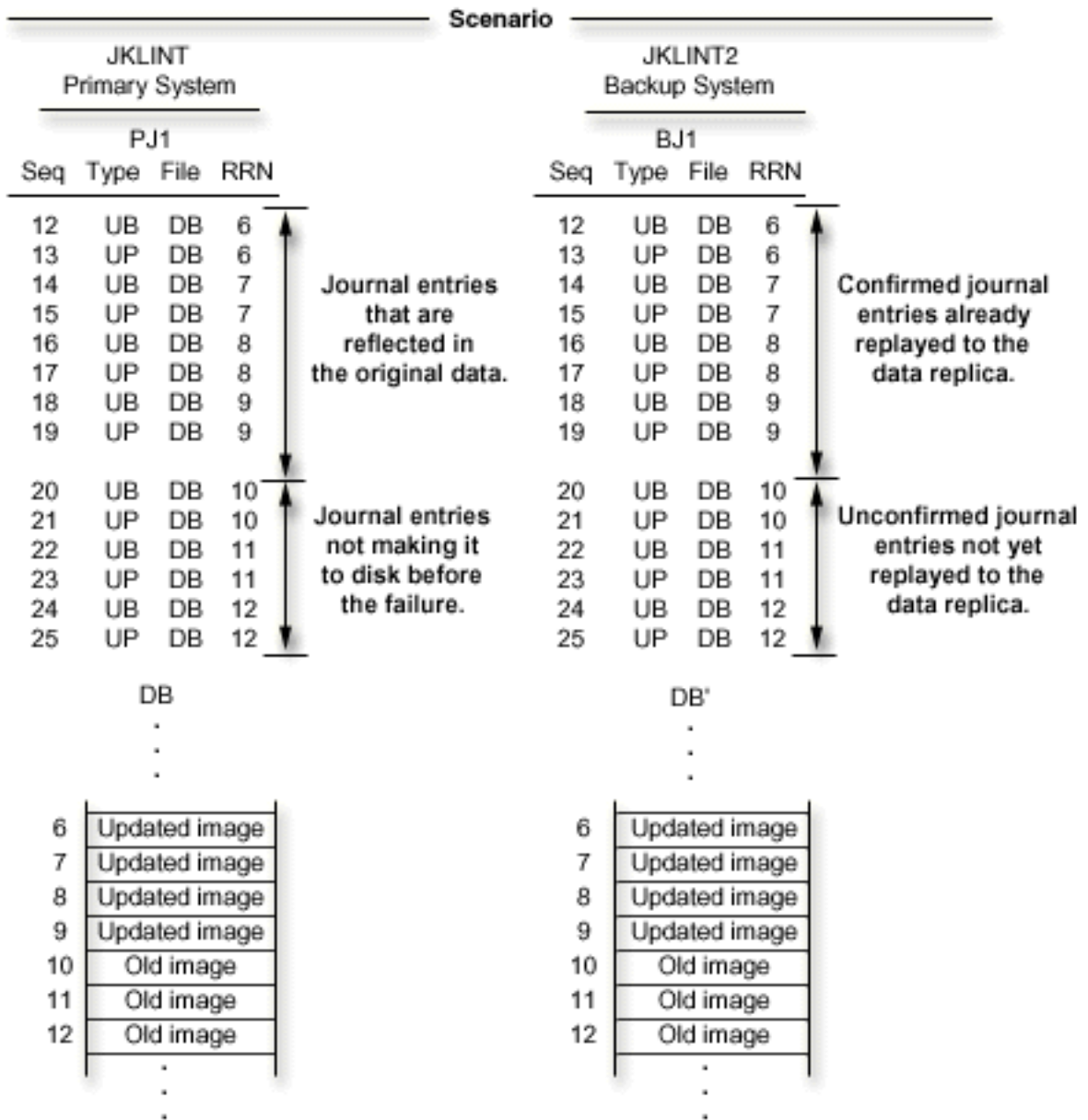

2. Perform switch-over processing and prepare JKLINT2 to run applications

a) The hot-backup application reads unconfirmed journal entries from BJ1 and replays them to the data replica. They are retrieved from BJ1 by using the Receive Journal Entry (RCVJRNE) command or QjoRetrieveJournalEntries API, specifically requesting that unconfirmed journal entries be returned. Journal entries 140-145 are generated into journal PJ2 when replaying these changes to the data replica.

- b) The QjoChangeJournalState API or CHGJRN command inactivates the remote journal BJ1. During this operation, the system physically removes the unconfirmed journal entries from BJ1. The last known sequence number in BJ1 is now 19.
- c) The replay processing on JKLINT2 sends a user entry that indicates the point in time when the database was switched-over. The user entry in the following figure is sequence number 146, journal code 'U', entry type 'SW'.
- d) After these steps are performed on system JKLINT2, applications can now be started on JKLINT2 and use DB' as the database to be updated. Applications continue to work and deposit journal entries 147-200.
- e) System JKLINT restarts and normal IPL recovery finds the end of the journal for PJ1 to be sequence number 19. IPL recovery ensures that all changes up to sequence number 19 are reflected in the original data. The IPL for JKLINT completes with journal PJ1 being left in the *ACTIVE state, as this was the state of the journal when the system failed.

The following figure shows the state of BJ1, PJ2, and DB' when system JKLINT2 is ready to assume the role of the primary system.

Example

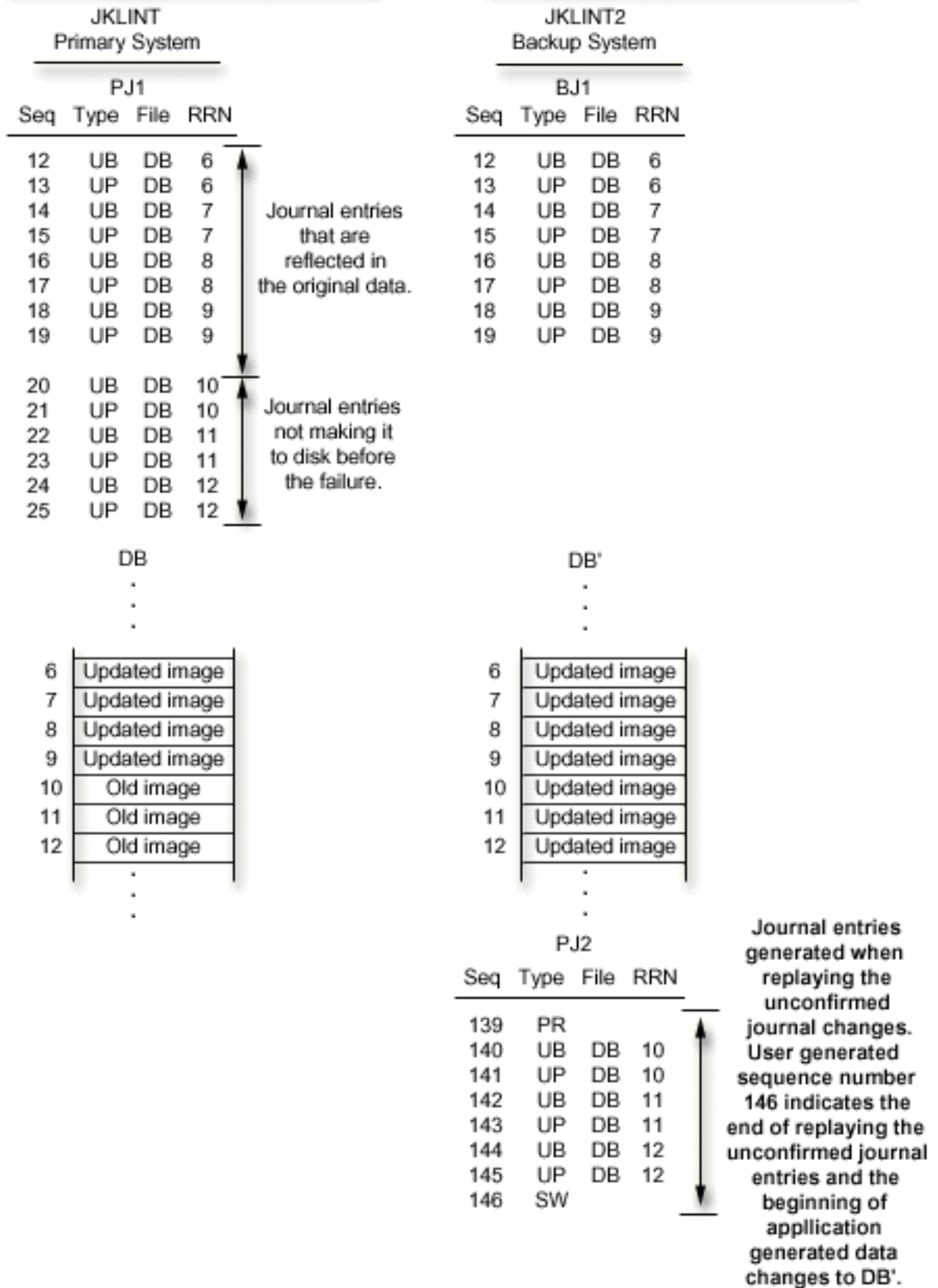

3. Activate remote journal PJ2 and transport journal to JKLINT

- a) After JKLINT restarts, activate the remote journal BJ2. Specify that the process will start with the attached journal receiver on JKLINT2. This starts the transport of journal entries representing the changes made on JKLINT2 as part of replaying the unconfirmed journal entries plus all changes made to DB' while JKLINT was unavailable. While this transfer is progressing (during catch-up processing, which then transitions into synchronous or asynchronous remote journal function mode), changes are still being made by applications to DB'.
- b) Either before or during the transport of journal entries to BJ2, send and make known the last known sequence number in BJ1 (19) to the hot-backup application apply. This can be included as information in the SW user journal entry.
- c) The hot-backup application backs-out changes that are known to PJ1 (after the last known sequence number in BJ1) from the original data DB on system JKLINT. For this particular scenario, no changes need to be backed out of the original data.

Note: For scenarios which require this back-out processing, both before-image and after-image journal entries are required.

The following figure shows the state of both systems after system JKLINT has completed its IPL. This is after system JKLINT2 has been running as the primary system, but before database DB is resynchronized with DB'. (The database changes represented in PJ2 by journal sequence numbers 147-200 are not shown in DB' for simplicity.)

Scenario

| JKLINT Primary System | | | | JKLINT2 Backup System | | | |
|--------------------------|------|------|-----|--------------------------|------|------|-----|
| PJ1 | | | | BJ1 | | | |
| Seq | Type | File | RRN | Seq | Type | File | RRN |
| 12 | UB | DB | 6 | 12 | UB | DB | 6 |
| 13 | UP | DB | 6 | 13 | UP | DB | 6 |
| 14 | UB | DB | 7 | 14 | UB | DB | 7 |
| 15 | UP | DB | 7 | 15 | UP | DB | 7 |
| 16 | UB | DB | 8 | 16 | UB | DB | 8 |
| 17 | UP | DB | 8 | 17 | UP | DB | 8 |
| 18 | UB | DB | 9 | 18 | UB | DB | 9 |
| 19 | UP | DB | 9 | 19 | UP | DB | 9 |
| 20 | IA | | | | | | |
| 21 | IU | DB | | | | | |

| DB | | DB' | |
|----|---------------|-----|---------------|
| . | | . | |
| . | | . | |
| . | | . | |
| 6 | Updated image | 6 | Updated image |
| 7 | Updated image | 7 | Updated image |
| 8 | Updated image | 8 | Updated image |
| 9 | Updated image | 9 | Updated image |
| 10 | Old image | 10 | Updated image |
| 11 | Old image | 11 | Updated image |
| 12 | Old image | 12 | Updated image |
| . | | . | |
| . | | . | |
| . | | . | |

| PJ2 | | | |
|-----|------|------|-----|
| Seq | Type | File | RRN |
| 139 | PR | | |
| 140 | UB | DB | 10 |
| 141 | UP | DB | 10 |
| 142 | UB | DB | 11 |
| 143 | UP | DB | 11 |
| 144 | UB | DB | 12 |
| 145 | UP | DB | 12 |
| 146 | SW | | |
| 147 | UP | . | . |
| | | . | . |
| | | . | . |
| 200 | UP | . | . |

Journal entries generated when replaying the unconfirmed journal changes.

Additional data changes made after JKLINT2 assumed the role of the primary system.

4. Replay changes to DB on JKLINT

- a) The hot-backup application replays the changes back to the original data on system JKLINT. The changes that are replayed include those changes that were made to DB' as part of the switch-over processing. The switch-over processing replayed the data changes for the unconfirmed journal

entries (sequence numbers 140-145)). Additional changes include those data changes that were deposited while system JKLINT2 had assumed the role of the primary system (sequence numbers 147-300). Note that changes are still being made to DB' on system JKLINT2 and journal entries are still being generated into local journal PJ2 on system JKLINT2.

- b) When you decide that JKLINT must again assume the role of the primary system, end the applications on JKLINT2. The following figure shows the state of both systems just before system JKLINT is going to assume the role of the primary system.
- c) Allow the remaining changes to be replicated to BJ2. After all changes have been sent to BJ2, you can inactivate BJ2.
- d) After all of the journal entries have been replayed to the original data on JKLINT, attach a new journal receiver to PJ1 to clearly denote a new recovery point.

The change journal operation is not absolutely essential. However, attaching a new journal receiver to PJ1 at this time makes clear where to start replaying changes back to the data replica on system JKLINT2. Performing the change journal operation also prevents the remote journal function from having to send back all of the journal entries that were previously generated into the currently attached journal receiver of PJ1. (The journal entries were generated in the receiver as part of replaying the data changes back to the original data on system JKLINT.)

The following figure shows the state of the journals and data just before starting to replay the changes back to the original data DB.

Scenario

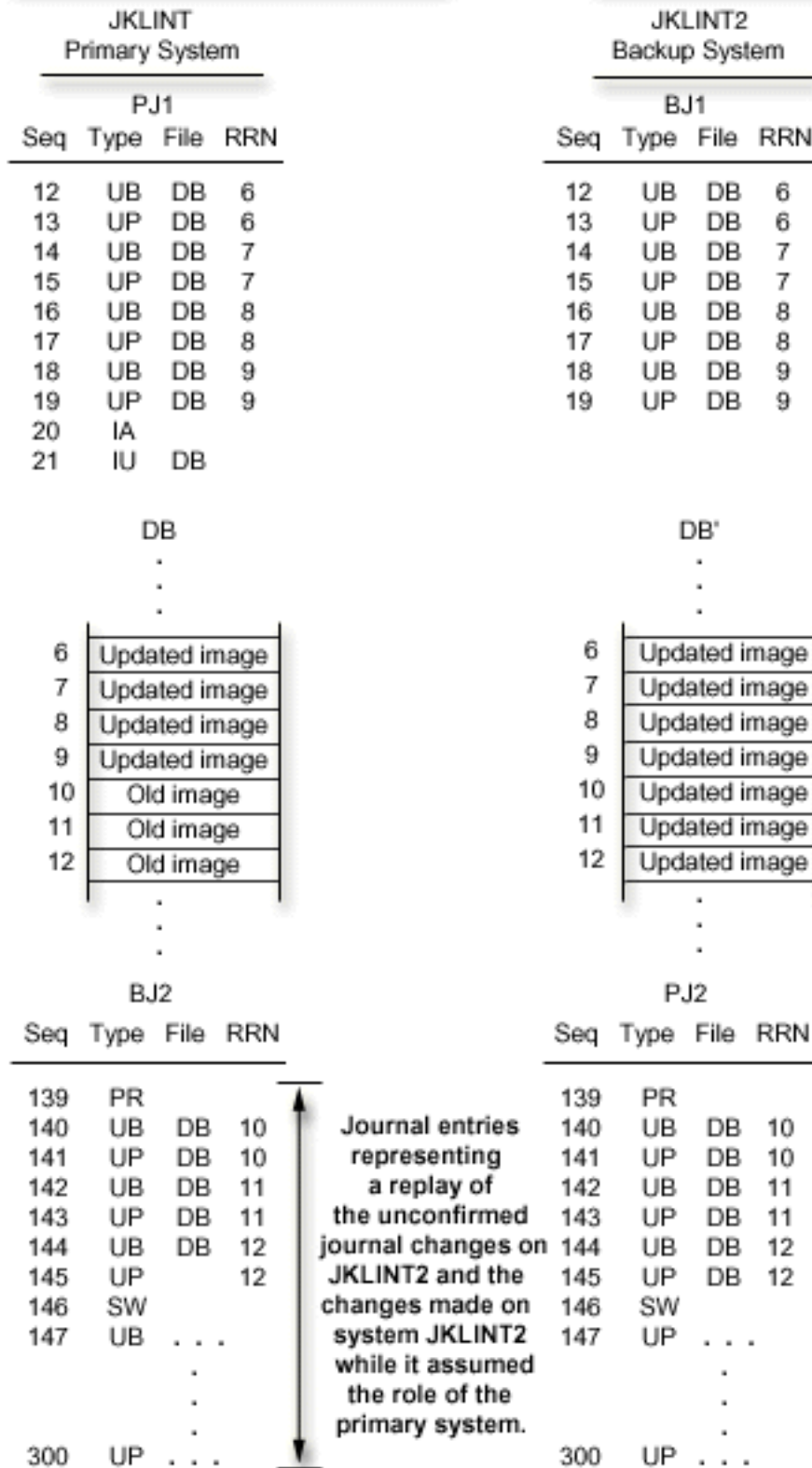

5. Allow JKLINT to again assume role of the primary system

- a) Application programs can now make changes to the original data DB on system JKLINT.
- b) When you determine that it is time to start replicating the changes made on the primary system to the backup system, you can activate the remote journal BJ1.

When activating the remote journal, you can indicate to send journal entries starting with the attached journal receiver on the source system. If this occurs, then only those journal entries that are required to be replayed to the data replica will be sent to system JKLINT2.

Note: You can start with the attached receiver, only if you did the change journal to attach a new receiver that was mentioned in step 4.

- c) If you want the complete chain of journal receivers from system JKLINT on JKLINT2, when you activate the remote journal, indicate to start with the attached journal receiver as known to the remote journal, BJ1. This will complete the sending of the journal receiver that contains the IPL entry (sequence number 20). The process will then move on to the next journal receiver that contains the journal entries where the hot-backup application apply will start replaying changes to the data replica. An alternative to that approach is to save and restore the detached journal receiver to system JKLINT2.
- d) You change the state of local journal PJ2 on system JKLINT2 to *STANDBY state.
- e) After local journal PJ2 has put in *STANDBY state, perform a change journal operation to attach a new journal receiver to PJ2.

The change journal operation is not absolutely essential. However, attaching a new journal receiver to PJ2 at this time makes clear where the replaying of changes back to the data replica started on system JKLINT2. Performing the change journal operation also avoids the remote journal function from having to later send all of these hot-backup application apply generated journal entries back to system JKLINT.

The newly attached journal receiver contains journal entries that will not have to be sent back to system JKLINT.

- f) After the operation is performed, the hot-backup application apply can be started on system JKLINT2 to start replaying changes to the data replica. The hot-backup application apply starts with the source system sending the newly attached journal receiver.

The following figure shows that JKLINT is preparing again assume the role of the primary system.

An important task for journal management is to swap journal receivers. You typically swap journal receivers when they reach their storage threshold. You can swap journal receivers either with IBM Navigator for i or with the Change Journal (CHGJRN) command. If you use system journal-receiver management, the system changes journal receivers for you.

Activating the replication of journal entries to a remote journal

In order to activate the replication of journal entries to a given remote journal, the following must be true:

Inactivating the replication of journal entries to a remote journal

When you end replication of journal entries to a remote journal, it is recommended that the replication of entries be ended from the source system whenever possible, rather than from the target system. Usually, ending replication from the target system for a remote journal is only necessary when the source system has failed, and the system has not ended the remote journal function.

Related reference

[Receive Journal Entry \(RCVJRNE\) command](#)

[Retrieve Journal Entries \(QjoRetrieveJournalEntries\) API](#)

Related information





[Scenario: Recovery for remote journaling](#)

This scenario describes a hot-backup environment in which the local system, JKLINT fails. It is necessary to restore the local system, and synchronize it with the remote system, JKLINT2.

Related information for journal management

Product manuals, IBM Redbooks, Web sites, and other information center topic collections contain information that relates to the Journal management topic. You can view or print any of the PDF files.







Manuals

- [AnyMail/400 Mail Server Framework Support](#)  (623 KB)
- [Performance Tools for IBM i](#)  (1.9 MB)
- [Simple Network Management Protocol \(SNMP\) Support](#)  (391 KB)
- [WebSphere® Development Studio: ILE C/C++ Programmer's Guide](#)  (2.1 MB)

IBM Redbooks

- [Striving for Optimal Journal Performance on DB2 Universal Database for iSeries](#)  (3.1 MB)

IBM Redbooks Technotes

- [Journaling - User ASPs versus the System ASP](#) 
- [*RMVINTENT: The preferred fork in the road for heavy journal traffic](#) 
- [Journaling - How many journals should I configure](#) 
- [Journal Receiver Diet Tip 1: Eliminating Open and Close Journal Entries](#) 
- [Soft Commit: Worth a try on IBM i5/OS v5r4](#) 
- [The Journal Recovery Count: Making it Count on IBM i5/OS](#) 

- [Journaling - How to View and More Easily Audit Minimized Journal Entries on The IBM System i Platform](#)



- [Journal Caching: Understanding the Risk of Data Loss](#)



- [Journal Standby Mode on IBM i5/OS: When it Makes Sense to Use](#)



- [Remote Journal on i5/OS - Are you Selecting the Right Type?](#)



- [Journaling - Unraveling the Mysteries of Sporadic Growth of Journal Receivers](#)



- [Journaling - Configuring Your Fair Share of Write Cache](#)



- [Journaling - Journal Receiver Diet Tip 2: Consider Using Skinny Headers](#)



- [Journaling at Object Creation with i5/OS v6r1m0](#)



- [Journaling - Why is My Logical File Journalled?](#)



- [Journaling - Using APYJRNCHG for Disaster Recovery](#)



- [Journaling - Common Remote Journal Questions](#)



Web sites

[DB2 for IBM i Coding examples](#) 

Other information

- [Backup and recovery](#)
- [CL programming](#)
- [OptiConnect for i5/OS](#)
- [Security Reference](#)
- [Work management](#)
- The IBM Publications Center at: <http://www.elink.ibm.link.ibm.com/publications/servlet/pbi.wss?>

Saving PDF files

To save a PDF on your workstation for viewing or printing:

1. Right-click the PDF in your browser (right-click the link above).
2. Click the option that saves the PDF locally.
3. Navigate to the directory in which you want to save the PDF.
4. Click **Save**.

Downloading Adobe Reader

You need Adobe Reader installed on your system to view or print these PDFs. You can download a free copy from the [Adobe Web site](http://get.adobe.com/reader/) (<http://get.adobe.com/reader/>) .

Code license and disclaimer information

IBM grants you a nonexclusive copyright license to use all programming code examples from which you can generate similar function tailored to your own specific needs.

SUBJECT TO ANY STATUTORY WARRANTIES WHICH CANNOT BE EXCLUDED, IBM, ITS PROGRAM DEVELOPERS AND SUPPLIERS MAKE NO WARRANTIES OR CONDITIONS EITHER EXPRESS OR IMPLIED, INCLUDING BUT NOT LIMITED TO, THE IMPLIED WARRANTIES OR CONDITIONS OF MERCHANTABILITY, FITNESS FOR A PARTICULAR PURPOSE, AND NON-INFRINGEMENT, REGARDING THE PROGRAM OR TECHNICAL SUPPORT, IF ANY.

UNDER NO CIRCUMSTANCES IS IBM, ITS PROGRAM DEVELOPERS OR SUPPLIERS LIABLE FOR ANY OF THE FOLLOWING, EVEN IF INFORMED OF THEIR POSSIBILITY:

1. LOSS OF, OR DAMAGE TO, DATA;
2. DIRECT, SPECIAL, INCIDENTAL, OR INDIRECT DAMAGES, OR FOR ANY ECONOMIC CONSEQUENTIAL DAMAGES; OR
3. LOST PROFITS, BUSINESS, REVENUE, GOODWILL, OR ANTICIPATED SAVINGS.

SOME JURISDICTIONS DO NOT ALLOW THE EXCLUSION OR LIMITATION OF DIRECT, INCIDENTAL, OR CONSEQUENTIAL DAMAGES, SO SOME OR ALL OF THE ABOVE LIMITATIONS OR EXCLUSIONS MAY NOT APPLY TO YOU.

Notices

This information was developed for products and services offered in the U.S.A.

IBM may not offer the products, services, or features discussed in this document in other countries. Consult your local IBM representative for information on the products and services currently available in your area. Any reference to an IBM product, program, or service is not intended to state or imply that only that IBM product, program, or service may be used. Any functionally equivalent product, program, or service that does not infringe any IBM intellectual property right may be used instead. However, it is the user's responsibility to evaluate and verify the operation of any non-IBM product, program, or service.

IBM may have patents or pending patent applications covering subject matter described in this document. The furnishing of this document does not grant you any license to these patents. You can send license inquiries, in writing, to:

IBM Director of Licensing
IBM Corporation
North Castle Drive
Armonk, NY 10504-1785
U.S.A.

For license inquiries regarding double-byte (DBCS) information, contact the IBM Intellectual Property Department in your country or send inquiries, in writing, to:

Intellectual Property Licensing
Legal and Intellectual Property Law
IBM Japan Ltd.
1623-14, Shimotsuruma, Yamato-shi
Kanagawa 242-8502 Japan

The following paragraph does not apply to the United Kingdom or any other country where such provisions are inconsistent with local law: INTERNATIONAL BUSINESS MACHINES CORPORATION PROVIDES THIS PUBLICATION "AS IS" WITHOUT WARRANTY OF ANY KIND, EITHER EXPRESS OR IMPLIED, INCLUDING, BUT NOT LIMITED TO, THE IMPLIED WARRANTIES OF NON-INFRINGEMENT, MERCHANTABILITY OR FITNESS FOR A PARTICULAR PURPOSE. Some states do not allow disclaimer of express or implied warranties in certain transactions, therefore, this statement may not apply to you.

This information could include technical inaccuracies or typographical errors. Changes are periodically made to the information herein; these changes will be incorporated in new editions of the publication. IBM may make improvements and/or changes in the product(s) and/or the program(s) described in this publication at any time without notice.

Any references in this information to non-IBM Web sites are provided for convenience only and do not in any manner serve as an endorsement of those Web sites. The materials at those Web sites are not part of the materials for this IBM product and use of those Web sites is at your own risk.

IBM may use or distribute any of the information you supply in any way it believes appropriate without incurring any obligation to you.

Licensees of this program who wish to have information about it for the purpose of enabling: (i) the exchange of information between independently created programs and other programs (including this one) and (ii) the mutual use of the information which has been exchanged, should contact:

IBM Corporation
Software Interoperability Coordinator, Department YBWA
3605 Highway 52 N
Rochester, MN 55901
U.S.A.

Such information may be available, subject to appropriate terms and conditions, including in some cases, payment of a fee.

The licensed program described in this document and all licensed material available for it are provided by IBM under terms of the IBM Customer Agreement, IBM International Program License Agreement or any equivalent agreement between us.

Any performance data contained herein was determined in a controlled environment. Therefore, the results obtained in other operating environments may vary significantly. Some measurements may have been made on development-level systems and there is no guarantee that these measurements will be the same on generally available systems. Furthermore, some measurements may have been estimated through extrapolation. Actual results may vary. Users of this document should verify the applicable data for their specific environment.

Information concerning non-IBM products was obtained from the suppliers of those products, their published announcements or other publicly available sources. IBM has not tested those products and cannot confirm the accuracy of performance, compatibility or any other claims related to non-IBM products. Questions on the capabilities of non-IBM products should be addressed to the suppliers of those products.

All statements regarding IBM's future direction or intent are subject to change or withdrawal without notice, and represent goals and objectives only.

This information is for planning purposes only. The information herein is subject to change before the products described become available.

This information contains examples of data and reports used in daily business operations. To illustrate them as completely as possible, the examples include the names of individuals, companies, brands, and products. All of these names are fictitious and any similarity to the names and addresses used by an actual business enterprise is entirely coincidental.

COPYRIGHT LICENSE:

This information contains sample application programs in source language, which illustrate programming techniques on various operating platforms. You may copy, modify, and distribute these sample programs in any form without payment to IBM, for the purposes of developing, using, marketing or distributing application programs conforming to the application programming interface for the operating platform for which the sample programs are written. These examples have not been thoroughly tested under all conditions. IBM, therefore, cannot guarantee or imply reliability, serviceability, or function of these programs. The sample programs are provided "AS IS", without warranty of any kind. IBM shall not be liable for any damages arising out of your use of the sample programs.

Each copy or any portion of these sample programs or any derivative work, must include a copyright notice as follows:

© (your company name) (year). Portions of this code are derived from IBM Corp. Sample Programs.

© Copyright IBM Corp. _enter the year or years_.

Programming interface information

This Journal management publication documents intended Programming Interfaces that allow the customer to write programs to obtain the services of IBM i.

Trademarks

IBM, the IBM logo, and ibm.com are trademarks or registered trademarks of International Business Machines Corp., registered in many jurisdictions worldwide. Other product and service names might be trademarks of IBM or other companies. A current list of IBM trademarks is available on the Web at "[Copyright and trademark information](http://www.ibm.com/legal/copytrade.shtml)" at www.ibm.com/legal/copytrade.shtml.

Adobe, the Adobe logo, PostScript, and the PostScript logo are either registered trademarks or trademarks of Adobe Systems Incorporated in the United States, and/or other countries.

Microsoft, Windows, Windows NT, and the Windows logo are trademarks of Microsoft Corporation in the United States, other countries, or both.

Java and all Java-based trademarks and logos are trademarks of Oracle, Inc. in the United States, other countries, or both.

Other product and service names might be trademarks of IBM or other companies.

Terms and conditions

Permissions for the use of these publications is granted subject to the following terms and conditions.

Personal Use: You may reproduce these publications for your personal, noncommercial use provided that all proprietary notices are preserved. You may not distribute, display or make derivative works of these publications, or any portion thereof, without the express consent of IBM.

Commercial Use: You may reproduce, distribute and display these publications solely within your enterprise provided that all proprietary notices are preserved. You may not make derivative works of these publications, or reproduce, distribute or display these publications or any portion thereof outside your enterprise, without the express consent of IBM.

Except as expressly granted in this permission, no other permissions, licenses or rights are granted, either express or implied, to the publications or any information, data, software or other intellectual property contained therein.

IBM reserves the right to withdraw the permissions granted herein whenever, in its discretion, the use of the publications is detrimental to its interest or, as determined by IBM, the above instructions are not being properly followed.

You may not download, export or re-export this information except in full compliance with all applicable laws and regulations, including all United States export laws and regulations.

IBM MAKES NO GUARANTEE ABOUT THE CONTENT OF THESE PUBLICATIONS. THE PUBLICATIONS ARE PROVIDED "AS-IS" AND WITHOUT WARRANTY OF ANY KIND, EITHER EXPRESSED OR IMPLIED, INCLUDING BUT NOT LIMITED TO IMPLIED WARRANTIES OF MERCHANTABILITY, NON-INFRINGEMENT, AND FITNESS FOR A PARTICULAR PURPOSE.



Product Number: 5770-SS1