

z/OS Communications Server



IP Network Print Facility

Version 2 Release 1

Note:

Before using this information and the product it supports, be sure to read the general information under “Notices” on page 189.

First Edition (September 2013)

This edition applies to version 2, release 1, modification 0 of z/OS (5650-ZOS), and to subsequent releases and modifications until otherwise indicated in new editions.

IBM welcomes your comments. You may send your comments to the following address.

International Business Machines Corporation
Attn: z/OS Communications Server Information Development
Department AKCA, Building 501
P.O. Box 12195, 3039 Cornwallis Road
Research Triangle Park, North Carolina 27709-2195

You can send us comments electronically by using one of the following methods:

Fax (USA and Canada):

1+919-254-1258

Send the fax to “Attn: z/OS Communications Server Information Development”

Internet email:

comsvrcf@us.ibm.com

World Wide Web:

<http://www.ibm.com/systems/z/os/zos/webqs.html>

If you would like a reply, be sure to include your name, address, telephone number, or FAX number. Make sure to include the following information in your comment or note:

- Title and order number of this document
- Page number or topic related to your comment

When you send information to IBM, you grant IBM a nonexclusive right to use or distribute the information in any way it believes appropriate without incurring any obligation to you.

© Copyright IBM Corporation 2000, 2013.

US Government Users Restricted Rights – Use, duplication or disclosure restricted by GSA ADP Schedule Contract with IBM Corp.

Contents

Figures	vii
Tables	ix
About this document	xi
How to use this document	xi
Determining whether a publication is current	xi
How to contact IBM service	xii
Conventions and terminology that are used in this document	xii
How to read a syntax diagram.	xiii
Prerequisite and related information	xvii
Summary of changes.	xxiii
Chapter 1. Introduction	1
Software requirements	1
Overview	1
Flow of Network Print Facility Processing	4
Print Data Processing	5
Network Print Facility interfaces with JES	6
Network Print Facility interfaces with VTAM	7
Specific concepts for processing VTAM output	8
Chapter 2. Planning for the Network Print Facility	11
Required skills	11
Required environment	11
Overall planning activities	11
JES planning considerations	12
VTAM Planning Considerations	13
Chapter 3. Customizing the Network Print Facility	15
Overall customization information.	15
Configuring NPF using TCPIP.DATA and NPF.DATA statements	16
TCPIP.DATA configuration	16
NPF.DATA configuration	17
NPFPRINTPREFIX statement	18
NPFxxxxALLOCATION statement.	19
NPFQMGRTHREAD statement.	20
NPFUNIT statement	21
Customization for JES output processing	22
Customizing JESNEWS	23
Defining the NPF FSS writer	23
Authorizing the NPF FSS writer load module	23
Determining where to print JES output	23
Defaults for JES output data.	24
Customization for VTAM output processing	24
Creating a startup procedure	25
Defining consistent resources	26
Modifying the program properties table	27
File definition for VTAM output	27
End-of-File definition	28
Installing the end-of-file table	29
References to the end-of-file table from the routing file	29
The structure of the end-of-file rules table (EZAPPEFT).	30

Defining end-of-file rules	30
EZAPPEFM TYPE=ENTRY	30
EZAPPEFM TYPE=PLU	32
EZAPPEFM TYPE=SYSDFLT	33
EZAPPEFM TYPE=END	34
End-of-file table example	34
Page format definition	37
Installing the page format table	37
References to the page format table from the routing file	38
Determining the default page format	38
The structure of the page format table (EZAPPPFT)	38
EZAPPPFT	38
Page format table examples	40
Chapter 4. Understanding the Network Print Facility files	43
The options file	43
Working with the options file	44
Options file input fields	44
The routing file	44
Working with the routing file	45
Routing file input fields	46
The queue file	47
Working with the queue file	47
The log file	48
The SNAP File for the VTAM capture point	48
The trace file	49
Chapter 5. Creating the Network Print Facility files	51
Generally initializing and loading procedures	51
Running the EZAPPFL macro	52
EZAPPFL TYPE=INITIAL	53
EZAPPFL TYPE=ROUTING	54
EZAPPFL TYPE=NXTDEST	59
EZAPPFL TYPE=OPTIONS	59
EZAPPFL TYPE=FINAL	61
Required parameters and default values for EZAPPFL	61
Sample NPF initialization jobs	62
Joint allocation of NPF VSAM files	62
Initialization of the NPF VSAM files	64
Adding records to the NPF VSAM files	66
Chapter 6. Maintaining the Network Print Facility files with ISPF	69
Enabling the Network Print Facility ISPF interface	69
Providing library access	69
Defining default data set names	70
Adding NPF to the ISPF primary option menu	74
Starting an NPF ISPF interface session	76
Helpful reminders	77
Setting the NPF ISPF defaults	78
Setting trace options	78
Maintaining the options file	79
Adding records to the options file	81
Copying records in the options file	82
Updating records in the options file	83
Deleting records from the options file	85
Maintaining the routing file	86
Adding records to the routing file	89
Adding specific broadcast destinations	91
Copying records in the routing file	92
Copying specific broadcast destinations	93

Updating records in the routing file	93
Updating specific broadcast destinations.	94
Deleting records from the routing file.	95
Deleting specific broadcast destinations	97
Managing the print queues	97
Working with the queue file.	98
Displaying the queue file.	99
Selecting a queue record.	100
Changing values in a queue record	102
Deleting queue records	103
Chapter 7. Writing exit routines to tailor the Network Print Facility	105
Two routing exits and one input record exit	106
Writing the general routing exit	106
Environment	107
Processing	107
Installing the exit	108
Input	108
Registers at entry	108
Parameter list contents	108
Return codes for the general routing exit	109
Output	109
Registers at exit	109
Writing the specific routing exit	109
Environment	110
Processing	110
Installing the exit	110
Input	110
Registers at entry	110
Parameter list contents	111
Return codes for the specific routing exit	111
Output	112
Registers at exit	112
Writing the input record exit	112
Environment	112
Processing	113
Installing the exit	115
Input	115
Registers at entry	115
Parameter list contents	116
Return codes for the input record exit	118
Output	118
Registers at exit	118
SPIN=GROUP restrictions	118
Input record exit to delete leading blank pages	119
The Routing Data Area (RDA).	122
Using the EZAPPFCD macro	122
Syntax.	123
Parameters	123
Chapter 8. Operating the Network Print Facility.	125
Operating the NPF FSS writer.	125
Creating the NPF FSS writer start procedure	126
Modifying the NPF FSS writer start procedure	127
Defining, starting, and stopping the NPF FSS writer	128
Operating the NPF VTAM capture point	131
Starting the NPF VTAM capture point	131
Modifying the NPF VTAM capture point	133
Stopping the NPF VTAM capture point.	136
Effects of VTAM HALT commands on the NPF VTAM capture point.	138

Operating the queue manager	138
Starting the NPF queue manager	138
Modifying the NPF queue manager	139
Stopping the NPF queue manager	141
Stopping the Network Print Facility	141
Chapter 9. Diagnosing Network Print Facility Problems	143
NPF FSS writer return codes	143
List of common problems and suggested solutions	143
Network Print Facility tracing	144
Using the NPF ISPF trace facility	144
Using the queue manager trace	145
Using the VTAM capture point trace	145
Network Print Facility logging	145
Generation of the print data set names	146
SNA sense codes used by the NPF VTAM capture point	146
Appendix A. Checklists for using the Network Print Facility	149
Checklist of the NPF tasks for all users (JES or VTAM)	149
Checklist of the NPF tasks for VTAM users	150
Checklist of the NPF tasks for JES users	152
Appendix B. Network Print Facility's Routing Data Area (RDA)	153
DSECT for routing data area	156
Appendix C. Sample NPF FSS writer definitions	157
Appendix D. The SCS printer emulator	159
Appendix E. Related protocol specifications	161
Appendix F. Accessibility	185
Notices	189
Policy for unsupported hardware.	197
Trademarks	197
Bibliography.	199
Index	203
Communicating your comments to IBM	209

Figures

1.	Flow of Network Print Facility processing.	4
2.	NPF JES elements	7
3.	NPF.DATA sample	18
4.	Example of an End-of-File table	35
5.	Example of EZAPDPDF macro use	41
6.	Sample of options file allocation	44
7.	Sample of routing file allocation	46
8.	Sample of queue file allocation	48
9.	TSO logon procedure	70
10.	ISPF primary option menu ISR@PRIM (Part 1 - menu section)	74
11.	ISPF primary option menu ISR@PRIM (Part 2a.- processing section).	75
12.	ISPF primary option menu ISR@PRIM (Part 2b.- processing section)	76
13.	Network Print Facility Primary Option Menu (EZAPPMP)	77
14.	NPF ISPF Defaults (EZAPPDCP)	78
15.	NPF Diagnosis Functions (EZAPPDGP)	79
16.	NPF Printer Options Configuration (EZAPPOCP)	80
17.	NPF Options Record Key Field Panel (EZAPPN1)	81
18.	NPF Options Record Panel (EZAPPN7)	82
19.	NPF options record key field copy panel (EZAPPN4)	83
20.	NPF options record panel (EZAPPN7)	83
21.	NPF options record key field edit panel (EZAPPN1)	84
22.	NPF options record edit panel (EZAPPN7)	85
23.	NPF options record key field panel (EZAPPN1)	86
24.	NPF options record panel (EZAPPN7)	86
25.	NPF printer routing configuration panel (EZAPPRCP)	87
26.	NPF routing file record key field panel (EZAPPN9)	89
27.	NPF routing record panel (EZAPPN15)	90
28.	NPF routing broadcast record panel (EZAPPN23)	91
29.	NPF routing file record key field copy panel (EZAPPN12)	92
30.	NPF routing record panel (EZAPPN15)	93
31.	NPF routing record key field edit panel (EZAPPN9)	94
32.	NPF routing record edit panel (EZAPPN15)	94
33.	NPF routing broadcast record edit panel (EZAPPN23)	95
34.	Routing file record key field delete panel (EZAPPN9)	96
35.	NPF routing record delete panel (EZAPPN15)	96
36.	NPF queue selection panel (EZAPPQSP)	100
37.	NPF queue list (EZAPPQLP) in KEY sequence	101
38.	NPF queue list (EZAPPQLP) in TIME sequence	101
39.	NPF queue record (EZAPPQRP)	103
40.	Input exit record parameter list	118
41.	NPF FSS writer return codes	143
42.	DSECT for routing data area	156
43.	FSS writer definition sample for JES2 version 4 and 5	157
44.	FSS writer definition sample for JES3 version 4	158

Tables

1.	Network Print Facility implementation Tasks	xi
2.	VTAM BIND parameter requirements	8
3.	JES data limitations	24
4.	Option file record input fields	44
5.	Routing file record input fields	46
6.	EZAPPF macro parameters and defaults	61
7.	The NPF option file functions	80
8.	Option file ISPF input fields	80
9.	The NPF routing file functions	87
10.	Routing file ISPF input fields	88
11.	Queue file ISPF fields	98
12.	Network Print Facility user exits	105
13.	Defining, starting, and stopping the NPF FSS writer	129
14.	List of common problems for general Network Print Facility processing	143
15.	List of common problems for processing JES output	144
16.	SCS code points.	159

About this document

This book describes how to plan for, customize, and use the Network Print Facility (NPF) in Transmission Control Protocol/Internet Protocol (TCP/IP) networks.

This document is for system programmers and network administrators who need to prepare their network to route VTAM[®], JES2, or JES3 printer output to remote printers .

You should be familiar with either JES or VTAM or both, to use this document.

You must perform several tasks to benefit from the Network Print Facility. The following table shows where you can find information on each of the tasks required. When information is located in a book other than this one, the title is noted.

Table 1. Network Print Facility implementation Tasks

For This Task:	See This Information in This Book:
Planning for the Network Print Facility	See Chapter 2, "Planning for the Network Print Facility," on page 11.
Installing the Network Print Facility	Installation appears in the z/OS Program Directory
Configuring the Network Print Facility	See Chapter 3, "Customizing the Network Print Facility," on page 15.
Learning about the NPF files	See Chapter 4, "Understanding the Network Print Facility files," on page 43.
Using macros to initialize and load the files	See Chapter 5, "Creating the Network Print Facility files," on page 51.
Using the Network Print Facility panels to maintain the files and manage the print queues	See Chapter 6, "Maintaining the Network Print Facility files with ISPF," on page 69.
Writing user exits to customize the Network Print Facility	See Chapter 7, "Writing exit routines to tailor the Network Print Facility," on page 105.
Starting, operating, and stopping the Network Print Facility	See Chapter 8, "Operating the Network Print Facility," on page 125.
Diagnosing Network Print Facility problems	See Chapter 9, "Diagnosing Network Print Facility Problems," on page 143. Messages and codes appear in z/OS Communications Server: IP Messages Volume 1 (EZA).

How to use this document

To use this document, you should be familiar with z/OS[®] TCP/IP Services and the TCP/IP suite of protocols.

Determining whether a publication is current

As needed, IBM[®] updates its publications with new and changed information. For a given publication, updates to the hardcopy and associated BookManager[®] softcopy are usually available at the same time. Sometimes, however, the updates

to hardcopy and softcopy are available at different times. The following information describes how to determine if you are looking at the most current copy of a publication:

- At the end of a publication's order number there is a dash followed by two digits, often referred to as the dash level. A publication with a higher dash level is more current than one with a lower dash level. For example, in the publication order number GC28-1747-07, the dash level 07 means that the publication is more current than previous levels, such as 05 or 04.
- If a hardcopy publication and a softcopy publication have the same dash level, it is possible that the softcopy publication is more current than the hardcopy publication. Check the dates shown in the Summary of Changes. The softcopy publication might have a more recently dated Summary of Changes than the hardcopy publication.
- To compare softcopy publications, you can check the last 2 characters of the publication's file name (also called the book name). The higher the number, the more recent the publication. Also, next to the publication titles in the CD-ROM booklet and the readme files, there is an asterisk (*) that indicates whether a publication is new or changed.

How to contact IBM service

For immediate assistance, visit this website: <http://www.software.ibm.com/network/commsserver/support/>

Most problems can be resolved at this website, where you can submit questions and problem reports electronically, and access a variety of diagnosis information.

For telephone assistance in problem diagnosis and resolution (in the United States or Puerto Rico), call the IBM Software Support Center anytime (1-800-IBM-SERV). You will receive a return call within 8 business hours (Monday – Friday, 8:00 a.m. – 5:00 p.m., local customer time).

Outside the United States or Puerto Rico, contact your local IBM representative or your authorized IBM supplier.

If you would like to provide feedback on this publication, see “Communicating your comments to IBM” on page 209.

Conventions and terminology that are used in this document

Commands in this book that can be used in both TSO and z/OS UNIX environments use the following conventions:

- When describing how to use the command in a TSO environment, the command is presented in uppercase (for example, NETSTAT).
- When describing how to use the command in a z/OS UNIX environment, the command is presented in bold lowercase (for example, **netstat**).
- When referring to the command in a general way in text, the command is presented with an initial capital letter (for example, Netstat).

All the exit routines described in this document are *installation-wide exit routines*. The installation-wide exit routines also called installation-wide exits, exit routines, and exits throughout this document.

The TPF logon manager, although included with VTAM, is an application program; therefore, the logon manager is documented separately from VTAM.

Samples used in this book might not be updated for each release. Evaluate a sample carefully before applying it to your system.

Note: In this information, you might see the term RDMA network interface card (RNIC) that is used to refer to the IBM 10GbE RoCE Express feature.

For definitions of the terms and abbreviations that are used in this document, you can view the latest IBM terminology at the IBM Terminology website.

Clarification of notes

Information traditionally qualified as Notes is further qualified as follows:

Note Supplemental detail

Tip Offers shortcuts or alternative ways of performing an action; a hint

Guideline

Customary way to perform a procedure

Rule Something you must do; limitations on your actions

Restriction

Indicates certain conditions are not supported; limitations on a product or facility

Requirement

Dependencies, prerequisites

Result Indicates the outcome

How to read a syntax diagram

This syntax information applies to all commands and statements that do not have their own syntax described elsewhere.

The syntax diagram shows you how to specify a command so that the operating system can correctly interpret what you type. Read the syntax diagram from left to right and from top to bottom, following the horizontal line (the main path).

Symbols and punctuation

The following symbols are used in syntax diagrams:

Symbol

Description

- ▶▶ Marks the beginning of the command syntax.
- ▶ Indicates that the command syntax is continued.
- | Marks the beginning and end of a fragment or part of the command syntax.
- ◀◀ Marks the end of the command syntax.

You must include all punctuation such as colons, semicolons, commas, quotation marks, and minus signs that are shown in the syntax diagram.

Commands

Commands that can be used in both TSO and z/OS UNIX environments use the following conventions in syntax diagrams:

- When describing how to use the command in a TSO environment, the command is presented in uppercase (for example, NETSTAT).
- When describing how to use the command in a z/OS UNIX environment, the command is presented in bold lowercase (for example, netstat).

Parameters

The following types of parameters are used in syntax diagrams.

Required

Required parameters are displayed on the main path.

Optional

Optional parameters are displayed below the main path.

Default

Default parameters are displayed above the main path.

Parameters are classified as keywords or variables. For the TSO and MVS™ console commands, the keywords are not case sensitive. You can code them in uppercase or lowercase. If the keyword appears in the syntax diagram in both uppercase and lowercase, the uppercase portion is the abbreviation for the keyword (for example, OPERand).

For the z/OS UNIX commands, the keywords must be entered in the case indicated in the syntax diagram.

Variables are italicized, appear in lowercase letters, and represent names or values you supply. For example, a data set is a variable.

Syntax examples

In the following example, the PUt subcommand is a keyword. The required variable parameter is *local_file*, and the optional variable parameter is *foreign_file*. Replace the variable parameters with your own values.

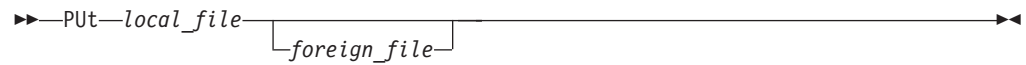

Longer than one line

If a diagram is longer than one line, the first line ends with a single arrowhead and the second line begins with a single arrowhead.

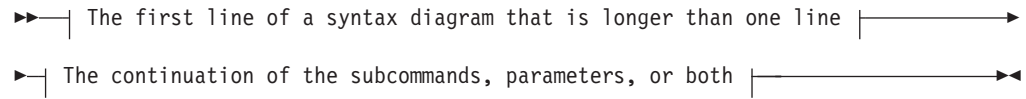

Required operands

Required operands and values appear on the main path line. You must code required operands and values.

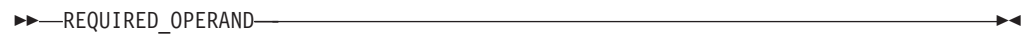

Optional values

Optional operands and values appear below the main path line. You do not have to code optional operands and values.

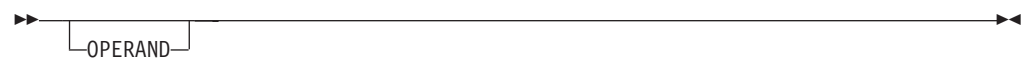

Selecting more than one operand

An arrow returning to the left above a group of operands or values means more than one can be selected, or a single one can be repeated.

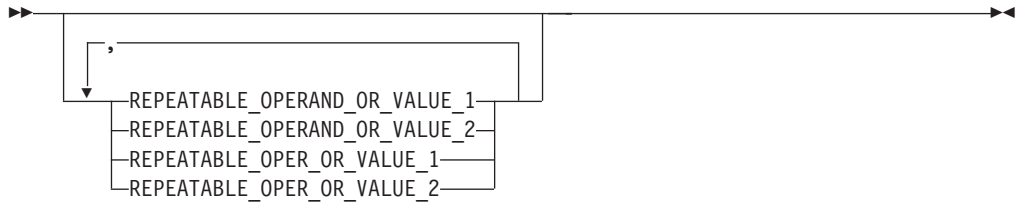

Nonalphanumeric characters

If a diagram shows a character that is not alphanumeric (such as parentheses, periods, commas, and equal signs), you must code the character as part of the syntax. In this example, you must code OPERAND=(001,0.001).

▶▶—OPERAND—==(—001—,—0.001—)—▶▶

Blank spaces in syntax diagrams

If a diagram shows a blank space, you must code the blank space as part of the syntax. In this example, you must code OPERAND=(001 FIXED).

▶▶—OPERAND—==(—001— —FIXED—)—▶▶

Default operands

Default operands and values appear above the main path line. TCP/IP uses the default if you omit the operand entirely.



Variables

A word in all lowercase italics is a *variable*. Where you see a variable in the syntax, you must replace it with one of its allowable names or values, as defined in the text.



Syntax fragments

Some diagrams contain syntax fragments, which serve to break up diagrams that are too long, too complex, or too repetitious. Syntax fragment names are in mixed case and are shown in the diagram and in the heading of the fragment. The fragment is placed below the main diagram.



Syntax fragment:



Prerequisite and related information

z/OS Communications Server function is described in the z/OS Communications Server library. Descriptions of those documents are listed in “Bibliography” on page 199, in the back of this document.

Required information

Before using this product, you should be familiar with TCP/IP, VTAM, MVS, and UNIX System Services.

Softcopy information

Softcopy publications are available in the following collection.

Titles	Order Number	Description
<i>IBM System z® Redbooks Collection</i>	SK3T-7876	The IBM Redbooks® publications selected for this CD series are taken from the IBM Redbooks inventory of over 800 books. All the Redbooks publications that are of interest to the zSeries® platform professional are identified by their authors and are included in this collection. The zSeries subject areas range from e-business application development and enablement to hardware, networking, Linux, solutions, security, parallel sysplex, and many others. For more information about the Redbooks publications, see http://www-03.ibm.com/systems/z/os/zos/zfavorites/ .

Other documents

This information explains how z/OS references information in other documents.

When possible, this information uses cross-document links that go directly to the topic in reference using shortened versions of the document title. For complete titles and order numbers of the documents for all products that are part of z/OS, see z/OS Information Roadmap (SA23-2299). The Roadmap describes what level of documents are supplied with each release of z/OS Communications Server, and also describes each z/OS publication.

To find the complete z/OS library, including the z/OS Information Center, see www.ibm.com/systems/z/os/zos/bkserv/.

Relevant RFCs are listed in an appendix of the IP documents. Architectural specifications for the SNA protocol are listed in an appendix of the SNA documents.

The following table lists documents that might be helpful to readers.

Title	Number
<i>DNS and BIND</i> , Fifth Edition, O'Reilly Media, 2006	ISBN 13: 978-0596100575
<i>Routing in the Internet</i> , Second Edition, Christian Huitema (Prentice Hall 1999)	ISBN 13: 978-0130226471
<i>sendmail</i> , Fourth Edition, Bryan Costales, Claus Assmann, George Jansen, and Gregory Shapiro, O'Reilly Media, 2007	ISBN 13: 978-0596510299
<i>SNA Formats</i>	GA27-3136
<i>TCP/IP Illustrated, Volume 1: The Protocols</i> , W. Richard Stevens, Addison-Wesley Professional, 1994	ISBN 13: 978-0201633467
<i>TCP/IP Illustrated, Volume 2: The Implementation</i> , Gary R. Wright and W. Richard Stevens, Addison-Wesley Professional, 1995	ISBN 13: 978-0201633542
<i>TCP/IP Illustrated, Volume 3: TCP for Transactions, HTTP, NNTP, and the UNIX Domain Protocols</i> , W. Richard Stevens, Addison-Wesley Professional, 1996	ISBN 13: 978-0201634952
<i>TCP/IP Tutorial and Technical Overview</i>	GG24-3376
<i>Understanding LDAP</i>	SG24-4986
z/OS Cryptographic Services System SSL Programming	SC24-5901
z/OS IBM Tivoli Directory Server Administration and Use for z/OS	SC23-6788
z/OS JES2 Initialization and Tuning Guide	SA32-0991
z/OS Problem Management	SC23-6844
z/OS MVS Diagnosis: Reference	GA32-0904
z/OS MVS Diagnosis: Tools and Service Aids	GA32-0905
z/OS MVS Using the Subsystem Interface	SA38-0679
z/OS Program Directory	GI11-9848
z/OS UNIX System Services Command Reference	SA23-2280
z/OS UNIX System Services Planning	GA32-0884
z/OS UNIX System Services Programming: Assembler Callable Services Reference	SA23-2281
z/OS UNIX System Services User's Guide	SA23-2279
z/OS XL C/C++ Runtime Library Reference	SC14-7314
zEnterprise 196, System z10, System z9 and eServer zSeries OSA-Express Customer's Guide and Reference	SA22-7935

Redbooks publications

The following Redbooks publications might help you as you implement z/OS Communications Server.

Title	Number
<i>IBM z/OS V1R13 Communications Server TCP/IP Implementation, Volume 1: Base Functions, Connectivity, and Routing</i>	SG24-7996
<i>IBM z/OS V1R13 Communications Server TCP/IP Implementation, Volume 2: Standard Applications</i>	SG24-7997
<i>IBM z/OS V1R13 Communications Server TCP/IP Implementation, Volume 3: High Availability, Scalability, and Performance</i>	SG24-7998
<i>IBM z/OS V1R13 Communications Server TCP/IP Implementation, Volume 4: Security and Policy-Based Networking</i>	SG24-7999
<i>IBM Communication Controller Migration Guide</i>	SG24-6298
<i>IP Network Design Guide</i>	SG24-2580
<i>Managing OS/390[®] TCP/IP with SNMP</i>	SG24-5866
<i>Migrating Subarea Networks to an IP Infrastructure Using Enterprise Extender</i>	SG24-5957
<i>SecureWay Communications Server for OS/390 V2R8 TCP/IP: Guide to Enhancements</i>	SG24-5631
<i>SNA and TCP/IP Integration</i>	SG24-5291
<i>TCP/IP in a Sysplex</i>	SG24-5235
<i>TCP/IP Tutorial and Technical Overview</i>	GG24-3376
<i>Threadsafe Considerations for CICS</i>	SG24-6351

Where to find related information on the Internet

z/OS

This site provides information about z/OS Communications Server release availability, migration information, downloads, and links to information about z/OS technology

<http://www.ibm.com/systems/z/os/zos/>

z/OS Internet Library

Use this site to view and download z/OS Communications Server documentation

www.ibm.com/systems/z/os/zos/bkserv/

IBM Communications Server product

The primary home page for information about z/OS Communications Server

<http://www.software.ibm.com/network/commserver/>

IBM Communications Server product support

Use this site to submit and track problems and search the z/OS Communications Server knowledge base for Technotes, FAQs, white papers, and other z/OS Communications Server information

<http://www.software.ibm.com/network/commserver/support/>

IBM Communications Server performance information

This site contains links to the most recent Communications Server performance reports.

<http://www.ibm.com/support/docview.wss?uid=swg27005524>

IBM Systems Center publications

Use this site to view and order Redbooks publications, Redpapers™, and Technotes

<http://www.redbooks.ibm.com/>

IBM Systems Center flashes

Search the Technical Sales Library for Techdocs (including Flashes, presentations, Technotes, FAQs, white papers, Customer Support Plans, and Skills Transfer information)

<http://www.ibm.com/support/techdocs/atmastr.nsf>

RFCs

Search for and view Request for Comments documents in this section of the Internet Engineering Task Force website, with links to the RFC repository and the IETF Working Groups web page

<http://www.ietf.org/rfc.html>

Internet drafts

View Internet-Drafts, which are working documents of the Internet Engineering Task Force (IETF) and other groups, in this section of the Internet Engineering Task Force website

<http://www.ietf.org/ID.html>

Information about web addresses can also be found in information APAR III1334.

Note: Any pointers in this publication to websites are provided for convenience only and do not serve as an endorsement of these websites.

DNS websites

For more information about DNS, see the following USENET news groups and mailing addresses:

USENET news groups

`comp.protocols.dns.bind`

BIND mailing lists

<https://lists.isc.org/mailman/listinfo>

BIND Users

- Subscribe by sending mail to `bind-users-request@isc.org`.
- Submit questions or answers to this forum by sending mail to `bind-users@isc.org`.

BIND 9 Users (This list might not be maintained indefinitely.)

- Subscribe by sending mail to `bind9-users-request@isc.org`.
- Submit questions or answers to this forum by sending mail to `bind9-users@isc.org`.

The z/OS Basic Skills Information Center

The z/OS Basic Skills Information Center is a web-based information resource intended to help users learn the basic concepts of z/OS, the operating system that runs most of the IBM mainframe computers in use today. The Information Center is designed to introduce a new generation of Information Technology professionals to basic concepts and help them prepare for a career as a z/OS professional, such as a z/OS systems programmer.

Specifically, the z/OS Basic Skills Information Center is intended to achieve the following objectives:

- Provide basic education and information about z/OS without charge
- Shorten the time it takes for people to become productive on the mainframe
- Make it easier for new people to learn z/OS

To access the z/OS Basic Skills Information Center, open your web browser to the following website, which is available to all users (no login required):
<http://publib.boulder.ibm.com/infocenter/zos/basics/index.jsp>

Summary of changes

This section describes the release enhancements that were made.

New in z/OS Version 2 Release 1

For specifics on the enhancements for z/OS Version 2, Release 1, see the following publications:

- z/OS Summary of Message and Interface Changes
- z/OS Introduction and Release Guide
- z/OS Planning for Installation
- z/OS Migration

Chapter 1. Introduction

The Network Print Facility (NPF) is a separately orderable feature of z/OS Communications Server. The Network Print Facility routes JES or VTAM print data from your MVS system to printers in the TCP/IP network.

Software requirements

In addition to the base operating system requirements for TCP/IP for V3R2, Network Print Facility requires software for certain environments.

To do any printing that requires a conversion of host names to IP addresses, the Network Print Facility requires:

- IBM C/370™ V2.2, or LE/370 V1.3 or higher, C run-time libraries

To process VTAM print data, the Network Print Facility requires VTAM 3.4.2 or higher.

To process JES print data, the Network Print Facility requires:

- JES2 SP Version 4 or higher
- JES3 4.2.1 or higher with APAR OY50274

To process JES print data with LRECL greater than 4088 bytes, the Network Print Facility requires:

- JES2 V4 or later with APARs OW07587 and OW07588
- JES3 V4.2.1 or later with APARs OW07588 and OW07589

To use the NPF ISPF panel interface, the Network Print Facility requires:

- ISPF 3.5 or higher
- IBM C/370 V2.2, or LE/370 V1.3 or higher, C run-time libraries

Overview

The Network Print Facility lets you print data from your z/OS system on remote printers accessible through IBM IP Services. The Network Print Facility supports the printing of the following types of output:

- JES2 output
- JES3 output
- VTAM SNA character string (SCS) output over LU type 1 sessions
- VTAM 3270 data stream output over LU type 3 and LU type 0 sessions

The Network Print Facility accomplishes this by transforming VTAM or JES output print data into a format that existing LPD functions can process.

The Network Print Facility lets you decide *where* and *how* output will be printed through the use of a routing file and options file. The *where* portion is defined by the routing file. The *how* portion is defined through LPR options in the options file and through other data in the routing file.

The Network Print Facility allows user exits for installation-defined routing decisions or data modifications. It also provides a queue manager program to control the initial sending of each print job, retries of failed print jobs, and deletion of print data sets after a user-specified retention time.

The Network Print Facility incorporates the following functions:

- For communication with printers in the TCP/IP network, the Network Print Facility uses the protocol defined in Request for Comment (RFC) 1179 and amendments.
 - The Line Printer Daemon (LPD) is the remote print server defined by this protocol. The LPD can have queuing capability, in which case it performs as a print spooling mechanism and a print driver.

In this book, the term LPD refers to any print server which observes this protocol; it is not meant to imply any specific product implementation.
 - The Line Printer Requestor (LPR) is the client defined by this protocol. LPR code within the Network Print Facility manages the communication between the MVS system and the LPD.

The Network Print Facility supports the same options as TCP/IP's LPR command, including translation. For more detail, see the LPR options described in the *z/OS Communications Server: IP User's Guide* and *Commands* and the translation tables topic in *z/OS Communications Server: IP Configuration Guide*.
- Two capture points allow the printing of data from either JES or VTAM:
 - For JES, an FSS writer for which the network administrator must specify one or more output classes. Output queued under any of those specified classes is routed by JES to the NPF FSS writer, which then prepares it for transmission to the LPD server.
 - For VTAM, a VTAM capture point application program, which does processing for one or more logical printers. Each logical printer emulates a real SNA-network printer, supporting SNA character string (SCS) data streams over an LU type-1 session or 3270 data streams over an LU type-3 or LU type-0 session. For more information about SCS and 3270 data streams, see *SNA - Sessions Between Logical Units* and the *3270 Information Display System Data Stream Programmer's Reference*.

An application with data to print (usually CICS® or IMS™) must first start a session with a logical printer in the NPF VTAM capture point application. When print data is received over that session, NPF then prepares it for transmission to the LPD server.

On the session, the NPF logical printer always acts as the secondary LU (SLU), and the application sending the print data acts as the primary LU (PLU). In this book, the sender of the print data will often be referred to as the **session partner LU**.
- A combination of internet name or IP address and printer name allow routing of print data within the TCP/IP network. Because this information is not provided by MVS applications that use JES or VTAM to print data, the Network Print Facility provides a routing mechanism. The routing mechanism uses a combination of files and optional user exits to derive the internet name or IP address and printer name from data provided by MVS.

The internet routings and print functions are determined in either of 2 ways or by a combination of the 2:

 1. Routing and options files created by the network administrator.

These files provide information for routing and printing based on the following subsystems:

VTAM

logical printer name

JES Class, destination, and forms (JCL parameters CLASS, DEST, FORMS)

This information is used to build the key used to access the routing file. (These keys are referred to as major and minor names. Definitions for these names are within the parameter descriptions in "EZAPPFL TYPE=ROUTING" on page 54.) The routing file in turn contains the key of a record in the options file. Between the 2 records, the system constructs a routing data area, which contains both routing information and printing options. This routing data area is used to determine the actual printer destination.

2. User exits

The Network Print Facility provides for user-written exits that can either replace the functions of the routing and options files or augment the information found therein.

- The optional general routing exit (user-supplied), invoked prior to the retrieval of the routing record from the routing file, can replace the routing file function by creating the routing data area, or it can alter the key used to access the routing file.
- The optional specific routing exit (user-supplied), invoked after the retrieval of the routing record or the invocation of the general routing exit, can alter the routing data area, including the internet name or IP address and the printer name.
- The optional input record exit (user-supplied), invoked as each print record is processed to modify the print data stream (its principal purpose), can also modify the routing data area based on information found within the print stream.

Each user exit is described in Chapter 7, "Writing exit routines to tailor the Network Print Facility," on page 105.

- The Network Print Facility's file creation macro and an ISPF interface can be used to build the routing and options files. See Chapter 5, "Creating the Network Print Facility files," on page 51 and Chapter 6, "Maintaining the Network Print Facility files with ISPF," on page 69 for more detail.
- For each individual print job, the Network Print Facility creates a sequential print data set and adds a corresponding record to its queue file. The queue file record keeps track of the print data set's name and status, along with the processing rules copied from the routing data area. The Network Print Facility's queue manager periodically scans the queue file and performs actions such as initial send attempts, retries, retention or deletion on files as required. The ISPF panel interface can be used to display or modify queue file record data.
- The Network Print Facility normally uses multiple address spaces.

For each of the following types of applications within NPF, there can be 0, 1, or multiple instances of the application running at any given time, and each instance of the application is a separately started MVS job or procedure running in its own address space:

- The VTAM capture point application
- The FSS writer acting as the JES capture point
- The queue manager

In addition, a TSO/E user authorized to use the Network Print Facility ISPF interface will require his own address space.

Flow of Network Print Facility Processing

Network Print Facility processing is illustrated in Figure 1, which contains numbered boxes that correlate to the numbered items in the list below.

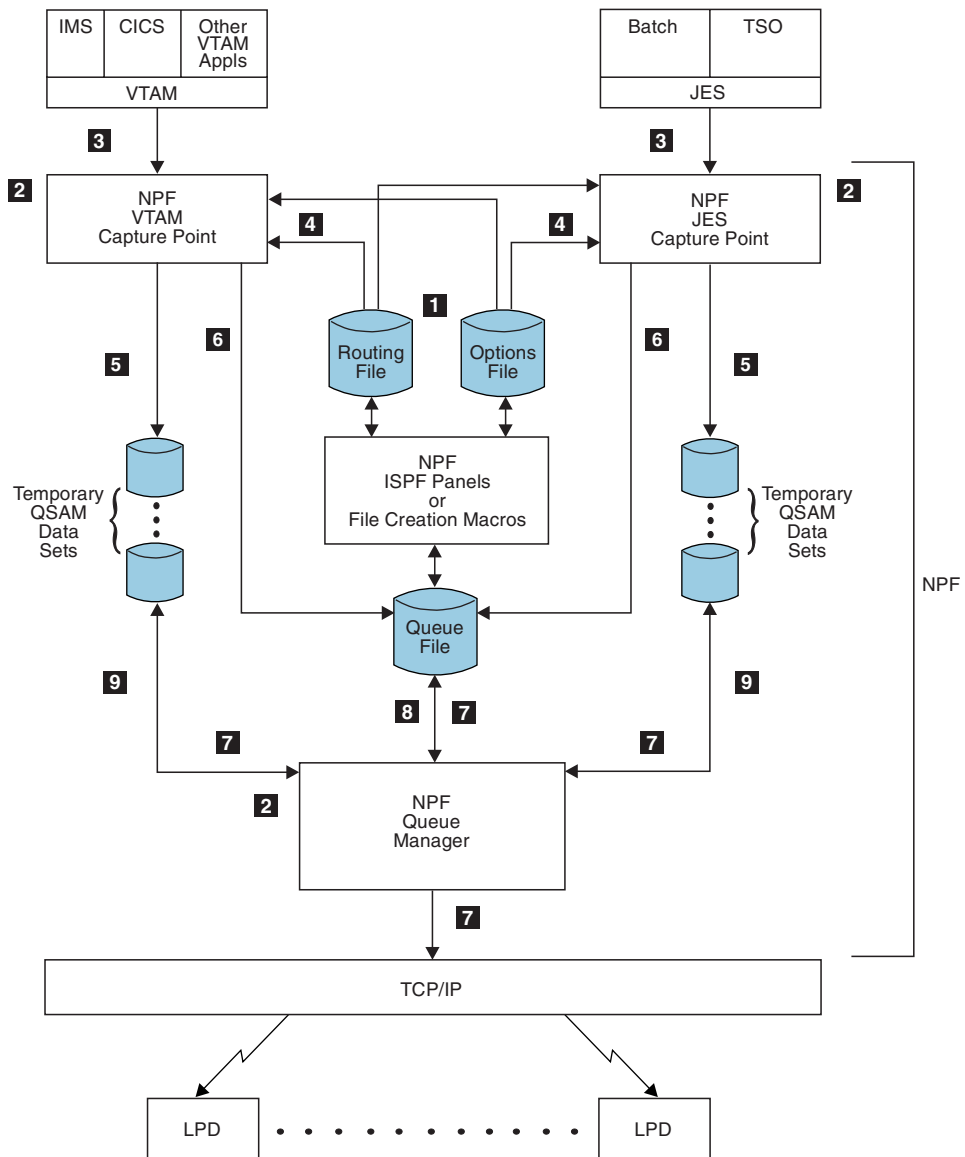

Figure 1. Flow of Network Print Facility processing

The system administrator creates routing and options files using the macros provided by Network Print Facility. These files can be modified through the use of the ISPF interface, after the initial loading. The macros and the ISPF panel interface, or both, can also be used to add data to the files.

The operator starts the Network Print Facility JES or VTAM capture point application and starts the queue manager.

For each print job, the Network Print Facility receives output through either the JES or VTAM capture point application.

The Network Print Facility obtains the necessary routing and options file information for the output. The routing can be to a single printer (a normal routing) or to multiple printers of the same type (a specific broadcast routing). Users can supply general routing or specific routing exits to alter the routing of print output.

The Network Print Facility creates a sequential print data set from the output received. Users can supply an input record exit to alter the print output before it is queued in this data set.

The Network Print Facility adds a record to the queue file for each location at which the print data set is to be printed. The queue file record contains information from the routing and options files in addition to the name and status of the print data set.

If multiple print jobs are waiting to go to the same printer, the NPF queue manager processes them in FIFO (First In, First Out) order. When it is time to send a particular print job, the queue manager uses information from the queue file to forward the queued data set to LPD services for printing.

Based on the return code from LPD and information in the queue file record, the NPF queue manager handles the queue record in one of the following ways:

- Keeps it to force the retry of an unsuccessful transmission.
- Keeps it for a user-specified retain time after a successful transmission or after all retries have been exhausted for an unsuccessful transmission.
- Erases it if no retry or retain time is indicated.

The NPF queue manager deletes the print data set after the last queue file record referring to it has been erased. For more details about queue manager processing, see “Managing the print queues” on page 97.

Print Data Processing

Within NPF, print data can be transformed at three different points in the flow. These transformations occur in the following order:

- VTAM only - The SCS or 3270 data stream received from the session partner LU is converted into a series of variable-length print records, each starting with an ASA carriage-control character.
- JES or VTAM - If the user has provided an input record exit, that exit is given the opportunity to modify each print record before it is queued.
- JES or VTAM - Prior to transmission to LPD, the print data set can be transformed as directed by user-specified LPR options. The same transformations available via the stand-alone LPR command can be used within the Network Print Facility, including the following information:
 - Translation
 - PostScript** output
 - Page header support

Network Print Facility interfaces with JES

An application generating print data is designed for a specific print environment, so an MVS application printing through JES spools might expect to create a print file having 132 alphanumeric character line width using ASA control characters for forms control. Or, it might create a print file a page at a time using graphic symbols. The application is generally unaware of JES or its functions, at least from a programming perspective. The person who defines the run-time environment for applications producing print for JES distribution is more aware of JES specifying such parameters as CLASS, FORMS, and DEST in the JCL.

The Network Print Facility capture point for JES appears to the application as a printer through the use of a special FSS writer as a part of the Network Print Facility. Certain definitions will aid further explanation:

FSI The Functional Subsystem Interface (FSI). This MVS interface allows communication between JES and your functional subsystem and functional subsystem application. This interface is what the Network Print Facility uses to communicate with MVS and JES to process JES output.

FSS The Functional Subsystem. This MVS subsystem is a collection of programs in an address space separate from JES that provides a JES-related function, such as print processing. An FSS extends the scope of JES processing.

Writer A JES function that processes print output.

NPF FSS writer

The special writer, part of the Network Print Facility, that you define to capture JES output. Each runs in a separate address space.

FSA A functional subsystem application is a collection of programs in the FSS address space that control one device.

NPF FSA subtask

The FSA subtask that the Network Print Facility uses to control each logical printer. One or more of these can run under each NPF FSS writer you establish.

NPF JES logical printer

There is a one-to-one correlation between the NPF JES logical printer and each FSA subtask.

LPD print queue

The LPD print queue on a host system that prints the output that has been transferred through each of the above.

This NPF FSS writer interfaces with JES in the following ways:

- At NPF FSS writer startup and initialization
- Accepting notification from JES that there is a print spool data set available for processing
- Using the MVS FSI to retrieve the print spool data set from the JES queue.
- Processing the data set; sending it forward from the FSA subtask through the NPF JES logical printer and eventually to a QSAM print data set pointed to by a queue file record.

Figure 2 on page 7 illustrates the relationship of the NPF FSS writer, the FSA subtask, and the logical printers.

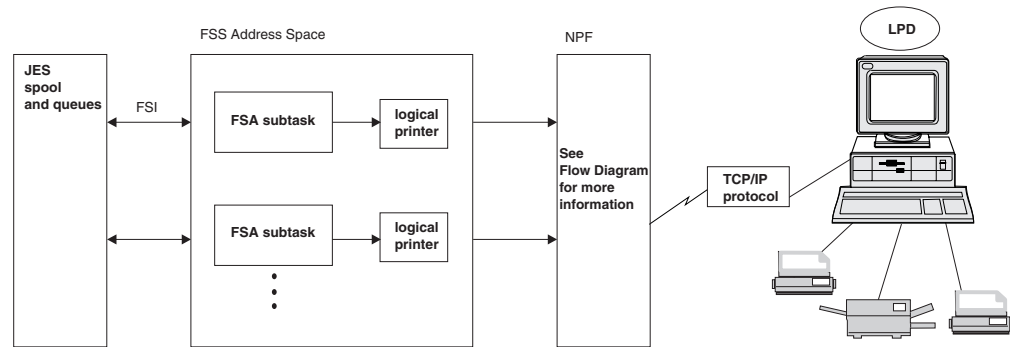

Figure 2. NPF JES elements

As illustrated in Figure 2, the Network Print Facility FSS writer uses the Functional Subsystem Interface (FSI) to communicate with MVS and JES. It communicates with MVS JES to receive output data sets (SYSOUT) from JES spool and write the data into a file for transmission to LPD.

Network Print Facility interfaces with VTAM

To do printing, a VTAM application program typically starts a session with a printer in its SNA network and sends the print data during that session. The Network Print Facility replaces the SNA-network printer with a logical printer within an NPF VTAM capture point application program.

For each logical printer LU:

- VTAM must activate an APPL definition statement
- The NPF VTAM capture point application must open a matching ACB

The NPF VTAM capture point application as a whole is not defined to VTAM in any way.

It is possible to run multiple instances of the NPF VTAM capture point application at the same time. Each must run in a different MVS address space and must do processing for a different set of logical printer LUs. There are several reasons why this might be useful:

- To improve throughput by spreading processing across multiple address spaces.
- To reduce region size problems by spreading the logical printer LUs across multiple regions.
- To enable different sets of logical printer LUs to be started and stopped at different times.

The set of logical printer LUs to be supported by any given instance of the NPF VTAM capture point application is selected as follows:

- The routing file entry for each logical printer LU contains a class identifier, the LUCLASS parameter, which specifies one or more numbers in the range from 1 to 64. LUCLASS is specified via the ROUTING function of the EZAPPFL macro. See "EZAPPFL TYPE=ROUTING" on page 54 for a complete definition of the LUCLASS parameter.
- The JCL used to start each instance of the NPF VTAM capture point application contains an LUCLASS sub-parameter, also specifying one or more numbers in the range from 1 to 64.

- Each logical printer LU whose routing file record's LUCLASS value matches the JCL's LUCLASS value is selected. The LUCLASS values are considered to match if they have one or more class identifiers in common; it is not necessary to have all specified class identifiers the same.

When running the VTAM capture point application, the routing file is required for logical printer name selection, even if the coding of a general routing exit makes it unnecessary for actual routing functions.

Specific concepts for processing VTAM output

This section describes some special topics pertinent to VTAM users.

BIND parameters

For the BIND sent to start a session with a Network Print Facility logical printer, there are some parameter restrictions. The LU Type parameter must be consistent with the type of print data to be sent during the session, and the FM Profile and TS Profile values must be allowed for that LU Type. Valid combinations of these BIND parameters are shown below:

Table 2. VTAM BIND parameter requirements

Data Type	LU Type	FM Profile	TS Profile
3270 data	LU 0	2	2
3270 data	LU 3	3	3
SNA character string (SCS) data	LU 1	3 or 4	3 or 4

Each BIND specifying an LU type of 0 or 3 must also specify a valid non-zero screen size.

In VTAM, various sets of default BIND parameters are defined by entries in user-modifiable logmode tables. Either explicitly or by default, the APPL definition for each Network Print Facility logical printer is associated with one of these logmode table entries containing a specific set of BIND parameters. When starting a session, the PLU uses these default BIND parameters, or it uses its own resource definitions to override some or all of the default BIND parameter data.

Attention: When an IMS application is the PLU and the logical printer is defined in IMS as a non-SNA 3270 device, IMS uses the default BIND parameters without any changes. Therefore, those default parameters must be correct for a 3270 data stream as illustrated in Table 2.

In most other cases, CICS and IMS subsystems override default BIND parameters as necessary to ensure consistency. With session partner LUs other than CICS or IMS, make sure that the combination of default BIND parameters in the logmode table and parameter overrides by the PLU result in a correct BIND for the Network Print Facility.

Restrictions on data stream support

For LU 1 sessions, Network Print Facility does not support:

- FM headers - For LU 1 data streams, the Network Print Facility VTAM capture point application does not expect FM data requests that it receives to be formatted. It has no logic to handle FM headers. Any request containing an FM header is rejected with a sense code of X'10030000' (function not supported).

- Some SCS commands. See Appendix D, “The SCS printer emulator,” on page 159 for more detail.

For LU 3 or LU 0 sessions, Network Print Facility does not support:

- Anything other than the basic function set for the 3270 data stream as described in *SNA - Sessions Between Logical Units*. Note that the Write Structured Fields command is not included in the basic function set and, therefore, is not supported.
- DBCS

Differences between SNA and TCP/IP print processing

TCP/IP-attached printers accessed by the Network Print Facility do not behave exactly like their SNA-network counterparts.

- The SNA-network user receives verification that the data has been printed:
 - In SNA, a positive response from a printer means that the data has actually been printed successfully.
 - With the Network Print Facility, a positive response means that the data has been received successfully by the Network Print Facility VTAM capture point application and queued successfully in a QSAM data set.
- If encryption is being used, the Network Print Facility only protects the data's security across the SNA LU-LU session:
 - With a real SNA-network printer, the encryption protects the data all the way to the final destination.
 - With the Network Print Facility, the data is decrypted as it arrives in the Network Print Facility application's VTAM host; it is unprotected across the TCP/IP portion of the network.
- If compression is being used, VTAM-supported data compression is available only between the sender and Network Print Facility's VTAM host.
 - With a real SNA-network printer, the compression is available all the way to the final destination.
 - With the Network Print Facility, the compressed data is decompressed after it arrives in the Network Print Facility application's VTAM host, but before it arrives at the application itself, not across the TCP/IP portion of the network.
- In an SNA network, being in session with a printer gives the application exclusive control of that printer, except for possible interference from local copy operations. The printer's normal session limit of 1 prevents any other application's print output from being interleaved with the owning application's output.

In a TCP/IP network, such exclusive control of the printer is not generally possible because a session limit of 1 applies only to the SNA portion of the flow, and it will not stop other users in the TCP/IP network from sending print jobs to the real printer that the logical printer represents.

User-modifiable tables

NPF's VTAM capture point application uses two user-modifiable tables to define certain processing rules for its sessions. These tables are introduced here and more fully explained later in the book.

- The end-of-file rules table

The Network Print Facility uses the concept of a print **file**, defined as:

A batch of related print data which should be handled as a single document. NPF keeps all of the data for a file together as it is queued, transmitted to LPD, and printed.

For correct results, it is necessary for NPF's VTAM capture point application to determine accurately where one file should end and the next one should begin. Unfortunately, it is not always clear how to do this.

To help in making these decisions, the Network Print Facility provides a user-modifiable end-of-file rules table. This table allows different end-of-file rules to be defined for different combinations of logical printer LU, session partner LU, and LU type used on the session. See "File definition for VTAM output" on page 27 for more information about how the Network Print Facility defines file boundaries.

- The default page format table

In some cases, the SCS data streams used on LU type 1 sessions depend on a default page format which is hard-wired or otherwise pre-set for the printer being used.

The Network Print Facility provides a user-modifiable table to allow the equivalent of these hard-wired defaults to be defined for its logical printers. See "Page format definition" on page 37 for more details on the Network Print Facility's page formats.

Notes for IMS/CICS users of telnet

In IMS or CICS subsystems, applications receive communication services from terminal management functions of subsystems. Thus, the IMS programmer thinks of a device as an LTERM and the CICS programmer thinks of a device as a TCTTE entry.

Many IMS and CICS applications have algorithms that derive LTERM or TCTTE names for printers by performing some hashing technique on the input LTERM or TCTTE names. If the Network Print Facility is used with Telnet, this creates problems because Telnet assigns the input LU name (and thereby the LTERM or TCTTE name) arbitrarily from a pool of LU names. If this type of algorithm is in use in your installation and you are using Telnet support, IBM recommends that the IP-LU mapping feature of Telnet be used. This feature allows the specification of the input LU name rather than having it randomly selected from a pool. This would, in turn, permit the application to select the LU name for the printer. See the LUMAP statement described in *z/OS Communications Server: IP Configuration Guide*.

Chapter 2. Planning for the Network Print Facility

Careful planning for the Network Print Facility is essential. Read all the information concerning the steps to implement this function before turning to the customization task.

Required skills

Before using the information in this section, make sure you have an understanding of JES or VTAM, or both.

Required environment

Before using the information in this section, make sure you have established the correct LPR/LPD environment. If you are connecting to MVS host printers, read about LPD in “Configuring the Remote Printer Server (LPD)” in the z/OS Communications Server: IP Configuration Guide.

See Chapter 1, “Introduction,” on page 1, the z/OS Program Directory, or z/OS Planning for Installation for the correct level of supported products.

Overall planning activities

To run the Network Print Facility, you need to plan in the following ways:

- Decide how many printers you will use.
- Ensure LPR/LPD options are established for how output should be printed. What LPD options does each printer support? What LPR options should the Network Print Facility process when sending a job to the printer?
- Decide who should have the authority to interactively access the routing, options, and queue files. Who should be able to change destinations and print options? Who should be able to look at the status of print jobs and who should be able to change or delete them? By default, all interactive users can update the routing, options, and queue files. If you have the Resource Access Control Facility (RACF®), you can use it to prevent access or allow read-only or read-write access for the appropriate users.
- Decide how you can effectively implement the routes you require. Should jobs be sent to one printer or to multiple homogeneous printers? Homogeneous printers are printers with identical LPR options. These can be similar printers with different locations or destinations. For more information about homogeneous printers, see “The options file” on page 43 and “The routing file” on page 44.
- Assign major and minor names for routing records. Major and minor names are the keys that the Network Print Facility uses to route print output. See the parameter descriptions in “EZAPPFL TYPE=ROUTING” on page 54 for valid specifications.
- Decide how to handle host name resolution. The routing records can specify an internet name or an IP address as the destination. If an internet name is specified, this name will have to be resolved by the Domain Name Server each time an output file is sent.
- Decide if you want to include an option to access the Network Print Facility on the ISPF Primary Option Menu

- Decide whether you will be using the NPF FSS writers or the VTAM capture point, or both.
- Define the Network Print Facility queue management function:
 - Decide how to handle output that *does* print successfully. Do you want to delete the job immediately? Do you want to retain the job for a period of time for future use?
 - Decide how to handle output that *does not* print successfully. Do you want to resend the data? If so, how many times do you want to attempt to resend? How often to retry? How long do you want to retain the file after all attempts to resend have failed?
 - Be prepared to specify these criteria in the file creation macros and on the panels.
- Determine if user exits are necessary. If so, create them and plan to specify them appropriately in the macros and on the panels.
- Plan to allocate adequate space for the routing, option, queue, and active VSAM files before using the file creation macros.
- Decide if you will use the various EZAPPFL macro functions to just initialize or to initialize and load the routing and options files.
- Decide whether you will update the routing and options files using the various functions of the EZAPPFL macro or the ISPF interface. The samples provided with the EZAPPFL macro show how to update the routing and options files in batch mode. Chapter 6, “Maintaining the Network Print Facility files with ISPF,” on page 69 shows how to update them using the ISPF interface.

See the “Checklist of the NPF tasks for all users (JES or VTAM)” on page 149 for a list of items to check as you begin to use the Network Print Facility.

JES planning considerations

Things to consider as you plan for Network Print Facility use in your JES environment are:

- Decide how many NPF FSS writers you will use. Because each FSA subtask processes output for JES logical printers in parallel, system storage constraints might affect the amount of printing and throughput possible. There might be benefits in specifying 1 FSS writer with multiple FSA subtasks instead of multiple FSS writers each with a single FSA subtask.

You can parallel process output in two ways:

1. Using a single writer with multiple logical printers
2. Defining multiple writers with one printer each

Writers with multiple printers can be more efficient than having multiple writers with one printer each, because each writer has its own address space. If, however, the printers are of different priority or have a large disparity in job length, one printer might develop a backlog, and in this situation, it might be best to use multiple writers. See the topics on calculating the number of FSA subtasks, defining and managing JES3 resources, and running a printer by using an output FSS in either the z/OS JES2 Initialization and Tuning Guide or the z/OS JES3 Initialization and Tuning Guide

- Decide how you can most effectively use the JCL CLASS parameter. The NPF FSS writer uses the CLASS parameter to decide which job to print. JES supplies the NPF FSS writer with SYSOUT based on a set of installation-defined criteria.

Therefore IBM recommends you define your selection criteria as CLASS. Multiple writers can use the same class, or each writer can be assigned to a different class.

- The NPF FSS writer uses fields in the job separator page area (IAZJSPA) such as DEST, CLASS, job name, and user ID in addition to extension areas. Ensure your own changes made to this DSECT (or changes made in JES2 exit 23 or JES3 exit 45, for example) are compatible with the Network Print Facility FSS writer.
- Accommodate the Network Print Facility's use of an 8 alphanumeric character name for destination. If you specify something longer in the DEST parameter of the JCL, you need to truncate that name for Network Print Facility use.
- Accommodate the Network Print Facility's effect on JESNEWS. See "Customizing JESNEWS" on page 23 for more information.
- Determine the best NPF run-time options for your print environment.

The setting of the SPIN option might affect the print processing or generation of JES separator pages. NPF will process output from JES on either a data set level (SPIN=DATASET) or a group level (SPIN=GROUP).

For JES, an output group is defined as "A set of a job's output data sets that share output characteristics, such as class, destination, and external writer." For example, a job's LOG, JCL, and job messages, although three separate JES data sets, can be considered one output group.

See "Modifying the NPF FSS writer start procedure" on page 127 for more information.

VTAM Planning Considerations

Things to consider as you plan for the Network Print Facility use in your VTAM environment are:

- Establish consistent definition of resources.

The key to consistent definition in the Network Print Facility is the logical printer name. The system administrator must set up a routing file defining the different logical printer names and their corresponding real TCP/IP resource IDs. For VTAM, each logical printer name must also be marked as belonging to one or more LUCLASSES. See "Defining consistent resources" on page 26 for more information.

- Determine the end-of-file rules for logical printers.

The Network Print Facility provides a default end-of-file rule for use on all sessions. However, for situations where that default rule is not sufficient, you can define different end-of-file rules for various combinations of SLU name, PLU name and LU type. For more information, see "File definition for VTAM output" on page 27.

- Determine default page formats for logical printers.

The Network Print Facility gives you the opportunity to define default page formats unique to an environment. For more information, see "Page format definition" on page 37.

Chapter 3. Customizing the Network Print Facility

Before you begin customization, both z/OS Communications Server and the Network Print Facility must be installed according to the instructions provided in the *z/OS Program Directory*.

This chapter provides:

- Overall customization information for both JES and VTAM implementations
- Specifications for NPF configuration statements
- JES customization information, including the definition of the functional subsystem (FSS) writers and printers
- VTAM customization information, including the definition of VTAM resources

Overall customization information

Procedure

Perform the following general procedures to customize the Network Print Facility. Use Appendix A, “Checklists for using the Network Print Facility,” on page 149 to verify that you have covered all the planning and customization tasks.

1. Verify configuration statements in TCPIP.DATA. You can find instructions in this chapter.
2. Specify configuration statements in NPF.DATA. You can find instructions in this chapter.
3. Perform specific tasks to customize for JES or VTAM implementations. You can find instructions in this chapter.
4. Create and initialize the routing, options, and queue files. You can find instructions in Chapter 5, “Creating the Network Print Facility files,” on page 51.
5. If required, write the optional user exits. You can find instructions in Chapter 7, “Writing exit routines to tailor the Network Print Facility,” on page 105.
6. Provide access to the NPF ISPF interface and use its panels to add or change data in the files. You can find instructions in Chapter 6, “Maintaining the Network Print Facility files with ISPF,” on page 69.
7. Ensure the JCL you use to start the NPF capture point applications and the queue manager contains the correct data set names for the NPF files.

Results

After you have configured Network Print Facility and initialized and loaded your files, you can start your Network Print Facility capture point applications. See “Starting the NPF VTAM capture point” on page 131 and “Creating the NPF FSS writer start procedure” on page 126 for details.

Configuring NPF using TCPIP.DATA and NPF.DATA statements

When the NPF capture point applications are started, they use configuration statements in the following data sets to set initialization and run-time values:

Data Set	Configuration Statement
TCPIP.DATA	TCPIPJOBNAME DATASETPREFIX
NPF.DATA	NPFPRINTPREFIX NPFJESALLOCATION NPFVTAMALLOCATION NPFQMGRTHREAD NPFUNIT

TCPIP.DATA configuration

The TCPIP.DATA data set is used by all TCP/IP client applications and is configured as part of z/OS Communications Server customization. You can find more information about this data set and its statements in z/OS Communications Server: IP Configuration Guide.

TCPIP.DATA statements

NPF uses values in two of the TCPIP.DATA configuration statements:

TCPIPJOBNAME provides the job name of the TCP/IP address space. NPF uses this to determine which TCP/IP program to use. Be sure to specify a job name for the TCP/IP address space in the TCPIPJOBNAME statement unless you want the default (TCPIP) to be used.

DATASETPREFIX provides an optional high-level qualifier that can be used as the *hlq* variable when searching for data sets. If NPF cannot find a DATASETPREFIX statement as it goes through the TCPIP.DATA search order, it uses the system default, TCPIP. This *hlq* value can affect the TCPIP.DATA search order, the NPF.DATA search order, and the high-level qualifier used to name NPF's temporary QSAM print data sets.

TCPIP.DATA search order

To find TCPIP.DATA, NPF follows a standard search sequence. It reads each instance of TCPIP.DATA it can find, in order, until it finds values for both the TCP/IP configuration statements. It uses the first value that it finds for each statement. If an allocation fails, the data set does not exist, or the data set is not available, NPF goes to the next data set in the sequence. The search ends when it finds values for both the TCP/IP configuration statements or when all data sets have been checked. The search order is:

1. The data set pointed to by the DD statement //SYSTCPD.
2. A data set with the name of *jobname*.TCPIP.DATA, where *jobname* is the jobname for the NPF capture point application or the TSO user ID for the TSO session (panels).
3. A data set with the name of SYS1.TCPPARMS(TCPDATA).

4. A data set with the name of *hlq.TCPIP.DATA*, where *hlq* is the value set by a *DATASETPREFIX* statement found in a prior *TCPIP.DATA*, or the system default value of *TCPIP*.

You can also find information about the native MVS environment *TCPIP.DATA* search order, and the system default in *z/OS Communications Server: IP Configuration Guide*.

NPF.DATA configuration

The *NPF.DATA* data set is specific for the Network Print Facility feature. A sample is provided in *hlq.SEZAINST(NPFDATA)*. It contains configuration statements that define a high-level qualifier and run-time values for both JES and VTAM NPF implementations.

NPF.DATA statements

All of the *NPF.DATA* configuration statements are optional. If you do not specify them, the Network Print Facility uses the defaults. You can split the *NPF.DATA* configuration statements across multiple *NPF.DATA* data sets and you can enter these statements in mixed case.

NPFPRINTPREFIX specifies a high-level qualifier to be used for NPF's temporary QSAM print data sets.

NPFJESALLOCATION defines the type of space being allocated and primary and secondary sizes of the data sets in an NPF JES implementation. It corresponds to the *JCL SPACE* parameter.

NPFVTAMALLOCATION defines the type of space being allocated and primary and secondary sizes of the data sets in an NPF VTAM implementation. It corresponds to the *JCL SPACE* parameter.

NPFQMGRTHREAD specifies the number of LPRs running under the NPF queue manager application. The default is 4.

NPFUNIT specifies the *UNIT* name for the dynamic allocation of the QSAM data sets. It corresponds to the *JCL UNIT* parameter.

NPF.DATA sample

The following *NPF.DATA* sample is provided in *hlq.SEZAINST(NPFDATA)*. Copy this sample to your library and modify it to suit your installation.

```

;
;  COPYRIGHT = NONE.
;
NPFPRINTPREFIX    NPF.TEMP
NPFJESALLOCATION   40000,2,2
NPFVTAMALLOCATION  TRK,1,1
NPFQMGRTHREAD     5
NPFUNIT           SYSDA

```

Figure 3. NPF.DATA sample

NPF.DATA search order

To find NPF.DATA, NPF follows a standard search sequence. It reads each instance of NPF.DATA it can find, in order, until it finds values for all the NPF configuration statements. It uses the first value that it finds for each statement. If an allocation fails, the data set does not exist, or the data set is not available, NPF goes to the next data set in the sequence. The search ends when it finds values for all NPF configuration statements or when all data sets have been checked.

The search order is:

1. The data set pointed to by a DD statement //SYSNPFD.
2. A data set with the name of *jobname*.NPF.DATA, where *jobname* is the jobname for the NPF capture point application or the user ID for the TSO session (panels).
3. A data set with the name of SYS1.TCPPARMS(NPFDATA).
4. A data set with the name of *hlq*.NPF.DATA, where *hlq* is the value specified by the DATASETPREFIX statement in TCPIP.DATA. If TCPIP.DATA cannot be found or does not contain a DATASETPREFIX statement, then *hlq* is the system default, TCPIP.

NPFPRINTPREFIX statement

The NPFPRINTPREFIX statement specifies a high-level qualifier of 26 characters or fewer used for NPF print data sets.

Syntax

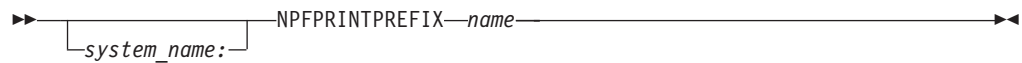

Parameters

system_name:

If you are sharing the NPF.DATA file across more than one MVS system, this parameter specifies the MVS system name. This value should be set to the same name as your JES NJE *nodename*. The colon is required.

name

A high-level qualifier for NPF print data sets. The name can be up to 26 characters and must follow these rules:

- It must not start or end with a period.
- Each qualifier segment must be no more than 8 characters long and consist of a combination of alphabetic, numeric, and some special characters. (See the *MVS JCL Reference* for details.)
- It must start with an alphabetic character, and each period must be followed by an alphabetic character.
- All alphabetic characters are converted to uppercase.

Usage notes

- If this statement is not specified, the system uses the general TCP/IP high-level qualifier, either specified via the DATASETPREFIX statement, or defaulted to TCPIP.
- Any high-level qualifier longer than 15 characters might cause truncations of the major and minor names used as part of the data set name. This applies to the NPFPRINTPREFIX value or, if one is not specified, it applies to the TCP/IP default high-level qualifier.

Related topics

See the *OS/390 Program Directory* for information about running EZAPPRFX.

NPFxxxxALLOCATION statement

The NPFxxxxALLOCATION statement specifies space size for either JES or VTAM that corresponds to the JCL SPACE parameter. Use JES or VTAM to replace xxxx in the statement. Specify the type of space being allocated and the primary and secondary sizes of the files.

Syntax

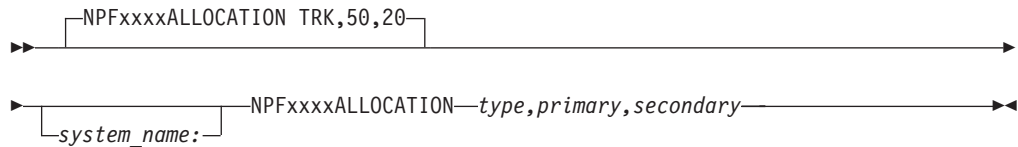

Parameters

system_name:

If you are sharing the NPF.DATA file across more than one MVS system, this parameter specifies the MVS system name. This value should be set to the same name as your JES NJE *nodename*. The colon is required.

type

The type of allocation: CYL, TRK, or a number specifying a block size if the allocation is to be done in blocks. The default is TRK.

primary

The size of the primary allocation for the files. If CYL is specified as the type, this specifies the number of cylinders. If TRK is specified as the type, this specifies the number of tracks. If a block size is specified as the type, this specifies the number of blocks. The default is 50.

secondary

The size of the secondary allocation for the files. If CYL is specified as the type, this indicates the number of cylinders. If TRK is specified as the type, this indicates the number of tracks. If a block size is specified as the type, this indicates the number of blocks. The default is 20.

Examples

Examples of this specification are:

```
NPFJESALLOCATION CYL,1,1
NPFVTAMALLOCATION TRK,1,1
```

Usage notes

- The values for the type, primary, and secondary allocations must be separated by commas.
- Specify primary extents large enough for the majority of jobs. Unused primary space is released after the data set is created.
- Specify non-zero secondary extents to ensure enough space to hold your largest data set.

NPFQMGRTHREAD statement

The NPFQMGRTHREAD statement specifies the number of LPRs running under the NPF queue manager application.

Syntax

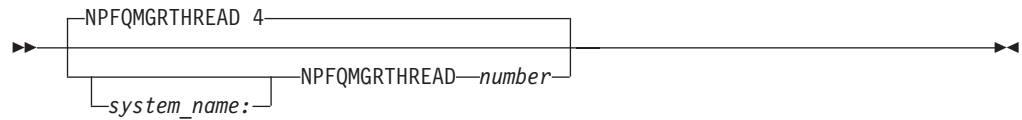

Parameters

system_name:

If you are sharing the NPF.DATA file across more than one MVS system, this parameter specifies the MVS system name. This value should be set to the same name as your JES NJE *nodename*. The colon is required.

number

A positive number, from 1 to 11, specifying the number of LPRs running under the NPF queue manager application. The default is 4.

Usage notes

The number of LPR threads is limited by the amount of below-the-line virtual storage available. Each LPR thread requires approximately 0.75 MB of below-the-line storage. If virtual storage problems exist, reduce the number of threads specified on this statement.

NPFUNIT statement

The NPFUNIT statement specifies a unit name of 8 or fewer characters to be used for the dynamic allocation of the QSAM print data sets.

Syntax

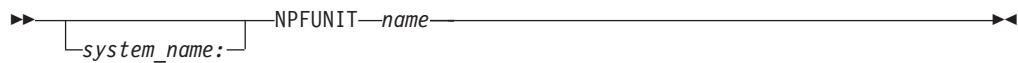

Parameters

system_name:

If you are sharing the NPF.DATA file across more than one MVS system, this parameter specifies the MVS system name. This value should be set to the same name as your JES NJE *nodename*. The colon is required.

name

A UNIT name for the DASD volume(s) where NPF data sets will be allocated. The name must follow these rules:

- It must define an esoteric unit name (for example, SYSDA), a generic unit name (for example, 3380), or a specific unit address.
- It must be at least one character and no more than 8 characters long. It consists of a combination of alphabetic, numeric, and some special characters.
- It must not start or end with a period.

Examples

Examples of this specification are:

```
NPFUNIT SYSDA
NPFUNIT 3380
```

Usage notes

If this statement is not specified, NPF uses the default value of SYSDA.

Customization for JES output processing

The Network Print Facility uses the functional subsystem interface (FSI) to communicate with MVS JES. The NPF functional subsystem (FSS) writer processes each job on the JES output queue by JES output class, forms, and destination information. The DEST, CLASS, and FORMS parameters are used to create the record key for the routing file in JES implementations and, therefore, play an important role in determining where to print JES output.

The basic concepts for JES output processing are explained in “Network Print Facility interfaces with JES” on page 6. Chapter 8, “Operating the Network Print Facility,” on page 125 provides additional information for defining the NPF FSS writer and tailoring it to your particular installation.

This section describes how to:

- Customize JESNEWS
- Define and authorize an NPF FSS writer
- Determine where to print JES output

Be sure to see “Checklist of the NPF tasks for JES users” on page 152 to verify that you have covered all the JES planning and customization tasks.

Customizing JESNEWS

JESNEWS is a separate data set that might be sent across the FSI to FSS printers under certain circumstances. It contains installation dependent information. Installations define the JESNEWS text via a DSP in JES3 (called JESNEWS) or via a particular external writer name in JES2 (called 'JESNEWS', that you write to using IEBGENER or IEBDG.)

For JES3, JESNEWS appears if an FSS writer is producing BURST pages. Ensure you specify BURST=NO, so the production of JESNEWS data sets does not affect NPF processing.

For JES2, JESNEWS appears if you specify SEP=YES and set up JESNEWS. JES2 exit 23 can be used to turn JESNEWS off so as not to affect NPF processing.

JES3 users can see *JES3 Commands* for details about how to use the JESNEWS DSP. JES2 users can find out more about JESNEWS in the *JES2 Initialization and Tuning Guide*.

Defining the NPF FSS writer

FSS writers control the processing of JES logical printers. The number of NPF FSS writers and the number of logical printers associated with each NPF FSS writer is installation-dependent. Each FSA subtask under the FSS writer acts as a logical printer dedicated to processing the output in its defined class or classes. The steps to define FSS writers and their logical printers vary depending on the version and release of JES.

Because each FSA subtask acts as a logical printer, after the FSA subtask has been defined, each instance of a writer can be started and stopped like any printer. The FSS writer can be started by JES commands or through the JES initialization definition. Commands and initialization statements to start the FSS writer in various environments can be found in Table 13 on page 129.

Authorizing the NPF FSS writer load module

The FSS load module (EZAPPFS) must be marked as both authorized and reusable, and placed in an APF-authorized library. To ensure subpools 0-127 are in the correct key, place EZAPPFS in the MVS program properties table (PPT) with the following entry:

```
PPT PGMNAME(EZAPPFS) KEY(1)
```

Note: PPT entries in the SCHEDxx member of SYS1.PARMLIB are no longer required. They are supplied in the default PPT table via load module IEFSDPPT.

Determining where to print JES output

Each NPF FSS writer is associated with 1 or more logical printers (which was assigned an output class or classes during JES initialization, or in some cases, by JES console commands). When an NPF FSS writer and associated logical printer are active, the NPF FSS writer processes all JES output that matches the output classes assigned to the logical printers. When the Network Print Facility receives the output, it uses the output class, destination, and forms associated with the

output to determine LPR options and which LPD printer queue should receive the output. This determination is made through the routing file described in the following chapter.

For example:

Output 1 has JCL parameter CLASS=C, FORMS=1000, DEST=LOCAL
Output 2 has JCL parameter CLASS=C, FORMS=1000, DEST=LOCAL
Output 3 has JCL parameter CLASS=C, FORMS=1000, DEST=DEST1
Output 4 has JCL parameter CLASS=C, FORMS=2000, DEST=LOCAL

Output 1 and 2 will be sent to the same LPD print queue, which were defined to handle the combination of the class, forms, and destination. Output 1, 3, and 4 might each be sent to separate printers or might have a different NPF processing performed because they each have a unique combination of class, forms, and destination. For more information on printer destination mapping, see “The routing file” on page 44.

Note: The Network Print Facility uses the 1–8 alphanumeric destination name you specify through the ROUTING function of the EZAPPFL macro (MAJKEY parameter) to route output.

Defaults for JES output data

The Network Print Facility uses the following defaults for output data sets:

Table 3. JES data limitations

Data Type	NPF Default
line mode data	LRECL = 4092, BLKSIZE = 4096
stream mode data	LRECL = 32 756, BLKSIZE = 32 760

Note: The maximum record length the Network Print Facility processes for line mode data is 4092.

All JES output data sets should be coded as follows:

RECFM=VBA for ASA carriage control
RECFM=VBM for machine carriage control
RECFM=VB for no carriage control

Customization for VTAM output processing

The Network Print Facility uses an NPF VTAM capture point application to process VTAM output. This section describes activities to ensure correct processing. The topics included are:

- Consistent resource definition
- File definition
- The EZAPPEFM macro
- Page format definition
- The EZAPPDPF macro

Be sure to see “Checklist of the NPF tasks for VTAM users” on page 150 to verify that you have covered all the VTAM planning and customization tasks.

See “Starting the NPF VTAM capture point” on page 131 for the procedure to start the NPF VTAM capture point application.

Creating a startup procedure

You can specify the amount of storage through the procedure to start the VTAM capture point application.

Procedure

Follow these steps to estimate your storage needs and then specify them in the startup procedure.

1. Determine the amount of below-the-line private storage needed for the NPF VTAM capture point application. Consider the following factors when estimating this storage requirement:
 - a. Storage for a minimum-configuration application:

For an NPF VTAM capture point application, the simplest useful configuration would have one logical printer LU running one session with all output routed to a single destination. The amount of below-the-line storage needed for such a configuration varies from one MVS system to the next.

 - For preliminary planning purposes, assume 0.5 MB will be needed for this configuration.
 - **Tuning note:** After NPF is installed, a simple test run with this configuration will enable you to refine that estimate. The JCL output listing from that test will show the below-the-line private storage actually used on your system.
 - b. Storage for active print files:

Print files being processed by the NPF VTAM capture point application are managed as temporary QSAM data sets requiring below-the-line storage.

 - Each file being received requires 16 KB.

Specify either the MAXFLSTG or MAXOPEN JCL parameter to limit the amount of below-the-line storage used for open print data sets. With either of these parameters, if a request for a new data set would cause that limit to be violated, that request will be rejected with a sense code indicating you had insufficient resources. For example, a limit of 1000 open files could be expressed by either MAXFLSTG=16000K or MAXOPEN=1000.
 - c. Other minor storage requirements:
 - Each logical printer LU requires 112 bytes of below-the-line control block storage.
 - Each session requires 112 bytes of below-the-line control block storage.
2. Set up the JCL to run the VTAM capture point application using the estimates calculated in the previous step. Include the following parameters on the EXEC statement.
 - a. Identify the program to be started.

```
PGM=EZAPPA
```
 - b. Code the REGION parameter to specify the amount of below-the-line storage calculated in the previous step. The region size depends on the number of active sessions and the maximum number of open print files in progress at any given time. This should include your minimum configuration requirement plus the maximum storage for active print files and other minor storage requirements.

- c. Code the PARM parameter with LUCLASS, and either MAXFLSTG or MAXOPEN.

```
,PARM=(LUCLASS=(luclass_list),  
        MAXFLSTG=file_stg_limit,  
        MAXOPEN=open_file_limit)
```

Specify *luclass_list* as one or more LU class numbers with values from 1 to 64. Specify *file_stg_limit* as the maximum amount of buffer space you want to allow for open print data sets, or specify *open_file_limit* as the maximum number of open print data sets.

These LU class numbers will be used as follows to select the set of logical printer names that the application represents:

- For each VTAM-usable entry in the routing file, the MAJKEY keyword must specify a logical printer name, and the LUCLASS value must specify one or more LU class numbers with values from 1 to 64.
- The LU class data from the JCL will be compared to the LU class data in each routing file entry. If there is a match on at least one LU class number, the application will represent the logical printer name specified by that entry.

For example, assume that the routing file contains 4 entries as follows:

```
PRINTERA LUCLASS=(1,4)  
PRINTERB LUCLASS=(2,3,4)  
PRINTERC LUCLASS=(3,4)  
PRINTERD LUCLASS=(2,4)
```

Given the above routing file entries, code the JCL LUCLASS parameter as follows:

To use all 4 printers

```
LUCLASS=(4)
```

To use printers B, C, and D,

```
LUCLASS=(2,3)
```

To use printers B and D

```
LUCLASS=(2)
```

To use just printer A

```
LUCLASS=(1)
```

See “Starting the NPF VTAM capture point” on page 131 for the sample JCL and a further explanation of the LUCLASS, MAXOPEN, and MAXFLSTG parameters.

- d. To prevent MVS from terminating the application because of its running time, code the JOB statement with TIME=1440 or TIME=NOLIMIT.

Defining consistent resources

Consistent definition of resources is essential to use the NPF VTAM capture point application.

Procedure

To ensure consistent definition for VTAM customization, perform these tasks *before* starting the Network Print Facility. See z/OS Communications Server: SNA Resource Definition Reference for additional detail on these items.

1. Set up an APPL definition for each logical printer name.

Define each of the logical printer names to VTAM by an APPL definition statement in an application major node definition. Selected parameters on that definition statement are discussed below:

- a. If any partner LU will need accurate BIND parameter information from the logon mode table, add a new table entry or find an existing one that meets the requirements. Then specify the necessary table name and entry name through the MODETAB and DLOGMOD keywords, or set up the table so the entry that you want will be selected by default.
 - b. Code SESSLIM=YES to force a session limit of 1 for the logical printer.
 - c. Specify (or default to) PARSESS=NO.
 - d. Do not code any APPC-related keywords.
2. In each session partner LU, set up definitions for each logical printer name. For CICS, a specific requirement is that you specify NO for the QUERY keyword on the TYPETERM macro. These logical printer definitions should correspond to the VTAM APPL names.
 3. Build the routing file to make the connection between the logical printer names and the LUCLASS numbers. Specify the logical printer LU name in the first part of the routing record key (Major Name) and specify the printer classes in the LUCLASS field. (See the "Routing file input fields" on page 46.)

Modifying the program properties table

To run the NPF VTAM capture point application as nonswappable, add a Network Print Facility entry for the VTAM application, EZAPPA AAA, in the MVS program properties table (PPT).

```
PPT PGMNAME(EZAPPA AAA) NOSWAP
```

Note: PPT entries in the SCHEDxx member of SYS1.PARMLIB are no longer required. They are supplied in the default PPT table via load module IEFSDPPT.

File definition for VTAM output

The print data for a given logical printer LU is received as a stream of request units (RUs). The SNA architecture defines two groupings of RUs that are of interest here:

- A *chain* consists of one or more RUs.
- A *bracket* consists of all of the RUs in one or more related chains.

For each logical printer, the Network Print Facility divides the stream of received RUs into a series of *print files* and queues the data for each print file in its own sequential data set, keeping it together as it is transmitted to LPD and printed.

For printing within the SNA network, there is no need for this print file concept. An application starting a session with a printer gains exclusive control of that printer for the duration of the session, and data is printed as soon as it arrives at the printer. Therefore, data is printed in the correct order, and there is no danger of intrusion by any other application's print output.

In contrast, when printing in the TCP/IP network, the sending application is not guaranteed exclusive control of the printer. All data within a single file is printed together in the correct order. However, between two successive files from one application, there is nothing to prevent the printing of files from other applications.

Therefore, to guarantee that data belonging together actually gets printed without intrusions from other sources, it is important to batch that data together into a single file.

From an SNA-theory point of view, the use of brackets is the most logical way to define file boundaries. Using this technique, a request marked BB (Begin Bracket) indicates the start of a new file, and the end of a chain marked EB (End Bracket) marks the end of the file. This is the default file definition technique used by the Network Print Facility. It works with both CICS and IMS LU type 1 sessions, with CICS LU type 3 sessions, and with other applications able to control their use of the BB and EB bracket bits.

There are situations where using bracket bits does not work well, as indicated by the following examples:

1. CICS application with an LU type 0 session:
 - BB is sent on the session's first request.
 - No EB is sent at the end of the transaction.
 - Result: The output for the entire session is treated as one file, causing a potentially long delay in printing.
2. IMS application with a non-SNA 3270 printer:
 - Each line of output is sent as a separate chain marked BB, EB.
 - Result: Each line is treated as a separate file, causing unnecessary file overhead and increasing the chances of other files from other applications intruding into the sequence.

End-of-File definition

The NPF VTAM capture point application provides 5 different end-of-file rules for defining files, as explained below. Only one of these rules can be specified for any given session:

1. End-of-file = end-of-bracket (the default rule).
2. End-of-file = end-of-session.
3. End-of-file = end-of-chain.
4. End-of-file indicated by a specified string of data in the file's last end-of-chain request.
5. End-of-file indicated by the expiration of a timer.

Timers should be used only as a last resort in situations where none of the other end-of-file rules make sense.

 - The use of timers to detect file boundaries is an inexact science. Experimentation and tuning is required to choose the best timer values, and even then the results will not be perfect.
 - Under each of the other end-of-file rules, exact file boundaries can be determined directly from the received print data requests.

The Network Print Facility uses a table to allow user specification of the end-of-file rules for different sessions. This user-replaceable table is defined using the EZAPPEFM macro and contains one or more entries. Each entry defines the end-of-file rules used with various combinations of PLU name and LU type. The table entry is selectable on a per-SLU basis, via the end-of-file entry name in the SLU's routing file entry. This end-of-file rules table is packaged in the module EZAPPEFT. That module is shipped in two different forms:

- As a ready-to-use load module which, if used as is, causes the end-of-file = end-of-bracket rule to be used on all sessions.
- As sample source code, which can be modified by the user to specify different rules in selected cases, then assembled and used instead of the IBM-supplied module.

Installing the end-of-file table

This end-of-file rules table is packaged in module EZAPPEFT. The EZAPPEFT is shipped in the form as a ready-to-use module or as sample source code. The users can modify the sample source code form.

Procedure

To install a user-modified version of EZAPPEFT, proceed as follows:

1. Code the modified version of the module, using the IBM-supplied EZAPPEFM macro. See “Defining end-of-file rules” on page 30 for details about how to use the macro to create the table.
2. Assemble and link-edit the module into a partitioned data set different from that used for the IBM-supplied version of the module. This prevents the module from being deleted during any subsequent re-install of NPF.
3. On the JCL for the NPF VTAM capture point application, provide a STEPLIB DD statement specifying that partitioned data set. For example:

```
//STEPLIB DD DSN=xtable.loadlib, DISP=SHR
```

In this example, `xtable.loadlib` is the name of the partitioned data set that includes the tables as members. See “Operating the NPF VTAM capture point” on page 131 for a sample startup procedure.

Results

After performing these steps, the new table will automatically replace the IBM-supplied version the next time the NPF VTAM capture point application is started.

To dynamically replace the current version of EZAPPEFT with a new one while the NPF VTAM capture point application is running, respond to message EZY0837I with the following code:

```
nn,RELOAD EZAPPEFT
```

After the dynamic replacement is complete, the new version of the table will be used for new sessions, but already-started sessions will continue to run under the rules from the old table.

See “RELOAD: Dynamically replacing a table” on page 135 for more information about RELOAD.

References to the end-of-file table from the routing file

Each SLU's routing file record contains the name of the EZAPPEFT table entry to be used for sessions involving that SLU. These table entry name references in the routing file can be explicitly coded through an ISPF panel or through an assembly using the EZAPPFL macro. If you do not code a table entry reference, the Network Print Facility sets up the routing file record to see the table entry named DFLTENTRY.

The structure of the end-of-file rules table (EZAPPEFT)

The statements to generate module EZAPPEFT should contain nothing except EZAPPEFM macros and comments. No other Assembler language statements should be coded. It should include at least one EZAPPEFM macro with TYPE=ENTRY and must end with exactly one EZAPPEFM macro with TYPE=END. Additional EZAPPEFM macros can be coded as needed.

IBM recommends that one EZAPPEFM macro with TYPE=ENTRY be coded with the macro label DFLTNTRY. This is the table entry name that is generated by default in any routing file record when the user does not specify an EOFNAME value in the ROUTING function of the EZAPPFL macro or an EOFNAME in an ISPF panel (see Figure 27 on page 90).

Defining end-of-file rules

You can code the EZAPPEFM macro to define end-of-file rules for each combination of SLU name, PLU name, and LU type. There are 4 types of EZAPPEFM macros you can code. TYPE=*value* is a required keyword identifying the function of the macro. Choose one of 4 valid values, as follows:

TYPE=ENTRY

Use this macro type to start a new table entry and optionally define entry-wide end-of-file defaults for one or more LU types. This function of the EZAPPEFM macro requires that you specify the name for the end-of-file rules table entry, *maclabel*. Do not code *maclabel* with any of the other types of EZAPPEFM (TYPE=SYSDFLT, TYPE=PLU, or TYPE=END).

TYPE=PLU

Use this macro to define end-of-file rules for one or more LU types when used with a specified PLU or set of PLUs. This macro type is optional. If used, several can follow an EZAPPEFM macro with TYPE=ENTRY.

TYPE=SYSDFLT

Use this macro type to define system-wide end-of-file defaults for one or more LU types. This macro type is optional. If used, there can be only one, and it must be the first EZAPPEFM macro in the module.

TYPE=END

Use this macro type to mark the end of the table. You must code exactly one EZAPPEFM macro with TYPE=END, and it must be the last EZAPPEFM macro in the module.

Each macro type is described separately, with separate syntax diagrams.

EZAPPEFM TYPE=ENTRY

TYPE=ENTRY indicates that this macro starts a new table entry and optionally defines entry-wide end-of-file defaults for one or more LU types.

Syntax

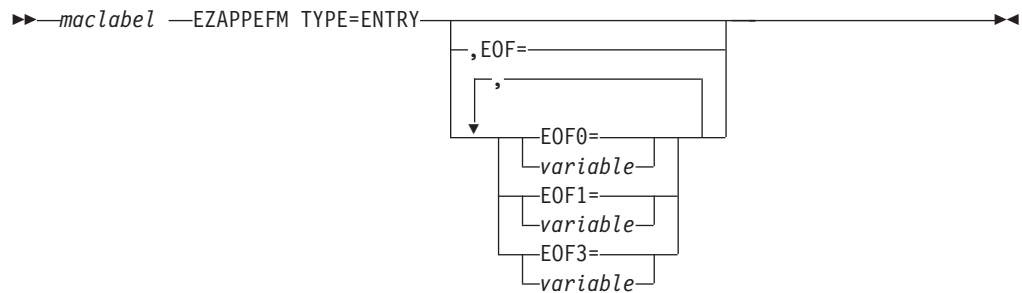

Parameters

maclabel

When you code TYPE=ENTRY, you must use *maclabel* to specify the name for the end-of-files rules table entry. Each table entry name must be unique and must conform to the rules for labels in assembler language. This name correlates to what the user specifies as the EOFNAME keyword in the ROUTING function of the EZAPPFL macro or as the EOFNAME field on the ISPF panel. See Figure 27 on page 90.

EOF=

Specifies an end-of-file rule for all LU types.

EOF0=, EOF1=, and EOF3=

Specifies an end-of-file rule for the single LU type 0, LU type 1, or LU type 3. The EOF0=, EOF1=, and EOF3= keywords can be coded together but cannot be used if the EOF= keyword is coded.

variable

The following variables can be coded for EOF, EOF0, EOF1, or EOF3:

- EB** Indicates end-of-bracket.
- EC** Indicates end-of-chain.
- ES** Indicates end-of-session.

(STRING,KEEP,*string*)

Indicates a character or hexadecimal end-of-file data string that remains as part of the print data. The value of *string* is coded as either C'character string' or X'hexadecimal string' and cannot exceed 56 bytes in length. The entire string must be received within a single RU, and that RU must be marked last-in-chain.

(STRING,DEL,*string*)

Indicates a character or hexadecimal end-of-file data string that is deleted prior to printing. The value of *string* is coded as either C'character string' or X'hexadecimal string' and cannot exceed 56 bytes in length. The entire string must be received within a single RU, and that RU must be marked last-in-chain.

(TIMER,*idleint*,*busyint*)

Indicates that files are closed according to the *idleint* and *busyint* values. This choice is allowed *only* with the EOF0 and EOF3 keywords for LU type 0 and LU type 3.

idleint

Required with TIMER. Indicates the idle time interval, in seconds. An open file is closed if this time passes without any

more input being received and the current file state indicates a reasonable stopping point (between chains).

busyint

Required with TIMER. Indicates the busy time interval, in seconds. An open file is closed at the next reasonable stopping point (between chains and at the top of a new page) if this time passes without any expirations of the idle interval timer. This interval prevents delays in printing output when a given session is sending print output almost continuously.

Usage notes

- With TYPE=ENTRY, use of the EOF or EOFx keywords is optional.
- For an SLU using this table entry, each of these keywords defines a default rule for all sessions using the specified LU types.

EZAPPEFM TYPE=PLU

TYPE=PLU indicates that this macro defines end-of-file rules for one or more LU types when used with a specified PLU or set of PLUs. Use of an EZAPPEFM macro with TYPE=PLU is optional. Several can be coded following an EZAPPEFM macro with TYPE=ENTRY.

Syntax

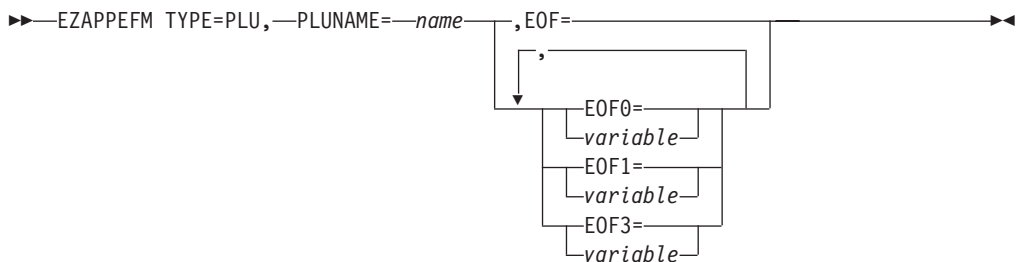

Parameters

name

Identifies a set of PLU names for which special end-of-file rules should be used instead of the default rules specified (or set by default) for the table entry. The following variations are allowed for the 1 to 8 byte name:

- The full name of a specific PLU.
- The partial name of a family of PLUs, with unspecified information replaced with * or ? characters.

EOF=, EOF0=, EOF1=, and EOF3=

At least one of these keywords is required. For an SLU using this table entry, each of these keywords defines a rule to be used for the specified LU types during any session in which the PLU name matches the macro's PLU name specification.

See the description of TYPE=ENTRY for the valid values of the EOF, EOF0, EOF1, and EOF3 *variable* and their coding rules.

Usage notes

Follow these rules when coding the PLUNAME:

- A single * represents any number of prefix or suffix characters. Using * in the middle of a partial PLU name is not allowed.
- A single ? represents exactly one character anywhere within the name.
- Do not mix * and ? characters in the same PLU name.
- There must be at least 1 significant character (other than * or ?) in the PLU name.

Examples

- Specify any PLU name starting with ABC:
PLUNAME=ABC*
- Specify any PLU name ending with ABC:
PLUNAME=*ABC
- Specify any PLU name containing the string ABC anywhere within the name:
PLUNAME=*ABC*
- Specify any PLU name containing the string AB in bytes 2 and 3 and the character C in byte 7:
PLUNAME=?AB???C?

EZAPPEFM TYPE=SYSDFLT

TYPE=SYSDFLT indicates that this macro defines system-wide end-of-file defaults for one or more LU types. Use of an EZAPPEFM macro with TYPE=SYSDFLT is optional; if coded, there can be only one, and it must be the first EZAPPEFM macro in the module.

Syntax

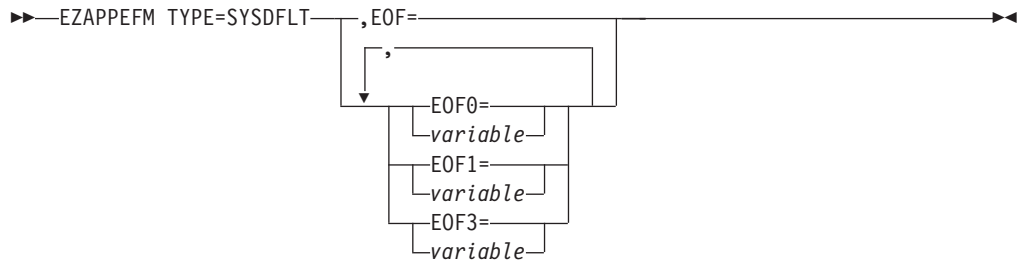

Parameters

EOF= EOF0= EOF1= EOF3=

At least one of these keywords is required. Each of these keywords defines a rule to be used as the system-wide default for the specified LU types.

See the description of TYPE=ENTRY for the valid values of the EOF, EOF0, EOF1, and EOF3 *variable* and their coding rules.

EZAPPEFM TYPE=END

TYPE=END indicates that this macro marks the end of the table. You must code exactly one EZAPPEFM macro with TYPE=END, and it must be the last EZAPPEFM macro in the module. With TYPE=END, no keywords are allowed.

Syntax

```

EZAPPEFM TYPE=END
  
```

Parameters

None

End-of-file table example

Figure 4 on page 35 shows an example of a user-modified end-of-file table. It is more extensive than what might be needed at an actual installation and does not resemble the IBM-supplied source code. The notes in the table are explained in "Example notes" on page 35.

```

***** Override of system default *****
* See note 2.
*
      EZAPPEFM TYPE=SYSDFLT,
      EOF0=(TIMER,15,900)
*
***** Start of 1st table entry *****
* See note 3.
*
DFLTENTRY EZAPPEFM TYPE=ENTRY
*
* See note 5a.
*
      EZAPPEFM TYPE=PLU,
      PLUNAME=SPECAPL1,
      EOF=ES
*
* See note 5b.
*
      EZAPPEFM TYPE=PLU,
      PLUNAME=IMSA*,
      EOF3=(TIMER,10,10800)
*
* See note 5c.
*
      EZAPPEFM TYPE=PLU,
      PLUNAME=IMS*,
      EOF3=(TIMER,15,900)
*
*
***** Start of 2nd table entry *****
* See note 4.
*
ENTRY2  EZAPPEFM TYPE=ENTRY,
      EOF3=(STRING,KEEP,C'End of Print Job')
*
* See note 6a.
*
      EZAPPEFM TYPE=PLU,
      PLUNAME=SPECAPL2,
      EOF1=EC
*
* See note 6b.
*
      EZAPPEFM TYPE=PLU,
      PLUNAME=??XYZ???,
      EOF0=(STRING,DEL,C'<<Temporary EOF String>>'),
      EOF3=(STRING,DEL,C'<<Temporary EOF String>>')
*
***** End of the table *****
*
      EZAPPEFM TYPE=END

```

Figure 4. Example of an End-of-File table

Example notes

1. Assembler source statements CSECT, RMODE, AMODE, and END are generated by the EZAPPEFM macros and, therefore, should not be coded by the user.
2. The EZAPPEFM macro with TYPE=SYSDFLT changes the system-wide default rule for LU0 sessions only. Under the new default rule for LU0, end-of-file is determined by the timer, with an idle interval of 15 seconds and a busy interval of 900 seconds (15 minutes).

For LU1 and LU3 sessions, nothing is specified; therefore, the normal system-wide default rules, EOF1=EB and EOF3=EB, are used for those LU types.

3. The EZAPPEFM macro with TYPE=ENTRY and the label DFLTENTRY defines the start of the first table entry. This entry is used by any SLU whose routing file record set up specified no end-of-file entry name or the entry name DFLTENTRY.

This macro does not contain any EOFx= keywords. Therefore, the default rules applying to this table entry are the same as the system-wide default rules explained above.

4. The EZAPPEFM macro with TYPE=ENTRY and the label ENTRY2 defines the start of the second table entry. This entry is used by any SLU whose routing file record specifies ENTRY2 as its end-of-file entry name.

This macro contains an EOF3= keyword, which overrides the system-wide default rule for LU3 sessions. Under the default rule, end-of-file is marked by the character string End of Print Job, and that string should be left as part of the print data.

For LU0 and LU1 sessions, nothing is specified; therefore, the system-wide default rules, EOF0=(TIMER,15,900) and EOF1=EB, apply to this table entry.

5. For all SLUs using the entry named DFLTENTRY, the following end-of-file rules are used:
 - a. If the PLU name is SPECAPL1, the print output for the entire session is treated as a single file for all LU types.
 - b. If the PLU name starts with IMSA:
 - On LU3 sessions, end-of-file is determined by the timer, with an idle interval of 10 seconds and a busy interval of 3 hours.
 - On LU0 sessions, the system-wide default rule, EOF0=(TIMER,15,900), is used
 - On LU1 sessions, the system-wide default rule, EOF1=EB, is used
 - c. If the PLU name does not start with IMSA but starts with IMS:
 - On LU3 sessions, end-of-file is timer-determined, with an idle interval of 15 seconds and a busy interval of 15 minutes.
 - On LU0 sessions, the system-wide default rule, EOF0=(TIMER,15,900), is used
 - On LU1 sessions, the system-wide default rule, EOF1=EB, is used
 - d. For all other PLU names, the Network Print Facility uses the default rules for the table entry.
6. For all SLUs using the entry named ENTRY2, the following end-of-file rules are used:
 - a. If the PLU name is SPECAPL2:
 - On LU1 sessions, each chain is treated as a separate file.
 - On LU0 sessions, the system-wide default rule, EOF0=(TIMER,15,900) is used
 - On LU3 sessions, this table entry's default rule, EOF3=(STRING,KEEP,C'End of Print Job'), is used
 - b. If the PLU name contains XYZ for its 3rd thru 5th bytes:
 - On LU0 and LU3 sessions, end-of-file is marked by the string <<Temporary EOF String>>, and that string is deleted before the file is printed.
 - On LU1 sessions, the system-wide default rule, EOF1=EB, is used.

- c. For all other PLU names, the Network Print Facility uses the default rules for the table entry.

Page format definition

In order to correctly handle the SCS print data received over an LU type 1 session, NPF must use a page format definition that is consistent with the target LPD printer. At session start-up, NPF determines the default page format for the session. As print data is processed, SCS commands within the print data stream might override some or all of the default page format information.

NPF uses a table to allow user specification of default page formats for different sessions. This user-replaceable table is defined using EZAPPPDPF macros and contains one or more entries with both horizontal and vertical page format data. A table entry is selectable on a per-SLU basis, via the default-page-format entry name in the SLU's routing file record.

The default page format table is packaged in the module EZAPPPFT. The EZAPPPFT module is shipped in two different forms:

- As a ready-to-use load module which contains an empty table. If used as is, this table causes NPF's hard-coded default page format values to be used for all sessions.
- As sample source code, which can be modified by the user to specify different page formats in selected cases, then assembled and used instead of the IBM-supplied module.

Installing the page format table

The default page format table is packaged in the module EZAPPPFT. The EZAPPPFT module is shipped in the form as a ready-to-use load module or as sample source code. The sample source code form can be modified by the user.

Procedure

To install a user-modified version of EZAPPPFT, proceed as follows:

1. Code the modified version of the module, using the IBM-supplied EZAPPPDPF macro. See "EZAPPPDPF" on page 38 for details about how to use the macro to create the table.
2. Assemble and link-edit the module into a partitioned data set different from that used for the IBM-supplied version of the module. This prevents the module from being deleted during any subsequent re-install of NPF.
3. On the JCL to start the VTAM capture point application, provide a STEPLIB DD statement specifying that partitioned data set. For example:

```
//STEPLIB DD DSN=xtable.loadlib, DISP=SHR
```

In this example, `xtable.loadlib` is the name of the partitioned data set that includes the tables as members. See "Operating the NPF VTAM capture point" on page 131 for a sample startup procedure.

Results

To dynamically replace the current version of EZAPPPFT with a new one while the NPF VTAM capture point application is running, respond to message EZY0837I with the following code:

```
nn, RELOAD EZAPPPFT
```

After the dynamic replacement is complete, the new version of the table will be used for new sessions, but already-started sessions will continue to run under the rules from the old table.

See “RELOAD: Dynamically replacing a table” on page 135 for more information about dynamically replacing a table.

References to the page format table from the routing file

Each SLU's routing file record optionally contains the name of the EZAPPPFT table entry to be used for sessions involving that SLU. These table entry name references in the routing file can be explicitly coded through the DEF PAGE FORMAT field in an ISPF panel (see Figure 27 on page 90) or through an assembly using the DFPNAME field of the EZAPPFL macro. If you do not code a table entry reference, the Network Print Facility sets up the routing file record with its table entry name set to blanks.

Determining the default page format

During session initiation, NPF checks the SLU's routing file record to see if a page format table entry name has been specified. Processing occurs as follows:

- If an entry name has been specified, the default page format data is copied from the named table entry. (If the named entry is not found, the session is rejected.)
- If the entry name is blank but the table contains an entry named DFLNTRY, the default page format data is copied from that entry.
- If the entry name is blank and the table does not have an entry named DFLNTRY, NPF uses hard-coded default page format values of MPP=80, MPL=1, LM=1, RM=80, TM=1, BM=1. (See “EZAPPDPF” for more information.)

The structure of the page format table (EZAPPPFT)

The page format table consists of a series of EZAPPDPF macros (one macro for each table entry), followed by an Assembler END statement.

EZAPPDPF

You can code the EZAPPDPF macro to define default page formats instead of using the SCS (SNA Character Stream) printer emulation's default page format.

Syntax

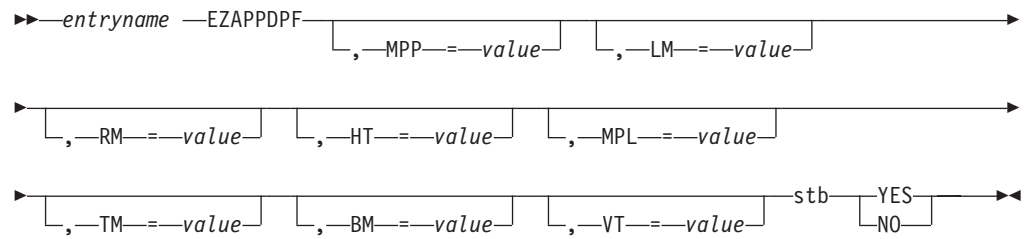

Parameters

entryname

A required parameter specifying the user-defined name for this page format table entry. Each *entryname* must be unique and must conform to the rules for labels in assembler language. This name correlates to what is specified as the DPFNAME keyword in the ROUTING function of the EZAPPFL macro or as the DEF PAGE FORMAT field on the ISPF panel. See Figure 27 on page 90.

MPP=value

Represents the maximum presentation position or line length. This can be zero or any integer from 1 through 255, inclusive. If this parameter is omitted or explicitly set to zero, Network Print Facility interprets this as though MPP=80 was coded.

LM=value

Identifies where the left margin starts. This can be zero or any integer from 1 through MPP, inclusive. If this parameter is omitted or explicitly set to zero, Network Print Facility interprets this as column 1.

RM=value

Identifies where the right margin starts. This can be zero or any value from LM to MPP, inclusive. If this parameter is omitted or explicitly set to zero, Network Print Facility interprets this as though RM had been set equal to the MPP value.

HT=value

Identifies positions of horizontal tabs. Specify this as a list HT=(t1,t2,...,tn). Each tab can be zero or any value from LM to RM, inclusive. A value of zero is valid and ignored. The application data stream can add additional tab stops but cannot remove default tab stops.

MPL=value

Represents the maximum presentation line (page length) in lines. This can be zero or any integer from 1 through 255, inclusive. If this parameter is omitted or explicitly set to zero, Network Print Facility interprets this as 1 line.

TM=value

Identifies where the top margin starts. The top margin is also used as the line number for Select Vertical Channel 1. This can be zero or any value from 1 to MPL, inclusive. If this parameter is omitted or explicitly set to zero, Network Print Facility interprets this as line 1.

BM=value

Identifies where the bottom margin starts. This can be zero or any value from TM to MPL, inclusive. If this parameter is omitted or explicitly set to zero, Network Print Facility interprets this as though BM had been set equal to the MPL value. A bottom margin of 1 suppresses automatic form feed when the application spaces past the bottom margin.

VT=value

Identifies the position of vertical tabs (also channels 2–12). Specify as a list $VT=(t1,t2,\dots,tn)$. The first 11 vertical tabs are also used as the line numbers for Select Vertical Channel 2 through 12. Each tab must be either zero or any value from TM to BM, inclusive. A value of zero is valid and ignored. The application data stream can add additional tab stops but cannot remove default tab stops.

STB.

The STB (suppress trailing blanks) parameter indicates if trailing blanks should be suppressed (STB=YES) or kept (STB=NO). STB=YES is the default and allows blanks (x'40') to be removed from the end of each print record for LU1 sessions. Because this option reduces the amount of network data traffic, it is the NPF method used prior to APAR PN87720.

If NPF is being used to transmit data to a device other than a printer and the x'40' data value represents something other than an empty print position, specify STB=NO and the trailing blanks will be sent.

Usage notes

- If MPP or RM is set lower than the actual LPD line length, the full width is not used. If they are set greater than the actual LPD line length, then LPD either truncates the long lines (losing data) or splits the lines and disrupts the vertical spacing of the file.
- If BM is set to 1, NPF inserts no automatic form feeds. Explicit form feed or Select Vertical Channel 1 in the data stream cause form feeds. If BM is greater than 1, NPF moves lines that might print below BM to TM on the next page.
- The Network Print Facility assumes LPD starts each file at the top of a new page. The Network Print Facility also assumes that form feed causes LPD to position at line 1 of the next page, so the Network Print Facility inserts blank lines at the top of each page whenever the top margin is greater than 1. MPL should be the total number of print lines on the page. For correct formatting, the number of printable lines $((BM + 1) - TM)$ needs to be correct. If this number is too small, the full page length is not used. If it is too large, LPD prints over the page or inserts additional form feeds.
- The SCS presentation position command permits printing outside of the margins but within the physical page dimensions. If your application is using SCS PP, then all margin settings must be consistent with LPD.

Page format table examples

Figure 5 on page 41 shows what a user-modified page format table might look like. This does not resemble the IBM-supplied source code.

```

***** This first macro starts the EZAPPPFT CSECT.
***** It uses all default values.
***** Bottom margin at line 1 suppresses automatic
***** form feed insertion.
    DEFAULT EZAPPPDF
    *
    *
***** The next macro specifies
***** format for printers that support 80 columns
***** by 66 lines and places print data in columns
***** 1 through 80 and lines 1 through 66.
***** Set no horizontal tabs. Set no vertical tabs.
***** Set CH01=1. (CH02 through CH12 are not set.)
    LETTER EZAPPPDF MPP=80,MPL=66      physical page columns, lines
    *
    *
***** The next macro specifies format for printers
***** that support 132 columns by 66 lines and places print
***** data in columns 10 through 120 and lines 6 through 60.
***** Set horizontal tabs in columns (10,) 25, 50, 75 and 100.
***** Set vertical tabs in lines (6,) 20, 30, 40 and 50.
***** Set CH01=6, CH02=20, CH03=30, CH04=40, and CH05=50.
***** (CH06-CH12 are not set.)
    WIDE    EZAPPPDF MPP=132,MPL=66,    physical page columns, lines X
            LM=10,RM=120,TM=6,BM=60,   page margins                X
            HT=(25,50,75,100),         horizontal tab stops        X
            VT=(20,30,40,50)           vertical tab stops
    *
    *
***** The next macro specifies format for printers
***** that support 255 columns by 255 lines.
***** Place print data in columns 15 through 250,
***** lines 10 through 250.
***** Set horizontal tabs in columns (15,) 25, 75 and 100.
***** Set vertical tabs in lines (10,) 15, 50, 100, 150, 250.
***** Set CH01=10, CH02=15, CH05=50, CH08=200, CH10=150,
***** and CH12=250.
***** (CH03, CH04, CH06, CH07, CH09, and CH11 are not set.)
    MAX     EZAPPPDF MPP=255,MPL=255,    physical page columns, lines X
            LM=15,RM=250,TM=10,BM=250, page margins                X
            HT=(25,100,0,75),          horizontal tab stops        X
            VT=(15,0,0,50,0,0,200,0,150,0,250) vertical tab stops
    *
    *
    END      ,                indicates end of module EZAPPPFT *****

```

Figure 5. Example of EZAPPPDF macro use

Chapter 4. Understanding the Network Print Facility files

Three files (VSAM key-sequenced data sets) serve as the foundation of the Network Print Facility processing. The *routing* and *options* files contain user-defined records that provide the Network Print Facility with the information it needs to route print data. The routing file defines where output will be printed, and the options file defines how it will print. The *queue* file contains temporary records created by the system to keep track of NPF print data sets.

In addition to these three files, NPF also maintains capture point and queue manager *log* files to track print data processing and a *trace* file to track NPF ISPF processing.

This section explains the type of information in each file and how the files relate to each other. You can find instructions for initializing and loading the NPF files in Chapter 5, “Creating the Network Print Facility files,” on page 51 and for updating them in Chapter 6, “Maintaining the Network Print Facility files with ISPF,” on page 69.

Note: The Network Print Facility maintains the integrity of the routing, options, and queue files in a shared file environment. Within a single MVS host, VSAM files can have shared access among the ISPF panels, an active VTAM capture point, an active FSS writer, and an active queue manager. The integrity mechanism assumes the files are allocated with at least SHAREOPTIONS (3,3) and will not perform correctly if less restrictive VSAM share options are specified. Users are strongly encouraged to use SHAREOPTIONS (4,3) to maintain data integrity.

The options file

An installation's print options are defined in the options file. Each record in the options file contains a set of valid LPR print options that are used when a job is printed. These options describe printers, type of data being printed, and instructions for printing the data. The LPR options can give instructions for a wide range of functions, such as whether or not to print headers, include margins, notify the sender, or translate the data. For specific information about the valid print options, see the LPR command in the z/OS Communications Server: IP User's Guide and Commands.

The Network Print Facility uses the options file with the routing file to determine *how* output will be printed. The routing file records contain pointers to options file records and thereby connect a set of print options to each routing. More than one routing file record can point to the same options file record.

The options file can also contain the name of a user-defined input record exit. This exit allows an installation to modify print data to meet specific output requirements. It can provide data manipulation capabilities beyond those provided by the LPR options, such as adding a banner page, modifying data by encryption, or deleting data. Use of any exit should not be done casually because it enables you to completely alter the data. See Chapter 7, “Writing exit routines to tailor the Network Print Facility,” on page 105 for more information.

Working with the options file

To work with the Network Print Facility's options file, first allocate space using the IDCAMS utility with the specifications shown in Figure 6.

Be sure to use the RECORDSIZE, SHAREOPTIONS, and KEYS values as defined. The size of the options file will be stable. Adjust FREESPACE based on experience with the files.

```
DEFINE CLUSTER (NAME(TCPIP.OPTIONS) VOLUMES(WRKL B2) -  
  CYLINDERS(1 1) -  
  IMBED -  
  RECORDSIZE(100 297) FREESPACE(0 15) -  
  INDEXED SHAREOPTIONS(4 3) -  
  UNIQUE NOWRITECHECK) -  
  DATA ( -  
    NAME(TCPIP.OPTIONS.DATA) -  
    KEYS(16 0) ) -  
  INDEX ( -  
    NAME(TCPIP.OPTIONS.INDEX) )
```

Figure 6. Sample of options file allocation

After the space has been allocated, you can initialize and load records into the options file using the EZAPPFL macro. You can also use the ISPF interface to load options file records or to maintain and correct them. The interface includes panels for you to add, copy, update or delete options file records.

Options file input fields

When creating or updating an options file record, you need to enter data for the following fields.

Table 4. Option file record input fields

ISPF Field	Macro Field	Definition
OPTIONS NAME	OPTNAME	A unique alphanumeric field containing the name of the options record.
INPUT RECORD EXIT	IREXIT	The name of the input record exit, if one is used.
LPR OPTIONS	OPTIONS	A list of the LPR options.

See “Running the EZAPPFL macro” on page 52 and “Maintaining the options file” on page 79 for detailed instructions.

The routing file

The Network Print Facility uses a routing file or table to determine *where* to route output that will be processed on remote printers. The routing file is a VSAM key-sequenced data set that contains information to route each data set to its LPD printer queue. You need one routing file entry (VSAM record) for each printer being used at the installation. Each routing file record is identified with a unique key field consisting of a major name and a minor name. For JES printers, the JCL DEST, CLASS, and FORMS parameters are used for the routing file key fields. For VTAM printers, LU name of the logical printer is used.

The routing file records contain a pointer to options file records. Multiple routing file records can point to the same record in the options file. Because the same destination printer can be used to print output with different characteristics, it can have many entries in the routing file. Each variation will require a separate routing file record pointing to the appropriate LPR options.

The routing file has two types of routings: normal and specific broadcast:

- Normal routings have one destination and send output to one printer.
- Specific broadcast routings have more than one destination and send output to multiple homogeneous printers. These printers of identical types (similar printers with different locations or destinations) have the same LPR options defined in the options file.

You can use the ISPF interface to modify the routing file when changes are required in your network, such as when printers are added or removed. This can be very useful if the network or a workstation stops functioning and the network administrator wants to reroute printer output.

Optionally, instead of altering the routing file, you can change the routing mechanism with a user exit. Use of any exit should not be done casually because it enables you to completely alter the data. See “Writing the general routing exit” on page 106 and “Writing the specific routing exit” on page 109 for more information on user-defined routing.

Working with the routing file

To work with the Network Print Facility's routing file, first allocate space using the IDCAMS utility with the specifications shown in Figure 7 on page 46. See the *VSAM Administration Guide* if you need more information about allocating VSAM data sets.

Be sure to use the RECORDSIZE, SHAREOPTIONS, and KEYS values as defined. The size of the routing file will be stable. Adjust FREESPACE based on experience with the files.

```

DEFINE CLUSTER (NAME(TCPIP.ROUTING) VOLUMES(WRKL2) -
  CYLINDERS(1 1) -
  IMBED -
  RECORDSIZE(150 636) FREESPACE(0 15) -
  INDEXED SHAREOPTIONS(4 3) -
  UNIQUE NOWRITECHECK) -
  DATA ( -
    NAME(TCPIP.ROUTING.DATA) -
    KEYS(20 0) ) -
  INDEX ( -
    NAME(TCPIP.ROUTING.INDEX) )

```

Figure 7. Sample of routing file allocation

After the space has been allocated, you can initialize and load records into the routing file using the EZAPPFL macro. You can also use the ISPF interface to load routing file records or to maintain and correct them. The interface includes panels for you to add, copy, update or delete routing file records.

Routing file input fields

When creating or updating a routing file record, you need to input data for the following fields.

Table 5. Routing file record input fields

ISPF Field	Macro Field
MAJKEY	An 8-byte alphanumeric field containing the major name for this routing. For JES, this corresponds to the DEST parameter in the JCL. For VTAM, this is the logical printer LU name.
MINKEY	An 8-byte alphanumeric field containing the minor name for this routing. For JES, this corresponds to the CLASS and FORMS parameters in the JCL. For VTAM, this is any value of your choice.
NDEST	The number of destinations in this routing. The number 1 indicates a normal route to one printer; a number greater than 1 indicates a specific broadcast to a set of homogenous printers.
RETAINS	The period of time the system should retain data for this routing after a successful transmission.
RETAINU	The period of time the system should retain data for this routing after an unsuccessful transmission, after the retry attempts are exhausted.
RETRYT	The period of time the system should wait before attempting a retry on this routing after an unsuccessful attempt to transmit.
RETRYL	The number of retry attempts to be made on this routing.
OPTNAME	The name of the options file record to be associated with this routing.
SREXIT	The name of a specific routing exit to be invoked.
INAME	The internet name or IP address of the destination host for the first or only destination. This field is case-sensitive.
PNAME	The name of the printer to be used at the remote host for the first or only destination. This field is case-sensitive.
LUCLASS	For VTAM only, the VTAM classes to which this LU belongs.
DPFNAME	For VTAM only, the name of an entry in the page format table.
EOFNAME	For VTAM only, the name of an entry in the end-of-file rules table.

See “Running the EZAPPFL macro” on page 52 and “EZAPPFL TYPE=ROUTING” on page 54 for detailed instructions.

The queue file

For each print job, a Network Print Facility capture point application creates a temporary QSAM data set that contains the print data. It also adds a record to the queue file to keep track of the temporary print data set.

The queue file is a VSAM key-sequenced data set with one record for each print job. The key of a queue file record is based on the major name, minor name, and the name of the temporary QSAM print data set. The queue file record also contains status fields plus the retry time, retain times, and retry limit found in the routing file record for that destination.

After a queue file record has been created, it comes under the control of the queue manager. Through the use of the NPF ISPF interface, you can affect how the queue manager handles the queue file and the temporary print data sets.

- The NPF queue manager scans the queue file at regular intervals to determine what processing is needed for each record. It can make initial send attempts, retry failed transmissions and update the queue file records to reflect this activity, hold print data sets and queue file records, or delete print data sets and queue file records that are no longer needed.
- A user can modify the queue file records through the ISPF interface. The interface allows you to change the data set status, the next date and time to retry the transmission, the retain times for successful and unsuccessful transmissions, the internet and printer name, and the LPR options. These changes will affect whether the print data sets are sent, held, or deleted and where they are sent.

It is possible for multiple NPF capture point applications to add records to the same queue file. However, only one NPF queue manager application should process any given queue file.

For a description of queue management, see “Managing the print queues” on page 97.

Working with the queue file

The only task required to set up the queue file is to allocate space using the IDCAMS utility with the specifications shown in Figure 8 on page 48. See the *VSAM Administration Guide* if you need more information about allocating VSAM data sets.

Be sure to use the RECORDSIZE, SHAREOPTIONS, and KEYS values as defined. The size of the queue file will be volatile. Adjust FREESPACE based on experience with the files.

```

DEFINE CLUSTER (NAME(TCPIP.QUEUE) VOLUMES(WRKL B2) -
  CYLINDERS(1 1) -
  IMBED -
  RECORDSIZE(870 1000) FREESPACE(0 15) -
  INDEXED SHAREOPTIONS(4 3) -
  UNIQUE NOWRITECHECK) -
DATA ( -
  NAME(TCPIP.QUEUE.DATA) -
  KEYS(62 0) ) -
INDEX ( -
  NAME(TCPIP.QUEUE.INDEX) )

```

Figure 8. Sample of queue file allocation

After the space has been allocated, the NPF capture point applications will create queue file records and the NPF queue manager will delete them at the appropriate time.

The log file

The Network Print Facility has a logging facility that writes messages in a log file to track the system activity regarding temporary print data sets. The messages record when a print data set is created, deleted, placed on the queue, and successfully or unsuccessfully transmitted. See “Network Print Facility logging” on page 145 for more information on these messages.

The log file data set has sequential organization (PS), a fixed block format (FBA), a logical record length (LRECL) of 133, and a block size (BLKSIZE) of 1330. Because the log file is not a VSAM data set, you do not need to allocate space for it. It can be dynamically allocated by specifying the log file with the //EZAPPLOG DD statement in the JCL to start the capture point applications and queue manager.

The log file cannot be shared. Therefore, you will need a unique log file for each startup procedure.

If the //EZAPPLOG DD statement is missing, the capture point applications will run but the system will not log the activity.

The SNAP File for the VTAM capture point

The NPF VTAM capture point optionally writes debugging information to the SNAP DD. Do not use this DD card unless requested by IBM service. The //EZAPPSNP DD can use SYSOUT=* or a QSAM data set with VBA or FBA format, a logical record length (LRECL) of 133, and any blocksize.

The SNAP file is specified with the //EZAPPSNP DD statement in the JCL to start the capture point. The SNAP file cannot be shared; therefore, you must specify a unique SNAP file for each startup procedure. If the //EZAPPSNP statement is missing, the system does not perform the debug SNAP trace.

The trace file

The NPF system also has a tracing facility to track the NPF internal processing that occurs during interactive ISPF sessions. The tracing facility can be turned on and off from the interface. It is normally used only for short periods of time when diagnosing problems and collecting information to forward to IBM service representatives.

Your system can have as many trace files as needed. The trace file that is used during an ISPF session is specified on the NPF Diagnosis Functions Panel. If a user specifies a data set that does not exist and the data set name begins with the user's TSO user ID, the system will dynamically allocate the file. All other trace files (those with a high-level qualifier other than the user ID) must be allocated with the following specifications: sequential organization (PS), a variable block format (VB), a logical record length (LRECL) of 132, and any block size (BLKSIZE).

Chapter 5. Creating the Network Print Facility files

The Network Print Facility provides a macro interface, EZAPPFL, to initialize the routing, options, and queue files. The program generated by the macro allows you several choices to initialize and load the files.

- Method 1: Initialize all three files. The macro loads each of them with a single record of binary zeroes.
- Method 2: Initialize all three files and add routing file and options file records at the same time. The program generated by the macro loads the queue file with a single record of binary zeroes and loads the routing and options files with the records you define.
- Method 3: Initialize the three files using either method 1 or 2 and then run the macro in update mode at another time to add records to the routing file and options file. When you run the macro in this mode, it appends records to existing files.

After the files have been initialized and loaded, you can use the ISPF interface to make additions or corrections to the routing and options files. You can choose to add all your routing and options records using the ISPF interface or just use it to make minor updates. In any case, you *must* run the EZAPPFL macro first to initialize and load the files.

Generally initializing and loading procedures

Before you use the ISPF interface to make additions or corrections to the routing and options files, you need to initialize and load the files first. The NPF VSAM files can be initialized only by using the EZAPPFL macro in a batch process.

Procedure

Perform these following steps to initiate the files.

1. Define the files using IDCAMS.
A sample that you can copy and modify is provided with the installation. See “Joint allocation of NPF VSAM files” on page 62.
Make note of the data set names you specify in this step and use them in the JCL for all other NPF jobs.
2. Code the EZAPPFL macro to define the load program. Use the macro with TYPE=INITIAL and MODE=LOAD and then issue a second macro with TYPE=FINAL to initialize the records. Optionally, use the macro with TYPE=ROUTING, TYPE=NXTDEST, and TYPE=OPTIONS to load routing and options records. See the syntax descriptions and examples in “Running the EZAPPFL macro” on page 52.
3. Run a job stream to assemble the macros and link and run the load program. See the sample shown in “Initialization of the NPF VSAM files” on page 64.
The program uses the following ddnames. These will be consistent in the JCL for all other NPF jobs.

```
ddname  
    File  
EZAPPRF  
    Routing
```

EZAPPOF
Options
EZAPPQF
Queue

Results

After the files have been initialized, you can add records to the options and routing files using the EZAPPFL macro or the NPF ISPF interface. The queue file is under system control and you cannot add records to it. The NPF ISPF interface allows you to view, modify, and delete queue file records so that you can administer your print queues.

There are two steps to the EZAPPFL macro update process:

1. Code the EZAPPFL macro to define the update program. Use TYPE=INITIAL with MODE=UPDATE, TYPE=ROUTING, TYPE=NXTDEST, TYPE=OPTIONS and TYPE=FINAL.
2. Run a job stream to assemble the macros, and then link and run the update program. See the sample shown in “Adding records to the NPF VSAM files” on page 66.

To interactively update the routing and options files and manage the print queues, see Chapter 6, “Maintaining the Network Print Facility files with ISPF,” on page 69.

Running the EZAPPFL macro

The EZAPPFL macro has five TYPE specifications that perform different functions. The syntax for each macro type is described separately.

TYPE=INITIAL

Defines the beginning of the program creation process and is required. You can specify MODE=LOAD to initialize and load the files or MODE=UPDATE to add records to the routing and options files.

TYPE=ROUTING

Defines a normal or specific broadcast routing. If routings are defined, they must be specified in the ascending alphanumeric sequence of the major and minor keys, and they must precede any options record definitions.

TYPE=NXTDEST

Defines an additional destination for a previous routing. The use of the NXTDEST type indicates a specific broadcast routing. When the number of destinations is greater than 1, the NXTDEST type must be used to define all of the destinations except the first (which is defined with the EZAPPFL TYPE=ROUTING macro). This indicates the addition of specific destinations.

TYPE=OPTIONS

Defines an options record. If options records are defined, they must be specified in ascending alphanumeric sequence (according to the OPTNAME parameter).

TYPE=FINAL

Defines the end of the program creation process and is required.

These examples show when and in what order you would code the various the EZAPPFL types. Macro types must be coded in the order shown, however, the other macro parameters within a specific type can be coded in any order.

Note: These examples are not complete. They do not include all the parameters needed to code a complete macro and the continuation indicator in column 72 required by the assembler program is omitted.

- To define a program that creates the binary zero records for all files:

```
EZAPPFL TYPE=INITIAL  
EZAPPFL TYPE=FINAL
```

- To define a program that creates 1 routing record and 1 options record:

```
EZAPPFL TYPE=INITIAL  
EZAPPFL TYPE=ROUTING  
EZAPPFL TYPE=OPTIONS  
EZAPPFL TYPE=FINAL
```

- To define a program that creates 1 routing record with 4 destinations and 1 options record:

```
EZAPPFL TYPE=INITIAL  
EZAPPFL TYPE=ROUTING  
EZAPPFL TYPE=NXTDEST  
EZAPPFL TYPE=NXTDEST  
EZAPPFL TYPE=NXTDEST  
EZAPPFL TYPE=OPTIONS  
EZAPPFL TYPE=FINAL
```

EZAPPFL TYPE=INITIAL

The INITIAL function indicates the start of the macro definition. It is required.

Syntax

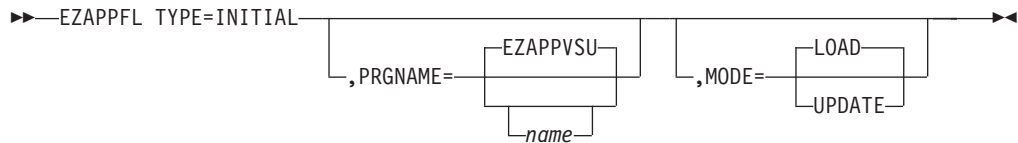

Parameters

PRGNAME=EZAPPVSU | *name*

Optional 8-character name assigned to the program being created. The default name is EZAPPVSU.

MODE=LOAD | UPDATE

Optional mode of operation.

LOAD

Specifies new files are being created. This is the default.

UPDATE

Specifies the routing and options files are being appended.

Examples

This example shows how to code the initial load.

```

EZAPPFL TYPE=INITIAL,           X
      PRGNAME=INITLOAD,        X
      MODE=LOAD

```

This example shows how to code an update to the routing and options files.

```

EZAPPFL TYPE=INITIAL,           X
      PRGNAME=ADDRECS,         X
      MODE=UPDATE

```

EZAPPFL TYPE=ROUTING

The ROUTING function defines either a normal or specific broadcast routing. If routing records are defined, they must be specified in ascending alphanumeric order according to the sequence of the major and minor keys.

Syntax

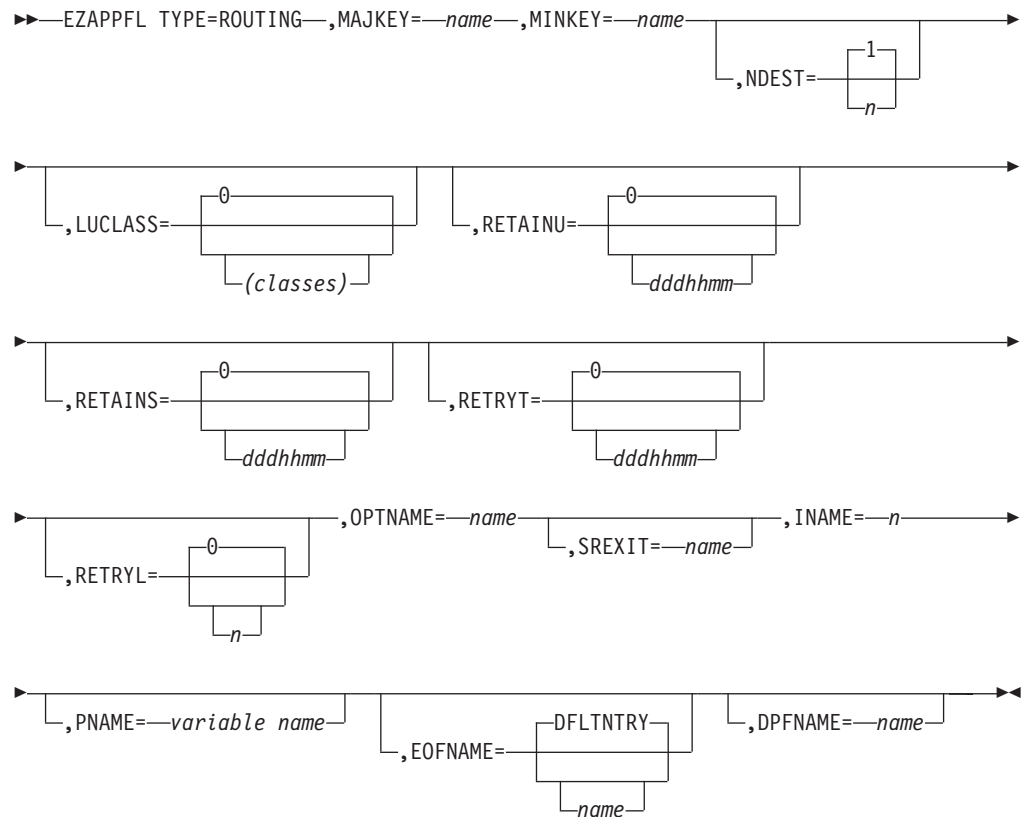

Parameters

MAJKEY=*name*

A 1 to 8 alphanumeric character description of the major key for the routing. For JES, this corresponds to the DEST parameter in the JCL. For VTAM, this is the logical printer LU name.

This required parameter corresponds to the MAJOR NAME value used in the ISPF panel interface. (See Figure 26 on page 89.)

MINKEY=*name*

A 1 to 8 alphanumeric character description of the minor key for the routing. For JES, this corresponds to 1 character for the CLASS and 4 characters or more for the FORMS parameters in the JCL. For VTAM, this parameter must be filled in because it is used for internal file access. It can contain any 1 to 8 alphanumeric characters of your choice but the first character must be alphabetic.

This required parameter corresponds to the MINOR NAME value used in the ISPF panel interface. (See Figure 26 on page 89.)

NDEST=1|*n*

A 2 byte numeric field specifying the number of destinations in this routing. More than one destination implies a specific broadcast routing to send output to multiple homogeneous printers. If the NDEST value is greater than 1, it requires an NXTDEST function of the EZAPPFL macro to specify the IP address and printer name for *each* of the other destinations. For example, a broadcast with 3 destinations requires one TYPE=ROUTING with NDEST=3 followed by two TYPE=NXTDEST macros.

If you omit NDEST, the system supplies a default of 1. This parameter corresponds to the NO OF DEST field in the NPF ISPF interface (see Figure 27 on page 90).

LUCLASS=0|(n1,n2,....)

The VTAM classes to which this LU belongs. Valid values are 1 - 64. The assigned classes are compared to the classes specified in the VTAM startup to determine which LUs are to be managed by a VTAM capture point. LUCLASS is used only to initialize a grouping of LUs. Parentheses are required to enclose one or more classes. Classes are separated by commas. This field corresponds to the field of the same name on the NPF ISPF interface (see Figure 27 on page 90).

LUCLASS is optional, the default is 0 (indicating a JES route.)

Do not specify this parameter for JES; for JES it is ignored.

RETAINU=0|dddhmm

The amount of time an unsuccessfully transmitted print file is retained for this routing after completing the specified number of retries. The format is *dddhmm* where:

ddd The number of days to retain the file (range 000-366)

hh The number of hours to retain the file (range 00-23)

mm The number of minutes to retain the file (range 00-59)

The total time to retain the file is the sum of the days, hours, and minutes. This field corresponds to the RETAIN TIME (U) field on the NPF ISPF interface (see Figure 27 on page 90).

This is optional, the default is 0.

RETAINS=0|dddhmm

The amount of time a successfully transmitted print file is retained for this routing. The format is *dddhmm* where:

ddd The number of days to retain the file (range 000-366)

hh The number of hours to retain the file (range 00-23)

mm The number of minutes to retain the file (range 00-59)

The total time to retain the file is the sum of the days, hours, and minutes.

This field corresponds to the RETAIN TIME (S) field on the NPF ISPF interface (see Figure 27 on page 90).

This is optional, the default is 0.

RETRYT=0|dddhmm

The retry time for this routing is the time between retries for a print file that has not been successfully sent. This field has the format *dddhmm* where:

ddd The number of days to wait before a retry (range 000-366)

hh The number of hours to wait before a retry (range 00-23)

mm The number of minutes to wait before a retry (range 00-59)

The total time to wait is the sum of the days, hours, and minutes. The maximum time allowed is 1 year. This field corresponds to the REPLY INTERVAL field on the NPF ISPF interface (see Figure 27 on page 90).

This is optional; the default is 0. The queue manager will treat the default of 0 as a 30-second interval.

RETRYL=0|n

The maximum number of retries for a print file. The maximum limit is 32 768. This field corresponds to the REPLY LIMIT field on the NPF ISPF interface (see Figure 27 on page 90).

This is optional, the default is 0.

OPTNAME=name

The 1–16 alphanumeric name of the options record. This is the name referred to in the OPTIONS function of the EZAPPFL macro by the OPTNAME parameter. It must be unique and can have up to 16 alphanumeric characters (A–Z and 0–9). If the name is not 16 characters, it is padded to the right with blanks.

This field corresponds to the OPTIONS NAME field on the NPF ISPF interface (see Figure 27 on page 90).

This is a required parameter.

SREXIT=name

The 1 to 8 alphanumeric character name of the specific routing exit associated with this routing. If the name is not 8 characters, it is padded to the right with blanks. This field corresponds to the ROUTING EXIT field on the NPF ISPF interface (see Figure 27 on page 90).

This parameter is optional, the default is no exit.

INAME=n

The internet name or IP address of this destination. This required parameter can be up to 255 characters in length, is case-sensitive, and corresponds to the HOST NAME/IP ADDRESS field on the NPF ISPF interface (see Figure 27 on page 90).

Be sure to specify the host in the same way on all routing records which specify the same printer. This is necessary to ensure correct FIFO (First In, First Out) handling of print jobs for that printer.

PNAME=name

The printer name for this destination. This required parameter can be up to 255 characters in length, is case-sensitive, and corresponds to the PRINTER NAME field on the NPF ISPF interface (see Figure 27 on page 90).

DPFNAME=name

For VTAM only, 1 - 8 byte alphanumeric name of an entry in the page format table. The default is blank. This corresponds to DEF PAGE FORMAT used in the ISPF panel interface. (See Figure 27 on page 90.) You can find information about the page format table in “Page format definition” on page 37.

For JES, this parameter is ignored.

EOFNAME=name

For VTAM only, 1 - 8 byte alphanumeric name of an entry in the end-of-file rules table. The default is DFLNTRY. This corresponds to EOFNAME used in the ISPF panel interface. (See Figure 27 on page 90.) You can find information about the page format table in “End-of-File definition” on page 28.

For JES, this parameter is ignored.

Usage notes

- The first character of both the major and minor name must be alphabetic.

- Code TYPE=ROUTING macros in ascending alphanumeric order based on the MAJKEY and MINKEY parameters.
- All TYPE=ROUTING macros must follow the TYPE=INITIAL macro.
- All TYPE=ROUTING macros must precede any EZAPPFL TYPE=OPTIONS macros.
- If the NDEST value is greater than 1 (indicating a specific broadcast routing) and it is not followed by the correct number of TYPE=NXTDEST macros, the Network Print Facility does not process the routing and issues console error message EZY0633E. For example, if a TYPE=ROUTING macro with NDEST=2 is not followed by one TYPE=NXTDEST macro, the routing will not be processed.
- To avoid the loss of output data sets until you are certain that they have been successfully sent and printed, define values for the retain time (RETAINS and RETAINU), retry time (RETRYT), and retry limit (RETRYL) parameters. If none of these values are specified, a print data set sent to this routing will not be saved regardless of whether or not it was successfully transmitted.

Factors to consider when coding these parameters:

- The NPF FSS writer and NPF VTAM capture point applications store print jobs in temporary sequential data sets as they are received. The capture point applications pass control to the &halpp queue manager, which manages the sending of the print data to LPD. RETAINS, RETAINU, RETRYT, and RETRYL affect how the queue manager handles these temporary data sets.
- RETRYL and RETRYT pertain to files that are not successfully delivered to their target LPD server. These determine how many times and how often the queue manager should attempt to send this file.

Set RETRYT at a reasonable interval for network or LPD problems to clear. Set RETRYL to control how many times to try resend before assuming that the problem is persistent.

- RETAINU and RETAINS specify a period of “administrative” time to allow files that are lost through LPD print queue failures, or by users, to be resent. They provide time for system administrators to examine failed jobs for problem determination and correction.

RETAINS affects all data sets that are eligible for deletion after they were successfully sent. RETAINU affects all data sets that are eligible for deletion after they have exhausted their retry count.

Examples

This example shows the coding for a normal routing for VTAM.

```

EZAPPFL TYPE=ROUTING,           X
    MAJKEY=ELU10100,           X
    MINKEY=VTAM,               X
    RETAINS=5,                 X
    RETAINU=10,                X
    RETRYT=5,                  X
    RETRYL=2,                  X
    NDEST=1,                   X
    OPTNAME=OPTION2,           X
    LUCLASS=(1,8,16,32,35,64), X
    DPFNAME=PGFORMAT1,        X
    EOFNAME=EOFPARM1,         X
    SREXIT=SPCEXIT2,          X
    INAME=MVS1.TCP.RALEIGH.IBM.COM, X
    PNAME=LPT1

```

EZAPPFL TYPE=NXTDEST

The NXTDEST function defines additional destinations on a specific broadcast routing. This routing must first have an EZAPPFL TYPE=ROUTING macro with the number of destinations greater than 1. Each additional destination in a broadcast routing requires a TYPE=NXTDEST entry.

Syntax

```
▶▶EZAPPFL TYPE=NXTDEST—, INAME=—inet_name—, PNAME=—printer_name—▶▶
```

Parameters

INAME=*inet_name*

The internet name or IP address of this destination. This required parameter is case-sensitive.

PNAME=*printer_name*

The printer name for this destination. This required parameter is case-sensitive.

Usage notes

- All TYPE=NXTDEST macros must follow a TYPE=ROUTING macro that defines a specific broadcast routing.
- All TYPE=ROUTING and TYPE=NXTDEST macros must precede any TYPE=OPTIONS macros.
- The number of TYPE=NXTDEST macros must be 1 less than the value specified in the NDEST parameter in the preceding TYPE=ROUTING macro. If this is not true, the Network Print Facility does not process the routing and issues console error message EZY0633E. For example, if a TYPE=ROUTING macro with NDEST=2 is not followed by one TYPE=NXTDEST entry, the routing will not be processed.

Examples

This example shows a specific broadcast routing with 2 destinations for the JES FSS writer.

```
        EZAPPFL TYPE=ROUTING,                X
          MAJKEY=LOCAL,                      X
          MINKEY=C1185,                      X
          RETAINS=5,                         X
          RETAINU=10,                        X
          RETRYT=5,                          X
          RETRYL=2,                          X
          NDEST=2,                           X
          OPTNAME=OPTION1,                   X
          SREXIT=SPECEXIT,                   X
          INAME=9.67.112.25,                  X
          PNAME=LPT1
*
        EZAPPFL TYPE=NXTDEST,                 X
          INAME=9.67.112.34,                  X
          PNAME=LPT2
```

EZAPPFL TYPE=OPTIONS

The OPTIONS function defines an options record. If options records are defined, they must be specified in ascending alphanumeric sequence.

Syntax

▶—EZAPPFL TYPE=OPTIONS—,OPTNAME=*optname*—
└,OPTIONS=*options*—┘
└,IREXIT=*variable name*—┘▶

Parameters

OPTNAME=*optname*

The name of the options record. This is the name referred to in the EZAPPFL TYPE=ROUTING macro by the OPTNAME parameter. It must be unique and can have up to 16 alphanumeric characters (A–Z and 0–9). If the name is not 16 characters, it is padded to the right with blanks.

This parameter provides the key for the VSAM record and is required. It corresponds to the OPTIONS NAME field in the NPF ISPF interface. See Figure 18 on page 82.

OPTIONS=*options*

The list of LPR options associated with this routing. This field can have up to 253 characters. Multiple options must be separated by blanks and enclosed in single quotation marks. Values and defaults can be found in the z/OS Communications Server: IP User's Guide and Commands . The only requirement specific to NPF is that you provide the JOB parameter in full (not just the first letter J) and specify the jobname or use a comma in its place. For example, these are valid:

```
job sms11,pass=****,for=usr11b
```

```
job ,pass=****
```

```
JOB SMS11
```

These are not valid:

```
job pass=****,for=usr11b
```

```
JOB PASS=****
```

```
job
```

Any options you specify here override default LPR options. If you want the default set of options supplied by LPR, do not specify the OPTIONS parameter. Some options will always be provided by NPF, such as jobname and user name for JES, user name for VTAM.

This corresponds to the LPR OPTIONS field in the NPF ISPF interface. See Figure 18 on page 82.

IREXIT=*name*

Up to an 8-character name of the input record exit **if one is to be used**. This corresponds to the INPUT RECORD EXIT field in the NPF ISPF interface. See Figure 18 on page 82. This parameter is optional. The default is no exit.

Usage notes

- The input record exit can insert less than 208 characters into the LPR options field.
- LPR translates EBCDIC files to an ASCII data stream for LPD. LPR supports translation to several languages or a user-supplied translation. For translation to

a particular language, specify the appropriate LPR translation option. For more about translation options, see the LPR options described in z/OS Communications Server: IP User's Guide and Commands and the using translation tables topic in z/OS Communications Server: IP Configuration Guide.

Examples

This example shows how to code one LPR option and an input exit.

```

EZAPPFL TYPE=OPTIONS,           X
      OPTNAME=OPTION1,         X
      IREXIT=INRECEX1,        X
      OPTIONS=TRACE

```

This example shows how to code multiple LPR options.

```

EZAPPFL TYPE=OPTIONS,           X
      OPTNAME=OPTION2,         X
      OPTIONS='burst header'

```

EZAPPFL TYPE=FINAL

The FINAL function defines the end of the program creation process and is required.

Syntax

▶▶—EZAPPFL TYPE=FINAL—▶▶

Parameters

None

Required parameters and default values for EZAPPFL

The following table provides a summary of the required parameters and default values for the EZAPPFL macro interface:

Table 6. EZAPPFL macro parameters and defaults

Macro	Parameter	Required or Default
TYPE=INITIAL	PRGNAME	default=EZAPPVSU
	MODE	default=LOAD
TYPE=ROUTING	MAJKEY	required
	MINKEY	required
	NDEST	default=1
	LUCLASS	default=0
	RETAINS	default=0
	RETAINU	default=0
	RETRYT	default=0
	RETRYL	default=0
	OPTNAME	required
SREXIT	default=blank (no exit)	
	DPFNAME	default=blank

Table 6. EZAPPFL macro parameters and defaults (continued)

Macro	Parameter	Required or Default
	EOFNAME	default=DFLTNTRY
TYPE=NXTDEST	INAME	required
	PNAME	required
TYPE=OPTIONS	OPTNAME	required
	IREXIT	default=blank (no exit)
	OPTIONS	default=blank (default LPR options)

Sample NPF initialization jobs

The following sample jobs can be found in *hlq*.SEZAINST. Copy them from this library and update them as needed to suit your configuration.

DELALLOC

Jointly allocates the routing, options, and queue files by deleting and defining the VSAM data sets

ROUTEOPT

Initializes and loads the routing, options, and queue files after they have been allocated

ADDRTOPT

Adds records to the routing and options files after they have been initialized.

Joint allocation of NPF VSAM files

You can copy this sample from *hlq*.SEZAINST(DELALLOC) and use it to jointly allocate the routing, options, and queue files by deleting and defining the VSAM data sets.

Execution note

You will need to modify the data set names as required by your installation.

```
//DELALLOC JOB
//* -----*
//*
//* COPYRIGHT = NONE
//*
//* SMP/E Distribution Name: EZAEC042 *
```

/* This is sample JCL to delete and allocate the VSAM data sets
 /* needed for the Network Print Facility.
 /*
 /* To delete the VSAM data sets required by the Network Print
 /* Facility use step 1 of this JCL.
 /*
 /* To allocate the VSAM data sets required by the Network Print
 /* Facility use step 2 of this JCL.
 /*
 /* WARNING:
 /*
 /* * Do not use this JCL to delete a queue file containing
 /* records for one or more temporary print data sets.

```

/**      Without that queue file, there will be no way for the
/**      ISPF panel interface to list those temporary data sets
/**      or for the queue manager to manage their further
/**      processing.
/** -----*
/** Step 1 :
/**
/**      The VSAM data sets deleted in this step are :
/**
/**      "Routing file" data sets
/**              TCPIP.ROUTING
/**              TCPIP.ROUTING.DATA
/**              TCPIP.ROUTING.INDEX
/**      "Options file" data sets
/**              TCPIP.OPTIONS
/**              TCPIP.OPTIONS.DATA
/**              TCPIP.OPTIONS.INDEX
/**      "Queue file" data sets
/**              TCPIP.QUEUE
/**              TCPIP.QUEUE.DATA
/**              TCPIP.QUEUE.INDEX
/** -----*
//DEL      EXEC PGM=IDCAMS
//SYSPRINT DD SYSOUT=*
//SYSIN    DD *
          DELETE -
            TCPIP.ROUTING -
            PURGE -
            ERASE
          DELETE -
            TCPIP.OPTIONS -
            PURGE -
            ERASE
          DELETE -
            TCPIP.QUEUE -
            PURGE -
            ERASE
/** -----*
/** Step 2 :
/**
/**      The VSAM data sets allocated in this step are :
/**
/**      "Routing file" data sets
/**              TCPIP.ROUTING
/**              TCPIP.ROUTING.DATA
/**              TCPIP.ROUTING.INDEX
/**      "Options file" data sets
/**              TCPIP.OPTIONS
/**              TCPIP.OPTIONS.DATA
/**              TCPIP.OPTIONS.INDEX
/**      "Queue file" data sets
/**              TCPIP.QUEUE
/**              TCPIP.QUEUE.DATA
/**              TCPIP.QUEUE.INDEX
/** -----*
//CREATE   EXEC PGM=IDCAMS
//SYSPRINT DD SYSOUT=*
//SYSIN    DD *
          DEFINE CLUSTER (NAME(TCPIP.ROUTING) VOLUMES(WRKL2) -
            CYLINDERS(1 1) -
            IMBED -
            RECORDSIZE(150 636) FREESPACE(0 15) -
            INDEXED SHAREOPTIONS(4 3) -

```

```

        UNIQUE NOWRITECHECK) -
        DATA ( -
            NAME(TCPIP.ROUTING.DATA) -
            KEYS(20 0) ) -
        INDEX ( -
            NAME(TCPIP.ROUTING.INDEX) )
    DEFINE CLUSTER (NAME(TCPIP.OPTIONS) VOLUMES(WRKL2) -
        CYLINDERS(1 1) -
        IMBED -
        RECORDSIZE(100 297) FREESPACE(0 15) -
        INDEXED SHAREOPTIONS(4 3) -
        UNIQUE NOWRITECHECK) -
        DATA ( -
            NAME(TCPIP.OPTIONS.DATA) -
            KEYS(16 0) ) -
        INDEX ( -
            NAME(TCPIP.OPTIONS.INDEX) )
    DEFINE CLUSTER (NAME(TCPIP.QUEUE) VOLUMES(WRKL2) -
        CYLINDERS(1 1) -
        IMBED -
        RECORDSIZE(870 1000) FREESPACE(0 15) -
        INDEXED SHAREOPTIONS(4 3) -
        UNIQUE NOWRITECHECK) -
        DATA ( -
            NAME(TCPIP.QUEUE.DATA) -
            KEYS(62 0) ) -
        INDEX ( -
            NAME(TCPIP.QUEUE.INDEX) )

```

Initialization of the NPF VSAM files

You can copy this sample from *hlq*.SEZAINST(ROUTEOPT) and use it to initialize and load the routing, options, and queue files after they have been allocated.

This job assembles the EZAPPFL macros and then links and executes the load program.

Execution notes

- You will need to include your own macro parameters to define your routing and options file records.
- You will need to modify the data set names specified by //EZAPPRF, //EZAPPOF, and //EZAPPQF, as required by your installation.

```

//ROUTEOPT JOB
//* -----*
//*                                     *
//*  COPYRIGHT = NONE                   *
//*                                     *
//*  SMP/E Distribution Name: EZAEC0YY  *
//*                                     *
//*  This is sample JCL to assemble, link and execute the file load *
//*  program for the routing, options and queue data sets used by *
//*  the Network Print Facility.        *
//*                                     *
//*  In this sample, the names of the routing, options and queue *
//*  files are:                         *
//*                                     *
//*      TCPIP.ROUTING                  *
//*      TCPIP.OPTIONS                  *
//*      TCPIP.QUEUE                    *
//*                                     *
//*  All three are assumed to have been created and initialized *
//*  prior to the use of this JCL.     *
//*                                     *

```



```

/** -----*
/** Step 1 : *
/** * *
/** This step assembles the File Load Program *
/** * *
/** This is the area where you will enter the routing and options *
/** information. *
/** -----*
//ASM EXEC PGM=IEV90,PARM='OBJECT,TERM',REGION=1024K
//SYSLIB DD DSN=TCPIP.SEZACMAC,DISP=SHR
// DD DSN=SYS1.MACLIB,DISP=SHR
// DD DSN=SYS1.MODGEN,DISP=SHR
//SYSUT1 DD UNIT=SYSDA,SPACE=(CYL,(5,1))
//SYSUT2 DD UNIT=SYSDA,SPACE=(CYL,(2,1))
//SYSUT3 DD UNIT=SYSDA,SPACE=(CYL,(2,1))
//SYSPUNCH DD DUMMY
//SYSLIN DD DSN=SYS1.&&OBJSET,DISP=(MOD,PASS),UNIT=SYSDA,
// SPACE=(80,(500,50))
//SYSTEM DD SYSOUT=*
//SYSPRINT DD SYSOUT=*
//SYSIN DD *
* -----*
* Must start with INITIAL parm *
* -----*
EZAPPFL TYPE=INITIAL, X
PRGNAME=ROUTEPT, X
MODE=LOAD
* -----*
* Example of a normal route for VTAM *
* -----*
EZAPPFL TYPE=ROUTING, X
MAJKEY=ELU10100, X
MINKEY=VTAM, X
RETAINS=5, X
RETAINU=10, X
RETRYT=5, X
RETRYL=2, X
NDEST=1, X
OPTNAME=OPTION2, X
LUCCLASS=(1,8,16,32,35,64), X
DPFNAME=PGFORMT1, X
EOFNAME=EOFPARM1, X
INAME=MVS1.TCP.RALEIGH.IBM.COM, X
PNAME=LPT1
* -----*
* Example of a specific broadcast route for the JES writer *
* (with 2 destinations) *
* -----*
EZAPPFL TYPE=ROUTING, X
MAJKEY=LOCAL, X
MINKEY=C1185, X
RETAINS=5, X
RETAINU=10, X
RETRYT=5, X
RETRYL=2, X
NDEST=2, X
OPTNAME=OPTION1, X
INAME=9.67.112.25, X
PNAME=LPT1
* -----*
* Example of second destination for the specific broadcast *
* route defined above *
* -----*
EZAPPFL TYPE=NXTDEST, X
INAME=QUIDDITY, X
PNAME=LPT2
* -----*

```

```

*      Examples of options entries
* -----*
*      OPTION1
* -----*
*          EZAPPFL TYPE=OPTIONS,
*              OPTNAME=OPTION1,
*              IREXIT=INRECEX1,
*              OPTIONS=TRACE
* -----*
*      OPTION2
* -----*
*          EZAPPFL TYPE=OPTIONS,
*              OPTNAME=OPTION2,
*              OPTIONS='TRACE CLASS E'
* -----*
*      Must end with FINAL parm
* -----*
*          EZAPPFL TYPE=FINAL
*          END
/*
/** -----*
/** Step 2 :
/**
/** This step links the File Load Program
/** -----*
/** LKED EXEC PGM=IEWL,PARM='LIST,MAP,XREF',
/** REGION=512K,COND=(4,LT)
/**SYSPRINT DD SYSOUT=*
/**SYSUT1 DD SPACE=(CYL,(5,1)),DISP=(NEW,PASS),UNIT=SYSDA
/**SYSLMOD DD DSNNAME=&&GOSET(GO),DISP=(MOD,PASS),UNIT=SYSDA,
/** SPACE=(1024,(50,1,1))
/**SYSLIN DD DSNNAME=&&OBJSET,DISP=(OLD,DELETE)
/**LINK.SYSIN DD DUMMY
/** -----*
/** Step 3 :
/**
/** This step executes the File Load Program
/** -----*
/**LOAD EXEC PGM=*.LKED.SYSLMOD,REGION=512K,COND=(4,LT)
/**EZAPPRF DD DSN=TCPIP.ROUTING,DISP=OLD
/**EZAPPOF DD DSN=TCPIP.OPTIONS,DISP=OLD
/**EZAPPQF DD DSN=TCPIP.QUEUE,DISP=OLD
/**SYSPRINT DD SYSOUT=*
/**SYSABEND DD SYSOUT=*
/**SYSDUMP DD SYSOUT=*

```

Adding records to the NPF VSAM files

You can copy this sample from *hlq*.SEZAINST(ADDRTOPT) and use it to add (append) routing and options records after the files have been allocated and initialized. You can append records if the routing and options files were loaded with binary zero records or with actual data.

This job assembles the EZAPPFL macros and then links and executes the load program.

Execution notes

- You will need to include your own macro parameters to define your routing and options file records.
- You will need to modify the data set names specified by //EZAPPRF, //EZAPPOF, and //EZAPPQF as required by your installation.

```

//ADDRTOPT JOB
//* -----*
//*                                     *
//* COPYRIGHT = NONE                                     *
//*                                     *
//* SMP/E Distribution Name: EZAEC0YR                   *
//*                                     *
//* This is sample JCL to add routing and options records to *
//* existing Network Print Facility VSAM data sets.      *
//*                                     *
//* In this sample, the names of the routing, options and queue *
//* files are:                                           *
//*                                     *
//*          TCPIP.ROUTING                             *
//*          TCPIP.OPTIONS                             *
//*          TCPIP.QUEUE                               *
//*                                     *
//* All three are assumed to have been created and initialized *
//* prior to the use of this JCL.                       *
//* -----*
//* Step 1 :                                           *
//*                                     *
//* This step assembles the File Load Program           *
//*                                     *
//* This is the area where you will enter the routing and options *
//* information.                                         *
//* -----*
//ASM          EXEC PGM=IEV90,PARM='OBJECT,TERM',REGION=1024K
//SYSLIB       DD DSN=TCPIP.SEZACMAC,DISP=SHR
//            DD DSN=SYS1.MACLIB,DISP=SHR
//            DD DSN=SYS1.MODGEN,DISP=SHR
//SYSUT1       DD UNIT=SYSDA,SPACE=(CYL,(5,1))
//SYSUT2       DD UNIT=SYSDA,SPACE=(CYL,(2,1))
//SYSUT3       DD UNIT=SYSDA,SPACE=(CYL,(2,1))
//SYSPUNCH     DD DUMMY
//SYSLIN       DD DSNAME=&&OBJSET,DISP=(MOD,PASS),UNIT=SYSDA,
//            SPACE=(80,(500,50))
//SYSTEM       DD SYSOUT=*
//SYSPRINT     DD SYSOUT=*
//SYSIN        DD *
* -----*
* Must start with INITIAL parm                         *
* -----*
*          EZAPPFL TYPE=INITIAL,                        X
*          PRGNAME=ADDRTOPT,                          X
*          MODE=UPDATE
* -----*
* Example of a normal route for VTAM                   *
* -----*
*          EZAPPFL TYPE=ROUTING,                       X
*          MAJKEY=DLU10100,                             X
*          MINKEY=VTAM,                                 X
*          RETAINS=10,                                  X
*          RETAINU=20,                                  X
*          RETRYT=5,                                    X
*          RETRYL=2,                                    X
*          NDEST=1,                                     X
*          OPTNAME=LUOPTN3,                             X
*          LUCLASS=(1,2,3,4,5,6,7,8,9,10,12,13,14,15,16,64), X
*          INAME=9.67.112.25,                           X
*          PNAME=LPT1
* -----*
* Example of a normal route for the JES writer         *
* -----*
*          EZAPPFL TYPE=ROUTING,                       X
*          MAJKEY=LOCAL,                                X

```

```

MINKEY=A1185, X
RETAINS=5, X
RETAINU=10, X
RETRYT=5, X
RETRYL=2, X
NDEST=1, X
OPTNAME=OPTION3, X
INAME=MVS1.TCP.RALEIGH.IBM.COM, X
PNAME=LPT1 X
* -----*
* Example of an options entry *
* -----*
* LUOPTN3 *
* -----*
EZAPPFL TYPE=OPTIONS, X
OPTNAME=LUOPTN3, X
OPTIONS=TRACE
* -----*
* OPTION3 *
* -----*
EZAPPFL TYPE=OPTIONS, X
OPTNAME=OPTION3, X
OPTIONS='TRACE CLASS E'
* -----*
* Must end with FINAL parm *
* -----*
EZAPPFL TYPE=FINAL
END

/*
/** -----*
/** Step 2 : *
/** *
/** This step links the File Load Program *
/** *
/** -----*
//LKED EXEC PGM=IEWL,PARM='LIST,MAP,XREF',
// REGION=512K,COND=(4,LT)
//SYSPRINT DD SYSOUT=*
//SYSUT1 DD SPACE=(CYL,(5,1)),DISP=(NEW,PASS),UNIT=SYSDA
//SYSLMOD DD DSNNAME=&&G0SET(GO),DISP=(MOD,PASS),UNIT=SYSDA,
// SPACE=(1024,(50,1,1))
//SYSLIN DD DSNNAME=&&0BJSET,DISP=(OLD,DELETE)
//LINK.SYSIN DD DUMMY
/** -----*
/** Step 3 : *
/** *
/** This step executes the File Load Program *
/** *
/** -----*
//LOAD EXEC PGM=*.LKED.SYSLMOD,REGION=512K,COND=(4,LT)
//EZAPPRF DD DSN=TCPIP.ROUTING,DISP=SHR
//EZAPPOF DD DSN=TCPIP.OPTIONS,DISP=SHR
//EZAPPQF DD DSN=TCPIP.QUEUE,DISP=SHR
//SYSPRINT DD SYSOUT=*
//SYSABEND DD SYSOUT=*
//SYSDUMP DD SYSOUT=*

```

Chapter 6. Maintaining the Network Print Facility files with ISPF

After the routing, options, and queue files have been created and initialized, you can use the Network Print Facility ISPF interface panels to add or update the routing and options records and manage your print queues.

This section shows you how to:

- Enable the NPF interface
- Set defaults for your interactive session
- Manage the print queue by browsing, updating, and deleting queue file records
- Maintain the routing and options files by adding, copying, updating, and deleting records

Enabling the Network Print Facility ISPF interface

The Network Print Facility ISPF interface panels can be used to add or update the routing and options records and manage your print queues. You can enable the Network Print Facility ISPF interface by adding NPF to the ISPF Primary Option Menu.

Procedure

To enable the Network Print Facility ISPF interface, perform the following steps.

1. Provide library access

You must provide access to the NPF ISPF libraries. You can do this by modifying the TSO logon procedures or running a CLIST.

2. Define default data set names

You can define data set names for the routing, options, queue, and trace files that are accessed during ISPF sessions. You can use an initialization CLIST to set different defaults for each user, for specific groups of users, or for all users.

3. Add NPF to the ISPF Primary Option Menu

To be able to select the NPF interface from your ISPF Primary Option Menu, you need to update the menu and processing sections of the ISR@PRIM module.

Results

Note: You must be able to scroll forward and back in the ISPF interface to be able to access specific broadcast records. Be sure that your keyboard has specific keys for **Page Up** and **Page Down** or that you have set PF keys for these functions using option 0.3 on the ISPF Primary Option Menu. UP or FORWARD will work for scrolling forward. DOWN, BACK, or BACKWARD will work for scrolling back.

Providing library access

You must provide access to the NPF ISPF libraries. You can do this by either:

- Adding DD statements to your TSO logon procedure
- Allocating the data sets with a CLIST

Network Print Facility ISPF data sets

The following libraries are partitioned data sets required for operation of the NPF ISPF interface in any MVS/TSO environment.

SEZAPENU (Panel Library):

hlq.SEZAPENU includes all the data panels required for NPF. The members in this library are:

- EZAPPN (Network Print Facility Data Panels)
- EZAPPH (Network Print Facility Help Panels)

SEZAMENU (Message Library):

hlq.SEZAMENU includes all the messages for NPF. Its member is EZYPR (Network Print Facility ISPF messages).

Using the TSO logon procedure

One method of providing access to the NPF ISPF libraries is to specify the NPF ISPF data sets in the TSO logon procedure.

Add the following DD statements to your TSO logon procedure and replace TCPIP with your installation's high-level qualifier.

If you need further information about the TSO logon procedure, see the *ISPF*

```
//ISPLIB      DD  DSN=TCPIP.SEZAPENU,DISP=SHR
//ISPLIB      DD  DSN=TCPIP.SEZAMENU,DISP=SHR
```

Figure 9. TSO logon procedure

Dialog Management Guide and Reference

Using a CLIST

Another method of providing access to the NPF ISPF interface is to run a CLIST to allocate the NPF ISPF data sets. Copy *hlq*.SEZAINST(NPFINIT) into your system CLIST library and make changes to the sections that allocate and deallocate the libraries.

Defining default data set names

If you do not define your own defaults, the NPF ISPF interface will use the following data set names as the defaults:

Routing file

TCPIP.ROUTING

Options file

TCPIP.OPTIONS

Queue file

TCPIP.QUEUE

Trace file

userid.NPFISPF.TRACE

You can change the default data set names for these files by updating and implementing the appropriate section in the initialization CLIST. You can set one default for all users or set different defaults for individual users.

Whether you use the system settings or define your own values, the NPF interface will retrieve the defaults at the start of an interactive session and display them on the panels. These values represent the actual data sets the interface will access. The users can change to other data sets by keying over the displayed values or they can go back to the initial defaults by clearing the fields.

To change the defaults, copy *hlq.SEZAINST(NPFINIT)* into your system CLIST library and make changes by following the instructions for this section.

You can run this CLIST as a stand-alone process or invoke it from the ISPF Primary Option Menu. See "Updating ISR@PRIM processing section" on page 75 for instructions on invoking it from the menu.

```

PROC 0
CONTROL NOFLUSH NOMSG MAIN
/*****/
/*                                          */
/* CLIST NAME:      NPFINIT                */
/*                                          */
/* COPYRIGHT = NONE.                        */
/*                                          */
/* SMP/E Distribution Name: EZAEC050       */
/*                                          */
/* DESCRIPTION:                               */
/*   This is a sample CLIST which does initialization processing */
/*   for NPF's ISPF panel interface and then invokes the NPF main */
/*   panel. This CLIST can be modified as necessary to match */
/*   specific installation requirements.     */
/*                                          */
/*   This CLIST can be invoked via a stand-alone TSO command, */
/*   or it can be invoked from the system's main ISPF panel.  */
/*                                          */
/*   Much of the code within this CLIST is optional and can be */
/*   deleted if desired. This optional code is divided into */
/*   3 sections as follows:                  */
/*                                          */
/* * Section 1: Sets up default file names for routing, */
/*   options, queue and trace file processing on NPF's ISPF */
/*   panel interface. For access to each type of file, the */
/*   default name will be used when no previously-used name */
/*   for that file has been saved by the current user id.   */
/*                                          */
/* * Section 2: Allocates the libraries containing the panels */
/*   and modules required by NPF's ISPF panel interface.    */
/*                                          */
/* * Section 3: Restores the ISPF environment by deallocating */
/*   the libraries allocated by the code in Section 2.      */
/*                                          */
/*   Set the &DODFLTS variable to 'Y' or 'N' to indicate */
/*   whether the default-setting logic should be executed.   */
/*                                          */
/*   Set the &DOLIBS variable to 'Y' or 'N' to indicate */
/*   whether the library-allocation logic should be executed. */
/*                                          */
/*****/
SET &DODFLTS = Y           /* Set defaults */
SET &DOLIBS = N           /* Do not allocate libraries */
/*****/
/*                                          */
/*           O P T I O N A L   C O D E   -   S E C T I O N   1 */
/*                                          */
/* The code in this section initializes default file names for */
/* NPF's routing, options, queue and/or trace files. These default */
/* names can be set the same for all users, or they can be set to */
/* different values for different user ids.                    */

```

```

/*                                                                    */
/* If this section is deleted or bypassed, NPF's panel code          */
/* will set its own hard-coded default values as documented in      */
/* the NPF manual.                                                 */
/*                                                                    */
/* Notes:                                                            */
/*                                                                    */
/* 1. The &CLSTUPDT# variable below controls whether this CLIST's   */
/*    default-setting logic is executed or bypassed when the CLIST   */
/*    gets control under a particular user id:                      */
/*                                                                    */
/*    * Set &CLSTUPDT# to a new and higher value each time this    */
/*      CLIST's default-setting logic is changed.                   */
/*                                                                    */
/*    * As each user id executes the CLIST, the &CLSTUPDT# value   */
/*      will be compared to the value saved when that user id's    */
/*      defaults were last updated:                                  */
/*                                                                    */
/*      - An updated &CLSTUPDT# value will cause the CLIST to     */
/*        execute its default-setting logic.                          */
/*                                                                    */
/*      - An unchanged &CLSTUPDT# value will cause the CLIST     */
/*        to bypass its default-setting logic.                        */
/*                                                                    */
/* 2. This sample CLIST assumes that you want default file         */
/*    names as follows:                                             */
/*                                                                    */
/*    * For the routing file:                                       */
/*      - For user id = USER6, file name = XYZ.PERS.ROUTING       */
/*      - For all other users, file name = TCPIP.NPF.ROUTING       */
/*                                                                    */
/*    * For the options file:                                       */
/*      - For user id = USER6, file name = XYZ.PERS.OPTIONS       */
/*      - For all other users, file name = TCPIP.NPF.OPTIONS       */
/*                                                                    */
/*    * For the queue file:                                         */
/*      - For user id = USER2 or USER3 or USER17,                 */
/*        file name = ABC.ACCT.QUEUE                                */
/*      - For user id = USER5, file name = PQR.PAYROLL.QUEUE      */
/*      - For user id = USER6, file name = XYZ.PERS.QUEUE         */
/*      - For all other users, file name = TCPIP.NPF.QUEUE        */
/*                                                                    */
/*    * For the trace file:                                         */
/*      - For all users, file name = userid.NPF.TRACE             */
/*                                                                    */
/******
IF &DODFLTS = Y THEN +
DO
  SET &CLSTUPDT# = 1 /* Set current update number */
  ISPEXEC VGET NPFUPDT# PROFILE /* Get last-saved update number*/
  IF &NPFUPDT# ^= &CLSTUPDT# THEN +
  DO
    SET &NPFUPDT# = &CLSTUPDT# /* Save the current */
    ISPEXEC VPUT NPFUPDT# PROFILE /* ... update number value */
    /*-----*/
    /* Set defaults applicable to most or all user ids */
    /*-----*/
    SET &NPFDFLTR = TCPIP.NPF.ROUTING
    SET &NPFDFLTO = TCPIP.NPF.OPTIONS
    SET &NPFDFLTT = &SYSUID..NPF.TRACE
    /*-----*/
    /* Set defaults for single user ids or sets of user ids */
    /*-----*/
    SELECT (&SYSUID)
      WHEN (USER2 | USER3 | USER17) +
        SET &NPFDFLTQ = ABC.ACCT.QUEUE
      WHEN (USER5) +

```



```

        SET &NPFDFTQ = PQR.PAYROLL.QUEUE
    WHEN (USER6) +
        DO
            SET &NPFDLTR = XYZ.PERS.ROUTING
            SET &NPFDFTO = XYZ.PERS.OPTIONS
            SET &NPFDFTQ = XYZ.PERS.QUEUE
        END
    OTHERWISE +
        SET &NPFDFTQ = TCPIP.NPF.QUEUE
    END
/*-----*/
/* Save the default values in the user id's Profile pool */
/*-----*/
ISPEXEC VPUT (NPFDLTR NPFDFTO NPFDFTQ NPFDFTT) PROFILE
END

END
/*****/
/*          E N D   O F   S E C T I O N   1          */
/*****/
/*****/
/*          O P T I O N A L   C O D E   -   S E C T I O N   2          */
/*-----*/
/* The code in this section allocates the libraries required by */
/* NPF's ISPF panel interface. */
/*-----*/
/* Note: This library-allocation function can also be accomplished */
/* by adding appropriate DD cards to each user id's TSO logon */
/* procedure. If that technique is used, the code in Sections 2 */
/* and 3 should be bypassed or deleted from this CLIST. */
/*-----*/
IF &DOLIBS = Y THEN +
    DO
        /*-----*/
        /* NPF libraries concatenation */
        /*-----*/
        ISPEXEC LIBDEF ISPLLIB DATASET ID('TCPIP.SEZAPENU') COND
        ISPEXEC LIBDEF ISPLMLIB DATASET ID('TCPIP.SEZAMENU') COND
    END
/*****/
/*          E N D   O F   S E C T I O N   2          */
/*****/
/*-----*/
/*          R E Q U I R E D   C O D E          */
/*-----*/
ISPEXEC SELECT PANEL(EZAPPMP) /* Invoke the NPF main panel */
/*****/
/*          O P T I O N A L   C O D E   -   S E C T I O N   3          */
/*-----*/
/* The code in this section restores the ISPF library environment */
/*-----*/
/* Note: This section is required if Section 2 is present, but */
/* should be bypassed or deleted if Section 2 is bypassed or deleted*/
/*-----*/
IF &DOLIBS = Y THEN +
    DO
        /*-----*/
        /* Restore the ISPF environment */
        /*-----*/
        ISPEXEC LIBDEF ISPLLIB
        ISPEXEC LIBDEF ISPLMLIB
    END
/*****/
/*          E N D   O F   S E C T I O N   3          */
/*****/

```

```

/*****/
/*-----*/
/*           R E Q U I R E D   C O D E           */
/*-----*/
RETURN                                           /* Return to invoker */

```

Adding NPF to the ISPF primary option menu

ISR@PRIM is a member in the ISPLIB library. If you want your users to have access to the NPF ISPF interface from the ISPF Primary Option Menu, you must update ISR@PRIM in two places:

- In the menu section (Part 1 of ISR@PRIM) to have an option for NPF to appear on the ISPF Primary Option Menu. See the example shown in Figure 10.
- In the processing section (Part 2 of ISR@PRIM) to have the selection invoke the NPF interface. You can optionally have the selection run the initialization CLIST before invoking the NPF interface. See the examples shown in Figure 11 on page 75 and Figure 12 on page 76.

After you have updated ISR@PRIM, the option you added for NPF will appear on the ISPF Primary Option Menu following the next ISPF logon.

Updating ISR@PRIM menu section

To have an option for the NPF ISPF interface appear on the ISPF Primary Option Menu, add an entry in the menu section of ISR@PRIM.

You can choose any value. This example uses the letter **N**.

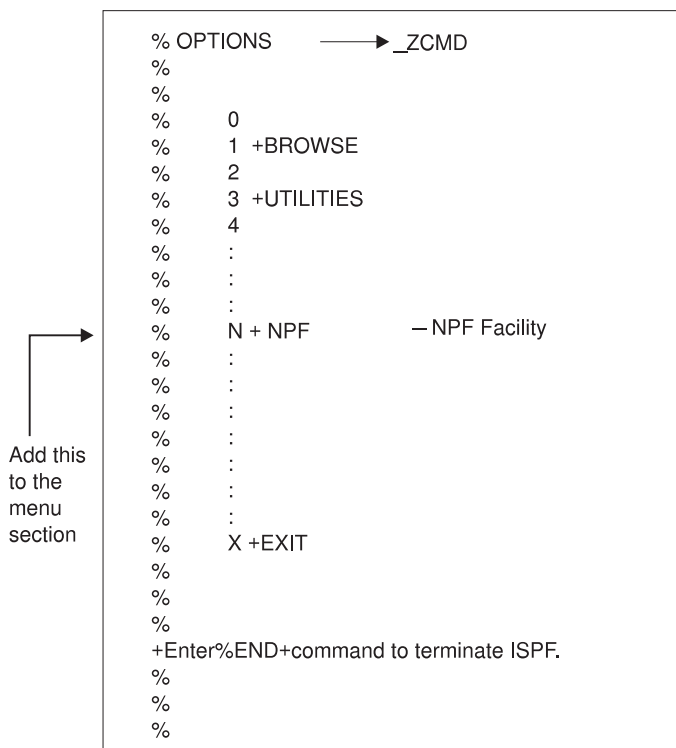

Figure 10. ISPF primary option menu ISR@PRIM (Part 1 - menu section)

Updating ISR@PRIM processing section

If you *do not* want to run the initialization CLIST before invoking the NPF interface, use the following example to update the processing section of ISR@PRIM. In this example, the selection **N** invokes the NPF main menu panel, EZAPPMP.

```
) INIT
.....
.....

) PROC
.....
.....
&ZEL = TRANS( TRUNC ($ZCMD,':')
              0, 'PANEL(ISPOPTA)
              1,
              2, 'PANEL(ISRUTIL)'
              3,
              :
              :
              N, 'PANEL (EZAPPMP)'
              :
              T, 'PGM(ISPTUTOR) PARM(ISR0000)'
              :
              X, 'EXIT'
              *, '?')
.....
.....
.....
.....
)END
```

Add this to the processing section

Figure 11. ISPF primary option menu ISR@PRIM (Part 2a.- processing section)

If you *do* want to run an initialization CLIST before invoking the NPF interface, use the following example to update the processing section of ISR@PRIM. In this example, the selection **N** invokes the NPFINIT CLIST, which in turn invokes the NPF main menu panel, EZAPPMP.

```

) INIT
.....
.....

) PROC
.....
.....
.....
&ZEL = TRANS( TRUNC ($ZCMD, '.')
                0, 'PANEL(ISPOPTA)
                1,
                2, 'PANEL(ISRUTIL)'
                3, .....
                :
                :
                N, 'CMD(%NPFINIT) NOCHECK'
                :
                T, 'PGM(ISPTUTOR) PARM(ISR0000)'
                :
                X, 'EXIT'
                *, '?')
.....
:
:
:
)END

```

Add this
to the
processing
section

Figure 12. ISPF primary option menu ISR@PRIM (Part 2b.- processing section)

Starting an NPF ISPF interface session

The NPF ISPF interface allows you to set options for your interactive session, maintain the routing and options files, and manage the print queue.

- You can configure the interface by setting the delete confirmation option for the routing, options, and queue files. You can also turn NPF tracing on or off.
- You can maintain the routing and options files by adding, copying, updating, or deleting records.
- You can manage your print queues by browsing the queue file, updating records to affect when (and if) the system will try to resend a print job, rerouting print jobs, and requesting queue records to be deleted.

Begin all NPF interactive sessions at the Network Print Facility Primary Option Menu shown in Figure 13 on page 77. To display this menu, select your installation-specific NPF option from the ISPF Primary Option Menu. See your system administrator if this option is not on your ISPF menu.

```

----- Network Print Facility Primary Option Menu -----
OPTION ==>

Type an option or ISPF command and press Enter.

    S SET DEFAULTS - NPF ISPF Defaults
    R ROUTING      - Printer Routing Configuration
    O OPTIONS      - Printer Options Configuration
    Q QUEUE        - Print Queue Operations

    D DIAGNOSIS   - Diagnosis Functions
    X EXIT        - Exit NPF

```

Figure 13. Network Print Facility Primary Option Menu (EZAPPMP)

From this menu you can proceed to all the NPF panels and perform the tasks required to maintain your files and print queues.

Task	Selection
Turn delete confirmation on or off	S SET DEFAULTS
Turn NPF ISPF tracing on or off	D DIAGNOSIS
Add, update, copy or delete printer routes	R ROUTING
Add, update, copy or delete printer options	O OPTIONS
Maintain your print queues	Q QUEUE
Return to the ISPF Primary Option Menu	X EXIT

Helpful reminders

- As you work with the NPF ISPF interface, keep these ideas in mind:
- Before you use the panel interface, ensure you have created the options, routing, and queue files correctly and that they contain valid information.
 - Only people with system administrator or network administrator authority should change the routing file or options file records.
 - Use only the NPF ISPF interface, not the ISPF VSAM editing option, to edit the options, routing, and queue files.
 - Keep a list of your general use printers for reference.
 - Plan to carefully record the keys (MAJOR, MINOR and OPTIONS NAME) of the records you create, as NPF does not provide a list of records by key field.
 - HOST NAME/IP ADDR (Host Name or IP Address) and PRINTER NAME are mixed case fields. All other fields are uppercase.
 - There is online help available for quick assistance on each NPF panel, on each input field, and on each message.
 - The characters you see in the fields on the panels in this book have these meanings:
 - XXXXXX** The field is filled in by the system. You cannot change the values.

SSSSSS The field displays a default or current value. You can change these values if you choose.

(blank space)

Some of these fields are required and you must enter data; others are optional and can remain blank.

Setting the NPF ISPF defaults

To display the NPF ISPF Defaults panel shown in Figure 14, enter **S** on the Network Print Facility Primary Option menu.

```
----- NPF ISPF Defaults -----  
COMMAND ==>  
  
Enter '/' to select option or clear field to deselect option.  
  
    Confirm Delete Request for: / Routing Records  
                               / Options Records  
                               / Queue Records
```

Figure 14. NPF ISPF Defaults (EZAPPDCP)

This panel allows you to choose whether or not you want to be prompted with a confirmation window when you delete records from your files. You can set these options at any time during your interactive session.

You have the option of requesting delete confirmation panels for each of three NPF files. Although delete confirmation panels provide an extra step in the deletion process and take more time, they allow you to change your mind or back out of a request made in error.

To enable this option, enter a / (backslash) next to your choices. Every time you delete these types of records, you will get a panel asking you to verify your request. The delete confirmation panel will *not* appear when the queue manager deletes queue file records that have expired.

To stop delete confirmation, clear the selection field.

Setting trace options

To display the NPF Diagnosis Functions panel shown in Figure 15 on page 79, enter **D** on the Network Print Facility Primary Option menu.

Table 8. Option file ISPF input fields (continued)

ISPF Field	Definition
INPUT RECORD EXIT	The name of the input record exit, if one is used. This can be up to 8-characters. This field can be blank if no exit is used.
LPR OPTIONS	A list of the LPR options with each option separated by blanks. This field can contain up to 255 characters. If the field is left blank, the default LPR options will be used for routings that specify this record. The valid LPR options are described in z/OS Communications Server: IP User's Guide and Commands.

Adding records to the options file

You can add options records by creating a new record (new key field and new data).

Procedure

Follow these steps to add a new options record, creating a new record:

1. Select **A** from the NPF Printer Options Configuration panel to display the NPF Options Record Key Field panel (Figure 17)

```

----- NPF Options Record Key Field -----
COMMAND ==>

ENTER OPTIONS RECORD KEY FIELD FOR ADD:

      OPTIONS NAME  ==>

PRESS ENTER TO DISPLAY THE NEXT PANEL

```

Figure 17. NPF Options Record Key Field Panel (EZAPPN1)

2. Specify the **OPTIONS NAME**. Enter the name you want to give the set of print options you are adding. This name will be the key field for this options record. This name must be unique and can have up to 16 alphanumeric characters. (For Hewlett Packard printers, the printer name must be text and all lowercase characters.)
3. Press **Enter** to display the NPF Options Record panel (Figure 18 on page 82).

```
ADD ----- NPF Options Record -----  
COMMAND ==>  
  
OPTIONS NAME          ==> XXXXXXXXXXXXXXXXX  
INPUT RECORD EXIT    ==>  
LPR OPTIONS          ==>
```

Figure 18. NPF Options Record Panel (EZAPPN7)

4. Enter the LPR OPTIONS and an optional INPUT RECORD EXIT.

Note: Because the OPTIONS NAME is the record key, it cannot be changed. If entered it incorrectly or misspelled it, you must cancel this record and start over.

5. To save the record, press **Enter**, and then press the END PF key or enter **END** on the command line to return.
6. To return without saving the record, enter **CANcel** on the command line.

Copying records in the options file

You can create a new options file record by copying data from an existing record to a new record. You do not have to rekey long lists of LPR options.

Procedure

Follow these steps to copy an options file record from an existing record:

1. Select **C** from the NPF Printer Options Configuration panel to display the NPF Options Record Key Field Copy panel (Figure 19 on page 83)

```

----- NPF Options Record Key Field Copy -----
COMMAND ==>

ENTER OPTIONS RECORD KEY FIELDS FOR COPY:

      OLD OPTIONS NAME  ==>
      NEW OPTIONS NAME  ==>

      PRESS ENTER TO DISPLAY THE NEXT PANEL

```

Figure 19. NPF options record key field copy panel (EZAPPN4)

2. Specify the OLD and NEW OPTIONS NAME. Enter the name of the existing record you are copying in the OLD field. Enter the name of the record you are creating in the NEW field. This is the key field for the new options record.
3. Press **Enter** to display the NPF Options Record panel (Figure 20)

```

COPY ----- NPF Options Record -----
COMMAND ==>

      OPTIONS NAME      ==> XXXXXXXXXXXXXXXXXXXX
      INPUT RECORD EXIT ==> XXXXXXXX
      LPR OPTIONS       ==> XXXXXXXXXXXXXXXXXXXX

      PRESS ENTER TO COPY THE ABOVE OPTIONS

```

Figure 20. NPF options record panel (EZAPPN7)

This panel displays the old key field in OPTIONS NAME and the data to be copied from the existing record. *The information on this panel cannot be changed.*

4. Press **Enter** to copy the new options file record.

Updating records in the options file

You can update any existing options file record. Use the same rules for updating data as for entering new data in these fields.

Procedure

Follow these steps to update an options file record:

1. Select **E** from the NPF Printer Options Configuration panel to display the NPF Options Record Key Field Edit panel (Figure 21)

```
----- NPF Options Record Key Field -----  
COMMAND ===>  
  
ENTER OPTIONS RECORD KEY FIELD FOR EDIT:  
  
      OPTIONS NAME  =====>  
  
      PRESS ENTER TO DISPLAY THE NEXT PANEL
```

Figure 21. NPF options record key field edit panel (EZAPPN1)

2. Specify the **OPTIONS NAME**. Enter the name of options record you want to update. This name is the key field of this options record.
3. Press **Enter** to display the NPF Options Record Edit panel (Figure 22 on page 85)

```
EDIT ----- NPF Options Record -----  
COMMAND ==>  
  
OPTIONS NAME          ==> XXXXXXXXXXXXXXXX  
INPUT RECORD EXIT    ==> SSSSSSS  
LPR OPTIONS           ==> SSSSSSSSSSS
```

Figure 22. NPF options record edit panel (EZAPPN7)

4. Change the INPUT RECORD EXIT and LPR OPTIONS as appropriate to update the record.

Note: Because the OPTIONS NAME is the record key, it cannot be changed. If you need to correct it, you must delete this record and start over.

5. To save the changes, press **Enter**, and then press the **END PF** key or enter **END** on the command line to return.
6. To return without saving the changes, enter **CANcel** on the command line.

Deleting records from the options file

You should not delete any options file records that are being used by active routings. Before you delete an options file record, ensure that no routing file records have this options record specified in their OPTIONS NAME field.

Procedure

Follow these steps to delete an options file record:

1. Select **D** from the NPF Printer Options Configuration panel to display the NPF Options Record Key Field panel (Figure 23 on page 86)

```

----- NPF Options Record Key Field -----
COMMAND ==>

ENTER OPTIONS RECORD KEY FIELD FOR DELETE:

      OPTIONS NAME  ==>

      PRESS ENTER TO DISPLAY THE NEXT PANEL

```

Figure 23. NPF options record key field panel (EZAPPN1)

2. Specify the **OPTIONS NAME**. Enter the name of the options record you want to delete. This name is the key field for the options record.
3. Press **Enter** to display the NPF Options Record Panel (Figure 24).

```

DELETE ----- NPF Options Record -----
COMMAND ==>

      OPTIONS NAME           ==> XXXXXXXXXXXXXXXXXXXX
      INPUT RECORD EXIT     ==> XXXXXXXXXXXXX
      LPR OPTIONS           ==> XXXXXXXXXXXXXXXXXXXX

      PRESS ENTER TO DELETE THE ABOVE OPTIONS

```

Figure 24. NPF options record panel (EZAPPN7)

4. Verify that this is the record you want to delete.
5. Press **Enter** to delete it.

If you requested delete confirmation for the options file, you will get a panel that allows you to continue or stop the deletion. See “Setting the NPF ISPF defaults” on page 78 for instructions to turn delete confirmation on and off.

Maintaining the routing file

The NPF ISPF interface allows you to maintain your routing file by providing you with panels to browse, add, copy, update, or delete routing file records.

To display the NPF Printer Routing Configuration panel shown in Figure 25, enter **R** on the Network Print Facility Primary Option menu.

```

----- NPF Printer Routing Configuration -----
COMMAND ==>

VSAM DSN ==> SSSSSSSSSSSSSSSS          USERID - XXXXXXXX
                                           DATE   - XXXXXXXX
                                           TIME   - XXXXXXXX

OPTION ==>

  A ADD    - Add printer routes
  B BROWSE - Browse printer routes
  C COPY   - Copy printer routes
  D DELETE - Delete printer routes
  E EDIT   - Edit printer routes

```

Figure 25. NPF printer routing configuration panel (EZAPPRCP)

This panel displays your user ID, and the current day and date in the format for which your system was configured. It also displays the routing file (VSAM DSN) you will access.

The file displayed is either the default file or the last file you used. If you want to work with a different routing file, enter a fully-qualified data set name in this field. If you want to reset this field back to the default, clear the field and press **ENTER**.

From this panel you can proceed to browse, add, update, or delete records in the specified routing file.

Note: This file must be created and initialized before you can perform any of these tasks.

Table 9. The NPF routing file functions

Task	Selection
Add a new printer route to the routing file	A Add printer routes
Browse a printer route in the routing file	B Browse printer routes
Copy an old printer route to a new one	C Copy printer routes
Delete an existing printer route from the routing file	D Delete printer routes
Update an existing printer route	E Edit printer routes

In each of these tasks, you will be entering the MAJOR and MINOR NAME (key fields) of a new or existing record and then adding or updating data on a subsequent panel.

Table 10 on page 88 shows the data you need for these panels. See this table as you work with the routing file records.

Table 10. Routing file ISPF input fields

ISPF Field	Definition
MAJOR NAME	An 8-byte alphanumeric field containing the major name for this routing. For JES, this corresponds to the DEST parameter in the JCL. For VTAM, this is the logical printer LU name.
MINOR NAME	An 8-byte alphanumeric field containing the minor name for this routing. For JES, this corresponds to the CLASS and FORMS parameters in the JCL, 1 character for CLASS and 1 to 7 characters for FORMS. For VTAM, this is any value of your choice.
NO OF DEST	The number of destinations in this routing. The number 1 indicates a normal routing to one printer. A number greater than 1 indicates a specific broadcast routing to multiple homogenous printers.
RETAIN TIME(S)	The period of time the system should retain data for this routing after a successful transmission. The format is dddhhmm where: ddd = the number of days (range 000 to 366) hh = the number of hours (range 00 to 23) mm = the number of minutes (range 00 to 59)
RETAIN TIME(U)	The period of time the system should retain data for this routing after an unsuccessful transmission after the retry attempts have been exhausted. The format is dddhhmm where: ddd = the number of days (range 000 to 366) hh = the number of hours (range 00 to 23) mm = the number of minutes (range 00 to 59)
RETRY INTERVAL	The period of time the system should wait before attempting a retry on this routing after an unsuccessful attempt to transmit. The format is dddhhmm where: ddd = the number of days (range 000 to 366) hh = the number of hours (range 00 to 23) mm = the number of minutes (range 00 to 59)
RETRY LIMIT	The number of retry attempts to be made on this routing. Valid values are 0 to 65535. If the file is not successfully transmitted by LPR within this number of retries, the RETAIN TIME(U) becomes effective. If you specify 0, the print data and queue record will be deleted by the queue manager if the first transmission is not successful. 0 is the default.
OPTIONS NAME	The name of the options file record to be associated with this routing. This must be a valid name (key field) of an existing options file record.
ROUTING EXIT	The name of a specific routing exit to be invoked. See "Writing the specific routing exit" on page 109 for information.
HOST NAME/IP ADDR	The internet name or IP address of the destination host. This field can contain up to 255 characters and is case-sensitive. Use dotted decimal format for addresses and use periods to separate labels in a domain name. Be sure to specify the host in the same way on all routing records which specify the same printer. This is necessary to ensure correct FIFO (First In, First Out) handling of print jobs for that printer.
PRINTER NAME	The name of the printer to be used at the remote host for the destination. his field can contain up to 255 characters and is case-sensitive.

Table 10. Routing file ISPF input fields (continued)

ISPF Field	Definition
LUCLASS	For VTAM only, this is a list of printer classes assigned to this destination. It identifies which VTAM LUs are used by each occurrence of the VTAM capture point. Valid values are 1 to 64. Specify them from left to right with a space between.
DEF PAGE FORMAT	For VTAM only, the name of an entry in the page format table. The default is blank. See “Page format definition” on page 37 for information about creating the page format table.
EOF FILE NAME	For VTAM only, the name of an entry in the end-of-file rules table. The default is DFLTNTTRY. See “Defining end-of-file rules” on page 30 for information about creating the end-of-file table.

Adding records to the routing file

You can add routing records by creating a new record (new key fields and new data) or copying a new record (new key fields and new data). Whether you are adding a normal routing with one destination or a specific broadcast routing with multiple destinations, you begin in the same way.

Procedure

Follow these steps to add a new routing record:

1. Select **A** from the NPF Printer Routing Configuration panel to display the NPF Routing Record Key Field panel (Figure 26)

```

----- NPF Routing Record Key Field -----
COMMAND ==>

ENTER ROUTING RECORD KEY FIELD FOR ADD:

          MAJOR NAME  ==>          (SLU/DEST)
          MINOR NAME  ==>          (USERDEF/JESOPTS)

          PRESS ENTER TO DISPLAY THE NEXT PANEL
  
```

Figure 26. NPF routing file record key field panel (EZAPPN9)

2. Specify the routing record key field. These are unique identifiers consisting of a MAJOR NAME and MINOR NAME. Enter the MAJOR NAME and MINOR NAME according to the requirements for a JES or VTAM configuration.

The MAJOR NAME for JES corresponds to the JCL DEST parameter. For VTAM it is the logical printer LU name.

The MINOR NAME for JES corresponds to the JCL CLASS and FORMS parameters, 1 character for CLASS and 1 to 7 characters for FORMS. Concatenate the two values and left justify them. For example, if CLASS=C and FORMS=1885, enter C1185 starting at the left of the MINOR NAME entry field.

For VTAM, the MINOR NAME is user-defined. It can contain any 1 to 8 alphanumeric characters of your choice.

3. Press **Enter** to display the NPF Routing Record Add panel (Figure 27)

```
ADD ----- NPF Routing Record -----
COMMAND ==>                                     SCROLL ==> PAGE

MAJOR NAME      ==> XXXXXXXX          MINOR NAME      ==> XXXXXXXX
LUCLASS         ==>

NO OF DEST      ==> 1
RETAIN TIME(S)  ==>
RETRY INTERVAL  ==>
DEF PAGE FORMAT ==>
OPTIONS NAME    ==>
HOST NAME/IP ADDR ==>

RETAIN TIME(U)  ==>
RETRY LIMIT     ==>
EOF FILE NAME   ==>
ROUTING EXIT    ==>

PRINTER NAME    ==>
```

Figure 27. NPF routing record panel (EZAPPN15)

4. Specify the fields for the new routing you are adding. If this is a normal routing, you need only to enter data on this panel. If this is a specific broadcast routing, enter the information for the first destination on this panel and the information for the other destinations on subsequent panels. See Table 10 on page 88 for specific input criteria.
5. To save the data:
 - For a normal routing, press **ENTER** and then press the END PF key or enter **END** on the command line to return.
 - For a specific broadcast routing, press **ENTER** and then press the DOWN PF key to scroll forward to the next panel to enter data for the other printer destinations. When you are done, press **ENTER** and the END PF key to save the data for this destination.
 - For all panels except the first panel, you can also press the UP PF key to scroll backward to edit any data for these destinations.
6. To return without saving the routing, enter **CANcel** on the command line.

Results

Of particular note:

- MAJOR NAME and MINOR NAME are the key fields for this record and cannot be changed. If they are incorrect, you must cancel this record and start over.
- NO OF DEST specifies the number of destinations on the routing and determines if this is a normal or specific broadcast routing. Valid values are 1 to 65535. Normal routings must have 1 destination. This is the default.
- LUCLASS, DEF PAGE FORMAT, and EOF FILE NAME are for VTAM routes only. Leave these fields blank for JES routes.
- OPTIONS NAME is required and must be the valid name (key field) of an existing options file record.

- HOST NAME/IP ADDR (Host Name or IP Address) and PRINTER NAME are required. They are both case sensitive and can contain uppercase and lowercase letters. Imbedded blanks are not allowed.
- If this is a specific broadcast routing (NO OF DEST is greater than 1), enter the HOST NAME/IP ADDR (Host Name or IP Address) and PRINTER NAME for the first destination on this panel.
- RETAIN TIME(S), RETAIN TIME(U), RETRY TIME, and RETRY LIMIT affect whether or not the print data is retained after the first transmission attempt and, if retained, how and when the system will try to resend it. See “Managing the print queues” on page 97 for more information.

Adding specific broadcast destinations

About this task

If you specify more than one destination on the Routing Record Add Panel (NO OF DEST is greater than 1), it indicates that you are creating a specific broadcast routing to send the print data to multiple homogenous printers.

When you scroll forward, the system will display subsequent panels so you can enter information for the other destinations. NPF provides one Routing Broadcast Record panel (Figure 28) for each additional destination.

```

ADD ----- NPF Routing Broadcast Record (2 of 2) ----- RECORD ADDED
COMMAND ==> SCROLL ==> PAGE

MAJOR NAME      ==> XXXXXXXX
MINOR NAME      ==> XXXXXXXX
HOST NAME/IP ADDR ==>

PRINTER NAME    ==>

```

Figure 28. NPF routing broadcast record panel (EZAPPN23)

Procedure

Follow these steps to add specific broadcast destinations:

1. Complete the HOST NAME/IP ADDR (Host Name or IP Address) and PRINTER NAME for the next destination on the routing and press **ENTER** to save the data for this destination.
2. Press the **DOWN** PF key to scroll forward. Subsequent panels will appear for as many additional destinations as are needed. For example, if the number of destinations is 5, then this panel will appear 4 times to enable you to complete information about each specific destination.
3. By pressing the **UP** PF key, you can also scroll backward to edit any data for these destinations.

4. When you are done, press the END PF key or enter **END** on the command line to return.

Copying records in the routing file

You can create a new routing file record by copying data from an existing record to a new record. If the existing routing is a specific broadcast, all the destinations will be copied. Because most routing records are similar except for minor variations, this feature can save time.

Procedure

Follow these steps to copy a routing file record from an existing record:

1. Select **C** from the NPF Printer Routing Configuration panel to display the NPF Routing Record Key Field Copy panel (Figure 29)

```
----- NPF Routing Record Key Field Copy -----
COMMAND ==>>

ENTER ROUTING RECORD KEY FIELDS FOR COPY:

  OLD ROUTING RECORD:

    MAJOR NAME  ==>>          (SLU/DEST)
    MINOR NAME  ==>>          (USERDEF/JESOPTS)

  NEW ROUTING RECORD:

    MAJOR NAME  ==>>          (SLU/DEST)
    MINOR NAME  ==>>          (USERDEF/JESOPTS)

PRESS ENTER TO DISPLAY THE NEXT PANEL
```

Figure 29. NPF routing file record key field copy panel (EZAPPN12)

2. Specify the key fields for OLD ROUTING RECORD and the NEW ROUTING RECORD. Enter the MAJOR NAME and MINOR NAME of the existing record you are copying in the OLD ROUTING RECORD field. Enter the MAJOR NAME and MINOR NAME of the record you are creating in the NEW ROUTING RECORD field. This will be the key field for the new routing record.
3. Press **Enter** to display the NPF Routing Record Panel (Figure 30 on page 93.)

```

COPY ----- NPF Routing Record -----
COMMAND ==>

MAJOR NAME      ==> XXXXXXXX      MINOR NAME      ==> XXXXXXXX
LUCLASS        ==>

NO OF DEST      ==> X
RETAIN TIME(S) ==> XXXXXXXX      RETAIN TIME(U) ==> XXXXXXXX
RETRY INTERVAL  ==> XXXXXXXX      RETRY LIMIT     ==> XXXXX
DEF PAGE FORMAT ==>
OPTIONS NAME    ==> XXXXXXXXXXXX  EOFILE NAME     ==>
HOST NAME/IP ADDR ==> XXXXXXXXXXXX  ROUTING EXIT    ==>

PRINTER NAME    ==> XXXXXXXXX

PRESS ENTER TO COPY THE ABOVE ROUTE

```

Figure 30. NPF routing record panel (EZAPPN15)

This panel displays the data to be copied from the existing record. The information on this panel cannot be changed.

4. Press **Enter** to copy the routing file record.

Copying specific broadcast destinations

You can copy only an entire specific broadcast routing, not individual destinations within it. When you copy the normal record for the first destination on a specific broadcast routing, all the records for the other destinations are copied with it.

To copy a specific broadcast routing, follow the steps for copying a normal routing file record. See “Copying records in the routing file” on page 92. If this is a routing with multiple destinations, the records for all the additional destinations will be copied along with the first one.

Updating records in the routing file

To update any existing routing file record, you must know the MAJOR NAME and MINOR NAME of the routing you want to update. Use the same rules for updating data as for entering new data in these fields.

Procedure

Follow these steps to update a routing record:

1. Select **E** from the NPF Printer Routing Configuration panel to display the NPF Routing Record Key Field Edit panel (Figure 31 on page 94)

```

----- NPF Routing Record Key Field -----
COMMAND ==>

ENTER ROUTING RECORD KEY FIELD FOR EDIT:

        MAJOR NAME  ==>          (SLU/DEST)
        MINOR NAME  ==>          (USERDEF/JESOPTS)

PRESS ENTER TO DISPLAY THE NEXT PANEL

```

Figure 31. NPF routing record key field edit panel (EZAPPN9)

2. Specify the ROUTING RECORD KEY FIELD. Enter the MAJOR NAME and MINOR NAME for the record you want to update.
3. Press **Enter** to display the NPF Routing Records Edit panel (Figure 32)

```

EDIT ----- NPF Routing Record -----
COMMAND ==>                               SCROLL ==> PAGE

MAJOR NAME      ==> XXXXXXXX             MINOR NAME      ==> XXXXXXXX
LUCLASS         ==>

NO OF DEST      ==> X
RETAIN TIME(S)  ==> SSSSSSSS             RETAIN TIME(U)  ==> SSSSSS
RETRY INTERVAL  ==> SSSSSSSS             RETRY LIMIT     ==> SSSSS
DEF PAGE FORMAT ==>
OPTIONS NAME    ==> SSSSSSSS             EOFILE NAME     ==>
HOST NAME/IP ADDR ==> SSSSSSSSSSSSSSSS   ROUTING EXIT    ==>

PRINTER NAME    ==> SSSSSSSSSSSSSSSSSSSSS

```

Figure 32. NPF routing record edit panel (EZAPPN15)

4. Change the information as necessary to update the record. See Table 10 on page 88 for specific input criteria and to “Adding records to the routing file” on page 89 for helpful notes.
5. Press **Enter** to save the new values.

Updating specific broadcast destinations

To update any information for a specific broadcast routing, start by displaying the normal record for the first destination and then scroll through the subsequent records for each of the other destinations.

Procedure

Follow these steps to update a specific routing record:

1. Select **E** from the NPF Printer Routing Configuration panel to display the NPF Routing Record Key Field Edit panel (Figure 31 on page 94).
2. Specify the ROUTING RECORD KEY FIELD. Enter the MAJOR NAME and MINOR NAME for the record you want to update.
3. Press **Enter** to display the NPF Routing Records Edit panel (Figure 32 on page 94).
4. Change any data as necessary on this panel. Press **Enter** to save any changes to the first destination.
5. Press the **DOWN** or **UP** PF keys to scroll forward or backward to display the data for each destination. (See Figure 33.)

```
EDIT ----- NPF Routing Broadcast Record (2 of 2) -----
COMMAND ==>                                     SCROLL ==> PAGE

MAJOR NAME      =====> XXXXXXXX
MINOR NAME      =====> XXXXXXXX
HOST NAME/IP ADDR =====> SSSSSSSSSSS

PRINTER NAME    =====> SSSSSSSSSSSSS
```

Figure 33. NPF routing broadcast record edit panel (EZAPPN23)

6. Change the HOST NAME/IP ADDR (Host Name or IP Address) and PRINTER NAME, if necessary, for the next destination. Then, scroll forward to the next destination.
7. Repeat the last step until the panels for all of the destinations have been displayed and updated or bypassed.

Deleting records from the routing file

You can delete records in the routing file for normal or specific broadcast routings. Be aware that when you delete these records, you are eliminating the routing from your system.

Procedure

Follow these steps to delete a routing record:

1. Select **D** from the NPF Printer Routing Configuration panel to display the NPF Routing Record Key Field Delete panel (Figure 31 on page 94).
2. Specify the ROUTING RECORD KEY FIELD. Enter the MAJOR NAME and MINOR NAME for the record you want to update.
3. Press **Enter** to display the NPF Routing Records Delete panel (Figure 34 on page 96).

```

----- NPF Routing Record Key Field -----
COMMAND ==>

ENTER ROUTING RECORD KEY FIELD FOR DELETE:

        MAJOR NAME  ==> XXXXXXXX      (SLU/DEST)
        MINOR NAME  ==> XXXXXXXX      (USERDEF/JESOPTS)

PRESS ENTER TO DISPLAY THE NEXT PANEL

```

Figure 34. Routing file record key field delete panel (EZAPPN9)

4. Specify the ROUTING RECORD KEY FIELD. Enter the MAJOR NAME and MINOR NAME for the record you want to delete.
5. Press **Enter** to display the NPF Routing Record Delete Panel (Figure 35)

```

DELETE ----- NPF Routing Record -----
COMMAND ==>

MAJOR NAME      ==> XXXXXXXX      MINOR NAME      ==> XXXXXXXX
LUCLASS        ==>

NO OF DEST      ==> X
RETAIN TIME(S)  ==> SSSSSSS      RETAIN TIME(U)  ==> SSSSSSS
RETRY INTERVAL  ==> SSSSSSS      RETRY LIMIT     ==> SSSSS
DEF PAGE FORMAT ==>
OPTIONS NAME    ==> SSSSSSSSSS    ROUTING EXIT    ==>
HOST NAME/IP ADDR ==> SSSSSSSSSSSS

PRINTER NAME    ==> SSSSSSSSSSSS

PRESS ENTER TO DELETE THE ABOVE ROUTE

```

Figure 35. NPF routing record delete panel (EZAPPN15)

6. Verify that this is the record you want to delete.
7. Press **Enter** to delete it.

If you requested delete confirmation for the routing file, you will get a panel that allows you to continue or stop the deletion. See “Setting the NPF ISPF defaults” on page 78 for instructions to turn delete confirmation on and off.

Note: If you are deleting a specific broadcast routing, each destination on the routing will be deleted.

Deleting specific broadcast destinations

You can delete only an entire specific broadcast routing, not individual destinations within it. When you delete the normal record for the first destination on a specific broadcast routing, all the records for the other destinations are deleted with it.

To delete a specific broadcast routing, follow the steps for deleting a normal routing file record. See “Deleting records from the routing file” on page 95. If this is a routing with multiple destinations, the records for all the additional destinations will be deleted along with the first one.

Managing the print queues

Whenever a print job is received by NPF, the capture point application creates a temporary QSAM print data set and adds a record to the queue file for each destination to which that print data is to be sent. For a multiple-destination routing only, an extra record is also written to act as an end-of-set marker.

The queue manager then assumes responsibility for all further processing of the print data set and the queue file records which point to it. Queue manager functions are listed as follows:

- Determining the order in which print jobs should be scheduled. For any given printer, print jobs are sent in FIFO (First In, First Out) order based on arrival time.
- Sending print data to LPD, including both initial send attempts and retries.
- Evaluating the return code from the send attempt and determining which of the following actions is needed:
 - After a successful transmission, keeping the queue record for a user-specified retain time or erasing the queue record immediately.
 - After an unsuccessful transmission, setting up the queue record for a retry of the send, keeping the queue record for a user-specified retain time, or erasing the queue record immediately.
- Erasing a queue record after its user-specified retain time has expired.
- Deleting a QSAM print data set after the last queue file record which points to it has been erased.

Each record on the queue file contains a data set status field. Possible values for this field and their meanings are as follows:

- | | |
|----------|---|
| Z | No send attempted yet. Normal next action is the initial attempt to send the print data. |
| U | Last send unsuccessful; one or more retries left. Normal next action is a retry of the failed send operation. |
| R | Last send unsuccessful; all retries exhausted; queue record being kept for the RETAIN(U) retain time. Normal next action, after the RETAIN(U) interval expires, is to erase the queue record and, if this is a single-destination routing, delete the corresponding print data set. |
| T | Last send successful; queue record being kept for the RETAIN(S) retain time. Normal next action, after the RETAIN(S) interval expires, is to erase the queue record and, if this is a single-destination routing, delete the corresponding print data set. |

- H** Print job being held. The queue record is kept, but no processing is done for it while in this state.
- X** End-of-set marker for a multiple-destination routing. The purpose of this record is to make sure that the QSAM print data set is not deleted until all queue records which point to it have been erased. Records with this state are displayed by the ISPF interface, but you cannot make any changes to them.
- D** Delete. Records with this state have been marked for deletion by a panel operator but not yet erased by the queue manager. These records are never displayed by the ISPF interface.

Working with the queue file

Queue file record data

Table 11 shows the data you need to manage your print queue. See this table as you work with the queue file records.

Table 11. Queue file ISPF fields

ISPF Field	Definition
SLU/DEST	An 8-byte alphanumeric field containing the first part of the queue record key. For JES routes, this corresponds to the DEST parameter in the JCL. For VTAM, this is the secondary logical unit (logical printer LU name).
PLU/JOBNAME	An 8-byte alphanumeric field containing the second part of the queue record key. For JES routes, this corresponds to the jobname used to submit the print request. For VTAM, this is the primary logical unit (origin of the data).
Creation Date	The date the queue record was created. The format will vary according to the national language being used.
Creation Time	The time the queue record was created. The format will vary according to the national language being used.
DS Status	A code representing the status of the print data: Z Successfully received by NPF but not yet sent to remote printer U Unsuccessful transmission; to be retried R Unsuccessful transmission; retries exhausted T Successful transmission H Being held in the print queue X End of Set of queue records
Printer Name	Same as PRINTER NAME in the routing file. The name of the printer used at the destination host on this route. This can be up to 255 characters and is case-sensitive.

Table 11. Queue file ISPF fields (continued)

ISPF Field	Definition
Host Name/IP Address	Same as HOST/IP ADDR in the routing file. The name or IP address of the destination host on this route. destination host on this route. This can be up to 255 characters and is case-sensitive. Use dotted decimal format for addresses and periods to separate labels in a domain name. Embedded blanks are not allowed. Be sure to specify the host in the same way on all routing records which specify the same printer. This is necessary to ensure correct FIFO (First In, First Out) handling of print jobs for that printer.
DS Name	Name of the print data set. See name for details on how this name is created.
Last Send Date/Time	The last date and time the queue manager tried to send this print request. The format will vary according to the national language being used.
Next Send Date/Time	The next date and time the queue manager will try to send this print request. This is calculated by the last sent date/time and the Retry Interval values. The format will vary according to the national language being used.
Retry Interval	Same as RETRY TIME in the routing file. The period of time the system should wait before attempting a retry on this route after an unsuccessful attempt to transmit.
Attempts/of	The number of times the queue manager has actually tried to resend the print request and the number of total retry attempts that were specified. The second value is the same as RETRY LIMIT in the routing file.
Retain Time (Successful)	The amount of time the queue manager should keep the print data after successful transmission. When this time is exceeded, the record is deleted.
Retain Time (Unsuccessful)	The amount of time the queue manager should keep the print data after an unsuccessful transmission when there are no more retries scheduled.
Print Options	Same as LPR Options in the options file. A list of LPR options that will be used to print the data at the destination printer.

Displaying the queue file

Depending on the size of your installation and the volume of requests, the queue file can contain numerous records. You can display the entire queue file or just a selected part of it. You can choose to select queue records based on the key fields, the creation data and time, the data set status, the printer queue name, host name, or IP address.

Procedure

Follow these steps to display the queue file:

1. Select **Q** from the Network Print Facility Primary Option Menu to display the NPF Queue Selection Panel (Figure 36 on page 100)

This panel provides entry fields for your selection criteria and shows you the commands you are authorized to use on the queue records listed in the subsequent panel. It also displays the queue file (VSAM DSN) you will access.

The file displayed is either the default file or the last file you used. If you want to work with a different queue file, enter a fully-qualified data set name in this field. If you want to reset this field to the default, clear the field and press **ENTER**.

```

----- NPF Queue Selection Panel -----
COMMAND ==>

VSAM DSN ==> SSSSSSSSSSSSSSSSS          USERID - XXXXXXXX
                                         DATE  - XXXXXXXX
                                         TIME  - XXXXXXXX
                                         SEQ   - XXXX

Enter optional display criteria below:

SLU/DEST          ==>
PLU/JOBNAME       ==>
Creation Date     ==>                    (YYYY/MM/DD)
Creation Time     ==>                    (HH:MM)
Data Set Status   ==>                    (H,R,T,U,X,Z)
Printer Name      ==>

Host Name/IP Address ==>

* The following line commands will be available when the list is displayed:

B or S - Browse record          = - Repeat last command
D or P - Delete record          E - Edit record

```

Figure 36. NPF queue selection panel (EZAPPQSP)

- Specify the fields to select the records you want to see. The values in these fields are treated in an **AND** condition. The selected records must meet all the criteria specified.

You can use an asterisk (*) in the following ways:

- By itself to mean any value (* matches any value)
- At the start of a string (*ABC matches values ending with ABC)
- At the end of a string (ABC* matches values starting with ABC)

Although the fields for Printer Name and Host Name or IP Address contain up to 255 characters, you can enter only 130 characters. If necessary, you can use the asterisk (*) to accommodate the selection of longer names.

If all fields are blank or contain an asterisk (*), you will get a list of the entire NPF queue file.

- If necessary, change the SEQ field value to indicate the order in which you want the selected queue records displayed. You have two valid choices:
 - KEY - displays the records in key sequence, the same order in which the records occur within the queue file.
 - TIME - causes the records to be displayed in arrival-time sequence, with the oldest records appearing first.
- Press **Enter** to display the NPF Queue List panel (Figure 37 on page 101).

Selecting a queue record

About this task

The records displayed in the NPF Queue List panel are selected based on the criteria you enter on the NPF Queue Selection panel. You can view these queue records, and if authorized, modify, delete, reset, or hold them.

Note: The examples below show sample queue records for printer lpt1 at IP address 9.67.111.12 arranged in both KEY and TIME sequences.

```

DATE 96/02/22 TIME 14:25 - NPF Queue List ----- Row 1 TO 14 OF 14
COMMAND ===> SCROLL ==>
A SLU/DEST PLU/JBNM S DATE TIME PRINTQ HOST
A01PP140 APPL01 T 96/02/22 12:02 lpt1 9.67.111.12
A01PP140 APPL01 Z 96/02/22 13:50 lpt1 9.67.111.12
A01PP140 CICS23 Z 96/02/22 14:10 lpt1 9.67.111.12
A01PP140 IMS14A T 96/02/22 11:48 lpt1 9.67.111.12
A01PP140 IMS14A Z 96/02/22 13:41 lpt1 9.67.111.12
A01PP145 IMS14A R 96/02/22 12:52 lpt1 9.67.111.12
A01PP145 IMS14A Z 96/02/22 13:51 lpt1 9.67.111.12
A01PP149 IMS14A Z 96/02/22 14:08 lpt1 9.67.111.12
A01PP149 XYZAPPL Z 96/02/22 14:11 lpt1 9.67.111.12
A01PP151 APPL01 Z 96/02/22 14:02 lpt1 9.67.111.12
A01PP151 APPL01 Z 96/02/22 14:08 lpt1 9.67.111.12
A01PP151 CICS23 R 96/02/22 13:26 lpt1 9.67.111.12
A01PP151 CICS23 Z 96/02/22 13:59 lpt1 9.67.111.12
A01PP155 IMS14A U 96/02/22 13:37 lpt1 9.67.111.12
***** BOTTOM OF DATA *****

```

Figure 37. NPF queue list (EZAPPQLP) in KEY sequence

```

DATE 96/02/22 TIME 14:25 - NPF Queue List ----- Row 1 TO 14 OF 14
COMMAND ===> SCROLL ==>
A SLU/DEST PLU/JBNM S DATE TIME PRINTQ HOST
A01PP140 IMS14A T 96/02/22 11:48 lpt1 9.67.111.12
A01PP140 APPL01 T 96/02/22 12:02 lpt1 9.67.111.12
A01PP145 IMS14A R 96/02/22 12:52 lpt1 9.67.111.12
A01PP151 CICS23 R 96/02/22 13:26 lpt1 9.67.111.12
A01PP155 IMS14A U 96/02/22 13:37 lpt1 9.67.111.12
A01PP140 IMS14A Z 96/02/22 13:41 lpt1 9.67.111.12
A01PP140 APPL01 Z 96/02/22 13:50 lpt1 9.67.111.12
A01PP145 IMS14A Z 96/02/22 13:51 lpt1 9.67.111.12
A01PP151 CICS23 Z 96/02/22 13:59 lpt1 9.67.111.12
A01PP151 APPL01 Z 96/02/22 14:02 lpt1 9.67.111.12
A01PP151 APPL01 Z 96/02/22 14:08 lpt1 9.67.111.12
A01PP149 IMS14A Z 96/02/22 14:08 lpt1 9.67.111.12
A01PP140 CICS23 Z 96/02/22 14:10 lpt1 9.67.111.12
A01PP149 XYZAPPL Z 96/02/22 14:11 lpt1 9.67.111.12
***** BOTTOM OF DATA *****

```

Figure 38. NPF queue list (EZAPPQLP) in TIME sequence

Procedure

Follow these steps to select a record from this list:

1. Enter an action or command:
 - To browse a record, enter **B** or **S** in the Action column. When the record is displayed, all the fields are protected.
 - To delete a record, enter **D** or **P** in the Action column. The queue manager deletes the queue record and any of its print data sets.
 - To edit a record, enter **E** in the Action column. When the record is displayed, you are able to modify fields not under system control.
 - To hold a record, enter **H** in the Action column or **HOLD** *slu/destname* on the command line.
 - To reset a record, enter **R** in the Action column or **RESET** *slu/destname* on the command line.
 - To repeat any command, enter **=** in the Action column. This allows you to perform the same command successively for several records.

- To refresh the queue list display, enter **REFRESH** on the command line.
2. Press **Enter** to activate the commands and display the NPF Queue Record panel (Figure 39 on page 103).

Helpful hints

- You can reset queue records whose Data Set Status is U (unsuccessful), R (retries exhausted), or H (on hold). These jobs will be resent to the printer.
 - The reset action (**R**) resets one print request.
 - The **RESET** *slu/destname* command resets all requests for a destination.
- You can hold queue records whose Dataset Status is U (unsuccessful), R (retries exhausted), or Z (not yet sent to the printer). These jobs will not be sent to the printer.
 - The hold action (**H**) holds one print request.
 - The **HOLD** *slu/destname* command resets all requests for a destination.
- The queue records with a Dataset Status of X (End of Set) are only for system use. You cannot perform any functions on them.
- The DATE and TIME displayed on the Queue List panel are close to but not identical to the arrival date/time used to determine TIME ordering. This difference can sometimes make a list appear slightly out of order, even though the sequence is actually correct.
 - The displayed values indicate when the QSAM print data set was OPENed.
 - The arrival date/time values indicate when the QSAM print data set was CLOSEd.
- There are at least two cases in which the TIME sequencing of displayed queue file records should be useful:
 - To quickly check your network for printers experiencing delays, set the Data Set Status selection field to either UZ or ZU and set the SEQ selection field to TIME. Queue records for the oldest unsent print jobs will appear at the top of the resulting list, indicating which printers have the longest delays.
 - To display the backlog of unsent print jobs for a specific printer, set the Host Name/IP Address (Host Name or IP Address) and Printer Name fields to select that printer, and set other selection fields the same as in the previous example. The resulting list will show the waiting print jobs in the exact order in which they are scheduled to be printed.

Changing values in a queue record

You can change the values in the fields on this panel to affect when (and if) the queue manager will retry to transmit the job and when it will delete the queue record and its print data sets. You can also reroute the data on the next retry to a different destination and change the print options that will be used.

```

EDIT ----- NPF Queue Record -----
COMMAND ==>

SLU/DEST : XXXXXXXX   PLU/JOBNAME: XXXXXX           DATE - XXXXXXXX
DS Name  : XXXXXXXXXXXXXXXXXXXXXXXXXXXXXXXXXXXX    TIME - XXXXXX
DS Status : X
Last Send : Date      ==> XXXXXXXXXX Time          ==> XXXXX
Next Send : Date      ==> SSSSSSSSSS Time          ==> SSSSS
Retry     : Interval  ==> S           Attempts      ==> S   of S
Retain Time: Successful ==> S           Unsuccessful ==> S
Print Options ==> SSSSSSSSSSSSSSSSSSSSSSSSSSSSSSS

Printer Name ==> SSSSSSSSSSSSSSSSSSSSSSSSSSSSSSS

Host Name/IP Address ==> SSSSSSSSSSSSSSSSSSSSSSSSSSSSSSS

```

Figure 39. NPF queue record (EZAPPQRP)

Change data as appropriate in the following fields:

- Next Send Date/Time
- Retry Interval
- Attempts/of (Corresponds to retry count and retry limit)
- Retain Time Successful
- Retain Time Unsuccessful
- Print Options
- Printer Name
- Host Name or IP Address

See “Managing the print queues” on page 97 and Table 11 on page 98 for valid values for information on these fields.

Helpful hints

- To retry printing, increase the retry limit or decrease the retry count. For a queue record currently in state "R" (retries exhausted), either of these actions will change the state to "U" (unsuccessful).
 - Attention:** To avoid unnecessary print delays, you must modify the Next Send time also; the state change does not automatically update the Next Send time.
 - Suggestion: A safer way to retry printing is to use the RESET command to change the record state and automatically update the Next Send time.
- To print the job with different options, change the Print Options.
- To delay or expedite additional print attempts, change the Next Send times and, possibly, the Retry Interval.
- To stop additional print attempts, change the retry limit to 0.
- To retain the queue record for a longer or shorter time, change the Retain Time values.
- To send the print job to another print queue or host, change the Printer Name, or Host Name or IP Address

Deleting queue records

You can delete queue records by entering **D** or **P** in the Action column on the NPF Queue List panel (Figure 37 on page 101).

Chapter 7. Writing exit routines to tailor the Network Print Facility

Installations can create exit routines to preclude the use of the Network Print Facility's own mechanism for routing by:

- Creating the routing data area (RDA)
- Modifying the key (for JES, DEST and CLASS, for example) and access the routing and options files
- Modifying the RDA after it has been created
- Modifying print data

Such exit routines must supply all the information the Network Print Facility requires involving routing and options. These optional exit routines can route output dynamically by modifying the routing data area (RDA), a critical data area described in more detail in "The Routing Data Area (RDA)" on page 122.

See Table 12 for a short description of the Network Print Facility exits.

Table 12. Network Print Facility user exits

Exit	Description
<p>Routing Exits - alter the routing of printed output</p> <ul style="list-style-type: none"> • Used to determine where output is printed. (Substitute for the routing file or options file, or both.) • Used to modify routing file information. • Used to modify options file information. 	<p>Two types:</p> <ol style="list-style-type: none"> 1. General routing exit - changes JES and VTAM input parameters <i>before</i> the routing or options data is read. It can replace the functions of the routing or options files or change the key used to access the routing or options files. 2. Specific routing exit - invoked <i>after</i> the routing or options data is read or <i>after</i> the general routing exit completes. It can change or augment the routing and options data obtained from those sources.
<p>Input record exit - alters the content of the data to be printed.</p> <ul style="list-style-type: none"> • Invoked each time data is received by the Network Print Facility. • Used to insert, modify, or delete application data. • Used to modify routing or options data based on contents of application data. 	<p>Allows specification of reformatting, translation, encryption, or other installation-defined functions needed to accommodate output to destined printers.</p>

The exits are entered through an MVS link and follow normal MVS register conventions.

This chapter presents the following information:

- General routing exit information
- Specific routing exit information
- Input record exit information
- The routing data area
- Using the EZAPPFCD macro to generate the data areas you need

Two routing exits and one input record exit

Two separate user exits can be used to alter routing. These are referred to as *routing exits*. They substitute for the routing file or the options file or both.

- **General routing exit**

This user exit is named EZAPPGPR. It changes JES or VTAM input parameters and is invoked *before* the routing or options data is read (routing data areas are created.) It can replace the functions of the routing or options files because you can use it to create the RDA itself or change the key used to access the files. To invoke EZAPPGPR, it must be in a library specified by a JOBLIB, STEPLIB, or in the LNKLIST.

- **Specific routing exit**

This user exit is user-named and is invoked in one of two ways:

1. *After* the general routing exit completes
2. *After* the Network Print Facility creates the routing data area

It can modify the RDA or change or augment the data obtained from those sources. To invoke the specific routing exit, it must be a LINKLST member of MVS PARMLIB or specified on either the JOBLIB or STEPLIB DD statements.

The name of this exit is user-dependent. It must follow MVS module naming standards, can be up to an 8-byte alphanumeric name and can be defined in the:

- RTDASREX field of the routing data area, via the general routing exit.
- SREXIT parameter in “EZAPPFL TYPE=ROUTING” on page 54.
- ROUTING EXIT field, as illustrated in Figure 27 on page 90.

Input record exit

This user exit performs two functions:

1. Allows modification of the RDA.
2. Allows the alteration of the contents of data to be printed. This can be used to insert, modify, or delete application data as needed to accommodate output to destined printers.

This exit is invoked for all data-related functions in NPF processing.

The name of this exit is user-dependent. It must follow MVS module naming standards, can be up to an 8-byte alphanumeric name and can be defined in the:

- RTDAIREX field of the routing data area.
- IREXIT parameter in “EZAPPFL TYPE=OPTIONS” on page 59.
- INPUT RECORD EXIT field, as illustrated in Figure 18 on page 82.

See “Using the EZAPPFCD macro” on page 122 to produce the DSECTS needed for the exits.

Writing the general routing exit

The general routing exit is used when the installation can provide a more sophisticated and accurate method of routing than the Network Print Facility can with the routing and options files. The exit can interpret information provided by the capture points in an installation-specific context and produce more accurate routings. For example, examination of the JES or VTAM specific data can produce a direct routing or a different way to access the routing file to produce a routing.

The general routing exit can be used for two purposes:

- Create a routing data area using an algorithm different from that provided by the Network Print Facility. In this use of the general routing exit, the exit interprets the input parameters and develops the information required for the routing data area. After the routing data area is built, the exit returns control to the Network Print Facility specifying that the routing data area has been built. Optionally, the exit can cause the invocation of a specific routing exit by putting the name of the specific routing exit in the RTDASREX field in the routing data area. Otherwise, this field should be set to either binary zeros or blanks.
- Change the key used to access the routing file. In this use of the general routing exit, the exit interprets the input parameters and develops the major and minor keys for access to the routing file. The exit returns these keys to the Network Print Facility and a code indicating that the keys have been changed. The system then uses the keys to access the routing (and then options) file and builds the routing data area based on the information in the files. The use of the specific routing exit is controlled by an entry in the routing file (see the SREXIT parameter in the ROUTING function of the EZAPPFL macro).

Environment

The exit should be coded following standard assembly linkage with the following parameters:

Name EZAPPGPR

AMODE

Any

RMODE

24 or 31

Link Attribute

RENT (Reentrant)

In the JES environment, it runs in supervisor state using storage key 1. In the VTAM environment, it runs in problem state.

Processing

At initialization, the Network Print Facility issues a conditional LOAD for the module EZAPPGPR. If the LOAD fails, the Network Print Facility assumes that the general routing exit is not supplied and builds the routing data area for each print file using the routing and options files. If the LOAD is successful, the Network Print Facility performs the following initialization steps for each print file.

- Invoke EZAPPGPR
 - If EZAPPGPR built a routing data area:
 - Invoke a specific routing exit if one was specified
 - If EZAPPGPR replaced the keys or did nothing:
 - Build a routing data area using the routing and options files.
 - Invoke a specific routing exit if one was specified

Note: To maintain integrity of the routing and options files, do not use the general routing exit to process these files.

Installing the exit

The exit should be linked into a target library which is referred to by a JOBLIB, STEPLIB, or LINKLIST entry for execution of the appropriate capture point.

Input

See "Parameter list contents."

Registers at entry

GPR1 Parameter list

GPR13
Caller's save area

GPR14
Caller's return address

GPR15
Entry point of exit

Parameter list contents

The macro EZAPPFCD GRE=DSECT generates a DSECT of the parameter list for the general routing exit. EZAPPFCD GRE=INLINE generates an inline copy.

See "Using the EZAPPFCD macro" on page 122 to generate the DSECTS you need.

GRCALLID

Address of a four-byte character field with the identity of the caller:

Value	Meaning
--------------	----------------

'JES '	The caller is a JES external writer.
---------------	--------------------------------------

'VTAM'	The caller is the VTAM application module.
---------------	--

GRCALLPM

The address of the JES or VTAM-specific parameter area. For JES, it is the address of a list of parameters that consists of:

1. A pointer to the GETDS function-dependent area in the IAZFSIP DSECT. (To generate this DSECT, code the IAZFSIP macro with LIST=YES in your exit.)
2. A pointer to the values of the PARM parameters passed by the NPF FSS writer start procedure.
3. A fullword binary number specifying the length of the PARM parameters passed by the NPF FSS writer start procedure.
4. A fullword of binary zeros
5. A fullword of binary zeros (reserved)
6. A fullword of binary zeros (reserved)
7. A fullword of binary zeros (reserved)
8. The EOF flag

For VTAM, it consists of the address of the 35-byte BIND image received from VTAM.

GRRTNAME

Address of an area containing two 8-byte name fields. The names passed to the exit are the major and minor names of the routing record that NPF will use unless otherwise directed. To use the NPF-selected routing record, return with GPR 15 set to 0000. To specify a different routing record, return with GPR 15 set to 0001 and supply the new major and minor names in this area.

GRRTDATA

The address of the fullword where the exit will store the address of the new routing data area. This field must be supplied by the exit when the return code is 0002.

Because NPF will FREEMAIN the new routing area allocated by the EZAPPGPR exit, make sure the size of the RDA corresponds to the following formula:

$\text{length} = 346 + (\text{RTDADEST} * 516)$

Return codes for the general routing exit

Upon completion the general routing exit should return a value in GPR 15 as follows:

- 0000** Exit completed successfully. Will use the routing record specified by the major and minor names that were passed to the exit.
- 0001** Exit completed successfully. Will use the routing record specified by the new major and minor names that were supplied by the exit.
- 0002** Exit completed successfully. No routing record will be used because the routing data area was supplied by the exit.

Anything Else

Exit did not complete successfully. Message EZY0631E is accompanied by either:

- For VTAM - sense code x'081C0103'
- For JES - return code 1002

Output

See "Parameter list contents" on page 108

Registers at exit

GPR15

As defined above

All other registers

Restored to caller's values

Writing the specific routing exit

The specific routing exit is used to modify the contents of the routing data area. It is used much the same as the general routing exit. NPF invokes it after it builds the routing data area, but unlike the general routing exit, the user can specify a specific exit for each routing. Like the general routing exit, the specific routing exit can use information provided by the capture points in an installation-specific context and produce more accurate routings. For example, examination of the JES

or VTAM specific data might produce a more accurate routing than is contained in the routing file or produced by the general routing exit.

The specific routing exit is invoked after the routing data area (RDA) has been built. Because the routing data area can be built by either the general routing exit or by data from the routing and options files, the specific routing exit can be used with either method. Its purpose is to further modify the routing data area.

See Appendix B, "Network Print Facility's Routing Data Area (RDA)," on page 153 for the structure of the routing data area. When specifying routing data format, be careful to leave the specific routing exit field (RTDAEXIT field in the RDA, the SREXIT parameter in the ROUTING function of the EZAPPFL macro, and the ROUTING EXIT field, as illustrated in Figure 27 on page 90) blank if you are not using a specific routing exit. The required fields are the same as in the general routing exit. The run-time environment is the same as the general routing exit.

Environment

The exit should be coded following standard assembly linkage with the following parameters:

Name User Specified. The name must follow MVS conventions for Load module names and must be specified in the routing file or placed in the routing data area by the general routing exit.

AMODE
Any

RMODE
24 or 31

Link Attribute
RENT (Reentrant)

Processing

The system tests for the presence of the specific routing exit by examining field RTDASREX in the routing data area. If this field is zeros or blanks, the Network Print Facility assumes no specific routing exit is to be used. If this field is something else, it uses this name in a conditional LINK to the specific routing exit.

Installing the exit

The exit should be linked into a target library which is referred to by a JOBLIB, STEPLIB, or LINKLIST entry for execution of the appropriate capture point.

Input

See "Parameter list contents" on page 111

Registers at entry

GPR1 Parameter list

GPR13
Caller's save area

GPR14
Caller's return address

GPR15
Entry point of exit

Parameter list contents

The macro EZAPPFCD SRE=DSECT generates a DSECT of the parameter list for the specific routing exit. EZAPPFCD SRE=INLINE generates an inline copy.

SRCALLID

Address of a four-byte character field with the identity of the caller:

Value Meaning

'JES ' The caller is a JES external writer.

'VTAM'

The caller is the VTAM application module.

SRCALLPM

The address of the JES or VTAM-specific parameter area. For JES, it is the address of a list of parameters that consists of:

1. A pointer to the GETDS function-dependent area in the IAZFSIP DSECT. (To generate this DSECT, code the IAZFSIP macro with LIST=YES in your exit.)
2. A pointer to the values of the PARM parameters passed by the NPF FSS writer start procedure.
3. A fullword binary number specifying the length of the PARM parameters passed by the NPF FSS writer start procedure.
4. A fullword of binary zeros
5. A fullword of binary zeros (reserved)
6. A fullword of binary zeros (reserved)
7. A fullword of binary zeros (reserved)
8. The EOF flag

For VTAM, it consists of the address of the 35-byte BIND image received from VTAM.

SRRTDATA

A fullword binary field specifying the address of the routing data area. The exit modify this area if desired.

Return codes for the specific routing exit

Upon completion the exit will return a value in GPR 15 as follows:

0000 Exit completed successfully.

Anything Else

Exit did not complete successfully. Message EZY0632E is accompanied by either:

- For VTAM - sense code x'081C0103'
- For JES - return code 1002

Or, in the case of a failure to link, message EZY0636E is accompanied by either:

- For VTAM - sense code x'081C0103'
- For JES - return code 1005

Output

See "Parameter list contents" on page 111

Registers at exit

GPR15

As defined above

All other registers

Restored to caller's values

Writing the input record exit

The input record exit can be used for any editing function that you want. It is invoked for all data-related functions in NPF processing, and can play an integral part in the creation of the file being transmitted. In addition, it can modify routing data based on print data observed, for example, the user's name or system name.

The input record exit allows the system administrator to modify the contents of printed output.

There are two purposes for the input record exit

- To modify, add to, or remove print data from the print stream.
- To modify the routing data area based on print data.

Understanding how LPR has been defined to operate in a particular environment will enable installations to take advantage of the input record exit's capabilities.

The input record exit can:

- Add data, such as a banner page.
- Modify data. The input record exit is invoked with each PUT. The input record exit can modify data (for example, by translation or encryption) and then continue with the PUT. The input record exit has storage that the Network Print Facility can manage for you after you construct it.
- Delete data.
- Cause a file to be rescanned (only for JES output).

Environment

The exit should be coded following standard assembly linkage with the following parameters:

Name User Specified. The name must follow MVS conventions for Load module names and must be specified in the Options file or placed in the routing data area by the general routing exit.

AMODE

Any

RMODE

24 or 31

Link Attribute
RENT (Reentrant)

Processing

The system tests for the presence of the input record exit by examining field RTDAIREX in the routing data area. If this field is zeros or blanks, the Network Print Facility assumes no input record exit is to be used. If this field is something else, it uses this name in a conditional LOAD to the input record exit and saves its address. This address is used to access the exit on all calls.

The input record exit is invoked for 4 conditions. The specific condition can be determined by checking the field RTDAFUNC in the routing data area. The four conditions explained below are: open, put, close, and term/release.

OPEN The system is preparing to process a print file. It is about to allocate and open the QSAM file to contain the data to be passed. The input record exit should prepare itself as follows:

1. Obtain program storage, if necessary. For the JES capture point, this should be necessary only on the first OPEN issued by a (JES) logical printer. For the VTAM capture point, this is necessary for each print file. The address of this storage is stored in the area pointed to by IRESTRG and is returned for any processing related to this logical printer/file.
2. Get addressability to the routing data area. The address of the RDA is in field IRERTD in the parameter area. Use the DSECT RTDATA, generated using the EZAPPFCD RDA=DSECT macro.
3. Examine the field RTDARTYP. If it is not acceptable, it can be changed to one of the following record formats:

Value Meaning

FB File will be allocated as fixed blocked records.

FBA File will be allocated as fixed blocked records with ASA carriage control.

FBM File will be allocated as fixed blocked records with machine carriage control.

VB File will be allocated as variable blocked records.

VBA File will be allocated as variable blocked records with ASA carriage control.

VBM File will be allocated as variable blocked records with machine carriage control.

4. Examine the field RTDARECL. This field specifies the logical record length to be used for the QSAM file. If the file format is VB, VBA or VBM, this specifies the maximum record length. If the file format is FB, FBA or FBM, it specifies the actual record length. If the value is not acceptable, it can be changed but with the following considerations:
 - If the record format is FB, FBA or FBM, and this length is greater than the length of records passed from the capture point, the records are padded to the right with blanks. This might cause unpredictable results including the insertion of additional blank lines on the printed output. The exit must avoid this condition by reformatting the data as it is processed.

- If the record format is FB, FBA or FBM, and this length is less than the length of records passed from the capture point, the records are split, resulting in multiple printed lines for each line received from the capture point. The exit must avoid this condition by reformatting the data as it is processed.
 - If the record format is VB, VBA or VBM, this length is the maximum record length and includes the 4-byte LLbb field preceding each record.
5. Examine the field RTDABLKS. This field specifies the blocksize to be used in the QSAM file. If the value is not acceptable it can be changed, with the following considerations:
 - If the record format is FB, FBA or FBM, it must be an even multiple of the value in RTDARECL.
 - If the record format is VB, VBA or VBM, it must be a minimum of the value in RTDARECL plus 4.
 6. Examine the field RTDABUFS. This field specifies the buffer size to be passed to the exit for PUT processing. If this buffer size is not acceptable, it can be changed. It must have a minimum value of the value in RTDARECL plus 2.

PUT Network Print Facility is about to place a record of print data on the file for processing. The data is located in a buffer and the address and length of the data is passed to the input record exit via the parameter list. The input record exit performs three functions:

1. It modifies the data. For this purpose, there are two bytes of buffer space in front of the data, which is used by the exit to expand the record to the left. The amount of buffer space to the right is equal to the buffer size minus the record length minus 2. If the exit moves the record within the buffer or moves it to another buffer, it must replace the address and length of the data in the parameter list fields.
2. The input record exit specifies the disposition of the data by using the IREWFLG as follows:

Value Meaning

- X'00' Write the data to the file.
- X'01' Do not write the data to the file.

3. The input record exit controls the logic of the capture point using the field IRERFLG as follows:

Value Meaning

- X'00' Do not re-invoke the input record exit until the next data record has been obtained or the file is to be closed.
- X'01' Re-invoke the input record exit without a new input buffer before returning to the capture point. This permits the input record exit to insert additional data.
- X'02' This option is available for JES only. It tells the capture point to restart processing at the beginning of the spool file.

CLOSE

Processing for CLOSE is similar to processing for PUT. The following exceptions must be observed:

- The data address and length fields will have no meaning at invocation. If the exit wants to write an additional data record to the file, it must place the address and length of the data in these fields.
- Unless the input record exit provides data to be written to the file, IREWFLG must be set to X'01'.
- A value of X'00' in IRERFLG is interpreted as 'continue with CLOSE processing. Thus, if the exit specifies this value, it will be the last time the exit is invoked related to this file.
- A value of X'02' in IRERFLG is currently not supported for CLOSE.

TERM/RELEASE

The exit is invoked at this time to allow it to free any resources such as storage that it might have obtained.

Special considerations for handling JES data

The following information should be taken into consideration when coding an input record exit for the JES capture point:

- The default record format for all QSAM data sets is RECFM=VBA if SPIN=GROUP is specified. For SPIN=DATASET processing, the RECFM will be VBA, VBM, or VB depending on the type of carriage control specified when the data set was written to JES (ASA=VBA, machine=VBM, none=VB).
- The default DCB information for the QSAM file will be LRECL=4092 and BLKSIZE=4096. If a larger LRECL is needed, the input record exit must override the LRECL and BLKSIZE. Record lengths larger than 4092 are not supported unless the input record exit is coded.
- At OPEN time, any of the characteristics (RECFM, LRECL, BLKSIZE) of the QSAM data set can be overridden by the input record exit. However, it is the responsibility of the input record exit code to ensure the data records conform to any changes.

Installing the exit

The exit should be linked into a target library which is referred to by a JOBLIB, STEPLIB, or LINKLIST entry for execution of the appropriate capture point.

Input

See "Parameter list contents" on page 116

Registers at entry

GPR1 Address of the parameter list

GPR13
Caller's save area

GPR14
Caller's return address

GPR15
Entry point of exit

Parameter list contents

The options file can specify an input record exit to be invoked before putting a print record in the print file. This is the parameter list passed to that input record exit. The name of the exit is specified by the user in the IREXIT parameter on the OPTIONS function of the EZAPPFL macro (see "EZAPPFL TYPE=OPTIONS" on page 59).

The parameter list consists of the address of a pointer to the following parameter area. The macro EZAPPFCD IRE=DSECT generates a DSECT of this parameter area. EZAPPFCD IRE=INLINE generates an inline copy.

IRELLEN

Length of this parameter area

IRESTRG

The address of a working storage area used by the exit. The length of this area is 16 bytes.

IRECPAD

The address of the JES or VTAM-specific parameter area. For JES, it is the address of a list of parameters that consists of:

1. A pointer to the GETDS function-dependent area in the IAZFSIP DSECT. (To generate this DSECT, code the IAZFSIP macro with LIST=YES in your exit.)
2. A pointer to the values of the PARM parameters passed by the NPF FSS writer start procedure.
3. A fullword binary number specifying the length of the PARM parameters passed by the NPF FSS writer start procedure.
4. A pointer to the IDXFLAG1 byte in the IAZIDX DSECT. (To generate this DSECT, code the IAZIDX macro with LIST=YES in your exit.)
5. A fullword of binary zeros (reserved)
6. A fullword of binary zeros (reserved)
7. A fullword of binary zeros (reserved)
8. The EOF flag

For VTAM, it consists of the address of the 35-byte BIND image received from VTAM.

IREBPTR

The address of the input/output buffer

IREDLLEN

A fullword binary number specifying the length of the data in the buffer.

IREWFLG

A one-byte field specifying whether the data in the buffer is to be written to the file or skipped. On entry to the exit, this field is set to X'00'. On return from the exit, it is set as follows:

X'00' The data is to be written to the file.

X'01' The data is not to be written.

IRERFLG

A one-character field which specifies what input record is to be returned on the next call to the exit. On entry to the exit, this flag is set to X'00'. On return from the exit, it is set as follows:

- X'00'** Specifies the next record returned to the exit will be the next record from the input spool file.
- X'01'** Specifies that control will be returned to the exit so that additional records can be inserted into the output data stream. If the exit returns a new I/O buffer address BELOW the 16 MB line in IREBPTR, then subsequent invocations of the exit will be passed the address of the CURRENT input record in IREBPTR. If the exit returns a new I/O buffer address ABOVE the 16 MB line, or IREBPTR is not changed, then subsequent invocations of the exit will be passed the address of the last output buffer in IREBPTR.
- X'02'** Specifies that the next record returned to the exit will be the first record in the spool file.

IREEOF

A one-character field used to indicate that an EOF has been encountered.

Value Meaning

- x'00'** Not EOF
- x'01'** EOF

IRECID

A one-character field used to identify the caller.

Value Meaning

- V** VTAM
- J** JES

IREOPLN

The length of the data set name plus the options data already used by NPF. Subtract this from 255 to determine how much space you have for user-supplied options.

IREABNF

A one-character field which indicates if the input record exit can insert records into the output data stream. On entry to the exit, this flag is set to:

- X'00'** Specifies that print data set is open and the exit can insert records into the file.
- X'02'** Specifies that print data set is closed due to an out of space condition and no further records can be inserted into the output file.

IRERTD

The address of the routing data area.

```

*-----*
*                INPUT RECORD EXIT PARAMETER LIST                *
*-----*
IRELIST DS    0F
IRELLEN DS    F          Length of this parameter list
IRESTRG DS    F          Pointer to static 16-byte memory
IRECPAD DS    F          Pointer to JES/VTAM parameter list
IREBPTR DS    F          Pointer to 32K I/O buffer
IREDLLEN DS   F          Length of data in the buffer
IREWFLG DS    C          Write/Skip flag
IRERFLG DS    C          Read flag
IREEOFF DS    C          EOF encountered flag
IRECID  DS    C          Caller's ID (J=JES V=VTAM)
IREOPLN DS    H          Length of the DSN + options data
IREABNF DS    C          Print file abend indicator
          DS    C          Reserved
IRERTD  DS    F          Address of the routing data area
IRELISTL EQU  *-IRELIST  Length of Parameter List

```

Figure 40. Input exit record parameter list

Return codes for the input record exit

Upon completion, the exit will return a value in GPR 15 as follows:

0000 Exit completed successfully.

Anything Else

Exit did not complete successfully. Message EZY0660E is accompanied by either:

- For VTAM - sense code x'081C0109'
- For JES - return code 3003

Output

See "Parameter list contents" on page 116

Registers at exit

GPR15

As defined above

All other registers

Restored to caller's values

SPIN=GROUP restrictions

NPF provides support in the JES capture point for SPIN=GROUP processing when the data sets in the group have different characteristics. To correctly process data sets with different characteristics, the following restrictions apply when SPIN=GROUP is specified:

- If a record format for the QSAM data sets other than RECFM=VBA is required, then the input record exit must be coded to override the RECFM.
- If the RECFM is overridden by the input record exit and any record contains carriage control, NPF will NOT strip off the carriage control. It will be passed as the first character of the data block.
- The IDX flags are checked for every SYSOUT record. If neither the ANSI nor the machine carriage control characters are set, a DEFAULT new line Carriage

Control is ADDED in the first byte. If the input record exit must check if this carriage control byte has been added, the address of the IDXFLAG1 byte is passed in the JES-specific parameter area (IRECPAD). If IDXANSI (x'20') and IDXMACH (x'10') are zero, the carriage control byte has been added.

- All output created by SPIN=GROUP processing will have carriage control unless overridden by the input record exit. Avoid coding the NOCC LPR option in the options file unless an input record exit will be used to override the VBA format.
- For SPIN=GROUP processing, the parameter list passed to the input record exit contains a pointer to the GETDS parameter from the currently ACTIVE data set, not the FIRST data set in the group.
- The JES JOB Separator Page Data Area (JSPA) is addressable only from the GDSJSPA field of the current GETDS parameter. For SPIN=GROUP processing, the JSPA is for the CURRENT data set in the group only. If information is needed from the JSPA of the first data set while processing subsequent data sets in the group, the input record exit must make its own copy of the required data.

Input record exit to delete leading blank pages

The following information shows an example of an input record exit that deletes leading blank pages from the printed output. You can copy this sample from *hlq.SEZAINST(DELBLANK)*.

```

DELBLANK TITLE 'Input Record Exit to Delete Leading Blank Pages'
*-----*
*  DELBLANK NPF Sample Input Record Exit  *
*-----*
*
*  COPYRIGHT = NONE                       *
*
*  SMP/E Distribution Name: EZAEC043      *
*
*  Some applications generating SNA print data streams force a new *
*  page at the beginning of independent pieces of work. This      *
*  correspond with the NPF end-of-file rule specified.            *
*
*  Some LPD print managers force a new page between files.       *
*
*  If both are true, the printed output will begin with a blank  *
*  page. This NPF input record exit looks at the carriage control *
*  character on the first line of output in files from the NPF VTAM *
*  capture point application. If it is a form feed, it is changed *
*  to an overstrike so that printing will begin on the first page. *
*
*-----*
DELBLANK CSECT
DELBLANK AMODE ANY
DELBLANK RMODE ANY
*          Registers          entry    DELBLANK    exit
R0      EQU  0                n/a      work      =entry
R1      EQU  1                >>IRELIST work      =entry
R2      EQU  2                n/a      work      =entry
R3      EQU  3                n/a      work      =entry
R4      EQU  4                n/a      work      =entry
R5      EQU  5                n/a      work      =entry
R6      EQU  6                n/a      work      =entry
R7      EQU  7                n/a      work      =entry
R8      EQU  8                n/a      >IRXSTATD =entry
R9      EQU  9                n/a      >RTDATA   =entry
R10     EQU 10                n/a      >IRELIST  =entry
R11     EQU 11                n/a      base 2   =entry
R12     EQU 12                n/a      base 1   =entry
R13     EQU 13                >callsave >DELBSTG =entry

```

```

R14    EQU    14                >return    work    =entry
R15    EQU    15                >DELBLANK  retcode  retcode
      SPACE 5
      USING DELBLANK,R15      Establish temporary base register
      B      DELB0000        Branch around constants
      DC     CL9'DELBLANK'    Module identifier
      DC     CL9'&SYSDATE'    Assembly date
      DC     CL6'&SYSTIME'    Assembly time
DELBASE2 DC A(DELBLANK+4096) Second base register if needed
      SPACE 5
DELB0000 DS 0H
      STM    R14,R12,12(R13)  Save caller's registers
      LR     R12,R15          Change base registers
      DROP   R15             Tell assembler
      USING DELBLANK,R12,R11
      L      R11,DELBASE2    Establish second base register
      L      R10,0(R1)       Get address of exit parameter list
      USING IRELIST,R10      Make exit parameter list addressable
      L      R9,IRERTD       Get address of routing data area
      USING RTDATA,R9       Make routing data area addressable
      L      R8,IRESTRG      Get address of IRE static memory
      USING IRXSTATD,R8     Make IRE static storage addressable
      ICM    R1,15,IRXDSTGA  Get address of IRE dynamic storage
      BNZ    DELB0020        Storage has already been allocated
      LA     R2,DELBSTGL     Get length of program storage
      GETMAIN RC,LV=(R2),LOC=ANY Get program storage
      LTR    R15,R15         Did GETMAIN work?
      BZ     DELB0010        Yes
      WTO    'DELBLANK GETMAIN FAILED'
      LA     R15,8           No, show error
      B      RET00010        Return to NPF
DELB0010 DS 0H
      ST     R1,IRXDSTGA     Save dynamic storage address
DELB0020 DS 0H
      ST     R1,8(0,R13)     Complete save area pointers
      ST     R13,4(0,R1)
      LR     R13,R1          Point to dynamic storage area
      USING DELBSTG,R13     Tell assembler
      SPACE 5
      CLC    RTFUNCTN(4),=CL8'OPEN' Is this OPEN call?
      BE     OPN00000        Yes
      CLC    RTFUNCTN(3),=CL8'PUT' Is this PUT call?
      BE     PUT00000        Yes
      CLC    RTFUNCTN(5),=CL8'CLOSE' Is this CLOSE call?
      BE     CLS00000        Yes
      CLC    RTFUNCTN(7),=CL8'RELEASE' Is this RELEASE call?
      BE     REL00000        Yes
      CLC    RTFUNCTN(4),=CL8'TERM' Is this TERM call?
      BE     TRM00000        Yes
      WTO    'DELBLANK UNKNOWN FUNCTION'
      LA     R15,4           Bad function, show error
      B      RET00000        Return to NPF
      SPACE 5
*-----*
*          Process OPEN call
*-----*
OPN00000 DS 0H
      MVI    IRXFLAG,IRXNEW  Set flag for new file
      XR     R15,R15         Zero return code
      B      RET00000        Go return to NPF
*-----*
*          Process PUT call
*-----*
PUT00000 DS 0H
      CLI    IRXFLAG,IRXNEW  First PUT to this file?
      BNE    PUT00020        No, pass it through
      MVI    IRXFLAG,IRXOLD  Only look at first PUT

```



```

        CLI  IRECID,C'V'      Is this VTAM application?
        BNE  PUT00020        No, pass it through
        L    R2,IREBPTR      Get input buffer pointer
        CLI  RTDARTYP,C'V'   Variable length records?
        BNE  PUT00010        No, continue
        LA   R2,4(0,R2)      Yes, point past record descriptor
PUT00010 DS    0H           R2 points to carriage control
        CLI  0(R2),C'1'      Is it form feed?
        BNE  PUT00020        No, pass it through
        MVI  0(R2),C'+'      Change to overstrike
PUT00020 DS    0H
        MVI  IREWFLG,X'00'   Write this record
        MVI  IRERFLG,X'00'   Read next record
        XR   R15,R15         Zero return code
        B    RET00000        Go return to NPF
-----*
*          Process CLOSE call
-----*
CLS00000 DS    0H
        MVI  IREWFLG,X'01'   No record to write
        MVI  IRERFLG,X'00'   Normal return from CLOSE
        XR   R15,R15         Zero return code
        B    RET00000
-----*
*          Process RELEASE or TERM call
-----*
REL00000 DS    0H
TRM00000 DS    0H
        LA   R2,DELBSTGL     Get length of dynamic storage
        LR   R1,R13          Get address of dynamic storage
        L    R13,SAVEAREA+4  Get address of caller's save area
        FREEMAIN RU,LV=(R2),A=(R1) Free dynamic storage
        XR   R15,R15         Zero return code
        B    RET00010
        SPACE 5
-----*
*          Return to NPF
-----*
RET00000 DS    0H
        L    R13,SAVEAREA+4  Return to caller
RET00010 DS    0H
        ST   R15,16(R13)     Set return code in saved R15
        LM   R14,R12,12(R13) Restore caller's registers
        BSM  0,R14
        EJECT
-----*
*          Program constants
-----*
        LTORG
        SPACE 5
IRXSTATD DSECT              16 byte static IRE storage
IRXDSTGA DS    A            Address of dynamic storage area
IRXFLAG  DS    X            File status flag
IRXNEW   EQU   X'00'        ... first record in file
IRXOLD   EQU   X'FF'        ... not first record in file
        DS    3X            unused
        DS    D             unused
        SPACE 5
DELBSTG  DSECT
SAVEAREA DS    18F          Save Area
        DS    0D            Round up to double word boundary
DELBSTGL EQU   *-DELBSTG    Length of dynamic storage area
        SPACE 5
EZAPPFCD IRE=DSECT,        DSECT for input record exit parameters X
        RDA=DSECT          DSECT for routing data area
        SPACE 5
        END    ,            End of DELBLANK module

```

The Routing Data Area (RDA)

This data area (for a layout see Appendix B, "Network Print Facility's Routing Data Area (RDA)," on page 153) is the cornerstone of the Network Print Facility. It contains the routing information referenced by the Network Print Facility. The Network Print Facility can build the RDA, or the user can build it. In either case, it must be established so the Network Print Facility can access the routing information required.

The routing data area is accessible to all three exits. If the general routing exit builds the routing data area, it should initialize all fields. Fields that can be modified by either the specific routing exit or the input record exit are marked.

Use the general routing exit (EZAGRPPR) to create the routing data area.

Both the general routing exit and the specific routing exit affect the RDA. The Network Print Facility modifies the RDA depending on the result of a series of checks, as follows:

1. Does a general routing exit exist?
Invoke it. The general routing exit does one of the following things:
 - a. Builds the RDA (don't read the routing and options files).
 - b. Modifies the keys used to read the routing and options files.
 - c. Nothing.
2. The GRE notifies NPF of the results of this check. If no RDA was built, NPF builds one.
The system then checks if a specific routing exit exists. If there is one, the Network Print Facility invokes it.
The specific routing exit can modify the RDA.

See Appendix B, "Network Print Facility's Routing Data Area (RDA)," on page 153 for the exact structure of the RDA.

Using the EZAPPFCD macro

Use the EZAPPFCD macro to generate the data areas you need and to supply the appropriate information for the RDA. This macro provides copies of parameter lists and record formats for the Network Print Facility. All specifications are optional.

Environment

MVS Assembler

Programming Requirements

The use of YES/DSECT options creates a DSECT. Your program needs to resume the previous CSECT. Use of the INLINE option creates parameter lists or record descriptions within the current CSECT/DSECT.

Restrictions

None

Input Regs

Not Applicable

Output Regs

Not Applicable

Performance Implications

None

Abend Codes

None

Return Codes

None

Syntax

Macro Syntax:



Parameters

RDA=YES|DSECT|NO

YES, DSECT

Generate Routing Data Area DSECT

NO Do not generate Routing Data Area DSECT

IRE=YES|DSECT|NO|INLINE

YES, DSECT

Generate Input Record Exit Parameter List DSECT

NO Do not generate Input Record Exit Parameter List

INLINE

Generate Input Record Exit Parameter List definition

SRE=YES|DSECT|NO|INLINE

YES, DSECT

Generate Specific Routing Exit Parameter List DSECT

NO Do not generate Specific Routing Exit Parameter List

INLINE

Generate Specific Routing Exit Parameter List definition

GRE=YES|DSECT|NO|INLINE

YES, DSECT

Generate General Routing Exit Parameter List DSECT

NO Do not generate the General Routing Exit Parameter List

INLINE

Generate General Routing Exit Parameter List definition

Example

```
EZAPPCD , X  
      IRE=DSECT      Generate DSECT for Input Record Exit
```

Chapter 8. Operating the Network Print Facility

To start the Network Print Facility, you need separate JCL procedures for each instance of the NPF FSS writer, the VTAM capture point, and the queue manager. Similarly, to terminate the Network Print Facility or modify it while it is running, you need to perform separate actions for each part of the Network Print Facility.

The FSS writers are started by JES console commands. Both the VTAM capture point and queue manager can be submitted as batch jobs or converted to procedures, stored in a system PROCLIB, and started from the console with the MVS START command.

Note: z/OS Communications Server must be running before you start the NPF VTAM capture point, FSS writer, or queue manager programs.

The chapter includes information on how to:

- Start, stop, and operate the NPF FSS Writer
- Start, stop, and operate the VTAM Capture Point
- Start, stop, and operate the Queue Manager

TCP/IP High-Level Qualifier

The high-level qualifier is determined as part of the overall TCP/IP configuration and is explained in “TCPIP.DATA configuration” on page 16. It can be specified in TCPIP.DATA with the DATASETPREFIX statement, or left to the system default value. If you are using the //SYSTCPD DD statement to specify TCPIP.DATA, ensure that ISPF can find your defined high-level qualifier by including this statement in:

- All NPF (JES and VTAM) capture point startup procedures
- All queue manager start up procedures
- TSO/E ISPF user logon procedure

Operating the NPF FSS writer

Before you can start and operate an FSS writer you need to have:

- The FSS defined to JES (FSSDEF)
- A start procedure catalogued in the system or other recognized PROCLIB (the catalogued procedure must have access to the JES program named HASPFSSM).

After these have been defined to your system, you can enter commands at the operator console to start and stop the individual FSS writers which are running as FSA subtasks.

On some systems, you can also stop the entire FSS address space with the CANCEL command. For example, to stop the address space of a functional subsystem defined as FSSNAME=TCPFSS or FSSDEF(TCPFSS), you would enter:

```
C TCPFSS
```

Creating the NPF FSS writer start procedure

The following information shows a sample procedure to start an NPF FSS writer. You can copy this sample from *hlq.SEZAINST(FSWTR)*, modify it to suit your environment, and catalogue it to a recognized PROCLIB, such as the SYS1.PROCLIB.

Note: The log file cannot be shared. If you want to run more than one instance of the NPF FSS writer, you will need separate procedures with a unique name for this data set in each procedure.

```
//FSWTR PROC
//* -----*
//*
//* COPYRIGHT = NONE
//*
//* SMP/E Distribution Name: EZAECOYU *
//*
//* This JCL starts the Network Print Facility's JES interface.
//*
//* The executable code is assumed to be in a link library which is
//* in the system link list. (The default is TCPIP.SEZALINK).
//*
//* REGION=3M is specified to provide sufficient below-the-line
//* storage for a writer with a single FSA (printer) subtask.
//* That number should be increased by 850K for each additional
//* FSA (printer) subtask defined for the writer.
//*
//* In this sample, the names of the routing, options and queue
//* files are:
//*
//* TCPIP.ROUTING
//* TCPIP.OPTIONS
//* TCPIP.QUEUE
//*
//* All three are assumed to have been created and initialized
//* prior to the use of this JCL.
//*
//* The log data set for this sample is TCPIP.JES1.LOG.
//*
//* NOTE: All temporary data sets created by Network Print Facility
//* will have the high-level qualifier specified via the
//* defined search sequence. (See "Configuring NPF Using
//* TCPIP.DATA and NPF.DATA Statements" in IBM TCPIP for MVS:
//* Network Print Facility).
//*
//* In this sample, user specified defaults will be found
//* in the TCPIP.DATA data set defined by the SYSTCPD DD
//* statement and in the NPF.DATA data set defined by the
//* SYSNPFD DD statement.
//* -----*
//IEFPROC EXEC PGM=EZAPPF5,REGION=3M
//EZAPPRF DD DSN=TCPIP.ROUTING,DISP=SHR
//EZAPPOF DD DSN=TCPIP.OPTIONS,DISP=SHR
//EZAPPQF DD DSN=TCPIP.QUEUE,DISP=SHR
//EZAPPLLOG DD DSN=TCPIP.JES1.LOG,DISP=OLD
//SYSTCPD DD DSN=TCPIP.TCPIP.DATA,DISP=SHR
//SYSNPFD DD DSN=TCPIP.NPF.DATA,DISP=SHR
//SYSPRINT DD SYSOUT=*
//SYSABEND DD SYSOUT=*
//SYSMDUMP DD SYSOUT=*
```

Modifying the NPF FSS writer start procedure

ESTAE-SDUMP, SPIN, and MSG-SUPPRESS are a few of the run-time options available for the NPF FSS writer.

ESTAE-SDUMP=YES**|NO**

This option specifies whether the ESTAE routine will issue an SDUMP (SVC dump) whenever an FSS or FSA task abends. Specification of this parameter immediately affects all subsequent task abends.

YES Specifies an SDUMP will be issued. This is the default.

NO Specifies an SDUMP will not be issued.

SPIN=DATASET**|GROUP**

This specifies how the data sets received from JES should be written to output data sets.

DATASET

Specifies an output data set will be written for each data set received from JES.

GROUP

Specifies an output data set will be written for each group of data sets received from JES. This option is appropriate for JES2 users and is the default.

A data set group starts when JES sends a START or CONTINUE job separator page area (JSPA) and ends when JES sends an END JSPA or another START or CONTINUE JSPA.

Specification of this parameter affects only the SYSOUT data sets that have not yet been selected by the FSA. Data set that have already been selected use the previous setting.

In JES3 environments, use the SPIN=DATASET option on the NPF FSS writer to separate the output into individual data sets.

QSAMLRECL=4092 **32756**

This option specifies the logical record length (LRECL) to be used when allocating the print data set.

4092 Specifies an output data set LRECL of 4092, which is the default. Specifying 4092 instructs NPF to process output as if the maximum LRECL is 4088 bytes or less. If you specify 4092 and the output records are greater than 4088 bytes, the FSS writer will ABEND.

32757 Specifies an output data set LRECL of 3275. Specifying 32756 allows NPF to process output with LRECLs up to 32752 bytes. You must specify 32756 if any output records are larger than 4088 bytes.

MSG-SUPPRESS=NONE

This debugging option should be used only at the direction of the IBM Support Center to gather additional trace data for problem resolution.

You can establish or modify the run-time options for the NPF FSS writer procedure in three ways.

- With the PARM field on the EXEC statement in the NPF FSS writer start procedure
- With a PARMLIB DD statement in the NPF FSS writer start procedure
- Dynamically, using the MVS modify command

The system processes options in the above order. If an option is specified in more than one way, the system uses the last one specified.

Using the PARM field to specify options

You can specify run-time options with the optional PARM field on the EXEC statement in the NPF FSS writer start procedure. Separate each option by a comma. For example:

```
//IEFPROC EXEC PGM=EZAPPF,REGION=3M,PARM='ESTAE-SDUMP=NO'  
//STEPLIB DD DSN=TCPIP.V3R2.LOAD,DISP=SHR
```

Using a PARMLIB DD statement to specify options

You can specify run-time options with an optional PARMLIB DD statement in the NPF FSS writer start procedure.

This statement points to a sequential data set or partitioned data set member. It must contain fixed 80-byte records (RECFM=F or FB, LRECL=80). Each record in this data set can be a string of options from 1 to 80 bytes long. Each option should be separated by a comma with no blanks between. Options must start in column 1.

For example,

```
//IEFPROC EXEC PGM=EZAPPF,REGION=3M  
//PARMLIB DD DSN=USER1.SOURCE(INPARM),DISP=SHR  
//STEPLIB DD DSN=TCPIP.V3R2.LOAD,DISP=SHR  
...
```

where USER1.SOURCE(INPARM) might contain:

```
ESTAE-SDUMP=NO  
SPIN=GROUP
```

Using the MVS modify command to change options

After the NPF FSS writer has been started, you can dynamically make changes by passing an options string with the MVS MODIFY command.

For example, if the FSS was defined as TCPFSS, at the operator console you can enter:

```
F TCPFSS,ESTAE-SDUMP=NO
```

When using the MODIFY command, be aware of when the new option takes effect. Some options take effect immediately, others take effect on subsequent print jobs. Some options are captured when an FSA or device is started. In these cases, that FSA would have to be stopped and restarted to cause the new options to take effect.

Defining, starting, and stopping the NPF FSS writer

Put your short description here; used for first paragraph and abstract.

Table 13 on page 129 describes how to define, start, and stop the NPF FSS writer on various levels of JES. Before issuing any of these commands, the procedure to start the NPF FSS writer must be catalogued in a system or recognized PROCLIB. See "Creating the NPF FSS writer start procedure" on page 126.

Because the JES capture point is defined as a functional subsystem, only the JES commands (\$SPRTx or *S,PRTx) can be used to start the NPF writer. The MVS START command cannot be used to initiate the writer.

Table 13. Defining, starting, and stopping the NPF FSS writer

Level	How to Define	How to Start or Stop
JES2 Version 6	<p>The functional subsystem and FSS writer definitions can be specified either through JES initialization parameters or by entering commands interactively.</p> <p>The following example shows the initialization parameters to define an NPF FSS called TCPFSS which points to a start procedure called FSWTR. It also defines two FSS writers called PRT5 and PRT6 that process class D output.</p> <pre>(optional:) DESTID(DEST1) DEST=U1 (optional:) DESTID(DEST2) DEST=U2 FSS(TCPFSS) PROC=FSWTR,AUTOSTOP=YES PRT5 CLASS=D,SEP=YES, SEPDS=NO, DRAIN,MODE=FSS, FSS=TCPFSS, TRKCELL=YES, PRMODE=(LINE,PAGE), NPRO=0, ROUTECDE=DEST1, SETUP=NOHALT, WS=(Q,R/) PRT6 CLASS=D,SEP=YES, SEPDS=NO, DRAIN,MODE=FSS, FSS=TCPFSS, TRKCELL=YES, PRMODE=(LINE,PAGE), NPRO=0, ROUTECDE=DEST2, SETUP=NOHALT, WS=(Q,R/)</pre> <p>The following example shows the console commands to define an NPF FSS called TCPFSS which points to a start procedure called FSWTR and to define two FSS writers to process class D output.</p> <pre>\$ADD FSS(TCPFSS), PROC=FSWTR,AUTOSTOP=YES \$ADD PRT5,MODE=FSS, FSS=TCPFSS,CLASS=D \$ADD PRT6,MODE=FSS, FSS=TCPFSS,CLASS=D</pre>	<p>To start the FSS writer that is processing class D output, from the operator console, enter:</p> <pre>\$SPRT5</pre> <p>To stop the same FSS writer, from the operator console, enter:</p> <pre>\$PPRT5</pre> <p>To start both FSS writers, two commands are needed. From the operator console, enter:</p> <pre>\$SPRT5 Then enter: \$SPRT6</pre> <p>To stop both FSS writers, enter:</p> <pre>\$PPRT5 Then enter: \$PPRT6</pre>

Table 13. Defining, starting, and stopping the NPF FSS writer (continued)

Level	How to Define	How to Start or Stop
JES3 Version 6	<p>The functional subsystem and FSS writers are defined by JES initialization parameters.</p> <p>The following example shows the initialization parameters to define an NPF FSS called TCPFSS which points to a start procedure called FSWTR. It also defines an FSS writer called PRT501 that processes class C output.</p> <pre> DEVICE, DTYPE=PRT3820, JNAME=PRT501, DYNAMIC=NO, MODE=FSS, FSSNAME=TCPFSS, HEADER=YES, BURST=NO, NPRO=NO, SETUPMSG=NO, FORMS=(YES, STANDARD), JUNIT=(, SY1, S1, ON, , SY2, S2, OFF), PM=LINE, WS=(CL, F), WC=C FSSDEF, TYPE=WTR, FSSNAME=TCPFSS, SYSTEM=(SY1), PNAME=FSWTR, TERM=YES, AUTOSTOP=YES </pre>	<p>To call the FSS writer that is processing class C output, from the operator console, enter:</p> <pre>*X,WTR,OUT=PRT501</pre> <p>To start the FSS writer that is processing class C output, from the operator console, enter:</p> <pre>*S,PRT501</pre> <p>To enable the FSS writer to process class D output instead of class C, from the operator console, enter:</p> <pre>*X,WTR,OUT=PRT501,WC=D</pre> <p>To stop the same FSS writer, from the operator console, enter:</p> <pre>*C,PRT501</pre>

For more information about starting and stopping FSS writers, see *z/OS JES2 Commands* or *z/OS JES3 Commands*.

Helpful reminders

- JES output files can be routed by the following methods:
 - Specify the CLASS, DEST, and FORMS parameters in the JCL of the print jobs before you submit them.
 - With JES2, use the Spool Display and Search Facility (SDSF) to dynamically alter CLASS, FORMS, or DEST specifications of jobs already in the queue.
- IBM recommends using the NPRO=0 or NPRO=NO in your FSS definitions. If you use any other value, the NPF FSS writer processes the last file on the JES queue and leaves it on the queue until either a new file enters the queue or an internal timer runs out.
- If your JES3 installation is set up to route all output to the JES hold queue, you can use the following commands to move a job from the hold queue to the writer queue:

*I,J=jobname	to find out the job number
*F,U,J=jobnumber,Q=HOLD,NQ=WTR	to move the job from the JES hold queue to the NPF FSS writer queue
- The following example shows you how to set up an NPF FSS writer for called PRT6 that uses CLASS as the only selection criterion. See *JES2 Commands* or *JES3 Commands* for variations that might be more appropriate for your specific environment.

\$DU PRT6	to display the printer setup
\$T PRT6,WS=(-R/)	PRT6 uses CLASS as the only selection criterion

- JES2 users should use the SEP parameter in their FSS writer definitions. SEP is the default, and is specified as follows:
 - For JES2 Version 4, specify SEP=YES
 - For JES2 Version 2 and 3, specify SEP NOSEP, available in JES2 Version 2 and 3, will group more than 2 data sets into 1.
 - We recommend that the AUTOSTOP=YES parameter be specified on the FSS definition.

Operating the NPF VTAM capture point

The following sections show you the JCL needed to start the NPF VTAM capture point application, the commands you can use to modify it while it is running, and the options you have for stopping it.

Starting the NPF VTAM capture point

The following shows a sample procedure to start an NPF VTAM capture point application. You can copy this sample from *hlq.SEZAINST(EZAPPAAA)* and modify it to suit your environment.

Note: The log file cannot be shared. If you want to run more than one instance of the VTAM capture point application, you will need separate startup procedures with a unique name for each data set in each procedure.

```
//EZAPPAAA JOB
//*-----*
//*
//* COPYRIGHT = NONE
//*
//* SMP/E Distribution Name: EZAECOYS
//*
//* This JCL starts the Network Print Facility's VTAM Capture Point
//* application.
//*
//* The executable code is assumed to be in a link library which is
//* in the system link list. (The default is TCP/IP.SEZALINK).
//*
//* In this sample, below-the-line storage usage is assumed to have
//* been estimated as follows:
//*   0.5M - for a minimum-sized application
//*   3.5M - for storage to handle in-process print files.
//*
//* The following values in the JCL reflect these assumptions:
//*
//* The REGION parameter specifies the maximum amount of
//* below-the-line storage which MVS will allow for this
//* application. The 4M value in this sample is the sum of the
//* two assumed values described above.
//*
//* The MAXFLSTG subparameter limits the amount of below-the-line
//* storage which the Network Print Facility will request for
//* print files which are still in process of being received.
//* Each open print file uses up 16K of this limit. The 3584K
//* value (3.5M) specified in this sample will allow a maximum
//* of 224 print files to be open at the same time.
//*
//* TIME is coded with 1440 so we don't time out.
//*
//* The subparameter LUCLASS is coded (1,2) to pick up any printers
//* in our LU classes 1 and/or 2.
//*
```

```

/** In this sample, the names of the routing, options and queue
/** files are:
/**
/**      TCPIP.ROUTING
/**      TCPIP.OPTIONS
/**      TCPIP.QUEUE
/**
/** All three are assumed to have been created and initialized
/** prior to the use of this JCL.
/**
/** The log data set for this sample is TCPIP.VTAM1.LOG.
/**
/** NOTE: All temporary data sets created by Network Print Facility
/** will have the high-level qualifier specified via the
/** defined search sequence. (See "Configuring NPF Using
/** TCPIP.DATA and NPF.DATA Statements" in IBM TCPIP for MVS:
/** Network Print Facility).
/**
/** In this sample, user specified defaults will be found
/** in the TCPIP.DATA data set defined by the SYSTCPD DD
/** statement and in the NPF.DATA data set defined by the
/** SYSNPFDD DD statement.
/**
/**-----*
//EZAPPA   EXEC PGM=EZAPPA   ,REGION=4M,TIME=1440,
//          PARM='LUCLASS=(1,2),MAXFLSTG=3584K'
//EZAPPRF  DD DSN=TCPIP.ROUTING,DISP=SHR
//EZAPPOF  DD DSN=TCPIP.OPTIONS,DISP=SHR
//EZAPPQF  DD DSN=TCPIP.QUEUE,DISP=SHR
//EZAPPLOG DD DSN=TCPIP.VTAM1.LOG,DISP=OLD
//SYSTCPD  DD DSN=TCPIP.TCPIP.DATA,DISP=SHR
//SYSNPFDD DD DSN=TCPIP.NPF.DATA,DISP=SHR
//SYSPRINT DD SYSOUT=*
//SYSABEND DD SYSOUT=*
//SYSMDUMP DD SYSOUT=*

```

Specifying VTAM capture point parameters

The required and optional parameters for the VTAM capture point application are passed by the PARM parameter on the EXEC statement of the start procedure. Add your parameters following PARM=, making certain that:

- All parameters are in uppercase
- Parameters are separated by commas
- Each set of parameters is enclosed in quotes

For example: //EZAPPA EXEC
PGM=EZAPPA ,PARM='LUCLASS=(1,2),MAXFLSTG=2150K'

Syntax

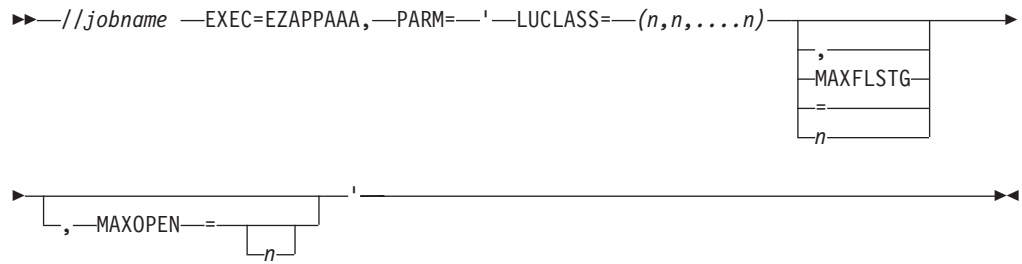

Parameters

LUCLASS=(n,n,...n)

Specifies the LU names from the routing file that this instance of the Network Print Facility's VTAM capture point will process.

This field is required. Valid values are 1 to 64. Separate each value with a comma. No comma should follow the last value.

MAXFLSTG=n

Specifies the maximum amount of below-the-line private storage you want to allow for the processing of open temporary print data sets.

This parameter is optional and has no default value. The value specified is limited to 8 characters and can specify a number of bytes, kilobytes or megabytes. For example, you can specify a value of 2 megabytes as 2097152, 2048K or 2M.

This parameter is intended to prevent abends caused by excessive requests for below-the-line storage. The value should equal the REGION parameter value minus the total below-the-line storage required for code and control blocks. See "Creating a startup procedure" on page 25.

When the below-the-line storage needed for a new temporary print data set would cause the MAXFLSTG limit to be exceeded, the new print data request is rejected with an X'08120000' (insufficient resources) sense code. This prevents a GETMAIN request which could cause an abend due to a REGION size violation.

MAXOPEN=n

Specifies the maximum number of temporary print data sets that can be open at any given time.

At 16 KB of below-the-line storage per open print data set, this is simply a less direct, alternative method of specifying the same storage limit described under MAXFLSTG.

This parameter is optional and has no default value. If the parameter is omitted, a maximum of 1 temporary print data set per logical printer can be open at any given time.

The parameter value is limited to 8 digits and must be non-zero.

When the opening of a new temporary print data set would cause the MAXOPEN limit to be exceeded, the new print data request is rejected with an X'08120000' ('insufficient resources') sense code.

Modifying the NPF VTAM capture point

While the VTAM capture point application is running, you can dynamically add or delete logical printers and replace the end-of-file rules and default page format



Parameters

luname

The 8-character logical printer to add or delete. This name is the same as the major name key field in the ROUTING file.

ADD

Adds a new printer. This *luname* must already have a VTAM entry in the routing file (one that has an LUCLASS specified).

DEL

Deletes an existing printer. The *luname* must already be inactive in the NPF's VTAM capture point. This can be done by deactivating the LU in VTAM. If the logical printer was never active in NPF's VTAM capture point (it was unable to be opened), then it can be deleted at any time.

Usage notes

The new logical printer is considered added after the ROUTING file entry is located, related control blocks are created, and an initial attempt to OPEN its ACB is complete. For the printer to become active, it must also already be defined and active in VTAM.

Examples

To add a logical printer to the NPF's VTAM capture point, enter this response to message EZY0837I:

```
R nn,LUNAME=ELU10100,ADD
```

To delete a logical printer from the NPF's VTAM capture point, enter this response to message EZY0837I:

```
R nn,LUNAME=ELU10100,DEL
```

RELOAD: Dynamically replacing a table

Use the RELOAD operator response to dynamically replace the end-of-file rules or default page format tables. This operator response does not affect any current session, only sessions established after executing this command.

Syntax

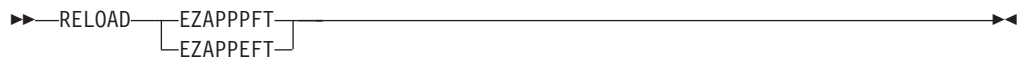

Parameters

EZAPPPFT

Replaces the default page format table

EZAPPEFT

Replaces the end-of-file rules table

Examples

To replace the default page format table, enter this response to message EZY0837I:

```
R nn,RELOAD EZAPPPFT
```

Stopping the NPF VTAM capture point

You can terminate the VTAM capture point application by issuing a QUIT, QUIT FORCE, or KILL response to message EZY0837I.

QUIT: Normal termination

Use one of the variations of the QUIT command as the normal way to terminate NPF's VTAM capture point application.

Syntax

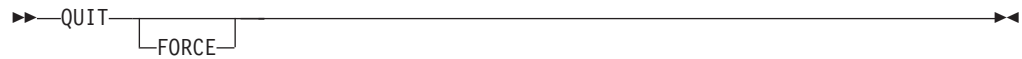

QUIT

Prevents any new sessions from starting but allows each current session to continue normal operation. Only after all current sessions have ended naturally will the NPF VTAM capture point terminate.

Because this request does nothing to force an end to current sessions, it is possible to have a long delay between entering the reply and the actual termination. Each session ends naturally only when the session partner LU decides to end it.

QUIT FORCE

Acts the same as QUIT, except that current sessions are forced to end immediately instead of being allowed to continue. QUIT FORCE normally terminates more quickly than QUIT; however, any files only partially received when QUIT FORCE is issued will result in output with incomplete data.

Examples

To stop the NPF's VTAM capture point, enter this response to message EZY0837I:

```
R nn,QUIT
```

To stop the NPF's VTAM capture point and force all current sessions to end, enter this response to message EZY0837I:

```
R nn,QUIT FORCE
```

KILL: Immediate Termination

Use the KILL operator response only for emergency termination of NPF's VTAM capture point. This request causes immediate termination with no attempt to end sessions or clean up open print files. Loss of print files can occur.

Syntax

Attention: This is not a recommended operator control. It is included only to allow the operator a way out if a hang condition prevents completion of a QUIT FORCE request.

Examples

To stop the NPF's VTAM capture point and all sessions immediately, enter this response to message EZY0837I:

```
R nn,KILL
```

Effects of VTAM HALT commands on the NPF VTAM capture point

When a console operator enters a HALT command to end VTAM, the effect to the NPF VTAM capture point application depends on the type of HALT.

- A standard HALT causes the orderly closing of the ACBs for all logical printers, but the Network Print Facility continues.
No new sessions are allowed to start, but existing sessions are allowed to continue normally. After a logical printer's sessions have ended naturally, the logical printer's ACB is closed. The Network Print Facility application remains operational, periodically attempting to reopen the ACBs for its logical printers.
- A HALT QUICK causes processing essentially identical to that for the standard HALT, except that each existing session is ended immediately via a TERMSESS macro.
- A HALT CANCEL causes the immediate closing of each logical printer's ACB, automatically ending any existing sessions. Data already received is processed. The then ends by returning to MVS.

Operating the queue manager

The following sections show you the JCL needed to start the NPF queue manager, the commands you can use to modify it while it is running, and the options you have for stopping it.

Starting the NPF queue manager

The queue manager program, EZAPPQSA, runs in a separate address space from other Network Print Facility activities.

It is possible to run multiple instances of the NPF queue manager at the same time, subject to the following restrictions:

- Each instance of the NPF queue manager should do processing for a different queue file and should have its own unique log file.
- All queue records for any given printer should be in a single queue file and, therefore, processed by a single instance of the NPF queue manager.

Specifying NPF queue manager parameters

The required parameters for the NPF queue manager are passed by the PARM parameter on the EXEC statement of the start procedure.

Syntax

▶ `—//—jobname —EXEC=EZAPPQSA,—PARM=—'—time—'` ▶

Parameters

time

This parameter is used to specify the scan interval used by the queue manager. This field is required.

The interval is specified in hours, minutes, and seconds in the format of *hhmmss*. Significant digits are required to be specified. For example, 2 minutes can be coded as 000200 or 200. The maximum value you can enter is 999999.

Note: A long scan interval uses fewer resources but delays the initial attempts to send new print jobs.

Modifying the NPF queue manager

While the NPF queue manager is running, you can dynamically change the scan interval and turn the trace facility on or off. To do this, at the operator's console, enter INTERVAL, TRACE, or NOTRACE in response to message EZY0960I.

INTERVAL: Change scan time

Use the INTERVAL operator response to dynamically change the scan time interval.

Syntax

▶▶—INTERVAL=—time—▶▶

time

This parameter is used to specify the new scan interval. The interval is specified in hours, minutes, and seconds in the format of *hhmmss*. Significant digits are required to be specified. For example, 2 minutes can be coded as 000200 or 200. The maximum value you can enter is 999999.

Note: A long scan interval uses fewer resources but delays the initial attempts to send new print jobs.

Examples

To change the queue manager's scan time interval to 1 hour and 30 minutes, enter this response to message EZY0960I:

```
R nn,INTERVAL=13000
```

TRACE: Turn on console trace

Use the TRACE operator response to dynamically turn on the console trace. This allows the operator to follow the flow of the NPF queue manager on the console.

Syntax

▶▶—TRACE—▶▶

Examples

To start a trace of the NPF queue manager, enter this response to message EZY0960I:

```
R nn,TRACE
```

NOTRACE: Turn off console trace

Use the NOTRACE operator response to dynamically turn off the console trace. This allows the operator to stop the NPF queue manager from reporting on its flow.

Syntax

Examples

To stop a trace of the NPF queue manager, enter this response to message EZY0960I:

```
R nn,NOTRACE
```

Stopping the NPF queue manager

You can terminate the NPF queue manager by issuing a STOP response to message EZY0960I. This response terminates the queue manager immediately following the completion all its outstanding processing.

For example, to stop the NPF queue manager, enter this response to message EZY0960I:

```
R nn,STOP
```

Stopping the Network Print Facility

In order to stop the Network Print Facility you must stop each of its programs:

- The JES capture point (See Table 13 on page 129)
- The VTAM capture point application (See “Stopping the NPF VTAM capture point” on page 136)
- The NPF queue manager (See “Stopping the NPF queue manager”)

Because these all are independent programs and run in separate address spaces, they can be stopped individually at any time.

Chapter 9. Diagnosing Network Print Facility Problems

Diagnosis information includes:

- NPF FSS Writer Return Codes
- Lists of Common Problems
- Network Print Facility Tracing
- Generation of the Queue File Name
- SNA Sense Codes

NPF FSS writer return codes

These return codes can be received via Network Print Facility messages EZA0932E and EZA0933E.

0001	Incorrect function code
0002	Error on program GETMAIN
0003	Load failure
0004	Load failure for input record exit
0005	ATTACH failed
0006	LINK of LPR failed
0007	SOKETS initialization failed
1001	Error on GETMAIN in ALLOC function
1002	Routing/Options file error
1003	Open failed
1004	Routing record not found
1005	Link error on specific routing exit
1006	Options record not found
2001	Close failed
3001	Reposition input to 1st record for PUT
3002	PUT failed
3003	Error from input record exit
3004	Length error on PUT
3005	Insufficient space for data file
3006	PUT attempted on file that is not open
4001	File state incorrect for SEND
4002	SEND failed
4003	Deallocation failed
4004	PUT Queue error

Figure 41. NPF FSS writer return codes

List of common problems and suggested solutions

Table 14. List of common problems for general Network Print Facility processing

Problem	Explanation/Action
You are in a wait state.	Ensure TCPIPJOBNAME is defined.
You receive message CSV003I, Module EZAPPGPR not found.	Ignore the message. Anyone not specifying a general routing exit receives this message.

Table 15. List of common problems for processing JES output

Problem	Explanation/Action
<p>You receive a message regarding incorrect routing. It might be that a file is being sent back to the JES hold queue due to invalid routing information (nonexistent printer information, for example).</p>	<p>The file stays there until the user releases or reroutes it.</p> <p>Ensure the destination you specified in your JCL is the same as the destination value listed in the SDSF output display panel. If you are running JES2 Version 3, the destination name must be equal to the host name. If it is not the same, use what is listed in the SDSF output display panel as the destination for your routing file. What is displayed on the SDSF output display panel for class, destination, and forms is what JES is passing to the NPF FSS writer. Refer <i>JES2 Commands</i> or <i>JES3 Commands</i> for details about how to release held jobs from the JES queue.</p>
<p>The NPF FSS writer issues a user abend due to an unrecoverable JES error condition (not being able to connect to the Network Print Facility, for example).</p>	<p>The file is held on the JES queue until the user releases or reroutes it.</p> <p>All terminating errors caused by the NPF FSS writer interface to or from Network Print Facility routines generate a USER777 abend code. The writer error routine takes a snapshot of the storage before the NPF FSS writer terminates. When the error condition is fixed, the NPF FSS writer can be restarted.</p> <p>In case of invalid routing information (nonexistent printer information, for example), the Network Print Facility issues message EZY0912I indicating that the file is being sent back to the JES queue to be held. See <i>JES2 Commands</i> or <i>JES3 Commands</i> for details about how to release held jobs from the JES queue.</p>

Network Print Facility tracing

You can run traces of ISPF function using the options available on the NPF ISPF Primary Option Menu or you can run a trace of the queue management function through the use of an operator command.

Using the NPF ISPF trace facility

The Network Print Facility ISPF trace is useful for internal debugging only. Using this trace without the support of IBM service personnel might not be productive. You can use the NPF ISPF trace to trace an ISPF function (add or delete, for example). Information captured can then be displayed in a data set for evaluation and problem resolution.

Procedure

Follow these steps to implement the NPF ISPF trace:

1. Optional: Create the sequential data set you want to use for tracing with these specifications: sequential organization (PS), a variable block format (VB), a logical record length (LRECL) of 132, and any block size (BLKSIZE).
2. On the NPF Diagnosis Functions panel (EZAPPDGP), specify this data set or enter a data set name that begins with your TSO user ID and the system will allocate one for you. (See Figure 15 on page 79.)
3. On the same panel, enter a 2 to turn tracing on.

4. After the operation is complete, return to the NPF Diagnosis Functions panel enter a **1** to turn tracing off.
5. IBM service personnel will inspect the trace data set. Information will be available on data input to the operation and data output to the operation. Evaluate the data to ensure the names match, and appropriate fields are filled-in.

Results

Note: The trace facility is used only to trace the path of input to and output from NPF ISPF panels. It is not intended to be used to trace an abend. For example, if the TRACE is on and an abend occurs, you might not get complete data.

Using the queue manager trace

The operator can specify a trace of the queue management function by issuing the following commands:

```
R xx,TRACE           to turn on console trace
R xx,NOTRACE        to turn off console trace
```

The queue manager writes a message to the console for each file action, including retry attempts or file deletions. See the explanation of message EZY0960I in the z/OS Communications Server: IP Messages Volume 3 (EZY) manual. This message describes the routing, name of file, type of operation, and time. The time displayed is the time the scan started, not the time the actual operation occurs.

The trace output goes to the MVS console and the normal job log specified in the NPF start procedures (either NPF FSS writer (for JES) or VTAM).

Using the VTAM capture point trace

The operator can specify a debugging trace of the VTAM capture point by issuing the following commands in reply to the EZY0837I message (WTOR):

```
R xx,TRACE           to turn on console trace
R xx,NOTRACE        to turn off console trace
```

The trace entries are "programmer information" type WTOs with ROUTCDE=(11). They go to the JES message log for the VTAM capture point job and to the SYSLOG, but they are not displayed on the main operator console unless it has been configured to accept ROUTCDE(11) messages.

Additionally, if an EZAPPSNP DD is provided in the startup procedure for EZAPPAAA, then additional debugging information will be written to that DD. The EZAPPSNP DD is similar to the EZAPPLOG DD and can be SYSOUT=* or a sequential data set(PS) with RECFM=FBA, LRECL=133, and BLKSIZE=1330. If a sequential data set is used, be sure to provide enough space.

Network Print Facility logging

The Network Print Facility has a logging facility that writes messages in a log file to track the system activity regarding temporary print data sets. The messages (EZY0970I, EZY0971I, EZY0972E, EZY0973I) record when a print data set is placed on the queue, successfully or unsuccessfully transmitted, and deleted.

For logging, create a QSAM data set with VBA or FBA format, a logical record length (LRECL) of 133, and any blocksize.

The log file is specified with the //EZAPPLOG DD statement in the JCL to start the capture point applications and queue manager. The log file cannot be shared. Therefore, you must have a unique log file for each startup procedure for these programs. If the //EZAPPLOG statement is missing, the system will not log this activity.

Generation of the print data set names

Network Print Facility's queue file manager creates a name for each data set it tracks. The Network Print Facility derives the names for the temporary print data sets as follows:

- The name is divided into 4 sections:
 - High-level qualifier
 - Major Key (JES DEST or SLU name)
 - Minor Key (JES job name or VTAM PLU)
 - Date and time
- NPF obtains the high-level qualifier from an NPFPRINTPREFIX configuration statement, if one is specified. If not, NPF uses the TCP/IP high-level qualifier.
- NPF strips the major key of any trailing blanks.
- NPF strips the minor key of any trailing blanks.
- NPF derives the date and time as follows:
 - Calculates the modulo 25 value for the year, expressed as a letter A=0, B=1,.....,Y=24.
 - Expresses the julian day as a 3-digit number.
 - Expresses the hour in base25 using letters as in the year.
 - Expresses the minute as a 2-digit number.
 - Inserts a period because this makes up 7 characters.
 - Expresses the seconds and tenths of seconds as a 2-digit base 25 number using letters as above. Thus the date and time is YdddHmm.SS where the upper case letters represent the modulo/base 25 letters and the lower case letters represent numbers,
- NPF starts the name with the complete high-level qualifier.
- NPF ends the name with the complete date.
- NPF merges the lengths of the major and minor keys into one string if the sum is ≤ 8 . Otherwise, NPF uses them as two strings separated by a period.
- If necessary, NPF truncates the major/minor keys from the right to fit within the 44-character limit required by MVS. If the length of the high-level qualifier is 14 or less, no truncation occurs.

SNA sense codes used by the NPF VTAM capture point

An error on an input request is indicated by the return of either a negative response or (for BIND only) an UNBIND request. In either case, the error indication includes a sense code.

Sense codes used by the NPF VTAM application program fall into two categories:

- General-use sense codes already described in *SNA - Sessions Between Logical Units*. These are not discussed here.
- Implementation-specific sense codes, which are not described in standard SNA documentation. These sense codes and their meanings are described in the tables that follow.

Appendix A. Checklists for using the Network Print Facility

Use the 3 checklists provided here to plan for, customize, and use the Network Print Facility.

Checklist of the NPF tasks for all users (JES or VTAM)

- Decide how many logical printers you will use.
- Decide how you can effectively implement the routes you require. Should jobs be sent to one printer or to multiple homogeneous printers?
- Decide how you will use the LPR print options. Which will be the system default options and which will be specified in your options file? Plan to use the OPTIONS function of the NPF EZAPPFL macro or the NPF ISPF interface to create the options records.

See the z/OS Communications Server: IP User's Guide and Commands for a complete description of LPR options.
- Establish your own job header and trailer through LPR definitions; NPF does not provide job header and trailer options itself. If desired, use the IBM-supplied separator or banner defaults, provided with LPR. See the LPR documentation in the z/OS Communications Server: IP User's Guide and Commands.
- Decide on unique major and minor names for your print routings. Plan to use the ROUTING function of the NPF EZAPPFL macro or the NPF ISPF interface to create the routing records.
- Define the queue management function.
 - Decide how to handle output that *does* print successfully. Do you want to delete the job immediately? Do you want to retain the job for a period of time for future use? Plan to use the RETAINS option on the ROUTING function of the NPF EZAPPFL macro or the ISPF panel interface to specify your choices.
 - Decide how to handle output that *does not* print successfully. Do you want to delete the job immediately? Do you want to retain the job for a period of time for future use? Do you want to resend the data? If so, how many times do you want to attempt to resend? At what interval? Plan to use the RETAINU and RETRY options on the ROUTING function of the NPF EZAPPFL macro or the ISPF interface to specify your choices.
- Determine if user exits are necessary. If so, design, code, and install them. Plan to specify them appropriately in the macros, data areas, parameter lists, and in the routing and options records.

See Chapter 7, "Writing exit routines to tailor the Network Print Facility," on page 105.
- Install the C run-time libraries to implement the ISPF interface. This will require a re-IPL to make the change permanent.
- Configure your system for NPF by using the appropriate configuration statements.

See "Configuring NPF using TCPIP.DATA and NPF.DATA statements" on page 16.
- Assign appropriate user authorization. This might relate to the alteration of your ISPF logon procedure to enable NPF.

See the appropriate RACF manual or other security program publication.
- Enable the NPF ISPF interface.

- Provide library access
- Update the ISPF primary menu to include an option to access NPF.
- Establish optional default values for the routing, options, queue, and trace files to display on the interface panels.

See “Enabling the Network Print Facility ISPF interface” on page 69.

- Modify the program properties table with the JES PPT entry or the VTAM PPT entry or both (see the checklist specific to JES or VTAM for the exact update). Modifying the PPT requires a re-IPL.

See the z/OS MVS Initialization and Tuning Guide for information about updating the PPT.

- Define the JES capture point (NPF FSS writers) or VTAM capture point (applications), or both. See the Checklist for JES users, or the Checklist for VTAM users, on the following pages.
 - Allocate and initialize the VSAM files for routing, option, and queue files. See Chapter 5, “Creating the Network Print Facility files,” on page 51.
 - Load the routing and options file records using the various NPF EZAPPFL macro functions. See Chapter 5, “Creating the Network Print Facility files,” on page 51.
 - For each different VTAM capture point, JES capture point, or queue manager application, allocate a QSAM data set for the LOG file. See “Network Print Facility logging” on page 145.
 - Start either the NPF FSS writer to process output from JES or the VTAM capture point to process output from VTAM, or both. Start the NPF queue manager to handle the retention and retransmission of print data sets. These require you to submit the JCL start procedures for each. See Chapter 8, “Operating the Network Print Facility,” on page 125
 - Maintain your files by changing print options, routing destinations, and data fields that affect the disposition of print data sets. Use either the ISPF panel interface or the EZAPPFL macro. See Chapter 5, “Creating the Network Print Facility files,” on page 51 and Chapter 6, “Maintaining the Network Print Facility files with ISPF,” on page 69.
- Note:** Using the EZAPPFL macro updates the VSAM files in batch mode while ISPF performs the same function interactively. When large numbers of updates are required, using the EZAPPFL macro might be more efficient.
- If a problem is encountered using the NPF panel interface, use the NPF ISPF trace to find inconsistencies in panel input and output. See “Using the NPF ISPF trace facility” on page 144.

Checklist of the NPF tasks for VTAM users

- Establish consistent definition of resources.
 - Set up an APPL definition for each logical printer name. Define each of the logical printer (SLU) names to VTAM by an APPL definition statement in an application major node definition. See the z/OS Communications Server: SNA Resource Definition Reference.
 - In the partner LU, set up definitions for each logical printer (SLU) name. For CICS, a specific requirement is that you specify NO for the QUERY keyword on the TYPETERM macro. See IMS or CICS publications relating to resource definition.

- Build the routing file to make the connection between the logical printer names and the LUCLASS numbers. See “Routing file input fields” on page 46.
- Run nonswappable. Add a Network Print Facility entry for the VTAM application, EZAPPAAA, in the MVS program properties table (PPT). The EZAPPAAA entry must be specified as: PPT PGMNAME(EZAPPAAA)

Note: PPT entries in the SCHED xx member of SYS1.PARMLIB are no longer required. They are supplied in the default PPT table via load module IEFSDPPT.

- Estimate the appropriate region size for the job to start the Network Print Facility. The size depends on the maximum number of output files in progress at any given time, the number of logical printers, and the number of sessions.
- Set up the JCL to run the Network Print Facility for the VTAM capture point. There are four major types of information that this JCL must specify:
 1. On the EXEC statement, code PGM=EZAPPAAA to identify the program to be started.
 2. Also on the EXEC statement, code the PARM parameter with the LUCLASS subparameter to specify one or more LU class numbers with values from 1 to 64 and the REGION and MAXFLSTG parameters to accommodate your below-the-line storage estimates.
 3. Code DD statements for the routing, options, queue, and log files. The ddnames must be coded exactly as shown in the VTAM start sample. The system administrator can choose the data set names.
 4. On the JOB statement, code TIME=1440 or TIME=NOLIMIT to prevent MVS from terminating the application because of its running time.
See “Starting the NPF VTAM capture point” on page 131.
- For end-of-file processing:
 1. Evaluate if IBM's default end-of-file rule is sufficient for your installation. See “Defining end-of-file rules” on page 30.
 2. If necessary, use the EZAPPEFM macro to modify the end-of-file rules table (EZAPPEFT), assemble and link-edit it into a STEPLIB available to the NPF VTAM application or the link list. See “Defining end-of-file rules” on page 30.
 3. Specify the optional end-of-file rules table entry name in the SLU's routing file record. Several SLUs can share the same table entry. The Network Print Facility uses DFLTENTRY if you do not specify an entry name. See “EZAPPFL TYPE=ROUTING” on page 54.
- For page format processing:
 1. Evaluate if IBM's default page format is sufficient for your installation. See “EZAPPDPF” on page 38.
 2. If necessary, use the EZAPPDPF macro to create the page format table (EZAPPPFT), assemble and link-edit it into a STEPLIB available to the NPF VTAM application. See “EZAPPDPF” on page 38.
 3. Specify the optional page format table entry name in SLU's the routing file record. Several SLUs can share the same default page format. The Network Print Facility does not require any specification. See “EZAPPFL TYPE=ROUTING” on page 54.
 4. Dynamically replace the page format table, using the RELOAD command.
See “RELOAD: Dynamically replacing a table” on page 135.
- Start the VTAM capture point. See “Starting the NPF VTAM capture point” on page 131.

- Tune the VTAM capture point application by adjusting the limits you specify in the start procedure. See the **Tuning note** in “Creating a startup procedure” on page 25.

Checklist of the NPF tasks for JES users

- Decide how many NPF FSS writers or how many FSA subtasks you will use. See *z/OS MVS Using the Functional Subsystem Interface*.
- Determine where to print JES output. See the *z/OS MVS JCL Reference*.
- Decide how you can most effectively use the JCL CLASS parameter. If necessary, decide what selection criteria you will use in addition to CLASS to send output to an NPF FSS writer. See *z/OS JES2 Commands* or *z/OS JES3 Commands* for examples of the \$T command, or see “Determining where to print JES output” on page 23 in this book.
- Evaluate JESNEWS affect on the Network Print Facility. See *z/OS JES3 Commands* or *z/OS JES2 Initialization and Tuning Guide*, or see “Customizing JESNEWS” on page 23 in this manual.
- Authorize the NPF FSS writer load module. For JES2, place EZAPPFSS in the MVS program properties table (PPT) (with key=1) to ensure subpools 0–127 are in key 1. The EZAPPFSS entry must be specified as follows:

```
PPT  PGMNAME(EZAPPFSS)  KEY(1)
```

Note: PPT entries in the SCHEDxx member of SYS1.PARMLIB are no longer required. They are supplied in the default PPT table via load module IEFSDPPT.
- JES3 users should have APAR OY50274 applied in order for Network Print Facility to make use of field JSPJGRPD, which contains the DEST (destination) value. See the *z/OS Communications Server: New Function Summary*.
- Accommodate NPF's maximum 8-character restriction for destination names. See Note.
- If you are running JES2 Version 3, ensure the destination name is the same as the TCP/IP or MVS host name.
- Ensure your own changes made to the job separator page area (IAZJSPA) (such as DEST, CLASS, FORMS, job name, and user ID) and extension areas (or changes made in JES2 exit 23 or JES3 exit 45, for examples) are compatible with the NPF FSS writer. (The NPF FSS writer uses some of these fields.)
- Set up the NPF FSS writers you need using JES FSSDEF initialization statements. This includes tailoring the NPF FSS writer to your installation needs. See “Defining the NPF FSS writer” on page 23.
- Set up the JCL to start the NPF FSS writer, and start it. See “Creating the NPF FSS writer start procedure” on page 126.

Appendix B. Network Print Facility's Routing Data Area (RDA)

The routing data is a combination of data from the routing and options files and is accessible to all three exits. If the general routing exit builds the routing data area, it should initialize all fields. Fields that can be modified by either the specific routing exit or the input record exit are marked.

Field Name

Field Description

RTDAMAJK

An 8-byte character field containing the major name for this routing. For JES, this corresponds to the CLASS parameter in the JCL. For VTAM, this corresponds to the LU Name.

This field should not be modified.

RTDAMINK

An 8-byte character field containing the minor name for this routing. For JES, this corresponds to the DEST parameter in the JCL. For VTAM, this must contain nonblanks.

This field should not be modified.

RTDASREX

An 8-byte character field containing the name of the specific routing exit, if one was specified. If not, this field contains binary zeros.

This field should not be modified.

RTDAIREX

An 8-byte character field containing the name of the input record exit if one was specified. If not, this field contains binary zeros.

This field should not be modified.

RTDARTRS

A fullword binary field which gives the period of time the system should retain data for this routing after a successful transmission to LPR. This field has the format *dddhhmm*, where:

ddd The number of days to retain the file after successful transmission to LPR.

hh The number of hours to retain the file after successful transmission to LPR.

mm The number of minutes to retain the file after successful transmission to LPR.

The total time to retain the file is the sum of the days, hours and minutes.

This field can be modified by either exit.

RTDARTRU

A fullword binary field which gives the period of time the system should retain data for this routing after an attempting the specified number of retries without success. This field has the format *dddhhmm*, where:

ddd The number of days to retain the file after an unsuccessful transmission to LPR.

- hh** The number of hours to retain the file after an unsuccessful transmission to LPR.
- mm** The number of minutes to retain the file after an unsuccessful transmission to LPR.

The total time to retain the file is the sum of the days, hours and minutes. This field can be modified by either exit.

RTDARTRR

A fullword binary field which gives the period of time the system should wait before attempting a retry on this routing after an unsuccessful attempt to transmit to LPR. This field has the format *dddhhmm*, where:

- ddd** The number of days to wait before a retry of an unsuccessful transmission to LPR.
- hh** The number of hours to wait before a retry of an unsuccessful transmission to LPR.
- mm** The number of minutes to wait before a retry of an unsuccessful transmission to LPR.

The total time to wait before a retry of an unsuccessful transmission to LPR is the sum of the days, hours and minutes.

This field can be modified by either exit.

RTDADEST

A halfword binary number containing the number of destinations described by this routing record. The default is 1 (normal routing). A number greater than 1 means this record represents a specific broadcast.

This field can be modified but caution is advised. The system has no way to determine if it is consistent with the number of destinations described in RTDANAMS.

RTDARTRL

A halfword binary field which specifies the number of retry attempts to be made on this routing. If the file is not successfully transmitted by LPR within this number of retries, it changes to retain status.

This field can be modified by either exit.

RTDATYPE

A 1-byte character field containing the value 'N'. This record represents one or more destinations which have the same characteristics. It might be followed by additional records describing other destinations for the same routing. If the field NO_OF_DEST is 1, the record represents a normal routing. If the field NO_OF_DEST is greater than 1, the record represents a specific broadcast.

This field can be modified but caution is advised. The system has no way to determine if it is consistent with the number of destinations described in RTDANAMS.

RTRECTYP/RTDARTYP

A 3-byte character field containing the record type.

This field can be modified by the specific routing exit or the input record exit at OPEN time.

RTFUNCTN/RTDAFUNC

An 8-byte character field containing the function. This can be one of four conditions affecting the input record exit (open, put, close, and term-release.)

RTLRECL/RTDARECL

A fullword binary field specifying the logical record length for the print file

This field can be modified by the specific routing exit or the input record exit at OPEN time.

RTBLKSZ/RTDABLKS

A fullword binary field specifying the block size for the print file.

This field can be modified by the specific routing exit or the input record exit at OPEN time.

RTBUFSZ/RTDABUFS

A fullword binary field specifying the buffer size for the print file.

This field can be modified by the specific routing exit or the input record exit at OPEN time.

RTDAOPTN

A 16-byte character field containing the name of the Options record for this print job.

This field should not be modified.

RTDAOPTL

A halfword binary field containing the length of the options data used for this routing. This length must be 255 or less.

This field can be modified by either exit.

RTDAOPTD

A 256-byte character field containing up to 255 bytes of option data for this print job (the right-most byte of this field is ignored). They correspond to the options used for LPR. See the file description section for values.

This field can be modified by either exit.

RTDANAMS

A variable area containing a destination data area for each destination. The format of the destination data areas is as follows:

Field Name**Field Description****RTDANAML**

A 2-byte binary field specifying the length of INET_NAME

RTDAPRTL

A 2-byte binary field specifying the length of PRT_NAME

RTDAINAM

A variable length character field up to 255 characters in length specifying the internet name or address of the destination host for the first or only destination. This field is case-sensitive.

RTDAPNAM

A variable length character field up to 255 characters in length specifying the name of the printer to be used at the remote host for the first or only destination. This field is case-sensitive.

These fields might be modified by either exit. Care should be taken to make sure that the resulting modifications are consistent. Also, if the routing data area was built by NPF, there will be no additional storage at the end for additions.

DSECT for routing data area

The DSECT for the routing data area is generated using the EZAPPFCD TYPE=DSECT macro.

```

*-----*
*           DSECT for Routing Data Area           *
*-----*
RTDATA  DSECT           DSECT to Describe Routing Data
RTDAMAJK DS   CL8       Major Route Key                X
                                JES - Class of Output      X
                                VTAM - LU Name
RTDAMINK DS   CL8       Minor Route Key                X
                                JES - Destination of Output  X
                                VTAM - nonblank
RTDASREX DS   CL8       Name of specific routing exit
RTDAIREX DS   CL8       Name of input record exit
RTDARTRS DS   F         Success retain time in YDDHHMM
RTDARTRU DS   F         Failure retain time in YDDHHMM
RTDARTRR DS   F         Retry time in YDDHHMM
RTDADEST DS   H         Number of destinations          X
                                One destination = normal routing
RTDARTRL DS   H         Number of Retry Attempts
RTDATYPE DS   CL1       Route Type
RTDATYPN EQU  C'N'     Normal Routing
RTDATYPS EQU  C'S'     Specific Broadcast
RTRECTYP DS   CL3       Record type for print file
RTFUNCTN DS   CL8       The function in progress
RTLRECL DS   F         Logical record length for print file
RTBLKSZ DS   F         Block size for print file
RTBUFSZ DS   F         Size of I/O buffer
RTDAOPTN DS   CL16      Name of options record for this route
RTDAOPTL DS   H         Length of the options data
RTDAOPTD DS   CL256     Options data for this route
RTDANAMS DS   0H       Beginning of names
RTDADESD DSECT         DSECT for names - This DSECT will be X
                                repeated for each destination X
                                supported in this route = RTDADEST
RTDANAML DS   H         Length of internet name for this X
                                destination
RTDAPRTL DS   H         Length of printer name for this X
                                destination
RTDAINAM DS   CL256     Internet name for this destination
RTDAPNAM DS   CL256     Printer name for this destination
RTDAESE EQU   *
RTDAESL EQU   RTDAESE-RTDAESD

```

Figure 42. DSECT for routing data area

Appendix C. Sample NPF FSS writer definitions

```
*****
* The following samples show a breakdown of the FSSDEF definition
* statement and PRINTER definition statement required to be placed
* in the JES initialization job.
* The samples are NOT executable code but rather a grouping of the
* definitions for the following JES versions:
*
*           JES2 V4 or V5
*           JES3 V4
*
*****
*           WARNING : This sample is NOT executable code.
*****
*           COPYRIGHT = NONE.
*****
```

Definitions for JES2 Version 4 and Version 5 are the same for FSS and PRT for the purposes of these examples.

```
*****
*           *
*   JES2 V4 or V5   *
*           *
*****

*****
*           FSS WRITER DEFINITIONS           *
*           *
*   TCPFSS IS FOR PRINTER 5 AND PRINTER 6   *
*   TCPFS1 IS FOR PRINTER 7                 *
*****
FSSDEF(TCPFSS) PROC=FSWTR,HASPFSSM=HASPFSSM,AUTOSTOP=YES
FSSDEF(TCPFS1) PROC=FSWTR,HASPFSSM=HASPFSSM,AUTOSTOP=YES

*****
*           FSS PRINTER DEFINITIONS         *
*****
PRT5  MODE=FSS,FSS=TCPFSS,DRAIN,CLASS=C
PRT6  MODE=FSS,FSS=TCPFSS,DRAIN,CLASS=D
PRT7  MODE=FSS,FSS=TCPFS1,DRAIN,CLASS=E
```

Figure 43. FSS writer definition sample for JES2 version 4 and 5

```

*****
*   JES3 V4   *
*****

*****
*           FSS WRITER DEFINITIONS           *
*           WITH PRINTER (DEVICE)           *
*           DEFINITIONS FOLLOWING           *
*                                           *
* FSSPRT1 IS FOR PRINTER 501               *
* FSSPRT2 IS FOR PRINTER 502               *
* FSSPRT3 IS FOR PRINTER 503               *
* FSSPRT4 IS FOR PRINTER 504               *
*****

FSSDEF,TYPE=WTR,FSSNAME=FSSPRT1,MSGDEST=JES,      X
      PNAME=FSWTR,SYSTEM=MVS3,TERM=YES
DEVICE,DTYPE=PRT3820,JNAME=PRT501,MODE=FSS,      X
      FSSNAME=FSSPRT1,JUNIT=(,MVS3,S1,ON),SETUPMSG=NO
FSSDEF,TYPE=WTR,FSSNAME=FSSPRT2,MSGDEST=JES,      X
      PNAME=FSWTR,SYSTEM=MVS3,TERM=YES
DEVICE,DTYPE=PRT3820,JNAME=PRT502,MODE=FSS,      X
      FSSNAME=FSSPRT2,JUNIT=(,MVS3,S1,ON),SETUPMSG=NO
FSSDEF,TYPE=WTR,FSSNAME=FSSPRT3,MSGDEST=JES,      X
      PNAME=FSWTR,SYSTEM=MVS3,TERM=YES
DEVICE,DTYPE=PRT3820,JNAME=PRT503,MODE=FSS,      X
      FSSNAME=FSSPRT3,JUNIT=(,MVS3,S1,ON),SETUPMSG=NO
FSSDEF,TYPE=WTR,FSSNAME=FSSPRT4,MSGDEST=JES,      X
      PNAME=FSWTR,SYSTEM=MVS3,TERM=YES
DEVICE,DTYPE=PRT3820,JNAME=PRT504,MODE=FSS,      X
      FSSNAME=FSSPRT4,JUNIT=(,MVS3,S1,ON),SETUPMSG=NO

```

Figure 44. FSS writer definition sample for JES3 version 4

Appendix D. The SCS printer emulator

The SCS (LU type 1) printer emulator transforms the SNA Character Stream into a VBA (variable blocked with ASA carriage control) data set. The following table describes the code points that are undefined, unsupported, supported with defaults or fully supported. Undefined and unsupported code points are rejected with an SNA sense code of function error (X'10030000'). Supported code points with invalid parameters or without all parameters available in the same chain are rejected with an SNA sense code of parameter error (X'10050000').

Table 16. SCS code points

	x0	x1	x2	x3	x4	x5	x6	x7	x8	x9	xA	xB	xC	xD	xE	xF
0x	Null	(1)	(1)	(1)	SEL (9)	HT	RNL (4)	(1)	GE (2)	SPS (3)	RPT (3)	VT	FF	CR	SO	SI
1x	(1)	DC1 (3)	DC2 (3)	DC3 (3)	ENP (3)	NL	BS	POC (3)	(1)	(1)	UBS (3)	CU1 (3)	IFS (4)	IGS (4)	IRS (4)	IUS (7)
2x	(1)	(1)	(1)	WUS	INP (3)	LF	(1)	(1)	SA (2)	(1)	SW (3)	CSP (10)	(1)	(1)	(1)	BEL (3)
3x	(1)	(1)	SYN (3)	IR (4)	PP	TRN (2)	EBS (6)	(1)	SBS (3)	IT (3)	RFF (5)	CU3 (3)	DC4 (3)	(1)	(1)	SUB
4x		RSP (7)														
5x																
6x																
7x																
8x																
9x																
Ax																
Bx																
Cx											SHY (8)					
Dx																

Table 16. SCS code points (continued)

	x0	x1	x2	x3	x4	x5	x6	x7	x8	x9	xA	xB	xC	xD	xE	xF
Ex		ESP (7)														
Fx																

Notes on the table:

1. Undefined code point - function error.
2. Unsupported code point - function error.
3. Defaults to no operation - function ignored.
4. Defaults to new line (NL).
5. Defaults to form feed (FF).
6. Defaults to backspace (BS).
7. Defaults to space (X'40').
8. Defaults to dash (X'60').
9. Vertical channel select is supported. Select left/right platten is ignored. Select magnetic stripe reader/writer is unsupported.
10. Set Horizontal Format and Set Vertical Format are supported. Start of Format is ignored if at left margin, defaults to new line (NL) if not at left margin. Set Line Density, Set Graphic Escape Action, Set Chain Image and Set Print Density are ignored.

Double byte character strings (DBCS) begin with the shift_out (SO) code point and end with the shift_in (SI) code point. Valid characters between the SI and SO are X'4040' and any pair of bytes each in the range X'41' to X'FE'. Illegal characters found in a double byte character string or double byte character strings that do not complete in the same chain are rejected with an SNA sense code of data error (X'10010000').

All unspecified code points are passed to LPR as EBCDIC data. See the z/OS Communications Server: IP User's Guide and Commands to determine the EBCDIC-to-ASCII translation performed by LPR. See *SNA - Sessions Between Logical Units* for more information about SCS data streams.

Appendix E. Related protocol specifications

This appendix lists the related protocol specifications (RFCs) for TCP/IP. The Internet Protocol suite is still evolving through requests for comments (RFC). New protocols are being designed and implemented by researchers and are brought to the attention of the Internet community in the form of RFCs. Some of these protocols are so useful that they become recommended protocols. That is, all future implementations for TCP/IP are recommended to implement these particular functions or protocols. These become the *de facto* standards, on which the TCP/IP protocol suite is built.

You can request RFCs through electronic mail, from the automated Network Information Center (NIC) mail server, by sending a message to `service@nic.ddn.mil` with a subject line of RFC *nnnn* for text versions or a subject line of RFC *nnnn*.PS for PostScript versions. To request a copy of the RFC index, send a message with a subject line of RFC INDEX.

For more information, contact `nic@nic.ddn.mil` or at:

Government Systems, Inc.
Attn: Network Information Center
14200 Park Meadow Drive
Suite 200
Chantilly, VA 22021

Hard copies of all RFCs are available from the NIC, either individually or by subscription. Online copies are available at the following Web address:
<http://www.rfc-editor.org/rfc.html>.

Draft RFCs that have been implemented in this and previous Communications Server releases are listed at the end of this topic.

Many features of TCP/IP Services are based on the following RFCs:

RFC Title and Author

RFC 652

Telnet output carriage-return disposition option D. Crocker

RFC 653

Telnet output horizontal tabstops option D. Crocker

RFC 654

Telnet output horizontal tab disposition option D. Crocker

RFC 655

Telnet output formfeed disposition option D. Crocker

RFC 657

Telnet output vertical tab disposition option D. Crocker

RFC 658

Telnet output linefeed disposition D. Crocker

RFC 698

Telnet extended ASCII option T. Mock

- RFC 726**
Remote Controlled Transmission and Echoing Telnet option J. Postel, D. Crocker
- RFC 727**
Telnet logout option M.R. Crispin
- RFC 732**
Telnet Data Entry Terminal option J.D. Day
- RFC 733**
Standard for the format of ARPA network text messages D. Crocker, J. Vittal, K.T. Pogran, D.A. Henderson
- RFC 734**
SUPDUP Protocol M.R. Crispin
- RFC 735**
Revised Telnet byte macro option D. Crocker, R.H. Gumpertz
- RFC 736**
Telnet SUPDUP option M.R. Crispin
- RFC 749**
Telnet SUPDUP—Output option B. Greenberg
- RFC 765**
File Transfer Protocol specification J. Postel
- RFC 768**
User Datagram Protocol J. Postel
- RFC 779**
Telnet send-location option E. Killian
- RFC 783**
TFTP Protocol (revision 2) K.R. Sollins
- RFC 791**
Internet Protocol J. Postel
- RFC 792**
Internet Control Message Protocol J. Postel
- RFC 793**
Transmission Control Protocol J. Postel
- RFC 820**
Assigned numbers J. Postel
- RFC 821**
Simple Mail Transfer Protocol J. Postel
- RFC 822**
Standard for the format of ARPA Internet text messages D. Crocker
- RFC 823**
DARPA Internet gateway R. Hinden, A. Sheltzer
- RFC 826**
Ethernet Address Resolution Protocol: Or converting network protocol addresses to 48.bit Ethernet address for transmission on Ethernet hardware D. Plummer
- RFC 854**
Telnet Protocol Specification J. Postel, J. Reynolds

- RFC 855**
Telnet Option Specification J. Postel, J. Reynolds
- RFC 856**
Telnet Binary Transmission J. Postel, J. Reynolds
- RFC 857**
Telnet Echo Option J. Postel, J. Reynolds
- RFC 858**
Telnet Suppress Go Ahead Option J. Postel, J. Reynolds
- RFC 859**
Telnet Status Option J. Postel, J. Reynolds
- RFC 860**
Telnet Timing Mark Option J. Postel, J. Reynolds
- RFC 861**
Telnet Extended Options: List Option J. Postel, J. Reynolds
- RFC 862**
Echo Protocol J. Postel
- RFC 863**
Discard Protocol J. Postel
- RFC 864**
Character Generator Protocol J. Postel
- RFC 865**
Quote of the Day Protocol J. Postel
- RFC 868**
Time Protocol J. Postel, K. Harrenstien
- RFC 877**
Standard for the transmission of IP datagrams over public data networks J.T. Korb
- RFC 883**
Domain names: Implementation specification P.V. Mockapetris
- RFC 884**
Telnet terminal type option M. Solomon, E. Wimmers
- RFC 885**
Telnet end of record option J. Postel
- RFC 894**
Standard for the transmission of IP datagrams over Ethernet networks C. Hornig
- RFC 896**
Congestion control in IP/TCP internetworks J. Nagle
- RFC 903**
Reverse Address Resolution Protocol R. Finlayson, T. Mann, J. Mogul, M. Theimer
- RFC 904**
Exterior Gateway Protocol formal specification D. Mills
- RFC 919**
Broadcasting Internet Datagrams J. Mogul

- RFC 922**
Broadcasting Internet datagrams in the presence of subnets J. Mogul
- RFC 927**
TACACS user identification Telnet option B.A. Anderson
- RFC 933**
Output marking Telnet option S. Silverman
- RFC 946**
Telnet terminal location number option R. Nedved
- RFC 950**
Internet Standard Subnetting Procedure J. Mogul, J. Postel
- RFC 952**
DoD Internet host table specification K. Harrenstien, M. Stahl, E. Feinler
- RFC 959**
File Transfer Protocol J. Postel, J.K. Reynolds
- RFC 961**
Official ARPA-Internet protocols J.K. Reynolds, J. Postel
- RFC 974**
Mail routing and the domain system C. Partridge
- RFC 1001**
Protocol standard for a NetBIOS service on a TCP/UDP transport: Concepts and methods NetBios Working Group in the Defense Advanced Research Projects Agency, Internet Activities Board, End-to-End Services Task Force
- RFC 1002**
Protocol Standard for a NetBIOS service on a TCP/UDP transport: Detailed specifications NetBios Working Group in the Defense Advanced Research Projects Agency, Internet Activities Board, End-to-End Services Task Force
- RFC 1006**
ISO transport services on top of the TCP: Version 3 M.T. Rose, D.E. Cass
- RFC 1009**
Requirements for Internet gateways R. Braden, J. Postel
- RFC 1011**
Official Internet protocols J. Reynolds, J. Postel
- RFC 1013**
X Window System Protocol, version 11: Alpha update April 1987 R. Scheifler
- RFC 1014**
XDR: External Data Representation standard Sun Microsystems
- RFC 1027**
Using ARP to implement transparent subnet gateways S. Carl-Mitchell, J. Quarterman
- RFC 1032**
Domain administrators guide M. Stahl
- RFC 1033**
Domain administrators operations guide M. Lottor
- RFC 1034**
Domain names—concepts and facilities P.V. Mockapetris

- RFC 1035**
Domain names—implementation and specification P.V. Mockapetris
- RFC 1038**
Draft revised IP security option M. St. Johns
- RFC 1041**
Telnet 3270 regime option Y. Rekhter
- RFC 1042**
Standard for the transmission of IP datagrams over IEEE 802 networks J. Postel,
J. Reynolds
- RFC 1043**
Telnet Data Entry Terminal option: DODIIS implementation A. Yasuda, T.
Thompson
- RFC 1044**
Internet Protocol on Network System's HYPERchannel: Protocol specification K.
Hardwick, J. Lekashman
- RFC 1053**
Telnet X.3 PAD option S. Levy, T. Jacobson
- RFC 1055**
Nonstandard for transmission of IP datagrams over serial lines: SLIP J. Romkey
- RFC 1057**
RPC: Remote Procedure Call Protocol Specification: Version 2 Sun Microsystems
- RFC 1058**
Routing Information Protocol C. Hedrick
- RFC 1060**
Assigned numbers J. Reynolds, J. Postel
- RFC 1067**
Simple Network Management Protocol J.D. Case, M. Fedor, M.L. Schoffstall, J.
Davin
- RFC 1071**
Computing the Internet checksum R.T. Braden, D.A. Borman, C. Partridge
- RFC 1072**
TCP extensions for long-delay paths V. Jacobson, R.T. Braden
- RFC 1073**
Telnet window size option D. Waitzman
- RFC 1079**
Telnet terminal speed option C. Hedrick
- RFC 1085**
ISO presentation services on top of TCP/IP based internets M.T. Rose
- RFC 1091**
Telnet terminal-type option J. VanBokkelen
- RFC 1094**
NFS: Network File System Protocol specification Sun Microsystems
- RFC 1096**
Telnet X display location option G. Marcy
- RFC 1101**
DNS encoding of network names and other types P. Mockapetris

- RFC 1112**
Host extensions for IP multicasting S.E. Deering
- RFC 1113**
Privacy enhancement for Internet electronic mail: Part I — message encipherment and authentication procedures J. Linn
- RFC 1118**
Hitchhikers Guide to the Internet E. Krol
- RFC 1122**
Requirements for Internet Hosts—Communication Layers R. Braden, Ed.
- RFC 1123**
Requirements for Internet Hosts—Application and Support R. Braden, Ed.
- RFC 1146**
TCP alternate checksum options J. Zweig, C. Partridge
- RFC 1155**
Structure and identification of management information for TCP/IP-based internets M. Rose, K. McCloghrie
- RFC 1156**
Management Information Base for network management of TCP/IP-based internets K. McCloghrie, M. Rose
- RFC 1157**
Simple Network Management Protocol (SNMP) J. Case, M. Fedor, M. Schoffstall, J. Davin
- RFC 1158**
Management Information Base for network management of TCP/IP-based internets: MIB-II M. Rose
- RFC 1166**
Internet numbers S. Kirkpatrick, M.K. Stahl, M. Recker
- RFC 1179**
Line printer daemon protocol L. McLaughlin
- RFC 1180**
TCP/IP tutorial T. Socolofsky, C. Kale
- RFC 1183**
New DNS RR Definitions C.F. Everhart, L.A. Mamakos, R. Ullmann, P.V. Mockapetris
- RFC 1184**
Telnet Linemode Option D. Borman
- RFC 1186**
MD4 Message Digest Algorithm R.L. Rivest
- RFC 1187**
Bulk Table Retrieval with the SNMP M. Rose, K. McCloghrie, J. Davin
- RFC 1188**
Proposed Standard for the Transmission of IP Datagrams over FDDI Networks D. Katz
- RFC 1190**
Experimental Internet Stream Protocol: Version 2 (ST-II) C. Topolcic

- RFC 1191**
Path MTU discovery J. Mogul, S. Deering
- RFC 1198**
FYI on the X window system R. Scheifler
- RFC 1207**
FYI on Questions and Answers: Answers to commonly asked "experienced Internet user" questions G. Malkin, A. Marine, J. Reynolds
- RFC 1208**
Glossary of networking terms O. Jacobsen, D. Lynch
- RFC 1213**
Management Information Base for Network Management of TCP/IP-based internets: MIB-II K. McCloghrie, M.T. Rose
- RFC 1215**
Convention for defining traps for use with the SNMP M. Rose
- RFC 1227**
SNMP MUX protocol and MIB M.T. Rose
- RFC 1228**
SNMP-DPI: Simple Network Management Protocol Distributed Program Interface
G. Carpenter, B. Wijnen
- RFC 1229**
Extensions to the generic-interface MIB K. McCloghrie
- RFC 1230**
IEEE 802.4 Token Bus MIB K. McCloghrie, R. Fox
- RFC 1231**
IEEE 802.5 Token Ring MIB K. McCloghrie, R. Fox, E. Decker
- RFC 1236**
IP to X.121 address mapping for DDN L. Morales, P. Hasse
- RFC 1256**
ICMP Router Discovery Messages S. Deering, Ed.
- RFC 1267**
Border Gateway Protocol 3 (BGP-3) K. Lougheed, Y. Rekhter
- RFC 1268**
Application of the Border Gateway Protocol in the Internet Y. Rekhter, P. Gross
- RFC 1269**
Definitions of Managed Objects for the Border Gateway Protocol: Version 3 S. Willis, J. Burruss
- RFC 1270**
SNMP Communications Services F. Kastenholz, ed.
- RFC 1285**
FDDI Management Information Base J. Case
- RFC 1315**
Management Information Base for Frame Relay DTEs C. Brown, F. Baker, C. Carvalho
- RFC 1321**
The MD5 Message-Digest Algorithm R. Rivest

- RFC 1323**
TCP Extensions for High Performance V. Jacobson, R. Braden, D. Borman
- RFC 1325**
FYI on Questions and Answers: Answers to Commonly Asked "New Internet User" Questions G. Malkin, A. Marine
- RFC 1327**
Mapping between X.400 (1988)/ISO 10021 and RFC 822 S. Hardcastle-Kille
- RFC 1340**
Assigned Numbers J. Reynolds, J. Postel
- RFC 1344**
Implications of MIME for Internet Mail Gateways N. Bornstein
- RFC 1349**
Type of Service in the Internet Protocol Suite P. Almquist
- RFC 1350**
The TFTP Protocol (Revision 2) K.R. Sollins
- RFC 1351**
SNMP Administrative Model J. Davin, J. Galvin, K. McCloghrie
- RFC 1352**
SNMP Security Protocols J. Galvin, K. McCloghrie, J. Davin
- RFC 1353**
Definitions of Managed Objects for Administration of SNMP Parties K. McCloghrie, J. Davin, J. Galvin
- RFC 1354**
IP Forwarding Table MIB F. Baker
- RFC 1356**
Multiprotocol Interconnect on X.25 and ISDN in the Packet Mode A. Malis, D. Robinson, R. Ullmann
- RFC 1358**
Charter of the Internet Architecture Board (IAB) L. Chapin
- RFC 1363**
A Proposed Flow Specification C. Partridge
- RFC 1368**
Definition of Managed Objects for IEEE 802.3 Repeater Devices D. McMaster, K. McCloghrie
- RFC 1372**
Telnet Remote Flow Control Option C. L. Hedrick, D. Borman
- RFC 1374**
IP and ARP on HIPPI J. Renwick, A. Nicholson
- RFC 1381**
SNMP MIB Extension for X.25 LAPB D. Throop, F. Baker
- RFC 1382**
SNMP MIB Extension for the X.25 Packet Layer D. Throop
- RFC 1387**
RIP Version 2 Protocol Analysis G. Malkin
- RFC 1388**
RIP Version 2 Carrying Additional Information G. Malkin

- RFC 1389**
RIP Version 2 MIB Extensions G. Malkin, F. Baker
- RFC 1390**
Transmission of IP and ARP over FDDI Networks D. Katz
- RFC 1393**
Traceroute Using an IP Option G. Malkin
- RFC 1398**
Definitions of Managed Objects for the Ethernet-Like Interface Types F. Kastenholz
- RFC 1408**
Telnet Environment Option D. Borman, Ed.
- RFC 1413**
Identification Protocol M. St. Johns
- RFC 1416**
Telnet Authentication Option D. Borman, ed.
- RFC 1420**
SNMP over IPX S. Bostock
- RFC 1428**
Transition of Internet Mail from Just-Send-8 to 8bit-SMTP/MIME G. Vaudreuil
- RFC 1442**
Structure of Management Information for version 2 of the Simple Network Management Protocol (SNMPv2) J. Case, K. McCloghrie, M. Rose, S. Waldbusser
- RFC 1443**
Textual Conventions for version 2 of the Simple Network Management Protocol (SNMPv2) J. Case, K. McCloghrie, M. Rose, S. Waldbusser
- RFC 1445**
Administrative Model for version 2 of the Simple Network Management Protocol (SNMPv2) J. Galvin, K. McCloghrie
- RFC 1447**
Party MIB for version 2 of the Simple Network Management Protocol (SNMPv2) K. McCloghrie, J. Galvin
- RFC 1448**
Protocol Operations for version 2 of the Simple Network Management Protocol (SNMPv2) J. Case, K. McCloghrie, M. Rose, S. Waldbusser
- RFC 1464**
Using the Domain Name System to Store Arbitrary String Attributes R. Rosenbaum
- RFC 1469**
IP Multicast over Token-Ring Local Area Networks T. Pusateri
- RFC 1483**
Multiprotocol Encapsulation over ATM Adaptation Layer 5 Juha Heinanen
- RFC 1514**
Host Resources MIB P. Grillo, S. Waldbusser
- RFC 1516**
Definitions of Managed Objects for IEEE 802.3 Repeater Devices D. McMaster, K. McCloghrie

- RFC 1521**
MIME (Multipurpose Internet Mail Extensions) Part One: Mechanisms for Specifying and Describing the Format of Internet Message Bodies N. Borenstein, N. Freed
- RFC 1535**
A Security Problem and Proposed Correction With Widely Deployed DNS Software E. Gavron
- RFC 1536**
Common DNS Implementation Errors and Suggested Fixes A. Kumar, J. Postel, C. Neuman, P. Danzig, S. Miller
- RFC 1537**
Common DNS Data File Configuration Errors P. Beertema
- RFC 1540**
Internet Official Protocol Standards J. Postel
- RFC 1571**
Telnet Environment Option Interoperability Issues D. Borman
- RFC 1572**
Telnet Environment Option S. Alexander
- RFC 1573**
Evolution of the Interfaces Group of MIB-II K. McCloghrie, F. Kastenholz
- RFC 1577**
Classical IP and ARP over ATM M. Laubach
- RFC 1583**
OSPF Version 2 J. Moy
- RFC 1591**
Domain Name System Structure and Delegation J. Postel
- RFC 1592**
Simple Network Management Protocol Distributed Protocol Interface Version 2.0 B. Wijnen, G. Carpenter, K. Curran, A. Sehgal, G. Waters
- RFC 1594**
FYI on Questions and Answers—Answers to Commonly Asked "New Internet User" Questions A. Marine, J. Reynolds, G. Malkin
- RFC 1644**
T/TCP — TCP Extensions for Transactions Functional Specification R. Braden
- RFC 1646**
TN3270 Extensions for LUname and Printer Selection C. Graves, T. Butts, M. Angel
- RFC 1647**
TN3270 Enhancements B. Kelly
- RFC 1652**
SMTP Service Extension for 8bit-MIMEtransport J. Klensin, N. Freed, M. Rose, E. Stefferud, D. Crocker
- RFC 1664**
Using the Internet DNS to Distribute RFC1327 Mail Address Mapping Tables C. Allochio, A. Bonito, B. Cole, S. Giordano, R. Hagens
- RFC 1693**
An Extension to TCP: Partial Order Service T. Connolly, P. Amer, P. Conrad

- RFC 1695**
Definitions of Managed Objects for ATM Management Version 8.0 using SMIPv2
M. Ahmed, K. Tesink
- RFC 1701**
Generic Routing Encapsulation (GRE) S. Hanks, T. Li, D. Farinacci, P. Traina
- RFC 1702**
Generic Routing Encapsulation over IPv4 networks S. Hanks, T. Li, D. Farinacci, P. Traina
- RFC 1706**
DNS NSAP Resource Records B. Manning, R. Colella
- RFC 1712**
DNS Encoding of Geographical Location C. Farrell, M. Schulze, S. Pleitner D. Baldoni
- RFC 1713**
Tools for DNS debugging A. Romao
- RFC 1723**
RIP Version 2—Carrying Additional Information G. Malkin
- RFC 1752**
The Recommendation for the IP Next Generation Protocol S. Bradner, A. Mankin
- RFC 1766**
Tags for the Identification of Languages H. Alvestrand
- RFC 1771**
A Border Gateway Protocol 4 (BGP-4) Y. Rekhter, T. Li
- RFC 1794**
DNS Support for Load Balancing T. Brisco
- RFC 1819**
Internet Stream Protocol Version 2 (ST2) Protocol Specification—Version ST2+ L. Delgrossi, L. Berger Eds.
- RFC 1826**
IP Authentication Header R. Atkinson
- RFC 1828**
IP Authentication using Keyed MD5 P. Metzger, W. Simpson
- RFC 1829**
The ESP DES-CBC Transform P. Karn, P. Metzger, W. Simpson
- RFC 1830**
SMTP Service Extensions for Transmission of Large and Binary MIME Messages
G. Vaudreuil
- RFC 1831**
RPC: Remote Procedure Call Protocol Specification Version 2 R. Srinivasan
- RFC 1832**
XDR: External Data Representation Standard R. Srinivasan
- RFC 1833**
Binding Protocols for ONC RPC Version 2 R. Srinivasan
- RFC 1850**
OSPF Version 2 Management Information Base F. Baker, R. Coltun

- RFC 1854**
SMTP Service Extension for Command Pipelining N. Freed
- RFC 1869**
SMTP Service Extensions J. Klensin, N. Freed, M. Rose, E. Stefferud, D. Crocker
- RFC 1870**
SMTP Service Extension for Message Size Declaration J. Klensin, N. Freed, K. Moore
- RFC 1876**
A Means for Expressing Location Information in the Domain Name System C. Davis, P. Vixie, T. Goodwin, I. Dickinson
- RFC 1883**
Internet Protocol, Version 6 (IPv6) Specification S. Deering, R. Hinden
- RFC 1884**
IP Version 6 Addressing Architecture R. Hinden, S. Deering, Eds.
- RFC 1886**
DNS Extensions to support IP version 6 S. Thomson, C. Huitema
- RFC 1888**
OSI NSAPs and IPv6 J. Bound, B. Carpenter, D. Harrington, J. Houldsworth, A. Lloyd
- RFC 1891**
SMTP Service Extension for Delivery Status Notifications K. Moore
- RFC 1892**
The Multipart/Report Content Type for the Reporting of Mail System Administrative Messages G. Vaudreuil
- RFC 1894**
An Extensible Message Format for Delivery Status Notifications K. Moore, G. Vaudreuil
- RFC 1901**
Introduction to Community-based SNMPv2 J. Case, K. McCloaghrie, M. Rose, S. Waldbusser
- RFC 1902**
Structure of Management Information for Version 2 of the Simple Network Management Protocol (SNMPv2) J. Case, K. McCloaghrie, M. Rose, S. Waldbusser
- RFC 1903**
Textual Conventions for Version 2 of the Simple Network Management Protocol (SNMPv2) J. Case, K. McCloaghrie, M. Rose, S. Waldbusser
- RFC 1904**
Conformance Statements for Version 2 of the Simple Network Management Protocol (SNMPv2) J. Case, K. McCloaghrie, M. Rose, S. Waldbusser
- RFC 1905**
Protocol Operations for Version 2 of the Simple Network Management Protocol (SNMPv2) J. Case, K. McCloaghrie, M. Rose, S. Waldbusser
- RFC 1906**
Transport Mappings for Version 2 of the Simple Network Management Protocol (SNMPv2) J. Case, K. McCloaghrie, M. Rose, S. Waldbusser

- RFC 1907**
Management Information Base for Version 2 of the Simple Network Management Protocol (SNMPv2) J. Case, K. McCloghrie, M. Rose, S. Waldbusser
- RFC 1908**
Coexistence between Version 1 and Version 2 of the Internet-standard Network Management Framework J. Case, K. McCloghrie, M. Rose, S. Waldbusser
- RFC 1912**
Common DNS Operational and Configuration Errors D. Barr
- RFC 1918**
Address Allocation for Private Internets Y. Rekhter, B. Moskowitz, D. Karrenberg, G.J. de Groot, E. Lear
- RFC 1928**
SOCKS Protocol Version 5 M. Leech, M. Ganis, Y. Lee, R. Kuris, D. Koblas, L. Jones
- RFC 1930**
Guidelines for creation, selection, and registration of an Autonomous System (AS) J. Hawkinson, T. Bates
- RFC 1939**
Post Office Protocol-Version 3 J. Myers, M. Rose
- RFC 1981**
Path MTU Discovery for IP version 6 J. McCann, S. Deering, J. Mogul
- RFC 1982**
Serial Number Arithmetic R. Elz, R. Bush
- RFC 1985**
SMTP Service Extension for Remote Message Queue Starting J. De Winter
- RFC 1995**
Incremental Zone Transfer in DNS M. Ohta
- RFC 1996**
A Mechanism for Prompt Notification of Zone Changes (DNS NOTIFY) P. Vixie
- RFC 2010**
Operational Criteria for Root Name Servers B. Manning, P. Vixie
- RFC 2011**
SNMPv2 Management Information Base for the Internet Protocol using SMIv2 K. McCloghrie, Ed.
- RFC 2012**
SNMPv2 Management Information Base for the Transmission Control Protocol using SMIv2 K. McCloghrie, Ed.
- RFC 2013**
SNMPv2 Management Information Base for the User Datagram Protocol using SMIv2 K. McCloghrie, Ed.
- RFC 2018**
TCP Selective Acknowledgement Options M. Mathis, J. Mahdavi, S. Floyd, A. Romanow
- RFC 2026**
The Internet Standards Process — Revision 3 S. Bradner

- RFC 2030**
Simple Network Time Protocol (SNTP) Version 4 for IPv4, IPv6 and OSI D.
Mills
- RFC 2033**
Local Mail Transfer Protocol J. Myers
- RFC 2034**
SMTP Service Extension for Returning Enhanced Error Codes N. Freed
- RFC 2040**
The RC5, RC5–CBC, RC-5–CBC-Pad, and RC5–CTS Algorithms R. Baldwin, R. Rivest
- RFC 2045**
Multipurpose Internet Mail Extensions (MIME) Part One: Format of Internet Message Bodies N. Freed, N. Borenstein
- RFC 2052**
A DNS RR for specifying the location of services (DNS SRV) A. Gulbrandsen, P. Vixie
- RFC 2065**
Domain Name System Security Extensions D. Eastlake 3rd, C. Kaufman
- RFC 2066**
TELNET CHARSET Option R. Gellens
- RFC 2080**
RIPng for IPv6 G. Malkin, R. Minnear
- RFC 2096**
IP Forwarding Table MIB F. Baker
- RFC 2104**
HMAC: Keyed-Hashing for Message Authentication H. Krawczyk, M. Bellare, R. Canetti
- RFC 2119**
Keywords for use in RFCs to Indicate Requirement Levels S. Bradner
- RFC 2133**
Basic Socket Interface Extensions for IPv6 R. Gilligan, S. Thomson, J. Bound, W. Stevens
- RFC 2136**
Dynamic Updates in the Domain Name System (DNS UPDATE) P. Vixie, Ed., S. Thomson, Y. Rekhter, J. Bound
- RFC 2137**
Secure Domain Name System Dynamic Update D. Eastlake 3rd
- RFC 2163**
Using the Internet DNS to Distribute MIXER Conformant Global Address Mapping (MCGAM) C. Allocchio
- RFC 2168**
Resolution of Uniform Resource Identifiers using the Domain Name System R. Daniel, M. Mealling
- RFC 2178**
OSPF Version 2 J. Moy
- RFC 2181**
Clarifications to the DNS Specification R. Elz, R. Bush

- RFC 2205**
Resource ReSerVation Protocol (RSVP)—Version 1 Functional Specification R. Braden, Ed., L. Zhang, S. Berson, S. Herzog, S. Jamin
- RFC 2210**
The Use of RSVP with IETF Integrated Services J. Wroclawski
- RFC 2211**
Specification of the Controlled-Load Network Element Service J. Wroclawski
- RFC 2212**
Specification of Guaranteed Quality of Service S. Shenker, C. Partridge, R. Guerin
- RFC 2215**
General Characterization Parameters for Integrated Service Network Elements S. Shenker, J. Wroclawski
- RFC 2217**
Telnet Com Port Control Option G. Clarke
- RFC 2219**
Use of DNS Aliases for Network Services M. Hamilton, R. Wright
- RFC 2228**
FTP Security Extensions M. Horowitz, S. Lunt
- RFC 2230**
Key Exchange Delegation Record for the DNS R. Atkinson
- RFC 2233**
The Interfaces Group MIB using SMIPv2 K. McCloghrie, F. Kastenholz
- RFC 2240**
A Legal Basis for Domain Name Allocation O. Vaughn
- RFC 2246**
The TLS Protocol Version 1.0 T. Dierks, C. Allen
- RFC 2251**
Lightweight Directory Access Protocol (v3) M. Wahl, T. Howes, S. Kille
- RFC 2253**
Lightweight Directory Access Protocol (v3): UTF-8 String Representation of Distinguished Names M. Wahl, S. Kille, T. Howes
- RFC 2254**
The String Representation of LDAP Search Filters T. Howes
- RFC 2261**
An Architecture for Describing SNMP Management Frameworks D. Harrington, R. Presuhn, B. Wijnen
- RFC 2262**
Message Processing and Dispatching for the Simple Network Management Protocol (SNMP) J. Case, D. Harrington, R. Presuhn, B. Wijnen
- RFC 2271**
An Architecture for Describing SNMP Management Frameworks D. Harrington, R. Presuhn, B. Wijnen
- RFC 2273**
SNMPv3 Applications D. Levi, P. Meyer, B. Stewart

- RFC 2274**
User-based Security Model (USM) for version 3 of the Simple Network Management Protocol (SNMPv3) U. Blumenthal, B. Wijnen
- RFC 2275**
View-based Access Control Model (VACM) for the Simple Network Management Protocol (SNMP) B. Wijnen, R. Presuhn, K. McCloghrie
- RFC 2279**
UTF-8, a transformation format of ISO 10646 F. Yergeau
- RFC 2292**
Advanced Sockets API for IPv6 W. Stevens, M. Thomas
- RFC 2308**
Negative Caching of DNS Queries (DNS NCACHE) M. Andrews
- RFC 2317**
Classless IN-ADDR.ARPA delegation H. Eidnes, G. de Groot, P. Vixie
- RFC 2320**
Definitions of Managed Objects for Classical IP and ARP Over ATM Using SMIv2 (IPOA-MIB) M. Greene, J. Luciani, K. White, T. Kuo
- RFC 2328**
OSPF Version 2 J. Moy
- RFC 2345**
Domain Names and Company Name Retrieval J. Klensin, T. Wolf, G. Oglesby
- RFC 2352**
A Convention for Using Legal Names as Domain Names O. Vaughn
- RFC 2355**
TN3270 Enhancements B. Kelly
- RFC 2358**
Definitions of Managed Objects for the Ethernet-like Interface Types J. Flick, J. Johnson
- RFC 2373**
IP Version 6 Addressing Architecture R. Hinden, S. Deering
- RFC 2374**
An IPv6 Aggregatable Global Unicast Address Format R. Hinden, M. O'Dell, S. Deering
- RFC 2375**
IPv6 Multicast Address Assignments R. Hinden, S. Deering
- RFC 2385**
Protection of BGP Sessions via the TCP MD5 Signature Option A. Hefferman
- RFC 2389**
Feature negotiation mechanism for the File Transfer Protocol P. Hethmon, R. Elz
- RFC 2401**
Security Architecture for Internet Protocol S. Kent, R. Atkinson
- RFC 2402**
IP Authentication Header S. Kent, R. Atkinson
- RFC 2403**
The Use of HMAC-MD5-96 within ESP and AH C. Madson, R. Glenn

- RFC 2404**
The Use of HMAC-SHA-1-96 within ESP and AH C. Madson, R. Glenn
- RFC 2405**
The ESP DES-CBC Cipher Algorithm With Explicit IV C. Madson, N. Doraswamy
- RFC 2406**
IP Encapsulating Security Payload (ESP) S. Kent, R. Atkinson
- RFC 2407**
The Internet IP Security Domain of Interpretation for ISAKMPD. Piper
- RFC 2408**
Internet Security Association and Key Management Protocol (ISAKMP) D. Maughan, M. Schertler, M. Schneider, J. Turner
- RFC 2409**
The Internet Key Exchange (IKE) D. Harkins, D. Carrel
- RFC 2410**
The NULL Encryption Algorithm and Its Use With IPsec R. Glenn, S. Kent,
- RFC 2428**
FTP Extensions for IPv6 and NATs M. Allman, S. Ostermann, C. Metz
- RFC 2445**
Internet Calendaring and Scheduling Core Object Specification (iCalendar) F. Dawson, D. Stenerson
- RFC 2459**
Internet X.509 Public Key Infrastructure Certificate and CRL Profile R. Housley, W. Ford, W. Polk, D. Solo
- RFC 2460**
Internet Protocol, Version 6 (IPv6) Specification S. Deering, R. Hinden
- RFC 2461**
Neighbor Discovery for IP Version 6 (IPv6) T. Narten, E. Nordmark, W. Simpson
- RFC 2462**
IPv6 Stateless Address Autoconfiguration S. Thomson, T. Narten
- RFC 2463**
Internet Control Message Protocol (ICMPv6) for the Internet Protocol Version 6 (IPv6) Specification A. Conta, S. Deering
- RFC 2464**
Transmission of IPv6 Packets over Ethernet Networks M. Crawford
- RFC 2466**
Management Information Base for IP Version 6: ICMPv6 Group D. Haskin, S. Onishi
- RFC 2476**
Message Submission R. Gellens, J. Klensin
- RFC 2487**
SMTP Service Extension for Secure SMTP over TLS P. Hoffman
- RFC 2505**
Anti-Spam Recommendations for SMTP MTAs G. Lindberg

- RFC 2523**
Photuris: Extended Schemes and Attributes P. Karn, W. Simpson
- RFC 2535**
Domain Name System Security Extensions D. Eastlake 3rd
- RFC 2538**
Storing Certificates in the Domain Name System (DNS) D. Eastlake 3rd, O. Gudmundsson
- RFC 2539**
Storage of Diffie-Hellman Keys in the Domain Name System (DNS) D. Eastlake 3rd
- RFC 2540**
Detached Domain Name System (DNS) Information D. Eastlake 3rd
- RFC 2554**
SMTP Service Extension for Authentication J. Myers
- RFC 2570**
Introduction to Version 3 of the Internet-standard Network Management Framework J. Case, R. Mundy, D. Partain, B. Stewart
- RFC 2571**
An Architecture for Describing SNMP Management Frameworks B. Wijnen, D. Harrington, R. Presuhn
- RFC 2572**
Message Processing and Dispatching for the Simple Network Management Protocol (SNMP) J. Case, D. Harrington, R. Presuhn, B. Wijnen
- RFC 2573**
SNMP Applications D. Levi, P. Meyer, B. Stewart
- RFC 2574**
User-based Security Model (USM) for version 3 of the Simple Network Management Protocol (SNMPv3) U. Blumenthal, B. Wijnen
- RFC 2575**
View-based Access Control Model (VACM) for the Simple Network Management Protocol (SNMP) B. Wijnen, R. Presuhn, K. McCloghrie
- RFC 2576**
Co-Existence between Version 1, Version 2, and Version 3 of the Internet-standard Network Management Framework R. Frye, D. Levi, S. Routhier, B. Wijnen
- RFC 2578**
Structure of Management Information Version 2 (SMIv2) K. McCloghrie, D. Perkins, J. Schoenwaelder
- RFC 2579**
Textual Conventions for SMIv2 K. McCloghrie, D. Perkins, J. Schoenwaelder
- RFC 2580**
Conformance Statements for SMIv2 K. McCloghrie, D. Perkins, J. Schoenwaelder
- RFC 2581**
TCP Congestion Control M. Allman, V. Paxson, W. Stevens
- RFC 2583**
Guidelines for Next Hop Client (NHC) Developers R. Carlson, L. Winkler

- RFC 2591**
Definitions of Managed Objects for Scheduling Management Operations D. Levi,
J. Schoenwaelder
- RFC 2625**
IP and ARP over Fibre Channel M. Rajagopal, R. Bhagwat, W. Rickard
- RFC 2635**
*Don't SPEW A Set of Guidelines for Mass Unsolicited Mailings and Postings
(spam*)* S. Hambridge, A. Lunde
- RFC 2637**
Point-to-Point Tunneling Protocol K. Hamzeh, G. Pall, W. Verthein, J. Taarud,
W. Little, G. Zorn
- RFC 2640**
Internationalization of the File Transfer Protocol B. Curtin
- RFC 2665**
Definitions of Managed Objects for the Ethernet-like Interface Types J. Flick, J.
Johnson
- RFC 2671**
Extension Mechanisms for DNS (EDNS0) P. Vixie
- RFC 2672**
Non-Terminal DNS Name Redirection M. Crawford
- RFC 2675**
IPv6 Jumbograms D. Borman, S. Deering, R. Hinden
- RFC 2710**
Multicast Listener Discovery (MLD) for IPv6 S. Deering, W. Fenner, B.
Haberman
- RFC 2711**
IPv6 Router Alert Option C. Partridge, A. Jackson
- RFC 2740**
OSPF for IPv6 R. Coltun, D. Ferguson, J. Moy
- RFC 2753**
A Framework for Policy-based Admission Control R. Yavatkar, D. Pendarakis,
R. Guerin
- RFC 2782**
A DNS RR for specifying the location of services (DNS SRV) A. Gubrandsen, P.
Vixix, L. Esibov
- RFC 2821**
Simple Mail Transfer Protocol J. Klensin, Ed.
- RFC 2822**
Internet Message Format P. Resnick, Ed.
- RFC 2840**
TELNET KERMIT OPTION J. Altman, F. da Cruz
- RFC 2845**
Secret Key Transaction Authentication for DNS (TSIG) P. Vixie, O.
Gudmundsson, D. Eastlake 3rd, B. Wellington
- RFC 2851**
Textual Conventions for Internet Network Addresses M. Daniele, B. Haberman,
S. Routhier, J. Schoenwaelder

- RFC 2852**
Deliver By SMTP Service Extension D. Newman
- RFC 2874**
DNS Extensions to Support IPv6 Address Aggregation and Renumbering M. Crawford, C. Huitema
- RFC 2915**
The Naming Authority Pointer (NAPTR) DNS Resource Record M. Mealling, R. Daniel
- RFC 2920**
SMTP Service Extension for Command Pipelining N. Freed
- RFC 2930**
Secret Key Establishment for DNS (TKEY RR) D. Eastlake, 3rd
- RFC 2941**
Telnet Authentication Option T. Ts'o, ed., J. Altman
- RFC 2942**
Telnet Authentication: Kerberos Version 5 T. Ts'o
- RFC 2946**
Telnet Data Encryption Option T. Ts'o
- RFC 2952**
Telnet Encryption: DES 64 bit Cipher Feedback T. Ts'o
- RFC 2953**
Telnet Encryption: DES 64 bit Output Feedback T. Ts'o
- RFC 2992**
Analysis of an Equal-Cost Multi-Path Algorithm C. Hopps
- RFC 3019**
IP Version 6 Management Information Base for The Multicast Listener Discovery Protocol B. Haberman, R. Worzella
- RFC 3060**
Policy Core Information Model—Version 1 Specification B. Moore, E. Ellesson, J. Strassner, A. Westerinen
- RFC 3152**
Delegation of IP6.ARPA R. Bush
- RFC 3164**
The BSD Syslog Protocol C. Lonvick
- RFC 3207**
SMTP Service Extension for Secure SMTP over Transport Layer Security P. Hoffman
- RFC 3226**
DNSSEC and IPv6 A6 aware server/resolver message size requirements O. Gudmundsson
- RFC 3291**
Textual Conventions for Internet Network Addresses M. Daniele, B. Haberman, S. Routhier, J. Schoenwaelder
- RFC 3363**
Representing Internet Protocol version 6 (IPv6) Addresses in the Domain Name System R. Bush, A. Durand, B. Fink, O. Gudmundsson, T. Hain

- RFC 3376**
Internet Group Management Protocol, Version 3 B. Cain, S. Deering, I. Kouvelas, B. Fenner, A. Thyagarajan
- RFC 3390**
Increasing TCP's Initial Window M. Allman, S. Floyd, C. Partridge
- RFC 3410**
Introduction and Applicability Statements for Internet-Standard Management Framework J. Case, R. Mundy, D. Partain, B. Stewart
- RFC 3411**
An Architecture for Describing Simple Network Management Protocol (SNMP) Management Frameworks D. Harrington, R. Presuhn, B. Wijnen
- RFC 3412**
Message Processing and Dispatching for the Simple Network Management Protocol (SNMP) J. Case, D. Harrington, R. Presuhn, B. Wijnen
- RFC 3413**
Simple Network Management Protocol (SNMP) Applications D. Levi, P. Meyer, B. Stewart
- RFC 3414**
User-based Security Model (USM) for version 3 of the Simple Network Management Protocol (SNMPv3) U. Blumenthal, B. Wijnen
- RFC 3415**
View-based Access Control Model (VACM) for the Simple Network Management Protocol (SNMP) B. Wijnen, R. Presuhn, K. McCloghrie
- RFC 3416**
Version 2 of the Protocol Operations for the Simple Network Management Protocol (SNMP) R. Presuhn, J. Case, K. McCloghrie, M. Rose, S. Waldbusser
- RFC 3417**
Transport Mappings for the Simple Network Management Protocol (SNMP) R. Presuhn, J. Case, K. McCloghrie, M. Rose, S. Waldbusser
- RFC 3418**
Management Information Base (MIB) for the Simple Network Management Protocol (SNMP) R. Presuhn, J. Case, K. McCloghrie, M. Rose, S. Waldbusser
- RFC 3419**
Textual Conventions for Transport Addresses M. Daniele, J. Schoenwaelder
- RFC 3484**
Default Address Selection for Internet Protocol version 6 (IPv6) R. Draves
- RFC 3493**
Basic Socket Interface Extensions for IPv6 R. Gilligan, S. Thomson, J. Bound, J. McCann, W. Stevens
- RFC 3513**
Internet Protocol Version 6 (IPv6) Addressing Architecture R. Hinden, S. Deering
- RFC 3526**
More Modular Exponential (MODP) Diffie-Hellman groups for Internet Key Exchange (IKE) T. Kivinen, M. Kojo

- RFC 3542**
Advanced Sockets Application Programming Interface (API) for IPv6 W. Richard Stevens, M. Thomas, E. Nordmark, T. Jinmei
- RFC 3566**
The AES-XCBC-MAC-96 Algorithm and Its Use With IPsec S. Frankel, H. Herbert
- RFC 3569**
An Overview of Source-Specific Multicast (SSM) S. Bhattacharyya, Ed.
- RFC 3584**
Coexistence between Version 1, Version 2, and Version 3 of the Internet-standard Network Management Framework R. Frye, D. Levi, S. Routhier, B. Wijnen
- RFC 3602**
The AES-CBC Cipher Algorithm and Its Use with IPsec S. Frankel, R. Glenn, S. Kelly
- RFC 3629**
UTF-8, a transformation format of ISO 10646 R. Kermode, C. Vicisano
- RFC 3658**
Delegation Signer (DS) Resource Record (RR) O. Gudmundsson
- RFC 3678**
Socket Interface Extensions for Multicast Source Filters D. Thaler, B. Fenner, B. Quinn
- RFC 3715**
IPsec-Network Address Translation (NAT) Compatibility Requirements B. Aboba, W. Dixon
- RFC 3810**
Multicast Listener Discovery Version 2 (MLDv2) for IPv6 R. Vida, Ed., L. Costa, Ed.
- RFC 3947**
Negotiation of NAT-Traversal in the IKE T. Kivinen, B. Swander, A. Huttunen, V. Volpe
- RFC 3948**
UDP Encapsulation of IPsec ESP Packets A. Huttunen, B. Swander, V. Volpe, L. DiBurro, M. Stenberg
- RFC 4001**
Textual Conventions for Internet Network Addresses M. Daniele, B. Haberman, S. Routhier, J. Schoenwaelder
- RFC 4007**
IPv6 Scoped Address Architecture S. Deering, B. Haberman, T. Jinmei, E. Nordmark, B. Zill
- RFC 4022**
Management Information Base for the Transmission Control Protocol (TCP) R. Raghunathan
- RFC 4106**
The Use of Galois/Counter Mode (GCM) in IPsec Encapsulating Security Payload (ESP) J. Viega, D. McGrew
- RFC 4109**
Algorithms for Internet Key Exchange version 1 (IKEv1) P. Hoffman

- RFC 4113**
Management Information Base for the User Datagram Protocol (UDP) B. Fenner,
J. Flick
- RFC 4191**
Default Router Preferences and More-Specific Routes R. Draves, D. Thaler
- RFC 4217**
Securing FTP with TLS P. Ford-Hutchinson
- RFC 4292**
IP Forwarding Table MIB B. Haberman
- RFC 4293**
Management Information Base for the Internet Protocol (IP) S. Routhier
- RFC 4301**
Security Architecture for the Internet Protocol S. Kent, K. Seo
- RFC 4302**
IP Authentication Header S. Kent
- RFC 4303**
IP Encapsulating Security Payload (ESP) S. Kent
- RFC 4304**
Extended Sequence Number (ESN) Addendum to IPsec Domain of Interpretation (DOI) for Internet Security Association and Key Management Protocol (ISAKMP) S. Kent
- RFC 4307**
Cryptographic Algorithms for Use in the Internet Key Exchange Version 2 (IKEv2) J. Schiller
- RFC 4308**
Cryptographic Suites for IPsec P. Hoffman
- RFC 4434**
The AES-XCBC-PRF-128 Algorithm for the Internet Key Exchange Protocol P. Hoffman
- RFC 4443**
Internet Control Message Protocol (ICMPv6) for the Internet Protocol Version 6 (IPv6) Specification A. Conta, S. Deering
- RFC 4552**
Authentication/Confidentiality for OSPFv3 M. Gupta, N. Melam
- RFC 4678**
Server/Application State Protocol v1 A. Bivens
- RFC 4753**
ECP Groups for IKE and IKEv2 D. Fu, J. Solinas
- RFC 4754**
IKE and IKEv2 Authentication Using the Elliptic Curve Digital Signature Algorithm (ECDSA) D. Fu, J. Solinas
- RFC 4809**
Requirements for an IPsec Certificate Management Profile C. Bonatti, Ed., S. Turner, Ed., G. Lebovitz, Ed.
- RFC 4835**
Cryptographic Algorithm Implementation Requirements for Encapsulating Security Payload (ESP) and Authentication Header (AH) V. Manral

- RFC 4862**
IPv6 Stateless Address Autoconfiguration S. Thomson, T. Narten, T. Jinmei
- RFC 4868**
Using HMAC-SHA-256, HMAC-SHA-384, and HMAC-SHA-512 with IPsec S. Kelly, S. Frankel
- RFC 4869**
Suite B Cryptographic Suites for IPsec L. Law, J. Solinas
- RFC 4941**
Privacy Extensions for Stateless Address Autoconfiguration in IPv6 T. Narten, R. Draves, S. Krishnan
- RFC 4945**
The Internet IP Security PKI Profile of IKEv1/ISAKMP, IKEv2, and PKIX B. Korver
- RFC 5014**
IPv6 Socket API for Source Address Selection E. Nordmark, S. Chakrabarti, J. Laganier
- RFC 5095**
Deprecation of Type 0 Routing Headers in IPv6 J. Abley, P. Savola, G. Neville-Neil
- RFC 5175**
IPv6 Router Advertisement Flags Option B. Haberman, Ed., R. Hinden
- RFC 5282**
Using Authenticated Encryption Algorithms with the Encrypted Payload of the Internet Key Exchange version 2 (IKEv2) Protocol D. Black, D. McGrew
- RFC 5996**
Internet Key Exchange Protocol Version 2 (IKEv2) C. Kaufman, P. Hoffman, Y. Nir, P. Eronen

Internet drafts

Internet drafts are working documents of the Internet Engineering Task Force (IETF), its areas, and its working groups. Other groups can also distribute working documents as Internet drafts. You can see Internet drafts at <http://www.ietf.org/ID.html>.

Appendix F. Accessibility

Publications for this product are offered in Adobe Portable Document Format (PDF) and should be compliant with accessibility standards. If you experience difficulties when using PDF files, you can view the information through the z/OS Internet Library website or the z/OS Information Center. If you continue to experience problems, send an email to mhvrcfs@us.ibm.com or write to:

IBM Corporation
Attention: MHVRCFS Reader Comments
Department H6MA, Building 707
2455 South Road
Poughkeepsie, NY 12601-5400
USA

Accessibility features help a user who has a physical disability, such as restricted mobility or limited vision, to use software products successfully. The major accessibility features in z/OS enable users to:

- Use assistive technologies such as screen readers and screen magnifier software
- Operate specific or equivalent features using only the keyboard
- Customize display attributes such as color, contrast, and font size

Using assistive technologies

Assistive technology products, such as screen readers, function with the user interfaces found in z/OS. Consult the assistive technology documentation for specific information when using such products to access z/OS interfaces.

Keyboard navigation of the user interface

Users can access z/OS user interfaces using TSO/E or ISPF. See *z/OS TSO/E Primer*, *z/OS TSO/E User's Guide*, and *z/OS ISPF User's Guide Vol I* for information about accessing TSO/E and ISPF interfaces. These guides describe how to use TSO/E and ISPF, including the use of keyboard shortcuts or function keys (PF keys). Each guide includes the default settings for the PF keys and explains how to modify their functions.

z/OS information

z/OS information is accessible using screen readers with the BookServer or Library Server versions of z/OS books in the Internet library at www.ibm.com/systems/z/os/zos/bkserv/.

One exception is command syntax that is published in railroad track format, which is accessible using screen readers with the Information Center, as described in "Dotted decimal syntax diagrams."

Dotted decimal syntax diagrams

Syntax diagrams are provided in dotted decimal format for users accessing the Information Center using a screen reader. In dotted decimal format, each syntax element is written on a separate line. If two or more syntax elements are always

present together (or always absent together), they can appear on the same line, because they can be considered as a single compound syntax element.

Each line starts with a dotted decimal number; for example, 3 or 3.1 or 3.1.1. To hear these numbers correctly, make sure that your screen reader is set to read out punctuation. All the syntax elements that have the same dotted decimal number (for example, all the syntax elements that have the number 3.1) are mutually exclusive alternatives. If you hear the lines 3.1 USERID and 3.1 SYSTEMID, you know that your syntax can include either USERID or SYSTEMID, but not both.

The dotted decimal numbering level denotes the level of nesting. For example, if a syntax element with dotted decimal number 3 is followed by a series of syntax elements with dotted decimal number 3.1, all the syntax elements numbered 3.1 are subordinate to the syntax element numbered 3.

Certain words and symbols are used next to the dotted decimal numbers to add information about the syntax elements. Occasionally, these words and symbols might occur at the beginning of the element itself. For ease of identification, if the word or symbol is a part of the syntax element, it is preceded by the backslash (\) character. The * symbol can be used next to a dotted decimal number to indicate that the syntax element repeats. For example, syntax element *FILE with dotted decimal number 3 is given the format 3 * FILE. Format 3* FILE indicates that syntax element FILE repeats. Format 3* * FILE indicates that syntax element * FILE repeats.

Characters such as commas, which are used to separate a string of syntax elements, are shown in the syntax just before the items they separate. These characters can appear on the same line as each item, or on a separate line with the same dotted decimal number as the relevant items. The line can also show another symbol giving information about the syntax elements. For example, the lines 5.1*, 5.1 LASTRUN, and 5.1 DELETE mean that if you use more than one of the LASTRUN and DELETE syntax elements, the elements must be separated by a comma. If no separator is given, assume that you use a blank to separate each syntax element.

If a syntax element is preceded by the % symbol, this indicates a reference that is defined elsewhere. The string following the % symbol is the name of a syntax fragment rather than a literal. For example, the line 2.1 %OP1 means that you should see separate syntax fragment OP1.

The following words and symbols are used next to the dotted decimal numbers:

- A question mark (?) means an optional syntax element. A dotted decimal number followed by the ? symbol indicates that all the syntax elements with a corresponding dotted decimal number, and any subordinate syntax elements, are optional. If there is only one syntax element with a dotted decimal number, the ? symbol is displayed on the same line as the syntax element, (for example 5? NOTIFY). If there is more than one syntax element with a dotted decimal number, the ? symbol is displayed on a line by itself, followed by the syntax elements that are optional. For example, if you hear the lines 5 ?, 5 NOTIFY, and 5 UPDATE, you know that syntax elements NOTIFY and UPDATE are optional; that is, you can choose one or none of them. The ? symbol is equivalent to a bypass line in a railroad diagram.
- An exclamation mark (!) means a default syntax element. A dotted decimal number followed by the ! symbol and a syntax element indicate that the syntax element is the default option for all syntax elements that share the same dotted

decimal number. Only one of the syntax elements that share the same dotted decimal number can specify a ! symbol. For example, if you hear the lines 2? FILE, 2.1! (KEEP), and 2.1 (DELETE), you know that (KEEP) is the default option for the FILE keyword. In this example, if you include the FILE keyword but do not specify an option, default option KEEP will be applied. A default option also applies to the next higher dotted decimal number. In this example, if the FILE keyword is omitted, default FILE(KEEP) is used. However, if you hear the lines 2? FILE, 2.1, 2.1.1! (KEEP), and 2.1.1 (DELETE), the default option KEEP applies only to the next higher dotted decimal number, 2.1 (which does not have an associated keyword), and does not apply to 2? FILE. Nothing is used if the keyword FILE is omitted.

- An asterisk (*) means a syntax element that can be repeated 0 or more times. A dotted decimal number followed by the * symbol indicates that this syntax element can be used zero or more times; that is, it is optional and can be repeated. For example, if you hear the line 5.1* data area, you know that you can include one data area, more than one data area, or no data area. If you hear the lines 3*, 3 HOST, and 3 STATE, you know that you can include HOST, STATE, both together, or nothing.

Notes:

1. If a dotted decimal number has an asterisk (*) next to it and there is only one item with that dotted decimal number, you can repeat that same item more than once.
 2. If a dotted decimal number has an asterisk next to it and several items have that dotted decimal number, you can use more than one item from the list, but you cannot use the items more than once each. In the previous example, you could write HOST STATE, but you could not write HOST HOST.
 3. The * symbol is equivalent to a loop-back line in a railroad syntax diagram.
- + means a syntax element that must be included one or more times. A dotted decimal number followed by the + symbol indicates that this syntax element must be included one or more times; that is, it must be included at least once and can be repeated. For example, if you hear the line 6.1+ data area, you must include at least one data area. If you hear the lines 2+, 2 HOST, and 2 STATE, you know that you must include HOST, STATE, or both. Similar to the * symbol, the + symbol can only repeat a particular item if it is the only item with that dotted decimal number. The + symbol, like the * symbol, is equivalent to a loop-back line in a railroad syntax diagram.

Notices

This information was developed for products and services offered in the USA.

IBM may not offer all of the products, services, or features discussed in this document in other countries. Consult your local IBM representative for information on the products and services currently available in your area. Any reference to an IBM product, program, or service is not intended to state or imply that only that IBM product, program, or service may be used. Any functionally equivalent product, program, or service that does not infringe any IBM intellectual property right may be used instead. However, it is the user's responsibility to evaluate and verify the operation of any non-IBM product, program, or service.

IBM may have patents or pending patent applications covering subject matter described in this document. The furnishing of this document does not give you any license to these patents. You can send license inquiries, in writing, to:

IBM Director of Licensing
IBM Corporation
North Castle Drive
Armonk, NY 10504-1785
U.S.A.

For license inquiries regarding double-byte (DBCS) information, contact the IBM Intellectual Property Department in your country or send inquiries, in writing, to:

Intellectual Property Licensing
Legal and Intellectual Property Law
IBM Japan, Ltd.
19-21, Nihonbashi-Hakozakicho, Chuo-ku
Tokyo 103-8510, Japan

The following paragraph does not apply to the United Kingdom or any other country where such provisions are inconsistent with local law: INTERNATIONAL BUSINESS MACHINES CORPORATION PROVIDES THIS PUBLICATION "AS IS" WITHOUT WARRANTY OF ANY KIND, EITHER EXPRESS OR IMPLIED, INCLUDING, BUT NOT LIMITED TO, THE IMPLIED WARRANTIES OF NON-INFRINGEMENT, MERCHANTABILITY OR FITNESS FOR A PARTICULAR PURPOSE. Some states do not allow disclaimer of express or implied warranties in certain transactions, therefore, this statement may not apply to you.

This information could include technical inaccuracies or typographical errors. Changes are periodically made to the information herein; these changes will be incorporated in new editions of the publication. IBM may make improvements and/or changes in the product(s) and/or the program(s) described in this publication at any time without notice.

Any references in this information to non-IBM websites are provided for convenience only and do not in any manner serve as an endorsement of those websites. The materials at those websites are not part of the materials for this IBM product and use of those websites is at your own risk.

IBM may use or distribute any of the information you supply in any way it believes appropriate without incurring any obligation to you.

Licensees of this program who want to have information about it for the purpose of enabling: (i) the exchange of information between independently created programs and other programs (including this one) and (ii) the mutual use of the information which has been exchanged, should contact:

Site Counsel
IBM Corporation
P.O. Box 12195
3039 Cornwallis Road
Research Triangle Park, North Carolina 27709-2195
U.S.A

Such information may be available, subject to appropriate terms and conditions, including in some cases, payment of a fee.

The licensed program described in this information and all licensed material available for it are provided by IBM under terms of the IBM Customer Agreement, IBM International Program License Agreement, or any equivalent agreement between us.

Any performance data contained herein was determined in a controlled environment. Therefore, the results obtained in other operating environments may vary significantly. Some measurements may have been made on development-level systems and there is no guarantee that these measurements will be the same on generally available systems. Furthermore, some measurement may have been estimated through extrapolation. Actual results may vary. Users of this document should verify the applicable data for their specific environment.

Information concerning non-IBM products was obtained from the suppliers of those products, their published announcements or other publicly available sources. IBM has not tested those products and cannot confirm the accuracy of performance, compatibility or any other claims related to non-IBM products. Questions on the capabilities of non-IBM products should be addressed to the suppliers of those products.

All statements regarding IBM's future direction or intent are subject to change or withdrawal without notice, and represent goals and objectives only.

This information contains examples of data and reports used in daily business operations. To illustrate them as completely as possible, the examples include the names of individuals, companies, brands, and products. All of these names are fictitious and any similarity to the names and addresses used by an actual business enterprise is entirely coincidental.

If you are viewing this information softcopy, the photographs and color illustrations might not appear.

COPYRIGHT LICENSE:

This information might contain sample application programs in source language, which illustrates programming techniques on various operating platforms. You may copy, modify, and distribute these sample programs in any form without payment to IBM, for the purposes of developing, using, marketing or distributing

application programs conforming to the application programming interface for the operating platform for which the sample programs are written. These examples have not been thoroughly tested under all conditions. IBM, therefore, cannot guarantee or imply reliability, serviceability, or function of these programs. The sample programs are provided "AS IS", without warranty of any kind. IBM shall not be liable for any damages arising out of your use of the sample programs.

Each copy or any portion of these sample programs or any derivative work must include a copyright notice as follows:

© (your company name) (year). Portions of this code are derived from IBM Corp. Sample Programs. © Copyright IBM Corp. _enter the year or years_.

IBM is required to include the following statements in order to distribute portions of this document and the software described herein to which contributions have been made by The University of California. Portions herein © Copyright 1979, 1980, 1983, 1986, Regents of the University of California. Reproduced by permission. Portions herein were developed at the Electrical Engineering and Computer Sciences Department at the Berkeley campus of the University of California under the auspices of the Regents of the University of California.

Portions of this publication relating to RPC are Copyright © Sun Microsystems, Inc., 1988, 1989.

Some portions of this publication relating to X Window System** are Copyright © 1987, 1988 by Digital Equipment Corporation, Maynard, Massachusetts, and the Massachusetts Institute Of Technology, Cambridge, Massachusetts.

Some portions of this publication relating to X Window System are Copyright © 1986, 1987, 1988 by Hewlett-Packard Corporation.

Permission to use, copy, modify, and distribute the M.I.T., Digital Equipment Corporation, and Hewlett-Packard Corporation portions of this software and its documentation for any purpose without fee is hereby granted, provided that the above copyright notice appears in all copies and that both that copyright notice and this permission notice appear in supporting documentation, and that the names of M.I.T., Digital, and Hewlett-Packard not be used in advertising or publicity pertaining to distribution of the software without specific, written prior permission. M.I.T., Digital, and Hewlett-Packard make no representation about the suitability of this software for any purpose. It is provided "as is" without express or implied warranty.

Copyright © 1983, 1995-1997 Eric P. Allman

Copyright © 1988, 1993 The Regents of the University of California.

Redistribution and use in source and binary forms, with or without modification, are permitted provided that the following conditions are met:

1. Redistributions of source code must retain the above copyright notice, this list of conditions and the following disclaimer.
2. Redistributions in binary form must reproduce the above copyright notice, this list of conditions and the following disclaimer in the documentation and/or other materials provided with the distribution.
3. All advertising materials mentioning features or use of this software must display the following acknowledgment:

This product includes software developed by the University of California, Berkeley and its contributors.

4. Neither the name of the University nor the names of its contributors may be used to endorse or promote products derived from this software without specific prior written permission.

THIS SOFTWARE IS PROVIDED BY THE REGENTS AND CONTRIBUTORS "AS IS" AND ANY EXPRESS OR IMPLIED WARRANTIES, INCLUDING, BUT NOT LIMITED TO, THE IMPLIED WARRANTIES OF MERCHANTABILITY AND FITNESS FOR A PARTICULAR PURPOSE ARE DISCLAIMED. IN NO EVENT SHALL THE REGENTS OR CONTRIBUTORS BE LIABLE FOR ANY DIRECT, INDIRECT, INCIDENTAL, SPECIAL, EXEMPLARY, OR CONSEQUENTIAL DAMAGES (INCLUDING, BUT NOT LIMITED TO, PROCUREMENT OF SUBSTITUTE GOODS OR SERVICES; LOSS OF USE, DATA, OR PROFITS; OR BUSINESS INTERRUPTION) HOWEVER CAUSED AND ON ANY THEORY OF LIABILITY, WHETHER IN CONTRACT, STRICT LIABILITY, OR TORT (INCLUDING NEGLIGENCE OR OTHERWISE) ARISING IN ANY WAY OUT OF THE USE OF THIS SOFTWARE, EVEN IF ADVISED OF THE POSSIBILITY OF SUCH DAMAGE.

This software program contains code, and/or derivatives or modifications of code originating from the software program "Popper." Popper is Copyright ©1989-1991 The Regents of the University of California. Popper was created by Austin Shelton, Information Systems and Technology, University of California, Berkeley.

Permission from the Regents of the University of California to use, copy, modify, and distribute the "Popper" software contained herein for any purpose, without fee, and without a written agreement is hereby granted, provided that the above copyright notice and this paragraph and the following two paragraphs appear in all copies. HOWEVER, ADDITIONAL PERMISSIONS MAY BE NECESSARY FROM OTHER PERSONS OR ENTITIES, TO USE DERIVATIVES OR MODIFICATIONS OF POPPER.

IN NO EVENT SHALL THE UNIVERSITY OF CALIFORNIA BE LIABLE TO ANY PARTY FOR DIRECT, INDIRECT, SPECIAL, INCIDENTAL, OR CONSEQUENTIAL DAMAGES, INCLUDING LOST PROFITS, ARISING OUT OF THE USE OF THE POPPER SOFTWARE, OR ITS DERIVATIVES OR MODIFICATIONS, AND ITS DOCUMENTATION, EVEN IF THE UNIVERSITY OF CALIFORNIA HAS BEEN ADVISED OF THE POSSIBILITY OF SUCH DAMAGE.

THE UNIVERSITY OF CALIFORNIA SPECIFICALLY DISCLAIMS ANY WARRANTIES, INCLUDING, BUT NOT LIMITED TO, THE IMPLIED WARRANTIES OF MERCHANTABILITY AND FITNESS FOR A PARTICULAR PURPOSE. THE POPPER SOFTWARE PROVIDED HEREUNDER IS ON AN "AS IS" BASIS, AND THE UNIVERSITY OF CALIFORNIA HAS NO OBLIGATIONS TO PROVIDE MAINTENANCE, SUPPORT, UPDATES, ENHANCEMENTS, OR MODIFICATIONS.

Copyright © 1983 The Regents of the University of California.

Redistribution and use in source and binary forms are permitted provided that the above copyright notice and this paragraph are duplicated in all such forms and that any documentation, advertising materials, and other materials related to such distribution and use acknowledge that the software was developed by the University of California, Berkeley. The name of the University may not be used to endorse or promote products derived from this software without specific prior

written permission. THIS SOFTWARE IS PROVIDED ``AS IS" AND WITHOUT ANY EXPRESS OR IMPLIED WARRANTIES, INCLUDING, WITHOUT LIMITATION, THE IMPLIED WARRANTIES OF MERCHANTABILITY AND FITNESS FOR A PARTICULAR PURPOSE.

Copyright © 1991, 1993 The Regents of the University of California.

Redistribution and use in source and binary forms, with or without modification, are permitted provided that the following conditions are met:

1. Redistributions of source code must retain the above copyright notice, this list of conditions and the following disclaimer.
2. Redistributions in binary form must reproduce the above copyright notice, this list of conditions and the following disclaimer in the documentation and/or other materials provided with the distribution.
3. All advertising materials mentioning features or use of this software must display the following acknowledgment:
This product includes software developed by the University of California, Berkeley and its contributors.
4. Neither the name of the University nor the names of its contributors may be used to endorse or promote products derived from this software without specific prior written permission.

THIS SOFTWARE IS PROVIDED BY THE REGENTS AND CONTRIBUTORS ``AS IS" AND ANY EXPRESS OR IMPLIED WARRANTIES, INCLUDING, BUT NOT LIMITED TO, THE IMPLIED WARRANTIES OF MERCHANTABILITY AND FITNESS FOR A PARTICULAR PURPOSE ARE DISCLAIMED. IN NO EVENT SHALL THE REGENTS OR CONTRIBUTORS BE LIABLE FOR ANY DIRECT, INDIRECT, INCIDENTAL, SPECIAL, EXEMPLARY, OR CONSEQUENTIAL DAMAGES (INCLUDING, BUT NOT LIMITED TO, PROCUREMENT OF SUBSTITUTE GOODS OR SERVICES; LOSS OF USE, DATA, OR PROFITS; OR BUSINESS INTERRUPTION) HOWEVER CAUSED AND ON ANY THEORY OF LIABILITY, WHETHER IN CONTRACT, STRICT LIABILITY, OR TORT (INCLUDING NEGLIGENCE OR OTHERWISE) ARISING IN ANY WAY OUT OF THE USE OF THIS SOFTWARE, EVEN IF ADVISED OF THE POSSIBILITY OF SUCH DAMAGE.

Copyright © 1990 by the Massachusetts Institute of Technology

Export of this software from the United States of America may require a specific license from the United States Government. It is the responsibility of any person or organization contemplating export to obtain such a license before exporting.

WITHIN THAT CONSTRAINT, permission to use, copy, modify, and distribute this software and its documentation for any purpose and without fee is hereby granted, provided that the above copyright notice appear in all copies and that both that copyright notice and this permission notice appear in supporting documentation, and that the name of M.I.T. not be used in advertising or publicity pertaining to distribution of the software without specific, written prior permission. Furthermore if you modify this software you must label your software as modified software and not distribute it in such a fashion that it might be confused with the original M.I.T. software. M.I.T. makes no representations about the suitability of this software for any purpose. It is provided "as is" without express or implied warranty.

Copyright © 1998 by the FundsXpress, INC.

Export of this software from the United States of America may require a specific license from the United States Government. It is the responsibility of any person or organization contemplating export to obtain such a license before exporting.

WITHIN THAT CONSTRAINT, permission to use, copy, modify, and distribute this software and its documentation for any purpose and without fee is hereby granted, provided that the above copyright notice appear in all copies and that both that copyright notice and this permission notice appear in supporting documentation, and that the name of FundsXpress not be used in advertising or publicity pertaining to distribution of the software without specific, written prior permission. FundsXpress makes no representations about the suitability of this software for any purpose. It is provided "as is" without express or implied warranty.

THIS SOFTWARE IS PROVIDED ``AS IS" AND WITHOUT ANY EXPRESS OR IMPLIED WARRANTIES, INCLUDING, WITHOUT LIMITATION, THE IMPLIED WARRANTIES OF MERCHANTABILITY AND FITNESS FOR A PARTICULAR PURPOSE.

Copyright © 1999, 2000 Internet Software Consortium.

Permission to use, copy, modify, and distribute this software for any purpose with or without fee is hereby granted, provided that the above copyright notice and this permission notice appear in all copies.

THE SOFTWARE IS PROVIDED "AS IS" AND INTERNET SOFTWARE CONSORTIUM DISCLAIMS ALL WARRANTIES WITH REGARD TO THIS SOFTWARE INCLUDING ALL IMPLIED WARRANTIES OF MERCHANTABILITY AND FITNESS. IN NO EVENT SHALL INTERNET SOFTWARE CONSORTIUM BE LIABLE FOR ANY SPECIAL, DIRECT, INDIRECT, OR CONSEQUENTIAL DAMAGES OR ANY DAMAGES WHATSOEVER RESULTING FROM LOSS OF USE, DATA OR PROFITS, WHETHER IN AN ACTION OF CONTRACT, NEGLIGENCE OR OTHER TORTIOUS ACTION, ARISING OUT OF OR IN CONNECTION WITH THE USE OR PERFORMANCE OF THIS SOFTWARE.

Copyright © 1995-1998 Eric Young (eay@cryptsoft.com)

This package is an SSL implementation written by Eric Young (eay@cryptsoft.com). The implementation was written so as to conform with Netscape's SSL.

This library is free for commercial and non-commercial use as long as the following conditions are adhered to. The following conditions apply to all code found in this distribution, be it the RC4, RSA, lhash, DES, etc., code; not just the SSL code. The SSL documentation included with this distribution is covered by the same copyright terms except that the holder is Tim Hudson (tjh@cryptsoft.com).

Copyright remains Eric Young's, and as such any Copyright notices in the code are not to be removed. If this package is used in a product, Eric Young should be given attribution as the author of the parts of the library used. This can be in the form of a textual message at program startup or in documentation (online or textual) provided with the package.

Redistribution and use in source and binary forms, with or without modification, are permitted provided that the following conditions are met:

1. Redistributions of source code must retain the copyright notice, this list of conditions and the following disclaimer.

2. Redistributions in binary form must reproduce the above copyright notice, this list of conditions and the following disclaimer in the documentation and/or other materials provided with the distribution.
3. All advertising materials mentioning features or use of this software must display the following acknowledgment: "This product includes cryptographic software written by Eric Young (eay@cryptsoft.com)". The word 'cryptographic' can be left out if the routines from the library being used are not cryptographic related.
4. If you include any Windows specific code (or a derivative thereof) from the apps directory (application code) you must include acknowledgment:
"This product includes software written by Tim Hudson (tjh@cryptsoft.com)"

THIS SOFTWARE IS PROVIDED BY ERIC YOUNG ``AS IS" AND ANY EXPRESS OR IMPLIED WARRANTIES, INCLUDING, BUT NOT LIMITED TO, THE IMPLIED WARRANTIES OF MERCHANTABILITY AND FITNESS FOR A PARTICULAR PURPOSE ARE DISCLAIMED. IN NO EVENT SHALL THE AUTHOR OR CONTRIBUTORS BE LIABLE FOR ANY DIRECT, INDIRECT, INCIDENTAL, SPECIAL, EXEMPLARY, OR CONSEQUENTIAL DAMAGES (INCLUDING, BUT NOT LIMITED TO, PROCUREMENT OF SUBSTITUTE GOODS OR SERVICES; LOSS OF USE, DATA, OR PROFITS; OR BUSINESS INTERRUPTION) HOWEVER CAUSED AND ON ANY THEORY OF LIABILITY, WHETHER IN CONTRACT, STRICT LIABILITY, OR TORT (INCLUDING NEGLIGENCE OR OTHERWISE) ARISING IN ANY WAY OUT OF THE USE OF THIS SOFTWARE, EVEN IF ADVISED OF THE POSSIBILITY OF SUCH DAMAGE.

The license and distribution terms for any publicly available version or derivative of this code cannot be changed. i.e. this code cannot simply be copied and put under another distribution license [including the GNU Public License.]

This product includes cryptographic software written by Eric Young.

Copyright © 1999, 2000 Internet Software Consortium.

Permission to use, copy, modify, and distribute this software for any purpose with or without fee is hereby granted, provided that the above copyright notice and this permission notice appear in all copies.

THE SOFTWARE IS PROVIDED "AS IS" AND INTERNET SOFTWARE CONSORTIUM DISCLAIMS ALL WARRANTIES WITH REGARD TO THIS SOFTWARE INCLUDING ALL IMPLIED WARRANTIES OF MERCHANTABILITY AND FITNESS. IN NO EVENT SHALL INTERNET SOFTWARE CONSORTIUM BE LIABLE FOR ANY SPECIAL, DIRECT, INDIRECT, OR CONSEQUENTIAL DAMAGES OR ANY DAMAGES WHATSOEVER RESULTING FROM LOSS OF USE, DATA OR PROFITS, WHETHER IN AN ACTION OF CONTRACT, NEGLIGENCE OR OTHER TORTIOUS ACTION, ARISING OUT OF OR IN CONNECTION WITH THE USE OR PERFORMANCE OF THIS SOFTWARE.

Copyright © 2004 IBM Corporation and its licensors, including Sendmail, Inc., and the Regents of the University of California.

Copyright © 1999,2000,2001 Compaq Computer Corporation

Copyright © 1999,2000,2001 Hewlett-Packard Company

Copyright © 1999,2000,2001 IBM Corporation

Copyright © 1999,2000,2001 Hummingbird Communications Ltd.

Copyright © 1999,2000,2001 Silicon Graphics, Inc.

Copyright © 1999,2000,2001 Sun Microsystems, Inc.

Copyright © 1999,2000,2001 The Open Group

Permission is hereby granted, free of charge, to any person obtaining a copy of this software and associated documentation files (the "Software"), to deal in the Software without restriction, including without limitation the rights to use, copy, modify, merge, publish, distribute, and/or sell copies of the Software, and to permit persons to whom the Software is furnished to do so, provided that the above copyright notice(s) and this permission notice appear in all copies of the Software and that both the above copyright notice(s) and this permission notice appear in supporting documentation.

THE SOFTWARE IS PROVIDED "AS IS", WITHOUT WARRANTY OF ANY KIND, EXPRESS OR IMPLIED, INCLUDING BUT NOT LIMITED TO THE WARRANTIES OF MERCHANTABILITY, FITNESS FOR A PARTICULAR PURPOSE AND NONINFRINGEMENT OF THIRD PARTY RIGHTS. IN NO EVENT SHALL THE COPYRIGHT HOLDER OR HOLDERS INCLUDED IN THIS NOTICE BE LIABLE FOR ANY CLAIM, OR ANY SPECIAL INDIRECT OR CONSEQUENTIAL DAMAGES, OR ANY DAMAGES WHATSOEVER RESULTING FROM LOSS OF USE, DATA OR PROFITS, WHETHER IN AN ACTION OF CONTRACT, NEGLIGENCE OR OTHER TORTIOUS ACTION, ARISING OUT OF OR IN CONNECTION WITH THE USE OR PERFORMANCE OF THIS SOFTWARE.

Except as contained in this notice, the name of a copyright holder shall not be used in advertising or otherwise to promote the sale, use or other dealings in this Software without prior written authorization of the copyright holder.

X Window System is a trademark of The Open Group.

If you are viewing this information softcopy, the photographs and color illustrations may not appear.

You can obtain softcopy from the z/OS Collection (SK3T-4269), which contains BookManager and PDF formats.

Minimum supported hardware

The minimum supported hardware for z/OS releases identified in z/OS announcements can subsequently change when service for particular servers or devices is withdrawn. Likewise, the levels of other software products supported on a particular release of z/OS are subject to the service support lifecycle of those products. Therefore, z/OS and its product publications (for example, panels, samples, messages, and product documentation) can include references to hardware and software that is no longer supported.

- For information about software support lifecycle, see: <http://www-01.ibm.com/software/support/systemsz/lifecycle/>
- For information about currently-supported IBM hardware, contact your IBM representative.

Policy for unsupported hardware

Various z/OS elements, such as DFSMS, HCD, JES2, JES3, and MVS, contain code that supports specific hardware servers or devices. In some cases, this device-related element support remains in the product even after the hardware devices pass their announced End of Service date. z/OS continue to service element code; however, it will not provide service related to unsupported hardware devices. Software problems related to these devices will not be accepted for service, and current service activity will cease if a problem is determined to be associated with out-of-support devices. In such cases, fixes will not be issued.

Trademarks

IBM, the IBM logo, and ibm.com[®] are trademarks or registered trademarks of International Business Machines Corp., registered in many jurisdictions worldwide. Other product and service names might be trademarks of IBM or other companies. A current list of IBM trademarks is available on the web at Copyright and trademark information at www.ibm.com/legal/copytrade.shtml.

Intel is a registered trademark of Intel Corporation or its subsidiaries in the United States and other countries.

Java[™] and all Java-based trademarks are trademarks or registered trademarks of Oracle and/or its affiliates.

Linux is a registered trademark of Linus Torvalds in the United States, other countries, or both.

Microsoft, Windows, and Windows NT are trademarks of Microsoft Corporation in the United States, other countries, or both.

Adobe and PostScript are either registered trademarks or trademarks of Adobe Systems Incorporated in the United States, and/or other countries.

UNIX is a registered trademark of The Open Group in the United States and other countries.

Other product and service names might be trademarks of IBM or other companies.

Bibliography

This bibliography contains descriptions of the documents in the z/OS Communications Server library.

z/OS Communications Server documentation is available in the following forms:

- Online at the z/OS Internet Library web page at www.ibm.com/systems/z/os/zos/bkserv/
- In softcopy on CD-ROM collections. See “Softcopy information” on page xvii.

z/OS Communications Server library updates

An index to z/OS Communications Server book updates is at <http://www.ibm.com/support/docview.wss?uid=swg21178966>. Updates to documents are also available on RETAIN[®] and in information APARs (info APARs). Go to <http://www.ibm.com/software/network/commserver/zos/support> to view information APARs. In addition, Info APARs for z/OS documents are in *z/OS and z/OS.e DOC APAR and PTF ++HOLD Documentation*, which can be found at http://publibz.boulder.ibm.com/cgi-bin/bookmgr_OS390/Shelves/ZDOCAPAR.

z/OS Communications Server information

z/OS Communications Server product information is grouped by task in the following tables.

Planning

Title	Number	Description
z/OS Communications Server: New Function Summary	GC27-3664	This document is intended to help you plan for new IP or SNA function, whether you are migrating from a previous version or installing z/OS for the first time. It summarizes what is new in the release and identifies the suggested and required modifications needed to use the enhanced functions.
z/OS Communications Server: IPv6 Network and Application Design Guide	SC27-3663	This document is a high-level introduction to IPv6. It describes concepts of z/OS Communications Server's support of IPv6, coexistence with IPv4, and migration issues.

Resource definition, configuration, and tuning

Title	Number	Description
z/OS Communications Server: IP Configuration Guide	SC27-3650	This document describes the major concepts involved in understanding and configuring an IP network. Familiarity with the z/OS operating system, IP protocols, z/OS UNIX System Services, and IBM Time Sharing Option (TSO) is recommended. Use this document with the z/OS Communications Server: IP Configuration Reference.

Title	Number	Description
z/OS Communications Server: IP Configuration Reference	SC27-3651	This document presents information for people who want to administer and maintain IP. Use this document with the z/OS Communications Server: IP Configuration Guide. The information in this document includes: <ul style="list-style-type: none"> • TCP/IP configuration data sets • Configuration statements • Translation tables • Protocol number and port assignments
z/OS Communications Server: SNA Network Implementation Guide	SC27-3672	This document presents the major concepts involved in implementing an SNA network. Use this document with the z/OS Communications Server: SNA Resource Definition Reference.
z/OS Communications Server: SNA Resource Definition Reference	SC27-3675	This document describes each SNA definition statement, start option, and macroinstruction for user tables. It also describes NCP definition statements that affect SNA. Use this document with the z/OS Communications Server: SNA Network Implementation Guide.
z/OS Communications Server: SNA Resource Definition Samples	SC27-3676	This document contains sample definitions to help you implement SNA functions in your networks, and includes sample major node definitions.
z/OS Communications Server: IP Network Print Facility	SC27-3658	This document is for systems programmers and network administrators who need to prepare their network to route SNA, JES2, or JES3 printer output to remote printers using TCP/IP Services.

Operation

Title	Number	Description
z/OS Communications Server: IP User's Guide and Commands	SC27-3662	This document describes how to use TCP/IP applications. It contains requests with which a user can log on to a remote host using Telnet, transfer data sets using FTP, send and receive electronic mail, print on remote printers, and authenticate network users.
z/OS Communications Server: IP System Administrator's Commands	SC27-3661	This document describes the functions and commands helpful in configuring or monitoring your system. It contains system administrator's commands, such as TSO NETSTAT, PING, TRACERTE and their UNIX counterparts. It also includes TSO and MVS commands commonly used during the IP configuration process.
z/OS Communications Server: SNA Operation	SC27-3673	This document serves as a reference for programmers and operators requiring detailed information about specific operator commands.
z/OS Communications Server: Quick Reference	SC27-3665	This document contains essential information about SNA and IP commands.

Customization

Title	Number	Description
z/OS Communications Server: SNA Customization	SC27-3666	This document enables you to customize SNA, and includes the following information: <ul style="list-style-type: none"> • Communication network management (CNM) routing table • Logon-interpret routine requirements • Logon manager installation-wide exit routine for the CLU search exit • TSO/SNA installation-wide exit routines • SNA installation-wide exit routines

Writing application programs

Title	Number	Description
z/OS Communications Server: IP Sockets Application Programming Interface Guide and Reference	SC27-3660	This document describes the syntax and semantics of program source code necessary to write your own application programming interface (API) into TCP/IP. You can use this interface as the communication base for writing your own client or server application. You can also use this document to adapt your existing applications to communicate with each other using sockets over TCP/IP.
z/OS Communications Server: IP CICS Sockets Guide	SC27-3649	This document is for programmers who want to set up, write application programs for, and diagnose problems with the socket interface for CICS using z/OS TCP/IP.
z/OS Communications Server: IP IMS Sockets Guide	SC27-3653	This document is for programmers who want application programs that use the IMS TCP/IP application development services provided by the TCP/IP Services of IBM.
z/OS Communications Server: IP Programmer's Guide and Reference	SC27-3659	This document describes the syntax and semantics of a set of high-level application functions that you can use to program your own applications in a TCP/IP environment. These functions provide support for application facilities, such as user authentication, distributed databases, distributed processing, network management, and device sharing. Familiarity with the z/OS operating system, TCP/IP protocols, and IBM Time Sharing Option (TSO) is recommended.
z/OS Communications Server: SNA Programming	SC27-3674	This document describes how to use SNA macroinstructions to send data to and receive data from (1) a terminal in either the same or a different domain, or (2) another application program in either the same or a different domain.
z/OS Communications Server: SNA Programmer's LU 6.2 Guide	SC27-3669	This document describes how to use the SNA LU 6.2 application programming interface for host application programs. This document applies to programs that use only LU 6.2 sessions or that use LU 6.2 sessions along with other session types. (Only LU 6.2 sessions are covered in this document.)
z/OS Communications Server: SNA Programmer's LU 6.2 Reference	SC27-3670	This document provides reference material for the SNA LU 6.2 programming interface for host application programs.
z/OS Communications Server: CSM Guide	SC27-3647	This document describes how applications use the communications storage manager.

Title	Number	Description
z/OS Communications Server: CMIP Services and Topology Agent Guide	SC27-3646	This document describes the Common Management Information Protocol (CMIP) programming interface for application programmers to use in coding CMIP application programs. The document provides guide and reference information about CMIP services and the SNA topology agent.

Diagnosis

Title	Number	Description
z/OS Communications Server: IP Diagnosis Guide	GC27-3652	This document explains how to diagnose TCP/IP problems and how to determine whether a specific problem is in the TCP/IP product code. It explains how to gather information for and describe problems to the IBM Software Support Center.
z/OS Communications Server: ACF/TAP Trace Analysis Handbook	GC27-3645	This document explains how to gather the trace data that is collected and stored in the host processor. It also explains how to use the Advanced Communications Function/Trace Analysis Program (ACF/TAP) service aid to produce reports for analyzing the trace data information.
z/OS Communications Server: SNA Diagnosis Vol 1, Techniques and Procedures and z/OS Communications Server: SNA Diagnosis Vol 2, FFST Dumps and the VIT	GC27-3667 GC27-3668	These documents help you identify an SNA problem, classify it, and collect information about it before you call the IBM Support Center. The information collected includes traces, dumps, and other problem documentation.
z/OS Communications Server: SNA Data Areas Volume 1 and z/OS Communications Server: SNA Data Areas Volume 2	GC31-6852 GC31-6853	These documents describe SNA data areas and can be used to read an SNA dump. They are intended for IBM programming service representatives and customer personnel who are diagnosing problems with SNA.

Messages and codes

Title	Number	Description
z/OS Communications Server: SNA Messages	SC27-3671	This document describes the ELM, IKT, IST, IUT, IVT, and USS messages. Other information in this document includes: <ul style="list-style-type: none"> • Command and RU types in SNA messages • Node and ID types in SNA messages • Supplemental message-related information
z/OS Communications Server: IP Messages Volume 1 (EZA)	SC27-3654	This volume contains TCP/IP messages beginning with EZA.
z/OS Communications Server: IP Messages Volume 2 (EZB, EZD)	SC27-3655	This volume contains TCP/IP messages beginning with EZB or EZD.
z/OS Communications Server: IP Messages Volume 3 (EZY)	SC27-3656	This volume contains TCP/IP messages beginning with EZY.
z/OS Communications Server: IP Messages Volume 4 (EZZ, SNM)	SC27-3657	This volume contains TCP/IP messages beginning with EZZ and SNM.
z/OS Communications Server: IP and SNA Codes	SC27-3648	This document describes codes and other information that appear in z/OS Communications Server messages.

Index

A

- abend codes
 - USER777 130, 144
- accessibility 185
- adding records
 - specific broadcast routes 91
 - to the options file 81
 - to the routing file 89
- allocating space
 - for the options file 44
 - for the queue file 47
 - for the routing file 45
- APPL definition statement, VTAM 10, 26
- applications
 - CICS 7
 - IMS 7
 - VTAM 2
- authorized programs 23

B

- BIND parameter requirements 8
- brackets, EB 8

C

- capture points 2
- checklists
 - of customization tasks for JES users 152
 - of tasks for all users 149
- CICS 7
- CLASS parameter, JCL 6, 132
- CLUSTER parameter, VSAM DEFINE 44
- commands
 - LPR, TCP/IP 11, 44
 - MODIFY 128
- Communications Server for z/OS, online information xix
- configuring NPF
 - NPFJESALLOCATION statement 19
 - NPFPRINTPREFIX statement 18
 - NPFVTAMALLOCATION 19
 - TCPIP.DATA and NPF.DATA 16
- control blocks 8
- copying records
 - in the options file 82
 - in the routing file 92
 - specific broadcast routes 93
- creating files
 - options file 44
 - queue file 47
 - routing file 45
- creation date 98
- creation time 98

D

- data areas
 - Routing Data Area 153

- data set libraries
 - EZAPPFCA 138
 - EZAPPQSA 138
 - EZAPPQSB 138
- dataset status 98
- DATASETPREFIX statement 16
- DD statement 132
- def page format 87, 90
- default page format table 38
- default values for file creation macro 61
- DEFINE command, VSAM 44
- defining the NPF FSS writer 15, 23
 - options to set up 127
 - options to tailor 127
- definitions
 - APPL 10
 - FSS 15
 - resources 15
 - terminal 27, 131
 - typeterm 27
- delete confirmation 78
- deleting records
 - for specific broadcast routes 97
 - from the options file 85
 - from the routing file 95
- DEST parameter, JCL 6, 90, 98
- destinations, number of 87, 90
- diagrams
 - Network Print Facility Function Flow 4
- differences between SNA and TCP/IP print processing 9
- disability 185
- displaying queue records 100
- DNS, online information xx
- ds name 98
- DSECT
 - for the routing data 156

E

- EB 8
- emulation
 - SCS 159
- enabling the ISPF interface 69
- encryption 4, 9, 105, 106, 112
- end-of-files rules table 29
- environment, required for Network Print Facility 11
- eofile name 87, 90
- errors
 - PARSE 132
- examples
 - FSWTR definition 23
 - FSWTR procedure 126
 - input record exit 119
 - operator commands 130
 - options file allocation 44
 - queue file allocation 48
 - routing file allocation 46
 - starting the NPF FSS writer 23, 131
 - starting the NPF VTAM capture point application 131
 - starting the queue manager 138
 - when to use the EZAPPFL macro 53

EXEC statement, JCL 132
 exit routines 105
 exits
 general routing (EZAPPGR) 4, 106
 input record 112
 input record exit sample program 119
 specific broadcast routing 4, 109
 user-named 105
 EZAPDCP NPF ISPF Defaults panel 78
 EZAPDGP NPF Diagnosis Functions panel 79
 EZAPPEFM 30
 EZAPPEFT 30
 EZAPPFCA data set library 138
 EZAPPFL executable macro 51
 EZAPPFS FSS load module 23
 EZAPPGR general routing exit 106
 EZAPPMP Network Print Facility Primary Option Menu 77
 EZAPPN1 NPF Options Record Key Field panel (add) 81
 EZAPPN1 NPF Options Record Key Field panel (delete) 85
 EZAPPN1 NPF Options Record Key Field panel (edit) 84
 EZAPPN12 NPF Routing Record Key Field panel (copy) 92
 EZAPPN15 NPF Routing Record panel (add) 90
 EZAPPN15 NPF Routing Record panel (copy) 92
 EZAPPN15 NPF Routing Record panel (delete) 96
 EZAPPN15 NPF Routing Record panel (edit) 94
 EZAPPN23 NPF Routing Broadcast Record panel (add) 91
 EZAPPN23 NPF Routing Broadcast Record Update (edit) 95
 EZAPPN4 NPF Options Record Key Field panel (copy) 82
 EZAPPN7 NPF Options Record panel (add) 81
 EZAPPN7 NPF Options Record panel (copy) 83
 EZAPPN7 NPF Options Record panel (delete) 86
 EZAPPN7 NPF Options Record panel (edit) 84
 EZAPPN9 NPF Routing Record Key Field panel (add) 89
 EZAPPN9 NPF Routing Record Key Field panel (delete) 95
 EZAPPN9 NPF Routing Record Key Field panel (edit) 93
 EZAPPCP NPF Printer Options Configuration panel 80
 EZAPPDF 38
 EZAPPRP NPF Printer Routing Configuration panel 87
 EZAPPQLP NPF Queue List panel 101
 EZAPPQRP NPF Queue Record panel 102
 EZAPPQSA Queue Manager data set library 138
 EZAPPQSB Queue Manager data set library 138
 EZAPPQSP NPF Queue Selection panel 100
 EZAPPRFX 16, 17, 18, 19
 EZY0837I message 29, 134, 145

F

facilities
 LPR/LPD 2
 SDSF 130
 file creation macro
 default values and required parameters 61
 FINAL function of the EZAPPFL macro 61
 flow diagrams
 Network Print Facility Function Flow 4
 FORMS parameter, JES 6
 FSA
 subtask 6
 FSI 7
 FSS
 (NPF FSS) writer 15, 127
 how to define 15
 JCL parameters for 126
 load module (EZAPPFS) 23
 sample definitions 23
 FSWTR procedure 127

G

general routing exit (EZAPPGR)
 parameter list 108
 return codes 109
 writing 106

H

high-level qualifier
 NPF 17, 18, 19
 TCP/IP 16, 17, 125
 used in examples 127, 132
 hold queue records 101
 hostname 98, 103

I

IBM Software Support Center, contacting xii
 IMBED parameter, VSAM DEFINE 44
 IMS 7
 INDEX parameter, VSAM DEFINE 44
 Information APARs xvii
 INITIAL function of the EZAPPFL macro 53
 input record exit
 in the options file 80
 parameter list 116
 return codes 118
 writing 112
 installing the Network Print Facility
 for JES output processing 22
 for VTAM output processing 24
 introduction 15
 overall installation information 15
 internet
 print functions 2
 routings 2
 internet name 87, 91
 Internet, finding z/OS information online xix
 IP address 98, 103
 ISPF
 dialog application 141
 interface 69
 Primary Option Menu 74
 starting an NPF ISPF interface session 76
 ISPF panels,
 EZAPDCP NPF ISPF Defaults 78
 EZAPDGP NPF Diagnosis Functions 79
 EZAPPMP Network Print Facility Primary Option
 Menu 77
 EZAPPN1 NPF Options Record Key Field (add) 81
 EZAPPN1 NPF Options Record Key Field (delete) 85
 EZAPPN1 NPF Options Record Key Field (edit) 84
 EZAPPN12 NPF Routing Record Key Field (copy) 92
 EZAPPN15 NPF Routing Record (add) 90
 EZAPPN15 NPF Routing Record (copy) 92
 EZAPPN15 NPF Routing Record (delete) 96
 EZAPPN15 NPF Routing Record (edit) 94
 EZAPPN23 NPF Routing Broadcast Record (add) 91
 EZAPPN23 Routing Broadcast Record (edit) 95
 EZAPPN4 NPF Options Record Key Field (copy) 82
 EZAPPN7 NPF Options Record (add) 81
 EZAPPN7 NPF Options Record (copy) 83
 EZAPPN7 NPF Options Record (delete) 85
 EZAPPN7 NPF Options Record (edit) 84
 EZAPPN9 NPF Routing Record Key Field (add) 89
 EZAPPN9 NPF Routing Record Key Field (delete) 95

ISPF panels, (continued)

- EZAPPN9 NPF Routing Record Key Field (edit) 93
- EZAPPPCP NPF Printer Options Configuration 80
- EZAPPPRP NPF Printer Routing Configuration 87
- EZAPPQLP NPF Queue List 101
- EZAPPQRP NPF Queue Record 102
- EZAPPQSP NPF Queue Selection 100

ISR@PRIM 74

J

JCL

- CLASS subparameter 90
- DEST parameter 90
- EXEC statement 126

JES

- F,U,J=jobnumber,Q=HOLD,NQ=WTR command 130
- I,J=jobname command 130
- JES2 1, 23, 131
- JES3 1, 23, 130, 131
- NPF FSS writer 7
- output processing 22
- planning considerations 12
- SYSOUT 7
- writer 126
- WTR 23

JES queues

- HOLD 130

JES2 exit 23 13

JES3 exit 45 13

JESNEWS 23

jobname 98

JSPA 13

K

key fields

- major name 87, 90
- minor name 87, 90
- option name 80

key-sequenced data set, VSAM 43

keyboard 185

L

license, patent, and copyright information 189

load modules

- FSS (EZAPPPS) 23

log file 48, 145

logging 48, 145

logical printers

- JES 7, 23
- VTAM 26

LPD

- description 2
- options 11

LPR 1

- options 80, 81, 82, 84
- print queue 6

LPR/LPD facility

- description 2
- environment 11

LU types 1

LU-LU session 2

LUCLASS subparameter, VTAM 26

LUCLASS, ISPF input field 87, 90

M

macros

- executable 51
- EZAPPPDPF, page format 38
- EZAPPEFM, end-of-file 29, 30
- file load macro interface (EZAPPFL) 51, 107
- FINAL function 61
- INITIAL function 53
- NXDEST function 59
- OPEN ACB 10
- OPTIONS function 59
- ROUTING function 54

mainframe

- education xvii

major name 87, 90

major Network Print Facility concepts 2

managing the print queue 97

MAXFLSTG subparameter, VTAM 25, 133

MAXOPEN subparameter, VTAM 25, 133

menus

- Primary Option, ISPF 74
- Primary Option, Network Print Facility 76

message library (EZAMENU) 70

minor name 87, 90

MODIFY command 128

modifying

- the ISPF Primary Option menu 12
- the NPF VTAM capture point 133

N

names

- LUNAMES 2
- major 11
- minor 11
- printer, TCP/IP 10

Network Print Facility

- flow 4
- function flow diagram 4
- highlights 1
- installing 15
- major concepts 2
- overview 1
- planning 11
- Primary Option Menu 76
- required environment 11
- tailoring 105

Network Print Facility configuration statements

- NPFJESALLOCATION 19
- NPFPRINTPREFIX 18
- NPFVTAMALLOCATION 19

networks

- SNA 9

no of dest 87, 90

NPF Diagnosis Functions 79

NPF ISPF Defaults panel 78

NPF Options Record Key Field panel (add) 81

NPF Options Record Key Field panel (copy) 84

NPF Options Record Key Field panel (delete) 82

NPF Options Record Key Field panel (edit) 85

NPF Options Record panel (add) 81

NPF Options Record panel (copy) 83

NPF Options Record panel (delete) 86

NPF Options Record panel (edit) 84

NPF Printer Options Configuration panel 80

NPF Printer Routing Configuration panel 87

- NPF Queue List panel 101
- NPF Queue Record panel 102
- NPF Queue Selection panel 100
- NPF Routing Broadcast Record panel (add) 91
- NPF Routing Broadcast Record panel (edit) 95
- NPF Routing Record Key Field panel (add) 89
- NPF Routing Record Key Field panel (copy) 92
- NPF Routing Record Key Field panel (delete) 95
- NPF Routing Record Key Field panel (edit) 93
- NPF Routing Record panel (add) 90
- NPF Routing Record panel (copy) 92
- NPF Routing Record panel (delete) 96
- NPF Routing Record panel (edit) 94
- NPFINIT CLIST 71
- NXTDTEXT function of the EZAPPFL macro 59

O

- OPEN ACB macro, VTAM 10
- options file
 - adding records 81
 - allocating space 44
 - copying records 82
 - creating 44
 - deleting records 85
 - input fields 44, 80
 - setting up 43
 - understanding 43
 - updating records 84
- OPTIONS function of the EZAPPFL macro 59
- options name 80, 87, 90
- options, LPR 80, 81, 82, 84
- output processing
 - JES 22
 - VTAM 24
- overview 1

P

- page format table 38
- panel library (SEZAPENU) 70
- parameter libraries (parmlibs) 23, 27
- parameters, general routing exit 108
- parameters, input record exit 116
- parameters, JCL
 - CLASS 6
 - DEST 6
 - FORMS 6
 - PARM 26, 127
- parameters, specific routing exit 111
- parameters, VSAM DEFINE 44
- parameters, VTAM
 - BIND 8
 - LUNAME 46
- PARSE error 132
- planning for Network Print Facility
 - consistent definition 13, 26
 - introduction 11
 - JES considerations 12
 - required environment 11
 - VTAM considerations 13
- PLU 98
- PPT 23, 27
- prerequisite information xvii
- print options 98, 103
- print processing, differences between SNA and TCP/IP 9

- printer classes 13, 26
- printer destination 3, 6
- printer emulation
 - SCS 159
- printer name 87, 91, 98, 103
- problem diagnosis
 - SNA-network 10
 - TCP/IP-network 10
- processing VTAM output files 8
- profiles
 - FM Profile 8
 - TS Profile 8

Q

- QSAM files 10
- queue file
 - allocating space 47
 - creating 47
 - displaying records 99
 - input fields 98
 - selecting records 100
 - understanding 47
 - updating records 102, 141
 - viewing records 102, 141
- queue file records
 - browse 101
 - delete 101
 - edit 101
 - hold 101
 - refresh list 101
 - reset 101
- queue management 97
- queue manager 97
- QUIT 136
- QUIT FORCE 137

R

- RACF security 11
- records
 - routing file 46
- refresh queue list 102
- region size calculation 25
- required environment 11
- reset queue records 101
- resources, definition of 13
- retain parameter 56
- retain time, successful 87, 98, 103
- retain time, unsuccessful 87, 98, 103
- retry attempts 98, 103
- retry interval 98, 103
- retry limit 87
- retry parameter 56
- retry time 87
- return codes
 - general routing exit 109
 - input record exit 118
 - specific routing exit 111
- RFC (request for comments) 161
 - accessing online xix
- routines
 - exit 105
- routing
 - data area 153
 - normal 45

- routing (*continued*)
 - optional installation-defined 106
 - specific broadcast 45
 - to specific destinations 91
- routing exit 87
- routing file
 - adding records 89
 - allocating space 45
 - copying records 92
 - creating 45
 - deleting records 95
 - input fields 46, 87
 - setting up 44
 - understanding 44
 - updating records 93
- ROUTING function of the EZAPPFL macro 54

S

- samples
 - add routing and options records with EZAPPFL macro 66
 - deallocate and allocate the NPF files 62
 - default page format table (EZAPPDPF) macro use 40
 - end-of-file rules (EZAPPEFM) macro use 34
 - EZAPPAAA (VTAM start) 131
 - FSWTR (JES start) 126
 - initialize and load records with EZAPPFL macro 64
 - input record exit 119
 - queue manager start 138
- SCS
 - DBCS control table 159
 - SBCS control table 159
- SDSF 130
- security, file access 11
- SESSLIM parameter 9, 27
- SEZAMENU message library 70
- SEZAPENU panel library 70
- shortcut keys 185
- SLU 98
- SNA
 - network 10
 - network printers 10
 - print processing, differences between TCP/IP and SNA 9
 - session protocols 8
- SNAP file for VTAM capture point 48
- softcopy information xvii
- specific broadcast routes
 - adding records 91
 - copying records 93
 - deleting records 97
 - updating records 95
- specific broadcast routing 55
- specific routing exit
 - parameter list 111
 - return codes 111
 - writing 109
- Spool Display and Search Facility (SDSF) 130
- starting
 - EZAPPQSA 138
 - NPF ISPF interface session 76
 - the NPF FSS writer 126
 - the NPF VTAM capture point application 131
 - the queue manager 138
- statements
 - APPL definition, VTAM 9
 - DATASETPREFIX 16
 - DD 26

- statements (*continued*)
 - example 17
 - EXEC, JCL 132
 - Network Print Facility configuration 16
 - NPFJESALLOCATION 19
 - NPFPRINTPREFIX 18
 - NPFVTAMALLOCATION 19
 - STEPLIB 29, 38
 - TCP/IP configuration 16
 - TCPIPJOBNAME 16
- STEPLIB JCL for user modification 29, 38
- subparameters, JCL EXEC PARM
 - LUCLASS 26, 133
 - MAXFLSTG 25, 26, 133
 - MAXOPEN 25, 26, 133
- syntax diagram, how to read xviii
- SYSOUT, JES 7

T

- tables
 - default page format 38
 - end-of-files rules 30
 - Program Properties 23
- tables modified by STEPLIB 29, 38
- TCP/IP
 - online information xix
 - protocol specifications 161
- TCP/IP configuration statements 16
- TCP/IP print processing, differences between SNA and 9
- TCPIPJOBNAME statement 16
- Technotes xvii
- tracing
 - NPF ISPF trace options 144
 - NPF VTAM capture point trace 48, 134, 145
- trademark information 197
- TSO logon procedure 70

U

- understanding files
 - the options file 43
 - the queue file 47
 - the routing file 44
- updating records
 - in the options file 84
 - in the queue file 102, 141
 - in the routing file 93
 - specific broadcast routes 95
- user exits 3, 105
- user-named exit 106
- USER777 abend code 130, 144
- using
 - the EZAPPFL executable macro 51
 - the Network Print Facility Primary Option Menu 76

V

- viewing records
 - in the queue file 102, 141
- VSAM
 - APPL definition 9
 - CLUSTER parameter 44
 - DATA parameter 44
 - DEFINE command 44
 - file creation specifications 51

VSAM (*continued*)
key-sequenced data set 43
options file 43
queue file 47
routing file 45
VTAM
APPL statement 10
applications 2
LU name usage 45
output processing 24
planning considerations 13
VTAM, online information xix

W

writer
JES 2
NPF FSS 15, 23
writing
exit routines to tailor Network Print Facility 105
the general routing exit 106
the input record exit 112
the specific routing exit 109

Z

z/OS Basic Skills Information Center xvii
z/OS, documentation library listing 199

Communicating your comments to IBM

If you especially like or dislike anything about this document, use one of the methods listed below to send your comments to IBM. Whichever method you choose, make sure you send your name, address, and telephone number if you would like a reply.

Feel free to comment on specific errors or omissions, accuracy, organization, subject matter, or completeness of this document. However, the comments you send should pertain to only the information in this manual and the way in which the information is presented. To request additional publications, or to ask questions or make comments about the functions of IBM products or systems, you should talk to your IBM representative or to your IBM authorized remarketer.

When you send comments to IBM, you grant IBM a nonexclusive right to use or distribute your comments in any way it believes appropriate without incurring any obligation to you.

Send your comments to us in any of the following ways:

- To send comments by FAX, use this number: 1+919-254-1258
- To send comments electronically, use this address:
 - comsvrcf@us.ibm.com
- To send comments by post, use this address:

International Business Machines Corporation
Attn: z/OS Communications Server Information Development
P.O. Box 12195, 3039 Cornwallis Road
Department AKCA, Building 501
Research Triangle Park, North Carolina 27709-2195

Make sure to include the following information in your note:

- Title and publication number of this document
- Page number or topic to which your comment applies



Product Number: 5650-ZOS

Printed in USA

SC27-3658-00

