

IBM i  
7.2

*Troubleshooting*

**IBM**

**Note**

Before using this information and the product it supports, read the information in [“Notices” on page 77.](#)

This edition applies to IBM i 7.2 (product number 5770-SS1) and to all subsequent releases and modifications until otherwise indicated in new editions. This version does not run on all reduced instruction set computer (RISC) models nor does it run on CISC models.

This document may contain references to Licensed Internal Code. Licensed Internal Code is Machine Code and is licensed to you under the terms of the IBM License Agreement for Machine Code.

© **Copyright International Business Machines Corporation 1999, 2013.**

US Government Users Restricted Rights – Use, duplication or disclosure restricted by GSA ADP Schedule Contract with IBM Corp.

---

# Contents

<b>Troubleshooting.....</b>	<b>1</b>
PDF file for Troubleshooting.....	1
How your system manages problems.....	1
Detecting problems.....	2
System reference codes.....	2
Messages.....	3
Message queues.....	3
Logs.....	3
Watch for event function.....	4
Commands and APIs about watch for event function.....	4
Scenario: Using the watch for event function with an exit program.....	5
Starting a watch session.....	6
Ending a watch session.....	7
Displaying details of watch sessions.....	7
Scenario: Exit program for Watch for Event.....	10
Analyzing and handling problems.....	11
Problem analysis procedures.....	12
Starting problem analysis.....	12
Collecting system reference codes.....	15
Symptom and recovery actions.....	16
Recovering from a system power problem.....	17
Recovering when the Operations Console remote control panel feature is not working correctly.....	17
Recovering when the control panel push buttons or lights are not working correctly.....	18
Recovering from IPL or system failures.....	18
Recovering from a workstation failure.....	19
Recovering from a tape or optical device problem.....	19
Recovering from a disk or disk drive problem.....	20
Recovering from a communications problem.....	20
Recovering from system hang or loop condition.....	20
Recovering from an intermittent problem.....	20
Recovering when the console does not vary on.....	21
System reference code list.....	21
Performing a main storage dump.....	34
Performing an automatic main storage dump.....	34
Performing a manual main storage dump.....	34
Performing a manual main storage dump on a logical partition.....	35
Copying a current main storage dump.....	35
Reporting a main storage dump.....	36
Deleting a main storage dump.....	36
CL commands for problem analysis.....	37
Problem-handling menus.....	37
Using authorized program analysis reports.....	38
Reporting problems overview.....	39
Gathering information with the problem summary form.....	40
Problem summary form for single partition (model 270 and 8xx).....	40
Problem summary form for single partition (on models other than 270 and 8xx).....	41
Problem summary form for multiple partitions (model 8xx).....	42
Problem summary form for multiple partitions (on models other than 8xx).....	43
Contacting IBM support.....	44
Reporting problems detected by the system.....	45

Tracking problems.....	46
Querying problem status.....	46
Querying problem status using the QRYPRBSTS command.....	46
Querying problem status using the WRKPRB command.....	47
Finding a previously reported problem.....	47
Adding notes to a problem record.....	47
Reference information.....	48
Details: Messages.....	48
Types of messages.....	48
Error messages.....	49
Alerts.....	50
Managing messages.....	51
Displaying messages.....	51
Sending messages .....	53
Responding to messages.....	53
Removing messages .....	53
Printing messages.....	54
Details: Message queues.....	54
Types of message queues.....	54
Managing message queues.....	55
Creating message queues.....	56
Creating message queue QSYMSG for severe messages.....	57
Changing the attributes of message queues.....	57
Changing the message queue for a printer.....	57
Printing all messages in the message queue.....	58
Details: Logs.....	58
Job logs.....	58
Controlling the content of the job log.....	58
Displaying job logs.....	60
History logs.....	60
Displaying the list of history log files.....	60
Displaying the contents of the QHST history log.....	61
Problem logs.....	61
Printing error logs.....	61
Displaying error logs.....	61
Details: CL commands for problem handling.....	62
Using the Analyze Problem command.....	62
Analyzing a problem with OPENED status.....	63
Additional method to analyze a problem with OPENED status.....	63
Examples: The Analyze Problem command.....	63
Using the Verify Communications command.....	64
Examples: The Verify Communications command.....	64
Using the Verify Tape command.....	65
Using the Work with Alerts command.....	65
Example: The Work with Alerts command.....	66
Using the Work with Problems command.....	66
Examples: The Work with Problems command.....	66
Running the Work with Problems command.....	67
Using the Display Problems command.....	67
Using the Change Problem command.....	67
Using the Change Contact Information command.....	68
Details: Problem-handling menus.....	69
Using the NETPRB menu.....	69
Using the NETWORK menu.....	69
Using the PROBLEM menu.....	70
Using the PROBLEM2 menu.....	70
Using the TECHHELP menu.....	70
Using the USERHELP menu.....	71

Details: Authorized program analysis report.....	71
Determining the primary or alternative consoles.....	72
Replacing the battery power unit on models 5xx and expansion units FC 507x and FC 508x.....	73
Related information for Troubleshooting.....	75
<b>Notices.....</b>	<b>77</b>
Programming interface information.....	78
Trademarks.....	78



---

# Troubleshooting

When you have problems with the IBM® i products, read this topic collection to understand, analyze, and resolve these problems.

Sometimes you are able to resolve a problem on your own. Other times you need to gather information to help the service technicians resolve your problem in a timely manner.

**Note:** By using the code examples, you agree to the terms of the [“Code license and disclaimer information”](#) on page 75.

---

## PDF file for Troubleshooting

You can view and print a PDF file of this information.

To view or download the PDF version of this document, select [Troubleshooting](#) (about 880 KB).

### Saving PDF files

To save a PDF on your workstation for viewing or printing:

1. Right-click the PDF link in your browser.
2. Click the option that saves the PDF locally.
3. Navigate to the directory in which you want to save the PDF.
4. Click **Save**.

### Downloading Adobe Reader

You need Adobe Reader installed on your system to view or print these PDFs. You can download a free copy from the [Adobe Web site](http://www.adobe.com/products/acrobat/readstep.html) (www.adobe.com/products/acrobat/readstep.html) .

### Related reference

[Related information for Troubleshooting](#)

Product manuals, IBM Redbooks, Web sites, and other information center topic collections contain information that relates to the Troubleshooting topic collection. You can view or print any of the PDF files.

---

## How your system manages problems

You can use the problem-analysis functions that your system provides to manage both system-detected and user-defined problems. The structured problem management system helps you and your service provider quickly and accurately manage the problems when they occur on the system.

Your system provides functions for problem analysis, problem logging and tracking, problem reporting, and problem correction.

The following example illustrates the flow when handling a problem:

1. The system detects a hardware error.
2. An error notification is sent to the system.
3. A problem record with the configuration information, a system reference code, the name of the reporting device, and other information is created.
4. The error is recorded in the system error log.
5. A message is sent to the message queue of the system operator.
6. Problem analysis starts with the message.

The results of the problem analysis are automatically stored, along with the collected problem information. At this point, you can report the problem to your service provider.

### **Related concepts**

#### Analyzing and handling problems

If you are experiencing problems with your system, you need to gather further information to analyze and handle the problems. A start problem analysis procedure can guide you through resolving the problem.

#### Reporting problems overview

You need to know what information you should gather about the problem, how to report and track problems, and how to send a service request to IBM.

#### Detecting problems

You can detect whether problems have occurred on your system in several ways. Most of the time, you receive a message or a system reference code (SRC), which reports the problem that has been detected to you. You can also use the message queues and logs to gather more information.

## **Detecting problems**

---

You can detect whether problems have occurred on your system in several ways. Most of the time, you receive a message or a system reference code (SRC), which reports the problem that has been detected to you. You can also use the message queues and logs to gather more information.

### **Related concepts**

#### How your system manages problems

You can use the problem-analysis functions that your system provides to manage both system-detected and user-defined problems. The structured problem management system helps you and your service provider quickly and accurately manage the problems when they occur on the system.

## **System reference codes**

A *system reference code (SRC)* is a set of eight characters that identifies the name of the system component that detects the error codes and the reference code that describes the condition.

The first 4 characters of the SRC indicate the error type. The last 4 characters give additional information. In this document, each x of the xxxx that is shown as the last 4 characters of the SRC can be any number 0 through 9, or letter A through F.

When the system detects a problem, it displays an SRC on the system control panel. When you go through the following problem-analysis procedure, you can find out how to record the SRC on paper. The information gained from the SRC can help the hardware service provider better understand the problem and know how to fix it. Also, you might be able to find the SRC in the system reference code list to resolve it further on your own.

### **Examples: SRCs**

The following examples show SRCs that might occur as the result of an abnormal restart:

#### **Example 1**

Any B900xxxx SRC (where xxxx is any number or letter) during the start of the operating system phase of restart.

#### **Example 2**

A Power Down System (PWRDWN SYS) command that was not completed, ending with an SRC of B9003F10.



## Error codes

An *error code* is a group of characters or digits displayed on the console. Error codes are displayed in an error message, recorded in a problem log entry, or shown on the system control panel.

Error codes indicate that a hardware or software error condition has occurred on the system.

The system attention light is turned on when the system detects a hardware error it cannot correct. The error might result in data loss or corruption.

The error code recorded in the problem log is used to report errors and to perform problem analysis and resolution. Some error codes have the system automatically collect associated data used to diagnose the problem.

Some error codes require you to restart the system for recovery, whereas others might be handled and automatically recovered by the system.

### Related tasks

[System reference code list](#)

In these tables, locate the system reference code (SRC) that you have displayed. In the table, xxxx can be any number 0 through 9 or letter A through F.

## Messages

*Messages* are communications that are sent from one person or program to another. Whether you are a system operator or user, you can communicate on your system by sending and receiving messages. System programs use messages to communicate system conditions.

Your system sends informational and inquiry messages that provide you with important system information. Inquiry messages require you to respond. Informational messages allow you to keep track of system activities, jobs, users, and errors. Because messages provide information about your system, you should know how to handle messages when detecting and correcting problems.

You can display, send, respond to, remove, and print messages.

### Related concepts

[Details: Messages](#)

The details of messages, such as the types of messages and the ways to manage messages, can help you better understand and solve the problems that occur on your system.

## Message queues

A message queue is like a mail box for messages.

Your system has several message queues, which holds messages that provide helpful information when detecting and reporting problems. Understanding the location of history files, error messages, and system messages can help you solve problems, because they contain important system information.

You can create, change, and print message queues.

### Related concepts

[Details: Message queues](#)

You have different types of message queues to receive messages. You can manage the message queues in various ways.

## Logs

The IBM i licensed program records certain kinds of events and messages for use in diagnosing problems. A log is a special kind of database file that is used by the system to record this information.

The types of logs include:

### Job logs

Any job that runs on your system has a corresponding job log that records the job status and activities.

## History logs

History logs contain information about the operation of the system and about system status.

## Problem logs

Problem logs are useful for coordinating and tracking all your problem management operations.

## Related concepts

[Details: Logs](#)

Logs include job logs, history logs, and problem logs.

[Job logs and communication problems](#)

## Watch for event function

The watch for event function enhances your ability of detecting and reacting to problems. When specified messages, Licensed Internal Code log entries, or Product Activity Log entries occur, you are notified by calling a specified program to take the action you want.

## Commands and APIs about watch for event function

You can use CL commands and APIs to work with watches.

The following commands are used to work with the watch event function.

### Start Watch command

The Start Watch (STRWCH) command starts a watch session and notifies you when a specified message, a Licensed Internal Code log entry, or a Product Activity Log entry occurs. When the watched-for message is added to the specified message queue or log, or when the watched-for log entry is added, the exit program specified in the Watch program (WCHPGM) parameter is called. The watch session can be ended by the End Watch (ENDWCH) command or by the End Watch (QSCEWCH) API.

When you watch for messages, specify the message queue or job log where you expect the message to be sent. You can narrow the search by specifying a text string to be compared against the message data, against the From program, or against the To program of the watched-for message.

When you watch for Licensed Internal Code log entries, specify the Licensed Internal Code log major and minor codes. You can narrow the search by specifying a text string that is to be compared against:

- The number of the task dispatching element (TDE)
- The name of the task
- The type of server
- The name of the job
- The user name of the job
- The job number to further qualify the job name and user name of the job
- The thread identifier
- The exception identifier
- The LIC module name
- The LIC module replacement unit name
- The name of the entry point
- The byte offset into the LIC module text
- The timestamp of when the LIC module is compiled

When you watch for Product Activity Log entries, specify the particular system reference code (SRC) to be watched for. You can narrow the search by specifying a text string that is to be compared against:

- The name of the physical device that has the entry in the log
- The number or word that is used to identify a product

- The numbers or letters that are used to identify the feature level of a product with a given type

You can specify the priority of the job where the watch session is run. By default, a job priority of 25 is used.

## Work with Watches command

You can start a new watch or end an active watch with the Work with Watches (WRKWCH) command. With this command, you can also show a list of active watches on the system.

## End Watch command

The End Watch (ENDWCH) command ends a watch session that is started by the Start Watch (STRWCH) command or by the Start Watch (QSCSWCH) API. Watch sessions that are started by trace commands (such as STRTRC, TRCINT, TRCCNN, STRCMNTRC, TRCTCPAPP) are ended, but the associated trace remains active.

## Start Watch and End Watch APIs

The Start Watch (QSCSWCH) and End Watch (QSCEWCH) APIs are used in a similar way to the STRWCH and ENDWCH commands. The End Watch (QSCEWCH) API ends a watch session that was started by the STRWCH (Start Watch) command or by the Start Watch (QSCSWCH) API.

**Note:** Watch sessions started by trace commands (such as STRTRC, TRCINT, TRCCNN, STRCMNTRC, TRCTCPAPP) are ended but the associated trace remains active. A watch session can be ended by the same job that issues the start function or by a different job.

## Using the watch for event function with trace commands

Watch support enhances the trace functions by automatically monitoring and ending traces when certain predetermined criteria are met. This prevents the loss of valuable trace data and reduces the amount of time that you spend in monitoring traces.

### Related information

[Exit Program for Watch for Event](#)

[Start Watch \(STRWCH\) command](#)

[Advanced trace function: Watch support](#)

[Work with Watches \(WRKWCH\) command](#)

[End Watch \(ENDWCH\) command](#)

[Start Watch \(QSCSWCH\) API](#)

[End Watch \(QSCEWCH\) API](#)

## Scenario: Using the watch for event function with an exit program

This scenario explains how to use the watch for event function with an exit program.

Assume that you have a MYCLNUP program that you run whenever you want to clear the storage space on your system. You usually run this program when message CPF0907 (Serious storage condition might exist) is sent to the history log (QHST message queue in library QSYS).

You use the watch for event function to automatically run your cleanup program when the amount of available storage in the system auxiliary storage pool has reached the threshold value. Your user exit program also performs some special actions when the available storage is less than 5%.

When message CPF0907 enters the specified message queue, follow these steps to run MYCLNUP:

## Starting a watch session

A watch session can be started by the Start Watch (STRWCH) command or by the the Start Watch (QSCSWCH) API.

To start a watch session, follow these steps:

1. On the command line, enter STRWCH and press F4 (Prompt).
2. Specify a meaningful session identifier, such as mycleanup, in the **Session ID** field.
3. For the **Watch program parameter** field, specify MYWCHPGM, and type MYLIB for the **Watch program Library** field. MYWCHPGM is the exit program to be called when the watched-for event occurs.
4. For the **Watch for message, Message identifier** field, type CPF0907.
5. For the **Watched message queue, Message queue** field, type \*SYSOPR. This ensures that your Watch for Event exit program is called when the CPF0907 message is sent to the history log (QHST message queue in library QSYS).

To verify that the watch session was started, follow these steps:

1. At the command line, type WRKWCH and press F4 (Prompt).
2. For the **Watch** field, type \*STRWCH.
3. Check to see that the MYCLEANUP session is listed under the STRWCH type.

After the CPF0907 message is sent to the QHST message queue, the MYWCHPGM program in the MYLIB library is called. This program can call your MYCLNUP program and do any other functions you need by customizing the exit program.

## Examples of starting watch sessions

### • Starting a watch on your job

```
STRWCH  SSNID(OWN_JOB) WCHPGM(MYLIB/MYPGM)
WCHMSG((CPF0001)) WCHMSGQ(*JOBLOG)
```

This command starts the watch session named OWN\_JOB, watching for the CPF0001 message to occur on the job that called the STRWCH command. When the CPF0001 message is sent to the current job log, the MYPGM program in the MYLIB library is called to be notified of the event.

### • Starting a watch for a message specifying a Run Priority

```
STRWCH  SSNID(*GEN) WCHPGM(MYLIB/EXTPGM)
WCHMSG((CPF1804))
WCHMSGQ(*SYSOPR) (*JOBLOG)
WCHJOB(*ALL/MYUSER/MYJOBNAME)
RUNPTY(10)
```

This command starts a watch session to call the MYLIB/EXTPGM exit program when the CPF1804 message is found on the system operator message queue or within the \*ALL/MYUSER/MYJOBNAME job log. A unique watch session identifier is generated. The session identifier is returned to the message data of the CPC3901 completion message that is sent after the watch session starts successfully. The job by which the exit program will be called is run with a run priority of 10.

### • Starting a watch for a message specifying Comparison Data

```
STRWCH  SSNID(FRMPGM) WCHPGM(MYLIB/EXTPGM)
WCHMSG((CPC3922 QSCSWCH *FRMPGM))
WCHMSGQ(*HSTLOG)
```

This command starts a watch session to call the MYLIB/EXTPGM exit program when the QSCSWCH program sends the CPC3922 message to the message queue QHST in library QSYS.

### • Starting a watch for a Licensed Internal Code log entry

```
STRWCH  SSNID(LICLOGSSN) WCHPGM(*LIBL/EXTPGM)
WCHLICLOG(('99??' 9932 MYJOBNAME))
```

This command starts LICLOGSSN to watch for a Licensed Internal Code log entry that has a major code starting with 99 and a minor code of 9932 generated on the system. Also, the Licensed Internal Code log information needs to contain the text MYJOBNAME. The first match of the EXTPGM program found in the library list will be called, which notifies you that the event occurred.

- **Starting a watch for a PAL entry and Call Exit Program at start and end times**

```
STRWCH  SSNID(PALSSN)
WCHPGM(USRLIB/USRPGM)
CALLWCHPGM(*STRWCH *ENDWCH)
WCHPAL((B600512? MYRSC *RSCNAME))
```

This command starts PALSSN to watch for a Product Activity Log (PAL) entry that has a system reference code starting with B600512 generated on the system. Also, the PAL resource name contains the text MYRSC. The program USRLIB/USRPGM is called, which notifies you that the event occurred. It is also called before you start watching for any event and when the watch session is ending.

### **Ending a watch session**

You can end your watch session by using the End Watch (ENDWCH) command or the End Watch (QSCWCH) API.

To end a watch session, follow these steps:

1. On the command line, type ENDWCH and press F4 (Prompt).
2. In the **Session ID** field, specify myc1cleanup.

To verify that the watch session was ended, follow these steps:

1. On the command line, type WRKWCH and press F4 (Prompt).
2. In the **Watch** field, type \*STRWCH.
3. Verify that the MYCLEANUP session is not listed anymore.

#### **Notes:**

- You can also type DSPMSG MSGQ(\*SYSOPR) to verify that the watch session was ended. The CPI3999 message indicates that the MYCLEANUP watch session was ended because of reason code 08. Reason code 08 indicates that the End Watch (ENDWCH) command or End Watch (QSCWCH) API was issued.
- A watch session might end because an error was detected on the watch exit program. In this case, the watch program will not be called at \*ENDWCH time.
- If the watch session to be ended originally specified multiple message identifiers (IDs), Licensed Internal Code log entries, or Product Activity Log (PAL) entries, all of them are no longer watched. The CPI3999 message is sent to the caller of the Start Watch (STRWCH) command or the Start Watch (QSCWCH) API, and to the message queue QHST to indicate that an error in the exit program caused the watch session to be ended.

### **Displaying details of watch sessions**

With the Display Watch panel, you can list the details of the active watch sessions. The information displayed includes the messages, the Licensed Internal Code log entries, and the Product Activity Log (PAL) entries that are watched.

To view the details of the watch sessions, follow these steps:

1. At the command line, type WRKWCH and press F4 (Prompt). The Work with Watches display is shown.
2. Type option 5 (Display) and press Enter. The details of the watch sessions are displayed.

**Note:** By default, the first display shows the message details information. If no messages are watched for, then the first display shows the Licensed Internal Code log details. If neither messages nor Licensed Internal Code logs are watched for, then the first display shows the PAL details.

- **Session ID:** Shows the session identifier for the watch. This identifier is unique across all active watches on the system.

- **Started by:** Shows the name, user name, and the job number of the job that started the watch session.
- **Watch program:** Shows the exit program that is called to notify you that a specified watch event occurred and the name of the library where the exit program is located.
- **Origin:** Shows the name of the command or API that started the watch.
- **Run priority:** Shows the priority for the job where the watch session work is run.
- **Started:** Shows the date and time when the watch session was started.
- **Length of time to watch:** Shows the time limit (in minutes) for watching for a message, a Licensed Internal Code log entry, or a PAL entry. This information is only available on watch sessions that are started by trace commands. When the specified amount of time elapses, the watch exit program is called (if one was specified on Watch Exit Program parameter), the watch is ended, and message CPI3999 is sent to the history log.
- **Time interval:** Shows the interval of time (in seconds) of how often the trace exit program is called. This information is only available on watch sessions that are started by trace commands.
- **Call exit program:** Shows the times at which the watch program is called. This program is always called when the watched-for event occurs. The watch program is also called when the watch session is ending.

**Note:** If a watch session is started by the Start Watch (STRWCH) command or Start Watch (QSCSWCH) API, the **Length of time to watch** and **Time interval** parameters are not shown. Instead, the **Call exit program** parameter is shown.

The following tables list some additional information that is displayed during watch sessions:

<i>Table 1. Other information when watching for messages</i>	
<b>Parameters</b>	<b>Description</b>
Message ID	The message identifier to be watched for
Watched message queue	Identifies where to watch for the message identifiers specified on the Watch for message parameter
Library	The name of the library where the message queue is located
Job name	The name of the job being watched
User	The user name of the job being watched
Job number	The job number to further qualify the job name and user name
Compare against	Specifies which part of the message that the comparison data is to be compared against
Comparison data	Specifies that comparison data that is used if a message matching the specified message ID is added to the specified message queue or log

*Table 2. Other information when watching for Licensed Internal Code log entries*

<b>Parameters</b>	<b>Description</b>
Major code	Licensed Internal Code log major. code being watched for
Minor code	Licensed Internal Code log minor. code being watched for
Compare against	The part of the Licensed Internal. Code log that the data specified in the Licensed Internal Code log comparison data field is to be compared against
Comparison data	Specifies the comparison data. If this text is found in the used if a log entry matching the licensed internal code log entry specified major and minor codes data field that is specified as is added to the licensed internal compare against, the watched for code log condition is true. This text is case sensitive.

*Table 3. Other information when watching for Product Activity Log (PAL) entries*

<b>Parameters</b>	<b>Description</b>
SRC (system reference code)	The system reference code that. identifies the Product Activity Log (PAL) entry being watched for
Compare against	The part of the PAL that the data. specified for comparison data is to be compared against
Comparison data	The comparison data to be used. if a PAL entry that matches the specified system reference code was added

*Table 4. Function keys that can be used on the Display Watch panel*

<b>Function keys</b>	<b>Description</b>
F11 (Message queue and job)	Displays the message queue and. job log information
F13 (Message details)	Displays information about the. messages being watched for
F14 (LIC log details)	Displays information about the. licensed internal code logs being watched for
F15 (PAL details)	Displays information about the. PALs being watched for
F22 (Display entire field )	Shows the full comparison data. field

## Scenario: Exit program for Watch for Event

The Watch for event function is started by the Start Watch (STRWCH) command or the Start Watch (QSCSWCH) API to notify the user by calling an exit program when the specified event occurs. An event can be a message that is sent to a message queue, a job log, a Licensed Internal Code log entry, or a Product Activity Log (PAL) entry, which shows errors that occurred in disk and tape units, during communications, or on workstations.

The user-written exit program is called in the circumstances specified in the Watch option setting parameter. Here is an example of a Watch for Event exit program, which is written in C.

Use this exit program as a starting point to help you create your own watch for event exit program. You can modify the code to allow the program to perform additional functions.

**Note:** By using the code examples, you agree to the terms of the [“Code license and disclaimer information”](#) on page 75.

```

/*****
** file = mywchpgm.c
**
** Example of an Exit Program for Watch for Event.
**
** This program will be called by the watch for event support when CPF0907
** message is sent to the history log (QHST message queue in library QSYS).
**
** The program will call a cleanup program to free system storage and,
** if the available storage is less than 5%, the program will perform some
** more actions (not defined).
**
*****/
#include <decimal.h>
#include <stdio.h>
#include <string.h>
#include <stdlib.h>
#include <except.h> /* _INTRPT_Hndlr_Parms_T is typedefed */
#include <escwcht.h> /* Include for Watch Exit Program packaged in */
/* QSYSINC/H Source Physical File */

/***** Prototypes *****/
void UNEXPECTED_HDLER (_INTRPT_Hndlr_Parms_T *errmsg);

/* Declare variables to receive parameters */
char watch_option_setting[10],
      session_ID[10],
      * error_detected_ptr;

typedef struct {
    Qsc_Watch_For_Msg_t msg_data;
    char VarData[8776]; /* variable length data */
} MsgFullData_t;

MsgFullData_t * MsgFullData;

int main (int argc, char *argv[])
{
    char * cAvailStorage[4];
    decimal(7,4) dAvailStorage;

    /* Variables to call a command */
    int rc;
    char cmdtorun[128];
    #define CALL_MYCLNUP "CALL PGM(MYLIB/MYCLNUP)"

    /*****
    /* Turn exception monitor on.
    *****/
    #pragma exception_handler (UNEXPECTED_HDLER, 0, 0, _C2_MH_ESCAPE)

    memcpy(watch_option_setting, argv[1], 10);
    memcpy(session_ID, argv[2], 10);
    error_detected_ptr = argv[3];
    MsgFullData = (MsgFullData_t *) argv[4];

    /* Verify if the exit program was called because a watched message
    /* occurred. This verification is useful if you have a watch
    /* session waiting for a message event and for a Licensed Internal Code log event
    */

```



```

if (memcmp(watch_option_setting,"*MSGID      ",10)==0) {
    /* Verify if the message ID that occurred is CPF0907          */
    /* This verification is useful if you are watching for more than */
    /* one message in the same watch session                      */
    if (memcmp(MsgFullData->msg_data.Message_ID,"CPF0907",7)==0) {
        /* Call cleanup program to free space                    */
        strcpy(cmdtorun,CALL_MYCLNUP);
        rc = system(cmdtorun);

        if (rc == 0) {
            /* Determine if the available storage space is less than 5% */
            /* to do some extra processing                            */

            if (MsgFullData->msg_data.Length_Of_Replacement_Data > 0) {
                /* The remaining storage comes in the 4th field data in the */
                /* message replacement variable. See CPF0907 message        */
                /* description for a better understanding                    */
                memcpy(cAvailStorage,
                    (char *) (argv[4] +
                        MsgFullData->msg_data.Offset_Replacement_Data + 66),
                    4);

                dAvailStorage = *(decimal(7,4) *) cAvailStorage;

                if (dAvailStorage <= 5.00) {
                    /* Do some extra processing                            */
                }
            }
        }
        else { /* Error on clean-up program                        */
            UNEXPECTED_HDLR(NULL); /* Return error and exit          */
        }
        else {
            /* Add code in case you are expecting any other message ID    */
        }
    }

    /* Verify if the exit program was called because a Licensed Internal Code log occurred */
    else if (memcmp(watch_option_setting,"*LICLOG      ",10)==0) {
        /* Not needed for this watch session                            */
    }

    memcpy(error_detected_ptr,"                ",10); /* No error detected by
                                                    watch exit program, return blanks and
                                                    continue watching
    #pragma disable_handler
    return (0);
}

/*****
/* FUNCTION NAME: UNEXPECTED_HDLR
/*
/* FUNCTION :      Handle unexpected exceptions that may occur
/*                during the invocation of this pgm.
/*
/*
*****/
void UNEXPECTED_HDLR (_INTRPT_Hndlr_Parms_T *errmsg)
{
    memcpy(error_detected_ptr,"*ERROR      ",10); /* An error occurred
                                                    on the watch exit program. Return *ERROR
                                                    and End the watch session
    exit(EXIT_FAILURE);
}

```

## Analyzing and handling problems

If you are experiencing problems with your system, you need to gather further information to analyze and handle the problems. A start problem analysis procedure can guide you through resolving the problem.

You can use several options to solve the problem.

- The problem analysis procedures provide a list of yes or no questions that guide you down the path to locate the problem. This is a good place to start when you are not sure what the problem is, or if you are new to troubleshooting a system.

- The system reference code (SRC) list contains over 140 SRC groupings. It provides either a general idea of what the SRC means, or links to other sources of detailed information.
- A Main Storage Dump (MSD) is a process of collecting data from the system's main storage, which can be helpful for the technical support personnel to help you analyze the problem further.
- Control language (CL) commands are the set of commands with which a user requests system functions.
- Problem-handling menus accommodate users of all skill levels in solving system problems. For example, the USERHELP menu provides basic problem-handling functions where you can learn the simple task of using help. Alternatively, the NETWORK menu provides access to information that helps an operator handle problems throughout a network.
- Authorized Program Analysis Report (APAR) is a request for a defect correction in a current release of an IBM-supplied program.

### Related concepts

#### How your system manages problems

You can use the problem-analysis functions that your system provides to manage both system-detected and user-defined problems. The structured problem management system helps you and your service provider quickly and accurately manage the problems when they occur on the system.

## Problem analysis procedures

You can often solve problems that occur on your system with methodical analysis.

If you need the help of a service representative, you need to offer sufficient information to that person.

### Things to keep in mind while troubleshooting problems

- Has there been an external power outage or momentary power loss?
- Has the hardware configuration changed?
- Has system software been added?
- Have any new programs or program changes been recently installed?

To make sure that your licensed programs and products have been correctly installed, use the Check Product Option (CHKPRDOPT) command.

- Have any system values changed?
- Has any system tuning been done?

After considering this information, you are ready to begin problem analysis.

### Starting problem analysis

If you are having a problem on your system, follow this procedure to narrow down the problem and to gather the necessary information to report to your next level of support.

1. Can you turn on your system?
  - **Yes:** Continue with the next step.
  - **No:** Go to [“Recovering from a system power problem” on page 17.](#)
2. Does the Function/Data display on the system control display start with Function 11-3, or is the System Attention light on? Use the up and down arrow buttons to cycle through the functions to determine if an 11-3 exists. Press Enter to alternate between function and data.
  - **Yes:** Go to step [“19” on page 14](#) to determine if an 11-3 exists.
  - **No:** Continue with the next step.
3. Is the system logically partitioned?
  - **Yes:** Continue with the next step.
  - **No:** Go to step [“5” on page 13.](#)

4. Using system service tool (SST)/dedicated service tool (DST) from the primary partition console, select **Work with system partitions**, then select **Work with partition status**. Is there a partition with the state of Failed or Unit Attn?
  - **Yes:** Go to step [“19” on page 14](#).
  - **No:** Continue with the next step.
5. Does the console show a Main Storage Dump Manager display?
  - **Yes:** Go to [“Performing a main storage dump” on page 34](#).
  - **No:** Continue with the next step.
6. Does the display station that was in use when the problem occurred (or any display station) appear to be operational?

**Note:** The display station is operational if there is a sign-on display or a menu with a command line. If another display station is operational, use that display station to resolve the problem.

  - **Yes:** Continue with the next step.
  - **No:** Choose from the following options:
    - If your console cannot vary on, go to [“Recovering when the console does not vary on” on page 21](#).
    - For all other workstations, go to [“Recovering from a workstation failure” on page 19](#).
7. Is a message related to this problem shown on the display station?
  - **Yes:** Continue with the next step.
  - **No:** Go to step [“12” on page 13](#).
8. Is this a system operator message?

**Note:** It is a system operator message if the display indicates that the message is in the QSYSOPR message queue. Critical messages can be found in the QSYSMSG.

  - **Yes:** Continue with the next step.
  - **No:** Go to step [“10” on page 13](#).
9. Is the system operator message highlighted, or does it have an asterisk (\*) by it?
  - **Yes:** Go to step [“18” on page 14](#).
  - **No:** Go to step [“14” on page 14](#).
10. Move the cursor to the message line and press F1 (Help), or use option 5 (Display details and reply). Does the Additional Message Information display appear?
  - **Yes:** Continue with the next step.
  - **No:** Go to step [“12” on page 13](#).
11. Record the message information that is shown on the problem summary form. If possible, follow the recovery instructions on the Additional Message Information display. Did this solve the problem?
  - **Yes: This ends the procedure.**
  - **No:** Continue with the next step.
12. Type `dspmsg qsysopr` on any command line and press Enter to display system operator messages. Did you find a message that is highlighted or has an asterisk (\*) by it?
  - **Yes:** Go to step [“18” on page 14](#).
  - **No:** Continue with the next step.

**Note:** Management Central's Message monitor can also inform you when a problem has developed.
13. Did you find a message at or near the time that the problem occurred?

Use option 5 (Display details and reply) on the Work with Message display to determine the time that a message occurred.

If the problem appears to affect only one display station, you might be able to use information from the JOB menu to diagnose and solve the problem. Type GO JOB and press Enter on any command line to find this menu.

- **Yes:** Continue with the next step.
- **No:** Go to step [“16” on page 14](#).

14. Perform the following steps:

- a. Use option 5 (Display details and reply) to display additional information about the message.
- b. Record the message information that is shown on the problem summary form. If it indicates that you need to run problem analysis, go to step [“18” on page 14](#).
- c. If possible, follow any recovery instructions that are shown.

Did this solve the problem?

- **Yes: This ends the procedure.**
- **No:** Continue with the next step.

15. Were you instructed by the message information to look for additional messages in the system operator's message queue (QSYSOPR)?

- **Yes:** Press F12 (Cancel) to return to the list of messages and look for other related messages. Then, return to step [“12” on page 13](#).
- **No:** Continue with the next step.

16. Do you know which input/output device is causing the problem?

- **No:** Continue with the next step.
- **Yes:** Perform the following steps:
  - a. Type ANZPRB on the command line and press Enter.
  - b. Report the problem. **This ends the procedure.**

17. If you do not know which input/output device is causing the problem, describe the problems that you have observed by performing the following steps:

- a. Type go userhelp on any command line and press Enter.
- b. Select option 10 (Save information to help resolve a problem) on the Information and Problem Handling (USERHELP) menu. Type a brief description of the problem and press Enter on the Save Information to Help Resolve a Problem display. If you specify the default **Y** for the Enter notes about problem field and press Enter, the Select Text Type display appears that allows you to enter more text to describe your problem.

**Note:** To describe your problem in greater detail, see Using the Analyze Problem command. This command also might run a test to further isolate the problem.

18. Perform the following steps:

- a. Use option 5 (Display details and reply) to display additional information about the message.
- b. Press F14, or use the Work with Problem (WRKPRB) command.
- c. If this does not solve the problem, see Symptom and recovery actions.

19. Perform the following steps:

- a. Make sure that you have collected all of the system reference codes.
- b. Go to the System reference code list, find the system reference codes that you collected, and perform the actions indicated.

### **Related concepts**

[Gathering information with the problem summary form](#)

The problem summary form is used to record information displayed on the system unit control panel.

[Reporting problems detected by the system](#)

The system problem log contains a list of all the problems recorded on the system.

### **Related tasks**

Scenario: Message monitor

Collecting system reference codes

You need to record the system reference codes on the Problem summary form.

System reference code list

In these tables, locate the system reference code (SRC) that you have displayed. In the table, xxxx can be any number 0 through 9 or letter A through F.

Using the Analyze Problem command

To start problem analysis for user-detected problems, use the Analyze Problem (ANZPRB) command.

Using the Work with Problems command

With the problem analysis, you can gather more information about the problem and determine whether to solve it or to report it without the help of a hardware service provider.

Symptom and recovery actions

In the problem-analysis symptom and recovery list, find the symptom you are experiencing and then perform the corresponding recovery procedure.

### **Related reference**

Creating message queue QSYSMSG for severe messages

You can create an optional message queue, QSYSMSG, to hold specific severe system messages that require immediate action.

## **Collecting system reference codes**

You need to record the system reference codes on the Problem summary form.

If you have a model 270 or 8xx:

1. Press the increment button until 05 is displayed on the Function/Data display and press Enter. Record the information that is displayed.
2. Press the increment button again until 11 is displayed on the Function/Data display and press Enter. Record the information that is displayed.
3. Press the increment button again, the number 12 is displayed. Press Enter, and record the 32-character code: 16 characters from line one, and 16 characters from line two, of the Function/Data display.
4. Press the increment button again, the number 13 is displayed on the first line of the Function/Data display. Press Enter, and record the 32-character code: 16 characters from line one, and 16 characters from line two, of the Function/Data display.
5. Press the increment button again until the number 20 is displayed on the first line of the Function/Data display. Press Enter, and record the 32-character code: 16 characters from line one, and 16 characters from line two, of the Function/Data display.

### **Notes:**

1. For earlier models, if you have an expansion unit attached to your system, select Function 05, and record the system reference codes.
2. If 11-3 is shown in the Function/Data display on the control display, then the numbers that follow are the system reference codes.
3. If a number other than 11-3 is shown in the Function/Data display, the number might not indicate a problem with the system. These codes might indicate functions that you select from the control panel display.
4. If you have a display station with Type and Reference Code columns on it, record the data under the Type column as the first 4 characters of function 11 on the problem summary form. If an A, B, C, or D is displayed as the first digit in the Type column, use the data in the Reference Code column as the last 4 characters of function 11.

## Related concepts

[Gathering information with the problem summary form](#)

The problem summary form is used to record information displayed on the system unit control panel.

[Reporting problems overview](#)

You need to know what information you should gather about the problem, how to report and track problems, and how to send a service request to IBM.

## Related tasks

[Starting problem analysis](#)

If you are having a problem on your system, follow this procedure to narrow down the problem and to gather the necessary information to report to your next level of support.



## Symptom and recovery actions

In the problem-analysis symptom and recovery list, find the symptom you are experiencing and then perform the corresponding recovery procedure.

1. Were you directed here from the problem-analysis procedure?
  - **Yes:** Continue with the next step.
  - **No:** Go to [Starting problem analysis](#).
2. Use the following table to find the symptom you are experiencing in the Symptom column, starting at the top of the list and moving down. Then, perform the procedure listed in the Recovery procedure column.

<b>Symptom</b>	<b>Recovery procedure</b>
You cannot turn on the system.	See <a href="#">“Recovering from a system power problem”</a> on page 17.
The system attention light is on, or a system reference code is displayed on the control panel.	See the <a href="#">“System reference code list”</a> on page 21.
The Operations Console Remote Control Panel feature is not working correctly.	See <a href="#">“Recovering when the Operations Console remote control panel feature is not working correctly”</a> on page 17.
A pushbutton or light on the control panel is not working correctly.	See <a href="#">“Recovering when the control panel push buttons or lights are not working correctly”</a> on page 18.
You cannot perform an initial program load (IPL) or you suspect an operating system failure.	See <a href="#">“Recovering from IPL or system failures”</a> on page 18.
Your workstation or device (such as display or printer) is not working.	See <a href="#">“Recovering from a workstation failure”</a> on page 19.
You are having a problem with a tape or optical device.	See <a href="#">“Recovering from a tape or optical device problem”</a> on page 19.
You are having a problem with a disk or diskette unit.	See <a href="#">“Recovering from a disk or disk drive problem”</a> on page 20.
You cannot communicate with another device or computer.	See <a href="#">“Recovering from a communications problem”</a> on page 20.
Your system seems to be in a loop or hang condition.	See <a href="#">“Recovering from system hang or loop condition”</a> on page 20.
You are having an intermittent problem.	See <a href="#">“Recovering from an intermittent problem”</a> on page 20.

Table 5. Problem-analysis symptom and recovery list (continued)

Symptom	Recovery procedure
You are having data compression problems and receive this message: Message ID CPPEA02 along with system reference code (SRC) 6xxx 7051 - Compressed device and compression input/output adapter (IOA) are not compatible.	Go to Recovering from SRC 6xxx 7051 in the Working with Disk Compression chapter in the <a href="#">Recovering your system</a>  guide (about 570 pages).
You are having data compression problems and receive this message: Message ID CPPEA03 along with SRC 6xxx 7052 - Data compression warning.	Go to Recovering from SRC 6xxx 7052 in the Working with Disk Compression chapter in the <a href="#">Recovering your system</a>  guide (about 570 pages).
The system has logical partitions and a state of Failed or Unit Attn is displayed on the Partition Status display of a secondary partition. There is a reference code.	See the <a href="#">“System reference code list”</a> on page 21.
The system is logically partitioned and your partition seems to be in a loop or hang condition.	See the <a href="#">“Recovering from system hang or loop condition”</a> on page 20.
The system is logically partitioned and you cannot perform an initial program load (IPL), or you suspect an operating system failure.	See the <a href="#">“Recovering from IPL or system failures”</a> on page 18.
No symptom to match in the table.	Go to the <a href="#">“Reporting problems overview”</a> on page 39.

### Related tasks

#### Starting problem analysis

If you are having a problem on your system, follow this procedure to narrow down the problem and to gather the necessary information to report to your next level of support.

### Recovering from a system power problem

To resolve power problems, perform the following steps.

1. Make sure that the power that is supplied to the system is adequate. If your system units are protected by an Emergency Power Off (EPO) circuit, check that the EPO switch is not activated.
2. Verify that your system power cables are correctly connected to the electrical outlet. When power is available, the Function/Data display on the control panel is lit.
3. If you have an uninterruptible power supply, verify that the cables are correctly connected to the system, and that it is functioning.
4. Make sure all system units are powered on.
5. Is a system reference code displayed on the control panel?
  - **Yes:** Go to the [“System reference code list”](#) on page 21.
  - **No:** Contact your hardware service provider.

### Recovering when the Operations Console remote control panel feature is not working correctly

To resolve problems when the Operations Console remote control feature is not working correctly, complete the following steps.

1. Are you able to change modes or select system functions using the Remote Control Panel feature?

- **Yes:** Continue with the next step.
  - **No:** Make sure the Operations Console cable is attached correctly. Using the Operations Console display, disconnect and then reconnect the system connection. If the same failure occurs, contact your hardware service provider.
2. Are the Remote Control Panel functions (Function/Data, Mode and Power) correctly displayed?
    - **Yes:** Use the Remote Control Panel to start an IPL and continue with the next step.
    - **No:** Contact your hardware service provider.
  3. Was the IPL successfully started?
    - **Yes:** Continue the IPL process.
    - **No:** Contact your hardware service provider.

## Recovering when the control panel push buttons or lights are not working correctly

To resolve a problem when the control panel push buttons or lights are not working correctly, try turning on the system again. If the control panel push buttons or lights are still not working correctly, contact your hardware service provider.

## Recovering from IPL or system failures

To recover from initial program load (IPL) or system failures, follow these instructions.

If the system is logically partitioned, references to the system, console, displays, system commands, and system values are relative to the partition that has a problem.

If the problem is in a secondary partition, references to the control panel refer to the Work with Partition Status display functions. If the problem is in the primary partition, refer to the actual control panel.

Verify the following conditions:

- The device from which you performed the IPL is powered on.
- The tape and CD are loaded correctly.
- The sign-on user ID and password are correct.
- The system is set to the correct mode (Manual, Normal, Auto, or Secure).
- If this is a timed IPL, the system value for date/time and control panel mode is set correctly .
- If this is a remote IPL, the telephone, modem, control panel mode, and QRMTIPL value are set up correctly .

After you have checked for these conditions, perform the following steps:

1. Perform an IPL from the control panel or Operations Console Remote Control panel using the following steps:
  - a. Set the system to the **Manual** mode.
  - b. Choose from the following conditions:
    - If the system is turned on, select Function 03 and press Enter to start an IPL.
    - If the system is turned off, ensure that the control panel is in either Normal or Manual mode and power on the system.
2. Sign on to the system when the Sign On display appears, and then continue with step 3. If you do not see the Sign On display, check to see if you have a new system reference code (SRC):
  - **Yes:** Go to the [“System reference code list”](#) on page 21.
  - **No:** Contact your next level of support. See [“Reporting problems overview”](#) on page 39 for details.
3. On the IPL Options display, specify Yes for the following parameters:
  - Define or change the system at IPL



- Clear output queues
  - Clear job queues
  - Clear incomplete job logs
4. Change the system value for QMCHPOOL to a smaller value.
  5. Make sure the system value for QCTLSBSD has the correct spelling, or assign an alternative controlling subsystem.
  6. Change the system value for QPWRDWNLMT to a larger value.
  7. Continue the IPL process. If the same failure occurs, set the system to the Normal mode, and then contact your hardware service provider.

### Related concepts

[Troubleshooting logical partitions](#)

## Recovering from a workstation failure

To recover from a workstation failure, follow this procedure.

1. Make sure all workstations and devices (such as displays or printers) are turned on.
2. If the Operations Console is being used as the console, ensure that the cable from the PC to the system is attached correctly. Make sure that the PC has been correctly configured.
3. Make sure that all workstation cables are attached correctly, and that all workstations are set to the correct address. For information about the workstation address, see the following information:
  - If you are using Operations Console, see [“Determining the primary or alternative consoles” on page 72.](#)
  - If you are using other workstations, see the [Local Device Configuration](#)  book (about 760 KB).
4. Ensure the following conditions exist:
  - Recently attached workstations have been correctly configured to the system.
  - Workstation addresses are unique (if applicable).
  - Workstations are terminated (if applicable).
5. Check all workstation printers for mechanical problems such as paper jams, ribbon failure, and so on.
6. Perform the following steps:
  - a. Vary off the failing workstation controller if any other workstation is operational, and then vary it on again. Follow these steps to vary on or off the workstation controller:
    - i) Type `WRKCFGSTS *CTL` on any command line. The Work with Configuration Status display appears.
    - ii) Specify 1 (Vary-on) or 2 (Vary-off) in the opt column next to your workstation controller, and press Enter.
  - b. End all active jobs before varying off the workstation controller using the Work with Active Jobs (WRKACTJOB) command.
7. Try the operation again. If you are still having the same problem, contact your hardware service provider.

## Recovering from a tape or optical device problem

To resolve tape or optical device problems, follow this procedure.

Verify the following aspects:

- All tapes or optical devices are powered on and in a Ready (enabled) condition.
- Cables between the system and the tape or optical device are correctly connected (if applicable).
- Tape density and tape bits per inch (BPI) match.

- The tape path is cleaned.
- The CD disk is clean, the format is supported, and the disk is loaded correctly with the label side showing.

Does the tape device or CD device fail to read or write?

- **Yes:** Contact your hardware service provider.
- **No:** Replace the tape or CD and try the operation again. If the same failure occurs, contact your hardware service provider.

## Recovering from a disk or disk drive problem

To resolve disk or disk drive problems, follow this procedure.

1. Make sure that all disk and diskette units are powered on and enabled. Some disk units might have enabled switches.
2. Make sure cables are correctly connected between the system and disk or diskette unit (if applicable).
3. Do all diskettes fail to read or write?
  - **Yes:** Contact your hardware service provider.
  - **No:** Replace the diskette and try the operation again. If the same failure occurs, contact your hardware service provider.

## Recovering from a communications problem

To resolve problems with communications, follow this procedure.

1. Make sure that all communications equipment, such as modems or transceiver are powered on.
2. Make sure all communications cables are correctly connected.
3. Make sure the remote system is ready to receive communications.
4. Verify the network equipment (or provider) is functional. This includes telephone service (for example, verify the status of communications lines).
5. Verify that the configuration is correctly specified for the failing communications or LAN facility.
6. If you still have the same problem, contact your hardware service provider.

## Recovering from system hang or loop condition

To resolve system hang or loop conditions, follow this procedure.

1. To gather data on the current state of the system during the loop or hang condition, refer to the performing a main storage dump information. This information is critical for problem solving. Valuable diagnostic information will be lost if you do not collect the storage dump information before you try to perform an IPL.
2. Contact your hardware service provider after performing the main storage dump.

### Related tasks

#### Performing a main storage dump

A main storage dump (MSD) is a process of collecting data from the system's main storage. It can be done in these ways.

## Recovering from an intermittent problem

To resolve intermittent problems, follow this procedure.

1. Enter the Analyze Problem (ANZPRB) command on any command line. The Select Type of System display appears.
2. Select option 1 (This server or attached device). The Analyze problem display appears.
3. Select option 3 (Hardware problem). The Problem Frequency display appears.
4. Select option 1 (Yes) to get an intermittent checklist and follow the instructions.

5. If you still have the same problem, contact your hardware service provider.

## Recovering when the console does not vary on

To resolve console vary-on problems, follow this procedure.

If the system is logically partitioned, references to the system, console, displays, system commands, and system values are relative to the partition having a problem. References to the control panel refer to the "Work with partition" status display functions, if the problem is in a secondary partition, or refer to the actual control panel, if the problem is in the primary partition.

1. Locate the workstation that is used as the primary console. See [“Determining the primary or alternative consoles” on page 72](#).
2. Make sure the workstation cables are attached correctly and set to the correct address.
3. Can you sign on to an alternative console?
  - **Yes:** Continue with the next step.
  - **No:** Go to step [“5” on page 21](#).
4. If you can sign on to an alternative console, perform the following steps:
  - a. Make sure the primary console controller (for example, CTL01) and device description (for example, DSP01) have been created or restored. To check the device description, use the command `WRKCFGSTS *CTL`.
  - b. If descriptions exist, check the system operator message to determine why the primary console failed.
  - c. Take corrective actions indicated in the message.
  - d. If you still cannot solve the problem, set the system to the Normal mode and call your software service representative.
5. If you cannot sign on to an alternative console, perform the following steps:
  - a. Set the system to the **Manual** mode, select function 3, and press Enter to start an IPL. You will see the IPL Option display.
  - b. Were you able to get to the IPL Option display?
    - **No:** Contact your hardware service provider.
    - **Yes:** On the IPL Options display, specify **Y** (Yes) in the Define or change system at IPL field, **N** (No) in the Set major system option field and press Enter. The Configuration Commands menu appears.
  - c. Select option 2 (Controller description commands) to see the controller description for the console. Verify that the controller (for example, CTL01) was created correctly. If the name has been changed, refer to [Finding the primary console when the system is operational](#).
  - d. Select option 3 (Device description commands) to see the device description for the console. Verify that the device (for example, DSP01) was created correctly.

## System reference code list

In these tables, locate the system reference code (SRC) that you have displayed. In the table, xxxx can be any number 0 through 9 or letter A through F.

The SRCs are grouped in ranges, although the recovery for each range might not apply to every SRC within the range. If you cannot find your SRC range in this table, call your next level of support.

The codes in this list are organized by their first character, with numbers coming before letters. To navigate this listing, click or go to the following number or letter that matches the first character of your SRC. Then, select your SRC from the list provided.

0   1   2   3   4   5   6   7   8   9   A   B   C   D   E   F

For each SRC range, there is a brief description of what the SRC range indicates, and what you need to do. If the recommendation does not solve the problem, or if there is no recommended way to solve the problem, contact your hardware service provider.

## 0

These SRCs start with 0.

SRC	What it means and what you need to do
0000 xxxx	Check for a specific 0000 SRC. If you do not see your SRC, a control panel failure may have been detected.
0000 AABB 0000 AACC	You attempted a timed, remote, or automatic Initial Program Load (IPL) with the system in the Secure or Manual mode. Set the system to the Normal or Auto mode and perform an IPL again.
0000 AADD	You attempted a manual IPL with the system in the Secure or Auto mode. Set the system to the Normal or Auto mode and perform an IPL again.

## 1

These SRCs start with 1.

SRC	What it means
1xxx xxxx	Check for a specific 1xxx SRC. If you do not see your SRC, a System Power® Control Network (SPCN) failure may have been detected.
1xxx D101 1xxx D102	Either a battery power unit x failed, or a battery power unit x test failed. Replace the battery power unit. See <a href="#">“Replacing the battery power unit on models 5xx and expansion units FC 507x and FC 508x”</a> on page 73. If the battery still does not work after the replacement, call your hardware service provider.

## 2

These SRCs start with 2.

SRC	What it means
2105 xxxx	It may indicate a disk unit failure.
2107 xxxx	It may indicate a disk unit failure.
2629 xxxx	It may indicate a Storage IOA failure.
2644 3136	It may indicate a software installation error. See <a href="#">Common reference codes for i5/OS software installation</a> for more information.
2718 xxxx	It may indicate a Storage IOA failure.
2724 xxxx	It may indicate an I/O adapter Licensed Internal Code, or incompatible hardware failure.
2726 xxxx	It may indicate a Storage IOA failure.
2728 xxxx	It may indicate a Storage IOA failure.
2729 xxxx	It may indicate a Storage IOA failure.
2740 xxxx	It may indicate a Storage IOA failure.
2741 xxxx	It may indicate a Storage IOA failure.
2742 xxxx	It may indicate an I/O adapter hardware failure.

<b>SRC</b>	<b>What it means</b>
2743 xxxx	It may indicate an I/O adapter hardware failure.
2744 xxxx	It may indicate an I/O adapter Licensed Internal Code, or incompatible hardware failure.
2745 xxxx	It may indicate an I/O adapter hardware failure.
2746 xxxx	It may indicate a Twinaxial - Workstation Adapter error.
2748 xxxx	It may indicate a system bus failure.
2749 xxxx	It may indicate an I/O processor configuration error.
2750 xxxx	It may indicate an I/O adapter hardware failure.
2751 xxxx	It may indicate an I/O adapter hardware failure.
2757 xxxx	It may indicate a system bus failure.
2760 xxxx	It may indicate an I/O adapter hardware failure.
2761 xxxx	It may indicate an I/O adapter hardware error.
2763 xxxx	It may indicate a system bus failure.
2765 xxxx	It may indicate an I/O processor failure.
2766 xxxx	It may indicate an I/O processor configuration error
2767 xxxx	It may indicate an I/O processor error.
2768 xxxx	It may indicate an I/O processor error.
2771 xxxx	It may indicate an incompatible hardware detected, I/O adapter Licensed Internal Code failed, or one half of I/O adapter failed.
2772 xxxx	It may indicate an incompatible hardware error, or I/O adapter Licensed Internal Code failure.
2778 xxxx	It may indicate a system bus failure.
2780 xxxx	It may indicate a system bus failure.
2782 xxxx	It may indicate a system bus failure.
2787 xxxx	It may indicate an I/O processor configuration error.
2793 xxxx	It may indicate an I/O adapter hardware error.
2805 xxxx	It may indicate an I/O adapter hardware error.
2809 xxxx	It may indicate a Storage IOA failure.
2810 xxxx	It may indicate a Storage IOA failure.
281x xxxx	It may indicate an I/O adapter hardware error.
2824 xxxx	It may indicate a Storage IOA failure.
282C xxxx	It may indicate a Storage IOA failure.
2838 xxxx	It may indicate an I/O adapter Licensed Internal Code failure.
283C xxxx	It may indicate a device backplane problem.
283D xxxx	It may indicate a device backplane problem.
283F xxxx	It may indicate a device backplane problem.

<b>SRC</b>	<b>What it means</b>
2842 xxxx	It may indicate an I/O processor error.
2843 xxxx	It may indicate an I/O processor error.
2844 xxxx	It may indicate an I/O processor error.
2849 xxxx	It may indicate an I/O adapter Licensed Internal Code failure, or incompatible hardware error.
284B xxxx	It may indicate an I/O processor error.
284C xxxx	It may indicate an I/O processor error.
284D xxxx	It may indicate an I/O processor error.
284E xxxx	It may indicate an I/O processor error.
286C xxxx	It may indicate an I/O processor error.
286D xxxx	It may indicate an I/O processor error.
286E xxxx	It may indicate an I/O processor error.
286F xxxx	It may indicate an I/O processor error.
287F xxxx	It may indicate an I/O adapter hardware error detected.
28B9 xxxx	It may indicate an device backplane problem.
28BC xxxx	It may indicate an device backplane problem.
28CB xxxx	It may indicate an device backplane problem.
28CC xxxx	It may indicate an device backplane problem.
28CD xxxx	It may indicate an device backplane problem.

### **3**

These SRCs start with 3.

<b>SRC</b>	<b>What it means</b>
3490 xxxx	It may indicate a tape unit problem.
3494 xxxx	It may indicate a tape library problem.
3570 xxxx	It may indicate a tape unit problem.
358x xxxx	It may indicate a tape unit problem.
3590 xxxx	It may indicate a tape unit problem.

### **4**

These SRCs start with 4.

<b>SRC</b>	<b>What it means</b>
432x xxxx	It may indicate a disk unit failure.

### **5**

These SRCs start with 5.

<b>SRC</b>	<b>What it means</b>
5306 xxxx	It may indicate a device backplane problem.
5700 xxxx	It may indicate an I/O adapter hardware error.
5701 xxxx	It may indicate an I/O adapter hardware error.
5702 xxxx	It may indicate a problem with an I/O processor.
5703 xxxx	It may indicate a system bus failure.
5704 xxxx	It may indicate an I/O processor configuration error.

## **6**

These SRCs start with 6.

<b>SRC</b>	<b>What it means</b>
6149 xxxx	It may indicate an I/O adapter Licensed Internal Code failure.
63xx xxxx	A tape unit failed. See <a href="#">“Recovering from a tape or optical device problem”</a> on page 19.
6532 xxxx	It may indicate a Storage IOA failure.
6533 xxxx	It may indicate a Storage IOA failure.
6534 xxxx	It may indicate a Storage IOA failure.
660x xxxx	It may indicate a disk unit failure.
671x xxxx	It may indicate a disk unit failure.
671A xxxx	It may indicate a Storage IOA failure.
673x xxxx	It may indicate a disk unit failure.
6A59 xxxx	It may indicate a workstation adapter console failure.

## **7**

These SRCs start with 7.

<b>SRC</b>	<b>What it means</b>
7207 xxxx	It may indicate a tape unit error.
7208 xxxx	It may indicate a 8mm tape drive failure.

## **8**

These SRCs start with 8.

<b>SRC</b>	<b>What it means</b>
8427 xxxx	It may indicate a tape library failure.

## **9**

These SRCs start with 9.

<b>SRC</b>	<b>What it means</b>
93xx xxxx	A disk or diskette unit failed. See <a href="#">“Recovering from a disk or disk drive problem”</a> on page 20.

## A

These SRCs start with A.

SRC	What it means
<b>A1xx xxxx</b>	Check for a specific A1xx SRC. If you do not see your SRC, it can indicate an IPL load device failure. See <a href="#">“Recovering from IPL or system failures”</a> on page 18.
A12x 19xx	It may indicate a software installation error. See <a href="#">Common reference codes for i5/OS software installation</a> for more information.
A1xx 19xx	It may indicate a software installation error. See <a href="#">Common reference codes for i5/OS software installation</a> for more information.
<b>A6xx xxxx</b>	Check for a specific A6xx SRC. If you do not see your SRC, it can mean a Licensed Internal Code error was detected. See <a href="#">Common reference codes for i5/OS software installation</a> for more information.
A6xx 0277	<p>A compression disk unit cannot complete an operation.</p> <ol style="list-style-type: none"><li>1. Do <b>not</b> turn off the system when performing this procedure.</li><li>2. Look at the 4 characters that are to the left of the Data display of function 17-3. These 4 characters indicate the type of problem that exists and the recovery action to perform.</li><li>3. Are these character 8402 or 2002?<ul style="list-style-type: none"><li>• <b>No:</b> Continue with step <a href="#">“4”</a> on page 26.</li><li>• <b>Yes:</b> The compression disk unit is temporarily full of data. The command to the compression disk is being held. When the subsystem controller has created sufficient space on the compression disk unit to contain the data, the command that is being held is released and the system resumes normal processing. If the system does not resume normal processing within 20 minutes, contact your hardware service provider.</li></ul></li><li>4. If these characters are 8400 or 2000, the compression disk unit is full of data. The command to the compression disk is being held. Go to <a href="#">Disk unit full considerations</a> in the <a href="#">Recovering your system</a>  book.</li></ol>
A600 11xx	It may indicate a software installation error. See <a href="#">Common reference codes for i5/OS software installation</a> for more information.
A6xx 500x	It may indicate a workstation controller failure. See <a href="#">“Recovering from a workstation failure”</a> on page 19.
A600 50xx	It may indicate an Operations Console error. See <a href="#">Troubleshooting system reference code data</a> .
<b>A9xx xxxx</b>	Check for a specific A9xx SRC. If you do not see your SRC, it may indicate an application error.
A900 xxxx	It may indicate an Operations Console error. See <a href="#">Troubleshooting system reference code data</a> .



<b>SRC</b>	<b>What it means</b>
A900 2000	<p>If the IPL completed normally, does the console have a sign-on display?</p> <p><b>Note:</b> If the console did not vary on, see <a href="#">“Recovering when the console does not vary on”</a> on page 21.</p> <ol style="list-style-type: none"> <li>If the system completed the IPL, check the QSYSARB job log for a message, and follow the corrective actions indicated. To view the QSYSARB job log: <ol style="list-style-type: none"> <li>Use the Work with Active Jobs (WRKACTJOB) command, then type 5 (Work with) next to the QSYSARB job.</li> <li>Select option 10 (Display jobs) to view the job log. You need *QSECOFR user class, or *ALLOBJ and *JOBCTL special authority to view the job log.</li> </ol> </li> <li>If the problem persists, contact your hardware service provider.</li> </ol>
A900 3C70	It indicates that the system is in batch restricted state. See <a href="#">End Subsystem (ENDSBS)</a> for more information.

## **B**

These SRCs start with B.

<b>SRC</b>	<b>What it means</b>
B0xx xxxx	<p>Check for a specific B0xx SRC. If you do not see your SRC, it can mean a communications Licensed Internal Code failure was detected.</p> <ol style="list-style-type: none"> <li>Make sure the latest fix package is installed.</li> <li>If this does not solve the problem, call your software service representative.</li> </ol>
B003 xxxx	It may indicate an asynchronous Communications failure.
B006 xxxx	It may indicate a common Licensed Internal Code failure.
B070 xxxx	It may indicate a no response, time-out temporary error.
<b>B1xx xxxx</b>	Check for a specific B1xx SRC. If you do not see your SRC, it can mean an IPL load device failure. See <a href="#">“Recovering from IPL or system failures”</a> on page 18.
B101 4500	It may indicate an error with the Integrated xSeries Server (IXS). See <a href="#">Common reference codes for i5/OS software installation</a> for more information.
B1xx 45xx	It may indicate a software installation error. See <a href="#">Common reference codes for i5/OS software installation</a> for more information.
B2xx xxxx	It may indicate a Logical partition error.
B350 420A	It may indicate a software installation error. See <a href="#">Common reference codes for i5/OS software installation</a> for more information.
B427 xxxx	It may indicate a system processor failure.
B428 xxxx	It may indicate a system processor failure.
B437 xxxx	It may indicate a system processor failure.
B448 xxxx	It may indicate a system processor failure.
B467 xxxx	It may indicate a system processor failure.
B4FF xxxx	It may indicate a system processor failure.
<b>B6xx xxxx</b>	Check for a specific B6xx SRC. If you do not see your SRC, it can mean a Licensed Internal Code error was detected.

<b>SRC</b>	<b>What it means</b>
B600 500x	It may indicate an Operations Console error. See <a href="#">Troubleshooting system reference code data</a> .
B600 53xx	It may indicate a Logical partition error.
B608 1105	It may indicate a software installation error. See <a href="#">Common reference codes for i5/OS software installation</a> for more information.
<b>B9xx xxxx</b>	Check for a specific B9xx SRC. If you do not see your SRC, it can mean an IBM i IPL failure. See <a href="#">“Recovering from IPL or system failures”</a> on page 18.
B900 3000	Unexpected exception in bootstrap loader (QINITT/QINTO). See <a href="#">Common reference codes for IBM i software installation</a> for more information.
B900 3001	Error in interface to console from bootstrap loader (QINITT/QINTO).
B900 3002	Error in REQIO of create and load of QINSTALL.
B900 3003	Could not find name to use for device drive in bootstrap loader (QINITT/QINTO).
B900 3004	Wait time-out on event.
B900 3005	Unexpected return code from console in installation.
B900 3006	Unexpected feedback code from device processing in installation.
B900 3007	Unexpected exception during installation.
B900 3008	Operator cancelled job in response to message.
B900 3009	Exception in installation after termination condition found.
B900 3010	Cannot find required user profile in last part of installation.
B900 3011	Cannot find system object in QINFIXUP.
B900 3012	Previously unmarked damage detected by installation.
B900 3013	QINSTALL not found in QSYS.
B900 3014	Could not start CPF process.
B900 3015	Terminating error message issued from install.
B900 3016	Link/Load VMC MRI failure.
B900 3070	Build routines could not find QLINMTBL.
B900 3071	Build routines could not find library listed in QLINMTBL.
B900 308F	Unexpected install error (bad optical label, function, object type)
B900 3100	QSYS library NOT found.
B900 3110	QSYS library damaged.
B900 3115	Machine context needs to be reclaimed.
B900 3120	The installation communication object (QICO) has been damaged. The user must reinstall the operating system and should request the same install options that were requested previously.
B900 3121	The user has tried to IPL the system after a failed install. The user must reinstall to be able to recover from this error.
B900 3130	An error occurred before the QWCSCPF data object exists. (Called the PCO during ICPF.) (No machine 'message' area.)

<b>SRC</b>	<b>What it means</b>
B900 3140	System object NOT found.
B900 3150	System program NOT found.
B900 3160	System library NOT found.
B900 3170	Authorized user table could not be found. Install required.
B900 3175	Duplicate APPC devices found when setting network attributes after MISR has been reset.
B900 3180	Not enough main storage to setup minimums for Machine and *BASE pools.
B900 3190	Failure to initiate the Start CPF process.
B900 31A0	Resolve - recoverable object test failure.
B900 31B0	Unknown resolve failure.
B900 31C0	Damage has been detected in a RECOVERABLE system object required for Start CPF. The object has been destroyed and will be recreated on the next IPL.
B900 31D0	Damage has been detected in a RECOVERABLE system library required for Start CPF. The library will be recovered by the machine on the next IPL.
B900 31E0	Damage has been detected in an UNRECOVERABLE system object required for Start the operating system. The user must reinstall CPF.
B900 31F0	Initial CPF process default exception handler (QWCIPDEH). Error: recursive exceptions.
B900 31FF	Function check exception in the Initial CPF process.
B900 3210	QSYS library NOT found.
B900 3220	Function check exception before resolve to QWCSCPF object.
B900 3240	System object NOT found.
B900 3250	System program NOT found.
B900 3260	System library NOT found.
B900 3270	Not authorized to user console during automatic install.
B900 3278	Unable to access the System console during automatic install.
B900 3280	Unable to use installation profile during automatic install.
B900 32D0	Authorized user table could not be found. Install required.
B900 32E0	Authorized user table change password error. Re-IPL.
B900 3300	DST didn't select a console for SCPF to use on an attended IPL.
B900 3308	DST didn't select a console for CPF to use on an attended IPL during an install.
B900 3310	DST used Alternative console.
B900 3318	DST used Alternative console during an install.
B900 3320	DST still has control of the console.
B900 3328	DST still has control of the console during an install.
B900 3340	Unable to delete a damaged System console controller description.

<b>SRC</b>	<b>What it means</b>
B900 3348	Unable to delete a damaged System console controller description during an install.
B900 3350	Unable to delete a damaged System console description.
B900 3358	Unable to delete a damaged System console description during an install.
B900 3360	Unable to create the System console controller description.
B900 3368	Unable to create the System console controller description during an install.
B900 3370	Unable to create the System console description.
B900 3378	Unable to create the System console description during an install.
B900 337C	Unable to create the system console description because a double-byte device is on a non-double-byte system.
B900 337D	During an install, we are unable to create the System console description because a double-byte device is on a non-double-byte system.
B900 3380	Unable to resolve to controller description following creation.
B900 3388	Unable to resolve to controller description following creation during an install.
B900 3390	Unable to resolve to console description following creation.
B900 3398	Unable to resolve to console description following creation during an install.
B900 33A0	Unable to vary-on the System console controller.
B900 33A8	Unable to vary-on the System console controller during an during an install.
B900 33B0	Unable to vary-on the System console.
B900 33B8	Unable to vary-on the System console during an install.
B900 33F0	While working with the console and/or controller, a FC occurred.
B900 33F8	While working with the console and/or controller during an install, a FC occurred.
B900 3400	Installation object QICO exists, but this is an unattended IPL. Reinstall the operating system.
B900 3430	Start CPF display file missing. Value in QSCPFCONS system value does NOT allow IPL to continue
B900 3440	Database recovery termination error.
B900 3460	Installation (PART 2) error.
B900 3490	Signon display file, QDSTRCPF, could not be opened by Start CPF. Value in QSCPFCONS system value does NOT allow the IPL to continue.
B900 3498	I/O error occurred during sign on. Value in QSCPFCONS system value does NOT allow the IPL to continue.
B900 34B0	Signon limit exceeded.
B900 35B0	Failure to resolve to the controlling subsystem description.
B900 3600	Damage has been detected in a spooling related object that requires the user to IPL the system and specify a 'clear' of the spool input and output queues.
B900 3610	The job table is full. Perform an attended IPL and increase the QMAXJOB system value.

<b>SRC</b>	<b>What it means</b>
B900 3630	Damage has been detected in a recoverable system object that is required for Start CPF. The object has been destroyed and will be recovered on the next IPL.
B900 3660	Job table recovery error.
B900 3690	Failure to initiate the System Arbiter process.
B900 36A0	Failure to initiate critical system job.
B900 3700	Controlling SBSB damaged.
B900 3730	User not authorized to the controlling subsystem SBSB.
B900 3760	Controlling SBSB lock wait timeout.
B900 37B0	Function check exception while starting the controlling subsystem.
B900 37C0	Unable to Monitor 'NEVER' event.
B900 37D0	Recoverable object test failure from a resolve.
B900 37E0	Damage has been detected in an installed system object that is required by Start CPF. The object can be recovered by a re-install of the operating system.
B900 37F0	Unknown resolve failure.
B900 37FF	Function check exception in the Start CPF process.
B900 3810	Unexpected termination of the controlling subsystem.
B900 3820	Tampering occurred in operating system product load.
B900 3830	QSYS library NOT found.
B900 3850	QWCSCPF (Start CPF) data object cannot be found.
B900 3870	System object NOT found.
B900 3890	System program NOT found.
B900 38E0	System arbiter initial function had function check exception.
B900 38F0	System arbiter initial function had function check exception while handling a function check exception.
B900 3C10	Unexpected function check exception in controlling SBS monitor process during monitor startup.
B900 3C20	No *SIGNON type console job entry in SBSB of the controlling subsystem.
B900 3C50	Unexpected function check exception in controlling SBS monitor process during monitor shutdown.
B900 3C60	Requestor device unusable by the controlling subsystem monitor (during monitor shutdown to the restricted state OR the system startup to the restricted state).
B900 3C80	Miscellaneous termination of the controlling subsystem from an active monitor. Reason could be damaged SBSB or monitor queue.
B900 3CF0	Signon limit exceeded -- This occurred when the requester is the last source of work in the system.
B900 3CFF	Unknown controlling subsystem termination code.
B900 3D10	Auditing failure occurred when sending an audit record to the audit journal with QAUDENDACN set to *PWRDWNYS.

<b>SRC</b>	<b>What it means</b>
B900 3E10	System arbiter process queue space had unexpected failure.
B900 3E20	System arbiter process queue space is full.
B900 3E30	SCPF process queue space had unexpected failure.
B900 3E40	SCPF process queue space is full.
B900 3E50	QCPFMSG message file is damaged.
B900 3E51	QCPFMSG message file is not found.
B900 3F10	Immediate power down time limit expired. At least one active subsystem had not terminated within the time limit.
B900 3F40	System arbiter had function check exception while processing an immediate power down. Damage of some kind is probable.
B900 3F60	System arbiter had function check exception during device configuration shutdown processing.
B900 3F70	System arbiter had function check exception during LUS termination in QWCASCUE.
B900 3FA0	Function check exception while processing the subsystem monitor process termination event.
B900 3FB0	Function check exception while processing the subsystem monitor process termination event.
B900 3FC0	System arbiter had multiple function checks during subsystem process termination.
B900 3FFF	An error occurred which caused the system arbiter process to terminate unexpectedly.

## **C**

These SRCs start with C.

<b>SRC</b>	<b>What it means</b>
C1xx xxxx	These SRCs show the Status of an IPL. See the <a href="#">IPL SRC finder</a> for details, then perform <a href="#">“Recovering from IPL or system failures”</a> on page 18.
C2xx xxxx	These SRCs show the Status of an IPL. See the <a href="#">IPL SRC finder</a> for details, then perform <a href="#">“Recovering from IPL or system failures”</a> on page 18.
C3xx xxxx	These SRCs show the Status of an IPL. See the <a href="#">IPL SRC finder</a> for details, then perform <a href="#">“Recovering from IPL or system failures”</a> on page 18.
C5xx xxxx	These SRCs show the Status of an IPL. See the <a href="#">IPL SRC finder</a> for details, then perform <a href="#">“Recovering from IPL or system failures”</a> on page 18.
C6xx xxxx	These SRCs show the Status of an IPL. See the <a href="#">IPL SRC finder</a> for details, then perform <a href="#">“Recovering from IPL or system failures”</a> on page 18.
C9xx xxxx	These SRCs show the Status of an IPL. See the <a href="#">IPL SRC finder</a> for details, then perform <a href="#">“Recovering from IPL or system failures”</a> on page 18.
CAxx xxxx	These SRCs show the Status of an IPL. See the <a href="#">IPL SRC finder</a> for details, then perform <a href="#">“Recovering from IPL or system failures”</a> on page 18.

## **D**

These SRCs start with D.

<b>SRC</b>	<b>What it means</b>
<b>D1xx xxxx</b>	Check for a specific D1xx SRC. If you do not see your SRC, then the SRC is reporting IPL status. This is a normal indication while the system main storage is being saved to disk. See the <a href="#">IPL SRC finder</a> for details.  If the system is still not running correctly after 30 minutes, contact your hardware service provider.
D1xx 3xxx	Service Processor Main Storage Dump status reference code. This is a normal reference code showing the status of the system when performing a main storage dump.  You may suspect that the system is not operating correctly when the rightmost characters do not change for 2 minutes.  <b>Note:</b> It takes approximately 1 minute to dump each 20MB of main storage.
D100 80xx	Operations Console error. See <a href="#">Troubleshooting system reference code data</a> .
D2xx xxxx	These SRCs show the Status of an IPL. This is a normal indication while the panel functions and system code are powering down the system. See the <a href="#">IPL SRC finder</a> for details, then perform “ <a href="#">Recovering from IPL or system failures</a> ” on page 18.
D6xx xxxx	These SRCs show the Status of an IPL. This is a normal indication while the system is being powered down. See the <a href="#">IPL SRC finder</a> for details.  If the system does not start normally after 30 minutes, call your software service representative. When xxxx is changing, the system is doing a main storage dump.
D9xx xxxx	These SRCs show the Status of an IPL. See the <a href="#">IPL SRC finder</a> for details, then perform “ <a href="#">Recovering from IPL or system failures</a> ” on page 18.
DAxx xxxx	These SRCs show the Status of an IPL. See the <a href="#">IPL SRC finder</a> for details, then perform “ <a href="#">Recovering from IPL or system failures</a> ” on page 18.

## **E**

These SRCs start with E.

<b>SRC</b>	<b>What it means</b>
E600 xxxx	It may indicate a control panel failure.

## **F**

These SRCs start with F.

<b>SRC</b>	<b>What it means</b>
F000 xxxx	It may indicate a control panel failure.

### **Related concepts**

[System reference codes](#)

A *system reference code (SRC)* is a set of eight characters that identifies the name of the system component that detects the error codes and the reference code that describes the condition.

### **Related tasks**

[Starting problem analysis](#)

If you are having a problem on your system, follow this procedure to narrow down the problem and to gather the necessary information to report to your next level of support.

## Performing a main storage dump

A main storage dump (MSD) is a process of collecting data from the system's main storage. It can be done in these ways.

- **Automatically.** By the service processor as the result of a system failure.
- **Manually.** By performing a function 22 on the control panel when the system waits, loops, or appears to have an operating system failure. You can perform this task by selecting option 22 from the Work with partition status display.

Choose the task that you want to perform:

- Perform an automatic main storage dump
- Perform a manual main storage dump
- Perform a manual main storage dump on a logical partition
- Copy a current main storage dump
- Report a main storage dump
- Delete a main storage dump

### Related tasks

[Recovering from system hang or loop condition](#)

To resolve system hang or loop conditions, follow this procedure.

## Performing an automatic main storage dump

After a failure that causes the system to perform a main storage dump (MSD), the Main Storage Dump Occurred display is shown

When that occurs, go to [“Copying a current main storage dump”](#) on page 35.

## Performing a manual main storage dump

You can perform a manual main storage dump on a primary partition or a system without logical partitions.

To place the data from the system's main storage to the load-source disk, perform the following steps:

1. If your system has logical partitions, try to power them off.
2. Verify that no interactive jobs are running.
  - a. Select **Manual** mode.
  - b. Use the Increment/Decrement buttons to display function 22 (main storage dump).
  - c. Press Enter on the control panel.
3. Is 0000 0000 displayed on the control panel for more than 30 seconds?
  - **Yes:** The multiple function input/output processor (IOP) or service processor is not responding to a request from the control panel. Go to [“Reporting problems overview”](#) on page 39. **This ends the procedure.**
  - **No:** An attention SRC, A1xx 3022, is displayed, which indicates that function 22 has been selected.
4. Reselect function 22, press Enter on the control panel, and wait for the dump to complete. When the dump is complete, the Main Storage Dump Occurred display is shown. The appearance of an A1D0 300x or A6Dx 3000 SRC on the Main Storage Dump Occurred display indicates a successful manual MSD.
5. Go to [“Reporting a main storage dump”](#) on page 36. **This ends the procedure.**



## Performing a manual main storage dump on a logical partition

To perform a manual main storage dump on a logical partition, follow this procedure.



**Attention:** Only perform a secondary partition main storage dump (MSD) if you are under the direction of software support.

To place the data from the system's main storage to the load-source disk, perform the following steps:

1. On the logical partition or on the primary partition, start Dedicated Service Tools (DST).
2. Select option 11 (Work with system partitions).
3. Select option 2 (Work with partition status).
4. Select the logical partition on which you want to perform the MSD. Initiating a MSD against the primary partition is equivalent to initiating a MSD from the control panel.
5. Is the partition in Manual mode?
  - **Yes:** Continue to the next step.
  - **No:** Select option 10 (Mode manual).
6. Select option 22 (Force Main Storage Dump).
7. Select option 10 to confirm. Wait for the dump to complete. When the dump is complete, the Main Storage Dump Occurred display is shown on the selected logical partition.
8. The appearance of an A1D0 300x or A6Dx 3000 SRC on the Main Storage Dump Occurred display indicates a successful manual MSD.
9. Go to [“Reporting a main storage dump” on page 36.](#)

## Copying a current main storage dump

To copy a main storage dump (MSD) to a predefined storage area on the system, and to prevent an MSD from being overwritten when another dump occurs, complete these steps.

1. From the Main Storage Dump Occurred display, press Enter. The Main Storage Dump Manager appears.
2. Select option 1 (Work with current main storage dump). The Work with Current Main Storage Dump display appears.
3. Select option 1 (Display/Print). The Display Main Storage Dump display appears.
4. Select option 1 (MSD summary). The Main Storage Dump Summary display appears. This display shows the system reference code, date, and time of the MSD, and Licensed Internal Code level.
5. Record the summary information and report it to your service provider.
6. Press F12 (Cancel) twice to return to the Main Storage Dump Manager display.
7. Select option 3 (Copy to ASP). The Copy Main Storage Dump to ASP display appears.
8. Type a dump description, and then press Enter to start copying the dump. After the dump is copied, a message is displayed indicating whether the MSD copy operation completed.
9. Did a message indicate Copy completed normally?
  - **Yes: This ends the procedure.**
  - **No:** Continue with the next step.
10. Has your service provider requested a tape copy of the MSD?
  - **Yes:** Continue to the next step.
  - **No:** Work with your service provider on the problem.
11. To copy MSD to a tape device, follow these steps:
  - a. Select option 2 (Copy to media). The Copy Main Storage Dump to Media display appears.
  - b. Load the media and follow the instruction on the display.

- c. When the copy procedure is successfully completed, process the tape according to your service provider's instruction. If you encounter a problem with the copy procedure, contact your service provider. **This ends the procedure.**

## Reporting a main storage dump

If your system has the main storage dump enabled for auto copy, your system might have automatically copied the current MSD to the auxiliary storage pool (ASP), using the dump description Auto Copy. Your system might have the program initially loaded again on the system.

To report a main storage dump, follow these steps:

1. On any command line, enter STRSST.
2. Select option 1 (Start a service tool). The Start a Service Tool display is shown.
3. Select option 6 (Main storage dump manager). The Main Storage Dump Manager display is shown.
4. Select option 2 (Work with copies of main storage dumps). The Work with Copies of Main Storage Dumps display is shown.
5. Find the dump with the description of Auto Copy and select option 5 (Display/Print). The Display Main Storage Dump display is shown.
6. Select option 1 (MSD Summary). The Main Storage Dump Summary display is shown. This display shows the system reference code, date, and time of the MSD, and Licensed Internal Code level. Report the summary information to your service provider.
7. Press F3 (Exit) to return to the Work with Copies of Main Storage Dumps Display.
8. If the dump has a description of Auto Copy, rename it so that another auto copy and re-IPL can occur if necessary.
  - a. Select option 7 (Rename). The Rename Main Storage Dump display is shown.
  - b. Type a new dump description, and press Enter.
9. Has your service provider requested a tape copy of the MSD?
  - **Yes:** Continue to the next step.
  - **No:** Work with your service provider on the problem.
10. To copy an MSD to a tape device, perform the following steps:
  - a. Select option 8 (Copy to media). The Copy Main Storage Dump to Media display appears.
  - b. Load the media and follow the instructions on the display.
  - c. When the copy procedure is successfully completed, process the tape according to your service provider's instruction. If you encounter a problem with the copy procedure, contact your service provider.
11. Continue with [“Deleting a main storage dump” on page 36.](#)

## Deleting a main storage dump

When dump copies are no longer needed by your service representative, follow this procedure to delete them.

1. From any command line, enter STRSST.
2. Select option 1 (Start a service tool). The Start Service Tool display is shown.
3. Select option 6 (Main storage dump manager). The Main Storage Dump Manager display is shown.
4. Select option 2 (Work with copies of main storage dumps). The Work with Copies of Main Storage Dumps display is shown where you can see the list of dump copies.
5. If you want to delete any dump copies, type 4 next to the dump copies, and press Enter twice.
6. To exit SST, press F3 (Exit) three times, and then press Enter.

## CL commands for problem analysis

You can use the problem analysis control language (CL) commands to help you manage problems that you are experiencing with your system.

### Related concepts

#### Using the Verify Tape command

To verify whether the specified tape unit is operating, use the Verify Tape (VFYTAP) command.

#### Problem-handling menus

Problem-handling menus can help you analyze problems that occur on your system.

### Related tasks

#### Using the Analyze Problem command

To start problem analysis for user-detected problems, use the Analyze Problem (ANZPRB) command.

#### Using the Verify Communications command

The Verify Communications (VFYCMN) command allows you to verify either remote or local communications equipment.

#### Using the Work with Alerts command

When the system detects a problem, the service requester sends it to the service provider. To remotely analyze the system-detected problems, use the Work with Alerts (WRKALR) command.

#### Using the Work with Problems command

With the problem analysis, you can gather more information about the problem and determine whether to solve it or to report it without the help of a hardware service provider.

## Problem-handling menus

Problem-handling menus can help you analyze problems that occur on your system.

Your system problems can originate from the following areas:

- Job or programming
- System performance
- Equipment
- Communications

If you are experiencing problems with your system, use the following problem-handling menus to help analyze problems. The order of the menus listed is from basic skill level to advanced skill level.

- Solving user problems using the GO USERHELP menu. This menu is for the novice who wants to learn about using help and who needs help in analyzing problems.
- Solving problems using the GO PROBLEM menu. This is the main menu for working with problems.
- Solving system problems using the GO PROBLEM2 menu. This menu allows you to work with programming problems and system performance.
- Solving system problems using the GO TECHHELP menu. Use this menu if you encounter problems related to system operation.
- Solving network problems using the GO NETWORK menu. This menu allows you to manage and use network communications.
- Solving network problems using the GO NETPRB menu. This menu allows you to handle problems that relate to communications.

### Related concepts

#### CL commands for problem analysis

You can use the problem analysis control language (CL) commands to help you manage problems that you are experiencing with your system.

#### Using authorized program analysis reports

An *authorized program analysis report (APAR)* is an IBM-supplied program that allows you to create a diskette file or a tape file. The file contains information from your system to help software service representatives to correct programming problems.

### **Related tasks**

#### Using the USERHELP menu

This menu is for the novice who wants to learn about using help and who needs help in analyzing problems.

#### Using the PROBLEM menu

The problem-handling (PROBLEM) menu is the main menu for working with problems.

#### Using the PROBLEM2 menu

The second problem-handling (PROBLEM2) menu is an extension of the PROBLEM menu.

#### Using the TECHHELP menu

If you encounter a problem that relates to system operations, start with the Technical Support Tasks (TECHHELP) menu.

#### Using the NETWORK menu

From the network management (NETWORK) menu, you can manage and use network communications.

#### Using the NETPRB menu

From the network problem-handling (NETPRB) menu, you can handle problems that relate to communications.

## **Using authorized program analysis reports**

An *authorized program analysis report (APAR)* is an IBM-supplied program that allows you to create a diskette file or a tape file. The file contains information from your system to help software service representatives to correct programming problems.

The APAR procedure creates one or more diskette files or tape files that contain information about the following areas:

- Control storage dump area. This area is control-block storage that is used by the Licensed Internal Code.
- Input/output controller storage dump area.
- The system work area (if you are not running the APAR procedure during IPL after a system dump), including the following information:
  - The system configuration
  - The disk Volume Table of Contents (VTOC)
  - The #SYSWORK index
  - The trace work area
  - The security work area
  - The program temporary fix (PTF) work area
  - The diskette VTOC
  - The volume label
  - The IPL bootstrap
- PTF logs for the IBM licensed program library and system library.
- The system service log.
- The disk trace files. If you do not run the APAR procedure during startup, and you do not copy a task dump, then the system displays a trace file prompt and you can select up to 16 trace files to copy.
- Microcode tables.
- Task dump file (optional).
- The history file.

- The spooled file (optional).
- The job queue (optional).
- The message file (optional).
- The product-level data file.

The APAR procedure can copy a specified load member to a file named APARLOAD, a specified source member to a file named APARSRCE, or a specified procedure member to a file named APARPROC, which can be saved to diskette or tape. When the APAR procedure begins running, you can select the spooled file, job queue, message file, and user file index that the system copies. Most of the data areas that are copied can be displayed using the DUMP procedure.

## Using APARs to collect diagnostic information

After you have performed a system dump, run the authorized program analysis report (APAR) procedure during an IPL. The procedure requires an attended IPL.

To perform the APAR procedure, enter the following command:

```
APAR valid,[object],[source],[proc],[dumpfile],[S1],[AUTO/NOAUTO],[I1/TC/T1/T2]
```

### Related concepts

[Problem-handling menus](#)

Problem-handling menus can help you analyze problems that occur on your system.

[Using authorized program analysis reports](#)

An *authorized program analysis report (APAR)* is an IBM-supplied program that allows you to create a diskette file or a tape file. The file contains information from your system to help software service representatives to correct programming problems.

### Related reference

[Details: Authorized program analysis report](#)

You can use these parameters for understanding the authorized program analysis report (APAR) command.

[Save APAR Data \(SAVADATA\) command](#)

[Restore APAR Data \(RSTAPARDTA\) command](#)

## Reporting problems overview

---

You need to know what information you should gather about the problem, how to report and track problems, and how to send a service request to IBM.

For problems with software or Licensed Internal Code, you need to notify the IBM service and support of the failure and related symptoms. The problems that are detected by the system can be reported either manually or automatically.

If a problem is new, a Problem Management Record (PMR) is created by the IBM service and support. The PMR number is returned to your system. If the problem occurs again, you can resend the problems that are already sent (SENT or ANSWERED status). When the problem is resent, an updated PMR associated with the original PMR is created. A note is added to the end of the PMR, which says: Call completed as a duplicated, original PMR is: nnnnn.

You can submit feedback about a reported problem by adding notes to the problem log so that problems already sent can be resent with new data. You can also request PMR closure and provide any other kind of feedback to IBM. Text is added to the PMR if you request a PMR closure.

If voice support (telephone) is available when you contact IBM, an IBM service and support will contact you if requested, and work with you to resolve the problem. If you do not have voice support, you can view the response from the IBM service and support by using the Query Problem Status (QRYPRBSTS) command.



- Go to the system control panel to find and record the value for functions 05, 11, 12, and 13. See “Collecting system reference codes” on page 15 for step-by-step instructions on finding system reference codes. Use the grid below to record the characters shown on the Function/Data display.
- Set the same mode as recorded in step 1 of this form.

Comments: \_\_\_\_\_

<b>05</b>	----- ----- -----
<b>11</b>	----- ----- -----
<b>12</b>	----- ----- -----
<b>13</b>	----- ----- -----
<b>20</b>	----- ----- -----

### Problem summary form for single partition (on models other than 270 and 8xx)

This is the problem summary form for a single partition (on models other than 270 and 8xx).

Date and time that the problem occurred:      \_\_\_\_/\_\_\_\_/\_\_\_\_\_:\_\_:\_\_  
 PRM or service request number:                      \_\_\_\_\_  
 Describe the problem:                                      \_\_\_\_\_

Message ID	Message Text	From/Send Program	Instruction Number	To/Receive Program	Instruction Number
-----	-----	-----	-----	-----	-----
-----	-----	-----	-----	-----	-----
-----	-----	-----	-----	-----	-----

- Record the mode.
- Set the mode to Manual.
- Place a check on the lines below to indicate which lights on the panel are on. Refer to [Working with the control panel](#) for the system units for a diagram of the control panel.

-----      Power On  
 -----      Processor Active/Activity  
 -----      System Attention

- Press the Increment/Decrement buttons until 11-3 is shown in the Function/Data display. Press the Enter pushbutton.
- Record the 8 characters shown in the Data display for function 11-3.

**05**                      \_\_\_\_\_

<b>11xx</b>	_____
<b>12xx</b>	_____
<b>13xx</b>	_____
<b>14xx</b>	_____
<b>15xx</b>	_____
<b>16xx</b>	_____
<b>17xx</b>	_____
<b>18xx</b>	_____
<b>19xx</b>	_____
<b>20xx</b>	_____

Some systems do not show 05 on the Function/Data display.

6. Press the Increment button. This action steps the Function/Data display to the next higher number (12, 13, and so on) and blanks the Data display.
7. Press the Enter pushbutton. This action shows a new set of 8 characters in the Data display. Record this data on the form.
8. Repeat steps "6" on page 42 and "7" on page 42 until data has been recorded through function 20. All functions may not be displayed, depending on the failure.
9. Set the same mode as recorded in step "1" on page 41 of this form. Press the Increment/Decrement buttons until the number 11-3 is shown in the Function/Data display. Press the Enter pushbutton. The original system reference code (SRC) appears.
10. Return to the step that sent you here.

Comments: \_\_\_\_\_

### Problem summary form for multiple partitions (model 8xx)

Here is the problem summary form for multiple partitions (model 8xx).

Date and time that the problem occurred: \_\_\_\_/\_\_\_\_/\_\_\_\_:\_\_:\_\_

Partition state: \_\_\_\_\_

Partition ID: \_\_\_\_\_

Partition version: \_\_\_\_\_

Partition release: \_\_\_\_\_

Describe the problem: \_\_\_\_\_

<b>Message ID</b>	<b>Message Text</b>	<b>From/Send Program</b>	<b>Instruction Number</b>	<b>To/Receive Program</b>	<b>Instruction Number</b>
_____	_____	_____	_____	_____	_____
_____	_____	_____	_____	_____	_____
_____	_____	_____	_____	_____	_____

1. Record the mode.
2. From the Work with Partitions display, use option 10 to set the mode to Manual. For help getting to this display, refer to [Accessing control panel functions](#).
3. Place a check on the lines below to indicate which lights on the panel are on. Refer to [Working with the control panel](#) for the system units for a diagram of the control panel.
  - \_\_\_\_\_ Power On



- \_\_\_\_\_ Processor Active/Activity
  - \_\_\_\_\_ System Attention
4. On the following grid, record the characters shown on the Display Partition Status display for functions 05, 11, 12, 13. In the product activity log and other software displays, the system reference code (SRC) appears much like it does for earlier releases. One difference is that the first word has up to 32 characters of text. Another difference is that the word is a number from 1 to 9 instead of 11 to 19. This helps to avoid confusing the word number with the function number used to find it.
  5. Go to the system panel to find and record the value for function 20. See [“Collecting system reference codes”](#) on page 15 for step-by-step instructions.

## Problem summary form for multiple partitions (on models other than 8xx)

Here is the problem summary form for multiple partitions (on models other than 8xx).

**Date and time that the problem occurred:** \_\_\_\_\_/\_\_\_\_\_/\_\_\_\_\_:\_\_:\_\_

**Partition state:** \_\_\_\_\_

**Partition ID:** \_\_\_\_\_

**Partition version:** \_\_\_\_\_

**Partition name (optional):** \_\_\_\_\_

**Partition release:** \_\_\_\_\_

**Describe the problem:** \_\_\_\_\_

Message ID	Message Text	From/Send Program	Instruction Number	To/Receive Program	Instruction Number
_____	_____	_____	_____	_____	_____
_____	_____	_____	_____	_____	_____
_____	_____	_____	_____	_____	_____

1. Record the mode.
2. From Work with Partitions display, use option 10 to set the mode to Manual. For help getting to this display, refer to [Accessing control panel functions](#).
3. Place a check on the lines below to indicate which lights on the panel are on. Refer to [Working with the control panel](#) for the system units for a diagram of the control panel.

\_\_\_\_\_ Power On

\_\_\_\_\_ Processor Active/Activity

\_\_\_\_\_ System Attention

4. Record the 8 characters shown in the Display Partition Status display for Reference Codes 11x through 19xx.

**05** \_\_\_\_\_

**11xx** \_\_\_\_\_

**12xx** \_\_\_\_\_

**13xx** \_\_\_\_\_

**14xx** \_\_\_\_\_

**15xx** \_\_\_\_\_

**16xx** \_\_\_\_\_

**17xx** \_\_\_\_\_  
**18xx** \_\_\_\_\_  
**19xx** \_\_\_\_\_  
**20xx** \_\_\_\_\_

5. Go to the system control panel to find and record the value for the 20xx Reference Code.
6. Set the same mode as recorded in step “1” on page 43 of this form.
7. Return to the step that sent you here.

Comments: \_\_\_\_\_

## Contacting IBM support

Here are the contacts you can use to obtain services and support for your IBM i platform.

In general, the term *service* includes repair of hardware, the ability to ask usage and defect questions about your software, and on-site and remote support for any system concerns through IBM services.

Type of problem	Call
<ul style="list-style-type: none"> <li>• Advice</li> <li>• Migrating</li> <li>• "How to"</li> <li>• Operating</li> <li>• Configuring</li> <li>• Ordering</li> <li>• Performance</li> <li>• General information</li> </ul>	<ul style="list-style-type: none"> <li>• 1-800-IBM-CALL (1-800-426-2255)</li> <li>• 1-800-IBM-4YOU (1-800-426-4968)</li> </ul>
<p><b>Software:</b></p> <ul style="list-style-type: none"> <li>• Fix information</li> <li>• Operating system problem</li> <li>• IBM application program</li> <li>• Loop, hang, or message</li> </ul> <p><b>Hardware:</b></p> <ul style="list-style-type: none"> <li>• IBM system hardware broken</li> <li>• Hardware system reference code (SRC)</li> <li>• IBM input/output (I/O) problem</li> <li>• Upgrade</li> </ul>	<p>1-800-IBM-SERV (1-800-426-7378)</p>

When reporting suspected software problems, you need to provide the following information.

### Contact information

Send the following contact information that must be supplied to the IBM support center when a problem is reported or a PTF (program temporary fix) is requested:

- Name of the person who is responsible for the repair and maintenance of the system
- Electronic mailing address of the organization
- Language code that indicates your preferred language for PTF cover letters
- IBM-assigned customer number that uniquely identifies the customer

- IBM-assigned contract number that uniquely identifies the services contract
- Telephone number
- Fax number
- Media for mailing PTFs
- Whether you want your central site support desk called by an IBM service representative or the product support center
- System type and serial number

### **Problem description**

Include the following information when describing the problem you are experiencing with your system:

- The name of the software product you are using, including the version and release
- The cumulative PTF level of the system
- The problem symptom
- Message numbers, messages, and return codes associated with the problem
- A list of the steps needed to re-create the problem
- A list of any actions you have already taken
- A copy of the job log

### **Additional information for communications problems**

If the problem you are experiencing relates to a communications error, include the following information:

- Identify all systems and locations involved in the problem.
- Identify the communications method and connection used between the systems.
- Collect messages from all systems that are involved in the problem.
- Identify any recent changes or upgrades that have been made to any of the involved systems.

### **Additional information for IBM i Access problems**

If the problem you are experiencing relates to the IBM i Access products, provide the following additional information:

- All systems and locations involved in the problem.
- The topology between IBM i and the client system.
- The functions of IBM i Access that you are using.
- All resources that are involved.
- The operating system of the client system.
- Any major applications that are affected by the problem.
- Hardware attachments involved in the problem.
- Any recent changes or upgrades to any involved system.
- Any messages logged in QSYSOPR or on the client system.

### **Related reference**

[Directory of worldwide contacts](#)

## **Reporting problems detected by the system**

The system problem log contains a list of all the problems recorded on the system.

To report a problem that has an entry in the problem log, perform the following steps:

1. Type WRKPRB on any command line and press Enter. The Work with Problems (WRKPRB) display is shown.
2. If you have a problem ID, look for an entry with the same ID on the Work with Problems display. Select option 8 (Work with problem) for the problem you want to work with and press Enter. The Work with Problem display is shown.
3. Select option 2 (Report problem) and press Enter. The Verify Contact Information display is shown.
4. To change any fields that are displayed, type over the current information and press Enter. The system includes the new information in the service request.
5. Select the severity level that closely relates to the severity of your problem on the Select Problem Severity display.
6. Select who receives and processes your request on the Select Service Provider display.
7. Select when and how you want to send the service request on the Select Reporting Option display.
8. Choose from the following options:
  - To report the problem automatically, continue with Report problems automatically.
  - To report the problem by voice, perform the following steps:
    - a. Select option 3 (Report service request by voice). The telephone number of the service provider for your specific problem is displayed. If the service provider is IBM, a service number is assigned to the problem.
    - b. To put this number in the problem log, press F14 (Specify service-assigned number).

### Related tasks

#### Starting problem analysis

If you are having a problem on your system, follow this procedure to narrow down the problem and to gather the necessary information to report to your next level of support.

#### Using the Analyze Problem command

To start problem analysis for user-detected problems, use the Analyze Problem (ANZPRB) command.

## Tracking problems

You have several ways to track the problems that occur on your system, such as querying problem status, finding a previously reported problem, and adding notes to a problem record.

### Querying problem status

You can retrieve the latest status of a previously reported problem in different ways.

#### Related concepts

##### Reporting problems overview

You need to know what information you should gather about the problem, how to report and track problems, and how to send a service request to IBM.

### ***Querying problem status using the QRYPRBSTS command***

You can use the Query Problem Status (QRYPRBSTS) command to find the latest status of a reported problem.

1. Type QRYPRBSTS on any command line, and press the F4 key. The Query Problem Status (QRYPRBSTS) display is shown.

**Note:** Currently, the QRYPRBSTS command is not enabled to query hardware problems.
2. If you know the problem management record (PMR) number, type \*PMR in the **Problem identifier (ID)** field and press Enter. Additional fields are shown on the display. If you know the problem identifier number, type the 10-digit ID number for the problem in the **Problem identifier** field and press Enter. If you do not know the problem ID number, see [Finding a previously reported problem](#) for instructions on how to find this 10-digit number.

- Type the service number in the **Service number** field and press Enter.
- Type the branch number in the **Branch number** field and press Enter.
- Type the country or region number in the **Country or region number** field and press Enter.

**Note:** Both the branch number and the country or region number cannot contain blanks and must contain only three digits, 0 - 9.

3. After the query is complete, enter `WRKPRB xxxxxxxxxx` (where xxxxxxxxxx is the 10-digit problem ID number). The Work with Problem (WRKPRB) display is shown.
4. Type option 12 (Enter text) next to the problem entry and press Enter. The Select Text Type display is shown.
5. Select option 10 (Query Status text). The Query results are shown.

### **Querying problem status using the WRKPRB command**

The other method to find the latest status of a reported problem is using the Work With Problem (WRKPRB) command.

1. Type `WRKPRB` on any command line and press the Enter key. The Work with Problems display appears.
2. Find the problem entry for which you want to query the status. To start a query, the problem entry must have a status of Answered or Sent.
3. Type option 8 (Work with problem) next to the problem entry. The Work with Problem menu appears.
4. Select option 41 (Query problem status text). The Results of the query are shown.

**Note:** The QRYPRBSTS command does not apply to problem entries that have a Fix request specified in the problem description column of the Work with Problem display.

### **Finding a previously reported problem**

To find a previously reported problem, you need to know the number assigned by the service representative, which is known as the Problem Management Record (PMR) number.

After you have this number, type the following command on any command line:

```
WRKPRB SRVID(xxxxx)
```

where xxxxx is the PMR number, then press the Enter key.

If you do not have the PMR number, refer to “Using the Work with Problems command” on page 66 and search the list for the problems with a status of SENT, VERIFIED, ANSWERED, and CLOSED.

For example, to view a list of reported problems, enter the following command:

```
WRKPRB SRVID(63348) BRANCH(694) COUNTRY(760)
```

This command shows a list of problems that have been reported to an IBM PMR number with a service ID number of 63348, a branch number of 694, and a country or region number of 760.

### **Adding notes to a problem record**

Through the texts you add to a problem record, you can submit feedback about a problem you had downloading a program temporary fix (PTF). Problems that are already sent can be resent to update the Problem Management Record (PMR) with new data. You can also request that a PMR be closed and provide any other kind of feedback to IBM.

To attach a note or to add a note to an existing note in the problem record, perform these steps.

1. Use the Work with Problem (WRKPRB) command.
2. Select option 12 (Enter text) on the Work with Problems display. The Select Text Type display appears.
3. Select option 1 (Problem description text) to enter the problem description. Only the text entered with this option is sent to the service provider along with the problem.

**Note:** If a problem is resented, a new PWR associated with the original PMR is created. A message like

```
Call completed as a duplicate, original PMR is: nnnnn
```

is added to the end of the PMR. You can include the PMR information to the note and that text is added to the PMR text.

Notes need to be typed in the following format to keep a chronological record of events:

- On the first line, type a brief description of the problem.
- On the second line, type the current date.
- On the third line, type the note that you want to send. Use as many additional lines (up to 20) as you need.

Include the following information in your notes:

- Any recent release update that you have applied to the system.
- Any changes you made in the system configuration.
- Any new program or feature that you are using.
- Anything that might be different since the last time the program, feature, or device ran without a problem.

## Reference information

---

Reference information tells you more about messages, message queues, logs, CL commands, problem-handling menus, Authorized Program Analysis Reports (APARs), and how to determine the primary or alternative console.

### Details: Messages

The details of messages, such as the types of messages and the ways to manage messages, can help you better understand and solve the problems that occur on your system.

#### Related concepts

##### Messages

*Messages* are communications that are sent from one person or program to another. Whether you are a system operator or user, you can communicate on your system by sending and receiving messages. System programs use messages to communicate system conditions.

### Types of messages

A variety of system messages are available to help you, such as error messages, printer messages, and alerts.

The system contains the IBM-supplied message files, which are stored in the system library, QSYS; the CPF message file, QCPFMSG (for the system and machine interface messages); and the licensed program message files, such as QRPMSG (for RPG messages). It is important to understand the message types before you handle messages:

- Error messages can indicate both simple and complex errors that relate to the system, devices, or programs.
- Alerts provide analysis on hardware or software resources.

#### Related reference

CL programming

## Error messages

A variety of system messages can indicate conditions that range from simple typing errors to problems with system devices or programs.

Error messages can be sent to a message queue or to a program and shown on a display. Messages might be one of the following messages:

- An error message on your current display.
- A message regarding a system problem that is sent to the system operator message queue, QSYSOPR.
- A message regarding a device problem that is sent to the message queue specified in a device description.
- A message regarding a potential severe system condition that is sent to the QSYSMSG message queue, the system operator message queue, and other message queues specified by the users.
- An unexpected error message that is not handled by a program (shown on the Display Program Messages display).

### Using error messages

Error messages play an important role in helping you fix the errors.

If you request a task that the system cannot run because of an error, an error message is shown at the bottom of the display. Depending on the display, the keyboard might also lock. To unlock the keyboard, press the Reset key.

**Note:** Displays of some application programs might not have message lines on the bottom of the display.

To obtain additional information about the error, take the following steps:

1. Move the cursor to the same line as the message. If you cannot move the cursor, go to Step [“2” on page 49](#).
2. Use option 5 (Display details and reply) to display additional information about the message. Press F9 to see message details such as the program and its instruction number causing the error. You might need to contact the owner of the program to fix the problem described in the error message.

### Related tasks

#### [Messages in a message queue](#)

Some messages in a message queue allow you to run problem analysis. This helps you resolve an error that you cannot resolve from the message or from the Additional Message Information display.

#### *Examples: Using error messages*

These examples show how to respond to error messages under varying circumstances.

### Example 1

The system sometimes sends error messages that require you to respond or select from a group of options. Based on the possible choices given (always in parentheses), this is generally a one-character response.

For example, notice the five possible choices for this message:

```
Verify alignment on device PRT01. (I C G N R)
```

Messages of this kind with possible choices most often appear on the system operator message queue. However, under certain circumstances, they can also appear on your own message queue.

You are not expected to know or remember the meanings of the numbers or letters in any reply. The Additional Message Information display provides information about each choice. In addition, this display also provides a reply line on which you can type your reply (if a reply is needed).

## Example 2

Suppose that you want to print a finished report. You send it to the printer, but it doesn't print. You check your message queue and find the following message:

```
End of forms on printer PRT01. (C H I PAGE 1-99999)
```

The computer wants you to reply, using one of the four choices that are shown (C H I PAGE 1-99999).

To get to the Additional Message Information display from the Work with Messages display (the basic assistance level), follow these steps:

1. Position the cursor on the option line in front of the message you want to respond to.
2. Select option 5 (Display details and reply).
3. When the Additional Message Information display appears, page down through the information to find the description of each reply value.

### *Messages in a message queue*

Some messages in a message queue allow you to run problem analysis. This helps you resolve an error that you cannot resolve from the message or from the Additional Message Information display.

These messages have an asterisk (\*) in front of them (intermediate assistance level) or are highlighted (basic assistance level).

- Basic assistance level: Shows the Work with Messages display. Press **option 5** to show the Additional Message Information display.
- Intermediate assistance level: Shows the Display Messages display. You can position the cursor to the message and press Help to show the Additional Message Information display.

**Note:** Messages about critical system errors or conditions are reverse-imaged (intermediate assistance level), or highlighted (basic assistance level). You can run problem analysis on the messages with an asterisk (\*) in front of them or if F14 is shown on the Additional Message Information display.

To analyze problems from the intermediate assistance level:

1. Move your cursor to any message with an asterisk and press F14.
2. From the Work with Problem (WRKPRB) display, you can display the details of the problem and work directly with the problem.

To run problem analysis from the basic assistance level for messages that are highlighted, select **option 5** (Display details and reply) for that message and press F14 (Work with problem).

### **Related tasks**

#### Using error messages

Error messages play an important role in helping you fix the errors.

### **Alerts**

An *alert* is a message that provides a quick and initial assessment of a problem and gives the network operator guidance on corrective actions.

An alert is automatically sent from any system in the network to the system that is designated to manage problems. For those problems that a network operator cannot correct, the alert provides information that a specialist can use to isolate the source of the problem.

Alerts inform the operator of problems with hardware resources, such as local devices or controllers, communications lines, or remote controllers or devices. Alerts can also notify the operator of software errors that are detected by the system or application programs. If the system is part of a communications network, alerts can be created and sent through the network to the problem-managing system.

You can use alerts to perform the following management activities:

- Monitor systems and devices that operate unattended.
- Manage situations in which the local operator does not know how to handle the problem.



- Maintain control of system resources and expense.

## Benefits of alerts

Alerts help you to manage your network and systems more effectively.

The following situations are examples of when you might use alerts:

- To reduce your system and network costs. Because the system automatically controls the capabilities of alerts, you can automate common responses to system problems without operator intervention.
- To monitor your network status. Alerts provide information about specific network problems that can help you track and monitor your system.
- To monitor unattended remote systems. Alerts can notify a central site about a problem on an unattended system.
- To have all your technical people at one location. When you use alerts, you can staff all of your technical support at one central site.
- To make your own applications have the same error-reporting capabilities as the system functions. Alerts give you the capability to define your own alertable messages.
- To provide the ability to choose where your technical support is located. When you use alerts, you can select which of your systems receive central technical support.
- When you manage a network with either homogeneous or heterogeneous systems. Because alerts are designed to be independent of the system architecture, alerts from one system are readable on other systems.

### *Displaying alerts*

You can log and display alerts that were either locally created on your system or that were received from other systems in the network. Your system does not need to be actively processing alerts to work with alerts. You can see all the alerts that are logged in the alert database.

To view the logged alerts:

1. Use the Work with Alerts (WRKALR) command. Type WRKALR and press Enter from any command line. The most recent alert is displayed first.
2. Type 5 to display the recommended actions.
3. Type 8 to display the details for a specific alert.

To refresh the list of alerts automatically, press F21 (Automatic refresh).

## Managing messages

You can display, send, respond to, remove, and print messages with the System i® product.

### *Displaying messages*

From the IBM Navigator for i window, you can display messages in the system-operator (QSYSOPR) or user message queue.

Messages in these queues include information from the operating system and other users.

- To display a message from the IBM Navigator for i window, follow these steps:
  - a) Expand **Basic Operations**.
  - b) click **Messages**. This displays all the messages for your user profile.
  - c) From the action bar, select **Actions>Include** to show the **Messages - Include** dialog box.
  - d) Select the appropriate option to display messages for the current signed-on user, the system operator, or user entry from below.

**Note:** If you want to display messages for another user's entry, you must specify the user name. To see a list of all users on the system, click **Browse** and select the user name from the list shown to display the message queue.

- e) Optional: You can limit the messages that are displayed by severity. Severity ratings numerically identify the extent of a problem. To display messages with a minimum severity rating (0-99), enter a specific numeric value in the **Lowest severity** field.
- f) Click **OK** to save your changes and close the Include dialog box.

#### *Displaying message properties*

From the IBM Navigator for i window, you can display the properties of your messages.

This provides you with message information that includes:

#### **General from the File menu that shows you:**

- Message ID
- Type
- Date and time sent
- Message text
- Message help (cause and recovery)

#### **Details from the File menu that shows you:**

- Severity level
- Name of message queue
- Message queue library
- Name of the job that sent the message
- Who sent the message
- Number of jobs that sent the message
- Name of the program that sent the message

To display the properties of your messages from IBM Navigator for i window, follow these steps:

1. expand **Basic Operations**.
2. Click **Messages**.
3. Right-click any message in the list that you want additional detail and select **Properties**.

#### *Displaying messages in the QSYSMSG message queue*

The QSYSMSG message queue is used to handle potentially severe system messages, which are messages that require immediate action.

To display the messages in QSYSMSG, follow these steps:

1. Type WRKMSG QSYSMSG, the Work with Messages command for message queue QSYSMSG, at the command line. This command shows all messages in the QSYSMSG message queue.
2. For more information about a message, move the cursor to the same line as the message.
3. (Optional) If you do not have your Assistance Level specified as Basic, press F21. Select option 1=Basic. If you do not have your system set to the basic assistance level, you cannot display the message details.
4. To show the Additional Message Information display, select option 5.
5. To display message details, select F9. This display shows the time that the user sent the message. This also displays the name of the users or programs that sent and received the message.

**Note:** These instructions also display messages in any message queue.

## ***Sending messages***

Whether you are a system operator or a user, you can communicate between systems by sending messages.

- To send a message from the IBM Navigator for i window, follow these instructions:
  - a) From the IBM Navigator for i window, expand **Basic Operations**.
  - b) Click **Messages**.
  - c) From the action bar, select **Actions > Send Message**.
  - d) In the **Users** field, enter or select the name of the user or workstation who receives the message.
  - e) Select **Interrupt user** to interrupt a user with your message.
  - f) Select **Request a reply** if you want a reply to your message.
  - g) Type your message in the **Message** field.

## ***Responding to messages***

From the IBM Navigator for i window, you can reply to inquiry messages from the system operator or from other users.

To reply to your messages, follow these steps:

1. From the IBM Navigator for i window, select the inquiry message in the message list to which you want to reply.
2. Right click on it and select **Reply**.
3. Type your reply.
4. Click **Reply**.

## ***Responding to printer messages***

The system operator and users can receive and display messages from system programs that communicate system conditions.

This function includes receiving messages about printing. Each printer has a Details: Message queues message queue. The printer can stop printing to wait for a response to a message. This allows the system operator to manage and report problems regarding the print devices.

To display printer messages for which a response is required, follow these steps:

1. To show the Work with Printers display, type WRKWTR ASTLVL (\*BASIC) at the command line.
2. To display printer messages for which a response is required, select option 7 (Printer message).
3. In the reply field, type your response to the printer message.

## ***Related concepts***

[Details: Message queues](#)

You have different types of message queues to receive messages. You can manage the message queues in various ways.

## ***Removing messages***

The message queue stores messages from the system operator, system programs, and other users on the system. From the IBM Navigator for i window, you can remove any unneeded messages.

- To remove the appropriate messages from IBM Navigator for i window, follow these steps:
  - a) From the IBM Navigator for i window, expand **Basic Operations** and click **Messages**.
  - b) Select the message that you want to remove from the message list.
  - c) Right click on it and select **Delete**.
  - d) Click **Delete** button on the Confirmation dialog box.

## **Printing messages**

To help you organize system messages, you can print the specific messages that refer to the current problem that you are handling.

To print specific messages one at a time from the message queue, follow these steps:

1. Enter the Work with Messages (**WRKMSG**) command at the command line.
2. Press F4 to prompt.
3. In the message queue parameter field, enter the name of the message queue that contains the messages that you want to print.
4. Press Enter to continue.
5. (Optional) If you do not have your Assistance Level specified as Basic, press F21. Select option 1=Basic. If you do not have your system set to the basic assistance level, you cannot display the message details.
6. To display the message that you want to print, enter 5 (Display details) and reply in the Options column.
7. To print the message, press F6.

You can also track your systems problems by printing all messages in the message queue.

### **Related tasks**

[Printing all messages in the message queue](#)

Sometimes a problem has many messages associated with it. To organize these messages that are reporting possible problems, you can print them from a message queue.

## **Details: Message queues**

You have different types of message queues to receive messages. You can manage the message queues in various ways.

### **Related concepts**

[Message queues](#)

A message queue is like a mail box for messages.

[Responding to messages](#)

From the IBM Navigator for i window, you can reply to inquiry messages from the system operator or from other users.

## **Types of message queues**

The system provides several types of message queues to receive messages.

The system queues that you can use are as follows:

- The system operator message queue, QSYSOPR, contains system messages that require a reply from the operator.
- Optional message queue, QSYSMSG, holds several error messages.
- The history log, QHST, holds messages that track the system's activities.
- The printer queue stores messages that are associated with each printer.
- The message queue, which used by Electronic Customer Support programs to send message when resuming PTF orders, stores all the messages that are sent by Electronic Customer Support so that the number of messages being sent to QSYSOPR can be decreased.
- Each user and workstation also has message queues that hold messages from the system operator, from another user, or from another system.

### **QSYSOPR message queue**

The system operator message queue, QSYSOPR, contains system messages that require a reply from the operator.

To handle a large number of messages that are sent to the QSYSOPR message queue or to the configured message queue, a message queue parameter (MSGQ) exists for the following line and controller descriptions:

- Line descriptions: Distributed data interface, Ethernet, frame-relay, token-ring, X.25.
- Controller descriptions: APPC, async, local workstation, remote workstation, SNA host, virtual workstation.

### **Related tasks**

[Displaying the contents of the QHST history log](#)

The history log QHST contains the past system-operator messages, device status, job-status changes, and program-temporary-fix activities that are stored as system messages.

[Changing the message queue for a printer](#)

You can change the location of the message queue that stores messages associated with each printer. By changing this location, you can separate your printing messages from the system, the user, or the error messages.

### **Related reference**

[Creating message queue QSYSMSG for severe messages](#)

You can create an optional message queue, QSYSMSG, to hold specific severe system messages that require immediate action.

## **Managing message queues**

You can manage your message queues in several ways.

The operations you can use to manage your message queues include:

- Create message queues.
- Change the attributes of message queues.
- Change the message queue for a printer.
- Print all messages in the message queue.

The following details show how these examples can be implemented using message queues.

- A small-sized customer has one LAN line and few users: No changes need to be made. All messages remain in the QSYSOPR message queue or in the configured message queue.
- A medium-sized customer has a couple of LAN lines: In this instance, you need to change QCFGMSGQ (the message queue for lines, controllers and devices) system value to the system-supplied message queue, QSYS/QCFGMSGQ. As a result, all communications messages for the object types that support the MSGQ configuration parameter go to this queue.
- A large-sized customer has many LAN lines and many WAN lines, with many users on each line. You want to set up the message queues so that the messages are separated in the following ways:
  - The messages for the Ethernet LAN go to the ETHMSGQ message queue: On this line, the system configures all the controllers automatically.
  - The messages for the token-ring LAN go to the TRNMSGQ message queue: On this line, the system configures most controllers; however, some controllers must be configured manually.
  - All messages for workstation users go to the WSMSGQ message queue: This includes local workstations, remote workstations, pass-through, and Telnet.
  - All other communications messages go to the QCFGMSGQ message queue.
- You are an experienced operator who has written a program that helps the operator know which message queues are important. Here is how to configure this example:
  - Change the system value QCFGMSGQ to QSYS/QCFGMSGQ.
  - Create the Ethernet line description with the MSGQ(ETHMSGQ) parameter value: The system creates all controllers (and thus devices) on this line. This means the system sends its messages to the message queue defined in the line ETHMSGQ.

- Create the token-ring line description with the MSGQ(TRNMSGQ) parameter value: Messages for the created controllers and devices on this line are sent to the TRNMSGQ message queue. Controllers that are manually created on this line are created with the MSGQ(TRNMSGQ) parameter value.
- Create the X.25 line description with the MSGQ(V25MSGQ) parameter value: All controllers that are created for this X.25 line description must be created using the MSGQ(X25MSGQ) parameter value on the CRTCTLxxx command.
- You can set up the workstation controller descriptions in the following ways:
  - Change the local workstation controller description, which the system automatically created, to the MSGQ(WSMSGQ) parameter value.

**Notes:**

1. Create all printer devices attached to the workstation controller with the MSGQ(\*CTLD) parameter value. Messages for display devices always go to the message queue that is defined in the associated controller. Thus, changing the message queue of the controller causes the messages for the devices to go to the message queue that is defined in the controller description.
  2. It is possible for the user to use the Change Command Default (CHGCMDDFT) command and change the default value of the message queue. This means that the automatic creation of the local workstation controller uses a different message queue.
- Create the virtual controllers for pass-through and Telnet with the MSGQ(WSMSGQ) parameter value.
- Like the local workstation controllers, the messages for devices attached to the virtual workstation controllers are sent to the queue defined in the virtual controller. The same logic works for the remote workstation controllers and their attached devices.
- A large-sized customer that is now using TCP/IP only, and you want to have the line and workstation messages logged to the QTCP message queue: You can manage this configuration by changing the system value QCFGMSGQ to QSYS/QTCP.

***Creating message queues***

The message queue provides a place to receive and store informational and inquiry messages within a particular library.

To create a message queue, follow these steps:

1. From the Main Menu, select option 3 (General system tasks).
2. From the General Systems Tasks display, select option 4 (Messages).
3. From the Messages display, select option 7 (Create a message queue).
4. In the **Message Queue Parameter** field, enter the name of the new message queue.
5. To specify additional message queue characteristics, press F10 (Additional Parameters). You can specify the following characteristics:
  - Place all the message queue changes into the auxiliary storage. This includes the changes to the message queue attributes and the changes due to messages that are sent or removed from the queue.
  - Specify the message queue size.
  - Specify user authority.
  - Specify whether the message queue allows the system to generate an alert.
  - Specify the coded character set ID (CCSID).

**Note:** For further information about parameters and keywords that allow you to specify message queue characteristics, press F1 (Help).

**Related reference**

[Creating message queue QSYSMSG for severe messages](#)

You can create an optional message queue, QSYSMSG, to hold specific severe system messages that require immediate action.

### ***Creating message queue QSYSMSG for severe messages***

You can create an optional message queue, QSYSMSG, to hold specific severe system messages that require immediate action.

To create QSYSMSG, follow these steps:

Type CRTMSGQ QSYS/QSYSMSG TEXT ('OPTIONAL MSGQ TO RECEIVE SPECIFIC SYSTEM MESSAGES') on the command line and press Enter. The system then creates the message queue.

After you create the QSYSMSG message queue, your system stores specific system messages in it.

**Example:** CPF0907 Serious storage condition might exist. Press **HELP**.

### **Related concepts**

#### Types of message queues

The system provides several types of message queues to receive messages.

### **Related tasks**

#### Starting problem analysis

If you are having a problem on your system, follow this procedure to narrow down the problem and to gather the necessary information to report to your next level of support.

#### Creating message queues

The message queue provides a place to receive and store informational and inquiry messages within a particular library.

### ***Changing the attributes of message queues***

Your system has several message queues that hold messages with helpful information about finding and reporting problems. You can customize the way that a message queue notifies you of messages.

To change the attributes of a message queue, follow these steps:

1. Enter the Change Message Queue (CHGMSGQ) command from the command line.
2. Press F4 to prompt.
3. Enter the name of the message queue that you want to change in the Message queue (MSGQ) parameter field.
4. Enter the name of the library that contains the message queue in the message queue Library field.
5. To change the delivery notification, specify the Delivery (DLVRY) parameter.

**Note:** To view a list of values for the delivery parameter, press F1 (Help).

6. Press F10 (Additional Parameters).
7. To limit message delivery by severity codes, specify the numeric value that you want to view in the field of the Severity code filter (SEV) parameter field.

### ***Changing the message queue for a printer***

You can change the location of the message queue that stores messages associated with each printer. By changing this location, you can separate your printing messages from the system, the user, or the error messages.

To change the location of the message queue that stores printer messages, follow these steps:

1. To display a list of printers from the Main Menu, type WRKDEVD \*PRT on the command line. Press Enter.
2. Enter 2 (Change) in the Opt column, next to the print device that is changing.
3. From the Change Device Description display, specify the name of the message queue that you want to change in the message queue parameter field.

### **Related concepts**

#### Types of message queues

The system provides several types of message queues to receive messages.

### ***Printing all messages in the message queue***

Sometimes a problem has many messages associated with it. To organize these messages that are reporting possible problems, you can print them from a message queue.

To print messages from a message queue, follow these steps:

1. From the Main Menu, select option 3 (General Systems Tasks).
2. From the General Systems Tasks display, select option 4 (Messages).
3. From the Messages display, select option 3 (Display Messages).
4. In the Message queue parameter field, enter the name of the message queue that contains the messages which you want to print.
5. In the Library parameter field, specify the library where the message queue resides.
6. In the Output parameter field, enter the value \*PRTWRAP.
7. Optional: To quickly print messages, type `DSPMSG MSG(MSQNAME) OUTPUT(*PRTWRAP)` from the command line.

#### **Related tasks**

##### Printing messages

To help you organize system messages, you can print the specific messages that refer to the current problem that you are handling.

## **Details: Logs**

Logs include job logs, history logs, and problem logs.

#### **Related concepts**

##### Logs

The IBM i licensed program records certain kinds of events and messages for use in diagnosing problems. A log is a special kind of database file that is used by the system to record this information.

### **Job logs**

Every job that runs on your system has an associated job log that records its activities.

A job log can contain the following information:

- The commands in the job
- The commands in a CL program
- All messages associated with that job

#### **Related concepts**

##### History logs

The history log contains the information about the system operation and the system status.

#### **Related information**

##### Job logs and communication problems

### ***Controlling the content of the job log***

You can control the content of the job log by using the value specified on the LOG parameter.

When working with problems, you might want to do any of the following actions:

- Record the maximum amount of information for the jobs that have frequent problems
- Create a job log for the jobs that are completed normally
- Exclude informational messages

To control the content of the job log by using the Create Job Description (CRTJOB) command, follow these steps:



1. Type CRTJOBDD from any command line and press F4.
2. Find the message logging (LOG) parameter, and specify the appropriate values for the following parameters:
  - The message level.
  - The message severity.
  - The message text level.
3. Specify the values for the required parameters and press Enter.

*Details: Controlling the content of the job log using the message level value*

The message level value controls the type and number of messages that the system writes to a job log.

The message can be set at one of the following levels:

**0**

No data is logged.

**1**

Only those messages that are sent to the external message queue for jobs with a severity greater than or equal to the specified message severity are logged.

**2**

Logs all level-1 messages, and logs the following information:

- Any requests that result in a high-level message with a severity level that exceeds or equals the specified message severity.
- All of the associated messages of a logged request.

**3**

Logs the information for level-2 messages, and logs the following information:

- All requests.
- Commands that are run by a CL program (if allowed by the log from the CL program), the command's job attribute, and the log attribute of the CL program.

**4**

The following information is logged:

- All requests or commands that are logged from a CL program.
- All messages with a severity no less than the specified severity, including the trace messages.
- Commands that are run by a CL program must have the appropriate job and log attribute settings to allow the program to run correctly.

**Note:** A high-level message is one that is sent to the program message queue of the program that receives the request. For example, QCMD is an IBM-supplied request processing program that receives requests.

*Details: Controlling the content of the job log using the message severity value*

The message severity determines which messages are logged.

For example, informational messages have a severity of 00. Messages that are essential to the operation of the system have a severity of 99, which is the highest severity. For more information, see the online help.

*Details: Controlling the content of the job log using the message-text-level value*

You can request to generate a variety of message text. The amount of message text depends on the values that you specify for the message-text level value.

- Specify \*MSG to write only the message text to the job log.
- Specify \*SECLVL to write both message text and message help to the job log.
- Specify \*NOLIST if you do not want to create a job log when a job ends normally.

## ***Displaying job logs***

To analyze a problem, you might want to review the messages in the job log. You can display a job log in several different ways.

The job log contains the messages that are recorded when a job is running. How you display the job log depends on whether the job has ended or is still running.

- For a job that has ended, use the Work with User Jobs display.
  1. Type WRKUSRJOB from any command line.
  2. Select option 8 (Work with spooled files) for the job whose log you want to see.
  3. Find the file that is called QPJOBLOG on the Work with Spooled Files display.
  4. Type 5 (Display) to view it.
- For a job that is still running, use the Work with User Jobs display.
  1. Type WRKUSRJOB from any command line.
  2. Type 5 (Work with) for the job whose log you want to see.
  3. Type 10 (Display job log, if active or on job queue) from the Work with Job display.
- To display the job log for your own workstation session, use the Display Job Log (DSPJOBLOG) command. Type DSPJOBLOG from any command line.

## **History logs**

The history log contains the information about the system operation and the system status.

The history log tracks high-level activities such as the start and completion of jobs, device status changes, system operator messages, and security violations. The information is recorded in the form of messages. These messages are stored in files that are created by the system.

History logs help you track and control the system activities. If you maintain an accurate history log, you can monitor specific system activities that help analyze problems. History logs differ from job logs. Job logs record the sequential events of a job. History logs record certain operational and status messages that relate to all jobs in the system.

You can start your investigation of a problem by viewing the history log and then referring to a specific job log for details.

### **Related concepts**

#### Job logs

Every job that runs on your system has an associated job log that records its activities.

### **Related tasks**

#### Displaying the Product Activity Log to solve communication problems

## ***Displaying the list of history log files***

To view a list of history log files, use the Display Object Description (DSPOBJD) command.

The history log files are copies of all the messages that are sent to the message queue QHST. When the size of the current history log exceeds its size limitation, the system creates a new file. The files reside in the library QSYS and begin with the letters QHST, followed by a number. The format that is used is QHST yyddd*n*. The yyddd*n* represents the date of the first message in the file, where yy is the year and ddd is the sequential number of the day of the year. The *n* that is appended at the end is a sequence number; this sequence number is only incremented when more than one QHST file is generated within one day.

To display the list of history logs and to view its contents, complete these steps:

1. Type WRKF QHST\* from any command line.
2. Select option 5 to display the contents of the file.

**Note:** The system copies the messages in the QHST message queue to the history log files and then removes them from the QHST message queue. The Display Log (DSPLOG) command uses the history log files to show the messages sent to the QHST message queue.

### ***Displaying the contents of the QHST history log***

The history log QHST contains the past system-operator messages, device status, job-status changes, and program-temporary-fix activities that are stored as system messages.

To display the contents of the history log QHST, complete the following steps:

1. Type DSPLOG (the Display Log command) on the command line.
2. To prompt the command, select F4.
3. To display only messages that are logged during a certain time, specify a time period. If you do not specify a time period, the DSPLOG command displays all available messages for that day.

### **Related concepts**

#### Types of message queues

The system provides several types of message queues to receive messages.

### **Problem logs**

A problem log is used to coordinate and track all of your problem management operations.

The problem log with the problem records can be created for various reasons:

- Incoming alerts that are received.
- Service requests and program temporary fix (PTF) orders that are received.
- Local system-detected problems.
- Local user-detected problems.

You can print or display error logs from your jobs.

### ***Printing error logs***

The problem log contains a list of errors that occur on your system. When you review these errors, you might want to print the error log and determine the problem.

To print the error log, follow these steps:

1. Type PRTERLOG from any command line and press F4.
2. Type the parameter value for the kind of error log information that you want to print. For example, you can specify \*ALL to print all the error codes, or specify \*ALLSUM to print a summary of the error log.
3. Press Enter. The error log information is sent to the output queue that is identified in your user profile.
4. Type GO ASSIST from any command line to display the Operational Assistant menu.
5. Type 10 (Start printing) on the Work with Printer Output display to print the error log.

### **Related tasks**

#### Displaying error logs

When you review the errors that occur on your system, you might be able to determine the problem.

### ***Displaying error logs***

When you review the errors that occur on your system, you might be able to determine the problem.

You can also print the error logs.

To view an error log, complete these steps:

1. Type PRTERLOG on any command line and press F4.
2. Type the parameter value for the kind of error log information that you want to view. For example, you can specify \*ALL to view all the error codes, or specify \*ALLSUM to view a summary of the error log.
3. Press Enter. The error log information is sent to the output queue that is identified in your user profile.

4. Type G0 ASSIST on any command line to display the Operational Assistant menu.
5. Look for the error log at or near the bottom of the printer output list on the Work with Printer Output display.
6. Type 5 (Display) to view the printer output.

#### **Related tasks**

##### Printing error logs

The problem log contains a list of errors that occur on your system. When you review these errors, you might want to print the error log and determine the problem.

## **Details: CL commands for problem handling**

You can use several problem analysis commands when you experience problems with your system.

- Use the Analyze Problem (ANZPRB) command to analyze, create problem records for, or report user-detected problems.
- Use the Verify Communications (VFYCMN) command to verify either remote or local communications equipment.
- Use the Verify Tape (VFYTAP) command to start procedures that verify whether the specified tape unit is operating.
- Use the Work with Alerts (WRKALR) command to remotely analyze system-detected problems.
- Use the Work with Problems (WRKPRB) command to gather more information about a problem to either solve it or to report it without the help of a hardware service provider.

#### **Related information**

##### CL command finder

## **Using the Analyze Problem command**

To start problem analysis for user-detected problems, use the Analyze Problem (ANZPRB) command.

A new problem is a problem that you detect while using the system and that has not been recorded in the problem log. A new problem is also a problem that is in the problem log with a status of OPENED. When the analysis is complete, the results are stored in the problem record. The results are used to search for program temporary fixes (PTFs) to correct the problem or to prepare a new service request if the problem cannot be solved.

To analyze a new problem that has not been recorded in the problem log, perform the following steps:

1. Type ANZPRB on the command line.
2. Select the option that most closely corresponds to the problem listed on the Analyze a New Problem display. A series of steps then guides you through the problem analysis. When you progress through the problem analysis, the system builds a symptom string based on your responses.

**Note:** If you encounter the Problem Analysis display while you are building your symptom string, contact your service provider before continuing.

When you complete the problem analysis, the collected information is placed in the problem log.

#### **Related concepts**

##### CL commands for problem analysis

You can use the problem analysis control language (CL) commands to help you manage problems that you are experiencing with your system.

##### Reporting problems detected by the system

The system problem log contains a list of all the problems recorded on the system.

#### **Related tasks**

##### Starting problem analysis

If you are having a problem on your system, follow this procedure to narrow down the problem and to gather the necessary information to report to your next level of support.

### **Related reference**

[Analyze Problem \(ANZPRB\) command](#)

### **Analyzing a problem with OPENED status**

To analyze a problem that has been recorded in the problem log and that has a status of OPENED, follow these steps.

1. Type `DSPMSG QSYSOPR` on any command line and press the Enter key to see the system operator messages.
  - If the message is highlighted, use option 5 (Display details and reply) for the message. On the Additional Message Information display, press F14 (Work with problem).
  - If the message has an asterisk (\*) next to it, press F14 (Work with problem) on the Display Messages display.
2. Select option 8 (Work with problem), and then option 1 (Analyze problem). As you progress through the problem analysis, the system builds a symptom string based on your responses.
3. When you complete the problem analysis, the collected information is placed in the problem log.

### **Additional method to analyze a problem with OPENED status**

You can also use this method to analyze a problem and that has a status of OPENED in the problem log.

1. Type `WRKPRB` on any command line.
2. Select option 8 (Work with problem) for the problem, and then option 1 (Analyze Problem).

### **Examples: The Analyze Problem command**

These examples show how the commands are used to analyze system problems.

#### **Example 1: Displaying the menu**

```
ANZPRB
```

This command shows the Analyze Problem menu.

#### **Example 2: Starting remote analysis**

```
ANZPRB ANZTYPE(*REMOTE)
```

This command shows the display that prompts for the remaining values of the command. After you specify the appropriate values, the remote analysis begins.

#### **Example 3: Accessing remote system with user ID and password**

```
ANZPRB ANZTYPE(*REMOTE) RCPNAME(RCH38377) USERID(JON) PASSWORD
```

This command shows the display that prompts for the remaining values of the command. After you specify the appropriate values beyond the ones that are specified on the command example, the remote analysis begins.

#### **Example 4: Remote analysis has security level of 10**

```
ANZPRB ANZTYPE(*REMOTE) RCPNAME(RCH38377) USERID(JON)
```

This command is slightly different from the one in the preceding example. The same display prompt appears. However, if you do not specify `PASSWORD`, the system assumes that the remote system has a security level of 10; that is, the remote system does not use passwords. After you specify the appropriate values beyond the ones that are specified on the command example, the remote analysis begins.

## Example 5: Displaying menu

```
ANZPRB ANZTYPE(*MENU)
```

This command shows a menu that prompts for the type of analysis that you want. The remaining parameters do not appear on the display.

## Example 6: Starting local analysis

```
ANZPRB ANZTYPE(*LOCAL)
```

This command begins analysis on the local device. The remaining parameters do not appear on the display.

## Using the Verify Communications command

The Verify Communications (VFYCMN) command allows you to verify either remote or local communications equipment.

This command shows the display that prompts you to select the system on which you want to verify remote communications.

1. Type VFYCMN on any command line.
2. Press F4 (Prompt).

Depending on the configuration of the system, you can run tests on the following communications equipment:

- Cable
- Communications input/output adapter
- Communications interface trace
- Link
- Local modem
- Remote modem
- Link Problem Determination Aid-2 (LPDA-2)

### Related concepts

[CL commands for problem analysis](#)

You can use the problem analysis control language (CL) commands to help you manage problems that you are experiencing with your system.

### Related reference

[Verify Communications \(VFYCMN\) command](#)

## Examples: The Verify Communications command

These examples show how to verify communications equipment by using the Verify Communications command.

### Example 1: Showing the Select a Line to Test display

```
VFYCMN
```

This command shows the Select a Line to Test display.

### Example 2: Checking a remote system

```
VFYCMN VFYTYPE(*REMOTE)
```

This command shows the display that prompts for the remaining values of the command. After you specify the appropriate values, the remote analysis begins.

### Example 3: Accessing a remote system using a password

```
VFYCMN VFYTYPE(*REMOTE) RCPNAME(RCH38377) USERID(JON) PASSWORD
```

This command shows the display that prompts for the remaining values of the command. After you specify the appropriate values beyond the ones that are specified in the command example, the remote analysis begins.

### Example 4: Accessing a remote system without a password

```
VFYCMN VFYTYPE(*REMOTE) RCPNAME(RCH38377) USERID(JON)
```

This command is similar to the preceding example except that the PASSWORD parameter is not specified. The same prompt display is shown; however, the system assumes that the remote system has a security level of 10; that is, the remote system does not use passwords. Another prompt display appears after this command is specified. After the user specifies the appropriate values on this display, the remote analysis begins.

### Example 5: Checking a local system

```
VFYCMN VFYTYPE(*LOCAL)
```

This command begins an analysis on the local device. The remaining parameters do not appear on the display.

## Using the Verify Tape command

To verify whether the specified tape unit is operating, use the Verify Tape (VFYTAP) command.

### Related concepts

[CL commands for problem analysis](#)

You can use the problem analysis control language (CL) commands to help you manage problems that you are experiencing with your system.

### Related reference

[Verify Tape \(VFYTAP\) command](#)

## Using the Work with Alerts command

When the system detects a problem, the service requester sends it to the service provider. To remotely analyze the system-detected problems, use the Work with Alerts (WRKALR) command.

Follow these steps to complete the remote problem analysis:

1. Type WRKALR on any command line and press the Enter key.
2. Press F11 (Display user/group) to show the problem IDs associated with the alerts.
3. Type 9 (Work with problem) in the Opt column next to the alert that is associated with the problem you want to analyze. Then press Enter. You can also press F18 (Work with problem) to work with the problem log.
4. Type 8 (Work with problem) in the Opt column next to the problem you want to analyze.
5. Select option 1 (Analyze problem) from the Work with Problem menu.

### Related concepts

[CL commands for problem analysis](#)

You can use the problem analysis control language (CL) commands to help you manage problems that you are experiencing with your system.

### Related reference

[Work with Alerts \(WRKALR\) command](#)

### ***Example: The Work with Alerts command***

This example shows how to use the Work with Alerts (WRKALR) command.

1. Type WRKALR on the command line.
2. Press the Enter key.
3. Select the alert you want to work.
4. Use the different options on the Work with Alerts display to complete the required task.

### **Using the Work with Problems command**

With the problem analysis, you can gather more information about the problem and determine whether to solve it or to report it without the help of a hardware service provider.

You can run problem analysis on messages that are highlighted (basic assistance level) or messages that have an asterisk (\*) next to them (intermediate assistance level). If you do not see any of these messages, you might not be authorized to the Work with Problem (WRKPRB) command, or the message does not support additional problem analysis.

To run the Work with Problem (WRKPRB) command for messages that are highlighted, follow these steps:

1. Select option 5 (Display details and reply) for the message.
2. Press F14 (Work with problem).

#### **Related concepts**

[CL commands for problem analysis](#)

You can use the problem analysis control language (CL) commands to help you manage problems that you are experiencing with your system.

#### **Related tasks**

[Starting problem analysis](#)

If you are having a problem on your system, follow this procedure to narrow down the problem and to gather the necessary information to report to your next level of support.

[Running the Work with Problems command](#)

To run the Work with Problems (WRKPRB) command for messages with an asterisk (\*), perform these steps.

#### **Related reference**

[Work with Problems \(WRKPRB\) command](#)

### ***Examples: The Work with Problems command***

These examples show how to display problem entries using the CL commands.

#### **Example 1: Displaying Entries with Status of OPENED or READY**

```
WRKPRB STATUS(*OPENED *READY) HDW(9347)
```

This command shows the Work with Problems display. It lists only those problem entries that have a status of OPENED or READY, which identify a failing device with type 9347.

#### **Example 2: Displaying Current Day Problem Entries**

```
WRKPRB PERIOD(( *AVAIL *CURRENT ))
```

This command shows the Work with Problems display. It lists all problem entries that are created on the current day.

#### **Example 3: Displaying List of Hardware Problems**

```
WRKPRB SEV(1 2) HARDWARE(9347 001 10-7523489)
```



This command shows a list that contains problems that relate to user-specified hardware. The user has specified that the command track medium-to-high levels of severity.

## Running the Work with Problems command

To run the Work with Problems (WRKPRB) command for messages with an asterisk (\*), perform these steps.

1. Move your cursor to the message and press F14. The Additional Message Information display is shown.
2. Press the F14 (Work with problem) key. From the Work with Problem (WRKPRB) display, you can display the details of the problem and work directly with the problem.

### Related tasks

Using the Work with Problems command

With the problem analysis, you can gather more information about the problem and determine whether to solve it or to report it without the help of a hardware service provider.

## Using the Display Problems command

The Display Problems (DSPPRB) command allows you to show service information that relates to performing hardware or software maintenance. The service information, contained in the problem log entries, are shown on the DSPPRB display, printed with the job's output, or stored in a database file.

To display the contact information of your service provider, perform the following steps:

1. On the command line of the main menu, type DSPPRB and press Enter.
2. The DSPPRB display is shown. The information displayed include:
  - **Resource name:** Shows the original system of the problem.
  - **Product:** Shows the product where the problem is detected.
  - **Function:** Shows the function that the problem relates to.
  - **Program:** Shows the program that was running when the problem was detected.
  - **Message identifier:** Shows the message that indicates the problem.
  - **Origin:** Shows the origin system where the problem originated.
  - **Service number:** Shows the assigned service number of the problem. This number was assigned when the problem was reported to IBM service support.
  - **Branch number:** Shows the specified branch number of the problem. This number was assigned when the problem was reported to IBM service support.
  - **Country or region number:** Shows the country or region number of the problem. This number was assigned when the problem was reported to IBM service support.
  - **User assigned:** Shows the user-assigned number of the problem.
  - **Group assigned:** Shows the group-assigned number of the problem.

## Using the Change Problem command

With the Change Problem (CHGPRB) command, you can change the values of selected fields within the problem log. The changeable fields include the service-assigned number, the problem severity, the user name that is assigned to the problem log entry, and the problem description.

To change the contact information of your service provider, perform the following steps:

1. On the command line of the main menu, type CHGPRB and press Enter.
2. The Change Problem (CHGPRB) display is shown. The fields you can edit include:
  - **Origin:** The original system where the problem occurs.
  - **Severity:** The severity of the problem.

- **User assigned:** The user number that is assigned for the problem.
- **Group assigned:** The group number that is assigned for the problem.
- **Service number:** The service number that is assigned for the problem.
- **Branch number:** The branch number of the problem. This number was assigned when the problem was reported to IBM service support.
- **Country or region number:** The country or region number of the problem. This number was assigned when the problem was reported to IBM service support.
- **Problem category:** The category that the problem belongs to.
- **Text description:** The description of the problem.

Here is an example of changing problem information using the CHGPRB command:

```
CHGPRB PRBID(9213438081) ORIGIN(AS400 SYSTEM02) SEV(4)
ASNUSER(JEFFREY) GROUP(CHGPROB) SRVID(PMR01) BRANCH(694)
COUNTRY(760) TEXT('NEW PROBLEM DESCRIPTION')
```

This command adds a new description and changes problem 9213438081, which originated on SYSTEM02.AS400 to severity 4, the assigned user to JEFFREY, the group to CHGPROB, the service assigned number to PMR01, the branch number to 694, and the country or region number to 760.

## Using the Change Contact Information command

With the Change Contact Information (CHGCNTINF) command, you can change the local service information, which helps you contact or be contacted by various support centers.

To change the contact information of your service provider, perform the following steps:

1. On the command line of the main menu, type CHGCNTINF and press Enter.
2. The Change Contact Information display is shown. Edit the information you want to change in the following fields:
  - Enter the correct information for the company and the contact personnel in the **Company** and **Contact** fields.
  - Specify a unique number that IBM assigned to you and enter your description in the **Customer number** field. This number is used in various business and service transactions with IBM.

**Note:** You can specify up to five sets of customer numbers and associated descriptive texts. The customer identifier cannot contain blanks and must contain only digits 0 - 9. You can specify up to 256 characters of the descriptive text.
  - Specify a unique identifier that IBM assigned to your services contract and the corresponding description in the **Contract number:** field. With the number, all customer-purchased services under the identified contract can be searched.

**Note:** You can specify up to five sets of contract numbers and associated descriptive text. The Contract identifier cannot contain blanks and must contain only digits 0 - 9. Only uppercase letters A-Z are allowed. The contract identifier is either 6 or 7 characters. You can specify up to 256 characters of descriptive text.
  - Specify the primary telephone number, or the Help desk or pager number to be reached in the **Contact telephone numbers** field.
  - Provide your fax information in the **Fax telephone numbers** field.
  - Enter your mail address in the **Electronic mail addresses** field.
  - **Media for mailing PTFs:** Generally, an automatic selection for PTF distribution media is available according to the partition attached. However, if the automatic selection fails to determine a default media type, it turns to CD-ROM as the default.
  - **Call central site support:** Specify if want an IBM service representative or the product support center to call your central site support desk. When \*YES is set, your central site support is to be called. When \*NO is set, your central site support is not to be called.

## Details: Problem-handling menus

The problem-handling menus can be used to analyze problems that occur on your system.

Your system problems can originate from the following areas:

- Job or programming
- System performance
- Equipment
- Communications
- Remote system

If you are experiencing problems with your system, use the following problem-handling menus to help analyze problems.

- Use the NETPRB menu to handle problems that relate to communications.
- Use the NETWORK menu to manage and use network communications.
- Use the PROBLEM menu to work with problems.
- Use the PROBLEM2 menu to work with programming problems and system performance.
- Use the TECHHELP menu to work with system operation problems.
- Use the USERHELP menu to learn about using help and analyzing problems.

### Using the NETPRB menu

From the network problem-handling (NETPRB) menu, you can handle problems that relate to communications.

Verifying that the links are working correctly is a good place to start your problem investigation.

To access this menu:

1. Type `GO NETPRB` on any command line and press Enter.
2. Select the menu option for the task you want to perform.

#### Related concepts

[Problem-handling menus](#)

Problem-handling menus can help you analyze problems that occur on your system.

### Using the NETWORK menu

From the network management (NETWORK) menu, you can manage and use network communications.

Many of the options on this menu are for the advanced user, for example, someone who is responsible for a network of systems. Other problem-handling menus contain options that help users find problems on their own workstations or on specific systems within a single network.

To access this menu:

1. Type `GO NETWORK` on any command line and press Enter.
2. Select the menu option for the task you want to perform.

#### Related concepts

[Problem-handling menus](#)

Problem-handling menus can help you analyze problems that occur on your system.

## Using the PROBLEM menu

The problem-handling (PROBLEM) menu is the main menu for working with problems.

From the problem-handling menu, you can analyze problems, create problem records, view problem records, and report problems to the service provider. In addition, you can check message queues and the history log.

To access this menu:

1. Type `G0 PROBLEM` on any command line and press Enter.
2. Select the menu option for the task you want to perform.

### Related concepts

[Problem-handling menus](#)

Problem-handling menus can help you analyze problems that occur on your system.

### Related tasks

[Using the PROBLEM2 menu](#)

The second problem-handling (PROBLEM2) menu is an extension of the PROBLEM menu.

## Using the PROBLEM2 menu

The second problem-handling (PROBLEM2) menu is an extension of the PROBLEM menu.

From the PROBLEM menu, you can analyze problems at a cursory level. From the PROBLEM2 menu, you can perform tasks that allow you to work with programming problems and system performance. These are areas that require more skill in solving problems.

To access this menu:

1. Type `G0 PROBLEM2` on any command line and press Enter.
2. Select the menu option for the task you want to perform.

### Related concepts

[Problem-handling menus](#)

Problem-handling menus can help you analyze problems that occur on your system.

### Related tasks

[Using the PROBLEM menu](#)

The problem-handling (PROBLEM) menu is the main menu for working with problems.

## Using the TECHHELP menu

If you encounter a problem that relates to system operations, start with the Technical Support Tasks (TECHHELP) menu.

You can save the necessary information for a technical support person to do problem analysis by using the options from this menu. It is also possible to have a remote support organization access your system from a remote workstation.

To access this menu, complete the following steps:

1. Type `G0 TECHHELP` on any command line and press Enter.
2. Select the menu option for the task you want to perform.

### Related concepts

[Problem-handling menus](#)

Problem-handling menus can help you analyze problems that occur on your system.

## Using the USERHELP menu

This menu is for the novice who wants to learn about using help and who needs help in analyzing problems.

With the problem-handling menu, you can record information about a particular system by using option 10 (Save information to help resolve a problem). Note that option 10 creates a problem record and several spooled files that can be helpful to the analyzer.

To access the USERHELP menu, complete the following steps:

1. Type `G0 USERHELP` on any command line and press Enter.
2. Select the menu option for the task you want to perform.

### Related concepts

[Problem-handling menus](#)

Problem-handling menus can help you analyze problems that occur on your system.

## Details: Authorized program analysis report

You can use these parameters for understanding the authorized program analysis report (APAR) command.

### valid

The volume ID of the diskettes or tapes where you want to store the system data areas.

### object

The load member that contains the program that caused the program check to occur. The system places the load member in a diskette or in a tape file that is named APARLOAD.

### source

The source member from which the program was created. The system places the source member in a diskette or a in tape file that is named APARSRCE.

### proc

The procedure member from which the program was called. The system places the procedure member in a diskette or a tape file that is named APARPROC.

### dumpfile

The file that is created by a task dump. Specify zero (0) if you want to copy the most recent dump file. If you do not specify a file name when you run the APAR procedure from a display station, the status of all dump files is displayed. You can select to copy one or none of the files. If you do not specify a file name and the APAR procedure is not being run from a display station, no dump file is copied to the diskette or to the tape.

Dump files are named `#DUMP.nn` on disk, where *nn* is a number from 00 through 99.

### S1

You want to use slot one of the diskette drive (the 5360 system has multiple slots and the 9402 model 236 has only one slot). On the 9402 model 236, S1 is the only slot that can be used. If you do not specify a parameter, S1 is assumed.

### AUTO

You want to automatically save the results of the APAR procedure to the next slot on a diskette drive with multiple slots. You cannot use this parameter on the 9402 model 236.

### NOAUTO

You do not want to automatically save the results of the APAR procedure to the next slot on a diskette drive with multiple slots. You cannot use this parameter on the 9402 model 236.

### I1

The information collected by the APAR procedure is to be copied to a diskette.

**TC**

The information collected by the APAR procedure is to be copied to the 0.25 inch tape cartridge mounted in the tape drive. If no parameter is specified, TC is assumed.

**T1**

The information collected by the APAR procedure is to be copied to the 0.5 inch tape reel mounted in tape drive 1.

**T2**

The information collected by the APAR procedure is to be copied to the 0.5 inch tape reel that is mounted in tape drive 2.

**Related concepts**

Using authorized program analysis reports

An *authorized program analysis report (APAR)* is an IBM-supplied program that allows you to create a diskette file or a tape file. The file contains information from your system to help software service representatives to correct programming problems.

## Determining the primary or alternative consoles

If the Operations Console has been configured as the primary console, the system starts the Operations Console. If the Operations Console has not been configured, the primary console is a workstation attached to the first input/output processor (IOP) that is capable of supporting workstations.

In addition to the primary console, the system can assign up to two alternative consoles. The first alternative console can only be a TWINAX workstation that is attached to the same IOP as the primary console. The second alternative console is a workstation that is attached to the next IOP or Input/Output Adaptor (IOA) that is capable of supporting workstations.

The IOP that supports the console must be on the first system bus (bus 1).

If a workstation is not correctly attached to the first IOP that is capable of attaching workstations, the system does not assign a primary console. The system displays a reference code on the operator's panel. In addition, if the initial program load (IPL) mode is set to Manual, the system stops.

### Primary console workstation requirements

In order to be the primary console, the workstation must be operational and have the correct port and address. If the workstation is a PC, it must also have an active emulation program on the workstation.

The workstation requirements are:

- TWINAX workstation - Port 0 Address 0
- ASCII workstation - Port 0
- PC attached to ASCII IOP or IOA
  - Port 0
  - PC software to emulate a 316x or 3151 terminal
- PC attached to TWINAX IOP
  - Port 0 Address 0
  - 5250 emulator software active on PC
- PC attached to a LocalTalk IOA (6054)
  - SNAps 5250 Version 1.2 (or above) application
  - Console capable selected on Macintosh (IOA converts to Port 0 Address 0)
- PC attached to a 2609, 2612, 2699, or 2721 communications IOA
  - Client Access Console cable attached to the 2609 or 2612 P2 port (part number 46G0450 or 46G0479), 2699 (part number 21H3779), or 2721 (part number 44H7504)

- Operations Console cable attached to the 2609 or 2612 (part number 97H7555), 2699 (part number 97H7556), or 2721 (part number 97H7557) - 5250 emulation or Rumba active on PC

## Finding the primary console when the system is operational

You can use these methods to find the primary console:

- **Method 1:** Look for a sign-on display that shows a DSP01 in the upper-right corner.
- **Method 2:** If the device name (DSP01) for the console has been changed, you can verify the device name for the primary console by following these steps:
  1. Enter DSPCTLD QCTL on any command line. The Display Controller Description display appears.
  2. Find the Resource name parameter (such as CTL01) and record it.
  3. Enter PRTDEVADR rrrrr on any command line, where rrrr is the resource name you recorded.

**Note:** The data can be printed if the printer is active.
- **Method 3:**
  1. Enter STRSST on any command line. The System Service Tools display appears.
  2. Select option 1 (Start a service tool).
  3. Select option 7 (Hardware service manager).
  4. Select option 2 (Logical hardware resources).
  5. Select option 1 (System bus resources). On the Logical Hardware Resources on System Bus display, the < symbol indicates the IOP that the console is attached to.
  6. Select option 9 (Resource associate with IOP and display detail) to find the location of the system bus, board, and card.

## Finding the primary console when the system power is off

You can use one of the following methods to find the primary console when the system power is off.

- Turn on the system in **Manual** mode and look for the IPL and Install System display.
- Turn on the system in **Normal** mode and look for DSP01 on the sign-on display.

**Note:** The name might have been changed. Refer to the information about finding the primary console when the system is operational, which is mentioned previously in this topic, to determine the display name.

## Replacing the battery power unit on models 5xx and expansion units FC 507x and FC 508x

To remove or replace the battery power unit on models 5xx, expansion unit feature codes (FCs) 507x and 508x, follow these steps.

The part number for the battery power unit is 86G8040.

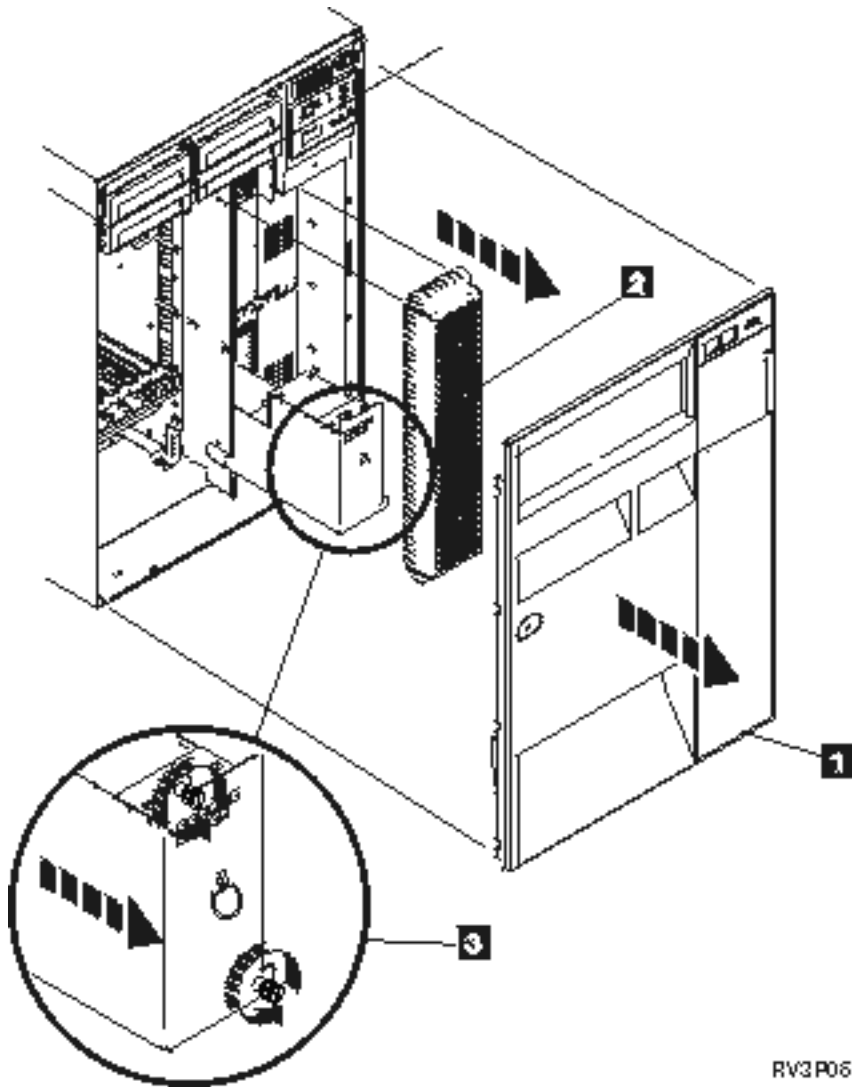

RV3P060-1

Figure 1. Removal of the battery power unit on models 5xx, and expansion units FC 507x and FC 508x.

1. Do not turn off the system.
2. Remove the front cover (see **1** in Figure 2).
3. Pull out and lift to remove the screen (see **2** in Figure 2).



**Attention:** If you remove the battery power unit while the system is running on battery power, the system will fail. It might also damage the battery power unit and the card enclosure.

4. Ensure that the system is not running on battery power. As a test, be sure that the console accepts system commands before removing the battery power unit.



**CAUTION:** Be careful when removing or installing this part or unit. This part or unit is heavy, but has a weight smaller than 18 kilograms (39.7 pounds). (RSFTC201)

5. Loosen the screws and use two hands to pull the battery power unit out (see **3** in Figure 2).
6. Install the battery power unit by reversing the removal procedure.



**CAUTION:** The battery is a lead-acid battery. To avoid possible explosion, do not burn. Exchange only with the IBM-approved part. Recycle or discard the battery as instructed by local regulations.

In the United States, IBM has a process for the collection of this battery. For information, call 1-800-426-4333. Have the IBM part number for the battery unit available when you call.





## Related information for Troubleshooting

---

Product manuals, IBM Redbooks, Web sites, and other information center topic collections contain information that relates to the Troubleshooting topic collection. You can view or print any of the PDF files.

### Manuals

- [Recovering your system](#)  book (about 8400 KB)
- [Local Device Configuration](#)  book (about 760 KB)

### IBM Redbooks

[AS/400e Diagnostic Tools for System Administrators: An A to Z Reference for Problem Determination](#)   
(about 4400 KB)

### Other information

- [CL programming](#): Information about defining and working with messages.
- [CL command finder](#)
- [Common reference codes for i5/OS software installation](#)
- [IPL SRC finder](#)
- [Managing service tools user IDs](#): Information about changing service tools user IDs and passwords, located in **Security → Service tools**.
- [Recovering your system](#)
- [Scenario: Message monitor in the Performance topic](#)

### Related reference

[PDF file for Troubleshooting](#)

You can view and print a PDF file of this information.

## Code license and disclaimer information

---

IBM grants you a nonexclusive copyright license to use all programming code examples from which you can generate similar function tailored to your own specific needs.

SUBJECT TO ANY STATUTORY WARRANTIES WHICH CANNOT BE EXCLUDED, IBM, ITS PROGRAM DEVELOPERS AND SUPPLIERS MAKE NO WARRANTIES OR CONDITIONS EITHER EXPRESS OR IMPLIED, INCLUDING BUT NOT LIMITED TO, THE IMPLIED WARRANTIES OR CONDITIONS OF MERCHANTABILITY, FITNESS FOR A PARTICULAR PURPOSE, AND NON-INFRINGEMENT, REGARDING THE PROGRAM OR TECHNICAL SUPPORT, IF ANY.

UNDER NO CIRCUMSTANCES IS IBM, ITS PROGRAM DEVELOPERS OR SUPPLIERS LIABLE FOR ANY OF THE FOLLOWING, EVEN IF INFORMED OF THEIR POSSIBILITY:

1. LOSS OF, OR DAMAGE TO, DATA;
2. DIRECT, SPECIAL, INCIDENTAL, OR INDIRECT DAMAGES, OR FOR ANY ECONOMIC CONSEQUENTIAL DAMAGES; OR
3. LOST PROFITS, BUSINESS, REVENUE, GOODWILL, OR ANTICIPATED SAVINGS.

SOME JURISDICTIONS DO NOT ALLOW THE EXCLUSION OR LIMITATION OF DIRECT, INCIDENTAL, OR CONSEQUENTIAL DAMAGES, SO SOME OR ALL OF THE ABOVE LIMITATIONS OR EXCLUSIONS MAY NOT APPLY TO YOU.



## Notices

---

This information was developed for products and services offered in the U.S.A.

IBM may not offer the products, services, or features discussed in this document in other countries. Consult your local IBM representative for information on the products and services currently available in your area. Any reference to an IBM product, program, or service is not intended to state or imply that only that IBM product, program, or service may be used. Any functionally equivalent product, program, or service that does not infringe any IBM intellectual property right may be used instead. However, it is the user's responsibility to evaluate and verify the operation of any non-IBM product, program, or service.

IBM may have patents or pending patent applications covering subject matter described in this document. The furnishing of this document does not grant you any license to these patents. You can send license inquiries, in writing, to:

IBM Director of Licensing  
IBM Corporation  
North Castle Drive  
Armonk, NY 10504-1785  
U.S.A.

For license inquiries regarding double-byte (DBCS) information, contact the IBM Intellectual Property Department in your country or send inquiries, in writing, to:

Intellectual Property Licensing  
Legal and Intellectual Property Law  
IBM Japan Ltd.  
1623-14, Shimotsuruma, Yamato-shi  
Kanagawa 242-8502 Japan

The following paragraph does not apply to the United Kingdom or any other country where such provisions are inconsistent with local law: INTERNATIONAL BUSINESS MACHINES CORPORATION PROVIDES THIS PUBLICATION "AS IS" WITHOUT WARRANTY OF ANY KIND, EITHER EXPRESS OR IMPLIED, INCLUDING, BUT NOT LIMITED TO, THE IMPLIED WARRANTIES OF NON-INFRINGEMENT, MERCHANTABILITY OR FITNESS FOR A PARTICULAR PURPOSE. Some states do not allow disclaimer of express or implied warranties in certain transactions, therefore, this statement may not apply to you.

This information could include technical inaccuracies or typographical errors. Changes are periodically made to the information herein; these changes will be incorporated in new editions of the publication. IBM may make improvements and/or changes in the product(s) and/or the program(s) described in this publication at any time without notice.

Any references in this information to non-IBM Web sites are provided for convenience only and do not in any manner serve as an endorsement of those Web sites. The materials at those Web sites are not part of the materials for this IBM product and use of those Web sites is at your own risk.

IBM may use or distribute any of the information you supply in any way it believes appropriate without incurring any obligation to you.

Licensees of this program who wish to have information about it for the purpose of enabling: (i) the exchange of information between independently created programs and other programs (including this one) and (ii) the mutual use of the information which has been exchanged, should contact:

IBM Corporation  
Software Interoperability Coordinator, Department YBWA  
3605 Highway 52 N  
Rochester, MN 55901  
U.S.A.

Such information may be available, subject to appropriate terms and conditions, including in some cases, payment of a fee.

The licensed program described in this document and all licensed material available for it are provided by IBM under terms of the IBM Customer Agreement, IBM International Program License Agreement or any equivalent agreement between us.

Any performance data contained herein was determined in a controlled environment. Therefore, the results obtained in other operating environments may vary significantly. Some measurements may have been made on development-level systems and there is no guarantee that these measurements will be the same on generally available systems. Furthermore, some measurements may have been estimated through extrapolation. Actual results may vary. Users of this document should verify the applicable data for their specific environment.

Information concerning non-IBM products was obtained from the suppliers of those products, their published announcements or other publicly available sources. IBM has not tested those products and cannot confirm the accuracy of performance, compatibility or any other claims related to non-IBM products. Questions on the capabilities of non-IBM products should be addressed to the suppliers of those products.

All statements regarding IBM's future direction or intent are subject to change or withdrawal without notice, and represent goals and objectives only.

All IBM prices shown are IBM's suggested retail prices, are current and are subject to change without notice. Dealer prices may vary.

This information is for planning purposes only. The information herein is subject to change before the products described become available.

This information contains examples of data and reports used in daily business operations. To illustrate them as completely as possible, the examples include the names of individuals, companies, brands, and products. All of these names are fictitious and any similarity to the names and addresses used by an actual business enterprise is entirely coincidental.

#### COPYRIGHT LICENSE:

This information contains sample application programs in source language, which illustrate programming techniques on various operating platforms. You may copy, modify, and distribute these sample programs in any form without payment to IBM, for the purposes of developing, using, marketing or distributing application programs conforming to the application programming interface for the operating platform for which the sample programs are written. These examples have not been thoroughly tested under all conditions. IBM, therefore, cannot guarantee or imply reliability, serviceability, or function of these programs. The sample programs are provided "AS IS", without warranty of any kind. IBM shall not be liable for any damages arising out of your use of the sample programs.

Each copy or any portion of these sample programs or any derivative work, must include a copyright notice as follows:

© your company name) (year). Portions of this code are derived from IBM Corp. Sample Programs.

© Copyright IBM Corp. \_enter the year or years\_.

If you are viewing this information softcopy, the photographs and color illustrations may not appear.

## Programming interface information

---

This publication documents intended Programming Interfaces that allow the customer to write programs to obtain the services of IBM i.

## Trademarks

---

IBM, the IBM logo, and ibm.com are trademarks or registered trademarks of International Business Machines Corp., registered in many jurisdictions worldwide. Other product and service names might be

trademarks of IBM or other companies. A current list of IBM trademarks is available on the Web at "[Copyright and trademark information](http://www.ibm.com/legal/copytrade.shtml)" at [www.ibm.com/legal/copytrade.shtml](http://www.ibm.com/legal/copytrade.shtml).

Adobe, the Adobe logo, PostScript, and the PostScript logo are either registered trademarks or trademarks of Adobe Systems Incorporated in the United States, and/or other countries.

IT Infrastructure Library is a registered trademark of the Central Computer and Telecommunications Agency which is now part of the Office of Government Commerce.

Intel, Intel logo, Intel Inside, Intel Inside logo, Intel Centrino, Intel Centrino logo, Celeron, Intel Xeon, Intel SpeedStep, Itanium, and Pentium are trademarks or registered trademarks of Intel Corporation or its subsidiaries in the United States and other countries.

Linux is a registered trademark of Linus Torvalds in the United States, other countries, or both.

Microsoft, Windows, Windows NT, and the Windows logo are trademarks of Microsoft Corporation in the United States, other countries, or both.

ITIL is a registered trademark, and a registered community trademark of the Office of Government Commerce, and is registered in the U.S. Patent and Trademark Office.

UNIX is a registered trademark of The Open Group in the United States and other countries.

Cell Broadband Engine is a trademark of Sony Computer Entertainment, Inc. in the United States, other countries, or both and is used under license therefrom.

Java and all Java-based trademarks and logos are trademarks of Sun Microsystems, Inc. in the United States, other countries, or both.

Other product and service names might be trademarks of IBM or other companies.







Product Number: 5770-SS1