

IBM i  
7.3

*Files and file systems*  
*Files and file systems Database file*  
*management*



**Note**

Before using this information and the product it supports, read the information in [“Notices” on page 211.](#)

This document may contain references to Licensed Internal Code. Licensed Internal Code is Machine Code and is licensed to you under the terms of the IBM License Agreement for Machine Code.

© **Copyright International Business Machines Corporation 1998, 2015.**

US Government Users Restricted Rights – Use, duplication or disclosure restricted by GSA ADP Schedule Contract with IBM Corp.

---

# Contents

<b>Database file management.....</b>	<b>1</b>
What's new for IBM i 7.3.....	1
PDF file for Database file management.....	1
Overview of database file management.....	2
File types.....	2
Working with database files.....	3
File resources allocation.....	3
File resource allocation: Overview.....	3
File resources that must be allocated.....	4
How the system allocates resources.....	4
Copying files.....	5
Copying files: Overview.....	5
Copying files: Commands.....	5
Copying files: Supported functions.....	7
Copying files: Basic functions.....	11
Copying physical or logical files.....	16
Creating the to-file (CRTFILE parameter).....	17
Specifying CRTFILE(*YES) on either the Copy File or Copy From Query File command.....	18
Authorities, user profiles, and file capabilities of the to-file.....	18
Adding, replacing, and updating records (MBROPT parameter).....	19
Specifying *REPLACE when copying files.....	19
Specifying *ADD when copying files.....	19
Specifying *UPDADD when copying files.....	22
Copying records into files that use trigger programs.....	23
Selecting the records to copy.....	23
Selecting records using a specified record format name (RCDFMT parameter).....	24
Selecting records by relative record numbers (FROMRCD and TORCD parameters).....	24
Selecting records by record keys (FROMKEY and TOKEY parameters).....	25
Selecting a specified number of records (NBRRCDs parameter).....	28
Selecting records based on character content (INCCHAR parameter).....	29
Selecting records based on field value (INCREL parameter).....	30
Copying deleted records (COMPRESS parameter).....	32
Printing records (PRINT, UTFMT, and TOFILE(*PRINT) parameters).....	34
Creating an unformatted print listing.....	35
Selecting members to copy.....	35
Copying file members: Overview.....	35
Allowed copy operations and parameters.....	35
Copying all members within a file.....	36
Copying only certain members within a file.....	36
Specifying the member name for the copy operation.....	36
Special considerations for the Override Database File and Override Tape File commands...	37
How the copy function adds members to the to-file.....	37
Copying between different database record formats (FMTOPT parameter).....	38
Specifying data for different field types and attributes.....	40
Converting universal coded character set (UCS-2) graphic fields.....	47
Converting universal coded character set transformation format (UTF-8 character and UTF-16 graphic).....	48
Converting System/370 floating-point and null fields.....	49
Conversion rules for copying files.....	50
Adding or changing source file sequence number and date fields (SRCOPT and SRCSEQ parameters).....	51

Copying device source files to database source files.....	51
Copying database source files to device source files.....	52
Copying database source files to database source files.....	52
Copying complex objects.....	52
Copying files that contain user-defined functions.....	52
Copying files that contain user-defined types.....	52
Copying files that contain datalinks.....	53
Copying files that contain large objects.....	53
Copying files that contain identity columns or ROWID attributes.....	59
Copying between different systems.....	59
Using the Copy From Import File command to copy between different systems.....	59
Using the Copy To Import File command to copy between different systems.....	66
Opened files.....	69
Scope of opened files.....	69
Opening files using temporary file descriptions.....	70
Detection of file description changes.....	73
Displaying information about open files.....	74
Monitoring file status with the open and I/O feedback area.....	74
Shared files.....	76
Open considerations for files shared in a job.....	77
I/O considerations for files shared in a job.....	78
Close considerations for files shared in a job.....	78
Overrides.....	78
Overview: Overrides.....	78
Benefits of using overrides.....	79
Summary of the override commands.....	79
Effect of overrides on some commands.....	80
Usage of overrides in multithreaded jobs.....	82
Application of overrides.....	83
Override of file attributes.....	83
Override of file names.....	84
Override of file names and file attributes.....	85
Override of the scope of an open file.....	85
How the system processes overrides.....	85
Scenario: Effect of exits on overrides.....	91
Scenario: Effect of TFRCTL on overrides.....	92
Scenario: Overrides to the same file at the same call level.....	92
CL program overrides.....	93
Securing files against overrides.....	93
Usage of a generic override for printer files.....	94
Application of overrides when compiling a program.....	96
Deletion of overrides.....	97
Display of overrides.....	97
Example: Displaying all overrides for a specific activation group.....	98
Example: Displaying merged file overrides for one file.....	98
Example: Displaying all file overrides for one file.....	98
Example: Displaying merged file overrides for all files.....	98
Example: Displaying overrides with WRKJOB.....	99
Example: Displaying overrides.....	99
Tips about displaying overrides.....	103
File redirection.....	103
Plans for redirecting files.....	104
Tips about redirecting files.....	104
Default actions for redirected files.....	105
Performance.....	108
Avoiding keyed sequence access paths.....	108
Specifying fewer parameters.....	108
Checking record format level identifiers.....	109

Preventing errors when copying files.....	109
Limitation of recoverable errors during copy.....	109
Prevention of date, time, and timestamp errors when copying files.....	111
Mapping considerations using the Copy Object command.....	111
Prevention of position errors when copying files.....	112
Prevention of allocation errors when copying files.....	112
Reasons for allocation errors when copying files.....	112
Prevention of copy errors that result from constraint relationships.....	113
Copy operation on files not in check-pending status.....	113
Copy operation on files in check-pending status.....	114
Prevention of copy errors related to your authority to files.....	114
Security.....	115
Object authority.....	115
Object operational authority.....	115
Object existence authority.....	116
Object management authority.....	116
Object reference authority.....	116
Object alter authority.....	116
Data authorities.....	116
Authorities required for file operations.....	117
Limitation of access to files and data when creating files.....	119
Troubleshooting database file management.....	120
File error detection and handling by the system.....	120
Messages and message monitors in files by the system.....	121
Major and minor return codes in files by the system.....	122
Recovery from file system errors.....	124
Normal completion of errors by the system.....	124
Completion with exceptions of errors by the system.....	124
Permanent system or file error.....	125
Permanent device or session error on I/O operation.....	125
Device or session error on open or acquire operation.....	125
Recoverable device or session errors on I/O operation.....	126
Reference.....	126
Double-byte character set support.....	126
Double-byte character set fundamentals.....	126
DBCS code scheme.....	127
Shift-control double-byte characters.....	131
Invalid double-byte code and undefined double-byte code.....	131
Usage of double-byte data.....	131
Double-byte character size.....	132
Process of double-byte characters.....	132
Basic double-byte characters.....	132
Extended double-byte characters.....	132
What happens when extended double-byte characters are not processed.....	133
DBCS device file support.....	133
What a DBCS file is.....	133
When to indicate a DBCS file.....	133
How to indicate a DBCS file.....	133
Improperly indicated DBCS files.....	135
DBCS display support.....	136
Inserting shift-control double-byte characters.....	136
Number of displayed extended double-byte characters.....	137
Number of DBCS input fields on a display.....	137
Effects of displaying double-byte data at alphanumeric workstations.....	137
Copy operation of DBCS files.....	137
Copy operation of spooled DBCS files.....	137
Copy operation of nonspooled DBCS files.....	137
Application program considerations for DBCS.....	139

Design of application programs that process double-byte data.....	139
Changing alphanumeric application programs to DBCS application programs.....	140
DBCS font tables.....	140
Commands for DBCS font tables.....	140
Finding out if a DBCS font table exists.....	141
Copying a DBCS font table onto tape or diskette.....	141
Copying a DBCS font table from tape or diskette.....	142
Deleting a DBCS font table.....	142
Starting the character generator utility for DBCS font tables.....	143
Copying user-defined double-byte characters.....	143
DBCS font files.....	143
DBCS sort tables.....	144
Commands for DBCS sort tables.....	145
Using DBCS sort tables on the system.....	145
Finding out if a DBCS sort table exists.....	145
Saving a DBCS sort table onto tape or diskette.....	145
Restoring a DBCS sort table from tape or diskette.....	146
Copying a Japanese DBCS master sort table to a data file.....	146
Copying a Japanese DBCS master sort table from a data file.....	147
Deleting a DBCS sort table.....	147
DBCS conversion dictionaries.....	148
System-supplied dictionary (for Japanese use only) for DBCS.....	148
User-created dictionary for DBCS.....	149
Commands for DBCS conversion dictionaries.....	149
Displaying and printing the DBCS conversion dictionary.....	154
Deleting a DBCS conversion dictionary.....	155
DBCS conversion (for Japanese use only).....	156
Where you can use DBCS conversion.....	156
How DBCS conversion works.....	156
Usage of DBCS conversion.....	157
Performing DBCS conversion.....	157
Feedback area layouts.....	161
Open feedback area.....	161
Device definition list.....	169
Volume label fields.....	177
I/O feedback area.....	177
Common I/O feedback area.....	177
I/O feedback area for ICF and display files.....	186
I/O feedback area for printer files.....	191
I/O feedback area for database files.....	192
Get attributes feedback area.....	197
Related information.....	207
<b>Notices.....</b>	<b>211</b>
Programming interface information.....	212
Trademarks.....	212
Terms and conditions.....	213

---

# Database file management

Traditional file management is the part of the operating system that controls the storing and accessing of traditional file objects (\*FILE objects in the QSYS.LIB library) on the IBM i operating system.

In some previous releases, this has been called *data management*. The data might be on internal storage (for example, database objects), on external media (diskette, tape, or printer objects), or on another system.

**Note:** By using the code examples, you agree to the terms of the [“Code license and disclaimer information”](#) on page 208.

---

## What's new for IBM i 7.3



Read about new or significantly changed information for the Database file management topic collection.

Changes to the Common I/O feedback area. For descriptions and the layout of the Common I/O feedback area see the [“Common I/O feedback area”](#) on page 177 topic.

Changes to the Database I/O feedback area. For descriptions and the layout of the Database I/O feedback area see the [“I/O feedback area for database files”](#) on page 192 topic.

### How to see what's new or changed

To help you see where technical changes have been made, this information uses:

- The  image to mark where new or changed information begins.
- The  image to mark where new or changed information ends.

In PDF files, you might see revision bars (|) in the left margin of new and changed information.

To find other information about what's new or changed this release, see the [Memo to users](#).

---

## PDF file for Database file management

You can view and print a PDF file of this information.

To view or download the PDF version of this document, select [Database file management](#).

### Saving PDF files

To save a PDF on your workstation for viewing or printing:

1. Right-click the PDF link in your browser.
2. Click the option that saves the PDF locally.
3. Navigate to the directory in which you want to save the PDF.
4. Click **Save**.

### Downloading Adobe Reader

You need Adobe Reader installed on your system to view or print these PDFs. You can download a free copy from the [Adobe Web site](http://www.adobe.com/products/acrobat/readstep.html) ([www.adobe.com/products/acrobat/readstep.html](http://www.adobe.com/products/acrobat/readstep.html)) .

### Related reference

[Related information for Database file management](#)

Product manuals, Web sites, and other information center topic collections contain information that relates to the Database file management topic collection. You can view or print any of the PDF files.

## Overview of database file management

---

File management provides the functions that an application uses when you create and access data on the system, and ensures the integrity of the data according to the definitions of the application.

Traditional file management, formerly known as *data management*, is the part of the operating system that controls the storing and accessing of data by an application program. The data might be on internal storage (for example, database), on external media (diskette, tape, printer), or on another system.

File management provides functions that allow you to manage files (create, change, override, or delete) using CL commands, and create and access data through a set of operations (for example, read, write, open, or close). File management also provides you with the capability to access external devices and control the use of their attributes for creating and accessing data.

If you want to make more efficient use of printers and diskette devices, file management provides the capability of spooling data for input or output. For example, data being written to a printer can be held on an output queue until the printer is available for printing.

On the IBM i operating system, each file (also called a file object) has a description that describes the file characteristics and how the data associated with the file is organized into records, and, in many cases, the fields in the records. Whenever a file is processed, the operating system uses this description.

You can create and access data on the system by using these file objects. File management defines and controls several different types of files. Each file type has associated CL commands to create and change the file, and you can also create and access data through the operations provided by file management.

### File types

The file management functions support these types of files.

- **Database files** are files (including distributed files) whose associated data is stored permanently in the system.
- **Device files** are files that provide access to externally attached devices such as displays, printers, tapes, diskettes, and other systems that are attached by a communications line. The device files supported are:
  - Display files, which provide access to display devices
  - Printer files, which describe the format of printed output
  - Tape files, which allow access to data files on tape devices
  - Diskette files, which provide access to data files on diskette devices
  - Intersystem communications function files (ICF files), which allow a program on one system to communicate with a program on the same system or another system.
- **Save files** are files that are used to store saved data on disk (without requiring diskettes or tapes).
- **Distributed data management (DDM) files** are files that allow access to data files stored on remote systems.

Each file type has its own set of unique characteristics that determines how the file can be used and what capabilities it can provide. The concept of a file, however, is the same regardless of what type of file it is. When a file is used by a program, it is referred to by name, which identifies both the file description and, for some file types, the data itself. This information is designed to help you understand the common characteristics of all file types so you can use the files to their full capabilities.

#### Related concepts

[Copying files](#)



With the copy function on the IBM i operating system, you can copy physical and logical files, copy members and records, copy complex objects, and copy files between systems.

#### Opened files

When you want an application to use a file, you do so by referring to that file by name. The file description for that file then controls how the program and the system interact.

#### Limitation of access to files and data when creating files

Specifying authorities allows you to control access to a file. You use the AUT parameter on the create command to specify public authority when you create a file.

#### Shared files

File management on the IBM i operating system provides several levels of support for shared files. Files can be shared among many users, many jobs, or many programs within the same job.

#### Application of overrides

You can perform two general types of overrides, which are file overrides and overrides for program device entries.

## Working with database files

---

This topic describes the various tasks that can be used to ensure that files are used effectively.

- What resources the system has allocated for each file type.
- How to move data between different files such as device and database.
- The options that exist when an application is used for accessing a file.
- The levels of support that exist for shared files.
- The process of changing file attributes such as file name, device name or remote location name.

### File resources allocation

Resources are those parts of the system that are required by a job or task, including main storage, devices, the processing unit, programs, files, libraries, and folders. When you write a high-level language program, you should be aware of what resources the system has allocated for each file type.

Normally, the system performs the allocation whenever a requested operation requires it. For example, the system allocates resources for each file that is used in a program when the file is opened.

To ensure that all of the resources that are needed by a program are available before the program is run, you can use the Allocate Object (ALCOBJ) CL command in the job before you run the program. In particular, the ALCOBJ command can allocate database files and most devices.

The following operations are examples of operations that require resource allocation:

- Open
- Acquire
- Start a program on a remote system

#### **Related information**

[Allocate Object \(ALCOBJ\) command](#)

### File resource allocation: Overview

When a high-level language program uses a file, several operations require that the system allocate the resources that are needed to perform that operation.

The system generally uses file resource allocation to ensure that multiple users do not use the file in conflicting ways. For example, you cannot delete a file while any application program is using it. The system does this by obtaining a lock on the file when it opens. The delete file operation also attempts to get a lock on the file and is unsuccessful because the program that uses the file still has the lock from when the file is opened, and the locks conflict.

## File resources that must be allocated

The file resources that the system must allocate depend on the type of file and the operation.

File resources consist of the following types:

### Open

- For printer and diskette files that are spooled (SPOOL(\*YES)), the file resources include the file description, the specified output queue, and the storage on the system for the spooled data. Because the data is spooled, the device does not need to be available.
- For database files, the file resources consist of the entire file; this includes the file, member, data, and the associated access path.
- For printer and diskette files that are not spooled (SPOOL(\*NO)) as well as for tape files, display files, and some ICF files, the file resources include the file description and the device. For ICF files that use Advanced Program-to-Program Communication (APPC), Advanced Peer-to-Peer Networking (APPN), or intrasystem communications, the file resources include the file description and the session resources that are associated with the device.
- For save files, the file resources consist of the entire file, including the file and data.
- For DDM files, the file resources include the file description and the session resources that are associated with the device.

### Acquire

For display files and ICF files that do not use APPC, APPN, or intrasystem communications, the system allocates the device as a resource. For ICF files that use APPC, APPN, or intrasystem communications, resources include the session resources that are associated with the device.

### Start a program on a remote system

Session resources that are needed for APPC and APPN.

## How the system allocates resources

When the system allocates resources, it waits for a predefined time if the resources are not immediately available. If the resources do not become available within the time limit, the system generates an error.

If you are using the Allocate Object (ALCOBJ) command, the command fails. If your program is performing a file operation, that operation fails, and the system sends an error message to the program message queue. You can use the error-handling functions of your high-level language to try the operation again. For example, if an open operation fails because another job is using the device associated with the file, you can try the open operation a specified number of times again, in the hope that the other job would finish with the device and your program would then be able to use it.

The length of time that the system waits when allocating resources is specified on the ALCOBJ command and on the WAITFILE parameter of the CL command used to create the file. If the ALCOBJ command is used before running a program, then the value of the WAITFILE parameter does not matter, because the resources is available.

If your application has error handling procedures for handling device errors that occur on device files, you need to specify a value of something other than \*IMMED to allow the system to recover from the error. The allocation of resources requested by your program on an open or acquire operation that allows your program to recover from the error is not successful until the system recovery procedures have been completed for the device.

The following list describes the values that are allowed for the WAITFILE parameter:

#### **\*IMMED**

This value specifies that no wait time is allowed. An immediate allocation of the file resources is required.

#### **\*CLS**

The job default wait time is used as the wait time for the file resources to be allocated.

**number-of-seconds**

Specify the maximum number of seconds that the program is to wait for the file resources to be allocated. Valid values are 1 through 32767 (32 767 seconds).

**Related information**

[Allocate Object \(ALCOBJ\) command](#)

## Copying files

With the copy function on the IBM i operating system, you can copy physical and logical files, copy members and records, copy complex objects, and copy files between systems.

You can move data between device files, database files, or both device and database files with the IBM i field-level-sensitive copy function. This function allows you to rearrange, enlarge, or drop any of the fields. You can also define database files.

**Related concepts**

[File types](#)

The file management functions support these types of files.

### Copying files: Overview

You can use the copy function to move data between device files, between database files (including distributed DB2<sup>®</sup> Multisystem files), or between device and database files.

Unlike traditional copy utilities, the IBM i copy function is field-level sensitive. Therefore, if you use the copy function, you can rearrange, enlarge, or drop any of the fields. The system also provides a way to define database files. Specific copy commands simplify dealing with tape and diskette units, database source files, and open query files.

See the Control language topic for the specific parameters supported by each copy command.

**Related information**

[Control language](#)

### *Copying files: Commands*

You can copy records to and from files with commands discussed in this topic.

To copy records to and from files, use the following commands:

**CPYF**

Copy File (CPYF) command copies all or part of a file from the database or external device to the database or external device.

**CPYFRMTAP**

Copy from Tape (CPYFRMTAP) command copies from a tape file to a database or device file. The from-file must be a tape file, but the to-file can be a physical file, diskette file, tape file, or program-described printer file. You can obtain a formatted listing of the records by using QSYSPT.

**CPYTOTAP**

Copy to Tape (CPYTOTAP) command copies from a database or device file to a tape file. The to-file must be a tape file, but the from-file can be a physical, logical, diskette, tape, or inline data file.

**CPYSRCF**

Copy Source File (CPYSRCF) command copies a database source file to a source physical file and converts the data in the from-file to the to-file CCSID. You can create a formatted listing by using QSYSPT (the file is changed for source records and is different from other copy command file formats). Record data is copied from the from-file to the to-file, disregarding differences in record formats (similar to the FMTOPT(\*NOCHK) parameter option on the CPYF command, except for the CCSIDs).

For new members that are added to the to-file, or if the MBROPT(\*REPLACE) parameter is specified, you can specify whether the last source update date and time is a new date or is copied from the

from-file with the source change date (SRCCHGDATE) parameter. This is also the default value for the CPYF command.

### **CPYFRMQRYP**

Copy from Query File (CPYFRMQRYP) command copies an open query file to a database or device file.

The system does not reclaim DDM conversations for a job when a copy command produces an error.

If you specify a DDM file and a local file on the CPYF or CPYSRCF commands, the system does not verify that the remote and local files are not the same on the source system. If you specify one DDM file, you can potentially copy to and from the same file.

For information about how to copy DBCS-open fields to graphic fields (including the option of removing trailing single-byte blanks for the DBCS-open field first), see [“DBCS-graphic fields using FMTOPT\(\\*MAP\) or FMTOPT\(\\*NOCHK\)”](#) on page 46.

Throughout this topic, unless the text specifies a specific command, the term *copy commands* refers to all the commands just described.

The device and database files where you can perform copy operations are shown in [Table 1 on page 6](#).

*Table 1. Copy operations*

<b>From-files</b>	<b>To-files</b>
DDM	DDM
Diskette <sup>1</sup>	Diskette <sup>1</sup>
Logical	Physical <sup>2</sup>
Open query <sup>3</sup>	Printer
Physical	*PRINT <sup>4</sup>
Inline data <sup>5</sup>	Tape
Tape	

#### **Notes:**

**1**

If the from-file and the to-file are both diskette files, the to-file must be spooled.

**2**

If the to-file does not exist before the copy operation, the copy operation will create a physical file as the to-file if you specified:

- CRTFILE(\*YES) on the CPYF command and the from-file is a physical or logical file.
- CRTFILE(\*YES) on the CPYFRMQRYP command.

**3**

Open query files can only be copied by using the CPYFRMQRYP command. CPYFRMQRYP is not allowed for open query files that use DDM files.

**4**

If TOFILE(\*PRINT) is specified, the from-file records are copied to the IBM-supplied printer device file QSYSVRT and formatted according to the OUTFMT parameter.

**5**

An inline data file (which is handled like a device file) is included as part of a batch job when the job is read by a reader program.

While copying records, some of the copy commands can perform the following functions:

- Copy from or to the first file member, a particular file member, a generic set of members, or all file members (FROMMBR and TOMBR parameters).
- Add a member to a physical to-file if the member does not exist.

- Add records to an existing file member, replace the contents of an existing member (MBROPT parameter), or update duplicate key records in a to-file member.
- Select certain records to copy by one of the following methods:
  - Selecting records by record format name when a multi-format logical file is copied (RCDFMT parameter).
  - Specifying records by starting at a relative record number and ending at a relative record number (FROMRCD and TORCD parameters).
  - Specifying records by starting with a specific record key value and ending with another specific record key value (FROMKEY and TOKEY parameters).
  - Specifying the number of records that you want to copy (NBRRCDs parameter).
  - Selecting records by the contents of one or more character positions in the record or in a field in the record (INCCHAR parameter).
  - Selecting records according to the values that are contained in one or more fields in the record (INCREL parameter).
  - Disregard or include deleted records in the from-file during the copy if processing the from-file in arrival sequence (COMPRESS parameter).
- Print copied records, excluded records, or error records (PRINT parameter) in a specified format (OUTFMT parameter).
- Copy records whose from-file and to-file record formats are different (FMTOPT parameter). When formats are different, you can perform any of the following actions:
  - Map fields whose names are the same in the from-file and to-file record formats and whose field attributes are compatible (\*MAP value).
  - Drop fields in the from-file record format that do not exist in the to-file record format (\*DROP value).
  - Copy data directly (left to right) disregarding any differences (\*NOCHK value).
- Copy from a source file to a data file or from a data file to a source file. If the from-file or to-file is a device file, this function is automatic. If both files are database files, you must specify FMTOPT(\*CVTSRC).
- Change sequence numbers and zero dates in the sequence number and date source fields when copying to a source physical file (SRCOPT parameter). When renumbering is to be done, the starting sequence number and the increment value can be specified (SRCSEQ parameter).
- End the copy after a specified number of recoverable errors are encountered (ERRLVL parameter).
- Create the to-file as part of the copy operation (CRTFILE parameter).

### ***Copying files: Supported functions***

The IBM i operating system provides many copy functions for database files and for device files. Each function has associated parameters and file types.

The following tables, (Table 2 on page 7 and Table 3 on page 9), provide a summary of the specific copy functions (using the copy commands) you can use for copying records by the types of files being copied from and to. The functions with their associated parameters are listed down the left side, and the file types (and if each can be a from-file and a to-file) are shown across the top. An X indicates that the associated parameter is valid for the type and use of file under which it occurs.

*Table 2. Summary of copy functions for database files*

Copy function	Parameter	Database files <sup>1</sup>			
		Physical		Logical	
		From	To	From	To
Select files	FROMFILE <sup>2</sup>	X		X	
	TOFILE		X		

Table 2. Summary of copy functions for database files (continued)

Copy function	Parameter	Database files <sup>1</sup>			
		Physical		Logical	
		From	To	From	To
Select members	FROMMBR	X		X	
	TOMBR		X		
Add to, replace, or update existing records	MBROPT		X		
Create the to-file	CRTFILE <sup>3</sup>	X	X	X	
Print copied, excluded, and error records	PRINT <sup>4</sup>	X	X	X	
Select by record format	RCDFMT			X	
Select by relative record number	FROMRCD	X		X <sup>5</sup>	
	TORCD	X		X <sup>5</sup>	
Select by key field value	FROMKEY	X		X	
	TOKEY	X		X	
Specify number of records to copy	NBRRCDS	X		X	
Select by character content	INCCHAR	X		X	
Select by field value	INCREL	X		X	
Process different database record formats	FMTOPT	X	X	X	
Update sequence number and date	SRCOPT	X	X	X	
Specify start value and increment	SRCSEQ	X	X	X	
Print character and hex format	OUTFMT <sup>4</sup>	X	X	X	
Maximum recoverable errors allowed	ERRLVL	X	X	X	
Disregard or include deleted records	COMPRESS <sup>6</sup>	X	X		

Table 2. Summary of copy functions for database files (continued)

Copy function	Parameter	Database files <sup>1</sup>			
		Physical		Logical	
		From	To	From	To
<b>Notes:</b>					
1	DDM files will appear to act like database files, with exceptions noted in <a href="#">Distributed database programming</a> .				
2	On the CPYFRMQRYP command, the FROMOPNID parameter is used to identify an open identifier for the open query file to be copied from. The FROMFILE parameter is used in all other copy commands.				
3	If the to-file does not exist before the copy operation and the from-file is a physical or logical file, the copy operation will create a physical file as the to-file if you specified CRTFILE(*YES) on the copy commands.				
4	You can specify a program-described printer file so that the copy will produce a list with no special formatting or page headings, or you can specify TOFILE(*PRINT) to produce a formatted list. You can specify PRINT(*COPIED) to produce a formatted list of the copied records, you can specify PRINT(*EXCLD) to produce a formatted list of the records excluded by the INCCHAR or INCREL parameters, and you can specify PRINT(*ERROR) to produce a formatted list of records causing ERRLVL errors. When you request a list by specifying the TOFILE(*PRINT) parameter, the OUTFMT parameter specifies whether the data is printed in character or in both character and hexadecimal form.				
5	You can specify the FROMRCD and TORCD parameter values for a logical file if it has an arrival sequence access path.				
6	You cannot specify COMPRESS(*NO) if: <ul style="list-style-type: none"> <li>• The to-file member or a logical file member based on the to-file member has a keyed access path with any of the following attributes: <ul style="list-style-type: none"> <li>– Unique keys (UNIQUE keyword specified in the DDS)</li> <li>– Floating-point key field or logical numeric key field and not MAINT(*REBLD)</li> <li>– Select/omit specifications in the DDS (without the DYNSLT keyword specified) and not MAINT(*REBLD)</li> </ul> </li> <li>• Field-level mapping or source/data conversion is required (FMTOPT parameter).</li> <li>• An EOFDLY wait time is specified for the from-file on an Override Database File (OVRDBF) command.</li> </ul> <p><b>Note:</b> To copy deleted records, the from-file must be processed in arrival sequence.</p>				

Table 3. Summary of copy functions for device files

Copy function	Parameter	Device files							
		Inline data		Diskette		Tape		Printer	
		From	To	From	To	From	To	From	To
Select files	FROMFILE	X		X		X			
	TOFILE				X		X		X
Select members	FROMMBR			X		X			
	TOMBR				X		X		

Table 3. Summary of copy functions for device files (continued)

Copy function	Parameter	Device files							
		Inline data		Diskette		Tape		Printer	
		From	To	From	To	From	To	From	To
Add to or replace existing records	MBROPT								
Create the to-file	CRTFILE								
Print copied or excluded records	PRINT <sup>1</sup>	X		X	X	X	X		X
Select by record format	RCDFMT								
Select by relative record number	FROMRCD	X		X		X			
	TORCD	X		X		X			
Select by key field value	FROMKEY								
	TOKEY								
Specify number of records to copy	NBRRCD	X		X		X			
Select by character content	INCCHAR	X		X		X			
Select by field value	INCREL								
Process different database record formats	FMTOPT								
Update sequence number or date	SRCOPT								
Specify start value and increment	SRCSEQ								
Print character or hex format	OUTFMT <sup>1</sup>	X		X	X	X	X		X
Maximum recoverable errors allowed	ERRLVL					X			
Disregard or include deleted records	COMPRESS								

**Note:**

1

You can specify a program-described printer file so that the copy will produce a list with no special formatting or page headings, or you can specify TOFILE(\*PRINT) to produce a formatted list. You can specify PRINT(\*COPIED) to produce a formatted list of the copied records, you can specify PRINT(\*EXCLD) to produce a formatted list of the records excluded by the INCCHAR or INCREL parameter, and you can specify PRINT(\*ERROR) to produce a formatted list of records causing ERRVL errors. When you request a list by specifying the TOFILE(\*PRINT) parameter, the OUTFMT parameter specifies whether the data is printed in character or in both character and hexadecimal form.



## **Copying files: Basic functions**

You can copy from a physical or logical database file, open query file, diskette file, tape file, or inline data file. The to-file can be a physical database file, diskette file, tape file, program-described printer file, or \*PRINT.

When you specify TOFILE(\*PRINT), the Copy Source File (CPYSRCF) command uses a different format from the other copy commands. This format shows source information in a more readable format, and, for multiple member copies, the members are copied and listed in alphabetical order.

If you are copying from a database file and the to-file does not exist, you must specify CRTFILE(\*YES) and identify the file name and library name on the TOFILE parameter in order to create the to-file. You cannot copy from a diskette to a diskette unless the to-file is spooled and a diskette spooling writer is not active.

The from-file (not including the Copy From Query File (CPYFRMQRYF) command where the from-file is not opened), to-file, and the QSYSPRT printer file (if TOFILE(\*PRINT), PRINT(\*COPIED), PRINT(\*EXCLD), or PRINT(\*ERROR) is specified) are opened with the SHARE(\*NO) attribute. Because the copy might not function correctly with a shared file, it will end with an error message if the from-file, to-file, or QSYSPRT printer file is overridden to SHARE(\*YES) and the file has already been opened in the job.

If you specify TOFILE(\*PRINT), the records are copied to the IBM-supplied printer file QSYSPRT, and the OUTFMT parameter formats the list.

If you do not want a formatted list or if you want to use first-character forms control (CTLCHAR(\*FCFC) on the Create Printer File (CRTPRTF) or Override with Printer File (OVRPRTF) command), you should specify a program-described printer file name (such as QSYSPRT) instead of \*PRINT on the TOFILE parameter.

### **Related information**

[Copy Source File \(CPYSRCF\) command](#)

[Copy From Query File \(CPYFRMQRYF\) command](#)

[Create Printer File \(CRTPRTF\) command](#)

[Override with Printer File \(OVRPRTF\) command](#)

### *File types and copying*

You need to consider this information when you copy files of one type to files of another type.

When the from-file and to-file are different types (source and data), the following statement is true. For the [CPYFRMQRYF](#) command, the from-file is always treated as a data file:

- If the from-file or to-file is a device file (or an inline data file), the copy function will automatically add or delete the source sequence number and date fields for each record copied.
- If the from-file and to-file are database files, you must specify FMTOPT(\*CVTSRC) to perform the operation. The sequence number and date fields are added or deleted as they are for a device file, and the data part of each record is copied without regard to the field definitions in the file record formats. For a source physical to-file, you can use the SRCSEQ parameter to control how sequence numbers are created if you also specified SRCOPT(\*SEQNBR).

### *Record sequence and copying*

The *access path* is the sequence in which records are organized in a database file. There are two types of access paths: *keyed sequence* and *arrival sequence*. With the copy function, you can process records in a database file in either arrival sequence or keyed sequence.

An arrival sequence copy transfers records in the order in which they physically exist in the from-file. Relative record numbers represent this order. The *relative record number* is the position where the records physically exist in storage. Because records are always added to the end of the file, the relative record number represents the order in which records arrived in the file.

A keyed sequence copy selects and transfers records by key value from a keyed physical file. This might result in a different physical order in the to-file. The to-file will be a reorganized version of the from-file. The relative record number of a specific record might change when a file is copied by key value:

Relative record number	Arrival sequence	Keyed sequence
1	1011	0016
2	0762	0762
3	0810	0810
4	3729	1011
5	0016	3729

You can copy a keyed physical file in arrival sequence by specifying the FROMRCD or TORCD parameter on the COPY commands. When you do this, the keyed sequence access path is not used to retrieve the records in key sequence. The records are retrieved in arrival sequence. This is helpful when the physical relative record location in the file is significant and needs to remain the same as it is in the original file. Specifying FROMRCD(1) is a good way to copy all the records in arrival sequence. Copying a physical file in arrival sequence instead of keyed sequence is also faster.

The kind of copy you run is determined by the type of from-file and the method of selecting records to copy. In general, files are copied using their keyed sequence, if they have one, otherwise, their arrival sequence.

A copy from a keyed file to a keyed file typically places records at the end of the to-file in key field order, by the from-file key, regardless of their physical order in the from-file. But if you select records in the from-file by relative record number (using the FROMRCD or TORCD parameter), they are physically placed at the end of the to-file in relative record number order, regardless of their keyed sequence in the from-file. The following example shows the result of a COPY command that specifies from record 3 to record 5:

From-file			To-file	
Relative record number	Key		Relative record number	Key
1	1011		.	—
2	0762		.	—
3	0810	< Arrival < Sequence < Copy	1401	0810
4	3729		1402	3729
5	0016		1403	0016

When the to-file has a keyed sequence, the records appear in correct order in the to-file when using the keyed sequence access path. A copy by relative record number always copies by arrival sequence.

### Related concepts

#### Selecting the records to copy

You can use parameters on the copy commands to select only the specific records that you want to copy.

#### Resending copy file completion message

If you run a COPY command from a CL program, the completion message indicating the number of records that are copied is not sent directly to the system operator. You can direct this message to the system operator by resending it.

The following example is a sample CL program that resends the COPY command using the `SNDPGMMSG` command.

**Note:** By using the code example, you agree to the terms of the [“Code license and disclaimer information”](#) on page 208.

```
PGM
DCL &MSGID TYPE(*CHAR) LEN(7)
```

```
DCL &MSGDTA TYPE(*CHAR) LEN(82)
CPYF FROMFILE(LIB1/XXX) TOFILE(LIB2/XXX) +
  MBROPT(*ADD)
RCVMSG MSGID(&MSGID) MSGDTA(&MSGDTA) +
  MSGTYPE(*COMP) RMV(*NO)
SNDPGMMSG MSGID(&MSGID) MSGF(QCPFMSG) +
  MSGTYPE(*INFO) TOMSGQ(QSYSOPR) +
  MSGDTA(&MSGDTA)
ENDPGM
```

The copy function sends one of the following completion messages for each from-file member/label successfully copied to the to-file:

- CPC2955 is the normal copy completion message.
- CPC2956 is used when COMPRESS(\*NO) is specified.
- CPC2957 indicates that no records were copied.
- CPC2954 is sent as a second completion message after the CPC2955, CPC2956, or CPC2957 completion message is sent, when you have specified MBROPT(\*UPDADD). It will indicate the number of records that were updated.

#### *Monitoring for copy errors*

When an error occurs, the escape message CPF2817 is sent to indicate many different error conditions.

Except for the empty from-file member case, which is described later, when this message is sent:

- A physical file is not created (even if CRTFILE(\*YES) was specified on a copy command).
- No members are added to a to-file that is a physical file.
- No to-file member is cleared (even if MBROPT(\*REPLACE) was specified).
- The to-file is not opened, so no file is created on a diskette or tape volume. If the to-file is spooled, no spooled file is created.
- No records are copied.

The CPF2817 escape message is always preceded by at least one diagnostic message that indicates the specific error condition. The message identifier of the diagnostic message, which immediately precedes the CPF2817 escape message is used as message replacement data (MSGDTA parameter on the Send Program Message (SNDPGMMSG) command) for the CPF2817 escape message. This enables you to monitor for specific error cases from the CPF2817 escape message by using the CMPDTA parameter on the Monitor Message (MONMSG) command.

For example, message CPF2802 is a diagnostic message. It indicates that the from-file cannot be found. You can monitor for just the `from-file not found` condition as follows:

```
PGM
    /* The replacement text of escape
    CPF2817 contains the msg ID
    CPF2802 for the 'from-file not
    found' condition */
CPYF FROMFILE(NOLIB/NOFILE) TOFILE(D504/KEY) +
  FROMMBR(NOMBR) TOMBR(MBR1) MBROPT(*ADD)
MONMSG MSGID(CPF2817) CMPDTA(CPF2802) +
  EXEC(SNDPGMMSG TOPGMQ(*EXT) +
  MSG('File NOFILE in NOLIB not found'))
ENDPGM
```

Any error other than `from-file not found`, including any other error reported with a CPF2817 escape message, causes a check in this program because the MONMSG command applies only to the CPF2817 escape message when it has the compare data from message CPF2802.

If you are running the Copy From Query File (CPYFRMQRYF) command, it does not close the open query file after completing the copy operation. However, if you are running the CPYFRMQRYF command from a command entry line, any error message that occurs after the Open Query File (OPNQRYF) command is successfully run closes the file unless you specified TYPE(\*PERM) on the OPNQRYF command. The system automatically runs a Reclaim Resources (RCLRSC) command if an error messages occurs. If the OPNQRYF command specifies TYPE(\*PERM), the system does not automatically close the file.

The following messages can be sent as diagnostic messages, followed immediately by a CPF2817 escape message. Some of these messages can also be sent as other message types (such as an informational or escape message). When the message is sent as a diagnostic message type, the message identifier appears in the replacement text of the CPF2817 escape message. You can monitor the condition by using the CMPDTA parameter on the MONMSG command:

CPD2807 CPD2808	CPF2806 CPF2807	CPF2840 CPF2841	CPF2872 CPF2873
CPD2809 CPD2810	CPF2808 CPF2810	CPF2842 CPF2843	CPF2874 CPF2877
CPD2811 CPD2812	CPF2811 CPF2812	CPF2844 CPF2847	CPF2878 CPF2879
CPD2825 CPD2968	CPF2813 CPF2814	CPF2848 CPF2849	CPF2881 CPF2883
CPD2969 CPD2970	CPF2816 CPF2819	CPF2851 CPF2853	CPF2884 CPF2890
CPD2971 CPD2972	CPF2820 CPF2821	CPF2854 CPF2855	CPF2891 CPF2893
CPD2973 CPD2974	CPF2822 CPF2823	CPF2856 CPF2857	CPF2960 CPF2962
CPD2975 CPD2976	CPF2825 CPF2826	CPF2860 CPF2861	CPF2963 CPF2965
CPD2979 CPD2980	CPF2827 CPF2831	CPF2862 CPF2863	CPF2969 CPF9807
CPD2981 CPF2801	CPF2832 CPF2833	CPF2864 CPF2865	CPF9808 CPF9820
CPF2802 CPF2803	CPF2834 CPF2836	CPF2868 CPF2869	CPF9830
CPF2804 CPF2805	CPF2837 CPF2839	CPF2870 CPF2871	

#### *Monitoring for zero records in the from-file*

There are some special considerations for copy when the from-file is a physical or logical file and one or more members to be copied are empty.

A member is considered empty in the following cases:

- You specified COMPRESS(\*NO) on the CPYF command, and the from-file member contains no records.
- You specified COMPRESS(\*YES) for a COPY command, and the from-file members contain no undeleted records.

Members copied involving record selection (CPYFRMQRYP command or the INCCCHAR and INCREL parameters of the CPYF command) that produce no records are not considered empty.

When the to-file is a printer file (including \*PRINT), or when the to-file is a physical file and you specified MBROPT(\*ADD) or MBROPT(\*UPDADD), empty from-file members are copied because no existing data will be destroyed. Each member that is copied is identified by a normal copy completion message. If the to-file is spooled, an empty spooled file is produced for each empty from-file member. If the PRINT parameter on the CPYF command specifies \*COPIED, \*EXCLD, or \*ERROR, the empty members are shown in the lists, and no records are printed.

Except for the CPYFRMQRYP command, an empty from-file member is never copied to a diskette or tape file, or to a physical file when MBROPT(\*REPLACE) is specified. Empty from-file members are skipped for these types of to-files, and a CPF2869 message is sent (as either an informational or diagnostic message) to identify each empty member. The empty members are skipped to avoid destroying existing data. When an empty from-file member is skipped, the following considerations apply:

- A tape or diskette file is not produced on the output volume. If the diskette file is spooled, no spool output file is created.
- An existing to-file physical file member is not cleared.
- If the to-file does not exist and you specified CRTFILE(\*YES) on a copy command, a physical file is created.
- If the to-file is a physical file and the to-file member does not exist, a member is added to the file.
- If the PRINT parameter on the CPYF command specifies \*COPIED, \*EXCLD, or \*ERROR, the empty members are not shown in the lists.

When the copy command specifies a generic name or \*ALL for the FROMMBR parameter, each empty from-file member skipped is identified by message CPF2869, sent as an informational message. If all the from-file members are skipped, a CPF2870 diagnostic message is sent after all the CPF2869 informational messages, followed by a CPF2817 escape message.

When the copy command specifies a single member name or FROMMBR(\*FIRST), or when there is an override for the from-file that forces a single member to be processed, an empty member that is skipped is identified by the diagnostic message CPF2869. The CPF2869 diagnostic message is followed by a CPF2817 escape message.

In the following example, the from-file and to-file are both database files, and EMPTY1 and EMPTY2 are empty members in the from-file.

**Note:** By using the code examples, you agree to the terms of the [“Code license and disclaimer information”](#) on page 208.

```
PGM
      /* No need to monitor for zero records
      when MBROPT(*ADD) specified */
CPYF  FROMFILE(D504/GEORGE) TOFILE(D504/KEN) +
      FROMMBR(EMPTY1) TOMBR(MBR1) MBROPT(*ADD)
CPYF  FROMFILE(D504/GEORGE) TOFILE(D504/KEN) +
      FROMMBR(EMPTY2) TOMBR(MBR2) MBROPT(*REPLACE)
MONMSG MSGID(CPF2817) CMPDTA(CPF2869) +
      EXEC(CLRPFM FILE(D504/KEN) MBR(MBR2))
      /* Monitor for zero records and
      send a message when all members
      to copy are empty */
CPYF  FROMFILE(D504/GEORGE) +
      TOFILE(D504/NEWFILE) FROMMBR(EMPTY*) +
      TOMBR(NEWMBR) MBROPT(*REPLACE)
MONMSG MSGID(CPF2817) CMPDTA(CPF2870) +
      EXEC(SNDPGMMSG TOPGMQ(*EXT) +
      MSG('All members to copy are empty'))
ENDPGM
```

For the first `CPYF` command, `MBROPT(*ADD)` is specified, so an escape message is not sent to the program because of the empty from-file member. Note that if `MBR1` does not exist before the copy, it is added to the to-file (if either the from-file member is empty or contains data).

For the second `CPYF` command, copy does not clear the to-file member when the from-file member is empty, so the `MONMSG` command after the second `CPYF` command starts the `CLRPFM` command to clear the to-file member when the from-file member is empty.

For the third `CPYF` command, the `CPF2817` escape message has compare data of `CPF2870` if all members to be copied are empty because the generic from-file member name, `EMPTY*`, requests that multiple members be copied.

### *Creating a duplicate to-file member*

You can create duplicates to-file members without doing the copy file action again.

When your application requires an exact duplicate of the records in the to-file member (if either the from-file is empty or contains data), an alternative solution is to use the [Clear Physical File Member \(CLRPFM\)](#) command:

```
CLRPFM FILE(X) MBR(XYZ)
CPYF FROMFILE(Y) TOFILE(X) TOMBR(XYZ) +
      MBROPT(*ADD)
```

Because `MBROPT(*ADD)` is specified, the [Copy File \(CPYF\)](#) command completes normally even if there is no data in file Y. `MBR(XYZ)` in file X contains an exact duplicate of the records in the member in file Y.

### *Copy From Query File command support for CCSIDs*

The Copy from Query File (`CPYFRMQRYPF`) command provides coded character set identifier (CCSID) conversions for character and double-byte character sets (DBCS) fields.

The Open Query File (`OPNQRYPF`) command converts all character and DBCS fields to the current job CCSID, except for fields that have a CCSID of 65535 or where `*HEX` is specified on the `MAPFLD` parameter. If the current job CCSID is 65535, then no conversions are done by `OPNQRYPF`. The Copy from Query File (`CPYFRMQRYPF`) command can also do conversions to the to-file field CCSIDs, so it is possible that double conversions will be done and data might be lost. To avoid the possibility of doing double conversions, change the job CCSID to 65535 before doing an `OPNQRYPF` if you plan to do a `CPYFRMQRYPF`.

CPYFRMQRYF uses a different query format. It is the same as the open query file format except for the CCSIDs for character and DBCS fields. The CCSIDs in this query format are determined according to the following conditions:

- If the OPNQRYF job CCSID is 65535, all character and DBCS fields in the query format have the same CCSIDs as the open query file format.
- If the OPNQRYF job CCSID is not 65535, all character and DBCS fields in the query format have their CCSIDs reset to the associated single-byte, mixed or double-byte CCSIDs of the OPNQRYF job CCSID, based on the field type. Fields with a CCSID of 65535 remain unchanged. If there is no associated mixed or double-byte CCSID for the OPNQRYF job CCSID, 65535 is used.

### **Related information**

[Working with CCSIDs](#)

*Copy Source File command support for CCSIDs*

Using the Copy Source File (CPYSRCF) command automatically converts data in the from-file to the to-file CCSID. If you do not want the character data converted, use the CPYF command with FMTOPT(\*NOCHK).

### **Related information**

[Copy Source File \(CPYSRCF\) command](#)

[Copy File \(CPYF\) command](#)

*Copy commands support for null values*

You can copy files that contain null-capable fields by using the Copy File (CPYF) and Copy From Query File (CPYFRMQRYF) commands. The FMTOPT parameter allows mapping of null-capable fields.

The INCREL parameter allows the selection of records that are based on whether a field is or is not null.

While copying the records to the to-file, the following commands ignore null values in the from-file:

#### **CPYTOTAP**

CPYTODKT

#### **CPYFRMTAP**

CPYFRMDKT

The following conditions or values on the CPYF or CPYFRMQRYF command ignore null values in the from-file while copying the records to the to-file:

#### **FMTOPT(\*NOCHK)**

#### **FMTOPT(\*CVTSRC)**

#### **Device to-file**

Record selection involving null values can still be done, but only the user-specified or default value in the buffer (rather than a null value) is copied to the to-file. Null values cannot be preserved in these instances. Any print listings produced when a copy command is run (including TOFILE(\*PRINT), PRINT(\*COPIED), PRINT(\*EXCLUDE), and PRINT(\*ERROR)) also ignore null values.

### **Related information**

[Copy File \(CPYF\) command](#)

[Copy From Query File \(CPYFRMQRYF\) command](#)

## **Copying physical or logical files**

To copy a physical or logical file (the from-file) on the IBM i operating system into another physical file (the to-file) that does not yet exist, you can use the Copy File (CPYF) command.

Here is an example:

```
CPYF FROMFILE(PERSONNEL/PAYROLL)
     TOFILE(TESTPAY/PAYROLL) MBROPT(*ADD)
     CRTFILE(*YES) ERRVL(10)
```

## Full-service copy support

A variety of copy commands that are modified by numerous parameters give you a great deal of flexibility in the way you copy your data. For instance, you typically can copy your data into existing files (or to-files). As shown in the example above, you can use the CRTFILE parameter on the CPYF or CPYFRMQRYP commands to create the to-file during the copy operation.

See [“Copying files: Overview”](#) on page 5 to learn about the basic functions relating to the IBM i copy commands.

## Copying only the information you need

The copy function lets you specify selected records and members of your files:

- [“Adding, replacing, and updating records \(MBROPT parameter\)”](#) on page 19
- [“Selecting members to copy”](#) on page 35
- [“Selecting the records to copy”](#) on page 23

## Copying across different formats and systems

- [“Copying between different database record formats \(FMTOPT parameter\)”](#) on page 38. You can copy from a source file to a data file or from a data file to a source file. If the from-file or to-file is a device file, this function is automatic. If both files are database files, you must specify FMTOPT(CVTSRC). If either file is a device file or inline data file, the FMTOPT parameter does not apply.
- [“Copying between different systems”](#) on page 59. This is especially important when you are using data warehousing, and when you want to use existing export products from other platforms to move data to the IBM i platform.

## Making the copy function work for your particular needs

You can accomplish a wide variety of tasks with careful use of the options that are available to you through the copy function.

- [“Printing records \(PRINT, OUTFMT, and TOFILE\(\\*PRINT\) parameters\)”](#) on page 34
- [“Adding or changing source file sequence number and date fields \(SRCOPT and SRCSEQ parameters\)”](#) on page 51
- [“Preventing errors when copying files”](#) on page 109
- [“Performance”](#) on page 108

### Related concepts

[Creating the to-file \(CRTFILE parameter\)](#)

To copy a physical or logical file when no to-file exists to receive the data, you can create the to-file by specifying CRTFILE(\*YES).

### Related information

[Copy File \(CPYF\) command](#)

[Copy From Query File \(CPYFRMQRYP\) command](#)

## Creating the to-file (CRTFILE parameter)

To copy a physical or logical file when no to-file exists to receive the data, you can create the to-file by specifying CRTFILE(\*YES).

In such cases, you specify the name of the new to-file on the TOFILE parameter, and qualify the name with the name of an existing library for which you have the required authority. (You must also have authority to the [Create Physical File \(CRTPF\)](#) command). You cannot override the created to-file that you specified to a different file or library.

CRTFILE(\*YES) automatically adds members and records to the new file.

The newly created file has certain authorities, capabilities, and a user profile associated with it. Your system specifies different identifiers and attributes to the new file based on whether you use the [Copy File \(CPYF\)](#) or [Copy From Query File \(CPYFRMQRYF\)](#) command.

### **Related concepts**

#### Copying physical or logical files

To copy a physical or logical file (the from-file) on the IBM i operating system into another physical file (the to-file) that does not yet exist, you can use the Copy File (CPYF) command.

### ***Specifying CRTFILE(\*YES) on either the Copy File or Copy From Query File command***

You get different results while specifying CRTFILE(\*YES) on the Copy File (CPYF) command and the Copy From Query File (CPYFRMQRYF) command.

If you specify CRTFILE(\*YES) on the [CPYF](#) command, the to-file that is created has the same record format and type of access path as the from-file. The file level and the format level identifiers of the new to-file are identical to the file level and the format level identifiers of the from-file. The text of from-file members that are copied is used as the text of any to-file members that are created.

When the from-file is a logical file, the system assigns the following physical file attributes: SIZE(\*NOMAX), ALLOCATE(\*NO), and CONTIG(\*NO). If the from-file is a logical file with multiple record formats, the to-file is created with the format that is specified on the RCD\_FMT parameter on the CPYF command.

If you specify CRTFILE(\*YES) on the [CPYFRMQRYF](#) command, the file-level and the format-level identifiers of the new to-file are generated at the time the new to-file is created. Furthermore, the physical file's attributes match the first file that is specified on the FILE parameter of the corresponding [Open Query File \(OPNQRYF\)](#) command. However, the system assigns some of the attributes. The file is created with CONTIG(\*NO), SIZE(\*NOMAX), ALLOCATE(\*NO), AUT(\*NORMAL) and FILETYPE(\*DATA).

The name, type, length, null capability, date, or time format, separators, and decimal positions attributes of each field on the format that is specified are used. The file is created without key fields and is an arrival sequence physical file.

In some cases, the OPNQRYF command changes the format of the format that is specified on the new to-file. The new to-file format might become null-capable when the OPNQRYF command uses one of the following grouping functions:

- %STRDEV
- %VAR
- %SUM
- %AVG
- %MIN
- %MAX

**Note:** A new to-file with a changed format has a format level identifier that is different from the format level identifier that is specified on the OPNQRYF command.

### **Related concepts**

#### Selecting records using a specified record format name (RCD\_FMT parameter)

You can use the RCD\_FMT parameter to select records of a certain record format to copy. Note that you can use this parameter on the CPYF command only.

### ***Authorities, user profiles, and file capabilities of the to-file***

When the Copy File (CPYF) command creates the local physical file, the from-file gives the created to-file all the *authorities* of the from-file. These authorities include public, private, and authorization lists.

When [Copy From Query File \(CPYFRMQRYF\)](#) creates the local physical file, the authorities given are of the first file that is specified on the FILE parameter of the corresponding [Open Query File \(OPNQRYF\)](#) command. The authorities include public, private, and authorization lists.



In both cases, the owner of the created to-file is the *user profile* running the copy command. The user running the copy command inherits \*ALL authority to the object. This is true unless the user is a member of a group profile and has OWNER(\*GRPPRF) specified for the profile.

If you specify OWNER(\*GRPPRF), the group profile becomes the owner of the to-file. In this case, if the user profile running the copy command does not have authority to add a member or write data to the new file, the copy command fails.

The created to-file does not maintain the file capabilities of the from-file. The to-file allows update, delete, read, and write operations, regardless of whether the from-file allowed these operations. Following are special considerations for the new to-file:

- If the number of records copied into a member is greater than the maximum size of the created to-file, the to-file is extended without intervention by the system operator.
- If the from-file is an SQL table, view, or index, the created to-file will be a physical file that is not an SQL table. However, when the from-file contains LOBs, datalinks, or user-defined types, the created to-file is an SQL table.
- If the from-file is an SQL table, the default values are not preserved. The default data type value will apply to the created physical file.
- If the from-file has a trigger program associated with it, the CPYF and CPYFRMQRYP commands do not copy the trigger information to the to-file when the CRTFILE parameter is used.
- If you create a new file (CRTFILE(\*YES)) from a file with constraints, the constraint definitions do not copy to the new file.
- If you create a new file (CRTFILE(\*YES)) from a file with user-defined functions, the user-defined functions do not copy to the new file.

## Adding, replacing, and updating records (MBROPT parameter)

Many IBM i copy commands enable you to add or replace existing data in the to-file specifying different attributes on the MBROPT parameter.

These commands include [Copy File \(CPYF\)](#), [Copy From Query File \(CPYFRMQRYP\)](#), [Copy From Tape \(CPYFRMTAP\)](#), and [Copy Source File \(CPYSRCF\)](#). The CPYF command also allows you to update duplicate key records and add nonduplicate key records to a to-file member.

You can do these tasks by specifying \*REPLACE, specifying \*ADD, or specifying \*UPDADD on the MBROPT parameter.

### Related concepts

[Copying records into files that use trigger programs](#)

Triggers enable you to perform copy actions automatically when a specified change operation occurs.

### Specifying \*REPLACE when copying files

By specifying \*REPLACE, you essentially clear the member. The copied records are the only records in the member when the operation completes. You must have authority to clear the member in order to specify MBROPT(\*REPLACE).

For copy commands other than the [Copy From Query File \(CPYFRMQRYP\)](#) command, when you specify \*REPLACE, copy command processing fails if the from-file does not contain any records. When you specify \*REPLACE on the [CPYFRMQRYP](#) command, the to-file member will be cleared even if the open query file contains no records.

\*REPLACE is the default value for the [Copy Source File \(CPYSRCF\)](#) command. All other copy commands have the default value of \*NONE; however, \*NONE is valid only for copying to a device file.

### Specifying \*ADD when copying files

When you specify \*ADD, each record copied is added to the end of the existing records in the member.

It is important to note that this is always true, even for keyed files. However, with keyed files, the added records appear to be merged in key sequence when accessed through a keyed access path. When copying

from query files, the relative record numbers of the resulting file might not correspond to those in the original file.

When \*ADD is specified, the copy completes normally even if the from-file contains no records.

When three files are copied with MBROPT(\*ADD) to a database file that is not keyed, the resulting to-file looks like the following figure:

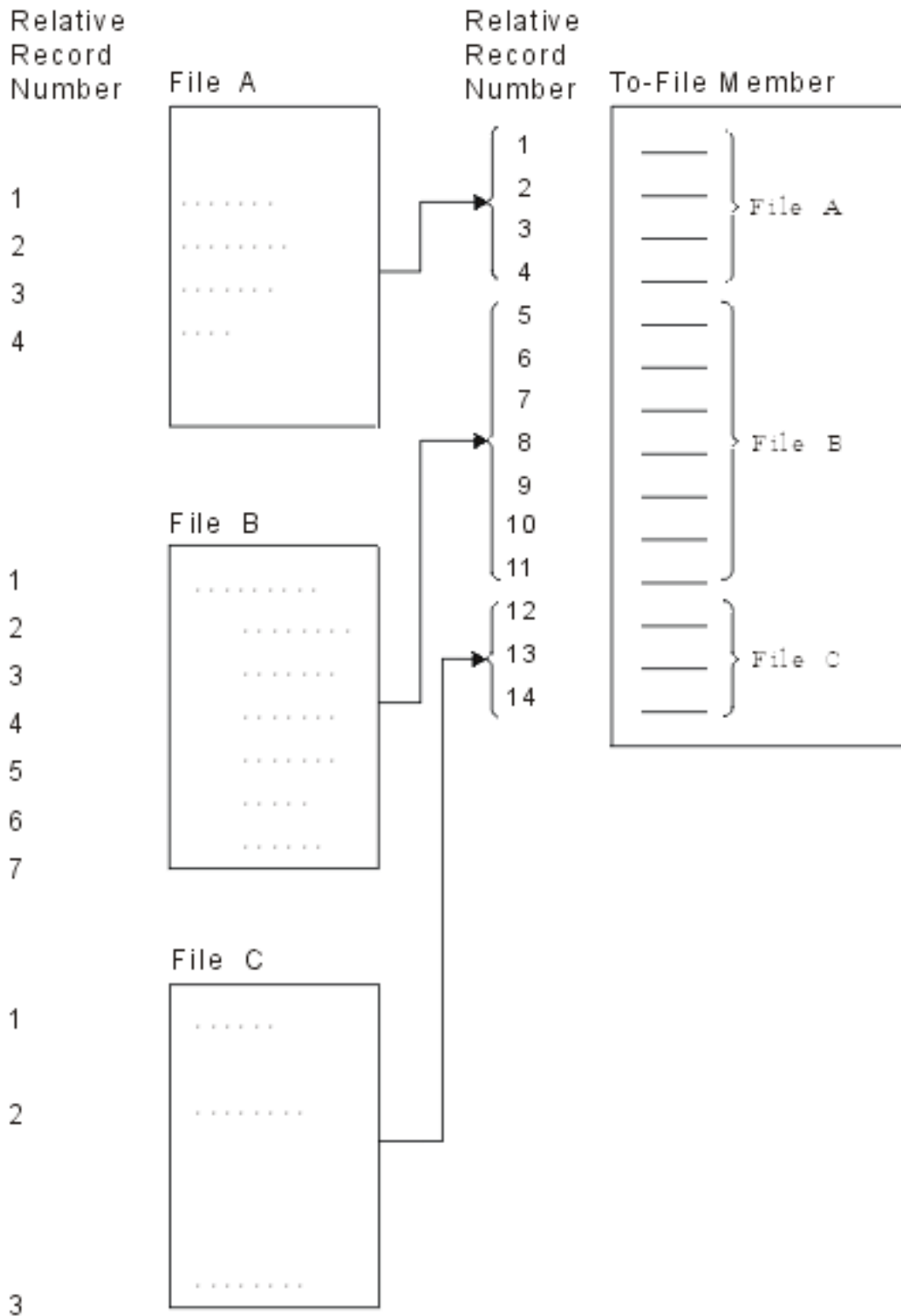

If MBROPT(\*ADD) is specified, records are always physically added at the end of the file, even if it is a keyed sequence file. In the following figure, FILEDB1 is a keyed physical from-file, and FILEDB2 is a keyed physical to-file. The files are shown as they physically appear in storage. FILEDB2 already has three records in it.

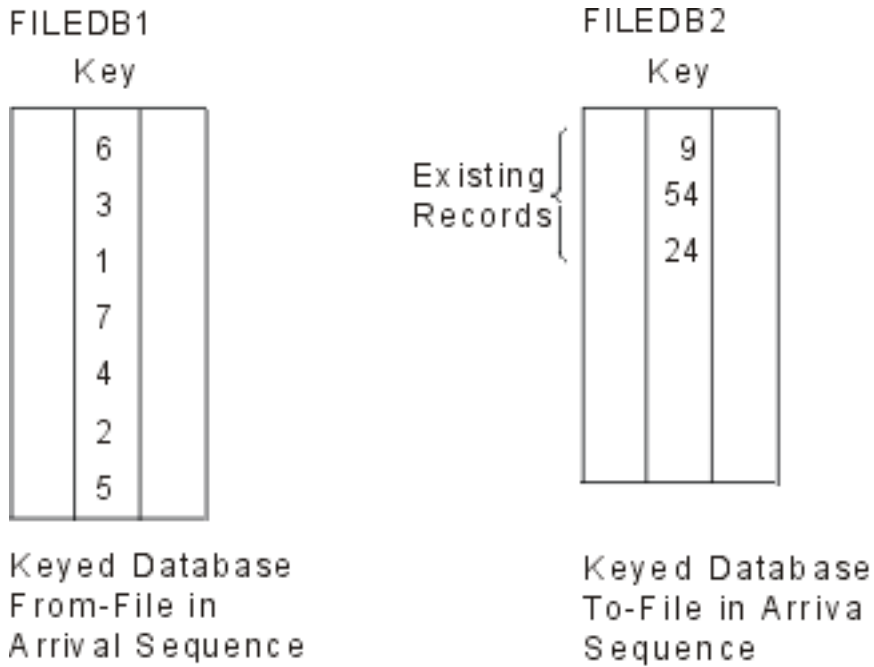

If you specify MBROPT(\*ADD), FROMKEY(1 2), and TOKEY(1 5), four records are added in key field order to the end of FILEDB2.

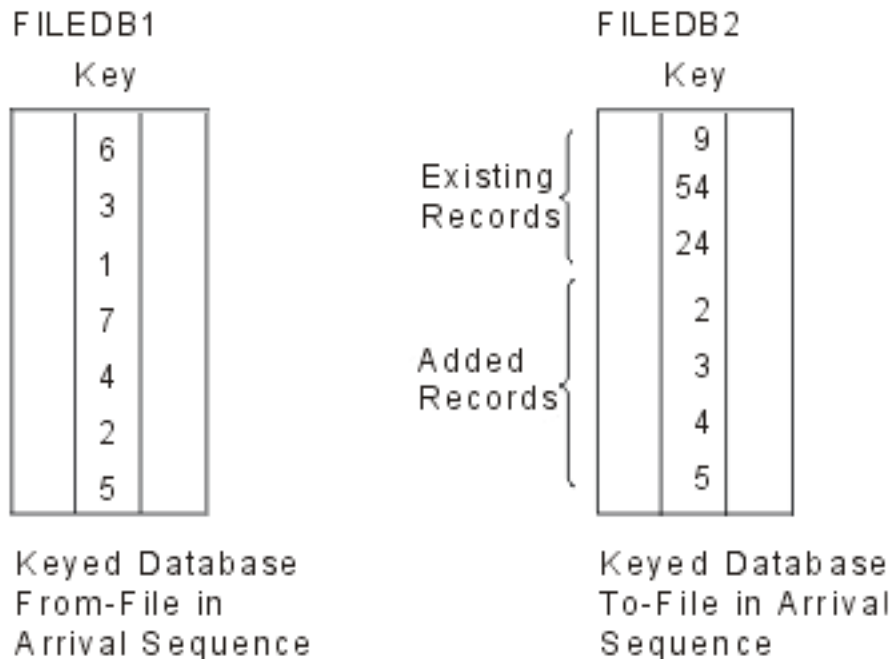

MBROPT(\*ADD)  
FROMKEY(1 2)  
TOKEY(1 5)

The added records, however, appear to be merged in the new file when viewed through a keyed sequence access path.

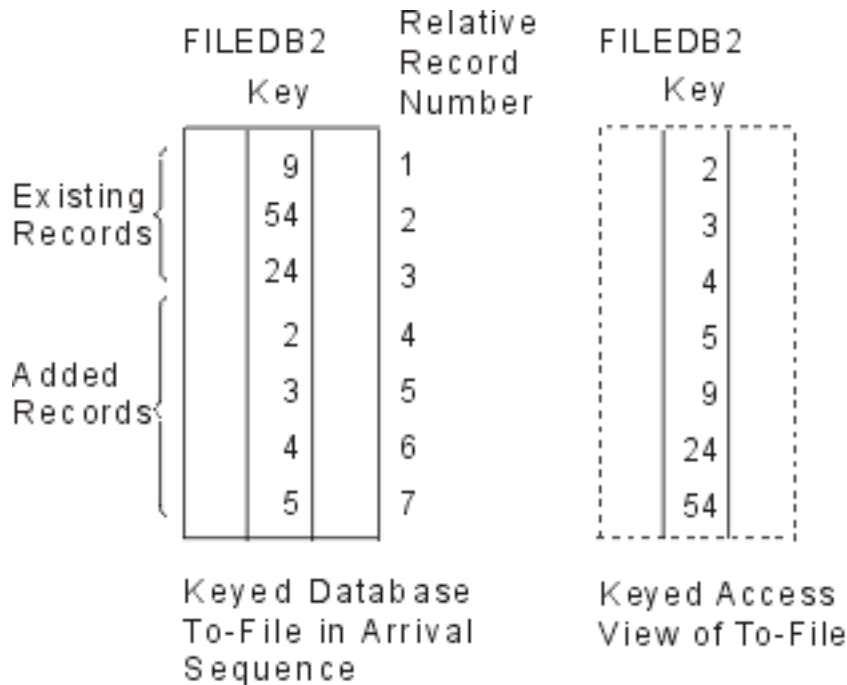

There are several ways to select records for copying. One method is selection by relative record number. Using the preceding example, if you selected records to copy to a third file from FILEDB2 by relative record number, from number 3 through 5, you would copy the records with a key value of 24, 2, and 3, not 4, 5, and 9.

### Related concepts

#### Copying deleted records (COMPRESS parameter)

You might want to copy deleted records to preserve the relative record numbers of records that are copied from the from-file. You can copy both deleted and undeleted records from one physical file member to another by specifying the COMPRESS(\*NO) parameter on a copy command.

#### Adding or changing source file sequence number and date fields (SRCOPT and SRCSEQ parameters)

You can perform additions or changes to sequence number fields and date fields sequence number and date fields when you are copying files.

#### Selecting records by relative record numbers (FROMRCD and TORCD parameters)

You can use the FROMRCD and TORCD parameters to copy files with specifying their record numbers. Note that you can use these parameters on the CPYF command only.

### **Specifying \*UPDADD when copying files**

When you specify \*UPDADD on the Copy File (CPYF) command, a from-file key value builds before the from-file record moves into the to-file. The from-file builds this key value by using the key specifications of the to-file.

Before the key value is built, the system performs any necessary field or data mapping, data conversion, or record selection. The system checks the to-file to see if this key value already exists in it (duplicate key of the from-file data). If the key value does exist in the to-file, the from-file record that contains the key value updates that to-file record.

The following rules apply if you specify MBROPT(\*UPDADD) on the CPYF command:

- The to-file must be a local database physical file that contains a primary or unique key.
- You cannot specify CRTFILE(\*YES). The to-file must exist before you run CPYF.
- CPYF cannot copy from multiple formats.

- Detected duplicate keys are not skipped but updated with the new from-file record value. Duplicate key errors (CPF5026) are not included as ERRLLV errors.
- CPF5027 will be included as an ERRLLV error. This error can occur if another process has a record that is locked. To avoid this error, you might want to pre-allocate the to-file within your job before performing the CPYF. You can use the WAITRCD parameter on the [Create Physical File \(CRTPF\)](#) and [Change Physical File \(CHGPF\)](#) commands to limit the length of time that the commands spend waiting for a record lock to be released in the to-file.
- All existing FMTOPT values are allowed. However, when using MBROPT(\*UPDADD), take care to avoid updating records that you do not want to update. Also avoid updating the same record multiple times when it is not what you want.
- Nulls are not used in determining duplicate key values if FMTOPT(\*NOCHK) is specified or if the from-file is a device file.
- You must have the minimum following authorities to the to-file:
  - Object operational (\*OBJOPR)
  - Add (\*ADD)
  - Update (\*UPD)

### ***Copying records into files that use trigger programs***

Triggers enable you to perform copy actions automatically when a specified change operation occurs.

A *trigger program* is a program that contains a set of trigger actions. A *trigger action* is a set of actions (high-level language statements, SQL statements, or IBM i utilities) that are performed automatically when a specified change operation (trigger event) occurs on a specified table or file.

If records are copied to a physical file that has an \*INSERT trigger program associated with it, the trigger program is called each time a record is copied to the file. The trigger program is not called if deleted records are copied. If an error occurs while the trigger program is running, the copy operation fails. However, records that were successfully copied before the error occurred remain in the to-file.

If a from-file has a trigger program associated with it, the [Copy File \(CPYF\)](#) and [Copy From Query File \(CPYFRMQRYP\)](#) commands do not copy the trigger information to the to-file when the CRTFILE parameter is used.

#### **Related concepts**

[Adding, replacing, and updating records \(MBROPT parameter\)](#)

Many IBM i copy commands enable you to add or replace existing data in the to-file specifying different attributes on the MBROPT parameter.

#### **Related information**

[Triggers](#)

[Database programming](#)

### **Selecting the records to copy**

You can use parameters on the copy commands to select only the specific records that you want to copy.

#### **Related concepts**

[Record sequence and copying](#)

The *access path* is the sequence in which records are organized in a database file. There are two types of access paths: *keyed sequence* and *arrival sequence*. With the copy function, you can process records in a database file in either arrival sequence or keyed sequence.

#### **Related information**

[Database Programming](#)

[Control language](#)

### **Selecting records using a specified record format name (RCDFMT parameter)**

You can use the RCDFMT parameter to select records of a certain record format to copy. Note that you can use this parameter on the CPYF command only.

When you copy from a logical file to a physical file and the logical file has more than one record format, you must specify a record format name unless you specify FMTOPT(\*NOCHK). If you use FMTOPT(\*NOCHK), then you can specify RCDFMT(\*ALL) to copy all from-file record formats to the to-file. The command uses this record format name to select records to copy.

This example shows how you can use the copy command to copy records from the logical file ORDFILL to the physical file INVOICE by using the record format ORDHDR:

```
CPYF FROMFILE(DSTPRODLB/ORDFILL) +  
     TOFILE(DSTPRODLB/INVOICE) RCDFMT(ORDHDR) +  
     MBROPT(*ADD)
```

When you copy from a logical file that has more than one record format to a device file, you can specify either a single record format to be used or specify RCDFMT(\*ALL) to copy using all the record formats. If the record formats have different lengths, the command pads the shorter records with blanks.

#### **Related concepts**

[Specifying CRTFILE\(\\*YES\) on either the Copy File or Copy From Query File command](#)

You get different results while specifying CRTFILE(\*YES) on the Copy File (CPYF) command and the Copy From Query File (CPYFRMQRYF) command.

[Selecting a specified number of records \(NBRRCD parameter\)](#)

When you specify a FROMKEY or FROMRCD parameter, you can specify the number of records (NBRRCD parameter) to be copied instead of the TOKEY or TORCD parameter.

[Copying deleted records \(COMPRESS parameter\)](#)

You might want to copy deleted records to preserve the relative record numbers of records that are copied from the from-file. You can copy both deleted and undeleted records from one physical file member to another by specifying the COMPRESS(\*NO) parameter on a copy command.

#### **Related information**

[DB2 Multisystem](#)

### **Selecting records by relative record numbers (FROMRCD and TORCD parameters)**

You can use the FROMRCD and TORCD parameters to copy files with specifying their record numbers. Note that you can use these parameters on the CPYF command only.

Relative record numbers can be specified for a copy from any file type except a keyed logical file. A keyed physical file can be copied in arrival order if relative record numbers are specified for the FROMRCD or TORCD parameter. Records can be copied:

- From a specified record number (FROMRCD parameter) to a specified record number (TORCD parameter) OR
- Until a specified number of records (NBRRCD parameter) has been copied

If the command reaches the end of the file before it reaches the specified ending record number or number of records, the copy completes normally.

When a relative record number is specified, records are copied, starting with the specified relative record number, in the order in which they physically exist in the database file being copied from. This is true even if the physical file has a keyed sequence access path. You can use the COMPRESS parameter with the FROMRCD and TORCD parameters to further define which records you want to select for copying.

If the from-file is a physical file or a logical file with an arrival sequence access path, the TORCD value is a relative record number that counts both the deleted and undeleted records ahead of it. If the from-file is a device file or inline data file, the TORCD value is a record number that includes only undeleted records (even for an I-format diskette file).

Deleted records retain their position among records that are not deleted. However these records do not necessarily retain their relative record number when they are copied if they are in the specified subset

and COMPRESS(\*NO) is specified. If you specify COMPRESS(\*YES), the command skips the deleted records and does not copy them. In this case, when the record number that is specified (FROMRCD parameter) is a deleted record, copying starts with the first undeleted record that follows.

This example shows how you can use the command to copy records from relative record number 500 to relative record number 1000 in the file EMP1 to the file EMP1T.

```
CPYF      FROMFILE(PERSONNEL/EMP1) +  
         TOFILE(TESTLIB1/EMP1T) MBROPT(*REPLACE) +  
         FROMRCD(500) TORCD(1000)
```

**Note:** If you use record numbers to select records, you cannot use record keys (FROMKEY/TOKEY parameters) to select records on the same CPYF command.

For information about using the FROMRCD and TORCD parameters with distributed files, see [DB2 Multisystem](#).

### Related concepts

[Specifying \\*ADD when copying files](#)

When you specify \*ADD, each record copied is added to the end of the existing records in the member.

### Selecting records by record keys (FROMKEY and TOKEY parameters)

You can specify record keys to copy only from a keyed database file. Note that you can use this parameter on the CPYF command only.

You can copy records:

- From a specified key value (FROMKEY parameter) to a specified key value (TOKEY parameter) OR
- Until a specified number of records (NBRRCDs parameter) is reached

If the command reaches the end of the file before it reaches the specified ending key value or number of records, the copy completes normally.

If no record in the from-file member has a key that is a match with the FROMKEY value, but there is at least one record with a key greater than the specified value, the first record copied is the first record with a key greater than the FROMKEY value. If the specified key value is greater than any record in the member, the command sends an error message and does not copy the member.

You can specify \*BLDKEY on the FROMKEY and TOKEY parameters to use a list of character and numeric values in their natural display form for the fields in a key. The command converts each element to the corresponding key field data type. The command then provides the *composite key* value (a key that is comprised of more than one field) to the database.

If you specify fewer values than the complete database key contains, the command builds a partial key and passes it to the database. If you specify more values than the database key contains, an ending error occurs. The command always applies values to the consecutive fields that are in the extreme left of the key so that it is impossible to skip key fields.

The command pads character fields on the right with blanks. The command adjusts numeric fields to the implied decimal point in the key field with the correct zero padding.

All regular rules for specifying numeric fields in an external character format apply. The command does not allow a floating-point value of \*NAN (Not a Number).

It is also important to understand key string comparisons made by the copy operation in order to interpret various warning messages.

**Note:** If you use record keys to select records, you cannot use relative record numbers (FROMRCD/TORCD parameters) to select records on the same CPYF command.

You should not specify COMPRESS(\*NO) when selecting records by record key from a keyed physical file. Because the keyed access path of a file does not contain deleted records, the copy command never copies them, so the compression is automatic.

Because deleted records are canceled in a copy by this method, it is also possible that the relative record numbers have changed in the new file, even if you have specified MBROPT(\*REPLACE).

The user has to input operand equal to the length of the fix field when specifying \*BLDKEY on the FROMKEY and TOKEY parameters for fix length binary character keyfields.

### Related concepts

Selecting a specified number of records (NBRRCD parameter)

When you specify a FROMKEY or FROMRCD parameter, you can specify the number of records (NBRRCD parameter) to be copied instead of the TOKEY or TORCD parameter.

#### *Key string comparisons made by the copy operation*

When the TOKEY value is specified, the check made by the copy operation is a logical character comparison between the key string for each record retrieved. The key strings can be specified explicitly using the first TOKEY parameter format or built implicitly by the copy operation that uses the list of values that are given.

A warning message is sent (but the copy operation continues) if this comparison gives different results than the ordering in which the database identifies the records in the keyed access path. The order might be different if:

- The key contains mixed ascending and descending fields
- The key contains fields for which a sort sequence other than \*HEX is in effect OR
- The key contains any of the following DDS keywords:

#### **ABSVAL**

Absolute value

#### **ALTSEQ**

Alternative collating sequence

#### **ALWNULL**

Allow null

#### **DATFMT**

Date format (\*MDY, \*DMY, \*YMD, \*JUL, SAA \*EUR, or SAA \*USA)

#### **DIGIT**

Digit force

#### **SIGNED**

Signed numeric

#### **TIMFMT**

Time format (\*USA)

#### **ZONE**

Zone force

If there are both ascending and descending fields in the file key, the first (the far left) key field determines whether the copy operation uses an ascending or descending key test to look for the last record to copy.

Using \*BLDKEY is the easiest way to specify (and ensure correct padding) values for packed, binary, and floating-point fields.

#### *Example: build-key function*

The example in this topic shows the usages of various parameters of the build-key function.

Key field number	Type	Length	Decimal precision	Value
1	CHAR	6		KEN
2	ZONED	6	2	54.25
3	BINARY	4	1	10.1

You can specify the FROMKEY (or TOKEY) parameter as follows:



```
FROMKEY( 2 x'D2C5D54040F0F0F5F4F2F50065')
```

Or, you can use the \*BLDKEY value and specify the FROMKEY as follows:

```
FROMKEY(*BLDKEY (KEN 54.25 10.1))
```

Another example using key fields 1 and 2 is:

```
FROMKEY(2 'KEN 005425')
```

Or, you can specify the \*BLDKEY value:

```
FROMKEY(*BLDKEY (KEN 54.25))
```

#### *Example: using FROMKEY and TOKEY*

In this example, the copy command copies records in the file EMP1 to the file EMP1T. EMP1T is a file in a test library. Because you only need a subset of the records, you specify a from-key value and a to-key value. Both are full key values.

Note that a 1 specified in the FROMKEY and TOKEY parameters indicates the number of key fields to be used in searching the record keys, starting with the first key field.

```
CPYF FROMFILE(PERSONNEL/EMP1) +  
TOFILE(TESTLIB1/EMP1T) MBROPT(*REPLACE) +  
FROMKEY(1 438872) TOKEY(1 810199)
```

All positions in a key value should be specified. If the value is shorter than the key field length, it will be padded on the right with zeros. Thus, a 5-position key field specified as FROMKEY(1 8) causes a search for a key equal to hex F800000000. If the key value contains blanks or special characters, you must enclose them in apostrophes.

#### *Variable-length fields used by record keys (FROMKEY and TOKEY)*

When the number of key fields and a value are used to specify the FROMKEY or TOKEY parameter, the string should include the 2-byte length field for each variable-length key field.

You must pad the variable-length key field with blanks so that keys following the variable-length key field are in the correct position. You can specify the data in hexadecimal format.

When you specify \*BLDKEY on the FROMKEY or TOKEY parameter for variable-length key fields, specify the character string without the 2-byte length field. Only the amount of data that is entered for the key value is used for key comparisons. You can specify a zero-length string for variable-length key fields.

#### *Date, time, and timestamp fields used by record keys (FROMKEY and TOKEY)*

When the number of key fields and a value are used to specify the FROMKEY or TOKEY parameter, no conversion of data occurs if the corresponding key field in the from-file is a date, time, or timestamp field.

The user input string that you specify (including the separators) must be in the same format as the date, time, or timestamp field. If it is not, a file open error might occur, or the records copied might not be the result that you want.

If \*BLDKEY is specified for the FROMKEY or TOKEY parameter and the corresponding key field in the from-file is a date, time, or timestamp field, the system attempts to convert the user-input key field value to the format (and separators) of the from-file field. The following rules apply to the conversion:

- **If the from-field is a date key field**, the system first determines if the user-input key value is in the same format and has the same separator as specified in the current job under which the copy command is running. This can be \*MDY, \*DMY, \*YMD, or \*JUL for the format and slash (/), hyphen (-), period (.), comma (,), or blank ( ) for the separator. If the user-input key value is not in the current job specified format and separator form, it determines if it is in one of the Systems Application Architecture® (SAA) formats (\*ISO, \*USA, \*EUR, or \*JIS). It also determines if it is in a YYYYDDD form (no separator). If the system can determine the user-input key value is in one of these forms, the input string is converted to the actual format (and separator) of the from-file date field, which is used for the key comparison. If the

user-input string format cannot be determined or the length or data value is not valid, the system issues a diagnostic message. You must left-justify the date portion of the user-input key value; it can contain trailing blanks.

- **If the from-field is a time key field**, the system first determines if the user-input key value is in the same format and has the same separator as specified in the current job under which the copy command is running. This might be HHMMSS for the format and colon (:), comma (,), period (.), or blank ( ) for the separator. If the user-input key value is not in the current job specified format and separator form, the system determines if it is in one of the SAA formats (\*ISO, \*USA, \*EUR, or \*JIS). If the system can determine the user-input key value is in one of these forms, the input string is converted to the actual format (and separator) of the from-file time field, which is used for the key comparison. If the user-input string format cannot be determined, or the length or data value is not valid, the system issues a diagnostic message. You must left-justify the time portion of the user-input key value; it can contain trailing blanks.
- **If the from-field is a timestamp key field**, the system first determines if the user-input key value is in the SAA format or YYYYMMDDHHMMSS form. If the system determines the user-input key value is in one of these forms, the input string is converted to the actual SAA timestamp format, which is used for the key comparison. If the user-input string format cannot be determined, or the length or data value is not valid, the system issues a diagnostic message. You must left-justify the timestamp portion of the user-input key value; it can contain trailing blanks.

#### *Null-capable fields used by record keys (FROMKEY and TOKEY)*

When you use the number of key fields and a value to specify the FROMKEY or TOKEY parameter, the copy command ignores the null values. The command uses only the buffer default values for values that are actually null for the comparison.

When you specify \*BLDKEY on the FROMKEY or TOKEY parameter, none of the \*BLDKEY values can refer to a null-capable field. If they do, the system sends an error message.

#### *Different CCSIDs used by record keys (FROMKEY and TOKEY)*

When you use the number of key fields and a value to specify the FROMKEY or TOKEY parameter, the copy command does not make any CCSID conversions to the input string.

When \*BLDKEY is specified on the FROMKEY or TOKEY for character, DBCS-open, DBCS-either, or DBCS-only fields, the value specified is assumed to be in the CCSID of the process in which the copy command is running. The copy command converts each of these key values from the job CCSID to the CCSID of the from-file key field. If no conversion table is defined or an error occurs while converting the input key value, a message is sent and the copy operation ends. If the value can be correctly converted, the converted value is used to build the key value that determines the first and last record to be copied.

#### *DBCS-graphic fields used by record keys (FROMKEY and TOKEY)*

When the number of key fields and a value are used to specify the FROMKEY or TOKEY parameter, no conversions are done on the input string. The input string is used as is.

When you specify \*BLDKEY on the FROMKEY or TOKEY for DBCS-graphic fields, you should enclose the DBCS data in shift-out and shift-in characters. The copy command assumes that the DBCS data is in the associated DBCS CCSID of the job CCSID. The shift-out and shift-in characters are removed before building the key. A message is sent and the copy operation ends:

- If the input string is not enclosed in shift-out and shift-in (SO-SI) characters OR
- The data cannot be converted to the DBCS CCSID of the from-file key field

#### **Selecting a specified number of records (NBRRCDs parameter)**

When you specify a FROMKEY or FROMRCD parameter, you can specify the number of records (NBRRCDs parameter) to be copied instead of the TOKEY or TORCD parameter.

You cannot specify both the NBRRCDs and the TORCD or TOKEY parameters. The specified number of records is copied starting with the specified from-key value or from-record number.

**Note:** You can use this parameter on the following commands: CPYF, CPYFRMDKT, CPYFRMQRYF, CPYFRMTAP, CPYTODKT, and CPYTOTAP.

You can specify the NBRRCD parameter without specifying the FROMKEY or FROMRCD parameter. The copy command copies records by starting with the first record in the file.

**Note:** The number of records specified is the number of records actually copied to the to-file, which include deleted records in the from-file if COMPRESS(\*NO) is specified, but does not include records excluded by the INCCHAR and INCREL parameters.

This example shows how you can use the copy command to copy 1000 records in the file EMP1 to the file EMP1T. The command copies records from the first member in EMP1 and replace the records in the first member in EMP1T.

```
CPYF FROMFILE(PERSONNEL/EMP1) +
     TOFILE(TESTLIB1/EMP1T) MBROPT(*REPLACE) +
     NBRRCD(1000)
```

You can also use the NBRRCD parameter to examine a subset of records on a list:

```
CPYF FROMFILE(PERSONNEL/EMP1) TOFILE(*PRINT) +
     FROMRCD(250) NBRRCD(10) OUTFMT(*HEX)
```

When you successfully copy an open query file, the file position is unpredictable. If you want to run a different program with the same files or run another CPYFRMQRYP, you must position the file or close the file and open it with the same OPNQRYF command. You can position the file with the Position Database File (POSDBF) command. In some cases, you can use a high-level language program statement.

### Related concepts

[Selecting records using a specified record format name \(RCDFMT parameter\)](#)

You can use the RCDFMT parameter to select records of a certain record format to copy. Note that you can use this parameter on the CPYF command only.

[Selecting records by record keys \(FROMKEY and TOKEY parameters\)](#)

You can specify record keys to copy only from a keyed database file. Note that you can use this parameter on the CPYF command only.

### **Selecting records based on character content (INCCHAR parameter)**

You can select records on the basis of the content of characters that start in a specific position in the record or field.

**Note:** You can use this parameter on the CPYF command only.

You can use the INCCHAR parameter with the FROMKEY or FROMRCD parameter. You can select records first by their key value or relative record number, and then by characters in some position in the record or field.

You can test for any character string of 1 through 256 bytes. If the character string contains any special characters or blanks, you must enclose the entire string in apostrophes.

You can also specify \*CT (contains) as the operator for the INCCHAR parameter. This specifies that the copy command should scan each record in the from-file for the selection character string. You can specify any valid starting position in the field or record for the start of the scan. The data will then be scanned from that position to the byte to the extreme right of the field or record.

If you specify both the INCCHAR and INCREL parameters, the copy command copies a record only if it satisfies both the INCCHAR and INCREL conditions.

This example shows how you can test for all records in the file DBIN that have an XXX starting in position 80. It then shows how you can copy these records to the file DKTOUT. Because this example includes testing for positions relative to the length of the whole record, you must specify \*RCD on the INCCHAR parameter.

```
CPYF FROMFILE(DBIN) TOFILE(DKTOUT) +
     INCCHAR(*RCD 80 *EQ XXX)
```

If you were testing for an XXX in a position in a particular field in the record, you would specify the field name instead of \*RCD, and the starting position of the character relative to the start of the field.

```
CPYF FROMFILE(DBIN) TOFILE(DKTOUT) +  
  INCCHAR(FLDA 6 *EQ XXX)
```

A field name cannot be specified if RCDFMT(\*ALL) is specified when copying from a multiple-format logical file, or if the from-file is a device file or inline data file.

For binary character fields, the INCCHAR parameter will use the binary character comparison rules. Comparisons will be performed by CPYF and no padding or truncation will be performed.

#### *Variable-length fields used by the INCCHAR parameter*

When you specify \*RCD for the INCCHAR parameter, the starting position represents the position in the buffer. The 2-byte length field of variable-length fields must be considered when determining the position.

Use single-byte blanks (X'40') to pad variable-length fields if the INCCHAR value spans multiple fields.

You can specify variable-length fields for the INCCHAR string when you specify a field name. The starting position represents the position in the data portion of the variable-length from-field value. The number of bytes that are compared is the number of bytes in the value that is specified for the INCCHAR string. If the actual data in the variable-length from-field is shorter than the value specified for the INCCHAR parameter, the from-field data is padded with single-byte blanks (X'40') for the comparison.

You cannot specify a zero-length string for the INCCHAR value.

#### *Null-capable fields used by the INCCHAR parameter*

The INCCHAR parameter allows null-capable character-field and null-capable DBCS-field names to be specified. However, any logical comparison with a null-field value tests as false, and the record is not copied.

The copy command performs no special processing if you specify the \*RCD special value as the field name. The command only compares buffer default values for actual null values.

#### *Different CCSIDs used by the INCCHAR parameter*

When you specify \*RCD for the INCCHAR parameter, the copy command does not perform any conversions on the input string. The command compares the byte string that you entered at the specified position in the record buffer of the from-file.

When you specify a field name, the command assumes that the input string is in the CCSID of the job in which the copy command runs. The input string is converted to the CCSID of the from-field. If no conversion table is defined or if an error occurs while converting the input string, a message is sent and the copy operation ends. If the command can correctly convert the value, the command uses the converted value for record selection.

#### *DBCS-graphic fields used by the INCCHAR parameter*

When you specify a graphic field for the INCCHAR parameter, you should enclose the DBCS data in shift-out and shift-in characters. The command assumes that the data is in the associated DBCS CCSID of the job CCSID.

There must be a valid conversion to the field CCSID; otherwise, an error occurs. The shift-out and shift-in characters are removed before doing the comparison. The position specifies the DBCS character position in which to begin the comparison.

### **Selecting records based on field value (INCREL parameter)**

You use the INCREL parameter to select records for copying by testing for the value of an entire field. Unlike the INCCHAR parameter, you can use the INCREL parameter only when you are copying from a database file, and you can test for different values in different fields on one copy command.

**Note:** You can use this parameter on the CPYF command only.

You can use as many as 50 AND and OR relationships on one INCREL parameter. The OR relationship groups the AND relationships. For example, the following INCREL parameter essentially says this: If field FLDA is greater than 5 and field FLDB is less than 6, select the record. If FLDB is equal to 9 (FLDA is any value), select the record.

```
INCREL(((*IF FLDA *GT 5) (*AND FLDB *LT 6) +
(*OR FLDB *EQ 9))
```

The value you specify must be compatible with the field type. You must enclose each INCREL relational set in parentheses.

The value \*IF must be specified as the first value in the first set of comparison values, if there is only one set or several sets of comparison values. If more than one set of comparison values are specified, either \*AND or \*OR must be specified as the first value in each set after the first set of values.

In the following discussion, an IF group refers to an IF set, optionally followed by one or more AND sets. An OR group refers to an OR set, optionally followed by one or more AND sets. All the comparisons specified in each group are done until a complete group, which is a single IF set or OR set having no AND sets following it, yields all true results. If at least one group has a true result, the copy command includes the record in the copied file.

The first set of comparison values (\*IF field-name operator value) and any AND sets logically connected with the IF set are evaluated first. If the results in all of the sets in the IF group are true, the testing ends and the record is copied. If any of the results in the IF group are false and an OR group follows, another comparison begins. The command evaluates the OR set and any AND sets that follow it (up to the next OR set). If the results in the OR group are all true, the record is included. If any result is false and another OR group follows, the process continues until either an OR group is all true or until there are no more OR groups. If the results are not all true for any of the IF or OR groups, the record is excluded (not copied to the to-file).

If you specify both the INCCHAR and INCREL parameters, the copy command copies a record only if it satisfies both the INCCHAR and INCREL conditions.

You cannot specify the INCREL parameter if you specify RCD\_FMT(\*ALL) when copying from a multiple-format logical file.

For binary character fields, the INCREL parameter will only allow checks for \*EQ and \*NE.

#### *Variable-length fields used by the INCREL parameter*

You can use variable-length character fields for the INCREL parameter. Enter the character value without the 2-byte length field. The length of the data that is entered determines the number of bytes that are used for the comparison.

If the actual data in the variable-length from-field is shorter than the value specified for the INCREL parameter, the from-field data is padded with single-byte blanks (X'40') for the comparison.

#### *Date, time, and timestamp fields used by the INCREL parameter*

The INCREL parameter allows date, time, and timestamp fields. The copy command compares the input field value chronologically to the value in the date, time, or timestamp field to determine if it should select the record.

The system attempts to convert the input string and the actual field value to an internal form that is chronologically compared. These rules apply to the conversion:

- **If the from-field is a date field**, the system determines if the user-input field value is in the same format and has the same separator as specified in the current job under which the copy command is running. The format can be \*MDY, \*DMY, \*YMD, or \*JUL and can use a slash (/), hyphen (-), period (.), comma (,), or blank ( ) for the separator. If the user-input field value does not use the same format or separator form of the current job, the system determines if it is one of the SAA formats (\*ISO, \*USA, \*EUR, OR \*JIS) or if it is a YYYYDDD form with no separators. If the system determines that the user-input field value is one of these forms, it converts the input string to an internal form. The from-field is then converted to its internal form, and the comparison is made. If the user-input string format cannot be determined, or the length or data value is not valid, a diagnostic message is issued and the copy operation ends. You must left-justify the date portion of the user-input field value; it can contain trailing blanks.
- **If the from-field is a time field**, the system determines if the user-input field value is in the same format and has the same separator as specified in the current job under which the copy command is

running. The format can be HHMMSS and have a colon (:), comma (,), period (.), or blank ( ) for the separator. If the user-input field value is not in the specified format and separator form of the current job, the system determines if it is in one of the SAA formats (\*ISO, \*USA, \*EUR, or \*JIS). If the system determines that the user-input key value is in one of these forms, it converts the input string to an internal form. The from-field is then converted to its internal form, and the chronological comparison is made. If the user-input string format cannot be determined or the length or data value is not valid, a diagnostic message is issued and the copy operation ends. You must left-justify the time portion of the user-input field value; it can contain trailing blanks.

- **If the from-field is a timestamp field**, the system first determines if the user-input field value is in the SAA format or YYYYMMDDHHMMSS form (no separators). If the system determines that the user-input field value is in one of these forms, it converts the input string to an internal form. The from-field is then converted to its internal form and the chronological comparison is made. If the user input string format cannot be determined, or the length or data value is not valid, a diagnostic message is issued and the copy operation ends. You must left-justify the timestamp portion of the user-input field value; it can contain trailing blanks.

#### *Null-capable fields used by the INCREL parameter*

The INCREL parameter allows a value of \*NULL as input for a field value. You can use the \*EQ and \*NE operators with the \*NULL value to test whether a field in a database file contains the null value or not.

\*EQ means that the value is null, and \*NE means that the value is not null when you specify the \*NULL value. The \*NULL value is not limited to null-capable fields.

#### *Different CCSIDs used by the INCREL parameter*

The copy command assumes that the input string for character, DBCS-open, DBCS-either, or DBCS-only fields are in the CCSID of the job in which the copy command is running. The input string is converted to the CCSID of the from-field.

If no conversion table is defined or an error occurs while converting the input string, a message is sent and the copy operation ends. If the copy command can correctly convert the value, it uses the converted value for record selection.

#### *DBCS-graphic fields used by the INCREL parameter*

When you specify a graphic field for the INCREL parameter, you should enclose the DBCS data in shift-out and shift-in characters. The copy command assumes that the data is in the associated DBCS CCSID of the job CCSID.

There must be a valid conversion to the field CCSID. Otherwise, an error occurs. The shift-out and shift-in characters are removed before doing the comparison.

### **Copying deleted records (COMPRESS parameter)**

You might want to copy deleted records to preserve the relative record numbers of records that are copied from the from-file. You can copy both deleted and undeleted records from one physical file member to another by specifying the COMPRESS(\*NO) parameter on a copy command.

If you do not use COMPRESS(\*NO), only records that have not been deleted are copied from the from-file.

**Note:** You can use this parameter on the CPYF command only.

#### **Related concepts**

##### Specifying \*ADD when copying files

When you specify \*ADD, each record copied is added to the end of the existing records in the member.

##### Selecting records using a specified record format name (RCDFMT parameter)

You can use the RCDFMT parameter to select records of a certain record format to copy. Note that you can use this parameter on the CPYF command only.

##### *Requirements of COMPRESS(\*NO) parameter and the Copy File command*

To use COMPRESS(\*NO), the conditions discussed in this topic must be true.

- The from-file and to-file must both be physical files.

- The from-file and to-file must both be the same type (either source or data).
- The from-file and to-file must either have identical record formats or you must specify FMTOPT(\*NOCHK) to perform the copy.
- You must use all the following (default) parameter values on the copy command:
  - PRINT(\*NONE)
  - INCCHAR(\*NONE)
  - INCREL(\*NONE)
  - SRCOPT(\*SAME)
  - ERRVLV(0)

*Restrictions of the COMPRESS(\*NO) parameter and the Copy File command*

You cannot specify COMPRESS(\*NO) for the cases discussed in this topic.

You cannot specify COMPRESS(\*NO) for the following types of access paths over the to-file, including when the access path is contained in a logical file and is based on the to-file member:

- Unique keys (you specified the UNIQUE keyword in the DDS).
- Select or omit specifications without the DYNSLT keyword (in the DDS for the file), and immediate or delayed maintenance (MAINT(\*IMMED) or MAINT(\*DLY) specified on the CRTPF or CRTLF command).
- Floating-point key field or logical numeric key field (in the DDS for the file), and immediate or delayed maintenance (MAINT(\*IMMED) or MAINT(\*DLY) specified on the CRTPF or CRTLF command). Note that a logical numeric key field is one of the following fields:
  - A numeric key field in a logical file
  - A field specified as a *to* field on the JFLD keyword that has different attributes than in the based-on physical file
  - A field specified as a sequencing field on the JDUPSEQ keyword that has different attributes than in the based-on physical file

You cannot specify COMPRESS(\*NO) for any of the following cases:

- If you use the JRNPF command to journal the to-file
- If the to-file member is in use or if any access path over the to-file member is in use
- If you specify an EOFDLY wait time for the from-file on an OVRDBF command

*Details of the COMPRESS(\*NO) parameter and the Copy File command*

The COMPRESS(\*NO) parameter allows the system to copy more quickly because records are transferred in blocks, but this is *not always* true. Typically, the COMPRESS(\*NO) function does not significantly affect performance.

Before you specify the COMPRESS(\*NO) parameter, be aware that when you use the COMPRESS(\*NO) parameter, the system takes the following actions:

- Before the records are copied, the system invalidates any keyed access paths that use the to-file member.
- After the copy operation is complete, the system rebuilds the access paths.

The run time and resource that are required to rebuild the keyed access paths might outweigh the performance benefit that is gained by copying deleted records.

If you do not specify the COMPRESS(\*NO) parameter, the system might still use the internal functions to perform the copy, but the choice of how the copy is performed is based on the number of records in the from-file and to-file members before the copy, and the number of keyed access paths over the to-file member.

If you specify the MBROPT(\*REPLACE) parameter, all keyed access paths over the to-file member must be invalidated and rebuilt, so specifying COMPRESS(\*NO) does not cause any additional overhead for rebuilding access paths.

If the from-file is a keyed physical file and neither a FROMRCD nor TORCD relative record number value is specified on the copy commands to force the file to be processed in arrival sequence, COMPRESS(\*NO) has no meaning because a keyed access path never contains any deleted records.

## Printing records (PRINT, UTFMT, and TOFILE(\*PRINT) parameters)

By specifying PRINT special values on a copy command, you can print a list of all records copied, all records excluded, or all records causing ERRLVL output errors.

**Note:** You can use the parameters described in this topic on the [CPYF](#), [CPYFRMQRYF](#), and [CPYFRMTAP](#) commands.

You can specify one or more of these listings on a single copy command, using character or hexadecimal format. You can also print an unformatted listing of records.

### Printing a list of all records copied

To print a list of all of the records that you copied, specify TOFILE(\*PRINT) on the copy command. The records are printed using the IBM-supplied printer file QSYSPT.

### Printing a list of excluded records

To print a listing of only the records that you excluded from the copy, specify \*EXCLD on the PRINT parameter. When you specify PRINT(\*EXCLD), the records print in the from-file format.

### Printing a list of copied records

To print a listing of only the records that you copied, specify \*COPIED on the PRINT parameter. When you specify PRINT(\*COPIED) and MBROPT(\*UPDADD), the records copied and the records updated appear on the same listing. A message follows each updated record that states that it was an update.

### Printing a list of records that cause errors

To print a listing of the records that caused ERRLVL output errors, specify \*ERROR on the PRINT parameter. (The ERRLVL parameter still controls the number of recoverable errors that can occur.) Only the number of records up to one (1) greater than the ERRLVL value that is specified are printed in the \*ERROR listing. The listing is similar to the PRINT(\*COPIED) and PRINT(\*EXCLD) listings.

## Selecting the format of the listing

To specify whether your listing prints in character or hexadecimal format, use the UTFMT parameter. The default value is \*CHAR, and records print in character format. If you specify \*HEX, records print in both character and hexadecimal format.

If you specify TOFILE(\*PRINT), the UTFMT parameter again specifies the format that is used to print the records.

When you specify PRINT(\*EXCLD), the records print in the from-file format. All character data is in the CCSID specified in the from-file field. For TOFILE(\*PRINT) and PRINT(\*COPIED) listings, and when the to-file is a print file, character data is in the CCSID specified in the to-file fields.

## Example

In this example, all records that are not copied (or excluded records) are printed:

```
CPYF FROMFILE(DKTIN) TOFILE(LIB1/PF) +
    MBROPT(*ADD) INCCHAR(*RCD 80 *EQ X) +
    PRINT(*EXCLD)
```

The records print in character format.

### Related concepts

[Preventing errors when copying files](#)



You can prevent many copy errors when you plan for certain conditions and situations ahead of time.

### ***Creating an unformatted print listing***

If you want an unformatted print listing or if the from-file records should be formatted using first-character forms control (CTLCHAR(\*FCFC), you must specify a program-described printer device file name. This file name can be QSYSPRT or user-defined (instead of \*PRINT).

To format the from-file records using first-character forms control, specify CTLCHAR(\*FCFC) on the Create Printer File (CRTPRTF), Change Printer File (CHGPRTF), or Override Printer File (OVRPRTF) command.

For copy commands where TOFILE(\*PRINT) is specified with a PRINT parameter value of \*COPIED, \*EXCLD, or \*ERROR (or any combination), the following limits apply:

- The QSYSPRT file must be spooled [SPOOL(\*YES)]
- You must specify the QSYSPRT in the device file or on the OVRPRTF command, because separate print files open for each file requested.

All records are copied to a single spooled file, and the data for each member or label identifier copied begins on a new print page.

### **Selecting members to copy**

The system gives you several options for copying file members.

#### ***Copying file members: Overview***

You can copy multiple database members or diskette labels to corresponding like-named to-file members or labels. They can also be copied and concatenated, one after another, into a single to-file member or label.

If the to-file is a spooled file, then the copy command copies each member or label to a separate spooled file. If TOFILE(\*PRINT) is specified, then all the members/labels are copied to a single spooled file, with the records for each member/label starting on a new page.

A single member or label, or multiple members or labels, can be copied to corresponding like-named to-file members or labels by specifying TOMBR(\*FROMMBR), TOLABEL(\*FROMMBR), or TOMBR(\*FROMLABEL) depending on the copy command used. If the to-file is tape, you cannot specify this unless you are copying from a single from-file member or label. \*FROMMBR is the default value for the TOMBR parameter on the CPYSRCF command, which copies the from-file members to like-named to-file members.

#### ***Allowed copy operations and parameters***

You can select certain members to copy under certain conditions with certain parameters.

This table shows the file types into which you can copy members or labels based on the source file type:

<i>Table 4. File types into which you can copy members or labels based on the source file type</i>	
<b>Diskette to:</b>	<b>Database to:</b>
Database (physical file)	Database (physical file)
Diskette (Note 1)	Diskette
Tape (Note 2)	Tape (Note 2)
Printer	Printer
*PRINT	*PRINT
<b>Notes:</b>	
1. The to-file must be spooled for diskette-to-diskette copy operations.	
2. Multiple from-file members or labels can only be copied to a single tape file label.	

This table shows the valid member or label parameters for copy commands:

<i>Table 5. Valid member or label parameters for copy commands</i>				
	<b>FROMMBR<sup>1</sup></b>	<b>FROMLABEL</b>	<b>TOMBR</b>	<b>TOLABEL</b>
CPYF	X		X	
CPYFRMDKT		X	X	
CPYFRMQRYF			X	
CPYFRMTAP		X	X	
CPYSRCF	X		X	
CPYTODKT	X			X
CPYTOTAP	X			
CPYFRMIMPF	X		X	
CPYTOIMPF	X		X	
<b>Notes:</b>				
<b>1</b>				
FROMMBR is not a parameter on the CPYFRMQRYF command because the members to be queried are specified on the OPNQRYF command.				

### ***Copying all members within a file***

For database files, copy all members by specifying \*ALL on the the FROMMBR or FROMLABEL parameter.

### ***Copying only certain members within a file***

For database files, you first specify a generic name on the FROMMBR or FROMLABEL parameter. You then modify the generic name to indicate the starting character string that each member or label has in common, and then follow it with an \* (asterisk).

For example, if you specified FROMMBR(ORD\*), the copy command would copy all database members that start with ORD.

**Note:** If you copy a generic set from a diskette, and a label *that is being copied* continues on another diskette volume, then the copy command copies all the affected labels on the continuation volume. This is also true when you copy all labels.

### ***Specifying the member name for the copy operation***

You can specify various member names for the copy operation using the FROMMER and TOMER parameters.

If you specify TOMBR (\*FIRST), the copy operation does not specify a label identifier. Therefore, you must specify a label identifier (LABEL parameter) on an OVRTAPF command. If you specify the special value \*FIRST, or \*TAPF on the copy command, then the copy command uses the label from the device file description.

If the from-file is tape, the copy command uses the from-file label as the label for a tape to-file. If the to-file is a database file, the command uses the nonblank characters to the extreme right of the from-file label for the member name of the to-file. The command uses up to a maximum of either 10 characters or to the period at the extreme right in the from-file label. The copy operation uses only valid member names for a database to-file.

If the from-file is a tape file that is not labeled, then a to-file member or label name is created that corresponds to the data file on the tape from-file in the form of CPYnnnnn, where nnnnn is the tape sequence number of the data file.

If you specify a tape in the FROMMBR or TOMBR parameter, it can have a maximum length of 10 characters. If the label contains special characters or more than 10 characters, you must specify the label on one of the following commands:

- Create Tape File (CRTTAPF)
- Change Tape File (CHGTAPF)
- Override with Tape File (OVRTAPF)

### ***Special considerations for the Override Database File and Override Tape File commands***

You need to pay attention to the results of specifying certain parameters on the OVRDBF and OVRTAPF commands.

For a database from-file or to-file, if an MBR parameter is specified on an OVRDBF (Override Database File) command, then the override member name is used instead of the value specified on the copy command. If the TOFILE parameter is specified with no MBR parameter value on the OVRDBF command, then the first member (in creation order) in the database file is used instead of the member specified on the copy command. For a tape from-file or to-file, if a LABEL parameter is specified on the OVRTAPF command for the to-file, the override label name is used instead of the label specified on the copy command.

If you copy multiple members or labels to corresponding like-named to-file members or labels, then you cannot use an override to a single to-file member or label unless you also override the from-file to a single member or label.

### ***How the copy function adds members to the to-file***

The copy function adds a member to the to-file when the member does not exist. The member name used is either the TOMBR parameter value from the copy command, or the member name that is specified in an override for the to-file.

If TOMBR(\*FROMMBR) or TOMBR(\*FROMLABEL) is specified on the copy command (and is not overridden), the from-file member names or label identifiers are used for the members added to the file.

If TOMBR(\*FIRST) is specified on the copy command, or if there is an override that specifies a TOFILE parameter with no MBR parameter, then no member name is known. The copy function does not add a member in this case unless the following conditions are true:

- You specified CRTFILE(\*YES) on the copy command
- The copy function must create the to-file

Except for the CPYFRMQRYP command, when the copy function creates the to-file without a specific member name specified, the from-file name is used for the member that is added to the to-file. When using the CPYFRMQRYP command, the member added to the physical file that is created by the copy operation has the name specified by the TOMBR parameter. If you specify TOMBR(\*FIRST), the to-file member has the same name as the to-file file name that is specified on the TOFILE parameter of the CPYFRMQRYP command. The copy command ignores the MBROPT parameter value when it creates the to-file, and adds records to the new file members.

If the from-file is a database file, the copy command uses the member text and SEU source type of the from-file member for the member that is added to the to-file. If the from-file is a device or inline data file, the copy command takes the text from message CPX0411; the SEU source type is TXT. If both the from-file and to-file are database source files, the SEU source type information in the added member will be the same as the from-file member. When it adds the to-file member, the copy command always assigns the SHARE(\*NO) and EXPDATE(\*NONE) attributes to the to-file member. The copy command also sets the creation date of the new member to the current system date (not the date when the from-file member was added).

When the copy command adds a member to a to-file that is a parent file, the constraint becomes established at that time.

## Copying between different database record formats (FMTOPT parameter)

When you copy from a database file to a database file, you must use the FMTOPT parameter if the record formats are not identical or if the files are different types (source or data). If either file is a device file or inline data file, the FMTOPT parameter does not apply. The records are truncated or padded with blanks or zeros when record lengths are different. A message is sent if the records are truncated.

**Note:** You can use this parameter on the Copy File (CPYF) and Copy From Query File (CPYFRMQRYF) commands.

For database files, when either FMTOPT(\*CVTSRC) or FMTOPT(\*NOCHK) is specified and the record data copied from any from-file record is not long enough to fill a to-file record, the extra bytes in the to-file record are set to a default value. If a default value other than \*NULL is specified for the DFT keyword of the database description specifications (DDS) for a field, that field is initialized to the specified default. Otherwise, all numeric fields are initialized to zeros, all character fields are initialized to blanks, all date, time, and timestamp fields are initialized to the current system date and time. If \*NULL is specified on the DFT keyword, only the default buffer value is used. The \*NULL default is ignored.

If the from-file or to-file is a device file or an inline data file, copy automatically adds or deletes the source sequence number and date fields for each record copied.

If one file is a data file and the other a source file, you must specify FMTOPT(\*CVTSRC) to perform the copy. The sequence number and date fields are added or deleted as appropriate and the data part of each record is copied without regard to the other field definitions in the file record formats. The SRCSEQ parameter can be used to control how the sequence numbers are created, provided SRCOPT(\*SEQNBR) is also specified.

Binary character fields are padded with zeros when using FMTOPT \*MAP.

For database-to-database copies, you can reconcile any differences in record formats by specifying:

- \*DROP to drop those fields in the from-file record format for which there are no fields of the same name in the to-file record format.
- \*MAP to convert fields in the from-file to the attributes of like-named fields in the to-file and to fill extra fields in the to-file, that are not in the from-file, with their default values. The default values are:
  - The parameter value (including \*NULL) for the DFT keyword, if specified for the field
  - Blanks (for character fields without the DFT keyword)
  - Zeros (for numeric fields without the DFT keyword)
  - Current® date, time, or timestamp for those type fields without the DFT keyword

\*MAP is required if fields with the same name are in different positions in the file record formats, even though these fields have the same attributes.

- \*DROP and \*MAP to drop fields in the from-file not named in the to-file and to convert remaining fields through mapping rules to fit the to-file fields that have different attributes or positions.
- \*NOCHK to disregard the differences. Data is copied left to right directly from one file to the other. Null values are ignored. The copied records are either truncated or padded with default buffer values. Because no checking is done, fields in the to-file might contain data that is not valid for the field as defined.

Dropping and mapping fields are based on a comparison of field names. Unless all the fields in the from-file have the same name in the to-file, you must specify \*DROP. If the names are the same, but the attributes or position in the record is different, you must specify \*MAP. Dropped fields are not copied. There must be at least one like-named field in both record formats to do mapping.

When \*MAP is specified, fields in the to-file record format that do not exist in the from-file record format are filled with their default values, as described earlier in this section. For fields that have the same name and attributes, the field in the from-file record format is mapped to the field with the same name in the to-file record format, even if their positions in the formats are different.

For example, the field CUSNO is the first field in the record format ORDHD, but it is the second field in record format ORDHD1. When the CUSNO field is copied with \*MAP, it is mapped to the second field of ORDHD1.

**Note:** It is possible for files with large record formats (many fields) to have the same format level identifiers even though their formats might be slightly different. Problems can occur when copying these files if the record format names of the from-file and the to-file are the same. When copying such files using FMTOPT(\*NONE) or FMTOPT(\*MAP), it is recommended that the record format names of the from-file and the to-file be different.

Table 6 on page 39 summarizes the database-to-database copy operations for each value on the FMTOPT parameter.

<i>Table 6. Database-to-database copy operations</i>					
FMTOPT parameter values (see note 4)	Database file record formats				
	All field names in from- and to-files are the same (like-named)	Some field names in from-and to-files are the same	No field names in either file are the same		
	Attributes and relative order also the same (see note 1)	Attributes and relative order not the same (see note 1)	Like-named fields have identical attributes and relative order (see note 1)	Not all like-named fields have identical attributes and relative order (see note 1)	
*NONE	Complete copy	Command ends	Command ends	Command ends	Command ends
*DROP	Complete copy (value ignored)	Command ends	If there are extra fields in the from-file, they are dropped, all others are copied. If there are extra fields in the to-file, the command ends. If there are extra fields in the from-file and in the to-file, the command ends.	Command ends	Command ends
*MAP (see note 2)	Complete copy (value ignored)	Complete copy (corresponding fields are mapped)	If there are extra fields in the from-file, the command ends. If there are extra fields in the to-file, they are filled, and the like-named fields are mapped. If there are extra fields in the to-file and the from-file, the command ends.		Command ends

Table 6. Database-to-database copy operations (continued)

FMTOPT parameter values (see note 4)	Database file record formats			
	All field names in from- and to-files are the same (like-named)	Some field names in from- and to-files are the same	No field names in either file are the same	
*MAP and *DROP (see note 2)	Complete copy (value ignored)	Complete copy (corresponding fields are mapped)	Extra fields in the from-file are dropped; like-named fields are mapped; extra fields in the to-file are filled.	Command ends
*NOCHK	Complete copy (value ignored)	Complete copy (direct data transfer disregarding fields) (see note 3)		

**Notes:**

1. Field attributes include the data type (character, zoned, packed, binary or floating point), field length, decimal position (for numeric fields), date or time format (for date or time fields), null capability, CCSID, and whether the field has variable length or fixed length.
2. Mapping consists of converting the data in a from-file field to the attributes of the corresponding (like-named) to-file field. If the attributes of any corresponding fields are such that the data cannot be converted, the copy is ended.
3. The records are padded or truncated as necessary. Data in the from-file might not match the to-file record format.
4. Any other value specified for the FMTOPT parameter is ignored when the \*CVTFLOAT value or the \*NULLFLAGS value is specified (except the \*CVTFLOAT and \*NULLFLAGS values).

**Specifying data for different field types and attributes**

You can use FMTOPT(\*MAP) to map data between fixed-length and variable-length fields and between variable-length fields with different maximum lengths.

When mapping a variable-length field with a length of zero to a variable-length to-field, the to-field length is set to zero.

When mapping a variable-length field with a length of zero to a fixed-length to-field, the to-field is filled with single-byte blanks (X'40'), unless the to-field is a DBCS-only field. A DBCS-only to-field is set to X'4040's and surrounded by shift-out and shift-in (SO-SI) characters.

When mapping variable-length fields to variable-length fields and the from-field does not have a length of zero and graphic fields are not being mapped to or from bracketed DBCS fields, the following action happens:

- If the from-field data length is less than or equal to the maximum length of the to-field, the length of a variable-length from-field is copied to a variable-length to-field.
- If the from-field data length is greater than the maximum length of the to-field, the data of the from-field is truncated to the maximum length of the to-field, and the to-field length is set to its maximum length. The data is truncated in a manner that ensures data integrity.

**Note:** In the examples, x represents a blank, < represents the shift-out character, and > represents the shift-in character. The 2-byte length is actually a binary number shown as a character to make the example readable.

Variable-Length  
Character From-Field  
(maximum length of  
eight)

Variable-Length  
Character To-Field  
(maximum length  
of five)

00XXXXXXXX — mapped → 00XXXXXX  
 03[ABC]XXXXX — mapped → 03[ABC]XX  
 07[ABCDEFGH] — mapped → 05[ABCDE]

Variable-Length  
DBCS-Only From-  
Field (maximum  
length of eight)

Variable-Length  
DBCS-Open To-  
Field (maximum  
length of five)

04[<AA>]XXXX — mapped → 04[<AA>]X  
 08[<AABBCC>] — mapped → 05[<AA>]X

*Mapping variable-length fields to fixed-length fields*

You can use FMTOPT(\*MAP) to map variable-length fields to fixed-length fields.

If the data length of the from-field is less than or equal to the to-field length, the data is copied to the fixed-length to-field and padded to ensure data integrity.

If the length of the from-field data is greater than the to-field length, the from-field data is copied to the to-field and truncated on the right in a manner that ensures data integrity.

Variable-Length  
Character From-Field  
(maximum length of  
eight)

Fixed-Length  
Character To-Field  
(length of six)

00XXXXXXXX — mapped → XXXXXX  
 04[ABCD]XXXX — mapped → [ABCD]XX  
 08[ABCDEFGH] — mapped → [ABCDEF]

*Map fixed-length fields to variable-length fields*

You can use FMTOPT(\*MAP) to map fixed-length fields to variable-length fields.

If the to-field has a maximum length greater than or equal to the from-field length, the from-field data is copied to the data portion of the to-field and padded to the right with single-byte blanks. The to-field length is set to the length of the from-field length.

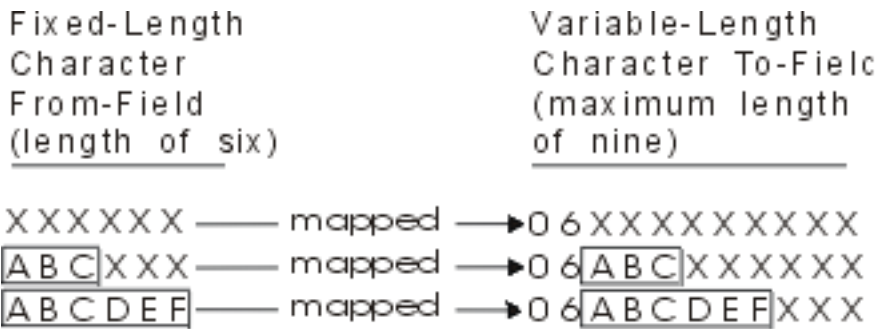

If the length of the from-field is greater than the maximum length of the variable-length to-field, the length portion of the variable-length to-field is set to the maximum length of the variable-length to-field. The data from the fixed-length from-field is copied to the data portion of the variable-length to-field and truncated on the right in a way that ensures data integrity.

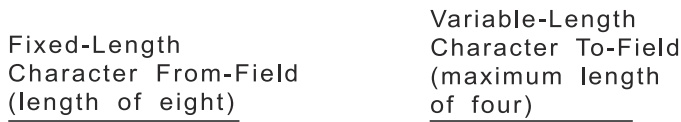

RV2H085-1

*Date, time, and timestamp fields using FMTOPT(\*MAP) or FMTOPT(\*NOCHK)*

You can use FMTOPT(\*MAP) or FMTOPT(\*NOCHK) for the date, time, and timestamp fields. The copy operation is handled differently according to your settings.

You must specify FMTOPT(\*MAP) or FMTOPT(\*NOCHK) on the Copy File (CPYF) command in any of the following cases:

- The from-file is a database data file.
- The to-file is a physical data file.
- The record formats are not identical.

Corresponding date, time, and timestamp fields in the from-file and to-file must have the same format attribute and separator for the record formats to be identical. For the Copy From Query File (CPYFRMQRYP) command, the same is true except that the open query file record format is used (rather than a from-file format).

When using FMTOPT(\*NOCHK), record data is copied directly from left to right into the to-file without any regard to field types.

When using FMTOPT(\*CVTSRC), data portions of records are directly copied from left to right into the to-file without any regard to the field types.

When using FMTOPT(\*DROP), fields in the from-file but not in the to-file are dropped. If any like-named fields in the from-file and to-file are date, time, or timestamp fields, the corresponding field must be the same type, have the same format attribute and separator, and have the same relative position in the record format as the like-named field, otherwise FMTOPT(\*MAP) might also be required.

FMTOPT(\*MAP) allows copying between like date, time, and timestamp field types regardless of the format or separator. Also, copies from and to date, time, and timestamp fields are allowed from and to zoned-decimal or character field types, provided the lengths, formats, and values can be converted.



FMTOPT(\*MAP) is required in this case for conversion to the to-field type (format and separator, if it applies).

Table 7 on page 43 outlines the conversion possibilities for the date, time, and timestamp.

<i>Table 7. Conversion table</i>						
<b>Data types</b>	<b>Forms</b>	<b>Allowable field length</b>	<b>Direction</b>	<b>Data type</b>	<b>Formats</b>	<b>Allowable field length</b>
Date	Any date format	6, 8, or 10	<-->	Date	Any	6, 8, or 10
Zoned	(MMDDYY)	6,0	<-->	Date	Any	6, 8, or 10
Zoned	(DDMMYY)	6,0	<-->	Date	Any	6, 8, or 10
Zoned	(YYMMDD)	6,0	<-->	Date	Any	6, 8, or 10
Zoned	(YYDDD)	5,0	<-->	Date	Any	6, 8, or 10
Character	(MMdDDdYY)	6 min	<-->	Date	Any	6, 8, or 10
Character	(DDdMMdYY)	6 min	<-->	Date	Any	6, 8, or 10
Character	(YYdMMdDD)	6 min	<-->	Date	Any	6, 8, or 10
Character	(YYdDDD)	6 min	<-->	Date	Any	6, 8, or 10
Character	(*USA)	6 min	---->	Date	Any	6, 8, or 10
Character	(*ISO)	6 min	---->	Date	Any	6, 8, or 10
Character	(*EUR)	6 min	---->	Date	Any	6, 8, or 10
Character	(*JIS)	6 min	---->	Date	Any	6, 8, or 10
Character	(YYYYDDD)	6 min	---->	Date	Any	6, 8, or 10
Time	Any time format	8	<-->	Time	Any	8
Zoned	(HHMMSS)	6,0	<-->	Time	Any	8
Character	(HHtMMtSS)	4 min	---->	Time	Any	8
Character	(*USA)	4 min	---->	Time	Any	8
Character	(*ISO)	4 min	---->	Time	Any	8
Character	(*EUR)	4 min	---->	Time	Any	8
Character	(*JIS)	4 min	---->	Time	Any	8
Character	(HHtMMtSS)	8 min	<----	Time	Any	8
Timestamp	SAA format	26	<-->	Timestamp	SAA	26
Zoned	(YYYYMMDDHHMMSS)	14,0	<-->	Timestamp	SAA	26
Character	SAA format	14 min	---->	Timestamp	SAA	26
Character	(YYYYMMDDHHMMSS)	14 min	<-->	Timestamp	SAA	26

Table 7. Conversion table (continued)

Data types	Forms	Allowable field length	Direction	Data type	Formats	Allowable field length
<p><b>Note:</b> In the format columns,</p> <p><b>d</b> = date separator value</p> <p><b>t</b> = time separator value</p> <p><b>any</b> = job formats or SAA formats</p> <p>In the allowable field-length column, <i>min</i> means the specified length is the minimum required for a conversion attempt. Conversion errors might still occur if the length is not long enough for the assumed format that you want. Refer to the DDS concepts information for more information about the date, time, and timestamp data types and keywords.</p>						

**When converting a character field to a date, time, or timestamp field:** The FMTOPT(\*MAP) is specified and the corresponding from-field and to-field names match, an attempt is made to determine what similar date form the character field is in. The following rules apply:

- **Converting a character field to a date field:** The minimum length that is required for the character field is 6. The system first determines if the character field data is in the same format and has the same separator as specified in the current job under which the copy command is running. This might be \*MDY, \*DMY, \*YMD, or \*JUL for the format and slash (/), hyphen (-), period (.), comma (,), or blank ( ) for the separator. If the character field is not in the specified format and separator form of the current job, the system determines if it is in one of the SAA formats (\*ISO, \*USA, \*EUR, or \*JIS), or if it is in a YYYYDDD form (no separator). If the system determines the character field is in one of these forms, it converts the character field to the date to-field. The date portion of the character field must be left-aligned and can contain trailing blanks.
- **Converting a character field to a time field:** The minimum length that is required for the character field is 4. The system first determines if the character field data is in the same format and has the same separator as specified in the current job under which the copy command is running. This might be \*HMS for the format and colon (:), comma (,), period (.), or blank ( ) for the separator. If the character field is not in the specified format and separator form of the current job, the system determines if it is in one of the SAA formats (\*ISO, \*USA, \*EUR, or \*JIS). If the system determines the character field is in one of these forms, it converts the character field to the time to-field. The time portion of the character field must be left-aligned and can contain trailing blanks.
- **Converting a character field to a timestamp field:** The minimum length that is required for the character field is 14. The system first determines if the character field data is in one of the following types:
  - SAA format
  - YYYYMMDDHHMMSS form

If the system determines that the character field is in one of these forms, it converts the character field to the timestamp to-field. The timestamp portion of the character field must be left-aligned and can contain trailing blanks.

**When converting a date, time, or timestamp field to a character field:** The FMTOPT(\*MAP) is specified and the corresponding from and to-file field names match, the system attempts to convert the date, time, or timestamp field into the form specified by the current job. The following rules apply:

- **For converting a date field to a character field:** The minimum length that is required for the character field is 6. The system first determines the date format and separator attribute of the current job under which the copy command is running. This might be \*MDY, \*DMY, \*YMD, or \*JUL for the format and

slash (/), hyphen (-), period (.), comma (,), or blank ( ) for the separator. The date field is converted into the character field in the specified format of the current job. For character fields that are longer than required for the conversion, the data is left-aligned and trailing blanks are added.

- **For converting a time field to a character field:** The minimum length required for the character field is 8. The system first determines the time separator attribute of the current job under which the copy command is running. This might be colon (:), comma (,), period (.), or blank ( ). The time field is converted into the character field in the \*HMS format (including the specified separator of the current job). For character fields that are longer than required for the conversion, the data is left-aligned and trailing blanks are added.
- **For converting a timestamp field to a character field:** The minimum length required for the character field is 14. The timestamp field is converted into the character field in the YYYYMMDDHHMMSS form (no separators). For character fields that are longer than required for the conversion, the data is left-aligned and trailing blanks are added.

**When converting a zoned decimal field to a date, time, or timestamp field:** The FMTOPT(\*MAP) is specified and the corresponding from-field and to-field names match. The system assumes that the zoned decimal field is in the form that is specified by the current job. The following rules apply:

- **For converting a zoned decimal field to a date field:** The system assumes the zoned decimal field data is in the same date format (no separators) as specified in the current job under which the copy command is running. This might be \*MDY, \*DMY, \*YMD, or \*JUL. The length of the zoned decimal field must be 5,0 (if the current job format is \*JUL) or 6,0 (if the current job format is \*MDY, \*DMY, or \*YMD). The system attempts to convert or copy it to the date to-field.
- **For converting a zoned decimal field to a time field:** The system assumes the zoned decimal field data is in the \*HMS format (no separators). The length of the zoned decimal field must be 6,0. The system attempts to convert or copy it to the time to-field.
- **For converting a zoned decimal field to a timestamp field:** The system assumes the zoned decimal field data is in the YYYYMMDDHHMMSS form (no separators). The length of the zoned decimal field must be 14,0. The system attempts to convert or copy it to the timestamp to-field.

**When converting a date, time, or timestamp field to a zoned decimal field:** The FMTOPT(\*MAP) is specified and the corresponding from-field and to-field names match, the system uses the specified format for the current job to determine what format the zoned decimal data should be in. The following rules apply:

- **For converting a date field to a zoned decimal field:** The system assumes the zoned decimal field data is to be in the same date format (no separators) as specified in the current job under which the copy command is running. This might be \*MDY, \*DMY, \*YMD, or \*JUL. The length of the zoned decimal field must be 5,0 (if the current job format is \*JUL) or 6,0 (if the current job format is \*MDY, \*DMY, or \*YMD). The system attempts to convert or copy the date field to it.
- **For converting a time field to a zoned decimal field:** The system assumes the zoned decimal field data is to be in the \*HMS format (no separators). The length of the zoned decimal field must be 6,0. The system attempts to convert or copy the time field to it.
- **For converting a timestamp field to a zoned decimal field:** The system assumes the zoned decimal field data is to be in the YYYYMMDDHHMMSS form (no separators). The length of the zoned decimal field must be 14,0. The system attempts to convert or copy the timestamp field to it.

An informational message is sent if any conversion is not successful because of a data value, data format, or data-length error. The to-file field is set with its default value.

## Related information

### DDS concepts

#### *Null-capable fields using FMTOPT(\*MAP) or FMTOPT(\*NOCHK)*

You can use FMTOPT(\*MAP) or FMTOPT(\*NOCHK) for null-capable fields. The copy operation is handled differently according to your settings.

FMTOPT(\*MAP) or FMTOPT(\*NOCHK) must be specified on the Copy File (CPYF) command if:

- The from-file is a database data file.

- The to-file is a physical data file.
- The record formats are not identical.

For the record formats to be identical, corresponding fields in the from-file and to-file must both be null-capable or not null-capable. For the Copy From Query File (CPYFRMQRYP) command, the same is true except that the open query file record format is used (rather than a from-file format).

When you use `FMTOPT(*MAP)`:

- Null values are copied from null-capable from-file fields to null-capable to-file fields that are named alike. This copying can only happen if the field attributes and lengths are compatible.
- Fields that are not null-capable can also be copied from and to null-capable fields, provided the field attributes and lengths are compatible. The results to expect in the to-file field are:
  - Copying a null-capable field to a null-capable field
 

Null values in the from-file field are copied to the to-file field. Values that are not null in the from-file field are also copied to the to-file field. For values that are not null in the from-file field that cause conversion errors during the copy, the default value of the to-file field is placed into the to-file field.
  - Copying a field that is not null capable to a null-capable field
 

Values that are not null in the from-file field are copied to the to-file field. For values in the from-file field that cause conversion errors during the copy operation, the default value of the to-file field is placed into the to-file field.
  - Copying a null-capable field to a field that is not null capable
 

Values that are not null in the from-file field are copied to the to-file field. If a conversion error occurs when copying values that are not null or the from-file field value is null, the to-file field default value is placed into the to-file.

When you use `FMTOPT(*NONE)`, the null values in the from-file are copied to the to-file when copying a database file to a physical data file with identical record formats.

When you use `FMTOPT(*DROP)`, the null values are copied.

When you use `FMTOPT(*NOCHK)` or `FMTOPT(*CVTSRC)`, the record data is copied directly from left to right into the to-file without any regard to field types. Null values are not copied if `*NOCHK` or `*CVTSRC` is specified, because the record formats need not be identical. Either a user-specified or default value is copied to the to-file rather than a null value.

#### *CCSIDs using FMTOPT(\*MAP) or FMTOPT(\*NOCHK)*

You can use `FMTOPT(*MAP)` or `FMTOPT(*NOCHK)` for CCSIDs. CCSID conversions are handled differently according to your settings.

When `FMTOPT(*NOCHK)` is specified, no CCSID conversions are done. Record data is copied directly from left to right into the to-file without any regard to field types or CCSIDs.

When `FMTOPT(*MAP)` is specified and a valid conversion is defined between the CCSID of the from-field and the CCSID of the to-file field, the character data is converted to the CCSID of the to-file field. However, if the CCSID of the from-file field or the CCSID of the to-file field is 65535, no conversions are done.

When `FMTOPT(*NONE)` is specified, the from-file and to-file attributes must be the same, unless one of the CCSIDs in corresponding fields is 65535.

For the Copy From Query File (CPYFRMQRYP) command, the `FMTOPT` rules are the same except that the changed query format is used instead of a from-file format.

#### *DBCS-graphic fields using FMTOPT(\*MAP) or FMTOPT(\*NOCHK)*

You can use `FMTOPT(*MAP)` or `FMTOPT(*NOCHK)` for DBCS-graphic fields. The copy operation is handled differently according to your settings.

When mapping graphic fields to bracketed DBCS fields, shift-out and shift-in characters are added around the DBCS data. When mapping from bracketed-DBCS fields to graphic fields, the shift-out and shift-in

characters are removed. For variable-length fields, the graphic field length is expressed in the number of DBCS characters and the bracketed DBCS length is expressed in number of bytes (including the shift-out and shift-in characters). This difference is accounted for when mapping variable-length graphic fields to or from variable bracketed DBCS fields.

When using the `Copy File (CPYF)` command with `FMTOPT(*MAP)` to copy a DBCS-open field to a graphic field, a conversion error occurs if the DBCS-open field contains any SBCS data (including blanks). When copying to a graphic field, it might be desirable to ignore trailing SBCS blanks that follow valid DBCS data (in a DBCS-open field). This allows the copy operation to be done without a conversion error. This type of copy can be done using a combination of the `Open Query File (OPNQRYF)` and `Copy From Query File (CPYFRMQRYF)` commands. The `OPNQRYF` command is used to remove trailing single-byte blanks and place the data into a variable-length DBCS-open field. The `CPYFRMQRYF` command with `FMTOPT(*MAP)` specified is used to copy the variable-length DBCS-open field to the graphic field.

For example, assume the DBCS-open fields in the file named `FILEO` are copied into graphic fields in the file named `FILEG`. An additional file (`FILEV`) must be created.

### The DDS for the original from-file `FILEO`:

```
***** ***** Beginning of data *****
      A          R FMT01
      A          FLD1          100          CCSID(65535)
      A          FLD2           70          CCSID(65535)
      A          FLD3          20A
***** ***** End of data *****
```

**DDS for `FILEV`:** This file's format will be specified on the `OPNQRYF` command `FORMAT` parameter. The only difference from `FILEO` is that the DBCS-open fields to be converted to graphic fields are defined to be variable length.

```
***** ***** Beginning of data *****
      A          R FMT01
      A          FLD1          100          VARLEN CCSID(65535)
      A          FLD2           70          VARLEN CCSID(65535)
      A          FLD3          20A
***** ***** End of data *****
```

**DDS for the new file `FILEG`:** The graphic fields are defined as fixed length; however, they can be made variable length, if that is what you want.

```
***** ***** Beginning of data *****
      A R FMT01 A FLD1 4G CCSID(65535) A FLD2 3G CCSID(65535) A FLD3 20A
***** ***** End of data *****
```

The following commands are used to copy the data from the DBCS-open fields in `FILEO` to the graphic fields in `FILEG`:

```
CHGJOB CCSID(65535)
OPNQRYF FILE((MYLIB/FILEO)) FORMAT(MYLIB/FILEV *ONLY) MAPFLD((FLD1 '%STRIP(1/FLD1 *TRAIL)') (FLD2 '%STRIP(1/FLD2 *TRAIL)'))
CPYFRMQRYF FROMOPNID(FILEO) TOFILE(MYLIB/FILEG) MBROPT(*REPLACE) FMTOPT(*MAP)
```

### Converting universal coded character set (UCS-2) graphic fields

You can use `FMTOPT(*MAP)` to convert universal coded character set (UCS-2) graphic fields.

Using `FMTOPT(*MAP)` to copy *to* a UCS-2 graphic field converts the data in the from-field CCSID to the CCSID of the UCS-2 graphic to-field. If the length after conversion is less than the length of the UCS-2 graphic to-field, the field is padded. If the length after conversion is greater than the length of the UCS-2 graphic to-field, the field is truncated.

Using `FMTOPT(*MAP)` to copy *from* a UCS-2 graphic field converts the data from the CCSID of the UCS-2 graphic field to the CCSID of the to-field. If the length after conversion is less than the length of the to-field, the field is padded. If the length after conversion is greater than the length of the to-field, the field is truncated. Shift-out and shift-in characters are added around double-byte data except in DBCS-graphic and UCS-2 graphic fields.

UCS-2 conversion possibilities also include variable length fields. Generally, the result length of a variable length to-field will be the minimum of the from-field converted length and the maximum length of the to-field.

The CCSID conversions created when copying from or to a UCS-2 graphic field might cause the byte length of the data to be different after the conversion. The maximum length of the to-field is used to determine if all of the converted data will fit in the to-field.

When copying from a UCS-2 graphic field to a character field, or to a DBCS-either field where the first byte is already converted to a valid SBCS character (not a shift-out X'0E'), any remaining characters that cannot be converted to SBCS (actual double-byte data in the UCS-2 field) will have a single-byte substitution character set in its place.

When copying from a UCS-2 graphic field to a DBCS-only, DBCS-graphic field, or to a DBCS-either field where the first byte is already converted to a DBCS shift-out (X'0E'), any remaining characters that cannot be converted to DBCS will have a double-byte substitution character set in its place.

To be successful when using FMTOPT(\*MAP) to convert from or to UCS-2 data, the resulting converted data for the to-field must conform to the to-field type. Otherwise, conversion errors will occur and the to-field will be set to its default value.

#### *UCS-2 graphic fields restrictions*

There are some restrictions when you copy from or to a UCS-2 graphic field.

The `CPYF` and `CPYFRMQRYP` commands with `FMTOPT(*MAP)` specified are not allowed when you copy from or to a UCS-2 graphic field unless the corresponding field is a UCS-2 or DBCS-graphic field (any CCSID including 65535), or is a character, DBCS-open, DBCS-either, or DBCS-only field with a CCSID other than 65535. The only other corresponding type allowed to have a CCSID of 65535 is DBCS-graphic.

The following parameters for the `CPYF` command do not support UCS-2 or UTF-16 graphic fields, or UTF-8 character fields:

- `FROMKEY(*BLDKEY)` that refers to a UCS-2 or UTF-16 graphic keyfield, or a UTF-8 character keyfield
- `TOKEY(*BLDKEY)` that refers to a UCS-2 or UTF-16 graphic keyfield, or a UTF-8 character keyfield
- `INCCCHAR` that specifies a UCS-2 or UTF-16 graphic field name, or a UTF-8 character field name
- `INCREL` that specifies a UCS-2 or UTF-16 graphic field name, or a UTF-8 character field name

#### **Related reference**

[Copy operation of DBCS files](#)

You can copy both spooled and nonspooled DBCS files.

### ***Converting universal coded character set transformation format (UTF-8 character and UTF-16 graphic)***

You can use `FMTOPT(*MAP)` to convert universal coded character set transformation format.

Using `FMTOPT(*MAP)` to copy to a UTF-8 character or UTF-16 graphic field converts the data in the from-field CCSID to the CCSID of the UTF-8 character or UTF-16 graphic to-field. If the length after conversion is less than the length of the UTF-8 or UTF-16 graphic to-field, the field is padded. If the length after conversion is greater than the length of the UTF-8 character or UTF-16 graphic to-field, the field is truncated.

Using `FMTOPT(*MAP)` to copy from a UTF-8 character or UTF-16 graphic field converts the data from the CCSID of the UTF-8 character or UTF-16 graphic field to the CCSID of the to-field. If the length after conversion is less than the length of the to-field, the field is padded. If the length after conversion is greater than the length of the to-field, the field is truncated.

UTF-8 or UTF-16 conversion possibilities also include variable length fields. Generally, the result length of a variable length to-field will be the minimum of the from-field converted length and the maximum length of the to-field.

The CCSID conversions created when copying from or to a UTF-8 or UTF-16 field might cause the byte length of the data to be different after the conversion. The maximum length of the to-field is used to determine if all of the converted data will fit in the to-field.

When copying from a UTF-8 or UTF-16 field to a character field, or to a DBCS-either field where the first byte is already converted to a valid SBCS character (not a shift-out X'0E'), any remaining characters that cannot be converted to SBCS (actual double-byte data in the UTF-8 or UTF-16 field) will have a single-byte substitution character set in its place.

When copying from a UTF-8 or UTF-16 field to a DBCS-only, DBCS-graphic field, or to a DBCS-either field where the first byte is already converted to a DBCS shift-out (X'0E'), any remaining characters that cannot be converted to DBCS will have a double-byte substitution character set in its place.

To be successful when using FMTOPT (\*MAP) to convert from or to a UTF-8 or UTF-16 data, the resulting converted data for the to-field must conform to the to-field type. Otherwise, conversion errors will occur and the to-field will be set to its default value.

FMTOPT (\*MAP) has to be specified when you copy from a non-normalize file to a normalize file. The to file will be a normalize file in any cases described in the following table:

<b>FromFile (non-normalize)</b>	<b>ToFile (normalize)</b>
UTF-8	UTF-8
UTF-8	UTF-16
UTF-16	UTF-16
UTF-16	UTF-8
UCS2	UTF-8
UCS2	UTF-16

### ***Converting System/370 floating-point and null fields***

To copy floating-point fields and null fields that are in a System/370 format to an IBM i format, use FMTOPT(\*CVTFLOAT) for the floating-point fields and FMTOPT(\*NULLFLAGS) for the null fields. You can use these two values together in one command: FMTOPT(\*CVTFLOAT \*NULLFLAGS).

The FMTOPT(\*CVTFLOAT) parameter on the Copy File (CPYF) command converts each floating point field from System/370 hexadecimal format to the IEEE format that is used by the IBM i operating system. The CPYF command converts those fields that are identified by the external description of the physical to-file.

The FMTOPT(\*NULLFLAGS) parameter on the CPYF command takes the byte (or flag) following each null-capable field and uses it to indicate if the corresponding input field is null. The CPYF command takes the fields that are identified as null-capable by the external description of the physical to-file. If the byte (or flag) is blank (X'40') or contains X'00', the data is considered not null. Any other value for the flag causes the corresponding input field data to be ignored and the output value set to null.

If you use \*CVTFLOAT or \*NULLFLAGS and the input file is externally described, the input file's external description is not used in mapping the copied data.

When you use \*CVTFLOAT and \*NULLFLAGS (together or independently), make certain that the to-file is an existing database, externally-described, physical data file.

You cannot specify the \*CVTFLOAT and \*NULLFLAGS values when any of the following conditions are true:

- You have specified RCDFMT(\*ALL) for a multiple-format logical from-file
- You have specified any value other than the default for CRTFILE, and the to-file does not exist
- You have specified a value other than the default for the FROMKEY, TOKEY, INCCHAR, INCREL, SRCOPT, or SRCSEQ parameters.

When you specify either \*CVTFLOAT or \*NULLFLAGS, all other values for the FMTOPT parameter are ignored. If you use both \*CVTFLOAT and \*NULLFLAGS on one CPYF command, both values are recognized.

When you specify the \*CVTFLOAT value (and have not specified \*NULLFLAGS), the expected from-file record length is the to-file record length. When you have specified the \*NULLFLAGS value, the expected from-file record length is equal to the sum of the to-file record length and the number of null-capable fields in the to-file. The from-file's record length cannot be less than the expected length. If the from-file's record length is greater than the expected length, an inquiry message is sent to the QSYSOPR message queue to determine if the user wants to continue. If the user continues, the trailing data (fields) in the from-file is truncated in the to-file.

The to-file must contain the correct result format description. The from-file data must be in the same corresponding position as the to-file data. Otherwise, output mapping errors or unpredictable results might occur. Date, time, and timestamp data must be in the external form of the to-file field specification. Numeric data types in the to-file must be large enough to contain the expected data. For example, decimal data types in the to-file must be created using the maximum possible precision for the byte length of the field to avoid the loss of any digits. Because there are no CCSID conversions, the to-file fields should be created with the expected CCSIDs.

For more information about converting floating points and null fields, see [“Errors in converting System/370 floating-point and null fields”](#) on page 50.

#### *Errors in converting System/370 floating-point and null fields*

Any conversion errors will cause CPF2958 messages to be issued for up to 10 records with errors. A CPF2959 message will be issued after the copy operation; this message indicates the number of records that caused an error if more than 10 records caused conversion errors.

If there are no floating-point fields in the to-file and \*CVTFLOAT is specified, no error messages are issued. However, no floating-point conversion is done. If you have not specified any null-capable fields in the to-file and \*NULLFLAGS, no error messages are issued. However, the from-file data is assumed to have no null bytes (or flags). When you use \*CVTFLOAT and \*NULLFLAGS, the CPYF command expects the from-file data to be defined by the to-file format.

You should use the \*CVTFLOAT and \*NULLFLAGS values only for files that require conversion of the System/370 hexadecimal floating-point fields or conversion with null flags. Using these values for other files might cause unpredictable results including possible data corruption and output errors. System/370 floating-point fields must be converted only once. If the fields are converted more than once, multiple conversions occur, and the data will be damaged.

This CPYF function is compatible with the data that is placed on tape by the DB2 unload function (DSNTIAUL). You must manually create the result tables or files with SQL or DDS on the IBM i operating system before you can run the CPYF function to convert the data. Use the formats produced by the DSNTIAUL function to create the result tables or files.

### **Conversion rules for copying files**

Here are the conversion rules the system follows when copying files.

The [Table 8 on page 51](#) table shows the field conversions that are allowed between mapped fields in the from-file and to-file record formats. If fields with the same name have incompatible attributes between the from-file and to-file formats, you can only use FMTOPT(\*NOCHK) to perform the copy. An X indicates that the conversion is valid, and a blank indicates a field mapping that is not valid.

When mapping character fields, the field being copied is truncated on the right if it is longer than the field into which the copy is made. For example, a character field of length 10 is copied into a character field of length 6; ABCDEFGHIJ becomes ABCDEF. If the field that is being copied is shorter than the field into which it is copied, the field is padded on the right with blanks. For example, a character field of length 10 is copied into a character field of length 12; ABCDEFGHIJ becomes ABCDEFGHIJxx (x = blank).

When you are mapping numeric fields, and the field being copied is longer than the field into which the copy is made, the field being copied is truncated on the left and right of the decimal point. For example, a zoned decimal field of length 9 with 4 decimal positions is copied to a zoned decimal field of length 6 with 3 decimal positions; 00115.1109 becomes 115.110.

If significant digits must be truncated to the left of the decimal point, the value is not copied, and the field is set to its default value (either the parameter value of the DFT keyword, if specified, or zero, if the DFT



keyword is not specified). Also, if significance will be lost because a floating-point numeric value exponent is too large, the to-file field is set to its default value.

When you are mapping numeric fields for which the field that is being copied is shorter than the field into which the copy is made, the field being copied is padded with zeros on the left and right of the decimal point. For example, a packed decimal field of length 7 with 5 decimal positions is copied to a packed decimal field of length 10 with 6 decimal positions; 99.99998 becomes 0099.999980.

*Table 8. Field conversions.* (This table is not applicable to FMTOPT(\*CVTFLOAT) or FMTOPT(\*NULLFLAGS), where the from-file data is defined by the to-file.)

From field	To character, binary character or hexadecimal field	To packed decimal field	To zoned decimal field	To binary (no decimals positions) field	To floating point field	To binary field (with decimals positions)
Character, binary character or hexadecimal	X					
Packed		X	X	X	X	
Zoned		X	X	X	X	
Binary (no decimal positions)		X	X	X	X	
Floating point		X	X	X	X	
Binary (with decimal positions)						X <sup>1</sup>
<b>Note:</b>						
<sup>1</sup> A binary numeric field with one or more decimal positions can be copied only to a binary field with the same number of decimal positions.						

## Adding or changing source file sequence number and date fields (SRCOPT and SRCSEQ parameters)

You can perform additions or changes to sequence number fields and date fields sequence number and date fields when you are copying files.

### Related concepts

[Specifying \\*ADD when copying files](#)

When you specify \*ADD, each record copied is added to the end of the existing records in the member.

### Copying device source files to database source files

When you copy a device source file to a database source file, the system adds sequence number fields and date fields at the start of the records.

The system assigns the first record a sequence number of 1.00, the next 2.00, and so on, increasing in increments of 1.00. If more than 9999 records are copied, the sequence number wraps back to 1.00 and continues to increment unless you specify the SRCOPT and SRCSEQ parameters on the copy command.

If several copies to the same file are made with MBROPT(\*ADD), you will have duplicate sequence numbers in the file. You can correct this using the [Reorganize Physical File Member \(RGZPFM\)](#) command.

Date fields are initialized to zeros.

When copying to or from a device, it is more efficient to use a device data file than a device source file. The copy function automatically adds or removes sequence number fields and date fields source sequence number and date fields as necessary.

### ***Copying database source files to device source files***

When you copy a database source file to a device source file, the system removes the date fields and the sequence number fields from the start of the records.

When copying to or from a device, it is more efficient to use a device data file than a device source file. The copy function automatically adds or removes source sequence number fields and date fields as necessary.

### ***Copying database source files to database source files***

When you copy database source files to database source files, you use SRCOPT(\*SEQNBR) and the SRCSEQ parameter to assign sequence numbers to the copied records.

You can copy between database source files by using the [Copy Source File \(CPYSRCF\)](#) or [Copy File \(CPYF\)](#) command. The CPYSRCF command might be easier to use because the parameter defaults are better suited for copying database source files.

If you specify SRCOPT(\*SEQNBR) to update the sequence numbers, the system considers the SRCSEQ parameter. The SRCSEQ parameter specifies the starting value that is assigned to the first copied record, and the increment value. The defaults are 1.00 and 1.00. You can specify a whole number of no more than 4 digits or a fraction of no more than 2 digits for the starting value and the increment value. You must use a decimal point for fractions.

For example, if you specify SRCSEQ(100.50), then the records copied will have sequence numbers 100.00, 100.50, 101.00, 101.50, and so on.

Suppose that you have a file that contains more than 9999 records. Use a fractional increment value so that each record has a unique sequence number. If you specify a starting value of .01 and an increment value of .01, the maximum number of records copied with unique sequence numbers is 999 999. When the maximum sequence number is exceeded (9999.99), all remaining records on that copy are initialized to 9999.99. The system does not wrap back to 1.00.

If the database source file that you are copying to has only an arrival sequence access path, the records are always physically placed at the end of the file. (Because the file does not have a keyed sequence access path, you cannot insert records into the middle of the file keyed access path.)

## **Copying complex objects**

You can copy from and to files that contain user-defined functions (UDFs), user-defined types (UDTs), DataLinks (DLs), large objects (LOBs), identity columns, or ROWIDs.

### ***Copying files that contain user-defined functions***

You can specify CRTFILE(\*YES) on the CPYF and CPYFRMQRYP commands when you copy files that contain user-defined functions (UDFs). UDFs do not get created with the new to-file.

You cannot copy distributed data management (DDM) files that contain user-defined functions to IBM i products.

#### **Related information**

[Copy File \(CPYF\) command](#)

[Copy From Query File \(CPYFRMQRYP\) command](#)

### ***Copying files that contain user-defined types***

You can specify CRTFILE(\*YES) on the CPYF and CPYFRMQRYP commands when you copy files that contain user-defined types (UDTs). If the from-file is an SQL table, view, or index that contains a UDT, these commands create an SQL table.

You can copy UDTs to other UDTs using FMTOPT(\*MAP), provided that you are copying from and to the same (identical) UDT. You can also copy from a non-UDT to a UDT, provided that the source type is

compatible. Data mapping is not allowed if you are copying between UDTs that are not identical. Also, data mapping is not allowed if you are copying from a UDT to a non-UDT.

You cannot copy distributed data management (DDM) files that contain user-defined types to IBM i products.

**Related information**

[Copy File \(CPYF\) command](#)

[Copy From Query File \(CPYFRMQRYP\) command](#)

**Copying files that contain datalinks**

You can specify CRTFILE(\*YES) on the CPYF and CPYFRMQRYP commands when you copy files that contain datalinks. If the from-file is an SQL table, view, or index that contains a datalink, these commands create an SQL table.

Datalinks can be mapped only to other datalinks. Therefore, if you specify \*NONE, \*MAP, or \*DROP on the FMTOPT parameter, the from-file and to-file must have corresponding datalinks. Truncation is not allowed. Shorter datalinks, however, can be converted to longer datalinks.

A file can be linked only once on a system. Therefore, a copy that performs mapping or that requires the formats to be identical (that is, \*NONE, \*MAP, or \*DROP is specified on the FMTOPT parameter) is not successful if corresponding from-file and to-file fields are both FILE LINK CONTROL. Copy operations that are performed using the \*NOCHK parameter option are not restricted, but errors occur if a datalink that references a linked file is copied to a datalink that is FILE LINK CONTROL.

When you specify CRTFILE(\*YES) on the CPYF or CPYFRMQRYP command, and the from-file contains a FILE LINK CONTROL datalink field, the following statements are true, depending on how you specify the FMTOPT parameter:

- If you specify \*NONE, \*MAP, or \*DROP on the FMTOPT parameter, the file is created, but an error message is issued and no I/O is performed.
- If you specify \*NOCHK or \*CVTSRC on the FMTOPT parameter, the file is created and I/O is attempted. The I/O will be unsuccessful for any records that contain a valid LINK.

The following table shows LINK scenarios associated with the CPYF command when different FMTOPT values are used.

<b>LINK status for from-field to to-field when FMTOPT parameter is *MAP or *NONE</b>	<b>How linking is performed</b>
FILE LINK CONTROL to FILE LINK CONTROL	Not allowed. Files can be linked only once.
NO LINK CONTROL to FILE LINK CONTROL (with no truncation)	Linking is performed.
FILE LINK CONTROL to NO LINK CONTROL (with no truncation)	No linking is performed.
NO LINK CONTROL to NO LINK CONTROL (with no truncation)	No linking is performed.

**Related information**

[Copy File \(CPYF\) command](#)

[Copy From Query File \(CPYFRMQRYP\) command](#)

**Copying files that contain large objects**

You can specify CRTFILE(\*YES) on the CPYF and CPYFRMQRYP commands when you copy files that contain large objects (LOBs). If the from-file is an SQL table, view, or index that contains a LOB, these commands create an SQL table.

The IBM i operating system supports three large object data types: binary large objects (BLOBs), single-byte or mixed character large objects (CLOBs), and double-byte character large objects (DBCLOBs). When

you copy files that contain these objects using the Copy File (CPYF) command, consider the following restrictions and requirements:

- LOB data is not copied when you copy from and to device files, when you copy to \*PRINT, or when you specify values of \*NOCHK or \*CVTSRC on the FMTOPT parameter. In these cases, only the default buffer value for the LOB field is copied, including \*POINTER. This is true even when you copy a file that contains a LOB field to an identical file. Valid LOB data is copied only when you have specified \*NONE, \*MAP, or \*DROP on the FMTOPT parameter.
- LOB data is not copied when you copy to a tape or diskette. In these cases, only the buffer value (including \*POINTER) is written to the tape or diskette. In addition, if you copy from the tape or diskette back to the same file, you might receive errors. This is because the file contains only the \*POINTER value and not a valid pointer to actual LOB data.
- When you specify \*UPDADD on the MBROPT parameter of the CPYF command, the to-file can contain a LOB field. LOB fields are also updated when duplicate keys are encountered.
- When you specify \*CVTFLOAT or \*NULLFLAGS on the FMTOPT parameter of the CPYF command, the to-file cannot contain a LOB field.
- If you want to print a file that contains LOB fields, specify \*PRINT on the TOFILE parameter of the CPYF command. \*POINTER will appear in the print listing in place of the LOB field data, and other non-LOB field data will also appear in the listing. If you have not specified \*PRINT on the TOFILE parameter and you specified \*COPIED, \*EXCLUDE, or \*ERROR on the PRINT parameter, then you must specify \*NOCHK or \*CVTSRC on the FMTOPT parameter for the copy operation to be allowed.
- You cannot specify LOB fields on the INCCHAR and INCREL parameters. You can specify \*RCD or \*FLD on the INCCHAR parameter, but only the fixed buffer length is compared instead of any actual LOB data.
- You cannot copy distributed data management (DDM) files that contain LOB fields to IBM i products.

The following tables show how LOBs are mapped to other data types during copy operations. The first table shows the mapping when both fields contain LOB field types. In the tables, consider the following guidelines:

- The mapping of LOBs from and to DATE or TIME types is not allowed.
- These mappings are valid only for FMTOPT(\*MAP) except where noted.
- There are similar data restrictions for large objects as those for normal character data (single-byte, mixed, and double-byte).

Field A type	Field B type	Allowed and copy direction	Data CCSID or attributes		CCSIDs	Conversion translation performed
			Field A	Field B		
BLOB	BLOB	Y* <—>	65535	65535	Same	No
CLOB	CLOB	Y* <—>	Character	Character	Same	No
CLOB	CLOB	Y* <—>	Open	Open	Same	No
DBCLOB	DBCLOB	Y* <—>	Graphic	Graphic	Same	No
DBCLOB	DBCLOB	Y* <—>	UCS2	UCS2	Same	No
CLOB	CLOB	Y <—>	Character	Character	Different	Yes
CLOB	CLOB	Y <—>	Open	Open	Different	Yes
DBCLOB	DBCLOB	Y <—>	Graphic	Graphic	Different	Yes
DBCLOB	DBCLOB	Y <—>	UCS2	UCS2	Different	Yes
CLOB	CLOB	Y <—>	Character	Open	Different	Yes
CLOB	DBCLOB	N	Character	Graphic	Different	—

Table 9. From-file and to-file mapping when both fields are large objects (continued)

Field A type	Field B type	Allowed and copy direction	Data CCSID or attributes		CCSIDs	Conversion translation performed
			Field A	Field B		
CLOB	DBCLOB	Y <->	Open	Graphic	Different	Yes
CLOB	DBCLOB	Y <->	Character	UCS2	Different	Yes
CLOB	DBCLOB	Y <->	Open	UCS2	Different	Yes
DBCLOB	DBCLOB	Y <->	Graphic	UCS2	Different	Yes
BLOB	CLOB	Y <->	65535	Character	Different	No
BLOB	CLOB	Y <->	65535	Open	Different	No
BLOB	DBCLOB	N	65535	Graphic	Different	—
BLOB	DBCLOB	N	65535	UCS2	Different	—
DBCLOB	DBCLOB	Y <->	1200	1200	Same	No
CLOB	DBCLOB	Y <->	Character	1200	Different	Yes
CLOB	DBCLOB	Y <->	Open	1200	Different	Yes
DBCLOB	DBCLOB	Y <->	Graphic	1200	Different	Yes
BLOB	DBCLOB	N	65535	1200	Different	—
CLOB	CLOB	Y <->	1208	1208	Same	No
CLOB	CLOB	Y <->	Character	1208	Different	Yes
CLOB	CLOB	Y <->	Open	1208	Different	Yes
DBCLOB	CLOB	Y <->	Graphic	1208	Different	Yes
BLOB	CLOB	N	65535	1208	Different	—

**Note:** \* These mappings are valid for FMTOPT(\*MAP), FMTOPT(\*NONE), and FMTOPT(\*DROP).

The second table shows the mapping between fixed-length data types and large objects.

Table 10. From-file and to-file mapping between fixed-length data types and large objects

Field A type	Field B type	Allowed and copy direction	Data CCSID or attributes		CCSIDs	Conversion translation performed
			Field A	Field B		
Character	BLOB	Y <->	Character	65535	Different	No
Open	BLOB	Y <->	Open	65535	Different	No
Either	BLOB	Y <->	Either	65535	Different	No
Only	BLOB	Y <->	Only	65535	Different	No
Graphic	BLOB	N	Graphic	65535	Different	—
UCS2	BLOB	N	UCS2	65535	Different	—
Character	CLOB	Y <->	Character	Character	Same/Different	No/Yes
Open	CLOB	Y <->	Open	Character	Different	Yes
Either	CLOB	Y <->	Either	Character	Different	Yes

Table 10. From-file and to-file mapping between fixed-length data types and large objects (continued)

Field A type	Field B type	Allowed and copy direction	Data CCSID or attributes		CCSIDs	Conversion translation performed
			Field A	Field B		
Only	CLOB	Y <—>	Only	Character	Different	Yes
Graphic	CLOB	N	Graphic	Character	Different	—
UCS2	CLOB	Y <—>	UCS2	Character	Different	Yes
Character	CLOB	Y <—>	Character	Open	Different	Yes
Open	CLOB	Y <—>	Open	Open	Same/Different	No/Yes
Either	CLOB	Y <—>	Either	Open	Different	Yes
Only	CLOB	Y <—>	Only	Open	Different	Yes
Graphic	CLOB	Y <—>	Graphic	Open	Different	Yes
UCS2	CLOB	Y <—>	UCS2	Open	Different	Yes
Character	DBCLOB	N	Character	Graphic	Different	—
Open	DBCLOB	Y <—>	Open	Graphic	Different	Yes
Either	DBCLOB	Y <—>	Either	Graphic	Different	Yes
Only	DBCLOB	Y <—>	Only	Graphic	Different	Yes
Graphic	DBCLOB	Y <—>	Graphic	Graphic	Same/Different	No/Yes
UCS2	DBCLOB	Y <—>	UCS2	Graphic	Different	Yes
Character	DBCLOB	Y <—>	Not 65535	UCS2	Different	Yes
Open	DBCLOB	Y <—>	Not 65535	UCS2	Different	Yes
Either	DBCLOB	Y <—>	Not 65535	UCS2	Different	Yes
Only	DBCLOB	Y <—>	Not 65535	UCS2	Different	Yes
Graphic	DBCLOB	Y <—>	Graphic	UCS2	Different	Yes
UCS2	DBCLOB	Y <—>	UCS2	UCS2	Same/Different	No/Yes
Character	DBCLOB	N	65535	UCS2	Different	—
Open	DBCLOB	N	65535	UCS2	Different	—
Either	DBCLOB	N	65535	UCS2	Different	—
Only	DBCLOB	N	65535	UCS2	Different	—
UTF8	BLOB	N	1208	65535	Different	—
UTF8	CLOB	Y <—>	1208	Character	Different	Yes
UTF8	CLOB	Y <—>	1208	Open	Different	Yes
UTF8	DBLOB	Y <—>	1208	Graphic	Different	Yes
UTF8	DBLOB	Y <—>	1208	UCS2	Same	No
UTF16	BLOB	N	1200	65535	Different	—
UTF16	CLOB	Y <—>	1200	Character	Different	Yes
UTF16	CLOB	Y <—>	1200	Open	Different	Yes

Table 10. From-file and to-file mapping between fixed-length data types and large objects (continued)

Field A type	Field B type	Allowed and copy direction	Data CCSID or attributes		CCSIDs	Conversion translation performed
			Field A	Field B		
UTF16	DBCLOB	Y <—>	1200	Graphic	Different	Yes
UTF16	DBCLOB	Y <—>	1200	UCS2	Same	No
Binary character	BLOB	Y <—>	65535	65535	Same	No
Binary character	CLOB	Y <—>	65535	Character	Different	No
Binary character	CLOB	Y <—>	65535	Open	Different	No
Binary character	DBCLOB	N	65535	Graphic	Different	—
Binary character	DBCLOB	N	65535	UCS2	Different	—
Binary character	UTF-8	N	65535	1208	Different	—
Binary character	UTF-16	N	65535	1200	Different	—

The second table shows the mapping variable-length data types and large object.

Table 11. From-file and to-file mapping between variable-length data types and large objects

Field A type	Field B type	Allowed and copy direction	Data CCSID or attributes		CCSIDs	Conversion translation performed
			Field A	Field B		
VARLEN Character	BLOB	Y <—>	Character	65535	Different	No
VARLEN Open	BLOB	Y <—>	Open	65535	Different	No
VARLEN Either	BLOB	Y <—>	Either	65535	Different	No
VARLEN Only	BLOB	Y <—>	Only	65535	Different	No
VARLEN Graphic	BLOB	N	Graphic	65535	Different	—
VARLEN UCS2	BLOB	N	UCS2	65535	Different	—
VARLEN Character	CLOB	Y <—>	Character	Character	Same/Different	No/Yes
VARLEN Open	CLOB	Y <—>	Open	Character	Different	Yes
VARLEN Either	CLOB	Y <—>	Either	Character	Different	Yes
VARLEN Only	CLOB	Y <—>	Only	Character	Different	Yes
VARLEN Graphic	CLOB	N	Graphic	Character	Different	—
VARLEN UCS2	CLOB	Y <—>	UCS2	Character	Different	Yes
VARLEN Character	CLOB	Y <—>	Character	Open	Different	Yes

Table 11. From-file and to-file mapping between variable-length data types and large objects (continued)

Field A type	Field B type	Allowed and copy direction	Data CCSID or attributes		CCSIDs	Conversion translation performed
			Field A	Field B		
VARLEN Open	CLOB	Y <-->	Open	Open	Same/Different	No/Yes
VARLEN Either	CLOB	Y <-->	Either	Open	Different	Yes
VARLEN Only	CLOB	Y <-->	Only	Open	Different	Yes
VARLEN Graphic	CLOB	Y <-->	Graphic	Open	Different	Yes
VARLEN UCS2	CLOB	Y <-->	UCS2	Open	Different	Yes
VARLEN Character	DBCLOB	N	Character	Graphic	Different	-
VARLEN Open	DBCLOB	Y <-->	Open	Graphic	Different	Yes
VARLEN Either	DBCLOB	Y <-->	Either	Graphic	Different	Yes
VARLEN Only	DBCLOB	Y <-->	Only	Graphic	Different	Yes
VARLEN Graphic	DBCLOB	Y <-->	Graphic	Graphic	Same/Different	No/Yes
VARLEN UCS2	DBCLOB	Y <-->	UCS2	Graphic	Different	Yes
VARLEN Character	DBCLOB	Y <-->	Not 65535	UCS2	Different	Yes
VARLEN Open	DBCLOB	Y <-->	Not 65535	UCS2	Different	Yes
VARLEN Either	DBCLOB	Y <-->	Not 65535	UCS2	Different	Yes
VARLEN Only	DBCLOB	Y <-->	Not 65535	UCS2	Different	Yes
VARLEN Graphic	DBCLOB	Y <-->	Graphic	UCS2	Different	Yes
VARLEN UCS2	DBCLOB	Y <-->	UCS2	UCS2	Same/Different	No/Yes
VARLEN Character	DBCLOB	N	65535	UCS2	Different	-
VARLEN Open	DBCLOB	N	65535	UCS2	Different	-
VARLEN Either	DBCLOB	N	65535	UCS2	Different	-
VARLEN Only	DBCLOB	N	65535	UCS2	Different	-
VARLEN UTF8	BLOB	N	1208	65535	Different	-
VARLEN UTF8	CLOB	Y <-->	1208	Open	Different	Yes
VARLEN UTF8	DBCLOB	Y <-->	1208	Graphic	Different	Yes
VARLEN UTF8	DBCLOB	Y <-->	1208	UCS2	Different/Same	Yes/No
VARLEN UTF16	BLOB	N	1200	65535	Different	-
VARLEN UTF16	CLOB	Y <-->	1200	Open	Different	Yes
VARLEN UTF16	DBCLOB	Y <-->	1200	Graphic	Different	Yes
VARLEN UTF16	DBCLOB	Y <-->	1200	UCS2	Different/Same	Yes/No
VARLEN Binary character	BLOB	Y <-->	65535	65535	Same	No



Table 11. From-file and to-file mapping between variable-length data types and large objects (continued)

Field A type	Field B type	Allowed and copy direction	Data CCSID or attributes		CCSIDs	Conversion translation performed
			Field A	Field B		
VARLEN Binary character	CLOB	Y <—>	65535	Character	Different	No
VARLEN Binary character	CLOB	Y <—>	65535	Open	Different	No
VARLEN Binary character	DBCLOB	N	65535	Graphic	Different	—
VARLEN Binary character	DBCLOB	N	65535	UCS2	Different	—
VARLEN Binary character	UTF-8	N	65535	1208	Different	—
VARLEN Binary character	UTF-16	N	65535	1200	Different	—

### Related information

[Copy File \(CPYF\) command](#)

[Copy From Query File \(CPYFRMQRYP\) command](#)

### Copying files that contain identity columns or ROWID attributes

You can specify CRTFILE (\*YES) on the CPYF and CPYFRMQRYP commands when you copy files that contain identity columns or ROWIDs.

If the from-file is an SQL table, view, or index that contains an identity column or ROWID, these commands create an SQL table.

When you copy files that contain an identity column or the ROWID attribute, you can either supply a value or have the system generate a value for the field.

### Related information

[Copy File \(CPYF\) command](#)

[Copy From Query File \(CPYFRMQRYP\) command](#)

### Copying between different systems

You can use the Copy From Import File (CPYFRMIMPF) and Copy To Import File (CPYTOIMPF) commands to import (load) or export (unload) data to and from the IBM i platform.

### Using the Copy From Import File command to copy between different systems

The Copy From Import File (CPYFRMIMPF) command maps or parses the data from (import) an import file to the to-file.

Depending on what type of file the import file is, there are different steps to use when running CPYFRMIMPF.

The CPYFRMIMPF command also supports a parallel-data loader to copy information from an import file to a to-file using multiple threads during the copy operation. To use multiple threads, the system must have the i5/OS operating system option DB2 Symmetric Multiprocessing (SMP).

#### Notes<sup>®</sup> on the CPYFRMIMPF command

The authority needed to perform the copy using the CPYFRMIMPF command is similar to the authority requirements for all other copies.

The from-file can be any of the following type:

- A stream file
- A DDM file
- A tape file
- A source physical file
- A distributed physical file
- A program described physical file
- A single format logical file
- An externally described physical file with one field. The one field cannot be a numeric data type.

The to-file can be any of the following type:

- A source file
- A DDM file
- A distributed physical file
- A program described physical file
- An externally described physical file

The field definition file can be any of the following type:

- A source physical file
- A DDM file
- A program described physical file
- An externally described physical file with one field

The error file can be any of the following type:

- A source physical file
- A DDM file
- A program described physical file
- An externally described physical file with one field

**Note:** The format of the error file and from-file must be the same.

#### *Restrictions on the CPYFRMIMPF command*

There are certain restrictions that apply to the CPYFRMIMPF command.

- The data type of the from-file must be one of two types:
  - A source physical file
  - A physical file with one field with a data type of CHARACTER, IGC OPEN, IGC EITHER, IGC ONLY, GRAPHIC, fixed or variable length
- The copied records might have the same relative record numbers in the to-file as in the from-file.
- Create the to-file before copying.
- RCDDEL \*ALL finds the first occurrence of CRLF, LFCR, CR, or LF. This value will be used as the RCDDEL throughout the rest of the program.
- The to-file and from-file cannot be the same file.
  - If a record from the from-file cannot be imported, the process continues based on the Errors Allowed (ERRLVL) parameter. When ERRLVL(\*NOMAX) is defaulted or specified while the ERRRCDFILE parameter is being used, incorrect error records might be written to the ERRRCDFILE. This occurs for two reasons: record blocking is performed from ERRLVL(\*NOMAX) or because the copy might be using multiple tasks to perform the request. To avoid having the incorrect records appearing in the error record file, follow either of the following two suggestions: use the ERRLVL(\*NOMAX) parameter only after knowing the data can be copied correctly or specify a numeric value rather than \*NOMAX.

When specifying a numeric value, all the error records will be written to the ERRRCDFILE until the ERRVLV number is exceeded or the end of file is reached.

**Note:** Note that you will need to specify a high enough number in order for the CPYFRMIMPF to make it through the entire file.

- If the from-file is a source file, the system does not copy the first 12 bytes of the record (**Sequence** field and **Date** field). If the to-file is a source file, the system sets the first 12 bytes of the to-file's data (**Sequence** field and **Date** field) to zeros.

You can use this command on files that contain user-defined types (UDTs), user-defined functions (UDFs), identity columns, ROWIDs, and large objects (LOBs). You cannot use this command on files that contain datalinks.

Using the CPYFRMIMPF command with a JOBCCSID of 65535 might produce inaccurate or unpredictable results.

#### *Importing data to the IBM i platform when the from-file is a database file or DDM file*

You can use the Copy from Import File (CPYFRMIMPF) command to import data from a database file or DDM file.

To import data from a database file or DDM file, follow these steps:

1. Create an import file for the data that you are going to copy to an externally described file.

The import file can be a database source file, an externally described database file that has one field, or a program-described physical file. If the file has one field, the data type must be CHARACTER, IGC OPEN, IGC EITHER, IGC ONLY, or GRAPHIC, either in fixed length or in variable length. The record length of the import file needs to be long enough to contain the longest record of the file being sent to the system, including any delimiters.

2. Send the data to the import file or from-file.

Sending the data into the import file causes the necessary ASCII to EBCDIC data conversions to occur. There are several ways to import the data such as:

- TCP/IP file transfer (text transfer)
- System i<sup>®</sup> Access support (file transfer, ODBC)
- Copy From Tape (CPYFRMTAP) command (copy from tape file)

3. Create an externally described database file, or DDM file, which will contain the resultant data of the import file.

4. Use the CPYFRMIMPF command to copy (translate or parse the records) from the import file to the to-file.

For importing large files, you can choose to have the import file split-up into multiple parts so that each part can be processed in parallel on an n-way multiprocessor system.

#### **Related concepts**

##### Parallel data loader support to use with the Copy From Import File command

The Copy From Import File (CPYFRMIMPF) command supports copying the data in parallel from an import file to a to-file using multiple threads during the copy operation. With this support, you can copy data files from other platforms into a to-file. This is especially useful for those who use data warehousing. To use multiple threads, your system must have the i5/OS operating system option DB2 Symmetric Multiprocessing (SMP).

#### *Importing data to the IBM i platform when the import file is a stream file*

You can use the Copy from Import File (CPYFRMIMPF) command to import data from a stream file.

If the import file is a stream file, use the following steps for importing data to the IBM i platform:

1. Create an externally described database file, or DDM file, which will contain the resultant data of the import file.
2. Use the CPYFRMIMPF command to copy (translate or parse the records) from the import file to the to-file.

For importing large files, you can have the import file split-up into multiple parts. The multiple parts then process in parallel.

**Note:** Records are not copied in parallel when the from stream file (FROMSTMF) parameter is specified.

#### *Parallel data loader support to use with the Copy From Import File command*

The Copy From Import File (CPYFRMIMPF) command supports copying the data in parallel from an import file to a to-file using multiple threads during the copy operation. With this support, you can copy data files from other platforms into a to-file. This is especially useful for those who use data warehousing. To use multiple threads, your system must have the i5/OS operating system option DB2 Symmetric Multiprocessing (SMP).

The number of threads you use during the copy operation is determined by the DEGREE(\*NBRTASKS) parameter of the [Change Query Attributes \(CHGQRYA\)](#) command. If the from-file has less than 50 000 records, only one job is used regardless of the \*NBRTASKS value.

The [CPYFRMIMPF](#) command (with the parallel data loader support) essentially breaks the import file into smaller portions or blocks. Each of these smaller portions is submitted in parallel, so the entire file processes at the same time. (This eliminates the latency of sequential processing.)

To maintain the same relative record numbers of the from-file in the to-file, use only one job for the copy. Specify DEGREE(\*NONE).

**Note:** Records are not copied in parallel when the from stream file (FROMSTMF) parameter is specified.

#### **Related tasks**

[Importing data to the IBM i platform when the from-file is a database file or DDM file](#)

You can use the Copy from Import File (CPYFRMIMPF) command to import data from a database file or DDM file.

#### *Handling data from the import file*

The Copy From Import File (CPYFRMIMPF) reads data from an import file and copies the data to a to-file. The data of the import file can be formatted by delimiters or in a fixed format.

“[Notes on the delimited import file \(CPYFRMIMPF command\)](#)” on page 62 has a series of characters (delimiters) that define where fields begin and end. The parameters of the command define which characters are used for delimiters.

“[Fixed formatted import file](#)” on page 65 requires the user to define a Field Definition File that defines the format of the import file. The Field Definition File defines where fields begin, end, and are null.

#### **Related concepts**

[Using the Copy To Import File command to copy between different systems](#)

The Copy To Import File (CPYTOIMPF) command copies the data from the from-file (typically a database file) to an import file.

#### **Related information**

[CPYFRMIMPF command](#)

#### *Notes on the delimited import file (CPYFRMIMPF command)*

The characters and data types discussed in this topic interpret the import file's data for a delimited import file.

#### **Blanks**

Blanks are treated in the following ways:

- All leading blanks and trailing blanks are discarded for character fields unless enclosed by string delimiters, according to the RMVBLANK parameter.
- A field of all blanks is interpreted as a field of one single blank character unless RMVBLANK \*NONE is specified.
- You cannot embed blanks inside numeric data.
- You cannot select a blank as a field or record delimiter.

The RMVBLANK parameter has the following options:

- \*NONE: All leading and trailing blanks are retained.
- \*LEADING: Leading blanks are removed. This is the default value.
- \*TRAILING: Trailing blanks are removed.
- \*BOTH: Leading and trailing blanks are removed.

**Note:** Removal of blanks, as specified by the RMVBLANK parameter, takes precedence over string delimiters.

### Null fields

A null field can be defined as follows:

- Two adjacent field delimiters (no data in between).
- Two adjacent string delimiters (no data in between).
- A field delimiter followed by a record delimiter (no data in between), an empty string.

If the field is null, the following statement is true:

- If the record's output field is not nullable and the import is a null field, the record is not to be copied, and an error is signaled.

### Delimiters

- A field delimiter can not be the same as a record delimiter.
- A field or record delimiter cannot be a blank.
- A string delimiter can enclose all fields when the string escape character STRESCCHR(\*NONE) is specified. The string delimiter character should not be contained within the character string.
- A string delimiter can not be the same as a record delimiter.
- A string delimiter or a string escape character cannot be the same as a field delimiter, a record delimiter, a decimal point, a date separator, or a time separator.
- If the data type of the from is CHARACTER, OPEN, EITHER, or ONLY, all double byte data must be contained within string delimiters or shift characters (for OPEN, EITHER, ONLY data type).

**Note:** String delimiters have lower precedence than leading blanks and trailing blanks.

- The defaults for delimiters are as follows:
  - String is: \*DBLQUOTE (double quotation mark)
  - Field is: , (comma)
  - Decimal separator is: . (period)
  - Record is: \*EOR (end of record)
- When a string delimiter character is contained by a string, precede the string delimiter in the string with the string escape character specified with the STRESCCHR parameter.

### String escape character

When a string delimiter character is contained by a string, you can use the STRESCCHR parameter to specify a string escape character for indicating that the string delimiter character should be treated as a normal character instead of string delimiter.

The STRESCCHR parameter has the following options:

- \*NONE: No string escape character is used.
- \*STRDLM: The string delimiter is used as the string escape character.
- *character-value*: The *character-value* is used as the string escape character.

### Numeric field

- Numeric fields can be imported in decimal or exponential form.
- Data to the right of the decimal point might be truncated depending on the output data format.

- Decimal separators are either a period or a comma (command option).
- Signed numeric fields are supported, + or -.

### **Character or Varcharacter fields**

- Fields too large to fit in the output fields are truncated. The system sends a diagnostic message.
- An empty string is defined as two string delimiters with no data between them.
- For the system to recognize a character as a starting or ending string delimiter, it must be the first or last character in the field after the RMVBLANK option has been applied. For example, 'abc' using the single quotation mark (') as the delimiter is the same as abc.

### **IGC or VarIGC fields**

- The system copies data from the from-file to the to-file. If any of the data is not valid, the system generates a mapping error.
- Data located between the shift out and shift in characters is treated as double-byte data. This data is also not parsed for delimiters. The shift characters in this case become "string delimiters".

### **Graphic, VarGraphic fields**

The system copies the data from the from-file to the to-file.

### **CCSIDs**

- The data from the from-file is read into a buffer by the CCSID of the from-file. The data in the buffer is checked and written to the to-file. The CCSID of the open to-file is set to the value of the from-file, unless a to-file CCSID is used.

If a to-file CCSID is used, the data is converted to that CCSID. If the CCSID of the to-file field is 65535, the data is converted to the CCSID specified in the TOCCSID parameter.

If the from-file is a tape file, and the FROMCCSID(\*FILE) is specified, the following limits apply:

- The job CCSID is used
- The from-file CCSID is requested by the user
- The character data (delimiters) passed on the command are converted to the CCSID of the from file. This allows the character data of the from-file and command parameters to be compatible.

### **Date field**

- All date formats supported by the IBM i operating system can be imported (\*ISO, \*USA, \*EUR, \*JIS, \*MDY, \*DMY, \*YMD, \*JUL, and \*YYMD).
- You can copy a date field to a timestamp field.

### **Time field**

- All time formats supported by the IBM i operating system can be imported (\*ISO, \*USA, \*EUR, \*JIS, \*HMS).
- You can copy a time field to a timestamp field.

### **Date and time separators**

The system supports all valid separators for date and time fields.

### **Timestamp field**

Timestamp import fields must be 26 bytes. The import ensures that periods exist in the time portion, and a dash exists between the date and time portions of the timestamp.

### **LOB field**

LOB data fields require using secondary stream files that contain the LOB data. The imported data file lists the name of the stream file containing the LOB data. The Field Definition File (FDF) that describes the offsets of the fields in the data file, also describes the offsets of the LOB file name field (not the LOB field itself).

An example of importing LOB data:

FDf file:

```
COLCHAR10      1      10      42
COLLOB         12      40      44
*END
```

The data file would be 44 characters in record length, containing the following data:

```
0      1      2      3      4
12345678901234567890123456789012345678901234
aaaaaaaaaa /lobdata/lob1.dat      N N
bbbbbb /lobdata/lob2.dat      N N
        /lobdata/lob3.dat      Y N
cccccccc      N Y
```

**Notes:** For each record in the imported data file:

1. Characters 1–10 are data for a column named COLCHAR10, with the null indicator at byte position 42.
2. Characters 12–40 are data for a column named COLLOB, with the null indicator at byte position 44. The COLLOB value is the name of the file which contains the LOB data.
3. In this example, there are 3 data files (lob1.dat, lob2.dat, and lob3.dat) which contain the actual LOB data to be imported.

### Number of fields mismatch

If the from-file or to-file do not have the same number of fields, the data is either truncated to the smaller to-file size, or the extra to-file fields will receive a null value. If the fields cannot contain null values, the issues an error message.

### Multiple threads

The number of threads that are used to copy the data depends on the DEGREE(\*NBRTASKS) parameter of the CHGQRYA command. When multiple threads are used, the application uses batch threads to copy the data. The user can change, hold, or end these batch threads. The copy operation does not complete until all the started batch threads complete.

The relative record numbers can be maintained only if a single thread is used and the import file does not contain any deleted records. If the from-file is a distributed physical file or logical file, the system performs the copy operation in a single process.

Files with less than 50 000 records use only one job.

### Fixed formatted import file

This topic gives an example of a Field Definition File that describes the fixed formatted file.

```
- *****/
- ****      Field Definition File      */
- *****/
- Description: This Field Definition File
- defines the import's file      */
- (FROMFILE) field start and end positions.      */
- *****/
- (FROMFILE) field start and end positions.      */
-FILE MYLIB/MYFILE      */
field1  1  12  13
field2  14  24  0
field3  25  55  56
field4  78  89  90
field5  100 109  0
field6  110 119 120
field7  121 221  0
*END
```

The following is a brief explanation of the Field Definition File format:

- = Comment line
- \*END = End of definition, this must be included

Field	Starting	Ending	Null
-------	----------	--------	------

Name	Position	Position	Character Position
field1	1	12	13
field2	14	24	None
field3	25	55	56
field4	78	89	90
field5	100	109	None
field6	110	119	120
field7	121	221	None

### Field Name

This name is the name of the to-file field name.

### Starting Position

This is the starting position for the field in the import file of each record. This is the byte position.

### Ending Position

This is the ending position for the field in the import file of each record. This is the byte position.

### Null Character Position

This is the position for the NULL value for the field in the import file of each record. The value zero specifies that NULL does not have a value. The value in the import file can be 'Y' or 'N'.

'Y' means the field is NULL. 'N' means the field is not NULL.

Each column must be separated by a blank character.

Each row must be sequentially ordered.

An alternative for creating the Field Definition File is using the \*COL keyword instead of the actual column names. \*COL indicates the positions of the data in the stream file for all the columns in the target files listed in order. The following example shows how to describe fixed formatted files using the \*COL keyword:

```
*COL 1 12 13
*COL 14 24 0
*COL 25 55 56
*COL 78 89 90
*COL 100 109 0
*COL 110 119 120
*COL 121 221 0
*END
```

### Improving the performance of the CPYFRMIMPF command

To improve the performance of the CPYFRMIMPF command, follow these steps.

1. Delete any logical keyed files based on the TOFILE.
2. Remove all constraints and triggers of the TOFILE.
3. Ensure the FROMFILE records will be copied correctly by attempting to copy a few of the records. Copy a few of the records using the FROMRCD and number of records option.
4. Use the ERRLLVL(\*NOMAX) parameter after you know you can copy the data correctly.
5. When the ERRLLVL(\*NOMAX) parameter is used, record blocking increases performance.

If an error in writing a record occurs during record blocking, the number of records listed as being copied in the completion message, CPC2955, might not be accurate.

### Using the Copy To Import File command to copy between different systems

The Copy To Import File (CPYTOIMPF) command copies the data from the from-file (typically a database file) to an import file.

You can then move the import file (or file to be exported) to your platform by any method, such as TCP/IP file transfer (text transfer), System i Access support (file transfer, ODBC), or the [Copy To Tape File \(CPYTOTAP\)](#) command. Your system then handles the data from the import file.



You can also specify a stream file, and the [CPYTOIMPF](#) command will copy the data to the stream file.

## **Related concepts**

### Handling data from the import file

The Copy From Import File (CPYFRMIMPF) reads data from an import file and copies the data to a to-file. The data of the import file can be formatted by delimiters or in a fixed format.

### *Notes on the Copy to Import File command*

The Copy to Import File (CPYTOIMPF) command reads data from a user from-file and copies it into an import file. The number of jobs used for copy is one. The data of the import file can be formatted by delimiters or it can be in a fixed format.

“Notes on the delimited import file (CPYTOIMPF command)” on page 68 has a series of characters (delimiters) that are used to define where fields begin and end. See “Restrictions for the Copy to Import File command” on page 67 for more information.

The parameters of the command define which characters are used for delimiters. A fixed format import file uses a fixed format. For more information, see “Copying data to the import file in a fixed format (CPYTOIMPF command)” on page 69.

The data in the from-file is read from the formatted database file and written to the import file with the parameters from the command.

If a user profile exists for the same library name that is being copied from, at least one of the following authority will be needed:

- The system authority \*ADD to the user profile with that name.
- Administrative authority

The from-file can be any of these:

- A source physical file
- A program described physical file
- A distributed physical file
- A single format logical file
- An externally described physical file

The to-file can be any of these:

- a stream file
- a source physical file
- a program described physical file
- a distributed physical file with one non-numeric field
- an externally described physical file with one non-numeric field

## **Related information**

### CPYTOIMPF command

### *Restrictions for the Copy to Import File command*

There are certain restrictions apply to the CPYTOIMPF command.

- The command restricts the correct usage for delimiters.
- The data type of a database file for the to-file can be any of the following types:
  - CHARACTER, IGC OPEN, IGC EITHER, IGC ONLY, GRAPHIC, or variable length. Its length must be capable of containing the data of the from-file, separators, and any data conversions.
  - The to-file and from-file cannot be the same file.
  - The from-file cannot be a multi-formatted logical file.
- If the to-file's record length is not long enough, an error is signaled.

- IGCDDTA is not supported for the CPYTOIMPF command.

You can use this command on files that contain user-defined types (UDTs) and user-defined functions (UDFs). You cannot use this command on files that contain large objects (LOBs) or DataLinks (DLs).

Using the CPYTOIMPF command with a JOBCCSID of 65535 might produce inaccurate or unpredictable results.

### Related information

#### [CPYTOIMPF command](#)

#### *Notes on the delimited import file (CPYTOIMPF command)*

This topic contains information about using the CPYTOIMPF command with delimited import files.

### Blanks

You can use the RMVBLANK parameter to handle blank characters from the character fields. The RMVBLANK parameter has the following options:

- \*NONE: All leading and trailing blanks are retained.
- \*LEADING: Leading blanks are removed. This is the default value.
- \*TRAILING: Trailing blanks are removed.
- \*BOTH: Leading and trailing blanks are removed.

**Note:** Removal of blanks, as specified by the RMVBLANK parameter, takes precedence over string delimiters.

### Null fields

If a field is null, the field contains two adjacent field delimiters (no data in between).

### Delimiters

- A delimiter cannot be a blank.
- A string delimiter or a string escape character cannot be the same as a field delimiter, a record delimiter, a decimal point, a date separator, or a time separator.
- A field delimiter cannot be the same as a record delimiter.
- When a string delimiter character is contained by a string, precede the string delimiter in the string with the string escape character specified with the STRESCCHR parameter.
- The defaults for delimiters are as follows:
  - String is: \*DBLQUOTE (double quotation mark)
  - Field is: , (comma)
  - Decimal point is: . (period)
  - Record is: \*EOR (end of record)

### String escape character

When a string delimiter character is contained by a string, you can use the STRESCCHR parameter to specify a string escape character for indicating that the string delimiter character should be treated as a normal character instead of string delimiter.

The STRESCCHR parameter has the following options:

- \*NONE: No string escape character is used.
- \*STRDLM: The string delimiter is used as the string escape character.
- *character-value*: The *character-value* is used as the string escape character.

### Numeric fields

Decimal points are either a period or a comma (command option).

### Graphic fields

The string delimiter is placed around all graphic data. If graphic data is contained in the file and the string delimiter is the \*NONE value, an error is signaled.

### All fields

The CAST function in SQL copies the data from the from-file to the to-file. All data is copied and the relative record numbers of the from-file and to-file are the same, unless the from-file contains deleted records. Deleted records are not copied.

### CCSIDs

The data from the from-file is read into the to-file's CCSID.

If the CCSID of the from-file field is 65535, the data will be converted from the CCSID specified in the FROMCCSID parameter.

The Stream file CCSID (STMFCCSID) parameter is used to specify the method of obtaining the stream file CCSID according to the code page that is used for data conversion. This parameter can be used to replace the Stream file code page (STMFCODPAG) parameter.

### Date fields

All date formats supported by the IBM i operating system can be exported (\*ISO, \*USA, \*EUR, \*JIS, \*MDY, \*DMY, \*YMD, \*JUL, \*YYMD).

### Time fields

All time formats supported by the IBM i operating system can be exported (\*ISO, \*USA, \*EUR, \*JIS, \*HMS).

### Date and time separators

All valid separators are supported for date and time fields.

### Timestamp fields

Timestamp export fields must be 26 bytes.

#### *Copying data to the import file in a fixed format (CPYTOIMPF command)*

When you copy data to the import file in a fixed format (DATFMT(\*FIXED)), each field of the file is copied. A null indicator on the command NULLS(\*YES) places either a 'Y' or 'N' following the field data in the to-file indicating if the field is null or not.

The Numeric field pad (NUMFLDPAD) parameter specifies whether numeric data fields need to be padded with blanks or zeros to fill its fixed length in the to-file.

## Opened files

When you want an application to use a file, you do so by referring to that file by name. The file description for that file then controls how the program and the system interact.

You have two options regarding how your application program uses the file description:

- You can use the file description as it currently exists. In this case, the system uses the file description as is, without any change.
- You can change some or all of the parameters that are associated with the file description. A change made to a file description can be permanent or temporary. See the appropriate book for the device that you are using for information about permanent changes.

### Related concepts

#### File types

The file management functions support these types of files.

## Scope of opened files

Files that are opened within the user default activation group are scoped to the call level number of the calling program (default).

A *call level number* is a unique number that the system assigns to each call stack entry. Files that are opened within a named activation group are scoped to the activation group level (default).

You can change the scope of an open operation by using override commands. For example, you can change the scope of an open operation to the job level.

## Related concepts

### Overrides

You can use overrides to temporarily change a file name, a device name associated with the file, or some of the other attributes of a file.

### Displaying information about open files

You can display information about your open files by typing `dspjob option(*opnf)` on any command line and press Enter, or by typing `wrkjob option(*opnf)` on any command line and press Enter.

## Opening files using temporary file descriptions

Temporary changes can provide greater flexibility to the application. The system makes temporary changes when the program is first establishing a path to the file by opening the file.

Temporary changes can be made in one of the following ways:

- By information that is specified within the program itself, and which is passed as parameters on the open operation.
- By using override CL commands in the input stream that is used to set up the runtime environment for the application

The ability to use the first way depends very much on which programming language you used to write the program. Some programming languages do not allow you to control the open process to any great extent. These languages do the open process more or less automatically and control what information gets passed. Other languages allow you to have greater control over the open process.

You can use the second option regardless of which programming language you use. The IBM i operating system provides override CL commands for each file type. By including override commands with the application, you can temporarily change the file description in a file that the program wants to use.

You can use both options together. Information that is contained in the application can change some parameters; an override command can change others. Both can change the same parameter. The operating system follows this order when making temporary changes to a file:

1. The file description provides a base of information.
2. Change information received from the application during the open process is applied first to the base information.
3. Change information found in the override command is applied last. If both the change information from the application and the override change the same information, the override has precedence.

Only the application that makes the changes can see the temporary changes. The file, as seen by another application, remains unchanged. In fact, two applications can use the same file at the same time, and each can change it temporarily according to its needs. Neither application is aware the other has made a temporary change. [Figure 1 on page 71](#) and [Figure 2 on page 72](#) illustrate the permanent and temporary change processes.

Before Change

After Change

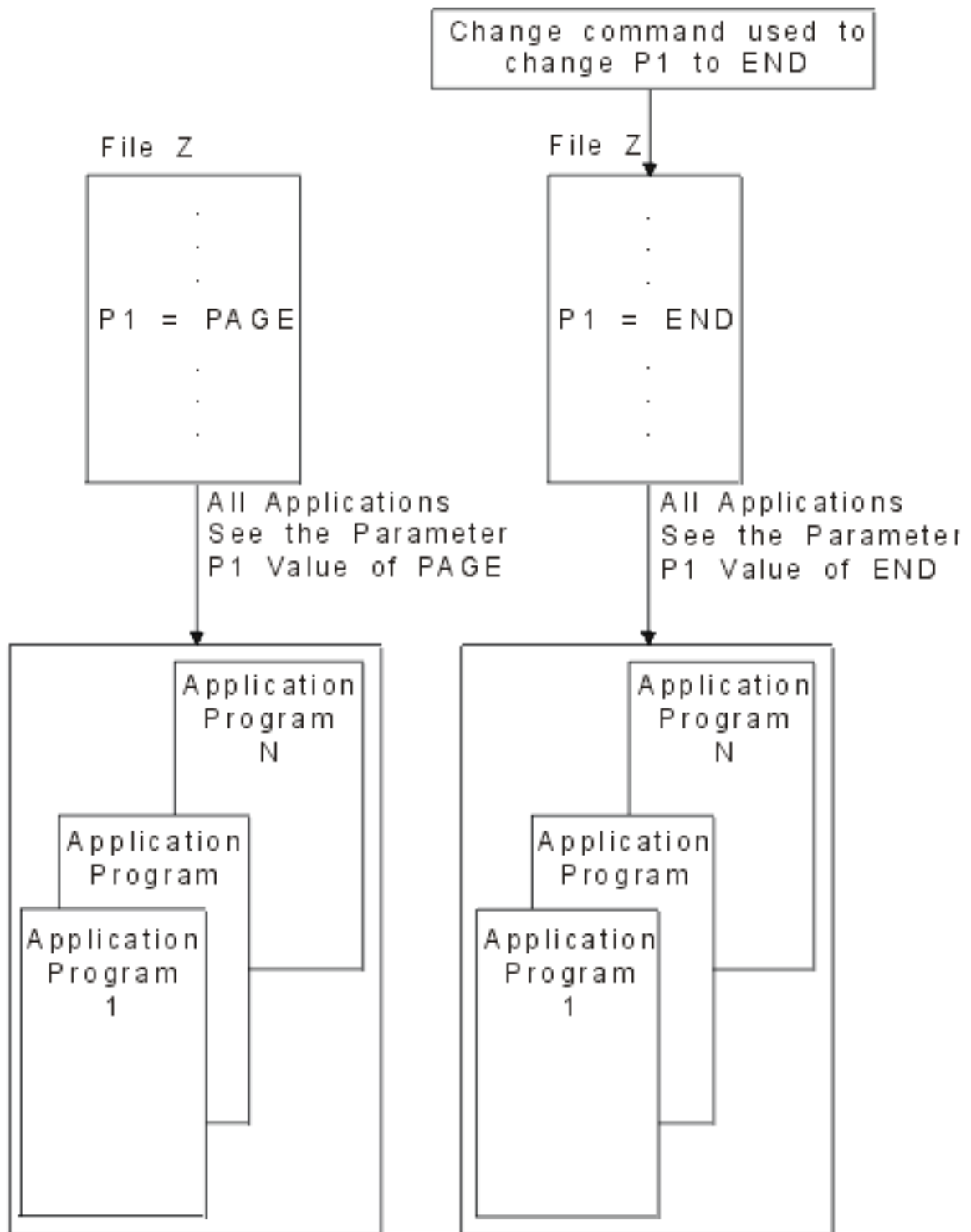

Figure 1. Permanently changing a file

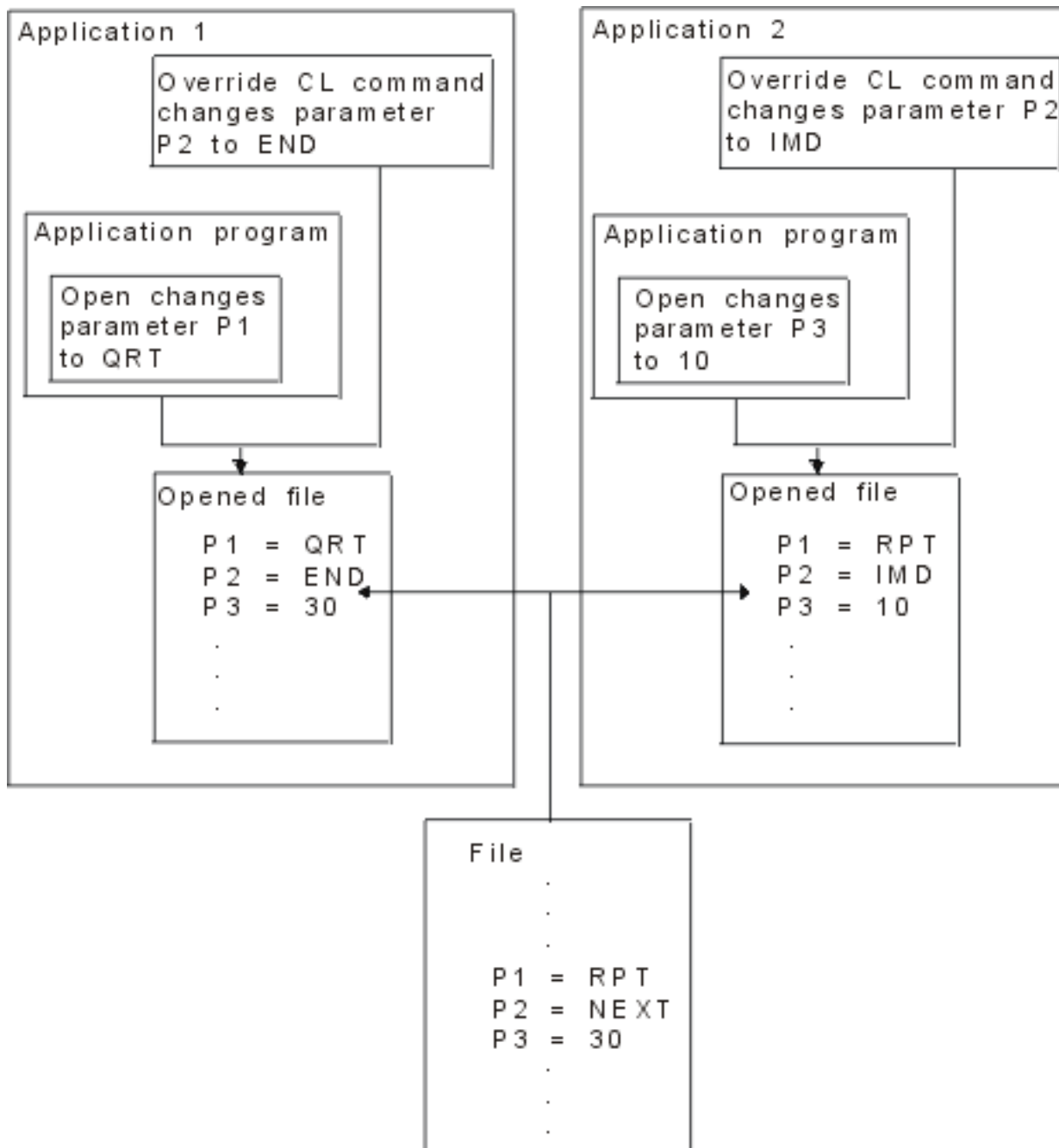

Figure 2. Temporarily changing a file

Once an application establishes a connection between itself and the file by opening the file, it can then proceed to use the file for either input or output operations. In the case of a database file, the open process establishes a path between the application and the actual database file. For device files, a path is established between the application and the actual device, or to a spooled file if the spooling attribute is active for the device file. In all cases, the application connects to what it wants to use, and those connections determine what input or output operations are valid. Not all operations are valid with all file types. The application must be aware of what file types it uses and then use only those operations which are valid for those types.

## Detection of file description changes

When a program that uses externally described files is compiled, the high-level language compiler extracts the record-level and field-level descriptions for the files referred to in the program and makes those descriptions part of the compiled program.

When you run the program, you can verify that the descriptions with which the program was compiled are the current descriptions.

The system assigns a unique level identifier for each record format when it creates the associated file. The system uses the following information to determine the level identifier:

- Record format name
- Field name
- Total length of the record format
- Number of fields in the record format
- Field attributes (for example, length and decimal positions)
- Order of the field in the record format

**Note:** It is possible for files with large record formats (many fields) to have the same format level identifiers even though their formats might be slightly different. Problems can occur when copying these files if the record format names of the from-file and the to-file are the same.

Display, printer, and ICF files can also use the number of and order of special fields called indicators to determine the level identifier.

If you change the DDS for a record format and change any of the items in the preceding list, the level identifier changes.

To check the record format identifiers when you run the program, specify LVLCHK(\*YES) on the create file or change file commands.

The level identifiers of the file and the file description that is part of the compiled program are compared when the file is opened and the LVLCHK(\*YES) parameter is specified. The system does a format-by-format comparison of the level identifiers. If the identifiers differ or if any of the formats that are specified in the program do not exist in the file, a message is sent to the program to identify the condition.

When the identifiers differ, this means that the file format has changed. If the changes affect a field that your program uses, you must compile the program again for it to run properly. If the changes do not affect the fields that your program uses, you can run the program without compiling again by entering an override command for the file and specifying the LVLCHK(\*NO) parameter. Specifying the LVLCHK(\*NO) parameter causes the system to omit the level identifier check when the file opens. For example, suppose that you add a field to the end of a record format in a database file, but the program does not use the new field. You can enter the [Override with Database File \(OVRDBF\)](#) command with the LVLCHK(\*NO) parameter so that the program can run without compiling again.

There are several CL commands available to you to check the changes. You can use the Display File Field Description (DSPFFD) command to display the record-level and field-level descriptions or, if you have the source entry utility (SEU), you can display the source file containing the DDS for the file. You can display the format level identifier that is defined in the file by using the [Display File Description \(DSPFD\)](#) or the [Display File Field Description \(DSPFFD\)](#) commands. The format level identifier which was used when the program was created can be displayed by the [Display Program References \(DSPPGMREF\)](#) command.

There are also some changes to a file description that will not cause an error when the file opens. These happen because the record format identifiers did not change or because your program does not use the changed formats. You can add or remove formats from a file without affecting existing programs that do not use the added or deleted formats.

Even though the level identifier does not change, some DDS functions that you add or delete can require changes in the logic of your program. You should review the functions you added or deleted to determine whether the program logic requires changes.

Normally, the use of LVLCHK(\*YES) is a good file integrity practice. The use of LVLCHK(\*NO) can produce unpredictable results.

## Displaying information about open files

You can display information about your open files by typing `dspjob option(*opnf)` on any command line and press Enter, or by typing `wrkjob option(*opnf)` on any command line and press Enter.

The following screen then displays:

```

                                Display Open Files
Job . . . : QPADEV0027      User . . . : KELLYMR      Number . . . : 032138
Number of open data paths . . . . . : 2

File      Library  Device      Member/
          QSYS    QPADEV0027 *ACTGRPDFN 0000000002 *DFTACTGRP
QDUI80
QDDSP0F   QSYS    QPADEV0027 *ACTGRPDFN 0000000002 *DFTACTGRP

Press Enter to continue.

F3=Exit   F5=Refresh  F10=Display I/O details  F12=Cancel  F16=Job menu
```

The **Scope** column identifies the level to which the open is scoped. \*ACTGRPDFN indicates that the open is scoped to the activation group level. If the file opened in the user default activation group, the open is scoped to the call level number of the calling program. If the file opened in a named activation group, the open is scoped to the activation group level. \*JOB indicates that the open is scoped to the job level. You can change the scope of an open operation by using override commands.

The **Activation Group** column identifies the number and name of the activation group. \*DFTACTGRP indicates the default activation group.

### Related concepts

#### Scope of opened files

Files that are opened within the user default activation group are scoped to the call level number of the calling program (default).

#### Overrides

You can use overrides to temporarily change a file name, a device name associated with the file, or some of the other attributes of a file.

## Monitoring file status with the open and I/O feedback area

The system monitors the status of a file in feedback areas after it opens the file.

As the system performs operations on a file, it updates the feedback areas to reflect the latest status. These feedback areas give you greater control over applications and provide important information when errors occur. The feedback areas are established at open time, and there is one feedback area for each open file. One exception is for shared files, which share feedback areas as well as the data path between the program and the file.

With some high-level languages on the system, you can access the status and other information about the file against which operations are performed. These feedback areas are of interest to you:

- Open feedback area



This area contains information of a general nature about the file after the system has successfully opened the file. Examples include the name and library of the file and the file type. The open feedback area information contains a complete list of the information that you can retrieve from the open feedback area. In addition to general information about the file, the open feedback area also contains file-specific information after the system has successfully opened the file. The applicable fields depend on the file type.

The open feedback area also contains information about each device or communications session that is defined for the file.

- **Input/output feedback area**

There are two sections of the I/O feedback area that are updated on the successful completion of input and output operations:

- **Common area**

This area contains information about I/O operations that were performed on the file. This includes the number of operations and the last operation performed. The I/O feedback area information contains a complete list of the information that you can retrieve from the common I/O feedback area.

- **File-dependent feedback area**

This area contains file-specific information for display, database, printer, and ICF files; for example, the major and minor return code and the amount of data received from the device. The I/O feedback area for ICF and display files, I/O feedback area for printer files, and I/O feedback area for database files information contain a complete list of the information that you can retrieve from the file-dependent I/O feedback area.

The above information areas can be useful to you. For example, when an error occurs with a device file, the program can determine predefined error handling operations based on the major/minor return code in the file-dependent feedback area. If data is being received from a communications device and the application on the other end sends an error, the program can determine that the next operation should be to wait until the next block of data is sent indicating the error. Possibly, the next operation might be to close the file and end the conversation with the application on the other side or wait for the next request from the application.

Another way might include detecting the type of file that actually opened to determine the type of operations that are allowed. If the file type is printer, only output operations are allowed.

## **Related concepts**

### Shared files

File management on the IBM i operating system provides several levels of support for shared files. Files can be shared among many users, many jobs, or many programs within the same job.

## **Related reference**

### Open feedback area

The open feedback area is the part of the open data path (ODP) that contains general information about the file after it has been opened. It also contains file-specific information, depending on the file type, plus information about each device or communications session defined for the file. This information is set during open processing and can be updated as other operations are performed.

### I/O feedback area

The IBM i operating system uses messages and I/O feedback information to communicate the results of I/O operations to the program.

### I/O feedback area for ICF and display files

The table in this topic shows the I/O feedback area for ICF and display files.

### I/O feedback area for printer files

The table in this topic shows the I/O feedback area for printer files.

## Shared files

File management on the IBM i operating system provides several levels of support for shared files. Files can be shared among many users, many jobs, or many programs within the same job.

The system automatically provides the first level of support. By default, the system lets multiple users and multiple jobs use one file at the same time. The system allocates the file and its associated resources for each use of the file in such a way that it can prevent conflicting uses. Within the same job, programs can share files if one program opens the same file more than once or if different programs open the same file. Even though the same file is being used, each open operation creates a new path from the program to the data or device so that each open operation represents an independent use of the file.

### Open data path

A closer level of sharing within a job allows more than one program to share the same path to the data or device. This path, called an *open data path*, is the path through which all of the read and write operations for the file are performed. You can use this level of sharing by specifying the SHARE parameter on the create file, change file, and override file commands. The SHARE parameter allows more than one program to share the file status, positions, and storage area. It can improve performance by reducing the amount of main storage the job needs and by reducing the time it takes to open and close the file. The IBM i operating system bases this level of sharing on two models:

- The *original program model* is the set of functions for compiling source code and creating high-level language programs on the system before the Integrated Language Environment® (ILE) model was introduced.
- The *ILE model* is the set of constructs and interfaces that provide a common runtime environment and runtime bindable application programming interface (APIs) for all ILE-conforming high-level languages.

### Shared files in the original program model

In the original program model, the SHARE(\*YES) parameter lets two or more programs that run in the same job share an open data path (ODP). It connects the program to a file. If not specified otherwise, every time a file is opened a new open data path is built. You can specify that if a file is opened more than once and an open data path is still active for it in the same job, the active ODP for the file can be used with the current open of the file; a new open data path does not need to be created. This reduces the amount of time that is required to open the file after the first opened to open the file after the first open, and the amount of main storage that is required by the job. You must specify SHARE(\*YES) for the first open and other opens of the same file to share the open data path. A well-designed (for performance) application will normally do a shared open on database files that multiple programs will open in the same job. Specifying SHARE(\*YES) for other files depends on the application.

### Shared files in the ILE model

In the ILE model, shared files are scoped either to the job level or to the activation group level. An *activation group* is a substructure of a runtime job. It consists of system resources (storage for program or procedure variables, commitment definitions, and open files) that are allocated to one or more programs. An activation group is like a miniature job within a job.

Any programs that run in any activation group can share shared files that are scoped to the job level. Only programs that run in the same activation group can share shared files that are scoped to the activation group level.

### Shared files: Considerations

Sharing files allows you to have programs within a job interact in ways that would otherwise not be possible. However, you need to understand the effects of opening, performing read and write operations, and closing shared files.

You should also see the appropriate documentation for all of the file types to understand how this support works, and the rules your programs must follow to use it correctly.

**Note:** Most high-level language programs process an open or a close operation independent of whether the file is being shared. You do not specify that the file is being shared in the high-level language program. You indicate that the file is being shared in the same job through the SHARE parameter. You specify the SHARE parameter only on the CREATE, CHANGE, and OVERRIDE file commands. Refer to your appropriate language information for more information.

### **Related concepts**

#### File types

The file management functions support these types of files.

#### Monitoring file status with the open and I/O feedback area

The system monitors the status of a file in feedback areas after it opens the file.

## **Open considerations for files shared in a job**

There are certain points to consider when you open a shared file in the same job by specifying SHARE(\*YES).

- You must make sure that when the shared file is opened for the first time in a job, all the open options that are needed for subsequent opens of the file are specified. If the open options specified for subsequent opens of a shared file do not match those specified for the first open of a shared file, an error message is sent to the program. (You can correct this by making changes to your program to remove any incompatible options.)

For example, PGMA is the first program to open FILE1 in the job and PGMA only needs to read the file. However, PGMA calls PGMB which will delete records from the same shared file. Because PGMB will delete records from the shared file, PGMA must open the file as if it, PGMA, is also going to delete records. You can accomplish this by using the correct specifications in the high-level language. (In order to accomplish this in some high-level languages, you might need to use file operation statements that are never run. See your appropriate language information for more details.)

- Sometimes sharing a file within a job is not possible. For example, one program might need records from a file in arrival sequence, and another program might need the records in keyed sequence. Or, you might use the same file for printing output, but want to produce the output from each program separately. In these situations, you should not share the open data path. You would specify SHARE(\*NO) on the override command to ensure that programs do not share the file within the job.
- If debug mode is entered with UPDPROD(\*NO) after the first open of a shared file in a production library, subsequent shared opens of the file share the original open data path and allow the file to be changed. To prevent this, specify SHARE(\*NO) on the OVERRIDE command before opening files while debugging your program.
- The use of commitment control for the first open of a shared file, requires that all subsequent shared opens also use commitment control.
- If you do not specify a library name in the program or the OVERRIDE command (\*LIBL is used), the system assumes that the library list has not changed since the last open operation of the same shared file with \*LIBL specified. If the library list has changed, specify the library name on the OVERRIDE command to ensure that you opened the correct file.
- The system processes overrides and program specifications that are specified on the first open operation of the shared file. Overrides and program specifications that are specified on subsequent open operations, other than those that change the file name or the value specified on the SHARE or LVLCHK parameters on the OVERRIDE command, are ignored.

## I/O considerations for files shared in a job

The system uses the same input/output area for all programs sharing the file, so the order of the operations is sequential regardless of which program does the operation.

For example, if Program A is reading records sequentially from a database file and it reads record 1 just before calling Program B, and Program B also reads the file sequentially, Program B reads record 2 with the first read operation. If Program B then ends and Program A reads the next record, it receives record 3. If the programs were not sharing the file, Program A would read record 1 and record 2, and Program B would read record 1.

For device files, the device remains in the same state as the last I/O operation.

For display and ICF files, programs other than the first program that opens the file can acquire more display or program devices or release display or program devices already acquired to the open data path. All programs sharing the file have access to the newly acquired devices, and do not have access to any released devices.

## Close considerations for files shared in a job

The processing done when a program closes a shared file depends on whether other programs currently share the open data path.

If there are other programs, the main function that is performed is to detach from the file the program that is requesting the close. For database files, the program also releases any record locks that it holds. The program will not be able to use the shared file unless it opens it again. All other programs sharing the file are still attached to the ODP and can perform I/O operations.

If the program closing the file is the last program sharing the file, then the close operation performs all the functions it would if the file had not been opened with the share option. This includes releasing any allocated resources for the file and destroying the open data path.

The function provided by this last close operation is the function that is required for recovering from certain runtime errors. If your application is written to recover from such errors and it uses a shared file, this means that all programs that are attached to the file when the error occurs must close the file. This might require returning to previous programs in the call stack and closing the file in each one of those programs.

## Overrides

You can use overrides to temporarily change a file name, a device name associated with the file, or some of the other attributes of a file.

Overrides allow you to make minor changes in how a program functions. Overrides allow you to select the data, on which they operate, without recompiling the program. These topics explain how to use overrides.

### Related concepts

#### [Scope of opened files](#)

Files that are opened within the user default activation group are scoped to the call level number of the calling program (default).

#### [Displaying information about open files](#)

You can display information about your open files by typing `dspjob option(*opnf)` on any command line and press Enter, or by typing `wrkjob option(*opnf)` on any command line and press Enter.

## Overview: Overrides

An *override* is a CL command that temporarily changes a file name, a device name, or remote location name associated with the file, or some of the other attributes of a file.

You can enter override commands interactively from a display station or submit them as part of a batch job. You can include them in a control language (CL) program, or issue them from other programs by calling the program QCMDEXC. Regardless of how they are issued, overrides remain in effect only for the

job, program, or display station session in which they are issued. Furthermore, they have no effect on other jobs that might be running at the same time.

When you create an application program, the file names that are specified in the program associate files with it. You can override these file names or the attributes of the specified file when you compile or run a program.

You can use overrides to change most, but not all, of the file attributes that are specified when the file is created. In some cases, you can specify attributes in overrides that are not part of the original file definition.

Overriding a file is different from changing a file in that an override does not permanently change the attributes of a file. For example, if you override the number of copies for a printer file by requesting six copies instead of two, the file description for the printer file still specifies two copies, but six copies are printed. The system uses the file override command to determine which file to open and what its file attributes are.

The system supplies the following override functions:

- [“Application of overrides” on page 83](#)
- [“Deletion of overrides” on page 97](#)
- [“Display of overrides” on page 97](#)

Handling overrides for message files is different in some respects from handling overrides for other files. You can override only the name of the message file, and not the attributes.

### **Related information**

[Control language](#)

### ***Benefits of using overrides***

Overrides are particularly useful for making minor changes to the way a program functions or for selecting the data on which it operates without having to recompile the program. Their principal value is in allowing you to use general purpose programs in a wider variety of circumstances.

Examples of items where you can use overrides include the following cases:

- Changing the name of the file to process
- Selecting the database file member to process
- Indicating whether to spool output
- Directing output to a different tape unit
- Changing printer characteristics such as lines per inch and number of copies
- Selecting the remote location to use with an ICF file
- Changing the characteristics of a communications session

### ***Summary of the override commands***

You can process override functions for files by using the CL commands including DLTOVR, DSPOVR, OVRDBF, and so on.

You can process override functions for files by using the following CL commands:

#### **Delete Override (DLTOVR)**

The Delete Override command deletes one or more file overrides, including overrides for message files, that were previously specified in a call level.

#### **Display Override (DSPOVR)**

The Display Override command displays file overrides at any active call level, activation group level, or job level for a job.

#### **Override with Data Base File (OVRDBF)**

The Override with Database File command overrides (replaces) the database file named in the program, overrides certain parameters of a database file that is used by the program, or overrides the file and certain parameters of the file to be processed.

### **Override with Display File (OVRDSPF)**

The Override with Display File command overrides (replaces) the display file named in the program, overrides certain parameters of a display file that is used by the program, or overrides the file and certain parameters of the file to be processed.

### **Override ICF File (OVRICFF)**

The Override with Intersystem Communications Function File command overrides the file that is named in the program, and overrides certain parameters of the processed file.

### **Override Message File (OVRMSGF)**

The Override with Message File command overrides a message file that is used in a program. The rules for applying the overrides in this command are different from the other override commands. For more information about overriding message files, see [Control language](#) .

### **Override with Printer File (OVRPRTF)**

The Override with Printer File command overrides (replaces) the printer file named in the program, overrides certain parameters of a printer file that is used by the program, or overrides the file and certain parameters of the file to be processed.

### **Override with Save File (OVRSAVF)**

The Override with Save File command overrides (replaces) the file named in the program, overrides certain attributes of a file that is used by the program, or overrides the file and certain attributes of the file to be processed.

### **Override with Tape File (OVRTAPF)**

The Override with Tape File command overrides (replaces) the file named in the program, overrides certain attributes of a file that is used by the program, or overrides the file and certain attributes of the file to be processed.

## ***Effect of overrides on some commands***

Some commands ignore overrides entirely, while others allow overrides only for certain parameters.

The following commonly used commands ignore overrides entirely:

- ADDLFM
- ADDPFM
- ALCOBJ
- APYJRNCHG
- CHGOBJOWN
- CHGPTR
- CHGSBSD
- CHGXXXF (all change file commands)
- CLRPFM
- CLRSAVF
- CPYIGCTBL
- CRTDUPOBJ
- CRTAUTHLR
- CRTSBSD
- CRTTAPF
- DLCOBJ
- DLTF
- DLTAUTHLR
- DSPDBR
- DSPFD
- DSPFFD

- DSPJRN
- EDTOBJAUT
- EDTDLOAUT
- ENDJRNP
- GRTOBJAUT
- INZPFM
- MOVOBJ
- RGZPFM
- RMVJRNCHG
- RMVM
- RNMOBJ
- RTVMBRD
- RVKOBJAUT
- SBMDBJOB
- SIGNOFF
- STRDBRDR
- STRJRNP

**Note:** Save operations and restore operations ignore all file overrides that are related to the respective media (tape, diskette, save file).

The system does not apply overrides to any system files that are opened as part of an end-of-routing step or end-of-job processing. For example, you cannot specify overrides for the job log file. In some cases, when you need to override something in a system file, you might be able to change it through a command other than an override command. For example, to change the output queue for a job log, the output queue can be changed before sign-off using the OUTQ parameter on the Change Job (CHGJOB) command to specify the name of the output queue for the job. If the printer file for the job log contains the value \*JOB for the output queue, the output queue is the one that is specified for the job.

The following commands allow overrides for the SRCFILE and SRCMBR parameters only:

- CRTCMD
- CRTICFF
- CRTDSPF
- CRTLF
- CRTXXPGM
- CRTPRTF
- CRTSRCPF
- CRTTBL
- CRTPF
- All create program commands. These commands also use overrides to determine which file will be opened by a compiled program.

The following command allows overrides for the TOFILE, MBR, SEQONLY, LVLCHK, and INHWRT parameters:

OPNQRYF

The following commands allow overrides, but do not allow changing the MBR to \*ALL:

- CPYFRMPCD
- CPYTOPCD

The following commands do not allow overrides to affect the display files that they use. Overrides to the printer files they use must not change the file type or the file name. Some restrictions are placed on changes that can be made to printer files used by these commands, but the system cannot guarantee that all combinations of possible specifications produce an acceptable report.

#### **DMPOBJ and DMPYSOBJ**

(In addition to the preceding limitations, these commands do not allow overrides to the file they dump.)

#### **DSPXXXXXX**

(All display commands. The display commands that display information about a file do not allow overrides to that file.)

#### **DSPIGDCT**

#### **EDTIGDCT**

#### **GO**

(You can override message files.)

#### **PRTXXXXXX**

(All print commands.)

#### **QRYDTA**

#### **TRCXXX**

(All trace commands.)

#### **WRKXXXXXX**

(All work-with commands.)

#### **Related concepts**

##### Application of overrides when compiling a program

Overrides can be applied at the time a program is being compiled for either of two purposes: to select the source file, or to provide external data definitions for the compiler to use in defining the record formats to be used on I/O operations.

##### File redirection

File redirection lets you use overrides to direct data input or output to a device of a different type; for example, to send data that was intended for a diskette to a printer instead.

#### ***Usage of overrides in multithreaded jobs***

You can use the OVRDBF, OVRPRTF, OVRMSGF, and DLTOVR commands in a multithreaded job with some restrictions.

The restrictions are listed as follows:

- Override with Database File (OVRDBF) command. You can run this command from the initial thread of a multithreaded job. Only the overrides that are scoped to the job or an ILE activation group affect open operations that are performed in a secondary thread.
- Override with Printer File (OVRPRTF) command. You can run this command from the initial thread of a multithreaded job. Only the overrides that are scoped to the job or an ILE activation group affect open operations that are performed in a secondary thread.
- Override with Message File (OVRMSGF) command. You can run this command from the initial thread of a multithreaded job. This command affects only message file references in the initial thread. Message file references that are performed in secondary threads are not affected.
- Delete Override (DLTOVR) command. You can run this command from the initial thread of a multithreaded job.

The other override commands are not permitted, and are ignored, in multithreaded jobs.



## Application of overrides

You can perform two general types of overrides, which are file overrides and overrides for program device entries.

### File overrides

File overrides let you override the following things:

- File attributes
- File names
- File attributes and file names simultaneously
- File open scope
- File types

### Overrides for program device entries

Overrides for program device entries let you override the attribute of an ICF file that provides the link between the application and each of the remote servers or devices with which your program communicates.

### Related concepts

#### File types

The file management functions support these types of files.

#### File redirection

File redirection lets you use overrides to direct data input or output to a device of a different type; for example, to send data that was intended for a diskette to a printer instead.

### Related information

[ICF Programming PDF](#)

### ***Override of file attributes***

Overriding file attributes is the simplest form of overriding a file.

File attributes are built as a result of the following actions:

- Create file and add member commands. Initially, these commands build the file attributes.
- Program using the files. At compile time, the user program can specify some of the file attributes. (The attributes that you can specify depend on the high-level language in which the program is written.)
- Override commands. At the time when a program runs, these commands can override the file attributes previously built by the merging of the file description and the file parameters specified in the user program.

For example, assume that you create a printer file OUTPUT whose attributes are:

- Page size of 60 by 80
- Six lines per inch
- Two copies of printed output
- Two pages for file separators
- Overflow line number of 55

The [Create Printer File \(CRTPRTF\)](#) command looks like this:

```
CRTPRTF FILE(QGPL/OUTPUT) SPOOL(*YES) +  
  PAGESIZE(60 80) LPI(6) COPIES(2) +  
  FILESEP(2) OVRFLW(55)
```

You specify the printer file OUTPUT in your application program with an overflow line number of 58 and a page size of 66 by 132.

However, before you run the application program, you want to change the number of printed copies to 3, and the overflow line to 60. The override command looks like this:

```
OVRPRTF FILE(OUTPUT) COPIES(3) OVRFLW(60)
```

Then you call the application program, and three copies of the output print.

When the application program opens the OUTPUT file, the system merges the file-specified attributes, program-specified attributes, and override-specified attributes to form the open data path. The system uses the open data path when the program runs. The system merges file-specified overrides with the program-specified attributes first. Then it merges these merged attributes with the override attributes. In this example, when the OUTPUT file is opened and output operations are performed, spooled output will be produced with a page size of 66 by 132, six lines per inch, three copies, and two file separator pages. The spooled output will overflow at 60 lines.

Figure 3 on page 84 explains this example.

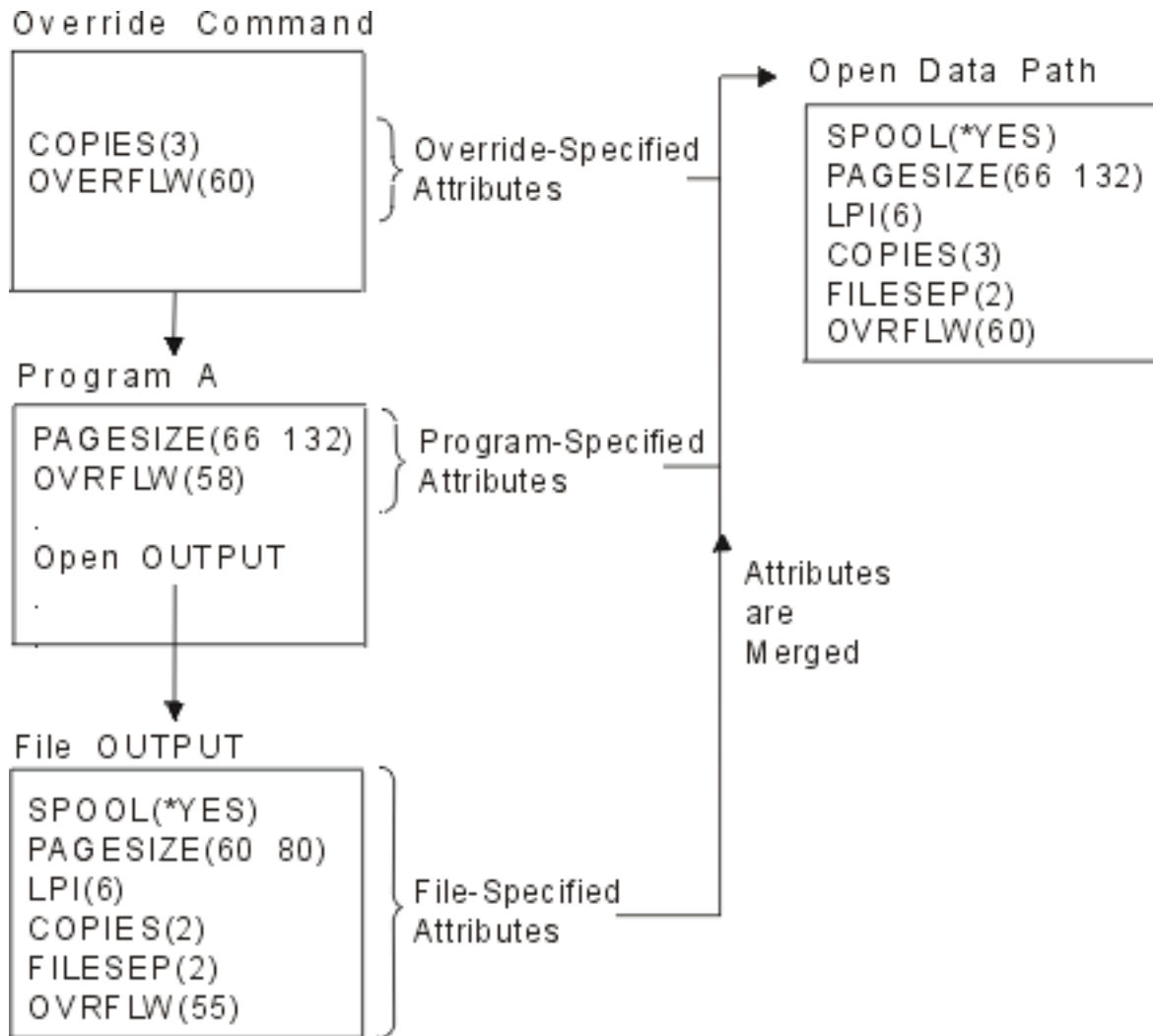

Figure 3. Override file attributes

### Override of file names

Overriding file names is another simple form that you change the file used by the program. This might be useful for files that you moved or renamed after the program compiled.

For example, you want to print the output from your application program by using the printer file REPORTS instead of the printer file OUTPUT (the application program specifies the OUTPUT printer file). Before you run the program, enter the following command:

```
OVRPRTF FILE(OUTPUT) TOFILE(REPORTS)
```

The [Create Printer File \(CRTPRTF\)](#) command must have created the file REPORTS before it can use the file.

### ***Override of file names and file attributes***

This form of overriding files is a combination of overriding file attributes and overriding file names. With this form of override, you can override the file that is to be used in a program and you can also override the attributes of the overriding file.

For example, you want the output from your application program to print using the printer file REPORTS instead of the printer file OUTPUT (the application program specifies the OUTPUT printer file). In addition to having the application program use the printer file REPORTS, you want to produce three copies. Assume that the following command created the file REPORTS:

```
CRTPRTF FILE(REPORTS) SPOOL(*YES) +  
  PAGESIZE(68 132) LPI(8) OVRFLW(60) +  
  COPIES(2) FILESEP(1)
```

Before you run the program, type the following command:

```
OVRPRTF FILE(OUTPUT) TOFILE(REPORTS) COPIES(3)
```

Then call the application program, and the program produces three copies of the output using the printer file REPORTS.

Note that this is *not* equal to the following two override commands:

```
Override 1 OVRPRTF FILE(OUTPUT) TOFILE(REPORTS)  
Override 2 OVRPRTF FILE(REPORTS) COPIES(3)
```

Only one override is applied for each call level for an open operation of a particular file; therefore, if you want to override the file that the program uses and also override the attributes of the overriding file from one call level, you must use a single command. If you use two overrides, the first override uses the printer file REPORTS to print the output. The system ignores the second override.

### ***Override of the scope of an open file***

The open scope (OPNSCOPE) parameter on the appropriate override command enables you to change the scope of a file open operation. The values for the OPNSCOPE parameter can be either \*JOB or \*ACTGRPDFN (default).

You can use this parameter to change the scope of an open operation from the call level number or activation group level to the job level.

For example, the following override command scopes the open operation of the BILLING file to the job level:

```
OVRDBF FILE(BILLING) OPNSCOPE(*JOB)
```

### ***How the system processes overrides***

In the Integrated Language Environment, overrides can be scoped to the call level, the activation-group level (the default), and the job level.

[Figure 4 on page 86](#) shows a representation of a job running in the Integrated Language Environment.

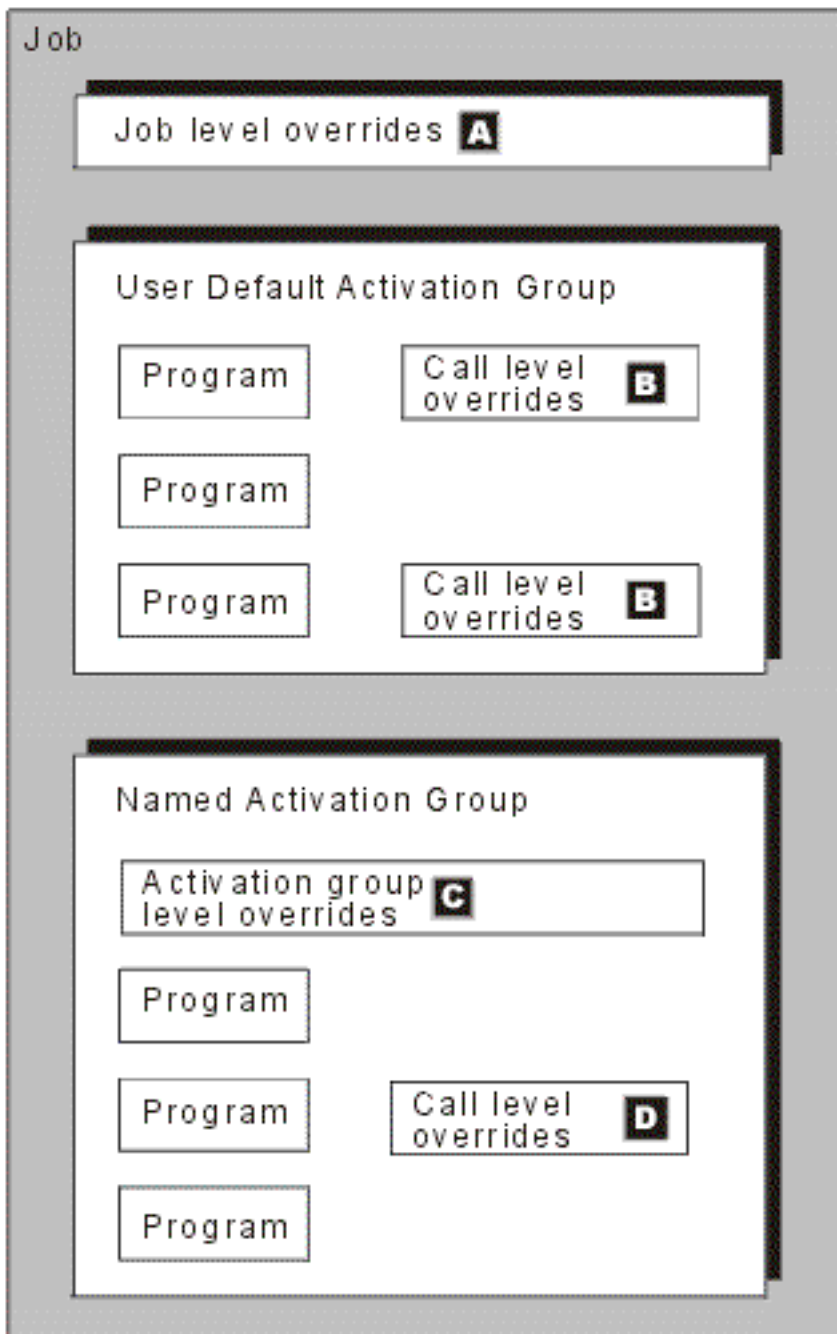

Figure 4. A job in the Integrated Language Environment

In the description that follows, the reference keys refer to the corresponding reference keys in the [Figure 4](#) on page 86.

A *job* is a piece of work that the system performs. An *interactive job* begins when a user signs on and ends when a user signs off. Overrides (**A**) that are scoped to the job level affect all programs that are running in any activation group within the job. There can be only one active override for a file at the job level. If you specify more than one, the most recent one takes effect. An override that is scoped to the job level remains in effect until one of the following events occurs:

- The job ends.
- The system explicitly deletes the override.
- Another job-level override for the same file replaces the override.

The rule previously stated is true regardless of the call level in which the overrides were specified. For example, an override that is issued in call level 3 that is scoped to the job level remains in effect when call level 3 is deleted. Overrides can be scoped to the job level by specifying OVRSCOPE(\*JOB) on the override command.

Overrides (**B**) that are specified in the user-default-activation-group can be scoped to the call level or to the job level. They cannot be scoped to the user default activation group level. However, overrides (**C** and **D**) that are specified in a named activation group can be scoped to the call level, activation group level, or the job level. Overrides (**C**) scoped to a named activation group level remain in effect until the system replaces or deletes the override, or until the system deletes the named activation group.

Overrides (**D**) that are scoped to the call level within a named activation group remain in effect until they are replaced, deleted, or until the program in which they were issued ends. Overrides can be scoped to the call level by specifying OVRSCOPE(\*CALLLVL) on the override command.

Overrides that are scoped to a named activation group level apply only to programs that run in the named activation group. They have no effect on programs that run in other named activation groups or in the user default activation group.

**Call levels** identify the subordinate relationships between related programs when one program calls another program within a job. Overrides that are scoped to the call level remain in effect from the time they are specified until they are replaced, or deleted, or until the program in which they are specified ends. This is true whether you issue the override in the user default activation group or in a named activation group.

For example:

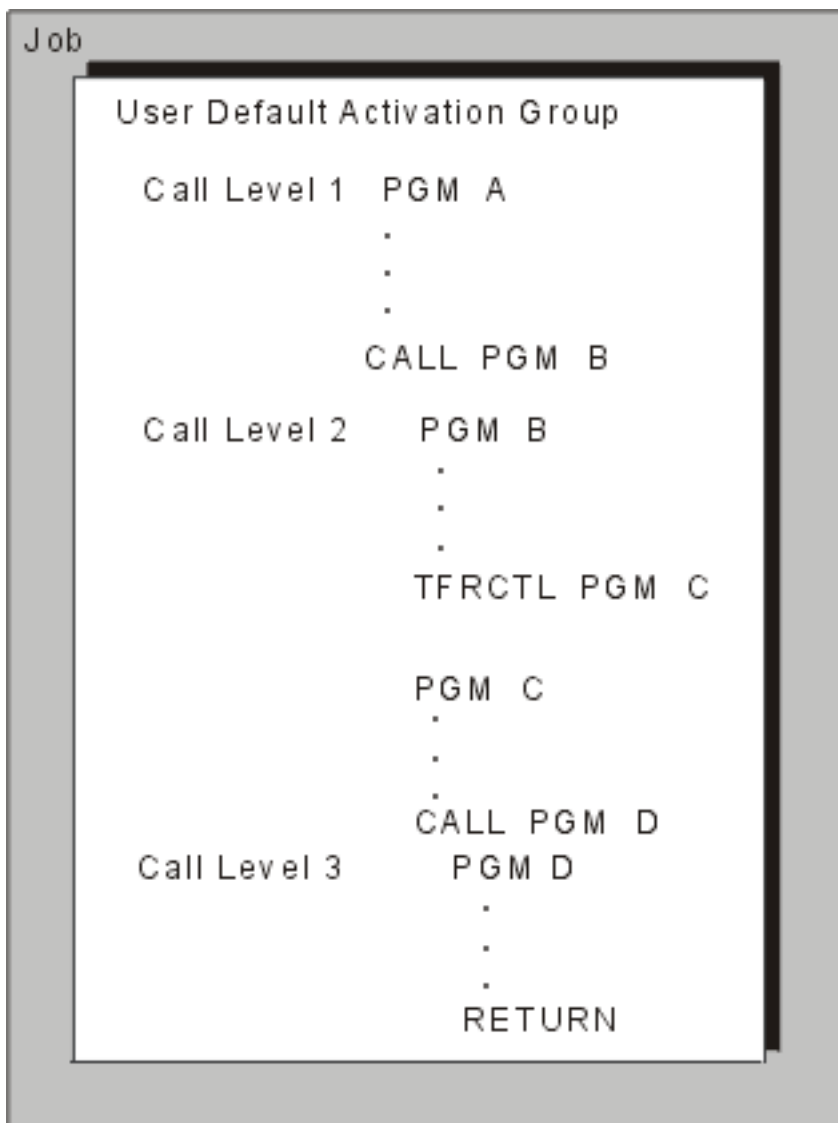

Figure 5. Call levels within a job

Several commands, such as Work with Job (WRKJOB), Work with Active Jobs (WRKACTJOB), or Display Job (DSPJOB), have options that allow you to display the call stack of an active job. There is a one-to-one relationship between a program that is displayed in the call stack and the call level. The first program name displayed (at the top of the list) on the call stack is the program at call level 1 for that job. Call level 1 is the lowest call level for a job. The second program name displayed is the program at call level 2 for that job. The last program name displayed is the program at the highest call level for that job.

In the example in Figure 5 on page 88, the Transfer Control (TFRCTL) command to PGMC causes PGMC to replace PGMB from the call stack. A CALL command places another program in the call stack. A RETURN command removes a program from the stack.

#### Process priority of overrides

Some overrides have higher priorities than others.

The system processes overrides when an open operation occurs in the following order:

1. Call level overrides up to and including the level of the oldest procedure in the activation group are applied first.
2. Activation group level overrides that were specified within the same activation group that the open operation was issued are applied.
3. Call level overrides below the level of the oldest procedure in the activation group are applied.

4. Job level overrides are applied.

*Scenario: How the system processes overrides*

When overrides are scoped to an activation group, the system does not process these overrides until it reaches the call level of the oldest procedure in that activation group.

The following example shows how overrides work in multiple activation groups.

Call Level 2	Program A (in user default activation group) OVRPRTF FILE(YYY) FOLD(*YES) OVRSCOPE(*CALLLVL) CALL PGM B
Call Level 3	Program B (in activation group 8) OVRPRTF FILE(ZZZ) TOFILE(YYY) DEV(P1) LPI(6) + OVRSCOPE(*CALLLVL) CALL PGM C
Call Level 4	Program C (in user default activation group) OVRPRTF FILE(ZZZ) CPI(12) OVRSCOPE(*CALLLVL) CALL PGM D
Call Level 5	Program D (in activation group 21) OVRPRTF FILE(YYY) DEV(P2) OVRSCOPE(*JOB) CALL PGM E
Call Level 6	Program E (in activation group 21) OVRPRTF FILE(ZZZ) LPI(12) OVRSCOPE(*ACTGRPDFN) CALL PGM F
Call Level 7	Program F (in activation group 8) OVRPRTF FILE(ZZZ) LPI(9) OVRSCOPE(*CALLLVL) CALL PGM G
Call Level 8	Program G (in activation group 8) OVRPRTF FILE(ZZZ) DUPLEX(*NO) + OVRSCOPE(*ACTGRPDFN) CALL PGM H
Call Level 9	Program H (in activation group 8) OVRPRTF FILE(YYY) LPI(5) OVRSCOPE(*ACTGRPDFN) CALL PGM I
Call Level 10	Program I (in activation group 8) OPEN FILE(ZZZ)

Figure 6. Example of override processing in multiple activation groups

When program I opens file ZZZ, file ZZZ has the following attributes:

- CPI(12)**  
From call level 4
- FILE(YYY)**  
From call level 3
- LPI(5)**  
From call level 9
- FOLD(\*YES)**  
From call level 2
- DEV(P2)**  
From call level 5

The system processes the overrides in the following order:

1. File ZZZ opens at call level 10. The system looks for any overrides issued at call level 10 that were scoped to the call level. There are no such overrides.
2. The system searches the next previous call level (level 9) for applicable overrides that were scoped to the call level. There are no such overrides. (The override issued in call level 9 is for file YYY and does not apply.)

3. The system searches call level 8 for applicable overrides that were scoped to the call level. There is an override for file ZZZ; however, it is scoped to the activation group level. The system does not process this override until it has processed all overrides with call levels greater than or equal to the call level of the oldest procedure in activation group 8. In this example, the call level of the oldest procedure in activation group 8 is 3. Therefore, the system will process all call level overrides that are issued at call levels greater than or equal to 3 before processing the activation group override that is issued at call level 8.
4. The system searches call level 7 for applicable overrides that were scoped to the call level. Because the override issued at call level 7 is scoped to the call level, it is processed. The LPI(9) attribute is assigned to file ZZZ.
5. The system searches call level 6 for applicable overrides that were scoped to the call level. Notice that call level 6 is in activation group 21. There is an override for file ZZZ; however, it is scoped to the activation group level of activation group 21. The system ignores this override altogether because it is scoped to an activation group other than activation group 8.
6. The system searches call level 5 for applicable overrides that were scoped to the call level. There are no such overrides. (The override issued in call level 5 is for file YYY and does not apply.)
7. The system searches call level 4 for applicable overrides that were scoped to the call level. Because the override issued at call level 4 is scoped to the call level, it is processed. The CPI(12) attribute is assigned to file ZZZ.
8. The system searches call level 3 for applicable overrides that were scoped to the call level. Because the override issued at call level 3 is scoped to the call level, it is processed. Notice that the file being opened has been changed to YYY from ZZZ. The DEV(P1) attribute is assigned to file YYY. The LPI(9) attribute is changed to LPI(6) and is assigned to file YYY.  
  
Call level 3 is the call level of the oldest procedure in activation group 8. Therefore, any overrides (for file YYY) that were scoped to the activation group level of activation group 8 are processed. The override issued at call level 9 is processed. This changes the LPI(6) attribute to LPI(5).
9. The system searches call level 2 for applicable overrides that were scoped to the call level. The override issued in call level 2 is processed. This assigns the FOLD(\*YES) attribute to file YYY.
10. The system searches call level 1 for applicable overrides that were scoped to the call level. There are no such overrides.
11. The system searches the job level for applicable overrides that were scoped to the job level. Because the override issued in call level 5 was scoped to the job level and it is for file YYY, it is processed. This changes the DEV(P1) attribute to DEV(P2).

#### *Process overrides: General principles*

The system processes overrides according to some general principles.

- Applied overrides include any that are in effect at the time a file is opened by an application program, when a program that opens a file is compiled, or when certain system commands are used. (See [“Override of file attributes”](#) on page 83, [“Application of overrides when compiling a program”](#) on page 96, and [“Effect of overrides on some commands”](#) on page 80). Thus, any overrides that are to be applied must be specified either before the file is opened by a program or before a program that opens the file is compiled. It is not necessary that overrides must be supplied for every file that is used in a program. Any file name for which no override is supplied is used as the actual file name.
- Override commands that are scoped to the job level remain in effect until they are replaced, deleted, or until the job in which they are specified ends. For more information about deleting overrides, see [“Deletion of overrides”](#) on page 97.
- There can be only one active override for a file at each level (job level, activation group level, or call level). If more than one override for the same file exists at the same level, the most recent one is active.

For an example of how the system processes overrides when more than one override for the same file exists at the same level, see [“Scenario: Overrides to the same file at the same call level”](#) on page 92.

- Override commands that are scoped to the job level apply to all programs that are running in the job regardless of the call level or activation group in which the overrides are specified.



- Override commands that are scoped to an activation group level apply to all programs that are running in the activation group regardless of the call level in which the overrides are specified.
- An override command (scoped to the call level) that is entered interactively exists at the call level for the caller of that command processor. For example, an override (scoped to the call level) that is entered on the command entry display cannot be deleted or replaced from a command processor that is called from the command entry display.
- The call level of an override (scoped to the call level) that is coded in a CL program is the call level of the CL program.
- An override (scoped to the call level) outside a program in a batch job takes the call level of the batch job command processor.
- If an override command (scoped to the call level) is run using a call to the QCMDEXC program, the override takes the call level of the program that called the QCMDEXC program. For an example, see [“CL program overrides”](#) on page 93.
- Exits (ENDPGM, RETURN, or abnormal exits) from a call operation delete overrides scoped to that call level. However, they do not delete overrides that are issued in that call level when they are scoped to the activation group level or the job level.

For an example, see [“Scenario: Effect of exits on overrides”](#) on page 91.

- The [Transfer Control \(TFRCTL\)](#) command causes one program to be replaced by another program at the same call level. The program, to which control is transferred, runs at the same call level as the program that contained the TFRCTL command. An override command in a program that transfers control to another program is not deleted during the transfer of control.

For an example, see [“Scenario: Effect of TFRCTL on overrides”](#) on page 92.

- Several overrides (possibly one per call level, one at the activation group level, and one at the job level) to a single file are allowed. They are processed according to the priorities in [“Process priority of overrides”](#) on page 88.

For an example of processing overrides, see [“Scenario: How the system processes overrides”](#) on page 89.

- You can protect an override from being overridden by overrides at lower call levels, the activation group level, and the job level; specify `SECURE(*YES)` on the override. For an example, see [“Securing files against overrides”](#) on page 93.

### ***Scenario: Effect of exits on overrides***

Exits (ENDPGM, RETURN, or abnormal exits) from a call operation delete overrides that are scoped to that call level. However, they do not delete overrides that are issued in that call level that are scoped to the activation group level or the job level.

For example, a [Return \(RETURN\)](#) command deletes all overrides scoped to that call level. Thus, overrides that are scoped to the call level in called programs that end with a RETURN or [End Program \(ENDPGM\)](#) command do not apply to the calling program. This is not true for programs that use the [Transfer Control \(TFRCTL\)](#) command.

In [Figure 7](#) on page 92, the RETURN command deletes the first override in program B, and FILE X is opened in program A. However, the RETURN command does not delete the second override because it is scoped to the job level. FILE B is opened in program A when program A processes the Open FILE A command.

```

Program A
.
.
.

CALL PGM(B)

Program B
Override 1 OVRDBF FILE(X) FILE(Y)
Override 2 OVRDBF FILE(A) TOFILE(B) +
          OVRSCOPE(*JOB)
.
.
.

RETURN

OPEN FILE X
.
.
.
OPEN FILE A

```

Figure 7. Example of effect of exits on overrides

**Scenario: Effect of TFRCTL on overrides**

The TFRCTL command replaces one program with another program at the same call level. The program to which control is transferred runs at the same call level as the program that contained the TFRCTL command. An override command in a program that transfers control to another program is not deleted during the transfer of control.

In the following example, program A transfers control to program B, and program B runs in the same call level as program A. The Override with Database File (OVRDBF) command causes the file to be positioned at the last record of the member when it is opened and is used for both programs A and B.

```

CALL PGM(A)

Program A

OVRDBF FILE(INPUT) POSITION(*END)

(INPUT is opened and positioned at the last
record of the member and closed after
processing.) TFRCTL PGM(B)
Program B

```

(INPUT is opened and positioned at the last record of the member.)

Figure 8. An example of the TFRCTL command

**Scenario: Overrides to the same file at the same call level**

When you enter two overrides for the same file name at the same call level, the second override replaces the first override. This allows you to replace an override at a single call level, without having to delete the first override.

In the following example, when the program attempts to open FILE A, FILE B overrides FILE A because of override 2. Because only one override can be applied for each call level, the system ignores override 1, and the file opened by the program is FILE B.

```

Program A
.
.
.
Override 1      OVRDBF FILE(B) TOFILE(C)
Override 2      OVRDBF FILE(A) TOFILE(B)
.
.
.
OPEN FILE A
.
.
.

```

Figure 9. An example of the system response to the open file command using overrides

To open FILE C, replace the two Override with Database File (OVRDBF) commands with the following command:

```
OVRDBF FILE(A) TOFILE(C)
```

This does not prevent applying an override at the same call level or job level in which the file is created. Regardless of which attribute is encountered first, file attributes on the override take the place of corresponding attributes on the create statement for the file.

### Related concepts

#### Deletion of overrides

When a program that has been called returns control to the calling program, the system deletes any overrides specified in the call level of the called program.

### **CL program overrides**

If a control language (CL) program overrides a file and then calls a high-level language program, the override remains in effect for the high-level language program.

However, if a high-level language program calls a CL program that overrides a file, the system deletes the override automatically when control returns to the high-level language program.

### **Securing files against overrides**

On occasion, you might want to prevent the person or program that calls your program from changing the file names or attributes you have specified. You can prevent additional file overrides by coding the SECURE(\*YES) parameter on a file override command for each file that needs protection. This protects your file from overrides at lower call levels, the activation group level, and the job level.

The following example shows how to prevent a person or program from changing the names or attributes of your file.

```

Override 1  OVRPRTF FILE(PRINT1) SPOOL(*NO)

Override 2  OVRDBF FILE(NEWEMP) TOFILE(OLDEMP) +
           MBR(N67)
           CALL PGM(CHECK)

           Program CHECK
Override 3  OVRDBF FILE(INPUT) +
           TOFILE(NEWEMP) MBR(N77) +
           SECURE(*YES)
           CALL PGM(EREPORT)

           Program EREPORT
           (NEWEMP and PRINT1 are opened.)

Override 4  OVRDBF FILE(INPUT) +
           TOFILE(NEWEMP) MBR(N77)
           CALL PGM(ELIST)

           Program ELIST
           (OLDEMP and PRINT1 are opened.)

```

*Figure 10. An example of a protected file*

When the code example calls program EREPORT, it attempts to open the files INPUT and PRINT1. EREPORT actually opens file NEWEMP, member N77. Because override 3 specifies SECURE(\*YES), the system does not apply override 2. When the example calls program ELIST, it also attempts to open the files INPUT and PRINT1. ELIST actually opens file OLDEMP, member N67. Because override 4 has the same name as override 3 and is at the same call level as override 3, it replaces override 3. Thus, the file is no longer protected from overrides at lower call levels, and the system applies override 2 for program ELIST.

PRINT1 is affected only by override 1, which is in effect for both programs EREPORT and ELIST.

### ***Usage of a generic override for printer files***

The OVRPRTF command allows you to have one override for all the printer files in your job with the same set of values. Without the generic override, you would need to do a separate override for each of the printer files.

To see scenarios regarding the application of [Override with Printer File \(OVRPRTF\)](#) command with \*PRTF, see the following topics.

#### *Example: Apply OVRPRTF with \*PRTF*

You can apply the OVRPRTF command to all printer files by specifying \*PRTF as the file name. The OVRPRTF command with \*PRTF is applied if there is no other override for the printer file name at the same call level.

The following example shows how \*PRTF works:

```

Override 1  OVRPRTF FILE(OUTPUT) COPIES(6) +
           LPI(6)
Override 2  OVRPRTF FILE(*PRTF) COPIES(1) +
           LPI(8)
           CALL PGM(X)

```

*Figure 11. An example of the OVRPRTF command and the \*PRTF parameter*

When program X opens the file OUTPUT, the opened file has the following attributes:

**COPIES(6)**

From Override 1

**LPI(6)**

From Override 1

When program X opens the file PRTOUT (or any printer file other than OUTPUT), the opened file has the following attributes:

**COPIES(1)**

From Override 2

**LPI(8)**

From Override 2

*Example: Applying OVRPRTF with \*PRTF from multiple call levels*

The example in this topic shows how printer-file overrides are applied from multiple call levels by using the \*PRTF value.

```

Program A
Override 1  OVRPRTF FILE(*PRTF) COPIES(1)
Override 2  OVRPRTF FILE(PRT2) COPIES(2)
Override 3  OVRPRTF FILE(PRT4) COPIES(2)
          CALL PGM(B)

```

```

Program B
Override 4   OVRPRTF FILE(*PRTF) LPI(4)
Override 5   OVRPRTF FILE(PRT3) LPI(8)
Override 6   OVRPRTF FILE(PRT4) LPI(8)
          CALL PGM(X)

```

*Figure 12. An example of printer-file overrides*

When program X opens the file PRT1, the opened file has the following attributes:

**COPIES(1)**

From Override 1

**LPI(4)**

From Override 4

Because no specific overrides are found for PRT1, \*PRTF overrides (1 and 4) are applied.

When program X opens the file PRT2, the opened file has the following attributes:

**COPIES(2)**

From Override 2

**LPI(4)**

From Override 4

Because no specific override is found for PRT2 in program B, override 4 is applied. In program A, override 2 specifies PRT2 and is applied.

When program X opens the file PRT3, the opened file has the following attributes:

**COPIES(1)**

From Override 1

**LPI(8)**

From Override 5

In program B, override 5 specifies PRT3 and is applied. Because no specific override is found for PRT3 in program A, override 1 is applied.

When program X opens the file PRT4, the opened file has the following attributes:

**COPIES(2)**

From Override 3

**LPI(8)**

From Override 6

In program B, override 6 specifies PRT4 and is applied. In program A, override 3 specifies PRT4 and is applied.

***Application of overrides when compiling a program***

Overrides can be applied at the time a program is being compiled for either of two purposes: to select the source file, or to provide external data definitions for the compiler to use in defining the record formats to be used on I/O operations.

Overrides to the source file are handled just like any other override. They can select another file, another member of a database file, another label for diskette or tape, or change other file attributes.

You can also apply overrides to files that are used within the program being compiled, if they are being used as externally described files in the program. These files are not opened at compile time, and thus the overrides are not applied in the normal manner. These overrides are used at compile time only to determine the file name and library that will be used to define the record formats and fields for the program to use I/O operations. Any other file attributes specified on the override are ignored at compile time. It is necessary that these file overrides be active at compile time only if the file name specified in the source for the program is not the file name that contains the record formats that the application needs.

The file name that is opened when the compiled program is run is determined by the file name that the program source refers to, changed by whatever overrides are in effect at the time the program runs. The file name used at compile time is not kept. The record formats in the file that is actually opened must be compatible with those that were used when the program was compiled. Obviously, the easiest way to assure that records are compatible is to have the same overrides active at run time that were active at compile time. If your program uses externally described data and a different field level file is used at run time, it is typically necessary to specify LVLCHK(\*NO) on the override. See [“File redirection” on page 103](#) for details.

The following example shows how overrides work when compiling a program:

```

Override 1  OVRDBF FILE(RPGSRC) +
            TOFILE(SRCPGMS) MBR(INVN42)
Override 2  OVRPRTF FILE(OUTPUT) TOFILE(REPORTS)
            CALL PGM(A)

            Program A
Override 3  OVRPRTF FILE(LISTOUT) +
            TOFILE(OUTPUT)
Override 4  OVRDBF FILE(RPGSRC) WAITFILE(30)
            CRTRPGM PGM(INVENTORY) +
            SRCFILE(RPGSRC)
            RETURN

Override 5  OVRPRTF FILE(LISTOUT) +
            TOFILE(REPORTS) LPI(8)
            CALL PGM(INVENTORY)

```

*Figure 13. An example over overrides when compiling a program*

The program INVENTORY opens the printer file REPORTS in place of printer file LISTOUT and creates output at 8 lines per inch.

The program INVENTORY is created (compiled) from the member INVN42 in the database file SRCPGMS. Override 4, which is applied first, overrides an optional file attribute. Override 1, which is applied last, causes the file RPGSRC to be overridden with the database file SRCPGMS, member INVN42.

The program INVENTORY is created with the printer formats from the file REPORTS. Assume that the source for the program INVENTORY, which is taken from file SRCPGMS and member INVN42, contains an open to the printer file LISTOUT. Override 3, which is applied first, causes the file LISTOUT to be overridden with OUTPUT. Override 2, which is applied last, overrides OUTPUT with REPORTS. Other attributes can be specified here, but it is not necessary because only the record formats are used at compile time.

At run time, override 3 is no longer active, because program A has ended. Therefore override 2 has no effect on LISTOUT. However, override 5, which is active at run time, replaces LISTOUT with REPORTS and specifies 8 lines per inch. Because the same file is used for compilation and runtime, you can leave level checking on.

### **Related reference**

[Effect of overrides on some commands](#)

Some commands ignore overrides entirely, while others allow overrides only for certain parameters.

## **Deletion of overrides**

When a program that has been called returns control to the calling program, the system deletes any overrides specified in the call level of the called program.

This does not include overrides that are scoped to the activation group level or the job level. Overrides that are scoped to the activation group level remain in effect until they are explicitly deleted, replaced, or until the activation group in which they are specified is deleted. Overrides that are scoped to the job level remain in effect until they are explicitly deleted, replaced, or until the job in which they are specified ends.

When control is transferred to another program by using the [Transfer Control \(TFRCTL\)](#) command, the overrides in the call level of the transferring program are not deleted.

You can also explicitly delete overrides on your system by using the [Delete Override \(DLTOVR\)](#) command. The DLTOVR command can delete overrides that are scoped to the call level, activation group level, or the job level. To delete overrides that are scoped to the activation group level, you do not need to specify a value for the OVRSCOPE parameter because OVRSCOPE(\*ACTGRPDFN) is the default. To delete overrides that are scoped to the job level, you must specify OVRSCOPE(\*JOB) on the DLTOVR command.

To identify an override, use the file name that is specified on the FILE parameter of the override command. You can delete all overrides at the current level (call level, activation group level, or job level) by specifying value \*ALL for the FILE parameter.

### **Related concepts**

[Scenario: Overrides to the same file at the same call level](#)

When you enter two overrides for the same file name at the same call level, the second override replaces the first override. This allows you to replace an override at a single call level, without having to delete the first override.

## **Display of overrides**

You can use the Display Override (DSPOVR) command to display file overrides at the job level, the activation group level, and at multiple call levels for a job. You can display all file overrides or overrides for a specific file.

The file overrides can be merged before being displayed. A merged override is the result of combining overrides from the job level to the current level or any specified call level, producing a composite override which will be applied when the file is used at the specific call level. The current call level is the call level of the program that is currently running. This program is the last program name that is displayed on the call stack. This command can be requested from either a batch or interactive environment. You can also access this function from option 15 (Display file overrides) from the Work with Job menu using the [Work with Job \(WRKJOB\)](#) command, or by selecting option 15 (Display file overrides) from the Display Job menu using the [Display Job \(DSPJOB\)](#) command.

### **Related information**

[Display Override \(DSPOVR\) command](#)

### **Example: Displaying all overrides for a specific activation group**

You can use the DSPOVR command to display all overrides for a specific activation group. Here is an example.

To display all overrides for a specific activation group, you type:

```
DSPOVR FILE(REPORTS) ACTGRP(*)
```

This displays all the overrides for the REPORTS file for the activation group in which the override is issued. ACTGRP(\*) is the default and is shown here for illustration purposes. To specify an activation group other than the one the command is to be issued in, specify the name of the activation group on the ACTGRP parameter.

### **Example: Displaying merged file overrides for one file**

You can specify \*YES for the MRGOVR parameter of the DSPOVR command to display merged file overrides for one file. Here is an example.

To display the merged file override for a particular file at a specific call level, you type:

```
DSPOVR FILE(REPORTS) MRGOVR(*YES) LVL(3)
```

This command produces a display that shows the merged override for the file REPORTS at call level 3 with text descriptions of each keyword and parameter. Any applicable overrides at the job level, the activation group level, and at call levels 1, 2, and 3 are used to form the merged override, but overrides at higher call levels are ignored. If the call level specified is not active, all applicable overrides up to the current level are used.

### **Example: Displaying all file overrides for one file**

You can specify \*NO for the MRGOVR parameter, and specify a specific call level for the LVL parameter to display all file overrides for one file. Here is an example.

To display all file overrides for a specific file up to a specific call level, you type:

```
DSPOVR FILE(REPORTS) MRGOVR(*NO) LVL(2)
```

This command produces a display that shows the file name, the call level for which the override was requested, the type of override, and the override parameters in keyword-parameter form. If no file overrides are found for the file up to and including the specified call level, escape message CPF9842 is sent. If you are using the [Display Override \(DSPOVR\)](#) command in a CL program, you might want to add a [Monitor Message \(MONMSG\)](#) command following the DSPOVR command to prevent your program from ending if there are no overrides for the file. This technique is illustrated in some of the examples later in this chapter.

### **Related information**

[Control language](#)

### **Example: Displaying merged file overrides for all files**

You can specify \*YES for the MRGOVR parameter, and specify \* for the LVL parameter to display merged file overrides for all files. Here is an example.

To display the merged file overrides for all files at the current call level, you type:

```
DSPOVR FILE(*ALL) MRGOVR(*YES) LVL(*)
```

This command produces a display showing the file name, the type of override, and the merged overrides in keyword-parameter form, where only the keywords and parameters entered on the commands are displayed. This is the same as what happens when you type [DSPOVR](#) with no parameters. Only those keywords for which parameters were specified are displayed. The associated text descriptions are not displayed. Overrides at call levels greater than 999 are not displayed.



### **Example: Displaying overrides with WRKJOB**

When overrides are displayed through an option on one of the system interfaces to work with jobs (for example, WRKJOB) instead of by the DSPOVR command, all file overrides from the job level to the current call level are displayed.

This would be the same as typing the following command:

```
DSPOVR FILE(*ALL) MRGOVR(*NO) LVL(*)
```

This produces a display showing the file name, the level (call level, activation group level, or job level) for which the override was requested, the type of override, and the override parameters in keyword-parameter form for each override.

Because the display overrides function uses a copy of the internal control blocks, overrides that were deleted between the time the display overrides function was called and the time the output was produced might not be reflected in the output. This can occur only when the overrides in another job are being displayed.

### **Example: Displaying overrides**

This example is intended only to illustrate what the various forms of the display override command can do.

The Display Override (DSPOVR) command is typically entered interactively or added temporarily to a CL program, or to any high-level language program via QCMDXEC, to verify that the proper overrides are in effect at the time a program is called or a file is opened. Assume that commands 1, 2, 3, and 18 are entered at call level 1.

```
Command 1      Program A (in the user default activation group)
                OVRPRTF FILE(PRTA) COPIES(3)
Command 2      OVRDBF FILE(DBC) WAITFILE(*IMMED)
Command 3      CALL PGM(B)

Command 4      Program B (in activation group 5)
                OVRPRTF FILE(PRTB) TOFILE(PRTA) COPIES(6) +
                OVRSCOPE(*CALLLVL)
Command 5      OVRDBF FILE(DBC) WAITFILE(60) OVRSCOPE(*CALLLVL)
Command 6      OVRDBF FILE(DBE) TOFILE(DBF) OVRSCOPE(*JOB)
Command 7      DSPOVR FILE(PRTB) MRGOVR(*YES)
Command 8      CALL PGM(C)

Command 9      Program C (in activation group 5)
                CALL PGM(QCMDXEC) PARM('OVRDSPF FILE(DSPE) +
                TOFILE(DSPF) OVRSCOPE(*CALLLVL)' 50)
Command 10     OVRDBF FILE(DBC) TOFILE(DBD) OVRSCOPE(*CALLLVL)
Command 11     DSPOVR FILE(DBC) MRGOVR(*NO) LVL(3)
Command 12     DSPOVR FILE(DBD) MRGOVR(*NO) LVL(2)
Command 13     MONMSG MSGID(CPF9842)
Command 14     OVRDSPF FILE(CREDITS) TOFILE(DEBITS)
Command 15     CALL PGM(QCMDXEC) PARM('DSPOVR FILE(*ALL) MRGOVR(*YES) +
                LVL(*) OUTPUT(*)' 47)
Command 16     RETURN

Command 17     DSPOVR FILE(*ALL) MRGOVR(*NO)
Command 18     RETURN
Command 19     DSPOVR FILE(*ALL) MRGOVR(*NO) LVL(2) OUTPUT(*)
```

*Figure 14. An example of displaying overrides*

Command 1 overrides the value of the COPIES attribute of file PRTA at level 1 to 3.

Command 2 overrides the value of the WAITFILE attribute of file DBC at level 1 to \*IMMED.

Command 3 calls program A and creates a new call level, 2.

Command 4 causes an override at level 2 from file PRTB to file PRTA. Also, the command overrides the value of the COPIES attribute to 6.

Command 5 overrides the the value of the WAITFILE attribute for file DBC at level 2 to 60.

Command 6 causes an override of file DBE to file DBF and scopes the override to the job level.

Command 7 displays a merged override for file PRTB at level 2 with text descriptions of each keyword and parameter, as shown in Figure 15 on page 100. The to-file is PRTA because of command 4, and the COPIES attribute is 3 because of command 1.

```

                                Display Override with Printer File

File . . . . . : PRTB
Call level . . . . . : *
Merged . . . . . : *YES

Name of file being overridden . . : FILE      Keyword  Value
Overriding to printer file . . . : TOFILE   PRTB
Library . . . . . :                   *LIBL
Number of copies . . . . . : COPIES      3

Press Enter to continue.

F3=Exit  F12=Cancel

```

Figure 15. Override with printer file display

Command 8 calls program B and creates the new call level 3.

Command 9 causes an override at level 3 from file DSPE to file DSPF. An override done via a call to the QCMDEXC program takes the call level of the program that called the QCMDEXC program.

Command 10 causes an override of file DBC to file DBD.

Command 11 displays all overrides for file DBC from the job level to level 3, as shown in Figure 16 on page 100. The overrides specified by commands 10, 5, and 2 are displayed in keyword-parameter form. Observe that this form of the DSPOVR command shows all the overrides for the selected file, regardless of redirection. The three overrides that are shown would not be merged because of the name change at level 3.

```

                                Display All File Overrides

Call level . . . . . : 3

Type options, press Enter.
  5=Display override details

Opt  File   Level  Type  Keyword Specifications
-   DBC    3      DB   TOFILE(*LIBL/DBD)
-                   2      DB   WAITFILE(60)
-                   1      DB   WAITFILE(*IMMED)

F3=Exit  F5=Refresh  F12=Cancel

```

Figure 16. All file overrides display (one file)

Command 12 attempts to display all file overrides for file DBD from the job level to level 2. Because no overrides for file DBD exist at levels 1 or 2, no overrides are displayed, and the override-not-found escape message (CPF9842) is sent.

Command 13 monitors for message CPF9842 on the preceding command. The monitor specifies no action to be taken, but will prevent a function check if the message is sent.

Command 14 causes an override of the display file CREDITS to the display file DEBITS. The override is scoped to the activation group level of activation group 5. OVRSCOPE(\*ACTGRPDFN) is the default.

Command 15 displays the merged overrides at the job level to call level 3 for all files in keyword-parameter form, as shown in [Figure 17 on page 101](#). File DBC is overridden to file DBD because of command 10 (commands 5 and 2 are therefore not effective). File DSPE is overridden to file DSPF because of command 9. File PRTB is overridden to file PRTA and COPIES(3) because of commands 4 and 1. File DBE is overridden to file DBF because of command 6. The file DEBITS overrides the file CREDITS because of command 14.

```
Display All Merged File Overrides

Call level . . . . . : *

Type options, press Enter.
  5=Display override details  8=Display contributing file overrides

Opt  File      Type  Keyword Specifications
-   DSPE      DSP   TOFILE(*LIBL/DSPF)
  8   PRTB      PRT   TOFILE(*LIBL/PRTA) COPIES(3)
-   DBC       DB    TOFILE(*LIBL/DBD)
-   PRTA      PRT   COPIES(3)
-   DBE       DB    TOFILE(*LIBL/DBF)
-   CREDITS   DSPF  TOFILE(*LIBL/DEBITS)

F3=Exit  F5=Refresh  F11=All file overrides  F12=Cancel
```

*Figure 17. All merged file overrides display*

If you enter a 5 on the line for PRTB, you get a detail display like the one shown in [Figure 15 on page 100](#). If you enter an 8 on this same line, you get a display showing commands 4 and 1 on separate lines, as shown in [Figure 18 on page 102](#). These are the overrides that were merged to form the PRTB override.

```

                                Display Contributing File Overrides

File . . . . . : PRTB
Call level . . . . . : *

Type options, press Enter.
  5=Display override details

Opt  Level  Type  Keyword Specifications
-    2      PRT  TOFILE(*LIBL/PRTA) COPIES(6)
-    1      PRT  COPIES(3)

F3=Exit  F5=Refresh  F12=Cancel  F14=Display previous override

```

Figure 18. Contribute file overrides display

Command 16 causes a return to level 2, and level 3 is deleted. The overrides issued at level 3 that are scoped to the call level are implicitly deleted. The override issued by command 14 is not deleted because it is scoped to the activation group level.

Command 17 displays all overrides issued for the job level to the current call level (level 2), as shown in [Figure 19 on page 102](#). The overrides specified in commands 1, 2, 4, 5, 6, and 14 display in keyword-parameter form. The override issued in command 10 is not displayed because call level 3 is no longer active. Pressing F11 on this display allows you to see a display that is similar to the one shown in [Figure 17 on page 101](#).

```

                                Display All File Overrides

Call level . . . . . : *

Type options, press Enter.
  5=Display override details

Opt  File      Level  Type  Keyword Specifications
-    CREDITS  *ACTGRP PRT  TOFILE(*LIBL/DEBITS)
-    PRTB      2      PRT  TOFILE(*LIBL/PRTA) COPIES(6)
-    DBC       2      DB   WAITFILE(60)
-           1      DB   WAITFILE(*IMMED)
-    PRTA      1      PRT  COPIES(3)
-    DBE       *JOB   DB   TOFILE(*LIBL/DBF)

F3=Exit  F5=Refresh  F11=All merged file overrides  F12=Cancel

```

Figure 19. All file overrides display (all files)

Command 18 causes a return to level 1, and level 2 is deleted. The overrides issued at level 2 that are scoped to the call level are implicitly deleted. The override that is caused by command 14 (scoped to the activation group level) is implicitly deleted when activation group 5 ends. In this example, assume that activation group 5 is a nonpersistent activation group and that ends when command 18 processes. The override caused by command 6 is not deleted.

Command 19 displays all overrides for the job level to call level 2 in keyword-parameter form. Because level 2 is no longer active, only the overrides scoped to the job level (command 6) and those specified at level 1 in commands 1 and 2 are displayed.

### ***Tips about displaying overrides***

Here are some tips you might use when you display overrides.

Note that when specifying a call level, as in the first two examples in this section, the call level on which you first entered override commands might not be level 1. Depending on the contents of the first program and first menu specified in your user profile, and any other programs or menus you might have come through, you might have entered your first override commands at level 3 or 4. You can enter `WRKJOB` and select option 11 (call stack) to see what programs are running at lower call levels.

Unless you know exactly what you want to see, it is typically best to request the override display with no parameters, because options on the basic override display allow you to select a detailed display of any override you are interested in. The specific options available are:

- From the merged display of all overrides, you can request the display that is not merged, as in [“Example: Displaying overrides with WRKJOB”](#) on page 99.
- From the unmerged display of all overrides, you can request the merged display.
- From the merged display of all overrides, you can request a merged detail display of any override, equivalent to the command in [“Example: Displaying merged file overrides for one file”](#) on page 98.
- From the merged display of all overrides, you can request a display of all the individual overrides that contributed to the merged display, showing the level (call level or job level) for which each was requested.
- From either the display of contributing overrides or the display (not merged) of all overrides, you can request a detail display of the override for a particular file at a single call level.

## **File redirection**

File redirection lets you use overrides to direct data input or output to a device of a different type; for example, to send data that was intended for a diskette to a printer instead.

This use of overrides requires somewhat more foresight than the override applications listed above, because the program must be able to accommodate the different characteristics of the two devices involved.

To override to a different type of file, use the override command for the new type of file. For example, if you are overriding a diskette file with a printer file, use the Override with Printer File (`OVRPRTF`) command.

This topic applies only to using an application program. System code might or might not support file redirection.

You use the Override with Database File (`OVRDBF`) command to redirect a file to a distributed data management (DDM) file. If the remote system is another IBM i product, all normal rules that are discussed in this topic apply. If the remote system is not a IBM i or System/38 product, do not specify an expiration date or end-of-file delay.

When you replace the file that is used in a program with another file of the same type, the new file is processed in the same manner as the original file. If you redirect a field-level file, or any other file that contains externally described data, you should typically specify `LVLCHK(*NO)` or recompile the program. Even when you turn level checking off, the record formats in the file must remain compatible with the records in the program. If the formats are not compatible, the results cannot be predicted.

Overrides that have a `TOFILE` parameter value other than `*FILE` remove any database member specifications that might be on overrides applied at higher call levels. The member name will default to `*FIRST` unless it is specified with the change to the file name or library or on another override at a lower call level.

If you change to a different type of file, the system ignores device-dependent characteristics and records that the system reads or writes sequentially. You must specify some device parameters in the new device file or the override. The system uses defaults for others.

The system ignores any attributes that are specified on overrides of a different file type than the final file type. The parameters SPOOL, SHARE, and SECURE are exceptions to this rule. The system accepts the parameters from any override that is applied to the file, regardless of device type.

**Related concepts**

[Application of overrides](#)

You can perform two general types of overrides, which are file overrides and overrides for program device entries.

**Related reference**

[Effect of overrides on some commands](#)

Some commands ignore overrides entirely, while others allow overrides only for certain parameters.

**Related information**

[Distributed database programming](#)

[Override with Printer File \(OVRPRTF\)](#)

[Override with Database File \(OVRDBF\)](#)

**Plans for redirecting files**

The table in this topic shows the valid combinations of file redirections.

To use this chart, identify the file type that you want to override in the FROM-FILE columns, and the file type that you want to override in the TO-FILE column. The intersection specifies an I or O or both; this means that the substitution is valid for these two file types when used as input files or as output files.

For example, you can override a diskette output file with a tape output file, and a diskette input file with a tape input file. The chart refers to file type substitutions only. That is, you cannot change the program function by overriding an input file with an output file.

*Table 12. File redirections.* Valid file redirections are summarized in the following table:

To-file	From-file					
	Printer	Intersystem communications function (ICF)	Diskette	Display	Database	Tape
Printer	O*	O	O	O	O	O
ICF	O	I/O O I	O I	I/O O I	O I	O I
Diskette	O	O I	O I	O I	O I	O I
Display	O	I/O O I	O I	I/O O I	O I	O I
Database	O	O I	O I	O I	O I	O I
Tape	O	O I	O I	O I	O I	O I

**Notes:**

- I=input file O=output file I/O=input/output file
- \*=redirection to a different type of printer

**Tips about redirecting files**

Some redirection combinations present special problems due to the specific characteristics of the device.

In particular:

- You should not redirect save files.

- You can redirect nonsequentially processed database files only to another database file or a DDM file.
- You can redirect Display files and ICF files that use multiple devices (MAXDEV or MAXPGMDEV > 1) only to a display file or ICF file.
- Redirecting a display file to any other file type, or another file type to a display file, requires that the program be recompiled with the override active if there are any input-only or output-only fields. This is necessary because the display file omits these fields from the record buffer in which it does not use them, but other file types do not.

### ***Default actions for redirected files***

This topic describes the specific default actions that the system takes when it redirects files and which default actions it ignores for each redirection combination.

#### **From**

Printer

#### **To**

ICF: Records are written to the file one at a time. Printer control information is ignored.

Display: Records are written to the display with each record overlaying the previous record. For program-described files, you can request each record using the Enter key. Printer control information is ignored.

Database: Records are written to the database in sequential order. Printer control information is ignored.

Diskette: The amount of data written on diskette is dependent on the exchange type of the diskette. Diskette label information must be provided in the diskette file or on an override command. Printer control information is ignored.

Tape: Records are written to the tape in sequential order. Tape label information must be specified in the tape file or on an override command. Printer control information is ignored.

#### **From**

ICF input

#### **To**

Display: Records are retrieved from the display one at a time. Type in the data for each record and press the Enter key when the record is complete.

Database: Records are retrieved from the database.

Diskette: Records are retrieved in sequential order. Diskette label information must be provided in the diskette file or on an override command.

Tape: Records are retrieved in sequential order. Tape label information must be specified in the tape file or on the override command.

#### **From**

ICF output

#### **To**

Printer: Records are printed and folding or truncating is performed as specified in the printer file.

Display: Records are written to the display with each record overlaying the previous record.

Database: Records are written to the database in sequential order.

Diskette: The amount of data written on diskette is dependent on the exchange type of the diskette. Diskette label information must be provided in the diskette file or on an override command.

Tape: Records are written to the tape in sequential order. Tape label information must be specified in the tape file or on the override command.

**From**

ICF input/output

**To**

Display: Input records are retrieved from the display one at a time. Type in the data for each record and press the Enter key when the record is complete. Output records are written to the display with each record overlaying the previous input or output record. Input and output records are essentially independent of each other and can be combined in any manner.

**From**

Diskette input

**To**

ICF: Records are retrieved from the ICF file one at a time.

Display: Records are retrieved from the display one at a time. Type in the data for each record and press the Enter key when the record is complete. A nonfield-level device file must be specified. Diskette label information is ignored.

Database: Records are retrieved in sequential order. Diskette label information is ignored.

Tape: Records are retrieved in sequential order. If a label value is specified in the program, that value is used as the label for the tape file.

**From**

Diskette output

**To**

ICF: Records are written to the ICF file one at a time.

Database: Records are written to the database in sequential order.

Display: Records are written to the display with each record overlaying the previous record. You can request each output record using the Enter key.

Printer: Records are printed and folding or truncating is performed as specified in the printer file.

Tape: Records are written on tape in sequential order.

**From**

Display input

**To**

ICF: Records are retrieved from the ICF file one at a time.

Diskette: Records are retrieved in sequential order. Diskette label information must be provided in the diskette file or on an override command.

Database: Input records are retrieved.

Tape: Records are retrieved in sequential order. Tape label information must be specified in the tape file or on an override command.

**From**

Display output

**To**

ICF: Records are written to the ICF file one at a time.

Database: Records are written to the database in sequential order.

Diskette: The amount of data written on diskette is dependent on the exchange type of the diskette. Diskette label information must be provided in the diskette file or on an override command.

Tape: Records are written on tape in sequential order. Tape label information must be specified in the tape file or on an override command.

Printer: Records are printed and folding or truncating is performed as specified in the printer file.



**From**

Display input/output

**To**

ICF: Input records are retrieved from the ICF file one at a time. Output records are written to the ICF file one at a time. The relationship between the input and output records is determined by the application program.

**From**

Database input (sequentially processed)

**To**

ICF: Records are retrieved from the ICF file one at a time.

Display: Records are retrieved from the display one at a time. Type in the data for each record and press the Enter key when the record is complete. A nonfield-level device file must be specified.

Diskette: Records are retrieved in sequential order. Diskette label information must be provided in the diskette file or on an override command.

Tape: Records are retrieved from tape in sequential order. Tape label information must be specified in the tape file or on an override command.

**From**

Database output (sequentially processed)

**To**

Printer: The number of characters printed is determined by the page size specified. If folding is specified, all of a record is printed.

ICF: Records are written to the ICF file one at a time.

Display: Records are written to the display with each record overlaying the previous record. You can request each output record using the Enter key.

Diskette: The amount of data written on diskette depends on the exchange type of the diskette. Diskette label information must be provided in the diskette file or on an override command.

Tape: Records are written on tape in sequential order. Tape label information must be specified in the tape file or on an override command.

**From**

Tape input

**To**

ICF: Records are retrieved from the ICF file one at a time.

Display: Records are retrieved from the display one at a time. Type in the data for each record and press the Enter key when the record is complete. A nonfield-level device file must be specified. Tape label information is ignored.

Database: Records are retrieved in sequential order. One record is read as a single field. Tape label information is ignored.

Diskette: Records are retrieved in sequential order. If a label value is specified in the program, that value is used as the label for the diskette file.

**From**

Tape output

**To**

Printer: Records are printed, and folding or truncating is performed as specified in the printer file.

ICF: Records are written to the ICF file one at a time. Tape label information is ignored.

Diskette: The amount of data written on diskette depends on the exchange type of the diskette. If a label value is specified in the program, that value is used as the label for the diskette file.

Display: Records are written to the display with each record overlaying the previous record. You can request each output record using the Enter key.

Database: Records are written to the database in sequential order.

## Performance

---

There are some guidelines that you can follow to improve the performance of your copy operations.

Apart from the guidelines discussed in the preceding topics, when you copy distributed files, you need to be familiar with the various factors that affect the performance of the copy command. The DB2 Multisystem feature provides support for distributed files or files that are spread across multiple systems. When you copy distributed files, you need to be familiar with the various factors that affect the performance of the copy command. You need to be aware of restrictions that apply when you copy to and from distributed files.

**Related information**

[DB2 Multisystem](#)

### Avoiding keyed sequence access paths

A copy that requires maintenance of a keyed sequence access path is slower than a copy from or to an arrival sequence access path.

You can improve copy performance if you reorganize the from-file so that its arrival sequence is the same as its keyed sequence access path. You can also improve copy performance if you select records by using the FROMRCD or TORCD parameter so that the keyed sequence access path is not used.

Create fewer logical access paths over the to-file. This improves copy performance because the copy process does not need to update as many access paths.

The smaller the length of the records within the file, the faster the copy.

### Specifying fewer parameters

In general, you can improve copy performance if you specify fewer optional copy parameters.

The following parameters affect the performance of the copy operation:

- ERRLVL
- FMTOPT
- INCCHAR
- INCREL
- PRINT
- SRCOPT

Using the COMPRESS function does not significantly affect performance. You should request COMPRESS(\*NO) if you want deleted records in the to-file, for example, when the relative record numbers need to be identical.

## Checking record format level identifiers

You can also improve copy performance by correctly setting the record format level identifiers in the Copy File (CPYF) command.

If you are using CPYF to move data between two supposedly *identical* files, the record format level identifiers should be identical to optimize copy performance. If the record format level identifiers are not identical, CPYF goes through a longer code path that checks each field and column in every record. This can impact the time CPYF requires to complete the function if extensive checking is not required.

Record format level identifiers of the two files should be different if the files have different attributes. If they are not different, field and column-level checking does not perform, resulting in improper data conversions or none at all. Note that FMTOPT (\*NOCHK) can be specified to avoid field and column-level checking, regardless of the value of the record format level identifiers, although certain attributes of the data (such as null values) will be lost when FMTOPT (\*NOCHK) is specified.

## Preventing errors when copying files

You can prevent many copy errors when you plan for certain conditions and situations ahead of time.

### Related concepts

[Printing records \(PRINT, OUTFMT, and TOFILE\(\\*PRINT\) parameters\)](#)

By specifying PRINT special values on a copy command, you can print a list of all records copied, all records excluded, or all records causing ERRLVL output errors.

## Limitation of recoverable errors during copy

When you copy to or from a database file or from a tape file, you can limit the number of recoverable errors that you accept before the copy ends. Use the ERRLVL parameter to specify this limit.

This parameter applies to the following types of errors:

### CPF4826

Media error

### CPF5026

Duplicate key in the access path of this member. (Note: The copy command does not count CPF5026 as an ERRLVL error when you specify MBROPT(\*UPDADD) on CPYF.)

### CPF5027

Record in use by another job. (Note: The copy command only counts CPF5027 as an ERRLVL error when you specify MBROPT(\*UPDADD) on CPYF.)

### CPF5029

Data or key conversion error

### CPF502D

Referential integrity constraint violation

### CPF502E

Referential integrity constraints cannot be validated

### CPF5030

Partial damage on member

### CPF5034

Duplicate key in the access path of another member

### CPF5036

Invalid length tape block read

### CPF504B

DataLink error

### CPF504C

DataLink preparation error

## CPF5097

\*NAN (Not a Number) value not allowed in floating-point key field

The ERRLVL parameter specifies the maximum number of recoverable errors allowed for each label pair or each member copied. The value specified for ERRLVL indicates the total errors that are allowed on both the from-file and the to-file that are combined for each label pair or each member copied. Each time an error occurs, the following process runs:

1. The process increases the count for that label pair or that member by 1.
2. A message identifying the last good record that is read or written is printed on all copy lists if TOFILE(\*PRINT), PRINT(\*COPIED), or PRINT(\*EXCLD) was specified.
3. The error record is printed if you specified PRINT(\*ERROR).
4. Copying continues.
5. If the copy command completely copies the from-file member without exceeding the limit, the process resets the counter to 0, and the copy of the next member starts.
6. If the limit is exceeded during the copy of a member, copying ends and a message is sent, even if more records or members remain to be copied.

### **For a database from-file, including the open query file, the recoverable errors are:**

- those that occur when data is converted (mapped) AND
- those caused by a damaged area on the disk (in auxiliary storage)

### **For a tape from-file, the recoverable errors are:**

- a block length that is not valid AND
- a media-read operation from the tape volume on the device resulting in an error

### **For a physical to-file, the recoverable errors are:**

- those that occur when data is converted AND
- those that occur when more than one of the same key is found

Any record that causes an error is not copied to the to-file. For a write error, the record is printed on a PRINT(\*COPIED) and PRINT(\*EXCLD) printout. A message then follows this printout. This message indicates that the record was not actually copied. If you specified PRINT(\*ERROR), the command prints the records that caused write errors on the \*ERROR listing. A message then indicates that an error occurred. For a read error, no record is available to be printed on the copy printouts (TOFILE(\*PRINT), PRINT(\*COPIED), PRINT(\*EXCLD), or PRINT(\*ERROR)). However, a message prints on all specified printouts that indicates that a record cannot be read.

When the command cannot read a portion of the file from disk, partial object damage to the contents of a database file occurs. If a file is damaged in such a way, you can bypass the records that are in error by copying the good records and manually adding the records that were not copied because of the damage.

Regardless of the value of the ERRLVL parameter, recoverable errors always appear in the job log with a reply of "C" for "Cancel."

For files that have constraint relationships, the ERRLVL parameter only affects the to-file. If you set the ERRLVL parameter to 0, the copy command does not copy into the file any record that causes the to-file to violate the constraint relationship. The copy operation ends. If ERRLVL is greater than 0, the copy command does not copy into the file any record that causes the to-file to violate the constraint relationship. However, the copy operation continues until enough violations (recoverable errors) have occurred so that the ERRLVL value has been reached. If this value is exceeded, the copy operation ends.

You can use the ERRLVL parameter to bring files with constraint relationships in check pending status back into non-check pending status. Do this by setting up the dependent to-file with constraints that are the same as the dependent from-file. Then, use a CPYF command with the ERRLVL(\*NOMAX) to copy all valid records. The to-file should not contain any records. The copy command does not insert into the to-file any records that it encounters from the from-file that would cause the to-file constraints to go

to check pending status. With ERRVLV set to \*NOMAX, the copy command processes all records in the from-file.

Other copy commands, Copy Source File (CPYSRCF), Copy From Tape (CPYFRMTAP), and Copy To Tape (CPYTOTAP), end immediately if the systems signals one of the recoverable errors because there is no ERRVLV parameter for them.

## **Prevention of date, time, and timestamp errors when copying files**

For FMTOPT(\*MAP), FROMKEY with \*BLDKEY, TOKEY with \*BLDKEY, and INCREL parameters, 2-digit year-date fields or values will be assumed to have a century of 19 if the year is in the range from 40 to 99, or a century of 20 if the year is in the range from 00 to 39.

For example, 12/31/91 is considered December 31, 1991, while 12/31/38 is considered December 31, 2038.

However, any from-files containing 2-digit year-date fields with actual internal date values outside the range January 1, 1940 to December 31, 2039 cause input mapping errors, and the copy operation fails.

When FMTOPT(\*MAP) is used to convert or copy a from-file field date value in a 4-digit year form to a 2-digit year form, the from-file field value must be within the range of January 1, 1940 to December 31, 2039. Otherwise, a mapping error occurs, and the copy command sets the to-file field with its default value.

Likewise, when using a 4-digit year date as a record selection input string on FROMKEY with \*BLDKEY or TOKEY with \*BLDKEY, the value must be within the same range if the corresponding from-file field is a date field with a 2-digit year-date. Otherwise, an error occurs. INCREL record selection is the exception to this rule, as 4-digit year date values outside this range might be used for corresponding 2-digit year-date fields.

### ***Mapping considerations using the Copy Object command***

Here are some mapping considerations when you use the Copy Object (COPY) command.

**When mapping a character field to a date, time, or timestamp field** and a format form is being used in the character field, leading zeros can be omitted from month, day, and hour parts. Microseconds can be truncated or omitted entirely in the character field.

**For mapping to time fields**, the seconds part (and corresponding separator) can be omitted from the character field.

For \*USA form values, the AM or PM with a preceding blank is required. These rules are also true for date, time, or timestamp values that are entered when using FROMKEY with \*BLDKEY, TOKEY with \*BLDKEY, or INCREL parameters on the CPYF command. All other instances of date, time, and timestamp data require leading zeros when necessary and no truncation.

**For both forms of the TOKEY parameter (\*BLDKEY or non-\*BLDKEY) the from-field data must be in a particular format for a chronological comparison to be made.** For the date field, you must use the \*ISO or \*JIS format to make a chronological comparison. For the time fields, you must use the \*HMS, \*ISO, \*EUR, or \*JIS formats to make the chronological comparison. For any other formats of date or time fields (for date (\*MDY, \*DMY, \*YMD, \*JUL, \*EUR, or \*USA) or for time (\*USA)), chronological comparisons are not possible because the TOKEY parameter performs a straight character string comparison. When you cannot make chronological comparisons, the system sends an informational message, and the copy operation continues.

**When copying data into a file with date, time, or timestamp fields, and the from-file is a device file or FMTOPT(\*NOCHK) or FMTOPT(\*CVTSRC) has been specified**, output mapping errors might occur if the data copied to a date, time, or timestamp field is not valid data for the to-file field format and separator attributes. You cannot copy the record if this occurs. If you use the CPYF or CPYFRMQRYF command, you can specify an error level other than zero (ERRVLV parameter) to bypass the record and continue the copy operation. When copying into date, time, or timestamp fields in these instances, it is important that the from-file data is valid for the to-file.

## Prevention of position errors when copying files

When the copy file function cannot locate the first record to copy in the from-file member, a position error occurs.

This can happen when using the Copy File (CPYF), Copy Source File (CPYSRCF), or Copy To Tape (CPYTOTAP) commands. If any of the following conditions are true, you might receive a position error for the from-file member:

- You specified the FROMKEY parameter, and all records in the member are less than the FROMKEY value or the member is empty.
- You specified the FROMRCD parameter beyond the end of the member or the member is empty.
- The value of the from-file member position (the POSITION parameter of the Override with Data Base File (OVRDBF) command) is beyond the end of the member, is not valid for the access path of the from-file, or the member is empty.

If a member position error occurs, the member cannot be added to the to-file, and no information about the member is added to the print lists.

If a member position error occurs during a copy operation that involves multiple members, the copy operation will continue with the next member.

If a member position error occurs for all members, a print list is not produced, and the to-file cannot be created.

## Prevention of allocation errors when copying files

The IBM i operating system places locks on the from-file and the to-file when you copy files. To prevent allocation errors when copying files, you can place stronger locks on those files.

When a database file is copied, each from-file member is allocated with a shared-for-read (\*SHRRD) lock state. When a device file is copied, the copy command allocates it with a shared-for-read (\*SHRRD) lock state. The copy command allocates the member only while it copies it. A shared-for-read lock state lets other users read and update the file while you are copying it.

Generally, the member being copied to is allocated with a shared-for-update (\*SHRUPD) lock state. However, if you specify MBROPT(\*REPLACE), the command allocates the member you are copying to with an exclusive (\*EXCL) lock state, and the records in the to-file are removed

When you are copying one physical file to another, you can place stronger locks on the members to allow internal system functions to perform the copy.

- The command can allocate the from-file member with an exclusive-allow-read (\*EXCLDRD) lock state.
- The command can allocate the to-file member with an exclusive (\*EXCL) lock state.

The command requires these stronger locks depending on the type of copy you perform. If you cannot get these locks, run the copy command and specify a value of 1 (or any valid value other than 0) on the ERRVLV parameter. These values do not require the stronger locks.

There are many reasons for allocation errors when you copy files. For instance, you should not use functions that touch the to-file during the copy.

### ***Reasons for allocation errors when copying files***

If another job allocates a member with too strong a lock state, the copy operation might end with an error message. This is also true if the library containing the file is renamed during the copy operation.

When a copy command runs, the to-file might be locked (similar to an \*EXCL lock with no time-out) so that no access is possible. Any attempt to use a function that must touch the to-file locks up the workstation until the copy command completes. For instance, you should not use the following functions on a to-file that you are copying:

WRKACTJOB  
Option 11 (Work with Locks)

Option 5 (Work with Job Member Locks)  
Option 8 (Work with Object Locks)  
DSPDBR  
DSPFD  
DSPFFD  
WRKJOB  
Option 12 (Work with Locks, if active)  
Option 5 (Work with Job Member Locks)  
F10 (Display Open Files, if active)  
WRKLIB  
The library containing the to-file  
DSPLIB  
The library containing the to-file  
WRKOBJLCK  
WRKRCDLCK

If you want to display any information about a to-file, you must anticipate the requirement and force the copy command to use block record-at-a-time operations by specifying `ERRLVL(1)`.

If you anticipate that problems might arise because of this, you can preallocate the files and members using the [Allocate Object \(ALCOBJ\)](#) command.

### **Related information**

[Control language](#)

## **Prevention of copy errors that result from constraint relationships**

A *constraint relationship* is a mechanism to ensure data integrity between a dependent file and a parent file. You need to pay attention to the constraint relationship when copying files.

A constraint relationship exists between a dependent file and a parent file when every non-null foreign key value in the foreign key access path of the dependent file matches a parent key value in the parent key access path of the parent file. A physical data file can be a parent or dependent file. However, a source physical file cannot be a parent or a dependent file.

Following are some copy commands and the relationships allowed:

- [Copy File \(CPYF\)](#) - from-file or to-file can be a parent or dependent file
- [Copy From Query File \(CPYFRMQRYP\)](#) - to-file can be a parent or dependent file
- [Copy From Tape \(CPYFRMTAP\)](#) - to-file can be a parent or dependent file
- [Copy To Tape \(CPYTOTAP\)](#) - from-file can be a parent or dependent file

### **Related concepts**

[Copy operation on files not in check-pending status](#)

When the parent or dependent file has an established constraint relationship that is not in check-pending status, the rules described in this topic apply.

[Copy operation on files in check-pending status](#)

When the parent or dependent file has an established constraint relationship that is in check-pending status, the rules described in this topic apply.

## **Copy operation on files not in check-pending status**

When the parent or dependent file has an established constraint relationship that is not in check-pending status, the rules described in this topic apply.

- If the from-file has an established constraint relationship, then you can copy all of the records from it whether it is a parent or dependent file.
- If the to-file has an established or enabled constraint relationship, then the following rules apply to keep the constraint relationship from entering check-pending status:

- A parent file cannot have its member cleared of records.
- A parent file cannot have more than one parent key value in the parent key access path of the same value (key must remain unique). That is, if the to-file is a parent file in a constraint relationship, then the copy does not allow duplicate key records to be copied into it.
- A dependent file's foreign key values that are not null must always have a corresponding parent key value. That is, if the to-file is a dependent file in a constraint relationship, the copy operation does not allow non-null foreign key records that do not have a corresponding parent key record to be copied into the dependent file.

The copy operation ensures that the data in the parent or dependent to-file is not damaged. Records can be copied to the to-file provided they do not cause the constraint relationship to go into check-pending status. If a user attempts to copy a record that does not meet the constraint relationship rules, the copy operation ends unless the `ERRLVL` parameter has been specified (`Copy File (CPYF)` and `Copy From Query File (CPYFRMQRYF)` commands only) with a value greater than zero.

To circumvent the above rules, you can disable the involved constraints before the copy operation, perform the copy, and then re-enable the constraints. However, the file is in check-pending status if constraint rules are still not met.

### Related concepts

Prevention of copy errors that result from constraint relationships

A *constraint relationship* is a mechanism to ensure data integrity between a dependent file and a parent file. You need to pay attention to the constraint relationship when copying files.

## Copy operation on files in check-pending status

When the parent or dependent file has an established constraint relationship that is in check-pending status, the rules described in this topic apply.

- If the from-file has an established constraint relationship in check pending, data access is restricted. If the from-file is a parent file, the command can read and copy data to the to-file. If the from-file is a dependent file, the command cannot read data to the to-file, and therefore cannot copy the data to the to-file.
- If the to-file has an established constraint relationship in check pending status, data access is restricted. If the to-file is a parent file, you can add new records (you can specify `MBROPT(*ADD)`). If the to-file is a parent file, you cannot clear the file (you cannot specify `MBROPT(*REPLACE)`). If the to-file is a dependent file, you cannot perform the copy regardless of which `MBROPT` parameter keyword you use.

To circumvent the above rules, you can disable the involved constraints before the copy operation, perform the copy, and then re-enable the constraints. However the file will be in check pending status if constraint rules are still not met.

### Related concepts

Prevention of copy errors that result from constraint relationships

A *constraint relationship* is a mechanism to ensure data integrity between a dependent file and a parent file. You need to pay attention to the constraint relationship when copying files.

## Prevention of copy errors related to your authority to files

The table in this topic summarizes the authority that is required for the from-file and the to-file.

<i>Table 13. Authority required to perform copy operation</i>		
	<b>From-file</b>	<b>To-file</b>
DDM file	*OBJOPR *READ	*OBJOPR <sup>1</sup> *ADD
Device file <sup>2</sup>	*OBJOPR *READ	*OBJOPR *READ
Logical file	*OBJOPR <sup>3</sup> *READ	Not allowed



Table 13. Authority required to perform copy operation (continued)

	From-file	To-file
Physical file	*OBJOPR *READ	*OBJOPR <sup>1</sup> *ADD
<b>Notes:</b>		
<b>1</b>		
This is the authority required for MBROPT(*ADD). If MBROPT(*REPLACE) is specified, *OBJMGT and *DLT authority are also required. If MBROPT(*UPDADD) is specified, *UPD authority is also required.		
<b>2</b>		
*OBJOPR and *READ authority is also required for any devices used for the file.		
<b>3</b>		
Also requires *READ authority to the based-on physical file members for the logical file members copied.		

If the to-file does not exist and CRTFILE(\*YES) is specified so that the copy command creates the to-file, then you must have operational authority to the [Create Physical File \(CRTPF\)](#) command.

## Security

The IBM i operating system provides many security features that help you control access to data and files.

These topics describe some of the file security functions. The topics covered include types of object authority including object operational, object existence, object management, object reference, and object alter authorities. Data authority and why you would want to limit user access to data is also described. Other topics that are included are authorities that are required for file operations and how to limit access to files and data when you are creating files.

### Related information

[Security reference](#)

[Planning and setting up system security](#)

## Object authority

There are several types of authority that can be granted to a user for a file. Also, you can use the SQL GRANT and REVOKE statements to assign and remove these IBM i authorities to SQL tables, including individual columns within those tables.

### Related information

[DB2 for i5/OS SQL reference](#)

## Object operational authority

Object operational authority allows you to look at an object description and use the object as determined by your data authorities to the object.

Object operational authority is required to:

- Open the file for processing. You must also have read authority to the file. For device files that are not using spooling, you must have object operational and also all data authorities to the device.
- Compile a program which uses the file description.
- Display the file description.
- Delete the file.
- Transfer ownership of the file.
- Grant and revoke authority.
- Change the file description.

- Move or rename the file.

## **Object existence authority**

Object existence authority allows you to change the existence status of a file.

Object existence authority is required to:

- Delete the file.
- Save, restore, and free the storage of the file.
- Transfer ownership of the file.

## **Object management authority**

Object management authority allows you to perform many operations on a file.

Object management authority is required to:

- Grant and revoke authority. You can grant and revoke only the authority that you already have.
- Change the file description.
- Move or rename the file.
- Refer to a database file from another database file.
- Add triggers to and remove triggers from database files.
- Add referential and unique constraints to database files.
- Remove referential and unique constraints to database files.
- Change the attributes of a database file.
- Change the attributes of a SQL package.

## **Object reference authority**

Object reference authority allows you to refer to a database file from another database file. The operations that you can perform on the referred-to database file are determined by the referring database file.

## **Object alter authority**

Object alter authority allows you to alter the attributes of a database file or SQL package.

Object alter authority is required to:

- Add triggers to and remove triggers from database files.
- Add referential and unique constraints to database files.
- Remove referential and unique constraints to database files.
- Change the attributes of a database file.
- Change the attributes of a SQL package.

## **Data authorities**

You can use data authorities to limit user access to the data in files.

You need the following authorities to perform the associated operations:

### **Execute**

Run a program or locate an object in a library.

### **Read**

Open any file for input, compile a program using the file, or display the file description.

### **Add**

Add new records to the file.

**Update**

Open a database file for update.

**Delete**

Open a database file for delete.

For files other than database and save files, the execute, the add, update, and delete authorities are ignored.

## Authorities required for file operations

This topic lists the file object authority and data authority required for file functions.

Table 14 on page 117 lists the file object authority required for file functions. Table 15 on page 118 lists the data authority required for file functions. This is the same information that was presented in the previous two sections, but it is listed by function rather than by authority.

*Table 14. Object authority required for file operations.* The file object authority required for file functions

<b>Function</b>	<b>Object operational</b>	<b>Object existence</b>	<b>Object management</b>	<b>Object reference</b>	<b>Object alter</b>
Open, I/O, close file <sup>1</sup>	X				
Compile a program using the file description	X				
Display file description	X				
Delete file	X	X			
Save/restore		X			
Transfer ownership	X	X			
Grant/revoke authority	X		X		
Change file description	X		X		
Move file	X		X		
Rename file	X		X		
Replace file	X	X	X		
Refer to another file <sup>2</sup>			X	X	
Add or remove file constraints <sup>3</sup>			X		X
Add or remove triggers <sup>4</sup>			X		X
Change attributes <sup>5</sup>			X		X

Table 14. Object authority required for file operations. The file object authority required for file functions (continued)

Function	Object operational	Object existence	Object management	Object reference	Object alter
<b>Notes:</b>					
1	For device files that are not using spooling, you must also have object operational and all data authorities to the device.				
2	For database files only.				
3	For database files only. Parent files need object management or object reference authority. Dependent files need object management or object alter authority.				
4	For database files only. Files need object management or object alter authority.				
5	For database files and SQL packages only. Files need object management or object alter authority.				

Table 15. Data authority required for file operations. The data authority required for file functions.

Function	Execute	Read	Add	Update	Delete
Open, I/O, close file <sup>1</sup>		X	X <sup>2</sup>	X <sup>3</sup>	X <sup>3</sup>
Compile a program using the file description		X			
Run a program or locate an object in a library	X				
Display file description		X			
Replace file		X			
Add or remove triggers <sup>4</sup>		X	X <sup>5</sup>	X <sup>6</sup>	X <sup>7</sup>

Table 15. Data authority required for file operations. The data authority required for file functions. (continued)

Function	Execute	Read	Add	Update	Delete
<b>Notes:</b>					
1	For device files that are not using spooling, you must also have object operational and all data authorities to the device.				
2	Open for output for database and save files.				
3	Open for update or delete for database files.				
4	For database files only.				
5	Add authority required in addition to Read authority for inserting triggers.				
6	Update authority required in addition to Read authority for updating triggers.				
7	Delete authority required in addition to Read authority for deleting triggers.				

## Limitation of access to files and data when creating files

Specifying authorities allows you to control access to a file. You use the AUT parameter on the create command to specify public authority when you create a file.

### What public authority is

Public authority is authority that is available to any user who does not have specific authority to the file or who is not a member of a group that has specific authority to the file. That is, if the user has specific authority to a file or the user is a member of a group with specific authority, then the public authority is not checked when a user performs an operation to the file. Public authority can be specified as:

- \*LIBCRTAUT. All users that do not have specific user or group authority to the file have authority determined by the library in which the file is being created. The library value is specified by the \*CRTAUT command to establish a public authority for this library.
- \*CHANGE. All users that do not have specific user or group authority to the file have authority to use the file. The \*CHANGE value is the default public authority. \*CHANGE grants any user object operational and all data authorities.
- \*USE. All users that do not have specific user or group authority to the file have authority to use the file. \*USE grants any user object operational, execute, and read data authority.
- \*EXCLUDE. Only the owner, security officer, users with specific authority, or users who are members of a group with specific authority can change or use the file.
- \*ALL. All users that do not have specific user or group authority to the file have all data authorities and all object authorities.
- Authorization list name. An authorization list is a list of users and their authorities. The list allows users and their different authorities to be grouped together.

### Specifying or changing authorities on existing files

To specify or change public authority on an existing file, use the [Edit Object Authority \(EDTOBJAUT\)](#), [Grant Object Authority \(GRTOBJAUT\)](#), or [Revoke Object Authority \(RVKOBJAUT\)](#) commands to grant or revoke the public authority of a file.

## Related concepts

[File types](#)

The file management functions support these types of files.

## Related information

[Security reference](#)

[Planning and setting up system security](#)

# Troubleshooting database file management

---

The IBM i operating system provides system reports and error messages when errors occur. You can take corresponding actions according to the errors.

## File error detection and handling by the system

The system can detect errors when a file is opened, when a program device is acquired or released, during I/O operations to a file, and when the file is closed.

When appropriate, the system will automatically try to run a failing operation again, up to a try again limit. When a try again is successful, neither operator nor program action is required.

## How the system reports errors

The system reports errors that can affect the processing of the program in any or all of the following ways:

- A notify, status, diagnostic, or escape message might be sent to the program message queue of the program using the file. These messages might also appear in the job log, depending on the message logging level that is set for the job. See [“Messages and message monitors in files by the system”](#) on page 121 for more information.
- The high-level language might return a file status code.
- A major and minor return code is returned in the I/O feedback area for intersystem communications function (ICF), display, and printer files. See [“Major and minor return codes in files by the system”](#) on page 122 for more information.
- A notify, status, diagnostic, or escape message might be sent to the operator message queue (QSYSOPR) or the history message queue (QHST).
- Information regarding the error might be saved in the system error log for use by the problem analysis and resolution programs.
- An alert message might be sent to an operator at another system in the network.
- The normal program flow might be interrupted and control might be transferred to an error-handling subroutine, or other language operations might occur. For additional information about how to handle runtime errors, see the appropriate book for the high-level language.

Only some of these are significant to a program that is attempting error recovery.

## Actions to take when you receive an error

See [“Recovery from file system errors”](#) on page 124 for information about the actions you should take when you receive an error.

## Unrecoverable errors

Not all file errors allow programmed error recovery. Some errors are permanent; that is, the file, device, or program cannot work until you take some corrective action. This might involve resetting the device by varying it off and on again, or correcting an error in the device configuration or the application program. Some messages and return codes inform the user or the application program of conditions that are information rather than errors, such as a change in the status of a communications line or a system action taken for an unexpected condition. In many cases, it is possible for the application program to test for an

error condition and take some preplanned recovery action that allows the program to continue without intervention from the operator.

### **Related information**

[Control language](#)

[Basic system operations](#)

## **Messages and message monitors in files by the system**

Displayed messages are the primary source of information for an operator or a programmer who is testing a new application.

A message typically contains more specific information than the file status code, the indicators, and the major and minor return code. The control language lets you monitor messages so that the CL program can intercept a message and take corrective action.

The Messages section in the CL topic has more information about message types and message monitors. In most high-level languages, the file status code and return codes (which are described in the following section) are more convenient sources of information.

Message numbers are assigned in categories to make it easier for a program to monitor for a group of related messages. The following table shows the message number ranges that are assigned for file error messages.

---

*Table 16. Number ranges of the IBM i file management message.* Message number ranges are assigned for file error messages to make it easier for a program to monitor for a group of related messages.

---

<b>Message IDs</b>	<b>Operation</b>	<b>Message type</b>
CPF4001-40FF	Open	Diagnostic and status.
CPF4101-43FF	Open	Escape messages that make the file unusable.
CPF4401-44FF	Close	Diagnostic and status.
CPF4501-46FF	Close	Escape messages that make the file unusable.
CPF4701-48FF	I/O, Acquire, and Release	Notify with a default reply of cancel, status, and escape messages that do not make the file or device unusable.
CPF4901-49FF	I/O, Acquire, and Release	Notify with a default reply of ignore or go.
CPF5001-50FF	I/O, Acquire, and Release	Notify with a default reply of cancel.
CPF5101-53FF	I/O, Acquire, and Release	Escape messages that make the file or device unusable.

---

*Table 16. Number ranges of the IBM i file management message. Message number ranges are assigned for file error messages to make it easier for a program to monitor for a group of related messages. (continued)*

<b>Message IDs</b>	<b>Operation</b>	<b>Message type</b>
CPF5501-56FF	I/O, Acquire, and Release	Escape messages that make the file or device unusable.

Some status messages, CPF4018 for example, are preceded by a diagnostic message that provides additional information. Diagnostic messages can be kept in the job log, depending on the message logging level of the job. If a CL program monitors for CPF4018, CPF5041, or similar messages, it can retrieve the accompanying diagnostic message from the program message queue.

If an error occurs for which an escape message is issued and the message is not monitored, your program will be ended and the message displayed for the operator. You can also monitor status messages, but if you do not monitor them the program continues. Most high-level languages except CL monitor for all the file errors that you are likely to encounter, and provide some standard recovery. Depending on the severity of the error, the high-level language might end the program and issue a message of its own. Alternatively, the application programmer can code an error recovery routine to handle errors that are anticipated in that particular application.

Within these error-handling routines, it is typically necessary to examine the file status or major and minor return codes to determine the cause of the error. The books for the language you are using explain how to access file status and major and minor return codes. The information for each language also explains the file status codes as each language defines them.

#### **Related information**

[Control language](#)

## **Major and minor return codes in files by the system**

Major and minor return codes report errors and certain status information for ICF, display, and printer files. They are not used for other files. They typically appear as four characters: the first two refer to the major code and the second two refer to the minor code.

The major code indicates the general type of error, and the minor provides further detail. Minor codes, except zero, have the same or a similar meaning, regardless of the major code with which they are combined.

The application program can test the return code after each I/O operation. If the major return code is 00, the operation completed successfully and the minor return code contains status information that indicates whether a read or a write operation should be performed next. A major return code of 04 or higher indicates that an error occurred. The program can test for any specific errors for which it will attempt programmed recovery. The application program can test for a specific condition by comparing the major and minor codes as a unit, or can identify a class of conditions by testing the major code alone.

Most major and minor return codes are accompanied by any one of several message numbers, for which the typical recovery action is similar. The individual languages file status codes; they can set based on the major and minor return codes.

Table 17 on page 123 defines the major return codes. See the Application Display Programming book for specific definitions of the major and minor return codes as they are used for display files and the message numbers associated with each. Similar specific definitions for printer files and each of the communications types valid on an ICF file can be found in the printing information and the books for each communications type.



*Table 17. Major return code definitions.* The major return codes and their definitions are outlined.

<b>Code</b>	<b>Definition</b>
00	The operation requested by your program completed successfully. The minor includes state information, such as change direction.
02	Input operation completed successfully, but job is being ended (controlled). The minor includes state information.
03	Successful input operation, but no data was received. The minor includes state information.
04	Error occurred because an output operation was attempted while data was waiting to be read.
08	An acquire operation failed because the device has already been acquired or the session has already been established.
11	A read-from-invited-program-devices operation failed because no device or session was invited.
34	An input exception occurred. The data length or record format was not acceptable for the program.
80	A permanent (unrecoverable) system or file error occurred. Programmer action is required to correct the problem.
81	A permanent (unrecoverable) device or session error occurred during an I/O operation.
82	A device or session error occurred during an open or acquire operation. Recovery might be possible.
83	A device or session error occurred during an I/O operation. Recovery might be possible.

**Related information**

[Application Display Programming PDF](#)

[Printing](#)

## Recovery from file system errors

This section describes the errors you might receive and the actions you should take to recover from those errors.

### Normal completion of errors by the system

A major and minor return code of 0000 indicates that the operation requested by your program completed successfully.

Most of the time, the system issues no message. In some cases, the system might use a diagnostic message to inform the user of some unusual condition that cannot be handled but might be considered an error under some conditions. For example, the system might ignore a parameter that is not valid, or it might take some default action.

For communications devices, a major return code of 00, indicating successful completion with data received, is accompanied by a minor return code that indicates what operation the application program is expected to perform next. The nonzero minor does not indicate an error. No message is issued.

### Completion with exceptions of errors by the system

The system assigns several rather specific major return codes (such as 02, 03, and 0309) to conditions for which a specific response from the application program is appropriate.

A major return code of 02 indicates that the requested input operation completes successfully, but the system is ending the job with a controlled cancel operation. The application program must complete its processing as quickly as possible. With the controlled cancel operation, programs can end orderly. If your program does not end within the time that is specified on the End Job (ENDJOB) command, the system ends the job without further notice.

A major return code of 03 indicates that an input operation completed successfully without transferring any data. For some applications, this might be an error condition, or it might be expected when the user presses a function key instead of entering data. It might also indicate that all the data has been processed, and the application program should proceed with its completion processing. In any case, the contents of the input buffer in the program should be ignored.

A major and minor code of 0309 indicates that the system received no data and is ending the job in a controlled manner. A major and minor code of 0310 indicates that there is no data because the specified wait time has ended. Other minor return codes accompanying the 02 or 03 major code are the same as for a 00 major code, indicating communications status and the operation to be performed next.

A major return code of 04 indicates that an output exception occurred. Specifically, your program attempted to send data when data should have been received. This is probably the result of not handling the minor return code properly on the previous successful completion. Your program can recover by just receiving the incoming data and then repeating the write operation.

A major return code of 34 indicates that an input exception occurred. The received data was either too long or incompatible with the record format. The minor return code indicates what was wrong with the received data, and whether the data was truncated or rejected. Your program can probably handle the exception and continue. If the data was rejected, you might be able to read it by specifying a different record format.

Two other return codes in this group, 0800 and 1100, are both typically the result of application programming errors, but are still recoverable. 0800 indicates that an acquire operation failed because the device has already been acquired or the session has already been established. 1100 indicates that the program attempted to read from invited devices with no devices invited. In both cases, the program ignored the request that is not valid, and the program can continue.

No message is issued with a 02 major code or most minor codes with the 03 major code, but the other exceptions in this group are typically accompanied by a message in the CPF4701-CPF47FF or CPF5001-CPF50FF range.

## Permanent system or file error

A major return code of 80 indicates a serious error that affects the file.

The application program must close the file and reopen it before attempting to use it again, but recovery is unlikely until the problem causing the error is found and corrected. To reset an error condition in a shared file by closing it and opening it again, all programs sharing the open data path must close the file. This might require returning to previous programs in the call stack and closing the shared file in each of those programs. The operator or programmer should refer to the text of the accompanying message to determine what action is appropriate for the particular error.

Within this group, several minor return codes are of particular interest. A major and minor code of 8081 indicates a serious system error that probably requires an authorized program analysis report (APAR). The message sent with the major and minor return code might direct you to run the [Analyze Problem \(ANZPRB\)](#) command to obtain more information.

A major and minor code of 80EB indicates that incorrect or incompatible options were specified in the device file or as parameters on the open operation. In most cases you can close the file, end the program, correct the parameter that is not valid with an override command, and run the program again. The override command affects only the job in which it is issued. It allows you to test the change easily, but you might eventually want to change or re-create the device file as appropriate to make the change permanent.

## Permanent device or session error on I/O operation

A major return code of 81 indicates a serious error that affects the device or session.

These errors include hardware failures that affect the device, communications line, or communications controller. It also includes errors because of a device being disconnected or powered off unexpectedly, and abnormal conditions that are discovered by the device and reported back to the system. Both the minor return code and the accompanying message provide more specific information about the cause of the problem.

Depending on the file type, the program must either close the file and open it again, release the device and acquire it again, or acquire the session again. To reset an error condition in a shared file by closing it and opening it again, all programs sharing the open data path must close the file. In some cases, the message might instruct you to reset the device by varying it off and on again. It is unlikely that the program will be able to use the failing device until the problem causing the error is found and corrected, but recovery within the program might be possible if an alternate device is available.

Some of the minor return codes in this group are the same as those for the 82 major return code. Device failures or line failures might occur at any time, but an 81 major code occurs on an I/O operation. This means that your program had already established a link with the device or session. Therefore, the program can transfer some data, but when the program starts from the beginning when it starts again. A possible duplication of data might result.

Message numbers accompanying an 81 major code might be in the range that indicates either an I/O or a close operation. A device failure on a close operation might be the result of a failure in sending the final block of data, rather than action specific to closing the file. An error on a close operation can cause a file to not close completely. Your error recovery program should respond to close failures with a second close operation. The second close will always complete, regardless of errors.

## Device or session error on open or acquire operation

A major return code of 82 indicates that a device error or a session error occurred during an open or acquire operation. Both the minor return code and the accompanying message will provide more specific information regarding the cause of the problem.

Some of the minor return codes in this group are the same as those for the 81 major return code. Device or line failures might occur at any time, but an 82 major code indicates that the device or session was unusable when your program first attempted to use it. Thus no data was transferred. The problem might be the result of a configuration or installation error.

Depending on the minor return code, it might be appropriate for your program to recover from the error and try the failing operation again after some waiting period. You should specify the number of times you try in your program. It might also be possible to use an alternate or backup device or session instead.

Message numbers accompanying an 82 major code might be in the range that indicates either an open or acquire operation. If the operation is an open operation, it is necessary to close the partially opened file and reopen it to recover from the error. If the operation is an acquire operation, it might be necessary to do a release operation before trying the acquire operation again. In either case, specify a wait time for the file that is long enough so that the system can recover from the error.

## Recoverable device or session errors on I/O operation

A major return code of 83 indicates that an error occurred in sending data to a device or receiving data from the device. Recovery by the application program is possible. Both the minor return code and the accompanying message provide more specific information regarding the cause of the problem.

Most of the errors in this group are the result of sending commands or data that are not valid to the device, or sending valid data at the wrong time or to a device that is not able to handle it. The application program can recover by skipping the failing operation or data item and going on to the next one, or by substituting an appropriate default. There might be a logic error in the application.

## Reference

---

You can select any of the reference topics on the navigation bar or from the list in this topic for quick access to specific reference information such as character support, feedback area layouts, and other support considerations.

## Double-byte character set support

This section contains information that you need if you use double-byte characters.

DBCS printer and spooling support information can be found in [Printing](#).

### Double-byte character set fundamentals

Some languages, such as Chinese, Japanese, and Korean, have a writing scheme that uses many different characters that cannot be represented with single-byte codes. To create coded character sets for such languages, the system uses 2 bytes to represent each character. Characters that are encoded in 2-byte code are called double-byte characters.

[Figure 20 on page 127](#) shows alphanumeric characters coded in a single-byte code scheme and double-byte characters coded in a double-byte code scheme.

You can use double-byte characters as well as single-byte characters in one application. For instance, you might want to store double-byte data and single-byte data in your database, create your display screens with double-byte text and fields, or print reports with double-byte characters.

1-Byte Code (SBCS)	2-Byte Code (DBCS)
A — X'C1'	A — X'42C1'
B — X'C2'	B — X'42C2'
1 — X'F1'	1 — X'42F1'
2 — X'F2'	2 — X'42F2'
	あ — X'4481' (Japanese)
	美 — X'457D' (Japanese)
	才 — X8877' (Korean)
	橋 — X'4589' (Japanese)
	进 — X'4F99' (Simplified Chinese)
	進 — X'5B70' (Traditional Chinese)

X'hhhh' indicates that the code has the hexadecimal value, "hhhh".

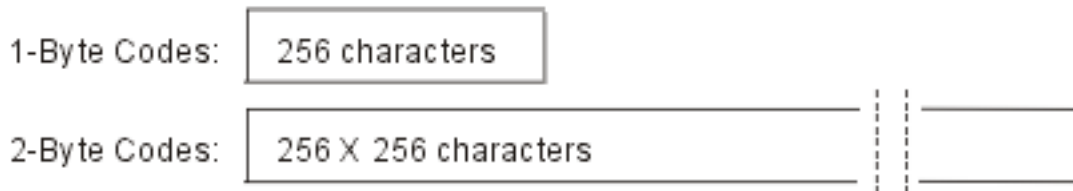

Figure 20. Single-byte and double-byte code schemes

### **DBCS code scheme**

IBM supports two DBCS code schemes: one for the host systems, the other for personal computers.

The IBM-host code scheme has the following code-range characteristics:

#### **First byte**

Hexadecimal 41 to hexadecimal FE

#### **Second byte**

Hexadecimal 41 to hexadecimal FE

#### **Double-byte blank**

Hexadecimal 4040

In Figure 21 on page 128, using the first byte as the vertical axis and the second byte as the horizontal axis, 256 x 256 intersections or code points are expressed. The lower-right code area is designated as the valid double-byte code area and x is assigned to the double-byte blank.

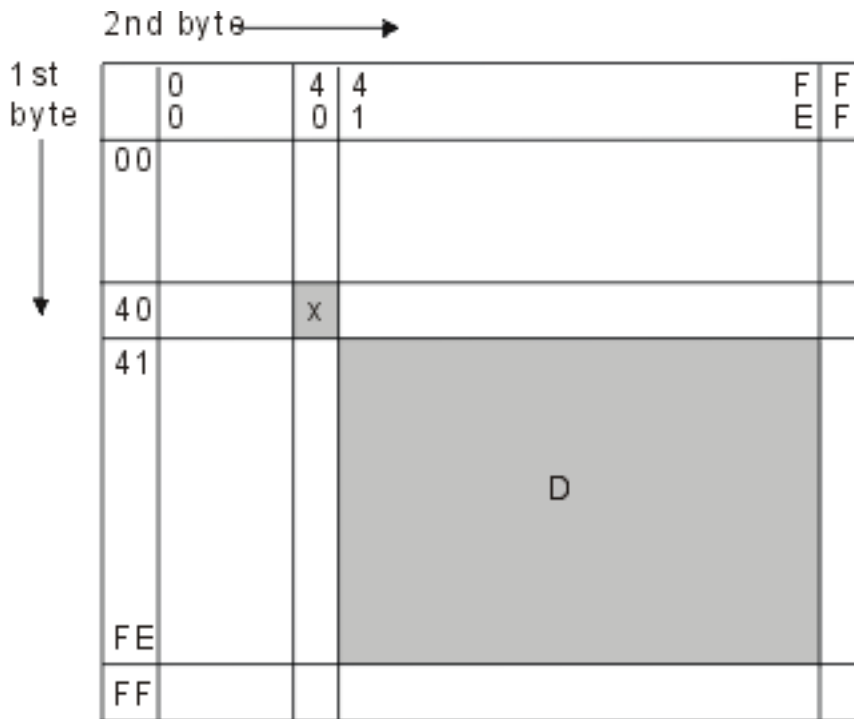

D: double-byte code area  
 x: double-byte blank

Figure 21. IBM-host code scheme

By assigning the values hexadecimal 41 to hexadecimal FE in the first and second bytes as the DBCS codes, the codes can be grouped in wards with 192 code points in each ward. For example, the code group with the first byte starting with hexadecimal 42 is called *ward 42*. Ward 42 has the same alphanumeric characters as those in a corresponding single-byte EBCDIC code page, but with double-byte codes. For example, the character *A* is represented in single-byte EBCDIC code as hexadecimal C1 and in IBM-host code as hexadecimal 42C1.

The IBM i operating system supports the following double-byte character sets:

- IBM Japanese character set
- IBM Korean character set
- IBM Simplified Chinese character set
- IBM Traditional Chinese character set

The following tables show the code ranges for each character set and the number of characters supported in each character set.

Table 18. IBM Japanese character set

Wards	Content	Number of characters
40	Space in 4040	1
41 to 44	Non-Kanji characters <ul style="list-style-type: none"> <li>• Greek, Russian, Roman numeric (Ward 41)</li> <li>• Alphanumeric and related symbols (Ward 42)</li> <li>• Katakana, Hiragana, and special symbols (Ward 43-44)</li> </ul>	549

---

*Table 18. IBM Japanese character set (continued)*

---

<b>Wards</b>	<b>Content</b>	<b>Number of characters</b>
45 to 55	Basic Kanji characters	3226
56 to 68	Extended Kanji characters	3487
69 to 7F	User-defined characters	Up to 4370
80 to FE	Reserved	

Total number of IBM-defined characters: 7263

---

---

*Table 19. IBM Korean character set*

---

<b>Wards</b>	<b>Content</b>	<b>Number of characters</b>
40	Space in 4040	1
41 to 46	Non-Hangeul/Hanja characters (Latin alphabet, Greek, Roman, Japanese Kana, numeric, special symbols)	939
47 to 4F	Reserved	
50 to 6C	Hanja characters	5265
6D to 83	Reserved	
84 to D3	Hangeul characters (Jamo included)	2672
D4 to DD	User-defined characters	Up to 1880
DE to FE	Reserved	

Total number of IBM-defined characters: 8877

---

---

*Table 20. IBM Simplified Chinese character set*

---

<b>Wards</b>	<b>Content</b>	<b>Number of characters</b>
40	Space in 4040	1

---

---

Table 20. IBM Simplified Chinese character set (continued)

---

<b>Wards</b>	<b>Content</b>	<b>Number of characters</b>
41 to 47	Non-Chinese characters (Latin alphabet, Greek, Russian, Japanese Kana, numeric, special symbols)	712
48 to 6F	Chinese characters: Level 1 and Level 2	3755 and 3008
70 to 75	Reserved	
76 to 7F	User-defined characters	Up to 1880
80 to FE	Reserved	
Total number of IBM-defined characters: 7476		

---

Table 21. IBM Traditional Chinese character set

---

<b>Wards</b>	<b>Content</b>	<b>Number of characters</b>
40	Space in 4040	1
41 to 49	Non-Chinese characters (Latin alphabet, Greek, Roman, Japanese Kana, numeric, special symbols)	1003
4A to 4B	Reserved	
4C to 68	Primary Chinese characters	5402
69 to 91	Secondary Chinese characters	7654
92 to C1	Reserved	
C2 to E2	User-defined characters	Up to 6204
E3 to FE	Reserved	
Total number of IBM-defined characters: 14060		

---

This code scheme applies to the IBM i, System/36, System/38, as well as the System/370 platform. A different DBCS code scheme, called the IBM Personal Computer DBCS code scheme, is used on the



Personal System/55. For details of the IBM Personal Computer DBCS code scheme, refer to IBM PS/55 publications.

### **Shift-control double-byte characters**

When the IBM-host code scheme is used, the system uses shift-control characters to identify the beginning and end of a string of double-byte characters.

The shift-out (SO) character, hex 0E, indicates the beginning of a double-byte character string. The shift-in (SI) character, hex 0F, indicates the end of a double-byte character string.

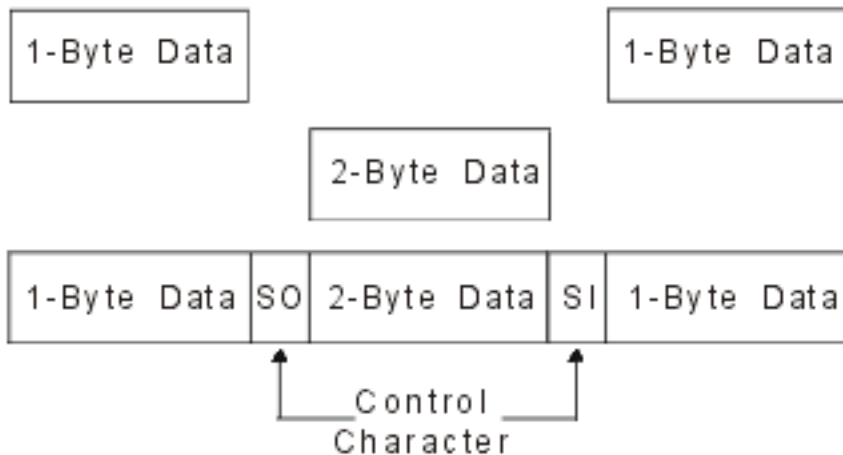

Figure 22. Placement of shift-out and shift-in characters

Each shift-control character occupies the same amount of space as one alphanumeric character. By contrast, double-byte characters occupy the same amount of space as two alphanumeric characters.

When double-byte characters are stored in a graphic field or a variable of graphic data type, there is no need to use shift control characters to surround the double-byte characters.

### **Invalid double-byte code and undefined double-byte code**

Invalid double-byte code has a double-byte code value that is not in the valid double-byte code range.

The IBM-Host code scheme in the DBCS code scheme topic shows valid double-byte code ranges. This is in contrast to undefined double-byte code where the double-byte code is valid, but no graphic symbol has been defined for the code.

#### **Related reference**

[DBCS code scheme](#)

IBM supports two DBCS code schemes: one for the host systems, the other for personal computers.

### **Usage of double-byte data**

This section describes where you can use double-byte data and the limitations to its use.

#### *Where you can use double-byte data*

You can use double-byte data as data in files, as the text of messages, as the text of object descriptions, as literals and constants, and as data to be processed by high-level language programs.

- As data in files:
  - Data in database files.
  - Data entered in input-capable and data displayed in output-capable fields of display files.
  - Data printed in output-capable fields in printer files.
  - Data used as literals in display files and printer files.
- As the text of messages.
- As the text of object descriptions.

- As literals and constants, and as data to be processed by high-level language programs.

Double-byte data can be displayed only at DBCS display stations and printed only on DBCS printers. Double-byte data can be written onto diskette, tape, disk, and optical storage.

#### *Where you cannot use double-byte data*

You cannot use double-byte data as IBM i object names, command names, or variable names in control language (CL) and other high-level languages, or as displayed or printed output on alphanumeric workstations.

### **Double-byte character size**

When displayed or printed, double-byte characters typically are twice as wide as single-byte characters.

Consider the width of double-byte characters when you calculate the length of a double-byte data field because field lengths are typically identified as the number of single-byte character positions used. For more information about calculating the length of fields containing double-byte data, refer to the [DDS concepts](#).

## **Process of double-byte characters**

Due to the large number of double-byte characters, the system needs more information to identify each double-byte character than is needed to identify each alphanumeric character.

There are two types of double-byte characters: *basic double-byte characters* and *extended double-byte characters*. These characters are typically processed by the device on which the characters are displayed or printed.

### **Basic double-byte characters**

Basic characters are frequently used double-byte characters that reside in the hardware of a DBCS-capable device.

Basic characters are frequently used double-byte characters that reside in the hardware of a DBCS-capable device. The number of double-byte characters stored in the device varies with the language supported and the storage size of the device. A DBCS-capable device can display or print basic characters without using the extended character processing function of the operating system.

### **Extended double-byte characters**

When processing extended characters, the device requires the assistance of the system. The system must tell the device what the character looks like before the device can display or print the character. Extended characters are stored in a DBCS font table, not in the DBCS-capable device.

When displaying or printing extended characters, the device receives them from the DBCS font table under control of the operating system.

Extended character processing is a function of the operating system that is required to make characters stored in a DBCS font table available to a DBCS-capable device.

To request extended character processing, specify the double-byte extended character parameter, IGCEXNCHR(\*YES), on the file creation command when you create a display (CRTDSPF command) or printer file (CRTPRTF command) that processes double-byte data. Because IGCEXNCHR(\*YES) is the default value, the system automatically processes extended characters unless you instruct it otherwise. You can change this file attribute by using a change file (CHGDSPF or CHGPRTF) or override file (OVRDSPF or OVRPRTF) command. For example, to override the display file named DBCSDSPF so that extended characters are processed, enter the following command:

```
OVRDSPF DSPF(DBCSDSPF) IGCEXNCHR(*YES)
```

#### **Notes:**

1. The system ignores the IGCEXNCHR parameter when processing alphanumeric files.

2. When you use the Japanese 5583 Printer to print extended characters, you must use the Kanji print function of the IBM Advanced DBCS Printer Support for iSeries licensed program. Refer to the *Kanji Print Function User's Guide and Reference* for how to use this utility.

### ***What happens when extended double-byte characters are not processed***

This topic describes the result you get when extended double-byte characters are not processed.

When extended characters are not processed, the following result happens:

- Basic double-byte characters are displayed and printed.
- On displays, the system displays the undefined character where it might otherwise display extended characters.
- On printed output, the system prints the undefined character where it might otherwise print extended characters.
- The extended characters, though not displayed or printed, are stored correctly in the system.

### **DBCS device file support**

This section describes DBCS-capable device files and special considerations for working with DBCS-capable device files.

Data description specifications (DDS), a language used to describe files, can be used with DBCS-capable device files.

#### ***What a DBCS file is***

A *DBCS file* is a file that contains double-byte data or is used to process double-byte data. Other files are called alphanumeric files.

The following types of device files can be DBCS files:

- Display
- Printer
- Tape
- Diskette
- ICF

#### ***When to indicate a DBCS file***

This topic describes the situations in which you should indicate that a file is DBCS.

You should indicate that a file is DBCS in one or more of the following situations:

- The file receives input, or displays or prints output, which has double-byte characters.
- The file contains double-byte literals.
- The file has double-byte literals in the DDS that are used in the file at processing time (such as constant fields and error messages).
- The DDS of the file includes DBCS keywords.
- The file stores double-byte data (database files).

#### ***How to indicate a DBCS file***

You must indicate that a device file is a DBCS file in order for the system to process double-byte data properly. You can indicate a DBCS file in the ways described in this topic.

- Through DDS:
  - DDS provides fields of the following data types.
    - *DBCS-only fields*: display and accept only double-byte characters. Double-byte characters in a DBCS-only field are enclosed in shift-out and shift-in characters that must be paired.

- *DBCS-open fields*: display and accept both single-byte and double-byte characters. Double-byte characters are enclosed in shift-out and shift-in characters that must be paired.
- *DBCS-either fields*: display and accept *either* single-byte or double-byte characters, but not *both*. Double-byte characters are enclosed in shift-out and shift-in character pairs.
- *DBCS-graphic fields*: display and accept only double-byte characters. Characters in a DBCS-graphic field do not have shift-out and shift-in characters. The IBM i DBCS-graphic field is equivalent to a System/370 DBCS field.
- In ICF files, by defining fields with DBCS-open data type (type O).
- In printer files, by defining fields with DBCS-open data type (type O) and DBCS-graphic data type (type G).
- In display files, by defining fields with DBCS-only data type (type J), DBCS-either data type (type E), DBCS-open data type (type O), or DBCS-graphic data type (type G).
- By using a double-byte literal that is used with the file at processing time, such as literals specified with the Default (DFT) and Error Message (ERRMSG) DDS keywords.

**Note:** You can also use double-byte literals as text and comments in a file, such as with the DDS keyword TEXT. However, the system does not consider a file, whose only DBCS usage is that it has double-byte comments, to be a DBCS file.

- By specifying the Alternative Data Type (IGCALTTYP) DDS keyword in display and printer files. This keyword lets you use display and printer files with both alphanumeric and double-byte applications. When you put the IGCALTTYP keyword into effect, you can use double-byte data with the file.

Put the IGCALTTYP keyword into effect by creating, changing, or overriding display and printer files with the IGCDDTA(\*YES) value. You can put the IGCALTTYP keyword into effect for display and printer files by specifying IGCDDTA(\*YES) on the following device file commands:

- Create Display File (CRTDSPF)
- Create Printer File (CRTPRTF)
- Change Display File (CHGDSPF)
- Change Printer File (CHGPRTF)
- Override with Display File (OVRDSPF)
- Override with Printer File (OVRPRTF)

When you specify IGCDDTA(\*NO), the IGCALTTYP keyword is not in effect and you can use only alphanumeric data with the file. Changing or overriding the file to put the IGCALTTYP keyword into effect does not change the DDS of the file.

Except when using the IGCALTTYP function, you do not need to specify IGCDDTA(\*YES) on the file creation command if you have already specified DBCS functions in the DDS. Instead, specify IGCDDTA(\*YES) when the file has DBCS functions that are not indicated in the DDS. For example, specify IGCDDTA(\*YES) on the file creation command if the file is intended to contain double-byte data.

- By specifying IGCDDTA(\*YES) on the following device file creation commands:
  - Create Display File (CRTDSPF)
  - Create Printer File (CRTPRTF)
  - Create Tape File (CRTTAPF)
- By specifying IGCDDTA(\*YES) on the following database file creation commands:
  - Create Physical File (CRTPF)
  - Create Source Physical File (CRTSRCPF)

## ***Improperly indicated DBCS files***

If you do not properly indicate that a file is a DBCS file, some errors might occur.

- For printer files, printer data management assumes the output data to the printer does not contain double-byte data. The end result depends on the type of printer the data is printed on and the status of the replace unprintable character parameter for the printer file you are using.

If the replace-unprintable-character option is selected, printer data management interprets shift-control characters as unprintable characters and replaces them with blanks. The double-byte data itself is interpreted as alphanumeric data, and the printer attempts to print it as such. The printed double-byte data does not make sense.

If the replace-unprintable-character option is not selected and the printer is an alphanumeric printer, the double-byte data, including the control characters, is sent as is to the printer. On most alphanumeric printers, the shift-control characters are not supported, and an error will occur at the printer.

If the replace-unprintable-character option is not selected and the printer is a DBCS printer, the double-byte data is printed with the exception of extended characters. Because the file was not indicated as a DBCS file, the system does not perform extended character processing. The extended characters are printed with the symbol for undefined double-byte characters.

- For display files, display data management assumes that the output data to the display does not contain double-byte data. The end result depends on whether the display is an alphanumeric or DBCS display.

If the display is an alphanumeric display, the double-byte data is interpreted as alphanumeric data. The shift-control characters appear as anks. The displayed double-byte data does not make sense.

If the display is a DBCS display, the double-byte data is displayed with the exception of extended characters. The system does not perform extended character processing on the data. Therefore, extended characters are displayed with the symbol for undefined double-byte characters.

- The system does not recognize literals with DBCS text as double-byte literals if the source file is not specified as a DBCS file.

### *Making printer files capable of DBCS*

When the data involved contains double-byte characters, the printer file that is used to place the data into the spooled file must be capable of processing double-byte data.

In many cases, printer files are used by the system to produce data that is eventually printed or displayed. In these cases, the data is first placed into a spooled file using one of the IBM-supplied printer files. The data is then taken from the spooled file and is displayed or printed based on the request of the user.

A printer file is capable of processing double-byte data when the value \*YES is specified on the IGCDDTA parameter for the file. In most cases, the system recognizes the occurrence of double-byte data and takes appropriate measures to ensure that the printer file used is capable of processing double-byte data.

In some cases, however, the system cannot recognize the occurrence of double-byte data and might attempt to use a printer file that is not capable of processing double-byte data. If this occurs, the output at the display or printer cannot be readable. This can happen when object descriptions containing double-byte characters are to be displayed or printed on an alphanumeric device.

To ensure that you receive correct results when you display or print double-byte characters, some recommendations should be followed. Action is required on your part if you have a single-byte national language installed as a secondary language. Printer files that are received as part of the DBCS version of a product are always capable of processing DBCS data.

The following suggested actions should be performed after the product or feature has been installed:

1. If all printers and display devices attached to your system are DBCS-capable, you can enable all printer files for double-byte data. For IBM-supplied printer files that are received as part of a single-byte secondary language feature, you can enable all printer files by issuing the Change Printer File (CHGPRTF) command:

```
CHGPRTF FILE(*ALL/*ALL) IGCDDTA(*YES)
```

After this command is completed, all printer files in all libraries are enabled for double-byte data. The change is a permanent change.

2. If all printer and display devices attached to your system are not DBCS-capable, it is suggested that you not enable all IBM-supplied printer files.

Instead, use the library search capabilities of the system to control which printer files to use for any particular job. When double-byte data might be encountered, the library list for the job must be such that the printer files that are DBCS-enabled are found first in the library list. Conversely, if only single-byte data is encountered, the library list must be set up so that the printer files that are not enabled for DBCS are found first. In this way, the printer file capabilities match the type of data that is processed. To decide what type of printer file to use, you need to consider what type of data is processed. The device that is used to actually display or print the data might also influence this decision.

In some cases, it might be preferable to make the printer file only temporarily DBCS-capable instead of making a permanent change. For a specific job, you can make this temporary change by using the Override with Printer File (OVRPRTF) command.

To temporarily enable a specific printer file, you can use the following command:

```
OVRPRTF FILE(filename) IGCDTA(*YES)
```

where filename is the name of the printer file you want to enable.

## DBCS display support

This section provides information about displaying double-byte characters.

### ***Inserting shift-control double-byte characters***

The system inserts shift-control characters into DBCS-only fields automatically.

To insert shift-control characters into open fields or either fields, follow these steps:

1. Position the cursor in the field in which you want to insert double-byte data.
2. Press the Insert Shift Control Character key (according to your DBCS display station user's guide).

The system inserts a pair of shift-control characters at the same time, as follows (where  $O_E$  represents the shift-out character and  $O_F$  represents the shift-in character):

```
 $O_E O_F$ 
```

The system leaves the cursor under the shift-in character and puts the keyboard in insert mode. Insert double-byte characters between the shift-control characters. To insert double-byte characters, start entering double-byte characters at the cursor position. For example, enter the double-byte character string D1D2D3, as follows (where  $O_E$  represents the shift-out character,  $O_F$  represents the shift-in character, and D1, D2, and D3 represent three double-byte characters):

```
 $O_E D1D2D3 O_F$ 
```

To find out if a field already has the shift-control characters, press the Display Shift Control Character key.

DBCS-graphic fields store double-byte characters without requiring the use of shift control characters. Shift control characters should not be inserted in graphic fields.

### ***Number of displayed extended double-byte characters***

The system can display up to 512 different extended characters on a Japanese display at one time. Additional extended characters are displayed as undefined characters. However, the additional extended characters are stored correctly on the system.

### ***Number of DBCS input fields on a display***

The use of DBCS input fields affects the total number of input fields allowed on a display. For a local 5250 display station, you can specify as many as 256 input fields. However, each three instances of a DBCS field reduces the maximum number of fields by one.

For example, if there are 9 DBCS fields on a display, then the maximum is  $256 - (9/3) = 253$  input fields.

### ***Effects of displaying double-byte data at alphanumeric workstations***

Alphanumeric display stations cannot display double-byte data correctly.

If you try to display double-byte data at an alphanumeric display station, the following result happens:

- The system sends an inquiry message to that display station, asking whether you want to continue using the program with double-byte data or to cancel it.
- If you continue using the program, the system ignores the shift-control characters and interprets the double-byte characters as though they were single-byte characters. Displayed double-byte data does not make sense.

## **Copy operation of DBCS files**

You can copy both spooled and nonspooled DBCS files.

### **Related concepts**

UCS-2 graphic fields restrictions

There are some restrictions when you copy from or to a UCS-2 graphic field.

### ***Copy operation of spooled DBCS files***

You can copy spooled files that have double-byte data by using the Copy Spooled File (CPYSPLF) command. However, the database file to which the file is being copied must have been created with the IGCDTA(\*YES) value specified.

When copying spooled files to a database file that contains double-byte data, an extra column is reserved for the shift-out character. This shift-out character is placed between the control information for the record and the user data. The following table shows the shift-out character column number, based on the value specified for the Control Character (CTLCHAR) keyword:

<b>CTLCHAR Value</b>	<b>Column for Shift-Out Character</b>
*NONE	1
*FCFC	2
*PRTCTL	5
*S36FMT	10

### ***Copy operation of nonspooled DBCS files***

You can use the Copy File (CPYF) command to copy double-byte data from one file to another.

When copying data from a double-byte database file to an alphanumeric database file, specify one of the following parameters on the CPYF command:

- If both files are source files or if both files are database files, you can specify either the FMTOPT(\*MAP) parameter or the FMTOPT(\*NOCHK) parameter.
- If one file is a source file and the other file is a database file, specify the FMT(\*CVTSRC) parameter.

When you copy DBCS files to alphanumeric files, the system sends you an informational message describing the difference in file types.

Either the FMTOPT(\*MAP) or FMTOPT(\*NOCHK) option of the copy file function must be specified for copies from a physical or logical file to a physical file when there are fields with the same name in the from-file and to-file, but the data type for fields is as shown in the following table.

<b>From-File Field Data Type</b>	<b>To-File Field Data Type</b>
A (character)	J (DBCS-only)
O (DBCS-open)	J (DBCS-only)
O (DBCS-open)	E (DBCS-either)
E (DBCS-either)	J (DBCS-only)
J (DBCS-only)	G (DBCS-graphic)
O (DBCS-open)	G (DBCS-graphic)
E (DBCS-either)	G (DBCS-graphic)
G (DBCS-graphic)	J (DBCS-only)
G (DBCS-graphic)	O (DBCS-open)
G (DBCS-graphic)	E (DBCS-either)
G (UCS-2 graphic)	A (Character (CCSID non-65535))
G (UCS-2 graphic)	O (DBCS-open (CCSID non-65535))
G (UCS-2 graphic)	E (DBCS-either (CCSID non-65535))
G (UCS-2 graphic)	J (DBCS-only (CCSID non-65535))
G (UCS-2 graphic)	G (DBCS-graphic)
A (Character (CCSID non-65535))	G (UCS-2 graphic)
O (DBCS-open (CCSID non-65535))	G (UCS-2 graphic)
E (DBCS-either (CCSID non-65535))	G (UCS-2 graphic)
J (DBCS-only (CCSID non-65535))	G (UCS-2 graphic)
G (DBCS-graphic)	G (UCS-2 graphic)
A (UTF-8)	A (Character (CCSID non-65535))
A (UTF-8)	O (DBCS-open (CCSID non-65535))
A (UTF-8)	E (DBCS-either (CCSID non-65535))
A (UTF-8)	J (DBCS-only (CCSID non-65535))
A (UTF-8)	G (DBCS-graphic non-65535)
A (UTF-8)	G (UTF-16)
A (UTF-8)	G (UCS-2 graphic)
A (Character (CCSID non-65535))	A (UTF-8)
O (DBCS-open (CCSID non-65535))	A (UTF-8)
E (DBCS-either (CCSID non-65535))	A (UTF-8)
J (DBCS-only (CCSID non-65535))	A (UTF-8)
G (DBCS-graphic non-65535)	A (UTF-8)
G (UCS-2 graphic)	A (UTF-8)
G (UTF-16)	A (Character (CCSID non-65535))
G (UTF-16)	O (DBCS-open (CCSID non-65535))



From-File Field Data Type	To-File Field Data Type
G (UTF-16)	E (DBCS-either (CCSID non-65535))
G (UTF-16)	J (DBCS-only (CCSID non-65535))
G (UTF-16)	G (DBCS-graphic non-65535)
G (UTF-16)	A (UTF-8)
G (UTF-16)	G (UCS-2 graphic)
A (Character (CCSID non-65535))	G (UTF-16)
O (DBCS-open (CCSID non-65535))	G (UTF-16)
E (DBCS-either (CCSID non-65535))	G (UTF-16)
J (DBCS-only (CCSID non-65535))	G (UTF-16)
G (DBCS-graphic non-65535)	G (UTF-16)
G (UCS-2 graphic)	G (UTF-16)

When you use FMTOPT(\*MAP) on the CPYF command to copy data to a DBCS-only field or DBCS-graphic field, the corresponding field in the from-file must *not* be:

- Less than a 2-byte character field
- An odd-byte-length character field
- An odd-byte-length DBCS-open field

**Note:** DBCS-graphic is the only type allowed to be CCSID 65535 when using FMTOPT(\*MAP) copying from or to a UCS-2 graphic field. UCS-2 graphic *cannot be* CCSID 65535.

If you attempt to copy with one of these specified in the from-field, an error message is sent.

When you copy double-byte data from one database file to another with the FMTOPT(\*MAP) parameter specified, double-byte data will be copied correctly. The system performs correct padding and truncation of double-byte data to ensure data integrity.

When using the CPYF command with FMTOPT(\*MAP) to copy a DBCS-open field to a graphic field, a conversion error occurs if the DBCS-open field contains any SBCS data (including blanks).

## Application program considerations for DBCS

This section describes considerations for writing applications that process double-byte data.

### ***Design of application programs that process double-byte data***

There are certain considerations when designing application programs that process double-byte data, as discussed in this topic.

Design your application programs for processing double-byte data in the same way you design application programs for processing alphanumeric data, with the following additional considerations:

- Identify double-byte data used in the database files.
- Design display and printer formats that can be used with double-byte data.
- If needed, provide DBCS conversion as a means of entering double-byte data for interactive applications. Use the DDS keyword for DBCS conversion (IGCCNV) to specify DBCS conversion in display files. Because DBCS workstations provide a variety of double-byte data entry methods, you are not required to use the IBM i DBCS conversion function to enter double-byte data.
- Create double-byte messages to be used by the program.
- Specify extended character processing so that the system prints and displays all double-byte data. See [“Extended double-byte characters” on page 132](#) for instructions.

- Determine whether additional double-byte characters need to be defined. User-defined characters can be defined and maintained using the character generator utility (CGU). Information about CGU can be found in the *ADTS/400: Character Generator Utility* book.

When you write application programs to process double-byte data, make sure that the double-byte data is always processed in a double-byte unit and do not split a double-byte character.

### ***Changing alphanumeric application programs to DBCS application programs***

If an alphanumeric application program uses externally described files, you can change that application program to a DBCS application program by changing the externally described files.

To convert an application program, follow these steps:

1. Create a duplicate copy of the source statements for the alphanumeric file that you want to change.
2. Change alphanumeric constants and literals to double-byte constants and literals.
3. Change fields in the file to the open (O) data type or specify the Alternative Data Type (IGCALTTYP) DDS keyword so that you can enter both double-byte and alphanumeric data in these fields. You might want to change the length of the fields as the double-byte data takes more space.
4. Store the converted file in a separate library. Give the file the same name as its alphanumeric version.
5. When you want to use the changed file in a job, change the library list, using the Change Library List (CHGLIBL) command, for the job in which the file will be used. The library in which the DBCS display file is stored is then checked before the library in which the alphanumeric version of the file is stored.

## **DBCS font tables**

DBCS font tables contain the images of the double-byte extended characters used on the system. The system uses these images to display and print extended characters.

The following DBCS font tables are objects that you can save or restore. These font tables are distributed with the DBCS national language versions of the OS/400® licensed program:

### **QIGC2424**

A Japanese DBCS font table used to display and print extended characters in a 24-by-24 dot matrix image. The system uses the table with Japanese display stations, printers attached to display stations, 5227 Model 1 Printer, and the 5327 Model 1 Printer.

### **QIGC2424C**

A Traditional Chinese DBCS font table used to print extended characters in a 24-by-24 dot matrix image. The system uses the table with the 5227 Model 3 Printer and the 5327 Model 3 Printer.

### **QIGC2424K**

A Korean DBCS font table used to print extended characters in a 24-by-24 dot matrix image. The system uses the table with the 5227 Model 2 Printer and the 5327 Model 2 Printer.

### **QIGC2424S**

A Simplified Chinese DBCS font table used to print extended characters in a 24-by-24 dot matrix image. The system uses the table with the 5227 Model 5 Printer.

### **QIGC3232**

A Japanese DBCS font table used to print characters in a 32-by-32 dot matrix image. The system uses the table with the 5583 Printer and the 5337 Model 1 Printer.

### **QIGC3232S**

A Simplified Chinese DBCS font table used to print characters in a 32-by-32 dot matrix image. The system uses the table with the 5337 Model R05 Printer.

All DBCS font tables have an object type of \*IGCTBL. You can find instructions for adding user-defined characters to DBCS font tables in the *ADTS/400: Character Generator Utility* book.

### ***Commands for DBCS font tables***

You can use the commands listed in this topic to manage and use DBCS font tables.

- [Check DBCS Font Table \(CHKIGCTBL\)](#)

- [Copy DBCS Font Table \(CPYIGCTBL\)](#)
- [Delete DBCS Font Table \(DLTIGCTBL\)](#)
- [Start Character Generator Utility \(STRCGU\)](#)
- [Start Font Management Aid \(STRFMA\)](#)

### ***Finding out if a DBCS font table exists***

You can use the Check DBCS Font Table (CHKIGCTBL) command to find out if a DBCS font table exists on your system.

For example, to find out if the table QIGC2424 exists, enter:

```
CHKIGCTBL IGCTBL(QIGC2424)
```

If the table does not exist, the system responds with a message. If the table does exist, the system returns no message.

Check for the existence of a table when adding a new type of DBCS workstation to make sure that the table used by the device exists on the system.

### **Related information**

[Check DBCS Font Table \(CHKIGCTBL\) command](#)

### ***Copying a DBCS font table onto tape or diskette***

You can use the Copy DBCS Font Table (CPYIGCTBL) command to copy a DBCS font table onto tape or diskette.

The DBCS font tables are saved when you use the Save System (SAVSYS) command so you do not need to use the CPYIGCTBL command when performing normal system backup.

### **Related information**

[Copy DBCS Font Table \(CPYIGCTBL\) command](#)

#### *When to copy a DBCS table onto tape or diskette*

You need to copy a DBCS table onto a tape or diskettes in these instances.

- Before deleting that table.
- After new user-defined characters are added to the tables.
- When planning to use the tables on another IBM i product.

#### *How to copy a DBCS table onto tape or diskette*

You can follow these steps to copy a DBCS font table onto a tape or diskettes.

1. Make sure that you have a tape or diskettes initialized to the \*DATA format. If necessary, initialize the tape or diskettes by specifying the FMT(\*DATA) parameter on the Initialize Diskette (INZDKT) command. See the [Tape files](#) topic for complete instructions on initializing tapes.
2. Load the initialized tape or diskette onto the system.
3. Enter the Copy DBCS Font Table (CPYIGCTBL) command as follows:
  - a. Choose the value OPTION(\*OUT).
  - b. Use the DEV parameter to select the device to which you want to copy the table.
  - c. Use the SELECT and RANGE parameters to specify which portion of the table you want copied from the system. See the description of the [Copy DBCS Font Table \(CPYIGCTBL\)](#) command for instructions on choosing SELECT and RANGE parameter values.

The following are two examples of the CPYIGCTBL command used to copy a DBCS font table to removable media.

- To copy the DBCS font table QIGC2424 onto diskettes, enter:

```
CPYIGCTBL IGCTBL(QIGC2424) OPTION(*OUT) +  
DEV(QDKT)
```

- To copy just the user-defined characters from DBCS font table QIGC2424 onto tape, enter:

```
CPYIGCTBL IGCTBL(QIGC2424) OPTION(*OUT) +  
DEV(QTAP01) SELECT(*USER)
```

4. Press Enter. The system copies the DBCS font table onto the specified media.
5. Remove the tape or diskette after the system finishes copying the table.

### ***Copying a DBCS font table from tape or diskette***

You can use the Copy DBCS Font Table (CPYIGCTBL) command to copy a DBCS font table from a tape or a diskette onto the system.

The system automatically creates the DBCS font table again when copying its contents if the following conditions are true:

- The specified table does not already exist in the system.
- The media from which you are copying the table contains all of the IBM-defined double-byte characters.
- SELECT(\*ALL) or SELECT(\*SYS) is specified on the CPYIGCTBL command.

#### **Related information**

[Copy DBCS Font Table \(CPYIGCTBL\) command](#)

#### *How to copy a DBCS table from a tape or diskette*

You can follow these steps to copy a DBCS font table from tape or diskette onto the system.

1. Load the removable media from which the table will be copied onto the system.
2. Enter the [Copy DBCS Font Table \(CPYIGCTBL\)](#) command as follows:
  - a. Choose the OPTION(\*IN) value.
  - b. Use the DEV parameter to select the device from which to copy the DBCS font table.
  - c. Use the SELECT and RANGE parameters to specify which portion of the table will be copied from the tape or diskette. See the [CL](#) topic collection for a description of the CPYIGCTBL command and for instructions on choosing SELECT and RANGE parameter values.

Here are two examples of commands used to copy a DBCS font table to the system.

- To copy the DBCS font table QIGC2424 from diskette, enter the following command:

```
CPYIGCTBL IGCTBL(QIGC2424) OPTION(*IN) +  
DEV(QDKT)
```

- To copy just the user-defined characters from DBCS font table QIGC2424 from tape and to replace the user-defined characters in the table with the ones from the tape, enter the following command:

```
CPYIGCTBL IGCTBL(QIGC2424) OPTION(*IN) +  
DEV(QTAP01) SELECT(*USER) RPLIMG(*YES)
```

3. Press Enter. The system copies the DBCS font table from the tape or diskette onto the system.
4. Remove the tape or diskette after the system finishes copying the table.

### ***Deleting a DBCS font table***

You can use the Delete DBCS Font Table (DLTIGCTBL) command to delete a DBCS font table from the system.

#### **Related information**

[Delete DBCS Font Table \(DLTIGCTBL\) command](#)

### *When to delete a DBCS font table*

You can delete an unused DBCS font table to free storage space.

For example, if you do not plan to use Japanese printer 5583 or 5337 with your system, font table QIGC3232 is not needed and can be deleted.

### *How to delete a DBCS font table*

When deleting a DBCS font table, you can follow these steps.

1. If you want, copy the table onto tape or diskettes. See [“Copying a DBCS font table onto tape or diskette” on page 141](#) for instructions. If you do not copy the table to removable media before deleting it, you will not have a copy of the table for future use.
2. Vary off all devices using that table.
3. Enter the DLTIGCTBL command.

For example, to delete the DBCS font table QIGC3232, enter the following command:

```
DLTIGCTBL IGCTBL(QIGC3232)
```

4. Press Enter. The system sends inquiry message CPA8424 to the system operator message queue for you to confirm your intention to delete a DBCS table.
5. Respond to the inquiry message. The system sends you a message when it has deleted the table.

**Note:** Do not delete a DBCS font table if any device using that table is currently varied on. Also, make sure that the affected controller is not varied on. If you try to delete the table while the device and controller are varied on, the system reports any devices attached to the same controllers as those devices and the controllers as damaged the next time you try to print or display extended characters on an affected device. If such damage is reported, follow these steps:

1. Vary off the affected devices, using the Vary Configuration (VRYCFG) command.
2. Vary off the affected controller.
3. Vary on the affected controller.
4. Vary on the affected devices.
5. Continue normal work.

### ***Starting the character generator utility for DBCS font tables***

You can use the STRCGU command to start the character generator utility.

You can call the CGU main menu or specify a specific CGU function, depending on the parameter used. Refer to the *ADTS/400: Character Generator Utility* book for more information.

### ***Copying user-defined double-byte characters***

You can use the STRFMA command to copy user-defined double-byte characters between an IBM i DBCS font table and a user font file at a Personal System/55, a 5295 Display Station, or an InfoWindow 3477 Display Station.

#### **Related information**

[STRFMA command](#)

## **DBCS font files**

In addition to the system-supplied DBCS font tables, the system also provides DBCS font files. These DBCS font files are physical files that contain frequently used double-byte characters.

When using the character generator utility, you can use the characters in these files as the base for a new user-defined character. These files are supplied with read-only authority as they are not to be changed. If you do not use character generator utility or the IBM Advanced DBCS Printer Support for iSeries licensed program, you can delete these files to save space. They all exist in the QSYS library.

The following DBCS font files are distributed with the DBCS national language versions of the OS/400 licensed program. They are used as a reference for the CGU and the IBM Advanced DBCS Printer Support for iSeries licensed program.

**QCGF2424**

A Japanese DBCS font file used to store a copy of the Japanese DBCS basic character images.

**QCGF2424K**

A Korean DBCS font file used to store a copy of the Korean DBCS basic character images.

**QCGF2424C**

A Traditional Chinese DBCS font file used to store a copy of the Traditional Chinese DBCS basic character images.

**QCGF2424S**

A Simplified Chinese DBCS font file used to store a copy of the Simplified Chinese DBCS basic character images.

## **DBCS sort tables**

DBCS sort tables contain the sort information and collating sequences of all the double-byte characters used on the system. The system uses these tables to sort double-byte characters using the sort utility.

DBCS sort tables are objects that you can save, restore and delete. Using the character generator utility you can also add, delete and change entries in these tables corresponding to the image entries in the DBCS font tables. For Japanese use only, you can also copy the DBCS master sort table to and from a data file.

The following DBCS sort tables are distributed with the DBCS national language versions of OS/400 licensed program:

**QCGMSTR**

A Japanese DBCS master sort table used to store the sort information for the Japanese double-byte character set.

**QCGACTV**

A Japanese DBCS active sort table used to store the sort collating sequences for the Japanese double-byte character set.

**QCGMSTRC**

A Traditional Chinese DBCS master sort table used to store the sort information for the Traditional Chinese double-byte character set.

**QCGACTVC**

A Traditional Chinese DBCS active sort table used to store the sort collating sequences for the Traditional Chinese double-byte character set.

**QCGACTVK**

A Korean DBCS active sort table used to map Hanja characters to Hangeul characters with equivalent pronunciation.

**QCGMSTRS**

A Simplified Chinese DBCS master sort table used to store the sort information for the Simplified Chinese double-byte character set.

**QCGACTVS**

A Simplified Chinese DBCS active sort table used to store the sort collating sequences for the Simplified Chinese double-byte character set.

You can sort Japanese, Korean, Simplified Chinese, and Traditional Chinese double-byte characters. Each of these languages have two DBCS sort tables, a DBCS master sort table and a DBCS active sort table, except for Korean which has only a DBCS active sort table. The DBCS master sort table contains sort information for all defined DBCS characters. The DBCS active sort table for Japanese, Simplified Chinese, and Traditional Chinese is created from the master sort table information and contains the collating sequences for the double-byte characters of that given language. These collating sequences have a purpose similar to the EBCDIC and ASCII collating sequences for the single-byte alphanumeric character

set. For Korean characters, the Hangeul characters are assigned both their collating sequence as well as their DBCS codes according to their pronunciation. Hence, a separate collating sequence is not required, and each of the Hanja characters is mapped to a Hangeul character of the same pronunciation using the DBCS active sort table QCGACTVK.

All DBCS sort tables have an object type of \*IGCSRT.

### **Commands for DBCS sort tables**

You can use the commands listed in this topic to manage and use DBCS sort tables.

- [Check Object \(CHKOBJ\)](#)
- [Save Object \(SAVOBJ\)](#)
- [Restore Object \(RSTOBJ\)](#)
- [Copy DBCS Master Sort Table \(CPYIGCSRT\)](#) (for Japanese table only)
- [Delete DBCS Sort Table \(DLTIGCSRT\)](#)
- [Start Character Generator Utility \(STRCGU\)](#)

### **Using DBCS sort tables on the system**

You can save the tables to tapes or diskettes, delete them from the system, and restore them to the system.

The Japanese DBCS master sort table can also be copied to a data file and copied from a data file so that it can be shared with a System/36 or Application System/Entry (AS/Entry) system. You can also add sort information for each user-defined character, and add that character to the DBCS collating sequence, as you create it using the character generator utility.

### **Finding out if a DBCS sort table exists**

You can use the Check Object (CHKOBJ) command to find out if a DBCS sort table exists in your system.

For example, to find out if the table QCGMSTR exists, enter:

```
CHKOBJ OBJ(QSYS/QCGMSTR) OBJTYPE(*IGCSRT)
```

If the table does not exist, the system responds with a message. If the table does exist, the system returns no message.

Check for the existence of a DBCS active sort table when you want to sort double-byte characters for the first time. The DBCS active table for the DBCS language must exist to sort the characters.

### **Related information**

[Check Object \(CHKOBJ\) command](#)

### **Saving a DBCS sort table onto tape or diskette**

You can use the Save Object (SAVOBJ) command to save a DBCS sort table onto tape or diskette. Specify \*IGCSRT for the object type.

The DBCS sort tables are saved when you use the SAVSYS command, so you do not need to use the SAVOBJ command when performing normal system backup.

### **When to save a DBCS sort table onto tape or diskette**

Save a DBCS sort table onto tape or diskette in the following instances:

- Before deleting that table
- After information is added, updated, or changed in the tables using the character generator utility
- When planning to use the tables on another IBM i product

### **Related reference**

[How to delete a DBCS sort table](#)

When you delete a double-byte character set (DBCS) sort table, follow these steps.

### **Related information**

[Save Object \(SAVOBJ\) command](#)

### ***Restoring a DBCS sort table from tape or diskette***

You can use the Restore Object (RSTOBJ) command to restore a DBCS sort table from a tape or a diskette onto the system.

The tables on the tape or diskette must previously have been saved using the SAVOBJ command. Specify \*IGCSRT for the object type. The system automatically re-creates the DBCS sort table when the specified table does not already exist in the system.

These tables must be restored to the QSYS library for the system to know they exist. For that reason, RSTOBJ restores \*IGCSRT objects only to the QSYS library and only if the objects do not already exist there.

### **Related information**

[Restore Object \(RSTOBJ\) command](#)

### ***Copying a Japanese DBCS master sort table to a data file***

Through the character generator utility, use the CPYIGCSRT command to copy the Japanese DBCS master sort table (QCGMSTR) to a data file.

This data file can then be moved to a System/36 server or AS/Entry system to replace the Japanese master sort table there.

#### *When to copy the Japanese DBCS master sort table to a data file*

You need to copy the Japanese DBCS master sort table to a data file in these instances.

- When planning to move the table to the System/36 or AS/Entry for use there. You should always transport the Japanese DBCS master sort table together with the Japanese DBCS font tables.
- Before deleting that table, as an alternative to the SAVOBJ command. You can then keep the file or save it on diskette or tape.

#### *How to copy the Japanese DBCS master sort table to a data file*

To copy the Japanese DBCS master sort table to a data file, follow these steps.

**Note:** In this section, the AS/Entry system also applies to every instance of System/36.

1. Decide what data file you want to copy it to. The file is automatically created if it does not already exist.
2. Enter the CPYIGCSRT command as follows:
  - a. Choose the value OPTION(\*OUT).
  - b. Use the FILE parameter to specify the name of the data file to which you want to copy the master table. If you are transporting the master table to the System/36 for use there, you should specify a file name of #KAMAST, or you must rename the file when you get it to the System/36. Use the IBM i CPYF command for copying the file onto diskette, and the System/36 TRANSFER command for copying the file from diskette to the System/36.
  - c. Use the MBR parameter to specify the name of the data file member to which you want to copy the master table. If you are transporting the master table to the System/36 for use there, you should specify \*FILE for the MBR parameter.
3. Press Enter. The system creates the file and member if they do not exist, and overwrites the existing member if they do exist.
4. If you now transport this file to your System/36 to replace the #KAMAST file there, you should also use the SRTXBLD procedure to update the active table to reflect the new master table.



## ***Copying a Japanese DBCS master sort table from a data file***

You can use the CPYIGCSRT command to copy the Japanese DBCS master sort table (QCGMSTR) from a data file.

### *When to copy the Japanese DBCS master sort table from a data file*

You need to copy the Japanese DBCS master sort table from a data file in these instances.

- When you plan on using the CPYIGCSRT command. In this case, you can copy the AS/Entry master sort file (#KAMAST) from the System/36 or AS/Entry to the IBM i platform. The CPYIGCSRT command copies sort information from the #KAMAST file to the IBM i master sort table (QCGMSTR). Delete the #KAMAST file from the IBM i platform after you complete the copy operation.
- When you have copied a version of the master table to a data file and you now want to restore that version.

**Note:** You should always migrate or copy the Japanese DBCS master sort table together with the Japanese DBCS font tables.

### *How to copy the Japanese DBCS master sort table from a data file*

To copy the Japanese DBCS master sort table from a data file, follow these steps.

1. Enter the CPYIGCSRT command as follows:
  - a. Choose the value OPTION(\*IN).
  - b. Use the FILE parameter to specify the name of the data file that contains a migrated System/36 or AS/Entry master file or an IBM i master table previously copied to the file using OPTION(\*OUT) with the CPYIGCSRT command. To migrate your System/36 or AS/Entry master file, use the TRANSFER command with the IFORMAT parameter on the System/36 or AS/Entry to save the #KAMAST master file on diskette. Use the Copy File (CPYF) command to copy the master file #KAMAST from diskette. Use the CPYIGCSRT command as described here to copy data from the file to the IBM i Japanese DBCS master sort table.
  - c. Use the MBR parameter to specify the name of the data file member from which you want to copy the master table data.
2. Press Enter. Even though the information in the existing Japanese DBCS master sort table is overridden, that table must exist before you can use this command.
3. To update the Japanese DBCS active table to reflect the new copied information, use the SRTXBLD procedure in the System/36 or AS/Entry environment, or the STRCGU command specifying OPTION(5). This must be done before you can use the sort utility to sort Japanese double-byte characters.

## ***Deleting a DBCS sort table***

You can use the DLTIGCSRT command to delete a DBCS sort table from the system.

### *When to delete a DBCS sort table*

You can delete an unused DBCS sort table to free disk space, but you need to always save a copy of the table using the Save Object (SAVOBJ) command.

You need to delete the DBCS master sort table for a DBCS language if any of the following conditions are true:

1. You will not be creating any new characters for that language using the character generator utility.
2. You will not be using the sort utility to sort characters for that language.

You need to delete the DBCS active sort table for a DBCS language if you do not use the sort utility to sort characters for that language. The DBCS active sort table must be on the system to use the sort utility for this language.

## **Related information**

[Save Object \(SAVOBJ\) command](#)

### *How to delete a DBCS sort table*

When you delete a double-byte character set (DBCS) sort table, follow these steps.

1. If you want, save the table onto tape or diskettes. If you do not save the table onto removable media before deleting it, you will not have a copy of the table for future use.
2. Enter the DLTIGCSRT command.

For example, to delete the DBCS sort table QCGACTV, enter:

```
DLTIGCSRT IGCSRT(QCGACTV)
```

3. Press Enter. The system sends you a message when it has deleted the table.

### **Related reference**

#### Saving a DBCS sort table onto tape or diskette

You can use the Save Object (SAVOBJ) command to save a DBCS sort table onto tape or diskette. Specify \*IGCSRT for the object type.

## **DBCS conversion dictionaries**

The DBCS conversion dictionary is a collection of alphanumeric entries and their related DBCS words. The system refers to the dictionary when performing DBCS conversion.

All DBCS conversion dictionaries have an object type of \*IGCDCT. A system-supplied and a user-created dictionary are used with DBCS conversion.

### **Related reference**

#### How DBCS conversion works

DBCS conversion is an interactive function between you and the system in which you enter an alphanumeric entry. The system displays related DBCS words, and you choose which word to use.

### ***System-supplied dictionary (for Japanese use only) for DBCS***

QSYSIGCDCT, the system-supplied dictionary that is stored in the library, QSYS, is a collection of entries with a Japanese pronunciation expressed in alphanumeric characters and the DBCS words related to those entries. The system checks this dictionary second when performing DBCS conversion.

QSYSIGCDCT contains these entries:

- Personal names
  - Family names
  - First names
- Organization names
  - Private enterprises registered in the security market
  - Public corporations
  - Typical organizations in the central and
  - Local governments
  - Most universities and colleges
- Addresses
  - Public administration units within the prefectures
  - Towns and streets in 11 major cities
- Business terms, such as department names and position titles commonly used in enterprises
- Individual double-byte characters, including basic double-byte characters, as defined by IBM

You cannot add or delete entries from this dictionary. However, you can rearrange the related DBCS words so that the words used most frequently are displayed first during DBCS conversion.

## Related reference

### Editing a DBCS conversion dictionary

You can use the Edit DBCS Conversion Dictionary (EDTIGCDCT) command to edit the DBCS conversion dictionary.

## ***User-created dictionary for DBCS***

A *user-created dictionary* contains any alphanumeric entries and related DBCS words that you choose to include.

You might create a user dictionary to contain words unique to your business or words that you use regularly but that are not included in the system-supplied dictionary.

You can create one or more DBCS conversion dictionaries with any names and store them in any library. When you perform DBCS conversion, however, the system only refers to the first user dictionary named QUSRIGCDCT in the user's library list, no matter how many dictionaries you have or what they are named. Make sure that the library list is properly specified so that the system checks the correct dictionary.

During DBCS conversion, the system checks QUSRIGCDCT before checking QSYSIGCDCT.

## ***Commands for DBCS conversion dictionaries***

You can use the commands listed in this topic to perform object management functions with the DBCS conversion dictionary.

You can use the following commands to perform object management functions with the DBCS conversion dictionary. Specify the OBJTYPE(\*IGCDCT) parameter when entering these commands:

- CHGOBJOWN: Change the owner of a DBCS conversion dictionary
- CHKOBJ: Check a DBCS conversion dictionary
- CRTDUPOBJ: Create a duplicate object of the dictionary
- DMPOBJ: Dump a DBCS conversion dictionary
- DMPYSOBJ: Dump the system-supplied dictionary
- DSPOBJAUT: Display a user's authority to the dictionary
- GRTOBJAUT: Grant authority to use the dictionary
- MOVOBJ: Move the dictionary to another library
- RNMOBJ: Rename the dictionary
- RSTOBJ: Restore the dictionary
- RVKOBJAUT: Revoke authority to use the dictionary
- SAVOBJ: Save the dictionary
- SAVCHGOBJ: Save a changed dictionary

The system saves or restores DBCS conversion dictionaries when you use these commands:

- RSTLIB: Restore a library in which the dictionary is stored
- SAVLIB: Save a library in which the dictionary is stored
- SAVSYS: Save QSYSIGCDCT, the system DBCS conversion dictionary, when saving the system

You can use the following commands to create, edit, display, and delete a dictionary:

- CRTIGCDCT: Create DBCS Conversion Dictionary
- EDTIGCDCT: Edit DBCS Conversion Dictionary
- DSPIGCDCT: Display DBCS Conversion Dictionary
- DLTIGCDCT: Delete DBCS Conversion Dictionary

### *Creating a DBCS conversion dictionary*

To create a DBCS conversion dictionary, follow these steps.

1. Use the Create DBCS Conversion Dictionary (CRTIGCDCT) command.

2. Name the dictionary, QUSRIGCDCT, so it can be used during DBCS conversion. The system uses the dictionary if it is the first user-created dictionary found when searching a user's library list.

You might call the dictionary by another name while it is being created to prevent application programs from using it for conversion. Later, change the dictionary name using the Rename Object (RNMOBJ) command.

For example, to create a user DBCS conversion dictionary to be stored in the library DBCSLIB, enter:

```
CRTIGCDCT IGCDCT(DBCSLIB/QUSRIGCDCT)
```

3. Use the [Edit DBCS Conversion Dict \(EDTIGCDCT\)](#) command to put entries and related words into the dictionary after creating it. See [“Editing a DBCS conversion dictionary” on page 150](#) for instructions on putting entries in the dictionary.

#### *Editing a DBCS conversion dictionary*

You can use the Edit DBCS Conversion Dictionary (EDTIGCDCT) command to edit the DBCS conversion dictionary.

Use editing to add user-defined characters to the dictionary, so that users can enter characters using DBCS conversion, and rearrange terms in a DBCS conversion dictionary to suit individual needs.

#### **Related reference**

[System-supplied dictionary \(for Japanese use only\) for DBCS](#)

QSYSIGCDCT, the system-supplied dictionary that is stored in the library, QSYS, is a collection of entries with a Japanese pronunciation expressed in alphanumeric characters and the DBCS words related to those entries. The system checks this dictionary second when performing DBCS conversion.

#### **Related information**

[Edit DBCS Conversion Dictionary \(EDTIGCDCT\) command](#)

#### *Requirements for a DBCS conversion dictionary*

The display station needed for use while editing the DBCS conversion dictionary depends on the value that you entered for the ENTRY parameter on the EDTIGCDCT command.

- If you specified a specific string with the ENTRY parameter or if you want to display double-byte characters, you must use a DBCS display station.
- If you did not specify a specific string with the ENTRY parameter, or if you do not want to display double-byte characters, use either a DBCS display station, or a 24-row by 80-column alphanumeric display station.

#### **Related information**

[Edit DBCS Conversion Dict \(EDTIGCDCT\) command](#)

[CL concepts and reference](#)

#### *DBCS conversion dictionary operations*

You can perform the editing operations listed in this topic on a user-created DBCS conversion dictionary

- Add entries to the dictionary (including adding the first entries to the dictionary after it is created). The dictionary can contain as many as 99,999 entries.
- Delete entries from the dictionary.
- Change entries in the dictionary, such as replacing the DBCS words related to an alphanumeric entry.
- Move the DBCS words related to an alphanumeric entry to rearrange the order in which they appear during DBCS conversion.

The only editing function that you can perform with QSYSIGCDCT, the system-supplied dictionary, is to move DBCS words related to an alphanumeric entry. You move words to rearrange the order in which they appear during DBCS conversion.

*Displays used for editing a DBCS conversion dictionary*

After you enter the Edit DBCS Conversion Dict (EDTIGCDCT) command, the system presents either the Work With DBCS Conversion Dictionary display or the Edit Related Words display, depending on the value entered for the ENTRY parameter on the command.

**Related information**

[Edit DBCS Conversion Dict \(EDTIGCDCT\) command](#)

[CL concepts and reference](#)

*Working with DBCS conversion dictionary display*

You can use the figure in this topic to work with alphanumeric entries, such as choosing an entry to edit or deleting an entry. The system displays the Work with DBCS Conversion Dictionary display if you enter \*ALL or a generic string for the ENTRY parameter of the Edit DBCS Conversion Dict (EDTIGCDCT) command.

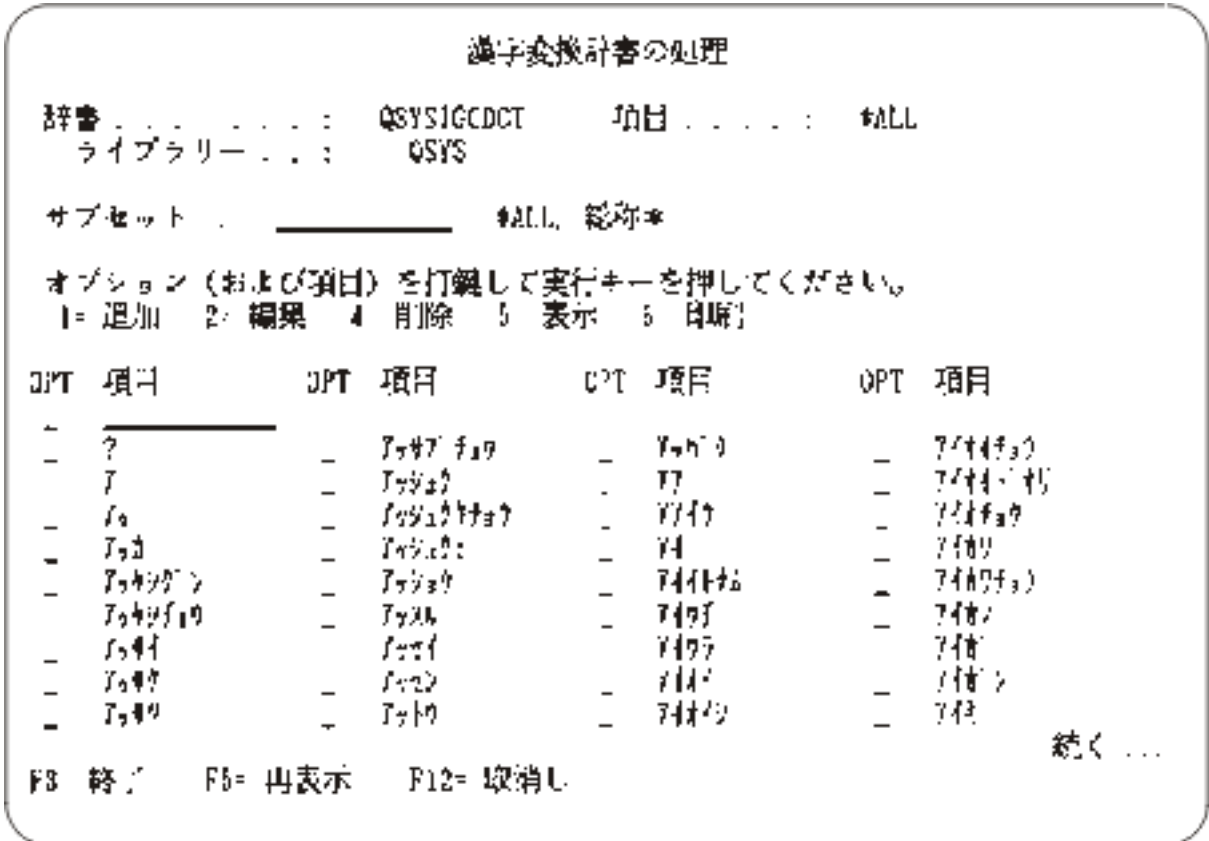

Figure 23. Display for Work with DBCS Conversion Dictionary

**Related information**

[Edit DBCS Conversion Dict \(EDTIGCDCT\) command](#)

[CL concepts and reference](#)

*Edit Related Words display for a DBCS conversion dictionary*

You can use this display to work with the DBCS words related to an alphanumeric entry. The system displays the Edit Related Words display if you enter a specific string for the ENTRY parameter. The system also displays the Edit Related Words display if you choose an entry to edit from the Work with DBCS Conversion Dictionary display.

Figure 24 on page 153 is an example of the Edit Related Words display.

**Related information**

[Edit DBCS Conversion Dict \(EDTIGCDCT\) command](#)

[CL concepts and reference](#)

### *Examples of editing operations for a DBCS conversion dictionary*

This topic contains examples of the editing operations that you can perform using the EDTIGCDCT displays.

#### *Beginning to edit a DBCS conversion dictionary*

You can enter the EDTIGCDCT command to start editing the dictionary for any type of editing operation.

For example, to put the first entry in the dictionary, enter:

```
EDTIGCDCT IGCDCT(DBCSLIB/QUSRIGCDCT) +  
ENTRY(*ALL)
```

Or, to edit the entries beginning with the string ABC enter:

```
EDTIGCDCT IGCDCT(DBCSLIB/QUSRIGCDCT) +  
ENTRY('ABC*')
```

#### *Adding the first entries in a DBCS conversion dictionary*

To add the first entries into a dictionary, follow these steps.

1. Specify ENTRY(\*ALL) when entering the EDTIGCDCT command. For example, to edit the dictionary QUSRIGCDCT stored in the library DBCSLIB, enter:

```
EDTIGCDCT IGCDCT(DBCSLIB/QUSRIGCDCT) +  
ENTRY(*ALL)
```

The system displays the Work with DBCS Conversion Dictionary display.

2. Enter a 1 in the first option field in the list and enter an alphanumeric entry to be added to the dictionary in the entry field.

The system then displays the Edit Related Words display showing only two lines of data: BEGINNING OF DATA and END OF DATA.

3. Enter an I in the *NBR* field beside the BEGINNING OF DATA line to insert a line.
4. Press Enter. The system displays a blank line.

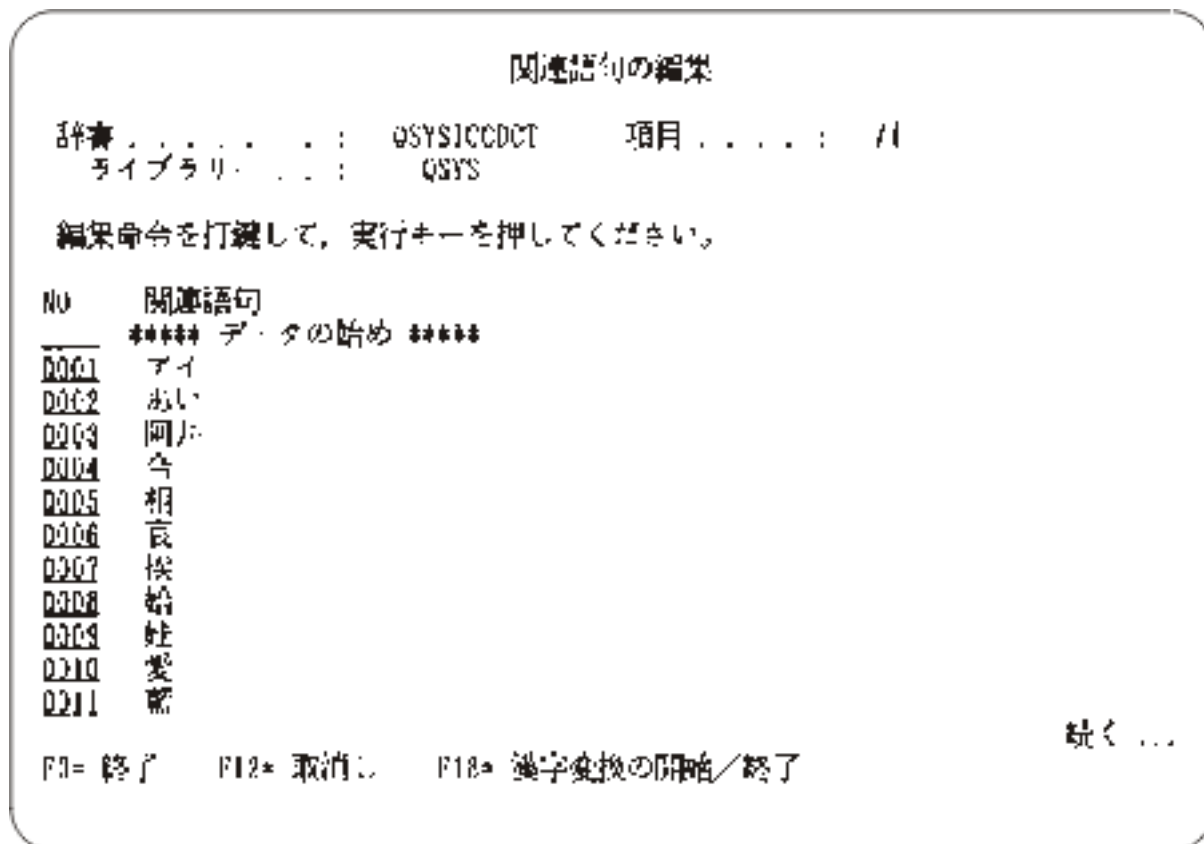

Figure 24. Display for Edit Related Words

5. On the blank line, enter a DBCS word to be related to the new alphanumeric entry.

If you enter data on the inserted line and leave the cursor on that line, another new line appears when you press the Enter key. You can enter another DBCS word on this line, or delete it by leaving it blank, and pressing the Enter key.

6. When you finish adding this first entry, press F12 to get the Exit Dictionary Entry display. Enter the Y option to save the entry and then return to the Work With DBCS Conversion Dictionary display. Enter option 1 again and enter another alphanumeric entry in the entry field to continue adding entries to the dictionary, or press F3 to end editing the dictionary.

#### Moving a related word in a DBCS conversion dictionary

Moving the words related to an alphanumeric entry changes the order in which the words appear during DBCS conversion. To move a word, follow these steps.

1. Display the Edit Related Words display for the entry in which you want to move DBCS words, either by entering a specific entry with the EDTIGCDCT command, or by choosing an entry to edit from the Work with DBCS Conversion Dictionary display.
2. When the display appears, enter an M in the *NBR* field beside the DBCS word to be moved.
3. Enter an A in the *NBR* field of the line after which the word will be moved.
4. Press Enter. The system moves the word on the line marked M to a position immediately following the line marked with an A.

#### Deleting an entry in a DBCS conversion dictionary

You can enter a 4 in the input field beside the entry to be deleted.

See Figure 25 on page 154 for detailed information.

#### Related reference

[Suggestions for editing a DBCS conversion dictionary](#)





To display all of the entries from the system-supplied dictionary QSYSIGCDCT and their related words, enter the following command:

```
DSPIGCDCT IGCDCT(QSYS/QSYSIGCDCT)
```

Figure 26 on page 155 provides an example of the display produced by the DSPIGCDCT command. It shows alphanumeric entries and their related words.

### Related information

[CL concepts and reference](#)

[Display DBCS Conversion Dictionary \(DSPIGCDCT\) command](#)

### Deleting a DBCS conversion dictionary

You can use the Delete DBCS Conversion Dictionary (DLTIGCDCT) command to delete a DBCS conversion dictionary from the system.

In order to delete the dictionary, you must have object existence authority to the dictionary and object operational authorities to the library in which the dictionary is stored.

When you delete a dictionary, make sure that you specify the correct library name. It is possible that many users have their own dictionaries, each named QUSRIGCDCT, stored in their libraries. If you do not specify any library name, the system deletes the first DBCS conversion dictionary in your library list.

For example, to delete the DBCS conversion dictionary QUSRIGCDCT in the library DBCSLIB, enter:

```
DLTIGCDCT IGCDCT(DBCSLIB/QUSRIGCDCT)
```

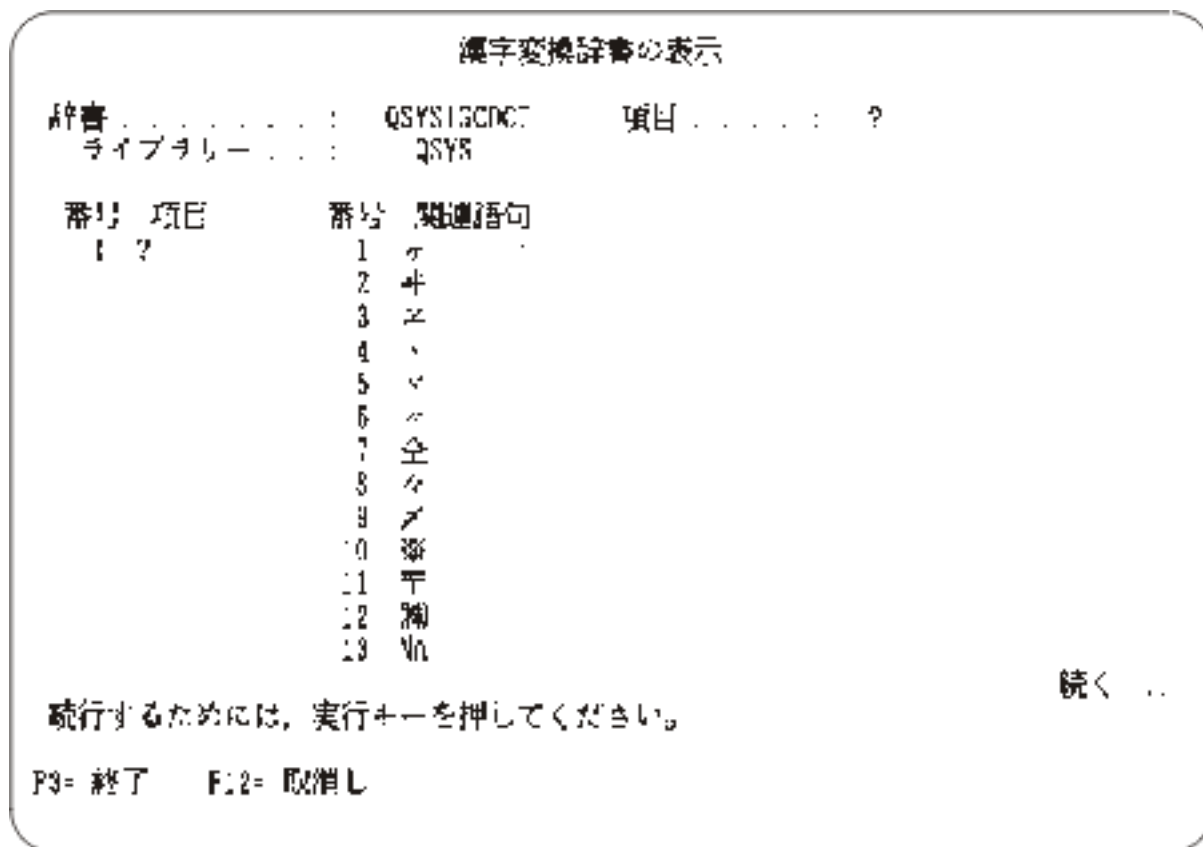

Figure 26. Display produced by the DSPIGCDCT command

### Related information

[CL concepts and reference](#)

## DBCS conversion (for Japanese use only)

When you use DBCS display stations to enter double-byte data, you can use the various data entry methods supported on the display station, or you can choose to use the IBM i DBCS conversion support.

DBCS conversion lets you enter an alphanumeric entry or DBCS code and convert the entry or code to its related DBCS word. DBCS conversion is intended for Japanese character sets and its use is limited for application to other double-byte character sets.

Specifically, DBCS conversion lets you convert the following data:

- A string of alphanumeric characters to a DBCS word
- English alphanumeric characters to double-byte alphanumeric characters
- Alphanumeric Katakana to double-byte Hiragana and Katakana letters
- A *DBCS code* to its corresponding double-byte character
- A *DBCS number* to its corresponding double-byte character

### ***Where you can use DBCS conversion***

This topic lists the occasions that you can use DBCS conversion.

- Prompting for double-byte data using QCMDXEXEC. For instructions on this procedure, see [Control language \(CL\)](#).
- Entering data into input fields of DBCS display files in user-written applications. Specify DBCS conversion with the DDS keyword IGCCNV. See [DDS concepts](#) for information about this keyword.
- Editing the related words on the Edit Related Words display, which is displayed when editing the DBCS conversion dictionary (EDTIGCDCT command).

### **Related reference**

[Editing a DBCS conversion dictionary](#)

You can Use the Edit DBCS Conversion Dictionary (EDTIGCDCT) command to edit the DBCS conversion dictionary.

### ***How DBCS conversion works***

DBCS conversion is an interactive function between you and the system in which you enter an alphanumeric entry. The system displays related DBCS words, and you choose which word to use.

The system determines which words are related to an alphanumeric entry by checking DBCS conversion dictionaries. The system checks two DBCS conversion dictionaries when performing DBCS conversion. It checks the first user-created dictionary named QUSRIGCDCT found when searching a user's library list. Then, it checks the system-supplied dictionary, QSYSIGCDCT, stored in the library QSYS. (QSYSIGCDCT contains only Japanese double-byte characters.) You can create other user dictionaries, and you can give them names other than QUSRIGCDCT, but the system only refers to the first user-created dictionary named QUSRIGCDCT found in your library list when performing DBCS conversion.

After checking the dictionaries, the system displays words related to the alphanumeric entry. You then position the cursor under the word of your choice, and press Enter. The system enters that word where the cursor was positioned when you began DBCS conversion.

### **Related reference**

[DBCS conversion dictionaries](#)

The DBCS conversion dictionary is a collection of alphanumeric entries and their related DBCS words. The system refers to the dictionary when performing DBCS conversion.

### **Usage of DBCS conversion**

You can customize the dictionary for DBCS conversion.

You can change the user-defined dictionary used during DBCS conversion. Before you change the user-defined dictionary, end your application program or end the command that the system is performing. Then change the dictionary that is used by changing the library list (using the CHGLIBL command).

You can create your own DBCS conversion dictionary for DBCS conversion. The system-supplied dictionary is a collection of entries with a Japanese pronunciation expressed in alphanumeric characters and Japanese DBCS words related to the entry. See [“Creating a DBCS conversion dictionary” on page 149](#) for instructions on this procedure.

If no user-created dictionary is found, the system refers only to QSYSIGCDCT. See [“DBCS conversion dictionaries” on page 148](#) for more information about creating and using DBCS conversion dictionaries.

### **Performing DBCS conversion**

This topic describes how to convert one alphanumeric entry to its related DBCS word using DBCS conversion. You must start DBCS conversion separately for each field in which you want to enter double-byte data.

**Note:** DBCS conversion is intended for Japanese data entry. Its use with other languages is limited.

While performing DBCS conversion, you can display information about the function by pressing the Help key. Help is available until you end DBCS conversion.

1. Position the cursor in the field in which you want to enter double-byte characters. Insert shift-control characters into the field if they have not yet been inserted. To find out how to insert shift characters, see [“Inserting shift-control double-byte characters” on page 136](#).
2. Position the cursor under the shift-in character, in a blank area between the shift-control characters, or under a double-byte character.
3. Press the function key used to start DBCS conversion.

In the service entry utility (SEU), as well as from the Edit Related Words display (displayed when using the EDTIGCDCT command), press F18. The system displays the following prompt line:

```
  A  -----B----- C
```

4. Enter the following values:

- a. In the field marked A, enter one of the following values:

**I**

Inserts the converted word before the character under which you positioned the cursor in step [“2” on page 157](#).

**R**

Replaces the character under which you positioned the cursor in step [“2” on page 157](#) with the converted word.

- b. In the field marked B, enter one of the following values:

- i) A string of alphanumeric characters to be converted. The string can have as many as 12 characters.
- ii) The 4-character DBCS code of a double-byte character.
- iii) The 2- to 5-digit DBCS number of a double-byte character.

- c. In the field marked C enter one of the following conversion codes:

**No entry**

Converts the entry in field B from alphanumeric to double-byte by referring to the DBCS conversion dictionaries.

**G**

Converts the 2- to 5-digit DBCS number in field B to the character it represents.

**H**

Converts the entry in field B to double-byte Hiragana, uppercase alphabetic, numeric, or special characters.

**K**

Converts the entry in field B to double-byte Hiragana, lowercase alphabetic, numeric, or special characters.

**X**

Converts the 4-character DBCS code to the character it represents.

5. Press Enter. The system displays the following prompt line:

```

A ----- B ----- C ----- D -----+

```

6. In the field marked D, the system displays words related to the entry in field B.

If you see a plus (+) sign following the last displayed word, the system has additional words to display. Press the Roll Up (Page Down) key to see these entries. Then, to return to a word displayed earlier, press the Roll Down (Page Up) key.

If a word is shown in a reverse image, the word contains an embedded blank.

7. Choose the DBCS word from field D that best suits your needs by positioning the cursor under that DBCS word.
8. Press Enter. The system enters the word where the cursor was positioned in step 2, either by inserting the word or by replacing another word, depending on what you entered in field A.
9. Take one of the following actions:
- Continue using DBCS conversion. Repeat [“4” on page 157](#) through [“8” on page 158](#) until you finish entering data into the field.
  - End DBCS conversion by pressing the *same* function key used to start conversion. The system automatically ends conversion when you reach the end of the field.

In SEU, as well as from the Edit Related Words display (displayed when using the EDTIGCDCT command), press F18.

**Note:** Until DBCS conversion is ended, you cannot perform any other system function. For example, the F3 key cannot be used to exit an SEU display.

### *Examples of DBCS Conversion*

This section contains examples of DBCS Conversion.

#### *Converting double-byte Kana to double-byte Kanji*

This example shows how to convert double-byte Kana to double-byte Kanji on a Windows-based workstation such as Personal Communications.

- Position the cursor in the field in which you want to enter double-byte data (see [Figure 27 on page 159](#)).
- Select the function configured for your workstation to start DBCS input mode.
- Type the double-byte Kana characters that are to be converted.
- Press the conversion key. A drop-down list shows related double-byte Kanji words.
- Select the appropriate word from the drop-down list and press Enter. The selected word is displayed in the field as shown in [Figure 28 on page 159](#).

Position the cursor here

日付 : 08/03/18	人 事 情 報 保 守	プログラム名 : EMPMAINT
社員番号 : _____	氏名 <input type="text"/>	画面名 : EMPMAINTF
	カガキ <input type="text"/>	性別 _____ 年齢 _____
現住所		
都道府県名 _____	市町村名 _____	
本籍地		
都道府県名 _____	市町村名 _____	
職位コード _ 職位名称 _____		
部課コード _ 部課名称 _____		
給与 _____ 趣味 _____		

HRSL321-02

Figure 27. Example display 1

日付 : 08/03/18	人 事 情 報 保 守	プログラム名 : EMPMAINT
社員番号 : _____	氏名 新井 <input type="text"/>	画面名 : EMPMAINTF
	カガキ <input type="text"/>	性別 _____ 年齢 _____
現住所		
都道府県名 _____		
本籍地		
都道府県名 _____		
職位コード _ 職位名称 _____		
部課コード _ 部課名称 _____		
給与 _____ 趣味 _____		

1 荒い

2 粗い

3 新井

4 荒井

5 洗い

6 新居

7 荒居

8 新

9 新伊

3/31

HRSL322-02

Figure 28. Example display 2

#### Converting many alphanumeric entries at one time to DBCS

This example shows how to convert many alphanumeric entries to DBCS at one time.

You do not need to continually start DBCS conversion for each alphanumeric entry. Instead, you can follow these steps:

1. Enter as many alphanumeric entries as will fit into field B. Separate each entry by a blank. Field B contains space for 12 alphanumeric characters:

These are the entries to be converted.

```
  |   |   |
  I XXX_YYY_ZZZ_
  A   B   C   D
```

The system converts the entries one at a time, in the order entered. When the system converts an entry, the system displays the DBCS words related to that entry in field D.

2. Position the cursor under the DBCS word that you want to use.
3. Press Enter. Then, the system adjusts field B. The next entry is moved to the position farthest left of the field. The DBCS words related to that entry are displayed in field D.

At this time, you can enter additional alphanumeric entries to be converted at the end of field B.

#### *Converting alphanumeric blanks to DBCS blanks*

This example shows how to convert alphanumeric blanks (one position wide) to DBCS blanks (two positions wide, the same width as double-byte characters) using DBCS conversion.

To convert blanks, follow these steps:

1. Enter one or more blanks in field B.

```
  A ----- B ----- C   D
```

2. Press Enter. The system displays in field D the same number of DBCS blanks as the alphanumeric blanks that you entered in field B. The DBCS blanks are displayed in reverse image.
3. Press Enter again. The system enters the DBCS blanks into the field where you started DBCS conversion.

#### *Changing alphanumeric entries or conversion code to DBCS*

This example shows how to change alphanumeric entries or conversion code to DBCS.

If none of the related words shown during conversion are suitable candidates for the alphanumeric entry, and you would like to try a conversion again (by using a different type of conversion or a different alphanumeric entry), follow these steps:

1. Move the cursor to field B. For example:

```
  Move the cursor here.
  |
  |XXXXXX
  A ----- B ----- C ----- D -----
```

2. Perform one of the following steps:
  - a. Position the cursor under the first position of the field in which you want to enter alphanumeric entries.
  - b. Enter a different alphanumeric entry.
  - c. Change the conversion code in field C, such as from H to K.
3. Press the Enter key.
4. Continue DBCS conversion.

#### *Using DBCS conversion to enter words in the DBCS conversion dictionary*

This example shows how to use DBCS conversion when entering DBCS words on the Edit Related Words display.

To start DBCS conversion, follow these steps:

1. Position the cursor at the position where the DBCS word is to be entered.
2. Press F18. The system displays the conversion prompt line at the bottom of the display.

Perform DBCS conversion according to the instructions described in [“Performing DBCS conversion” on page 157](#).

**Note:** You must start and end DBCS conversion separately for each line of data.

#### *Considerations for using DBCS conversion*

There are certain considerations for using DBCS conversion.

- You can only perform DBCS conversion at a DBCS display station, using the 5556 keyboard.
- You can use DBCS conversion to insert or replace characters only if the line in which double-byte characters are to be inserted has sufficient space.
  - The space available for inserting characters is equal to the number of characters from the last character on the line that is not blank to the right edge of the display.
  - The space available for replacing characters is equal to the number of characters from the cursor position (including the character marked by the cursor) to the end of the DBCS portion of the field.

The following result happens when you do not have enough space:

- If you try to insert or replace a string of characters where there is no space available, the system sends a message.
- If you ignore the message and press the Enter key again, the system truncates the characters that are in excess of the limit from the right side of the string to be inserted or replaced.

## Feedback area layouts

Tables in this section describe the Open feedback area and the I/O feedback area associated with any opened file.

The following information is presented for each item in these feedback areas:

- Offset, which is the number of bytes from the start of the feedback area to the location of each item
- Data type
- Length, which is given in number of bytes
- Contents, which is the description of the item and the valid values for it
- File type, which is an indication of what file types each item is valid for

The support provided by the high-level language you are using determines how to access this information and how the data types are represented. See your high-level language information for more information.

### Open feedback area

The open feedback area is the part of the open data path (ODP) that contains general information about the file after it has been opened. It also contains file-specific information, depending on the file type, plus information about each device or communications session defined for the file. This information is set during open processing and can be updated as other operations are performed.

*Table 22. Open feedback area*

Offset	Data type	Length	Contents	File type
0	Character	2	Open data path (ODP) type: <b>DS</b> Display, tape, ICF, save, printer file not being spooled, or diskette file not being spooled. <b>DB</b> Database member. <b>SP</b> Printer or diskette file being spooled or inline data file.	All

Table 22. Open feedback area (continued)

Offset	Data type	Length	Contents	File type
2	Character	10	Name of the file being opened. If the ODP type is DS, this is the name of the device file or save file. If the ODP type is SP, this is the name of the device file or the inline data file. If the ODP type is DB, this is the name of the database file that the member belongs to.	All
12	Character	10	Name of the library containing the file. For an inline data file, the value is *N.	All
22	Character	10	Name of the spooled file. The name of a database file containing the spooled input or output records.	Printer or diskette being spooled or inline data
32	Character	10	Name of the library in which the spooled file is located.	Printer or diskette being spooled or inline data
42	Binary	2	Spooled file number.	Printer or diskette being spooled
44	Binary	2	Maximum record length.	All
46	Binary	2	Maximum key length.	Database
48	Character	10	Member name: <ul style="list-style-type: none"> <li>• If ODP type DB, the member name in the file named at offset 2. If file is overridden to MBR(*ALL), the member name that supplied the last record.</li> <li>• If ODP type SP, the member name in the file named at offset 22.</li> </ul>	Database, printer, diskette, and inline data
58	Binary	4	Reserved.	
62	Binary	4	Reserved.	



Table 22. Open feedback area (continued)

Offset	Data type	Length	Contents	File type
66	Binary	2	File type: <b>1</b> Display <b>2</b> Printer <b>4</b> Diskette <b>5</b> Tape <b>9</b> Save <b>10</b> DDM <b>11</b> ICF <b>20</b> Inline data <b>21</b> Database	All
68	Character	3	Reserved.	
71	Binary	2	Number of lines on a display screen or number of lines on a printed page. Length of the null field byte map.	Display, printer Database
73	Binary	2	Number of positions on a display screen or number of characters on a printed line. Length of the null key field byte map.	Display, printer Database
75	Binary	4	Number of records in the member at open time. For a join logical file, the number of records in the primary. Supplied only if the file is being opened for input.	Database , inline data

Table 22. Open feedback area (continued)

Offset	Data type	Length	Contents	File type
79	Character	2	<p>Access type:</p> <p><b>AR</b> Arrival sequence.</p> <p><b>KC</b> Keyed with duplicate keys allowed. Duplicate keys are accessed in first-changed-first-out (FCFO) order.</p> <p><b>KF</b> Keyed with duplicate keys allowed. Duplicate keys are accessed in first-in-first-out (FIFO) order.</p> <p><b>KL</b> Keyed with duplicate keys allowed. Duplicate keys are accessed in last-in-first-out (LIFO) order.</p> <p><b>KN</b> Keyed with duplicate keys allowed. The duplicate keys can be accessed in one of the following orders:</p> <ul style="list-style-type: none"> <li>• First-in-first-out (FIFO)</li> <li>• Last-in-first-out (LIFO)</li> <li>• First-changed-first-out (FCFO)</li> </ul> <p><b>KU</b> Keyed, unique.</p>	Database
81	Character	1	<p>Duplicate key indication. Set only if the access path is KC, KF, KL, KN, or KU:</p> <p><b>D</b> Duplicate keys allowed if the access path is KF or KL.</p> <p><b>U</b> Duplicate keys are not allowed; all keys are unique and the access path is KU.</p>	Database
82	Character	1	<p>Source file indication.</p> <p><b>Y</b> File is a source file.</p> <p><b>N</b> File is not a source file.</p>	Database, tape, diskette, and inline data
83	Character	10	Reserved.	
93	Character	10	Reserved.	
103	Binary	2	Offset to volume label fields of open feedback area.	Diskette, tape
105	Binary	2	Maximum number of records that can be read or written in a block when using blocked record I/O.	All
107	Binary	2	Overflow line number.	Printer
109	Binary	2	Blocked record I/O record increment. Number of bytes that must be added to the start of each record in a block to address the next record in the block.	All
111	Binary	4	Reserved.	

Table 22. Open feedback area (continued)

Offset	Data type	Length	Contents	File type
115	Character	1	Miscellaneous flags.	
			<b>Bit 1:</b> Reserved.	
			<b>Bit 2:</b> File shareable	All
			<b>0</b> File was not opened shareable.	
			<b>1</b> File was opened shareable (SHARE(*YES)).	
			<b>Bit 3:</b> Commitment control	Database
			<b>0</b> File is not under commitment control.	
			<b>1</b> File is under commitment control.	
			<b>Bit 4:</b> Commitment lock level	Database
			<b>0</b> Only changed records are locked (LCKLVL (*CHG)). If this bit is zero and bit 8 of the character at offset 132 is one, then all records accessed are locked, but the locks are released when the current position in the file changes (LCKLVL (*CS)).	
			<b>1</b> All records accessed are locked (LCKLVL (*ALL)).	
			<b>Bit 5:</b> Member type	Database
			<b>0</b> Member is a physical file member.	
			<b>1</b> Member is a logical file member.	
			<b>Bit 6:</b> Field-level descriptions	All, except database
			<b>0</b> File does not contain field-level descriptions.	
			<b>1</b> File contains field-level descriptions.	
			<b>Bit 7:</b> DBCS or graphic-capable file	Database, display, printer, tape, diskette, and ICF
			<b>0</b> File does not contain DBCS or graphic-capable fields.	
			<b>1</b> File does contain DBCS or graphic-capable fields.	

Table 22. Open feedback area (continued)

Offset	Data type	Length	Contents	File type
			<p><b>Bit 8:</b> End-of-file delay</p> <p><b>0</b> End-of-file delay processing is not being done.</p> <p><b>1</b> End-of-file delay processing is being done.</p>	Database
116	Character	10	<p>Name of the requester device. For display files, this is the name of the display device description that is the requester device. For ICF files, this is the program device name associated with the remote location of *REQUESTER.</p> <p>This field is supplied only when either a device or remote location name of *REQUESTER is being attached to the file by an open or acquire operation. Otherwise, this field contains *N.</p>	Display, ICF
126	Binary	2	File open count. If the file has not been opened shareable, this field contains a 1. If the file has been opened shareable, this field contains the number of programs currently attached to this file.	All
128	Binary	2	Reserved.	
130	Binary	2	Number of based-on physical members opened. For logical members, this is the number of physical members over which the logical member was opened. For physical members, this field is always set to 1.	Database
132	Character	1	Miscellaneous flags.	
			<p><b>Bit 1:</b> Multiple member processing</p> <p><b>0</b> Only the member specified will be processed.</p> <p><b>1</b> All members will be processed.</p>	Database
			<p><b>Bit 2:</b> Join logical file</p> <p><b>0</b> File is not a join logical file.</p> <p><b>1</b> File is a join logical file.</p>	Database
			<p><b>Bit 3:</b> Local or remote data (DDM files)</p> <p><b>0</b> Data is stored on local system.</p> <p><b>1</b> Data is stored on remote system.</p>	Database

Table 22. Open feedback area (continued)

Offset	Data type	Length	Contents	File type
			<p><b>Bit 4:</b> Remote System/38 or IBM i data (DDM files). Applicable only if the value of Bit 3 is 1.</p> <p><b>0</b> Data is on a remote System/38 or IBM i product.</p> <p><b>1</b> Data is not on a remote System/38 or IBM i product.</p>	Database
			<p><b>Bit 5:</b> Separate indicator area</p> <p><b>0</b> Indicators are in the I/O buffer of the program.</p> <p><b>1</b> Indicators are not in the I/O buffer of the program. The DDS keyword, INDARA, was used when the file was created.</p>	Printer, display, and ICF
			<p><b>Bit 6:</b> User buffers</p> <p><b>0</b> The system creates I/O buffers for the program.</p> <p><b>1</b> User program supplies I/O buffers.</p>	All
			<p><b>Bit 7:</b> Reserved.</p>	
			<p><b>Bit 8:</b> Additional commitment lock level indicator. This is only valid if bit 3 of the character at offset 115 is one.</p> <p>If bit 4 of the character at offset 115 is zero:</p> <p><b>0</b> Only changed records are locked (LCKLVL(*CHG)).</p> <p><b>1</b> All records accessed are locked, but the locks are released when the current position in the file changes (LCKLVL(*CS)).</p> <p>If bit 4 of the character at offset 115 is one:</p> <p><b>0</b> All records accessed are locked (LCKLVL(*ALL)).</p> <p><b>1</b> Reserved.</p>	Database
133	Character	2	Open identifier. This value is unique for a full open operation (SHARE(*NO)) or the first open of a file that is opened with SHARE(*YES). This is used for display and ICF files, but is set up for all file types. It allows you to match this file to an entry on the associated data queue.	All



Table 22. Open feedback area (continued)

Offset	Data type	Length	Contents	File type
146	Binary	2	Number of devices defined for this ODP. For displays, this is determined by the number of devices defined on the DEV parameter of the Create Display File (CRTDSPF) command. For ICF, this is determined by the number of program devices defined or acquired with the Add ICF Device Entry (ADDICFDEVE) or the Override ICF Device Entry (OVRICFDEVE) command. For all other files, it has the value of 1.	All
148	Character		Device name definition list.	All

### Related concepts

Monitoring file status with the open and I/O feedback area

The system monitors the status of a file in feedback areas after it opens the file.

### Device definition list

The device definition list part of the open feedback area is an array structure. Each entry in the array contains information about each device or communications session attached to the file. The number of entries in this array is determined by the number at offset 146 of the open feedback area.

The device definition list begins at offset 148 of the open feedback area. The offsets shown for it are from the start of the device definition list rather than the start of the open feedback area.

Table 23. Device definition list

Offset	Data type	Length	Contents	File type
0	Character	10	Program device name. For database files, the value is DATABASE. For printer or diskette files being spooled, the value is *N. For save files, the value is *NONE. For ICF files, the value is the name of the program device from the ADDICFDEVE or OVRICFDEVE command. For all other files, the value is the name of the device description.	All, except inline data
10	Character	50	Reserved.	
60	Character	10	Device description name. For printer or diskette files being spooled, the value is *N. For save files, the value is *NONE. For all other files, the value is the name of the device description.	All, except database and inline data
70	Character	1	Device class. <b>hex 01</b> Display <b>hex 02</b> Printer <b>hex 04</b> Diskette <b>hex 05</b> Tape <b>hex 09</b> Save <b>hex 0B</b> ICF	All, except database and inline data

Table 23. Device definition list (continued)

Offset	Data type	Length	Contents	File type
71	Character	1	Device type.	
			<b>hex 02</b> 5256 Printer	
			<b>hex 07</b> 5251 Display Station	
			<b>hex 08</b> Spooled	
			<b>hex 0A</b> BSCCL	
			<b>hex 0B</b> 5291 Display Station	
			<b>hex 0C</b> 5224/5225 printers	
			<b>hex 0D</b> 5292 Display Station	
			<b>hex 0E</b> APPC	
			<b>hex 0F</b> 5219 Printer	
			<b>hex 10</b> 5583 Printer (DBCS)	
			<b>hex 11</b> 5553 Printer	
			<b>hex 12</b> 5555-B01 Display Station	
			<b>hex 13</b> 3270 Display Station	
			<b>hex 14</b> 3270 Printer	
			<b>hex 15</b> Graphic-capable device	
			<b>hex 16</b> Financial Display Station	
			<b>hex 17</b> 3180 Display Station	
			<b>hex 18</b> Save file	
			<b>hex 19</b> 3277 DHCF Device	
			<b>hex 1A</b> 9347 Tape Unit	
			<b>hex 1B</b> 9348 Tape Unit	
			<b>hex 1C</b> 9331-1 Diskette Unit	
			<b>hex 1D</b> 9331-2 Diskette Unit	



Table 23. Device definition list (continued)

Offset	Data type	Length	Contents	File type
			<b>hex 1E</b> Intrasystem communications support	
			<b>hex 1F</b> Asynchronous communications support	
			<b>hex 20</b> SNUF	
			<b>hex 21</b> 4234 (SCS) Printer	
			<b>hex 22</b> 3812 (SCS) Printer	
			<b>hex 23</b> 4214 Printer	
			<b>hex 24</b> 4224 (IPDS) Printer	
			<b>hex 25</b> 4245 Printer	
			<b>hex 26</b> 3179-2 Display Station	
			<b>hex 27</b> 3196-A Display Station	
			<b>hex 28</b> 3196-B Display Station	
			<b>hex 29</b> 5262 Printer	
			<b>hex 2A</b> 6346 Tape Unit	
			<b>hex 2B</b> 2440 Tape Unit	
			<b>hex 2C</b> 9346 Tape Unit	
			<b>hex 2D</b> 6331 Diskette Unit	
			<b>hex 2E</b> 6332 Diskette Unit	
			<b>hex 30</b> 3812 (IPDS) Printer	
			<b>hex 31</b> 4234 (IPDS) Printer	
			<b>hex 32</b> IPDS printer, model unknown	
			<b>hex 33</b> 3197-C1 Display Station	
			<b>hex 34</b> 3197-C2 Display Station	
			<b>hex 35</b> 3197-D1 Display Station	

Table 23. Device definition list (continued)

Offset	Data type	Length	Contents	File type
			<b>hex 36</b> 3197-D2 Display Station	
			<b>hex 37</b> 3197-W1 Display Station	
			<b>hex 38</b> 3197-W2 Display Station	
			<b>hex 39</b> 5555-E01 Display Station	
			<b>hex 3A</b> 3430 Tape Unit	
			<b>hex 3B</b> 3422 Tape Unit	
			<b>hex 3C</b> 3480 Tape Unit	
			<b>hex 3D</b> 3490 Tape Unit	
			<b>hex 3E</b> 3476-EA Display Station	
			<b>hex 3F</b> 3477-FG Display Station	
			<b>hex 40</b> 3278 DHCF device	
			<b>hex 41</b> 3279 DHCF device	
			<b>hex 42</b> ICF finance device	
			<b>hex 43</b> Retail communications device	
			<b>hex 44</b> 3477-FA Display Station	
			<b>hex 45</b> 3477-FC Display Station	
			<b>hex 46</b> 3477-FD Display Station	
			<b>hex 47</b> 3477-FW Display Station	
			<b>hex 48</b> 3477-FE Display Station	
			<b>hex 49</b> 6367 Tape Unit	
			<b>hex 4A</b> 6347 Tape Unit	
			<b>hex 4D</b> Network Virtual Terminal Display Station	
			<b>hex 4E</b> 6341 Tape Unit	
			<b>hex 4F</b> 6342 Tape Unit	

Table 23. Device definition list (continued)

Offset	Data type	Length	Contents	File type
			<b>hex 50</b> 6133 Diskette Unit	
			<b>hex 51</b> 5555-C01 Display Station	
			<b>hex 52</b> 5555-F01 Display Station	
			<b>hex 53</b> 6366 Tape Unit	
			<b>hex 54</b> 7208 Tape Unit	
			<b>hex 55</b> 6252 (SCS) Printer	
			<b>hex 56</b> 3476-EC Display Station	
			<b>hex 57</b> 4230 (IPDS) Printer	
			<b>hex 58</b> 5555-G01 Display Station	
			<b>hex 59</b> 5555-G02 Display Station	
			<b>hex 5A</b> 6343 Tape Unit	
			<b>hex 5B</b> 6348 Tape Unit	
			<b>hex 5C</b> 6368 Tape Unit	
			<b>hex 5D</b> 3486-BA Display Station	
			<b>hex 5F</b> 3487-HA Display Station	
			<b>hex 60</b> 3487-HG Display Station	
			<b>hex 61</b> 3487-HW Display Station	
			<b>hex 62</b> 3487-HC Display Station	
			<b>hex 63</b> 3935 (IPDS) Printer	
			<b>hex 64</b> 6344 Tape Unit	
			<b>hex 65</b> 6349 Tape Unit	
			<b>hex 66</b> 6369 Tape Unit	
			<b>hex 67</b> 6380 Tape Unit	
			<b>hex 68</b> 6378 Tape Unit	
			<b>hex 69</b> 6390 Tape Unit	

---

*Table 23. Device definition list (continued)*

---

<b>Offset</b>	<b>Data type</b>	<b>Length</b>	<b>Contents</b>	<b>File type</b>
72	Binary	2	Number of lines on the display screen.	Display
74	Binary	2	Number of positions in each line of the display screen.	Display

---

Table 23. Device definition list (continued)

Offset	Data type	Length	Contents	File type
76	Character	2	<p>Bit flags.</p> <p><b>Bit 1:</b> Blinking capability.</p> <p><b>0</b> Display is not capable of blinking.</p> <p><b>1</b> Display is capable of blinking.</p> <p><b>Bit 2:</b> Device location.</p> <p><b>0</b> Local device.</p> <p><b>1</b> Remote device.</p> <p><b>Bit 3:</b> Acquire status. This bit is set even if the device is implicitly acquired at open time.</p> <p><b>0</b> Device is not acquired.</p> <p><b>1</b> Device is acquired.</p> <p><b>Bit 4:</b> Invite status.</p> <p><b>0</b> Device is not invited.</p> <p><b>1</b> Device is invited.</p> <p><b>Bit 5:</b> Data available status (only if device is invited).</p> <p><b>0</b> Data is not available.</p> <p><b>1</b> Data is available.</p> <p><b>Bit 6:</b> Transaction status.</p> <p><b>0</b> Transaction is not started. An evoke request has not been sent, a detach request has been sent or received, or the transaction has completed.</p> <p><b>1</b> Transaction is started. The transaction is active. An evoke request has been sent or received and the transaction has not ended.</p>	Display

Table 23. Device definition list (continued)

Offset	Data type	Length	Contents	File type
			<p><b>Bit 7:</b> Requester device.</p> <p><b>0</b> Not a requester device.</p> <p><b>1</b> A requester device.</p> <p><b>Bit 8:</b> DBCS device.</p> <p><b>0</b> Device is not capable of processing double-byte data.</p> <p><b>1</b> Device is capable of processing double-byte data.</p> <p><b>Bits 9-10:</b> Reserved.</p> <p><b>Bit 11:</b> DBCS keyboard.</p> <p><b>0</b> Keyboard is not capable of entering double-byte data.</p> <p><b>1</b> Keyboard is capable of entering double-byte data.</p> <p><b>Bits 12-16:</b> Reserved.</p>	
78	Character	1	<p>Synchronization level.</p> <p><b>hex 00</b> The transaction was built with SYNLVL(*NONE). Confirm processing is not allowed.</p> <p><b>hex 01</b> The transaction was built with SYNLVL(*CONFIRM). Confirm processing is allowed.</p> <p><b>hex 02</b> The transaction was built with SYNLVL(*COMMIT).</p>	ICF
79	Character	1	<p>Conversation type.</p> <p><b>hex D0</b> Basic conversation (CNVTYPE(*USER)).</p> <p><b>hex D1</b> Mapped conversation (CNVTYPE(*SYS)).</p>	ICF
80	Character	50	Reserved.	

## Volume label fields

The table in this topic shows the volume label fields and their properties.

Table 24. Volume label fields

Offset	Data type	Length	Contents	File type
0	Character	128	Volume label of current volume.	Diskette, tape
128	Character	128	Header label 1 of the opened file.	Diskette, tape
256	Character	128	Header label 2 of the opened file.	Tape

## I/O feedback area

The IBM i operating system uses messages and I/O feedback information to communicate the results of I/O operations to the program.

The system updates the I/O feedback area for every successful I/O operation unless your program uses blocked record I/O.

In that case, the system updates the feedback area only when it reads or writes a block of records. Some of the information reflects the last record in the block. Other information, such as the count of I/O operations, reflects the number of operations on blocks of records and not the number of records. See your high-level language information to determine if your program uses blocked record I/O.

The I/O feedback area consists of two parts: a common area and a file-dependent area.

### Related concepts

[Monitoring file status with the open and I/O feedback area](#)

The system monitors the status of a file in feedback areas after it opens the file.

## Common I/O feedback area

This table shows the common I/O feedback area of the IBM i operating system.

Table 25. Common I/O feedback area

Offset	Data type	Length	Contents
0	Binary	2	Offset to file-dependent feedback area.
2	Unsigned Binary	4	Write operation count. Updated only when a write operation completes successfully. For blocked record I/O operations, this count is the number of blocks, not the number of records. If the maximum possible count value is reached the operation count will remain at that value.
6	Unsigned Binary	4	Read operation count. Updated only when a read operation completes successfully. For blocked record I/O operations, this count is the number of blocks, not the number of records. If the maximum possible count value is reached the operation count will remain at that value.
10	Unsigned Binary	4	Write-read operation count. Updated only when a write-read operation completes successfully. If the maximum possible count value is reached the operation count will remain at that value.

Table 25. Common I/O feedback area (continued)

Offset	Data type	Length	Contents
14	Binary	4	Other operation count. Number of successful operations other than write, read, or write-read. Updated only when the operation completes successfully. This count includes update, delete, force-end-of-data, force-end-of-volume, change-end-of-data, release record lock, and acquire/release device operations.
18	Character	1	Reserved.
19	Character	1	Current operation. <b>hex 01</b> Read or read block or read from invited devices <b>hex 02</b> Read direct <b>hex 03</b> Read by key <b>hex 05</b> Write or write block <b>hex 06</b> Write-read <b>hex 07</b> Update <b>hex 08</b> Delete <b>hex 09</b> Force-end-of-data <b>hex 0A</b> Force-end-of-volume <b>hex 0D</b> Release record lock <b>hex 0E</b> Change end-of-data <b>hex 0F</b> Put deleted record <b>hex 11</b> Release device <b>hex 12</b> Acquire device



Table 25. Common I/O feedback area (continued)

Offset	Data type	Length	Contents
20	Character	10	<p>Name of the record format just processed, which is either:</p> <ul style="list-style-type: none"> <li>• Specified on the I/O request, or</li> <li>• Determined by default or format selection processing</li> </ul> <p>For display files, the default name is either the name of the only record format in the file or the previous record format name for the record written to the display that contains input-capable fields. Because a display file might have multiple formats on the display at the same time, this format might not represent the format where the last cursor position was typed.</p> <p>For ICF files, the format name is determined by the system, based on the format selection option used. Refer to the <a href="#">ICF Programming</a> book for more information</p>  <p>.</p>
30	Character	2	<p>Device class:</p> <p>Byte 1:</p> <p><b>hex 00</b> Database</p> <p><b>hex 01</b> Display</p> <p><b>hex 02</b> Printer</p> <p><b>hex 04</b> Diskette</p> <p><b>hex 05</b> Tape</p> <p><b>hex 09</b> Save</p> <p><b>hex 0B</b> ICF</p>

Table 25. Common I/O feedback area (continued)

Offset	Data type	Length	Contents
			Byte 2 (if byte 1 contains hex 00):
			<b>hex 00</b> Nonkeyed file
			<b>hex 01</b> Keyed file
			Byte 2 (if byte 1 does not contain hex 00):
			<b>hex 02</b> 5256 Printer
			<b>hex 07</b> 5251 Display Station
			<b>hex 08</b> Spooled
			<b>hex 0A</b> BSCCL
			<b>hex 0B</b> 5291 Display Station
			<b>hex 0C</b> 5224/5225 printers
			<b>hex 0D</b> 5292 Display Station
			<b>hex 0E</b> APPC
			<b>hex 0F</b> 5219 Printer
			<b>hex 10</b> 5583 Printer (DBCS)
			<b>hex 11</b> 5553 Printer
			<b>hex 12</b> 5555-B01 Display Station
			<b>hex 13</b> 3270 Display Station
			<b>hex 14</b> 3270 Printer
			<b>hex 15</b> Graphic-capable device
			<b>hex 16</b> Financial Display Station
			<b>hex 17</b> 3180 Display Station
			<b>hex 18</b> Save file
			<b>hex 19</b> 3277 DHCF device

Table 25. Common I/O feedback area (continued)

Offset	Data type	Length	Contents
			<b>hex 1A</b> 9347 Tape Unit
			<b>hex 1B</b> 9348 Tape Unit
			<b>hex 1C</b> 9331-1 Diskette Unit
			<b>hex 1D</b> 9331-2 Diskette Unit
			<b>hex 1E</b> Intrasystem communications support
			<b>hex 1F</b> Asynchronous communications support
			<b>hex 20</b> SNUF
			<b>hex 21</b> 4234 (SCS) Printer
			<b>hex 22</b> 3812 (SCS) Printer
			<b>hex 23</b> 4214 Printer
			<b>hex 24</b> 4224 (IPDS) Printer
			<b>hex 25</b> 4245 Printer
			<b>hex 26</b> 3179-2 Display Station
			<b>hex 27</b> 3196-A Display Station
			<b>hex 28</b> 3196-B Display Station
			<b>hex 29</b> 5262 Printer
			<b>hex 2A</b> 6346 Tape Unit
			<b>hex 2B</b> 2440 Tape Unit
			<b>hex 2C</b> 9346 Tape Unit
			<b>hex 2D</b> 6331 Diskette Unit
			<b>hex 2E</b> 6332 Diskette Unit

Table 25. Common I/O feedback area (continued)

Offset	Data type	Length	Contents
			<b>hex 30</b> 3812 (IPDS) Printer
			<b>hex 31</b> 4234 (IPDS) Printer
			<b>hex 32</b> IPDS printer, model unknown
			<b>hex 33</b> 3197-C1 Display Station
			<b>hex 34</b> 3197-C2 Display Station
			<b>hex 35</b> 3197-D1 Display Station
			<b>hex 36</b> 3197-D2 Display Station
			<b>hex 37</b> 3197-W1 Display Station
			<b>hex 38</b> 3197-W2 Display Station
			<b>hex 39</b> 5555-E01 Display Station
			<b>hex 3A</b> 3430 Tape Unit
			<b>hex 3B</b> 3422 Tape Unit
			<b>hex 3C</b> 3480 Tape Unit
			<b>hex 3D</b> 3490 Tape Unit
			<b>hex 3E</b> 3476-EA Display Station
			<b>hex 3F</b> 3477-FG Display Station
			<b>hex 40</b> 3278 DHCF device
			<b>hex 41</b> 3279 DHCF device
			<b>hex 42</b> ICF finance device
			<b>hex 43</b> Retail communications device
			<b>hex 44</b> 3477-FA Display Station

Table 25. Common I/O feedback area (continued)

Offset	Data type	Length	Contents
			<b>hex 45</b> 3477-FC Display Station
			<b>hex 46</b> 3477-FD Display Station
			<b>hex 47</b> 3477-FW Display Station
			<b>hex 48</b> 3477-FE Display Station
			<b>hex 49</b> 6367 Tape Unit
			<b>hex 4A</b> 6347 Tape Unit
			<b>hex 4D</b> Network Virtual Terminal Display Station
			<b>hex 4E</b> 6341 Tape Unit
			<b>hex 4F</b> 6342 Tape Unit
			<b>hex 50</b> 6133 Diskette Unit
			<b>hex 51</b> 5555-C01 Display Station
			<b>hex 52</b> 5555-F01 Display Station
			<b>hex 53</b> 6366 Tape Unit
			<b>hex 54</b> 7208 Tape Unit
			<b>hex 55</b> 6252 (SCS) Printer
			<b>hex 56</b> 3476-EC Display Station
			<b>hex 57</b> 4230 (IPDS) Printer
			<b>hex 58</b> 5555-G01 Display Station
			<b>hex 59</b> 5555-G02 Display Station
			<b>hex 5A</b> 6343 Tape Unit
			<b>hex 5B</b> 6348 Tape Unit
			<b>hex 5C</b> 6368 Tape Unit
			<b>hex 5D</b> 3486-BA Display Station
			<b>hex 5F</b> 3487-HA Display Station

Table 25. Common I/O feedback area (continued)

Offset	Data type	Length	Contents
			<b>hex 60</b> 3487-HG Display Station
			<b>hex 61</b> 3487-HW Display Station
			<b>hex 62</b> 3487-HC Display Station
			<b>hex 63</b> 3935 (IPDS) Printer
			<b>hex 64</b> 6344 Tape Unit
			<b>hex 65</b> 6349 Tape Unit
			<b>hex 66</b> 6369 Tape Unit
			<b>hex 67</b> 6380 Tape Unit
			<b>hex 68</b> 6378 Tape Unit
			<b>hex 69</b> 6390 Tape Unit
			<b>hex 70</b> 6379 Tape Unit
			<b>hex 71</b> 9331-11 Diskette Unit
			<b>hex 72</b> 9331-12 Diskette Unit
			<b>hex 73</b> 3570 Tape Unit
			<b>hex 74</b> 3590 Tape Unit
			<b>hex 75</b> 6335 Tape Unit
32	Character	10	Device name. The name of the device for which the operation just completed. Supplied only for display, printer, tape, diskette, and ICF files. For printer or diskette files being spooled, the value is *N. For ICF files, the value is the program device name. For other files, the value is the device description name.
42	Binary	4	Length of the record processed by the last I/O operation (supplied only for an ICF, display, tape, or database file). On ICF write operations, this is the record length of the data. On ICF read operations, it is the record length of the record associated with the last read operation.
46	Character	80	Reserved.

Table 25. Common I/O feedback area (continued)

Offset	Data type	Length	Contents
126	Binary	2	Number of records retrieved on a read request for blocked records or sent on a write or force-end-of-data or force-end-of-volume request for blocked records. Supplied only for database, diskette, and tape files.
128	Binary	2	<p>For output, the field value is the record format length, including first-character forms control, option indicators, source sequence numbers, and program-to-system data. If the value is zero, use the field at offset 42.</p> <p>For input, the field value is the record format length, including response indicators and source sequence numbers. If the value is zero, use the field at offset 42.</p>
130	Character	2	Reserved.
132	Unsigned Binary	4	Current block count. The number of blocks of the tape data file already written or read. For tape files only. If the maximum possible count value is reached the block count will remain at that value.
136	Character	8	Reserved.

## ***I/O feedback area for ICF and display files***

The table in this topic shows the I/O feedback area for ICF and display files.

*Table 26. I/O feedback area for ICF and display files*

<b>Offset</b>	<b>Data type</b>	<b>Length</b>	<b>Contents</b>	<b>File type</b>
<b>0</b>	<b>Character</b>	<b>2</b>	<b>Flag bits.</b> <b>Bit 1:</b> Cancel-read indicator. <b>0</b> The cancel-read operation did not cancel the read request. <b>1</b> The cancel-read operation canceled the read request. <b>Bit 2:</b> Data-returned indicator. <b>0</b> The cancel-read operation did not change the contents of the input buffer. <b>1</b> The cancel-read operation placed the data from the read-with-no-wait operation into the input buffer. <b>Bit 3:</b> Command key indicator. <b>0</b> Conditions for setting this indicator did not occur. <b>1</b> The Print, Help, Home, Roll Up, Roll Down, or Clear key was pressed. The key is enabled with a DDS keyword, but without a response indicator specified. <b>Bits 4-16:</b> Reserved.	<b>Display</b>



Table 26. I/O feedback area for ICF and display files (continued)

Offset	Data type	Length	Contents	File type
2	Character	1	<p><b>Attention indicator byte (AIB). This field identifies which function key was pressed.</b></p> <p>For ICF files, this field will always contain the value hex F1 to imitate the Enter key being pressed on a display device.</p> <p>For display files, this field will contain the 1-byte hexadecimal value returned from the device.</p> <p><b>Hex codes</b>  <b>Function keys</b></p> <p><b>hex 31</b> 1</p> <p><b>hex 32</b> 2</p> <p><b>hex 33</b> 3</p> <p><b>hex 34</b> 4</p> <p><b>hex 35</b> 5</p> <p><b>hex 36</b> 6</p> <p><b>hex 37</b> 7</p> <p><b>hex 38</b> 8</p> <p><b>hex 39</b> 9</p> <p><b>hex 3A</b> 10</p> <p><b>hex 3B</b> 11</p> <p><b>hex 3C</b> 12</p> <p><b>hex B1</b> 13</p> <p><b>hex B2</b> 14</p> <p><b>hex B3</b> 15</p> <p><b>hex B4</b> 16</p> <p><b>hex B5</b> 17</p>	

Table 26. I/O feedback area for ICF and display files (continued)

Offset	Data type	Length	Contents	File type
			<b>hex B6</b> 18	<b>Display, ICF</b>
			<b>hex B7</b> 19	
			<b>hex B8</b> 20	
			<b>hex B9</b> 21	
			<b>hex BA</b> 22	
			<b>hex BB</b> 23	
			<b>hex BC</b> 24	
			<b>hex BD</b> Clear	
			<b>hex F1</b> Enter/Rec Adv	
			<b>hex F3</b> Help (not in operator-error mode)	
			<b>hex F4</b> Roll Down	
			<b>hex F5</b> Roll Up	
			<b>hex F6</b> Print	
			<b>hex F8</b> Record Backspace	
			<b>hex 3F</b> Auto Enter (for Selector Light Pen)	
<b>3</b>	<b>Character</b>	<b>2</b>	<b>Cursor location (line and position).</b> Updated on input operations that are not subfile operations that return data to the program. For example, hex 0102 means line 1, position 2. Line 10, position 33 would be hex 0A21.	<b>Display</b>
<b>5</b>	<b>Binary</b>	<b>4</b>	<b>Actual data length.</b> For an ICF file, see the <a href="#">ICF Programming</a> book for additional information.  For a display file, this is the length of the record format processed by the I/O operation.	<b>Display, ICF</b>

Table 26. I/O feedback area for ICF and display files (continued)

Offset	Data type	Length	Contents	File type
9	Binary	2	<b>Relative record number of a subfile record.</b> Updated for a subfile record operation. For input operations, updated only if data is returned to the program. If multiple subfiles are on the display, this offset will contain the relative record number for the last subfile updated.	Display
11	Binary	2	<b>Lowest subfile.</b> Indicates the lowest subfile relative record number currently displayed in the uppermost subfile display area if the last write operation was done to the subfile control record with SFLDSP specified. Updated for roll up and roll down operations. Reset to 0 on a write operation to another record. Not set for message subfiles.	Display
13	Binary	2	<b>Total number of records in a subfile.</b> Updated on a put-relative operation to any subfile record. The number is set to zero on a write or write-read operation to any subfile control record with the SFLINZ keyword optioned on. If records are put to multiple subfiles on the display, this offset will contain the total number of records for all subfiles assuming that no write or write-read operations were performed to any subfile control record with the SFLINZ keyword optioned on.	Display
15	Character	2	<b>Cursor location (line and position) within active window.</b> Updated on input operations that are not subfile operations that return data to the program. For example, hex 0203 means line 2, position 3 relative to the upper-left corner of the active window.	Display
17	Character	17	<b>Reserved.</b>	

Table 26. I/O feedback area for ICF and display files (continued)



Offset	Data type	Length	Contents	File type
34	Character	2	<p><b>Major return code.</b></p> <p><b>00</b> Operation completed successfully.</p> <p><b>02</b> Input operation completed successfully, but job is being canceled (controlled).</p> <p><b>03</b> Input operation completed successfully, but no data received.</p> <p><b>04</b> Output exception.</p> <p><b>08</b> Device already acquired.</p> <p><b>11</b> Read from invited devices was not successful.</p> <p><b>34</b> Input exception.</p> <p><b>80</b> Permanent system or file error.</p> <p><b>81</b> Permanent session or device error.</p> <p><b>82</b> Acquire or open operation failed.</p> <p><b>83</b> Recoverable session or device error.</p>	Display, ICF
36	Character	2	<p><b>Minor return code.</b> For the values for a display file, see the <a href="#">Application Display Programming book</a>.</p> <p> For the values for an ICF file, see the <a href="#">ICF Programming book</a> and the appropriate communications-type programmer's guide.</p> <p></p>	Display, ICF
38	Character	8	<p><b>Systems Network Architecture (SNA) sense return code.</b> For some return codes, this field might contain more detailed information about the reason for the error. For a description of the SNA sense codes, see the appropriate SNA book.</p>	ICF

Table 26. I/O feedback area for ICF and display files (continued)

Offset	Data type	Length	Contents	File type
46	Character	1	<b>Safe indicator:</b> <b>0</b> An end-of-text (ETX) control character has not been received. <b>1</b> An ETX control character has been received.	ICF
47	Character	1	<b>Reserved.</b>	
48	Character	1	<b>Request Write (RQSWRT) command from remote system/application.</b> <b>0</b> RQSWRT not received <b>1</b> RQSWRT received	ICF
49	Character	10	<b>Record format name received from the remote system.</b>	ICF
59	Character	4	<b>Reserved.</b>	
63	Character	8	<b>Mode name.</b>	ICF
71	Character	9	<b>Reserved.</b>	

#### Related concepts

Monitoring file status with the open and I/O feedback area

The system monitors the status of a file in feedback areas after it opens the file.

#### ***I/O feedback area for printer files***

The table in this topic shows the I/O feedback area for printer files.

Table 27. I/O feedback area for printer files

Offset	Data type	Length	Contents
0	Binary	2	Current line number in a page.
2	Binary	4	Current page count.
6	Character	1	Bit 1: Spooled file has been deleted: <b>1</b> The spooled file has been deleted. <b>0</b> The spooled file has not been deleted.
7	Character	27	Bits 2 - 8: Reserved. Reserved.

Table 27. I/O feedback area for printer files (continued)

Offset	Data type	Length	Contents
34	Character	2	Major return code. <b>00</b> Operation completed successfully. <b>80</b> Permanent system or file error. <b>81</b> Permanent device error. <b>82</b> Open operation failed. <b>83</b> Recoverable device error occurred.
36	Character	2	Minor return code.

#### Related concepts

Monitoring file status with the open and I/O feedback area

The system monitors the status of a file in feedback areas after it opens the file.

#### Related information

Printing

#### ***I/O feedback area for database files***

The table in this topic shows the I/O feedback area for database files.

Table 28. I/O feedback area for database files

Offset	Data type	Length	Contents
0	Binary	4	Size of the database feedback area, including the key and the null key field byte map.
4	Character	4	<b>Bits 1-24:</b> Each bit represents a join logical file in JFILE keyword. <b>0</b> JDFTVAL not supplied for file <b>1</b> JDFTVAL supplied for file
8	Binary	2	Offset from the beginning of the I/O feedback area for database files to the null key field byte map that follows the key value (which begins at offset 34 in this area).
10	Binary	2	Number of locked records.
12	Binary	2	Maximum number of fields.
14	Binary	4	Offset to the field-mapping error-bit map.

---

Table 28. I/O feedback area for database files (continued)

---

Offset	Data type	Length	Contents
18	Character	1	Current file position indication. <b>Bit 1:</b> Current file position is valid for get-next-key equal operation. <b>0</b> File position is not valid. <b>1</b> File position is valid. <b>Bits 2-8:</b> Reserved.

---

Table 28. I/O feedback area for database files (continued)

Offset	Data type	Length	Contents
19	Character	1	<p>Current record deleted indication:</p> <p><b>Bits 1-2:</b> Reserved.</p> <p><b>Bit 3:</b> Next message indicator.</p> <p><b>0</b> Next message not end of file.</p> <p><b>1</b> Next message might be end of file.</p> <p><b>Bit 4:</b> Deleted record indicator.</p> <p><b>0</b> Current file position is at an active record.</p> <p><b>1</b> Current file position is at a deleted record.</p> <p><b>Bit 5:</b> Write operation key feedback indicator.</p> <p><b>0</b> Key feedback is not provided by last write operation.</p> <p><b>1</b> Key feedback is provided by last write operation.</p> <p><b>Bit 6:</b> File position changed indicator. Set only for read and positioning I/O operations. Not set for write, update, and delete I/O operations.</p> <p><b>0</b> File position did not change.</p> <p><b>1</b> File position did change.</p> <p><b>Bit 7:</b> Pending exception indicator. Valid for files open for input only and SEQONLY(*YES N) where N is greater than 1.</p> <p><b>0</b> Pending retrieval error does not exist.</p> <p><b>1</b> Pending retrieval error does exist.</p> <p><b>Bit 8:</b> Duplicate key indicator.</p> <p><b>0</b> The key of the last read or write operation was not a duplicate key.</p> <p><b>1</b> The key of the last read or write operation was a duplicate key.</p>



---

*Table 28. I/O feedback area for database files (continued)*

---

<b>Offset</b>	<b>Data type</b>	<b>Length</b>	<b>Contents</b>
20	Binary	2	Number of key fields. Use this offset for binary operations. Use the next offset (offset 21) for character operations. These offsets overlap and provide the same value (there can be no more than 32 key fields, and only the low-order byte of offset 20 is used).
21	Character	1	Number of key fields.

---

Table 28. I/O feedback area for database files (continued)

Offset	Data type	Length	Contents
22	Character	1	<p><b>Bit 1:</b>            Decimal floating-point inexact result:  <b>0</b> Exact result.  <b>1</b> Inexact result.</p> <p><b>Bit 2:</b>            Decimal floating-point overflow:  <b>0</b> No overflow.  <b>1</b> Overflow occurred.</p> <p><b>Bit 3:</b>            Decimal floating-point underflow:  <b>0</b> No underflow.  <b>1</b> Underflow occurred.</p> <p><b>Bit 4:</b>            Decimal floating-point divide-by-zero error:  <b>0</b> No divide-by-zero error occurred.  <b>1</b> Divide-by-zero error did occur.</p> <p><b>Bit 5:</b>            Operand not valid for floating point:  <b>0</b> Operands are valid.  <b>1</b> Operands are not valid.</p> <p><b>Bit 6:</b>            Decimal floating-point subnormal result:  <b>0</b> Result is finite, meaning result is not subnormal.  <b>1</b> Result is subnormal.</p> <p><b>Bit 7:</b>            Reserved.</p> <p><b>Bit 8:</b>            Substitution characters for CCSID translation:  <b>0</b> No substitution characters were involved in translation.  <b>1</b> Substitution characters were involved in translation.</p>

Table 28. I/O feedback area for database files (continued)

Offset	Data type	Length	Contents
23	Character	1	<p><b>Bit 1</b> System-time temporal table ROW BEGIN timestamp adjustment:</p> <p><b>0</b> No system-time temporal timestamp adjustment.</p> <p><b>1</b> The ROW BEGIN column of a system-time temporal table was adjusted to ensure that the historical row had a ROW END column with a value that occurs after the ROW BEGIN column's value.</p> <p><b>Bits 2-8:</b> Reserved.</p>
24	Character	2	Reserved.
26	Binary	2	Key length.
28	Binary	2	Data member number.
30	Binary	4	Relative record number in data member.
34	Character	*	Key value.
*	Character	*	Null key field byte map.

### Get attributes feedback area

Performing the get attributes operation allows you to obtain certain information about a specific display device or ICF session.

Table 29. Get attributes

Offset	Data type	Length	Contents	File type
0	Character	10	Program device name.	Display, ICF
10	Character	10	Device description name. Name of the device description associated with this entry.	Display, ICF
20	Character	10	User ID.	Display, ICF
30	Character	1	Device class:	Display, ICF
			<b>D</b> Display	
			<b>I</b> ICF	
			<b>U</b> Unknown	

Table 29. Get attributes (continued)

Offset	Data type	Length	Contents	File type
31	Character	6	Device type: <b>3179</b> 3179 Display Station <b>317902</b> 3179-2 Display Station <b>3180</b> 3180 Display Station <b>3196A</b> 3196-A1/A2 Display Station <b>3196B</b> 3196-B1/B2 Display Station <b>3197C1</b> 3197-C1 Display Station <b>3197C2</b> 3197-C2 Display Station <b>3197D1</b> 3197-D1 Display Station <b>3197D2</b> 3197-D2 Display Station <b>3197W1</b> 3197-W1 Display Station <b>3197W2</b> 3197-W2 Display Station <b>3270</b> 3270 Display Station	

Table 29. Get attributes (continued)

Offset	Data type	Length	Contents	File type
			<b>3476EA</b> 3476-EA Display Station	
			<b>3476EC</b> 3476-EC Display Station	
			<b>3477FA</b> 3477-FA Display Station	
			<b>3477FC</b> 3477-FC Display Station	
			<b>3477FD</b> 3477-FD Display Station	
			<b>3477FE</b> 3477-FE Display Station	
			<b>3477FG</b> 3477-FG Display Station	
			<b>3477FW</b> 3477-FW Display Station	
			<b>525111</b> 5251 Display Station	
			<b>5291</b> 5291 Display Station	
			<b>5292</b> 5292 Display Station	
			<b>529202</b> 5292-2 Display Station	
			<b>5555B1</b> 5555-B01 Display Station	Display, ICF
			<b>5555C1</b> 5555-C01 Display Station	
			<b>5555E1</b> 5555-E01 Display Station	
			<b>5555F1</b> 5555-F01 Display Station	
			<b>5555G1</b> 5555-G01 Display Station	
			<b>5555G2</b> 5555-G02 Display Station	
			<b>DHCF77</b> 3277 DHCF device	
			<b>DHCF78</b> 3278 DHCF device	
			<b>DHCF79</b> 3279 DHCF device	

Table 29. Get attributes (continued)

Offset	Data type	Length	Contents	File type
			<b>3486BA</b> 3486-BA Display Station <b>3487HA</b> 3487-HA Display Station <b>3487HC</b> 3487-HC Display Station <b>3487HG</b> 3487-HG Display Station <b>3487HW</b> 3487-HW Display Station <b>APPC</b> Advance program-to-program communications device <b>ASYNC</b> Asynchronous communications device <b>BSC</b> Bisynchronous communications device <b>BSCSEL</b> BSCSEL communications device <b>FINANC</b> ICF Finance communications device <b>INTRA</b> Intrasystem communications device <b>LU1</b> LU1 communications device <b>RETAIL</b> RETAIL communications device <b>SNUF</b> SNA upline facility communications device	Display, ICF
37	Character	1	Requester device. This flag indicates whether this entry is defining a *REQUESTER device. <b>N</b> Not a *REQUESTER device (communications source device). <b>Y</b> A *REQUESTER device (communications target device).	Display, ICF
38	Character	1	Acquire status. Set even if device is implicitly acquired at open time. <b>N</b> Device is not acquired. <b>Y</b> Device is acquired.	Display, ICF

Table 29. Get attributes (continued)

Offset	Data type	Length	Contents	File type
39	Character	1	Invite status. <b>Y</b> Device is invited. <b>N</b> Device is not invited.	Display, ICF
40	Character	1	Data available. <b>Y</b> Invited data is available. <b>N</b> Invited data is not available.	Display, ICF
41	Binary	2	Number of rows on display.	Display
43	Binary	2	Number of columns on display.	Display
45	Character	1	Display allow blink. <b>Y</b> Display is capable of blinking. <b>N</b> Display is not capable of blinking.	Display
46	Character	1	Online/offline status. <b>O</b> Display is online. <b>F</b> Display is offline.	Display
47	Character	1	Display location. <b>L</b> Local display. <b>R</b> Remote display.	Display
48	Character	1	Display type. <b>A</b> Alphanumeric or Katakana. <b>I</b> DBCS. <b>G</b> Graphic DBCS.	Display
49	Character	1	Keyboard type of display. <b>A</b> Alphanumeric or Katakana keyboard. <b>I</b> DBCS keyboard.	Display

Table 29. Get attributes (continued)

Offset	Data type	Length	Contents	File type
50	Character	1	Transaction status. All communication types. <b>N</b> Transaction is not started. An evoke request has not been sent, a detach request has been sent or received, or the transaction has completed. <b>Y</b> Transaction is started. The transaction is active. An evoke request has been sent or received and the transaction has not ended.	ICF
51	Character	1	Synchronization level. APPC and INTRA. <b>0</b> Synchronization level 0 (SYNLVL(*NONE)). <b>1</b> Synchronization level 1 (SYNLVL(*CONFIRM)). <b>2</b> Synchronization level 2 (SYNLVL(*COMMIT)).	ICF
52	Character	1	Conversation being used. APPC only. <b>M</b> Mapped conversation. <b>B</b> Basic conversation.	ICF
53	Character	8	Remote location name. All communication types.	ICF
61	Character	8	Local LU name. APPC only.	ICF
69	Character	8	Local network ID. APPC only.	ICF
77	Character	8	Remote LU name. APPC only.	ICF
85	Character	8	Remote network ID. APPC only.	ICF
93	Character	8	Mode. APPC only.	ICF
101	Character	1	Controller information. <b>N</b> Display is not attached to a controller that supports an enhanced interface for nonprogrammable workstations. <b>1</b> Display is attached to a controller (type 1) that supports an enhanced interface for nonprogrammable workstations. See note. <b>2</b> Display is attached to a controller (type 2) that supports an enhanced interface for nonprogrammable workstations. See note. <b>3</b> Display is attached to a controller (type 3) that supports an enhanced interface for nonprogrammable workstations. See note.	Display



Table 29. Get attributes (continued)

Offset	Data type	Length	Contents	File type
102	Character	1	Color capability of display. <b>Y</b> Color display <b>N</b> Monochrome display	Display
103	Character	1	Grid line support by display. <b>Y</b> Display supports grid lines <b>N</b> Display does not support grid lines	Display
104	Character	1	<b>hex 00</b> Reset state <b>hex 01</b> Send state <b>hex 02</b> Defer received state <b>hex 03</b> Defer deallocate state <b>hex 04</b> Receive state <b>hex 05</b> Confirm state <b>hex 06</b> Confirm send state <b>hex 07</b> Confirm deallocate state <b>hex 08</b> Commit state <b>hex 09</b> Commit send state <b>hex 0A</b> Commit deallocate state <b>hex 0B</b> Deallocate state <b>hex 0C</b> Rollback required state	ICF
105	Character	8	LU.6 Conversation Correlator	ICF
113	Character	31	Reserved	Display, ICF

**Note:** The following information is provided only for an Integrated Service Digital Network (ISDN) used in the ICF or remote display session. Also, not all of the information will be available if the area to receive it is too small.

Table 29. Get attributes (continued)

Offset	Data type	Length	Contents	File type
144	Binary	2	ISDN remote number length in bytes. Consists of the total of the lengths of the next three fields: ISDN remote numbering type, ISDN remote numbering plan, and the ISDN remote number. If the ISDN remote number has been padded on the right with blanks, the length of that padding is not included in this total. :p If ISDN is not used, this field contains 0.	Display, ICF
146	Character	2	ISDN remote numbering type (decimal). <b>00</b> Unknown. <b>01</b> International. <b>02</b> National. <b>03</b> Network-specific. <b>04</b> Subscriber. <b>06</b> Abbreviated.	Display, ICF
148	Character	2	ISDN remote numbering plan (decimal). <b>00</b> Unknown. <b>01</b> ISDN/Telephony. <b>03</b> Data. <b>04</b> Telex**. <b>08</b> National Standard. <b>09</b> Private.	Display, ICF
150	Character	40	The ISDN remote number in EBCDIC, padded on the right with blanks if necessary to fill the field.	Display, ICF
190	Character	4	Reserved.	Display, ICF
194	Binary	2	ISDN remote subaddress length in bytes. Consists of the total of the lengths of the next two fields: ISDN remote subaddress type and the ISDN remote subaddress. If the ISDN remote subaddress has been padded on the right with blanks, the length of that padding is not included in this total. If ISDN is not used, this field contains 0.	Display, ICF

Table 29. Get attributes (continued)

Offset	Data type	Length	Contents	File type
196	Character	2	ISDN remote subaddress type (decimal). <b>00</b> NSAP. <b>01</b> User-specified.	Display, ICF
198	Character	40	ISDN remote subaddress (EBCDIC representation of the original hexadecimal value, padded on the right with zeros).	Display, ICF
238	Character	1	Reserved.	Display, ICF
239	Character	1	ISDN connection (decimal). <b>0</b> Incoming ISDN call. <b>1</b> Outgoing ISDN call. <b>Other</b> Non-ISDN connection.	Display, ICF
240	Binary	2	ISDN remote network address length in bytes. If the ISDN remote network address has been padded on the right with blanks, the length of that padding is not included.  If ISDN is not used, this field contains 0.	Display, ICF
242	Character	32	The ISDN remote network address in EBCDIC, padded on the right with blanks, if necessary, to fill the field.	Display, ICF
274	Character	4	Reserved.	Display, ICF
278	Character	2	ISDN remote address extension length in bytes. Consists of the total of the lengths of the next two fields: ISDN remote address extension type and the ISDN remote address extension. If the ISDN remote address extension has been padded on the right with zeros, the length of that padding is not included.  If ISDN is not used or there is no ISDN remote address extension, this field contains 0.	Display, ICF
280	Character	1	ISDN remote address extension type (decimal). <b>0</b> Address assigned according to ISO 8348/AD2 <b>2</b> Address not assigned according to ISO 8348/AD2 <b>Other</b> Reserved.	Display, ICF
281	Character	40	ISDN remote address extension (EBCDIC representation of the original hexadecimal value, padded on the right with zeros).	Display, ICF
321	Character	4	Reserved.	Display, ICF

Table 29. Get attributes (continued)

Offset	Data type	Length	Contents	File type
325	Character	1	X.25 call type (decimal). <b>0</b> Incoming Switched Virtual Circuit (SVC) <b>1</b> Outgoing SVC <b>2</b> Not X.25 SVC <b>Other</b> Reserved.	Display, ICF
326	Character	64	Transaction program name. Name of the program specified to be started as a result of the received program start request, even if a routing list caused a different program to be started.	ICF
390	Binary	1	Length of the protected LUWID field. The valid values are 0 through 26.	ICF
391	Binary	1	Length of the qualified LU-NAME. The valid values are 0 through 17.	ICF
392	Character	17	Network qualified protected LU-NAME in the form: netid.luname. This field is blank if there is no network qualified protected LU-NAME.	ICF
409	Character	6	Protected LUWID instance number.	ICF
415	Binary	2	Protected LUWID sequence number.	ICF
<b>Note:</b> The following information is available only when a protected conversation is started on the remote system; that is, when a conversation is started with an SYNCLVL value of *COMMIT. Also, not all of the information will be available if the area to receive it is too small.				
417	Binary	1	Length of the unprotected LUWID field. The valid values are 0 through 26.	ICF
418	Binary	1	Length of the qualified LU-NAME. The valid values are 0 through 17.	ICF
419	Character	17	Network qualified unprotected LU-NAME in the form: netid.luname. This field is blank if there is no network qualified unprotected LU-NAME.	ICF
436	Character	6	Unprotected LUWID instance number.	ICF
442	Binary	2	Unprotected LUWID sequence number.	ICF

---

Table 29. Get attributes (continued)

---

Offset	Data type	Length	Contents	File type
<b>Note:</b>				
<b>Type 1</b> Controllers available at V2R2, which support such things as the Windows operating system and continued cursor progression.				
<b>Type 2</b> Controllers available at V2R3. These support all of the V2R2 functions as well as menu bars, continued-entry fields, edit masks, and simple hotspots.				
<b>Type 3</b> Controllers available at V3R1. These support all of the V2R2 and V2R3 functions. They also support text in the bottom border of the Windows operating system.				

---

## Related information for Database file management

---

Product manuals, Web sites, and other information center topic collections contain information that relates to the Database file management topic collection. You can view or print any of the PDF files.

### Planning, installation, and migration

- [i5/OS globalization](#) provides information that is required to understand and use the national language support function on the IBM i operating system to the following audience:
  - Data processing manager
  - System operator and manager
  - Application programmer
  - End user
  - IBM marketing representative
  - System engineer

This topic prepares the user for planning, installing, configuring, and using national language support (NLS) and multilingual support. It also provides an explanation of the database management of multilingual data and application considerations for a multilingual system.

- [Local Device Configuration, SC41-5121](#),  provides the system operator or system administrator with information about how to do an initial local hardware configuration and how to change that configuration. It also contains conceptual information for device configuration, and planning information for device configuration on the 9406, 9404, and 9402 system units.

### Application development

- **ADTS/400: Character Generator Utility** provides the application programmer or system programmer with information about using the Application Development Tools character generator utility (CGU) to create and maintain a double-byte character set (DBCS) on the system.

### System management

- [Backup and recovery](#) provides the system programmer with information to plan a backup and recovery strategy. Also included are procedures to implement your backup and recovery strategy, how to recover from disk unit failures, and how to recover from a site loss.
- [Work management](#) provides information about how to create and change a work management environment.

- [Security reference](#) provides the system programmer with information about planning, designing, and auditing security. It includes information about security system values, user profiles, and resource security.

## Communications and connectivity

- [ICF programming](#), SC41-5442,  provides the application programmer with the information needed to write application programs that use System i communications and ICF files. It also contains information about data description specifications (DDS) keywords, system-supplied formats, return codes, file transfer support, and programming examples.

## Program enablers

- [Application display programming](#), SC41-5715,  provides information about creating and maintaining screens for applications, creating online help information, and working with display files on the IBM i operating system.
- [CL programming](#) provides a wide-ranging discussion of programming topics, including a general discussion of objects and libraries, control language (CL) programming, controlling flow and communicating between programs, working with objects in CL programs, and creating CL programs. Other topics include predefined and immediate messages and message handling, defining and creating user-defined commands and menus, and application testing, including debug mode, breakpoints, traces, and display functions.
- [Control language](#) provides a description of the control language (CL) and its commands. Each command is defined including its syntax diagram, parameters, default values, and keywords.
- [Database programming](#) provides the application programmer or system programmer with a detailed discussion of the IBM i database organization, including information about how to create, describe, and manipulate database files on the system.
- [DDS concepts](#) provides the application programmer with detailed descriptions of the entries and keywords needed to describe database files (both logical and physical) and certain device files (for displays, printers, and ICF) external to the user's programs.
- [Printing](#) provides information about how to understand and control printing: printing elements and concepts, printer file support, print spooling support, printer connectivity, advanced function printing, and printing with personal computers.
- [Tape files](#) provides information about creating and maintaining tape device files.

## System management

- [Distributed database programming](#) provides the application programmer or system programmer with information about remote file processing. It describes how to define a remote file to IBM i distributed data management (DDM), how to create a DDM file, which file utilities are supported through DDM, and the requirements of IBM i DDM as related to other systems.

### Related reference

PDF file for Database file management

You can view and print a PDF file of this information.

## Code license and disclaimer information

---

IBM grants you a nonexclusive copyright license to use all programming code examples from which you can generate similar function tailored to your own specific needs.

SUBJECT TO ANY STATUTORY WARRANTIES WHICH CANNOT BE EXCLUDED, IBM, ITS PROGRAM DEVELOPERS AND SUPPLIERS MAKE NO WARRANTIES OR CONDITIONS EITHER EXPRESS OR IMPLIED, INCLUDING BUT NOT LIMITED TO, THE IMPLIED WARRANTIES OR CONDITIONS OF MERCHANTABILITY,

FITNESS FOR A PARTICULAR PURPOSE, AND NON-INFRINGEMENT, REGARDING THE PROGRAM OR TECHNICAL SUPPORT, IF ANY.

UNDER NO CIRCUMSTANCES IS IBM, ITS PROGRAM DEVELOPERS OR SUPPLIERS LIABLE FOR ANY OF THE FOLLOWING, EVEN IF INFORMED OF THEIR POSSIBILITY:

1. LOSS OF, OR DAMAGE TO, DATA;
2. DIRECT, SPECIAL, INCIDENTAL, OR INDIRECT DAMAGES, OR FOR ANY ECONOMIC CONSEQUENTIAL DAMAGES; OR
3. LOST PROFITS, BUSINESS, REVENUE, GOODWILL, OR ANTICIPATED SAVINGS.

SOME JURISDICTIONS DO NOT ALLOW THE EXCLUSION OR LIMITATION OF DIRECT, INCIDENTAL, OR CONSEQUENTIAL DAMAGES, SO SOME OR ALL OF THE ABOVE LIMITATIONS OR EXCLUSIONS MAY NOT APPLY TO YOU.





## Notices

---

This information was developed for products and services offered in the U.S.A.

IBM may not offer the products, services, or features discussed in this document in other countries. Consult your local IBM representative for information on the products and services currently available in your area. Any reference to an IBM product, program, or service is not intended to state or imply that only that IBM product, program, or service may be used. Any functionally equivalent product, program, or service that does not infringe any IBM intellectual property right may be used instead. However, it is the user's responsibility to evaluate and verify the operation of any non-IBM product, program, or service.

IBM may have patents or pending patent applications covering subject matter described in this document. The furnishing of this document does not grant you any license to these patents. You can send license inquiries, in writing, to:

IBM Director of Licensing  
IBM Corporation  
North Castle Drive  
Armonk, NY 10504-1785  
U.S.A.

For license inquiries regarding double-byte (DBCS) information, contact the IBM Intellectual Property Department in your country or send inquiries, in writing, to:

Intellectual Property Licensing  
Legal and Intellectual Property Law  
IBM Japan Ltd.  
1623-14, Shimotsuruma, Yamato-shi  
Kanagawa 242-8502 Japan

The following paragraph does not apply to the United Kingdom or any other country where such provisions are inconsistent with local law: INTERNATIONAL BUSINESS MACHINES CORPORATION PROVIDES THIS PUBLICATION "AS IS" WITHOUT WARRANTY OF ANY KIND, EITHER EXPRESS OR IMPLIED, INCLUDING, BUT NOT LIMITED TO, THE IMPLIED WARRANTIES OF NON-INFRINGEMENT, MERCHANTABILITY OR FITNESS FOR A PARTICULAR PURPOSE. Some states do not allow disclaimer of express or implied warranties in certain transactions, therefore, this statement may not apply to you.

This information could include technical inaccuracies or typographical errors. Changes are periodically made to the information herein; these changes will be incorporated in new editions of the publication. IBM may make improvements and/or changes in the product(s) and/or the program(s) described in this publication at any time without notice.

Any references in this information to non-IBM Web sites are provided for convenience only and do not in any manner serve as an endorsement of those Web sites. The materials at those Web sites are not part of the materials for this IBM product and use of those Web sites is at your own risk.

IBM may use or distribute any of the information you supply in any way it believes appropriate without incurring any obligation to you.

Licensees of this program who wish to have information about it for the purpose of enabling: (i) the exchange of information between independently created programs and other programs (including this one) and (ii) the mutual use of the information which has been exchanged, should contact:

IBM Corporation  
Software Interoperability Coordinator, Department YBWA  
3605 Highway 52 N  
Rochester, MN 55901  
U.S.A.

Such information may be available, subject to appropriate terms and conditions, including in some cases, payment of a fee.

The licensed program described in this document and all licensed material available for it are provided by IBM under terms of the IBM Customer Agreement, IBM International Program License Agreement or any equivalent agreement between us.

Any performance data contained herein was determined in a controlled environment. Therefore, the results obtained in other operating environments may vary significantly. Some measurements may have been made on development-level systems and there is no guarantee that these measurements will be the same on generally available systems. Furthermore, some measurements may have been estimated through extrapolation. Actual results may vary. Users of this document should verify the applicable data for their specific environment.

Information concerning non-IBM products was obtained from the suppliers of those products, their published announcements or other publicly available sources. IBM has not tested those products and cannot confirm the accuracy of performance, compatibility or any other claims related to non-IBM products. Questions on the capabilities of non-IBM products should be addressed to the suppliers of those products.

All statements regarding IBM's future direction or intent are subject to change or withdrawal without notice, and represent goals and objectives only.

This information is for planning purposes only. The information herein is subject to change before the products described become available.

This information contains examples of data and reports used in daily business operations. To illustrate them as completely as possible, the examples include the names of individuals, companies, brands, and products. All of these names are fictitious and any similarity to the names and addresses used by an actual business enterprise is entirely coincidental.

#### COPYRIGHT LICENSE:

This information contains sample application programs in source language, which illustrate programming techniques on various operating platforms. You may copy, modify, and distribute these sample programs in any form without payment to IBM, for the purposes of developing, using, marketing or distributing application programs conforming to the application programming interface for the operating platform for which the sample programs are written. These examples have not been thoroughly tested under all conditions. IBM, therefore, cannot guarantee or imply reliability, serviceability, or function of these programs. The sample programs are provided "AS IS", without warranty of any kind. IBM shall not be liable for any damages arising out of your use of the sample programs.

Each copy or any portion of these sample programs or any derivative work, must include a copyright notice as follows:

© (your company name) (year). Portions of this code are derived from IBM Corp. Sample Programs.

© Copyright IBM Corp. \_enter the year or years\_.

If you are viewing this information softcopy, the photographs and color illustrations may not appear.

## Programming interface information

---

This Database file management publication documents intended Programming Interfaces that allow the customer to write programs to obtain the services of IBM i.

## Trademarks

---

IBM, the IBM logo, and [ibm.com](http://www.ibm.com) are trademarks or registered trademarks of International Business Machines Corp., registered in many jurisdictions worldwide. Other product and service names might be trademarks of IBM or other companies. A current list of IBM trademarks is available on the Web at "[Copyright and trademark information](http://www.ibm.com/legal/copytrade.shtml)" at [www.ibm.com/legal/copytrade.shtml](http://www.ibm.com/legal/copytrade.shtml).

Adobe, the Adobe logo, PostScript, and the PostScript logo are either registered trademarks or trademarks of Adobe Systems Incorporated in the United States, and/or other countries.

Microsoft, Windows, Windows NT, and the Windows logo are trademarks of Microsoft Corporation in the United States, other countries, or both.

Other product and service names might be trademarks of IBM or other companies.

## Terms and conditions

---

Permissions for the use of these publications is granted subject to the following terms and conditions.

**Personal Use:** You may reproduce these publications for your personal, noncommercial use provided that all proprietary notices are preserved. You may not distribute, display or make derivative works of these publications, or any portion thereof, without the express consent of IBM.

**Commercial Use:** You may reproduce, distribute and display these publications solely within your enterprise provided that all proprietary notices are preserved. You may not make derivative works of these publications, or reproduce, distribute or display these publications or any portion thereof outside your enterprise, without the express consent of IBM.

Except as expressly granted in this permission, no other permissions, licenses or rights are granted, either express or implied, to the publications or any information, data, software or other intellectual property contained therein.

IBM reserves the right to withdraw the permissions granted herein whenever, in its discretion, the use of the publications is detrimental to its interest or, as determined by IBM, the above instructions are not being properly followed.

You may not download, export or re-export this information except in full compliance with all applicable laws and regulations, including all United States export laws and regulations.

IBM MAKES NO GUARANTEE ABOUT THE CONTENT OF THESE PUBLICATIONS. THE PUBLICATIONS ARE PROVIDED "AS-IS" AND WITHOUT WARRANTY OF ANY KIND, EITHER EXPRESSED OR IMPLIED, INCLUDING BUT NOT LIMITED TO IMPLIED WARRANTIES OF MERCHANTABILITY, NON-INFRINGEMENT, AND FITNESS FOR A PARTICULAR PURPOSE.







Product Number: 5770-SS1