

IBM z/OS Debugger
16.0.4

Reference Summary



Note!

Before using this information and the product it supports, be sure to read the general information under [“Notices” on page 77](#).

Fourth Edition (October 2023)

This edition applies to IBM® z/OS® Debugger, 16.0.4 (Program Number 5724-T07 with the PTF for PH57538), which supports the following compilers:

- Open Enterprise SDK for Go 1.21 and 1.22 (Program Number 5655-GOZ)
- Open XL C/C++ for z/OS 1.1 (Program Number 5650-ZOS)
- z/OS XL C/C++ Version 2 (Program Number 5650-ZOS)
- C/C++ feature of z/OS Version 1 (Program Number 5694-A01)
- C/C++ feature of OS/390® (Program Number 5647-A01)
- C/C++ for MVS/ESA Version 3 (Program Number 5655-121)
- AD/Cycle C/370 Version 1 Release 2 (Program Number 5688-216)
- Enterprise COBOL for z/OS 6.1, 6.2, 6.3, and 6.4 (Program Number 5655-EC6)
- Enterprise COBOL for z/OS Version 5 (Program Number 5655-W32)
- Enterprise COBOL for z/OS Version 4 (Program Number 5655-S71)
- Enterprise COBOL for z/OS and OS/390 Version 3 (Program Number 5655-G53)
- COBOL for OS/390 & VM Version 2 (Program Number 5648-A25)
- COBOL for MVS™ & VM Version 1 Release 2 (Program Number 5688-197)
- COBOL/370 Version 1 Release 1 (Program Number 5688-197)
- VS COBOL II Version 1 Release 3 and Version 1 Release 4 (Program Numbers 5668-958, 5688-023) - with limitations
- OS/VS COBOL, Version 1 Release 2.4 (5740-CB1) - with limitations
- High Level Assembler for MVS & VM & VSE Version 1 Release 4, Version 1 Release 5, Version 1 Release 6 (Program Number 5696-234)
- Enterprise PL/I for z/OS 6.1 (Program Number 5655-PL6)
- Enterprise PL/I for z/OS Version 5 Release 1, Release 2, and Release 3 (Program Number 5655-PL5)
- Enterprise PL/I for z/OS Version 4 (Program Number 5655-W67)
- Enterprise PL/I for z/OS and OS/390 Version 3 (Program Number 5655-H31)
- VisualAge® PL/I for OS/390 Version 2 Release 2 (Program Number 5655-B22)
- PL/I for MVS & VM Version 1 Release 1 (Program Number 5688-235)
- OS PL/I Version 2 Release 1, Version 2 Release 2, Version 2 Release 3 (Program Numbers 5668-909, 5668-910) - with limitations

This edition also applies to all subsequent releases and modifications until otherwise indicated in new editions or technical newsletters.

You can find out more about IBM z/OS Debugger by visiting the following IBM Web sites:

- IBM Debug for z/OS: <https://www.ibm.com/products/debug-for-zos>
- IBM Developer for z/OS: <https://www.ibm.com/products/developer-for-zos>
- IBM Z and Cloud Modernization Stack: <https://www.ibm.com/docs/z-modernization-stack>

© **Copyright International Business Machines Corporation 1992, 2024.**

US Government Users Restricted Rights – Use, duplication or disclosure restricted by GSA ADP Schedule Contract with IBM Corp.

Contents

About this document.....	ix
Who might use this document.....	ix
Accessing z/OS licensed documents on the Internet.....	ix
How to read syntax diagrams.....	x
Symbols.....	x
Syntax items.....	x
Syntax examples.....	xi
How to provide your comments.....	xii
What's new in IBM z/OS Debugger.....	xiii
What's removed from IBM z/OS Debugger.....	xviii
Overview of IBM z/OS Debugger.....	xxi
Chapter 1. z/OS Debugger commands.....	1
? command.....	1
ALLOCATE command.....	1
ANALYZE command (PL/I).....	1
Assignment command (assembler and disassembly).....	1
Assignment command (LangX COBOL).....	1
Assignment command (PL/I).....	2
AT ALLOCATE (PL/I).....	2
AT APPEARANCE.....	2
AT CALL.....	2
AT CHANGE.....	2
AT CHANGE (remote).....	3
AT CURSOR (full-screen mode).....	3
AT DATE (COBOL).....	3
AT DELETE.....	3
AT ENTRY.....	4
AT ENTRY (remote).....	4
AT EXIT.....	4
AT GLOBAL.....	4
AT GLOBAL LABEL (remote).....	5
AT LABEL.....	5
AT LABEL (remote).....	5
AT LINE.....	6
AT LOAD.....	6
AT LOAD (remote).....	6
AT OCCURRENCE.....	6
AT OFFSET (disassembly).....	6
AT PATH.....	7
AT Prefix (full-screen mode).....	7
AT STATEMENT.....	7
AT STATEMENT (remote).....	7
AT TERMINATION.....	7
BEGIN command (programming language neutral).....	7
block command (C and C++).....	8
break command (C and C++).....	8
CALL %CEBR.....	8

CALL %CECI.....	8
CALL %DUMP.....	8
CALL %FA.....	8
CALL %FM.....	8
CALL %HOGAN.....	9
CALL %VER.....	9
CALL entry_name (COBOL).....	9
CALL procedure.....	9
CC command.....	9
CHKSTGV.....	9
CLEAR command.....	10
CLEAR AT (remote).....	11
CLEAR prefix (full-screen mode).....	12
COMMENT command.....	12
COMPUTE command (COBOL).....	12
CURSOR command (full-screen mode).....	12
Declarations (assembler, disassembly, and LangX COBOL).....	12
Declarations (C and C++).....	13
Declarations (COBOL).....	15
DECLARE command (PL/I).....	15
DESCRIBE command.....	16
DISABLE command.....	17
DISABLE prefix (full-screen mode).....	18
DO command (assembler, disassembly, LangX COBOL, and COBOL).....	18
DO command (PL/I).....	18
do/while command (C and C++).....	19
ENABLE command.....	19
ENABLE prefix (full-screen mode).....	19
EVALUATE command (COBOL).....	20
Expression command (C and C++).....	20
FIND command.....	20
FINDBP command.....	21
for command (C and C++).....	21
FREE command.....	21
GO command.....	21
GOTO command.....	21
GOTO LABEL command.....	21
%IF command (programming language neutral).....	22
IF command (assembler, disassembly, and LangX COBOL).....	22
if command (C and C++).....	22
IF command (COBOL).....	22
IF command (PL/I).....	22
IMMEDIATE command (full-screen mode).....	22
INPUT command (C and C++ and COBOL).....	22
JUMPTO command.....	23
JUMPTO LABEL command.....	23
LIST (blank).....	23
LIST AT.....	23
LIST AT (remote).....	24
LIST CALLS.....	25
LIST CC command.....	25
LIST CONTAINER.....	25
LIST CURSOR (full-screen mode).....	25
LIST DTCN.....	25
LIST expression.....	25
L expression prefix.....	26
LIST FREQUENCY.....	26
LIST LAST.....	26

LIST LDD.....	27
LIST LINE NUMBERS.....	27
LIST LINES.....	27
LIST MONITOR.....	27
LIST NAMES.....	27
LIST NAMES LABELS (remote).....	27
LIST ON (PL/I).....	28
LIST PROCEDURES.....	28
LIST REGISTERS.....	28
LIST STATEMENT NUMBERS.....	28
LIST STATEMENTS.....	28
LIST STORAGE.....	28
LIST TRACE LOAD command.....	29
LOAD command.....	29
LOADDEBUGDATA (LDD).....	29
MEMORY.....	30
M prefix command.....	30
MONITOR command.....	30
MOVE command (COBOL).....	30
NAMES DISPLAY command.....	31
NAMES EXCLUDE command.....	31
NAMES INCLUDE command.....	31
Null command.....	31
ON command (PL/I).....	32
PANEL command (full-screen mode).....	32
PERFORM command (COBOL).....	32
PLAYBACK BACKWARD command.....	33
PLAYBACK DISABLE command.....	33
PLAYBACK ENABLE command.....	33
PLAYBACK FORWARD command.....	34
PLAYBACK START command.....	34
PLAYBACK STOP command.....	34
POPOP command.....	34
POSITION command.....	34
Prefix commands (full-screen mode).....	34
PROCEDURE command.....	35
QUALIFY RESET.....	35
QUERY command.....	35
QUERY prefix (full-screen mode).....	38
QUIT command.....	38
QQUIT command.....	38
RESTORE command.....	38
RETRIEVE command (full-screen mode).....	38
RUN command.....	38
RUNTO command.....	38
RUNTO prefix command (full-screen mode).....	39
SCROLL command (full-screen mode).....	39
SELECT command (PL/I).....	39
SET ASSEMBLER ON/OFF.....	39
SET ASSEMBLER STEPOVER.....	40
SET AUTOMONITOR.....	40
SET CHANGE.....	40
SET COLOR (full-screen and line mode).....	40
SET COUNTRY.....	41
SET DBCS.....	41
SET DEFAULT DBG.....	41
SET DEFAULT LISTINGS.....	42
SET DEFAULT MDBG.....	42

SET DEFAULT SCROLL (full-screen mode).....	42
SET DEFAULT VIEW.....	42
SET DEFAULT WINDOW (full-screen mode).....	43
SET DISASSEMBLY.....	43
SET DYNDEBUG.....	43
SET ECHO.....	43
SET EQUATE.....	43
SET EXECUTE.....	43
SET EXPLICITDEBUG.....	44
SET FIND BOUNDS.....	44
SET FREQUENCY.....	44
SET HISTORY.....	44
SET IGNORELINK.....	44
SET INTERCEPT (C and C++).....	44
SET INTERCEPT (COBOL, full-screen mode, line mode, batch mode).....	45
SET INTERCEPT (COBOL, remote debug mode).....	45
SET KEYS (full-screen and line mode).....	45
SET LDD.....	45
SET LIST BY SUBSCRIPT command (COBOL).....	45
SET LIST BY SUBSCRIPT command (Enterprise PL/I, full-screen mode only).....	45
SET LIST TABULAR.....	46
SET LOG.....	46
SET LOG NUMBERS (full-screen and line mode).....	46
SET LONGCUNAME (C, C++, and PL/I).....	46
SET MDBG (C, C++).....	46
SET MONITOR (full-screen and line mode).....	46
SET MSGID.....	47
SET NATIONAL LANGUAGE.....	47
SET PACE.....	47
SET PFKEY.....	47
SET POPUP.....	47
SET PROGRAMMING LANGUAGE.....	47
SET PROMPT (full-screen and line mode).....	48
SET QUALIFY.....	48
SET REFRESH (full-screen mode).....	48
SET RESTORE.....	48
SET REWRITE (full-screen mode).....	49
SET REWRITE (remote debug mode).....	49
SET SAVE.....	49
SET SCREEN (full-screen and line mode).....	49
SET SCROLL DISPLAY (full-screen mode).....	50
SET SEQUENCE (PL/I).....	50
SET SOURCE.....	50
SET SUFFIX (full-screen mode).....	50
SET TEST.....	50
SET WARNING (C, C++, and PL/I).....	50
SET command (COBOL).....	51
SHOW prefix command (full-screen mode).....	51
STEP command.....	51
STORAGE command.....	51
switch command (C and C++).....	51
SYSTEM command.....	52
TRACE command.....	52
TRIGGER command.....	52
TSO command (z/OS).....	54
USE command.....	54
while command (C and C++).....	54
WINDOW CLOSE.....	54

WINDOW OPEN.....	54
WINDOW SIZE.....	54
WINDOW SWAP.....	55
WINDOW ZOOM.....	55
Chapter 2. z/OS Debugger built-in functions.....	57
%CHAR (assembler, disassembly, and LangX COBOL).....	57
%DEC (assembler, disassembly, and LangX COBOL).....	57
%GENERATION (PL/I).....	57
%HEX.....	57
%INSTANCES (C, C++, and PL/I).....	57
%RECURSION (C, C++, and PL/I).....	57
%WHERE (assembler, disassembly, and LangX COBOL).....	57
Chapter 3. EQAOPTS commands (optional).....	59
ALTDISP.....	61
BROWSE.....	61
CACHENUM.....	61
CCOUTPUTDSN.....	62
CCOUTPUTDSNALLOC.....	62
CCPROGSELECTDSN.....	62
CEEREAFTERAFTERQDBG.....	62
CICSASMPGMND.....	62
CODEPAGE.....	62
COMMANDSDSN.....	62
DEFAULTVIEW.....	62
DISABLERLIM.....	62
DLAYDBG.....	62
DLAYDBGEND.....	63
DLAYDBGDSN.....	63
DLAYDBGTRC.....	63
DLAYDBGXRF.....	63
DTCNDELETEDEADPROF.....	63
DTCNFORCExxxx.....	63
DYNDEBUG.....	63
EQAQPP.....	63
EXPLICITDEBUG.....	64
GPFDSN.....	64
HOSTPORTS.....	64
IGNOREODOLIMIT.....	64
IMISOORIGPSB.....	64
LOGDSN.....	64
LOGDSNALLOC.....	64
MAXTRANUSER.....	64
MDBG.....	64
MULTIPROCESS.....	64
NAMES.....	65
NODISPLAY.....	65
PREFERENCEDSN.....	65
SAVEBPDSN and SAVESETDSN.....	65
SAVEBPDSNALLOC and SAVESETDSNALLOC.....	65
SESSIONTIMEOUT.....	65
STARTSTOPMSG.....	65
STARTSTOPMSGDSN.....	65
SUBSYS.....	65
SVCSCREEN.....	65
TCPIPDATA.....	65

THREADTERMCOND.....	66
TIMACB.....	66
END.....	66
Chapter 4. z/OS Debugger variables.....	67
Chapter 5. Reference card: Frequently used z/OS Debugger commands.....	69
Chapter 6. Reference card: Frequently used z/OS Debugger commands while debugging assembler programs.....	73
Notices.....	77
Copyright license.....	77
Privacy policy considerations.....	78
Programming interface information.....	78
Trademarks and service marks.....	78

About this document

z/OS Debugger combines the richness of the z/OS environment with the power of Language Environment® to provide a debugger for programmers to isolate and fix their program bugs and test their applications. z/OS Debugger gives you the capability of testing programs in batch, using a nonprogrammable terminal in full-screen mode, or using a workstation interface to remotely debug your programs.

This document contains a summary of commands, built-in functions, and EQAOPTS commands provided by z/OS Debugger. Each topic contains the name of the command, built-in function, or EQAOPTS command and then a syntax diagram. For more information about each command or built-in function, refer to the *IBM z/OS Debugger Reference and Messages*. For more information about each EQAOPTS command, see the *IBM z/OS Debugger Customization Guide* or *IBM z/OS Debugger Reference and Messages*.

Who might use this document

This document is intended for programmers using z/OS Debugger to debug high-level languages (HLLs) with Language Environment and assembler programs either with or without Language Environment. Throughout this document, the HLLs are referred to as C, C++, COBOL, and PL/I.

z/OS Debugger runs on the z/OS operating system and supports the following subsystems:

- CICS®
- Db2®
- IMS
- JES batch
- TSO
- UNIX System Services in remote debug mode or full-screen mode using the Terminal Interface Manager only

To use this document and debug a program written in one of the supported languages, you need to know how to write, compile, and run such a program.

Accessing z/OS licensed documents on the Internet

z/OS licensed documentation is available on the Internet in PDF format at the IBM Resource Link® Web site at:

<http://www.ibm.com/servers/resourceLink>

Licensed documents are available only to customers with a z/OS license. Access to these documents requires an IBM Resource Link user ID and password, and a key code. With your z/OS order you received a Memo to Licensees, (GI10-8928), that includes this key code.

To obtain your IBM Resource Link user ID and password, log on to:

<http://www.ibm.com/servers/resourceLink>

To register for access to the z/OS licensed documents:

1. Sign in to Resource Link using your Resource Link user ID and password.
2. Select **User Profiles** located on the left-hand navigation bar.

Note: You cannot access the z/OS licensed documents unless you have registered for access to them and received an e-mail confirmation informing you that your request has been processed.

Printed licensed documents are not available from IBM.

You can use the PDF format on either **z/OS Licensed Product Library CD-ROM** or IBM Resource Link to print licensed documents.

How to read syntax diagrams

This section describes how to read syntax diagrams. It defines syntax diagram symbols, items that may be contained within the diagrams (keywords, variables, delimiters, operators, fragment references, operands) and provides syntax examples that contain these items.

Syntax diagrams pictorially display the order and parts (options and arguments) that comprise a command statement. They are read from left to right and from top to bottom, following the main path of the horizontal line.

Symbols

The following symbols may be displayed in syntax diagrams:

Symbol	Definition
--------	------------

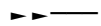

Indicates the beginning of the syntax diagram.



Indicates that the syntax diagram is continued to the next line.



Indicates that the syntax is continued from the previous line.



Indicates the end of the syntax diagram.

Syntax items

Syntax diagrams contain many different items. Syntax items include:

- Keywords - a command name or any other literal information.
- Variables - variables are italicized, appear in lowercase and represent the name of values you can supply.
- Delimiters - delimiters indicate the start or end of keywords, variables, or operators. For example, a left parenthesis is a delimiter.
- Operators - operators include add (+), subtract (-), multiply (*), divide (/), equal (=), and other mathematical operations that may need to be performed.
- Fragment references - a part of a syntax diagram, separated from the diagram to show greater detail.
- Separators - a separator separates keywords, variables or operators. For example, a comma (,) is a separator.

Keywords, variables, and operators may be displayed as required, optional, or default. Fragments, separators, and delimiters may be displayed as required or optional.

Item type	Definition
-----------	------------

Required	Required items are displayed on the main path of the horizontal line.
-----------------	---

Optional	Optional items are displayed below the main path of the horizontal line.
-----------------	--

Default	Default items are displayed above the main path of the horizontal line.
----------------	---

Syntax examples

The following table provides syntax examples.

Item	Syntax example
<p>Required item.</p> <p>Required items appear on the main path of the horizontal line. You must specify these items.</p>	
<p>Required choice.</p> <p>A required choice (two or more items) appears in a vertical stack on the main path of the horizontal line. You must choose one of the items in the stack.</p>	
<p>Optional item.</p> <p>Optional items appear below the main path of the horizontal line.</p>	
<p>Optional choice.</p> <p>An optional choice (two or more items) appears in a vertical stack below the main path of the horizontal line. You may choose one of the items in the stack.</p>	
<p>Default.</p> <p>Default items appear above the main path of the horizontal line. The remaining items (required or optional) appear on (required) or below (optional) the main path of the horizontal line. The following example displays a default with optional items.</p>	
<p>Variable.</p> <p>Variables appear in lowercase italics. They represent names or values.</p>	
<p>Repeatable item.</p> <p>An arrow returning to the left above the main path of the horizontal line indicates an item that can be repeated.</p> <p>A character within the arrow means you must separate repeated items with that character.</p> <p>An arrow returning to the left above a group of repeatable items indicates that one of the items can be selected, or a single item can be repeated.</p>	 

Table 1. Syntax examples (continued)

Item	Syntax example
<p>Fragment.</p> <p>The — fragment — symbol indicates that a labelled group is described below the main syntax diagram. Syntax is occasionally broken into fragments if the inclusion of the fragment would overly complicate the main syntax diagram.</p>	 <p>The diagram illustrates the fragment symbol and a complex choice structure. The fragment symbol is shown as a box labeled 'fragment' with a vertical line on the left and a vertical line on the right, both ending in arrowheads. Below this, the word 'fragment' is written. The main diagram shows a horizontal line with an arrowhead on the left and a double arrowhead on the right. A vertical line branches off downwards from the main line, labeled ', — required_choice2'. Another vertical line branches off upwards from the main line, labeled ', — required_choice1'. A third vertical line branches off downwards from the main line, labeled ', — optional_choice'. A fourth vertical line branches off upwards from the main line, labeled ', — default_choice'. The 'required_choice1' and 'required_choice2' lines are connected to the main line by a horizontal line. The 'optional_choice' and 'default_choice' lines are connected to the main line by a horizontal line.</p>

How to provide your comments

Your feedback is important in helping us to provide accurate, high-quality information. If you have comments about this document or any other z/OS Debugger documentation, you can leave a comment in [IBM Documentation](#):

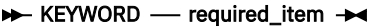
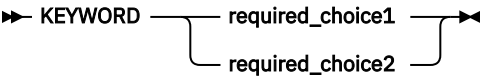
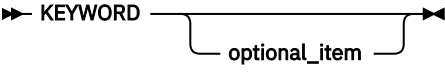
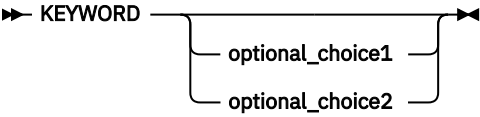
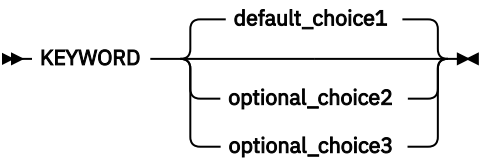
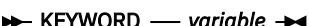
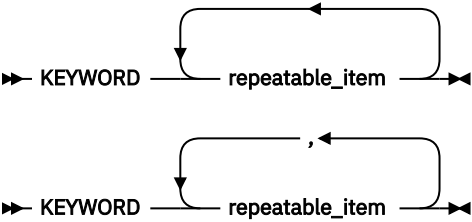
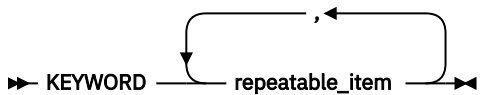
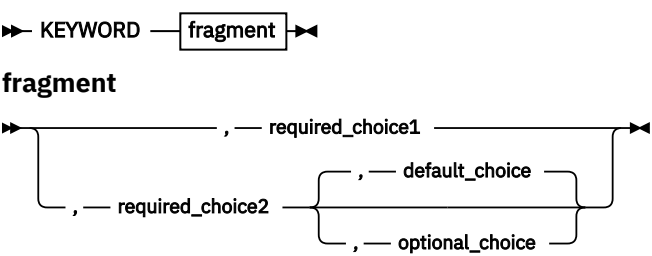
- IBM Developer for z/OS and IBM Developer for z/OS Enterprise Edition: <https://www.ibm.com/docs/developer-for-zos>
- IBM Debug for z/OS: <https://www.ibm.com/docs/debug-for-zos>
- IBM Z and Cloud Modernization Stack: <https://www.ibm.com/docs/z-modernization-stack>

When you send information to IBM, you grant IBM a nonexclusive right to use or distribute the information in any way it believes appropriate without incurring any obligation to you.

What's new in IBM z/OS Debugger

16.0.4

New support

- Support is added for IBM Open Enterprise SDK for Go 1.22.
- LangX COBOL now includes programs compiled with Enterprise COBOL for z/OS 6.

IBM Z® Open Debug 4.0

- Zowe Explorer is now the prerequisite. If it was not installed previously, when you install Z Open Debug 4.0, Zowe Explorer is installed automatically.
- Instead of installing two extensions, now you need to install only one extension: IBM Z Open Debug (zopendebug-<version>.vsix)
- Connections to the remote z/OS machine are now defined as zOpenDebug connection profiles in the Zowe team configuration file. A connection profile is created automatically based on the values you specified in Settings when you migrate to Z Open Debug 4.0. You can create multiple Zowe connection profiles to switch from one connection to another.
- The **Z Open Debug Profiles** view is now renamed as **z/OS Debugger Profiles** view and integrated into Zowe Explorer. If you installed an earlier version of the extension for IBM Z Open Debug Profiles view and have profiles in that view, when you install Z Open Debug 4.0, the profiles can be automatically migrated and the IBM Z Open Debug Profiles view will be uninstalled.
- The logging information previously available in the user's home directory is now available in the **Output** panel. Select **IBM Z Open Debug** from the list to filter out relevant log.
- You can no longer get the Debug profile Service URL from the Developer Tools window. Open a browser and visit the URL directly at: `{host_name}:{dps_port}/api/v1/profile/dtcn`.

For more information, see "Migrating from Z Open Debug v3 to v4", "Setting up for IBM Z Open Debug", and "Creating and managing debug profiles with Z Open Debug" in [IBM Documentation](#).

Debug Profile Service

- Debug Profile Service can now be used with Java 17, but IBM z/OS Liberty Embedded 23.0.0.12 or later is required.

Debug Manager

- You can now configure Debug Manager by using environment variables. For more information, see "Running Debug Manager as a started task by using environment variables" in *IBM z/OS Debugger Customization Guide*.
- You can now set the **TRUSTEDTCP** parameter to ON so that Debug Manager supports authentication of other Debug Manager instances connecting to its hub port using trusted TCP. For more information, see "Trusted TCP authentication for sysplex connections" in *IBM z/OS Debugger Customization Guide*.
- An example is added to show an overview of how an Eclipse client connects and communicates to the system in a DVIPA environment with multiple LPARs. For more information, see "Distributed Dynamic VIPA: Communication example" in *IBM z/OS Debugger Customization Guide*.

16.0.3

New support

- Support is added for z/OS 3.1.
- Support is added for IMS 15.4.
- Support is added for CICS Transaction Server for z/OS 6.2 (open beta).

- Support is added for IBM Open Enterprise SDK for Go 1.21.

Code Coverage

- In the code coverage report, you can switch to the tree view for a graphical representation of the hierarchy of files, modules, and flow points. In this tree view, you can click the name beside any node to open the source in the editor. For more information, see "Viewing coverage information in the tree view" in [IBM Documentation](#).
- You can now optimize collection to include only the modules being tested by ZUnit with the `z`, `zunit` parameters. For more information, see "Starting and stopping the headless code coverage collector" and "Specifying code coverage options in the startup key" in [IBM Documentation](#).

Eclipse debugger

- When you debug CICS applications, you can now specify `QUIT DEBUG` or `QUIT DEBUG TASK` in the z/OS Debugger Preferences page. For more information, see "Setting debug preferences" in [IBM Documentation](#).
- During playback, the **Variables** view now displays values collected during recording. Variables cannot be updated during replay. For more information, see "Using the Playback toolbar" in [IBM Documentation](#).

IMS Transaction Isolation

- You can perform any operation from a single connection and IMS Transaction Isolation facility will notify other LPARs of the configuration changes. For more information, see "Using IMS Transaction Isolation to create a private message-processing region and select transactions to debug" in [IBM z/OS Debugger User's Guide](#) and "Scenario F: Enabling the Transaction Isolation Facility" in [IBM z/OS Debugger Customization Guide](#).
- The EQAZDFLT settings are now used when you start the IMS Transaction Isolation Facility with the batch interface, Debug Profile Service and ADFz Common Components server, as they already are with the z/OS Debugger Utilities. For more information, see "Scenario F: Enabling the Transaction Isolation Facility" in [IBM z/OS Debugger Customization Guide](#).

EQANDBG

- EQANDBG is now available as an alias of EQANMDBG. It passes the unmodified input parameter list to the application and collects all debugger parameters from EQANMDBG DD. For more information, see "Starting z/OS Debugger for programs that start outside of Language Environment" or "Passing parameters to EQANMDBG or EQANDBG using only the EQANMDBG DD statement" in [IBM z/OS Debugger User's Guide](#).

EQAOPTS command

- Command `LDDAUTOLANGX` can now be specified to control whether LDD is automatically run on LangX COBOL compile units. For more information, see "LDDAUTOLANGX" in [IBM z/OS Debugger Reference and Messages](#).

Remote Debug Service

- Remote Debug Service can now be secured with AT-TLS. For more information, see "Customizing with the sample job EQARMTSU" and "Enabling secure communication with AT-TLS" in [IBM z/OS Debugger Customization Guide](#).

Debug Profile Service

- Debug Profile Service now runs on IBM z/OS Liberty Embedded instead of Apache Tomcat on z/OS. Refresh the `eqaprof.env` with the latest sample file to include environment variable **liberty_dir**. For more information, see "Customizing with the sample job EQAPRFSU" in [IBM z/OS Debugger Customization Guide](#).
- In addition to JCERACFKS, you can now also use a JCECCARACFKS keyring managed by RACF for secure communication. For more information, see the "Enabling secure communication with a RACF managed key ring" section in [IBM z/OS Debugger Customization Guide](#).

- You can now configure the number of requests per second to allow or deny into the Debug Profile Service. For more information, see "Customizing with the sample job EQAPRFSU" in *IBM z/OS Debugger Customization Guide*.

Documentation updates

- A new page is added to list the requisites to use debug functions. For more information, see "Requisite products" in *IBM z/OS Debugger Customization Guide*.
- Details of environment variables in `eqaprcf.env` for Debug Profile Service and `eqarmtc.env` for Remote Debug Service are now documented. For more information, see "Customizing with the sample job EQAPRFSU" (Debug Profile Service) and "Customizing with the sample job EQARMTSU" (Remote Debug Service) in *IBM z/OS Debugger Customization Guide*.

16.0.2

Compiler support

- Support is added for IBM Open Enterprise SDK for Go 1.20.
- Interoperability is now supported between 64-bit Java and 31-bit PL/I programs if you use 64-bit PL/I programs in between. Use delay debug mode to improve efficiency. For more information, see "Using delay debug mode to delay starting of a debug session" in *IBM z/OS Debugger User's Guide*.

IBM Z Open Debug

- Microsoft Visual Studio Code - Open Source is now the default browser-based IDE in Wazi for Dev Spaces. Support for Eclipse Theia has been deprecated as an IDE choice in Red Hat OpenShift Dev Spaces and will be removed in a future release.

IMS Transaction Isolation

- When Debug Profile Service is used, you can now use a filter to retrieve only the matching transactions instead of all the transactions for the specified IMS system to add to the IMS Isolation profile.
- You can now specify the range start and length for message pattern matching in the Eclipse IDE. For more information, see "Creating a debug profile for an IMS application using IMS Isolation with an Eclipse IDE" in [IBM Documentation](#).

Property group

- You can now choose whether to display the **Select Property Group** window when the debug editor initializes. For more information, see "Associating property groups with debug sessions" in [IBM Documentation](#).

Debug Profile Service

In addition to an SSL or a CA certificate, you can now enable Debug Profile Service to communicate with AT-TLS. For more information, see the "Enabling secure communication with AT-TLS" section in *IBM z/OS Debugger Customization Guide*.

16.0.1

Installation Manager

- You can now install the Eclipse IDE via Installation Manager again:
 - For IBM Developer for z/OS, you can install the Eclipse IDE via Installation Manager as in Version 15.0 and before. For more information, see [Installing the IBM Developer for z/OS client by using IBM Installation Manager](#).
 - For IBM Debug for z/OS, you can now install the Eclipse IDE via Installation Manager as an extension offering to the IBM Explorer for z/OS offering, and you no longer need to install via IBM Developer for z/OS. For more information, see [Installing the IBM Debug for z/OS Eclipse IDE with IBM Installation Manager](#).

Compiler support

- Support is added for IBM Open Enterprise SDK for Go 1.19.
- Support is added for 31-bit PL/I applications compiled with TEST (SOURCE).

The following APARs are required for this support:

- z/OS Language Environment APAR PH49423
- Enterprise PL/I for z/OS 6.1 APAR PH50085

Code Coverage

- The multiple import menu actions and buttons in the **Code Coverage Results** view are now consolidated into a single menu action and button to import code coverage results. With the new **Code Coverage Import** wizard, you can select the following result formats to import into any result location in the **Code Coverage Results** view:
 - **CCZIP**: Import coverage results with a file extension of `.cczip`, which are produced by headless code coverage collection or via the Eclipse UI. Older formats ending with `.clcoveragedata`, `.ccresult`, or `.zip` are also supported with this option.
 - **JaCoCo**: Import coverage results data execution files with a file extension of `.exec`, which are produced by JaCoCo.
 - **z/OS Debugger**: Import coverage information that is stored in a sequential data set, which is produced in z/OS Debugger using CC or DCC in the TEST runtime option via MFI.
 - **Java Code Coverage**: Import legacy Java code coverage results with a file extension of `.coveragedata`. This option is available only in IBM Developer for z/OS and IBM Developer for z/OS Enterprise Edition.

All files are converted to the `.cczip` format during import. For more information, see "Importing compiled code coverage results", "Importing JaCoCo code coverage results", "Importing z/OS Debugger code coverage data", and "Importing legacy Java code coverage results" in [IBM Documentation](#).

- With Code Coverage Service, you can now download exporter formats PDF, SonarQube, and Cobertura, in addition to CCZIP. For more information, see "Code Coverage Service RESTful API Documentation" in [IBM Documentation](#).
- The summary section in the code coverage reports now provides more useful statistics and improved usability.
- You can now customize the colors that are used to indicate the threshold statuses (failure, warning, passed) for code coverage results in the code coverage reports.

z/OS Debugger Profiles view

- In the Debug Profile Editor, the CICS user ID field is now pre-populated with the reserved keyword `&USERID`, which is substituted with the currently logged-in user ID upon profile activation.
- On the **IBM z/OS Debugger Preferences** page, you can now choose whether to automatically synchronize debug profiles in the view with those in the remote system when you establish an RSE connection. For more information, see the "Setting debug preferences" topic in [IBM Documentation](#).

Debug Manager

- Debug Manager can now establish communication between the client and the debugger when the LPAR the client is connect to and the LPAR that the debug session is started are different. The sysplex support requires Eclipse IDE 16.0.1 or later. For more information, see "Enabling sysplex support" in *IBM z/OS Debugger Customization Guide*.
- You can now use a configuration file to start Debug Manager. With a configuration file, you can start Debug Manager even when the length of command line with all necessary options exceeds 100 characters limit, for example, in the sysplex environment. For more information, see "Running Debug Manager as a started task using a configuration file" in *IBM z/OS Debugger Customization Guide*.

16.0.0

Compiler support

- Support is added for IBM Open XL C/C++ for z/OS 1.1. z/OS Language Environment APAR PH46617 is required for this support.
- Support is added for IBM Open Enterprise SDK for Go 1.18.
- Interoperability is now supported between 31-bit and 64-bit PL/I programs. Use delay debug mode to improve efficiency. For more information, see "Using delay debug mode to delay starting of a debug session" in *IBM z/OS Debugger User's Guide*.

The following APARs are required for this support:

- z/OS Language Environment APARs PH48829 and PH48239
- Enterprise PL/I for z/OS 6.1 APAR PH49506

64-bit support

- With the removal of standard mode, 64-bit PL/I programs are now supported in Debug Tool compatibility mode with some limitations. For more information, see the "Limitations of 64-bit support in remote debug mode" topic in *IBM z/OS Debugger User's Guide*.

The following APARs are required for this support:

- z/OS Language Environment APARs PH48829 and PH48239
- Enterprise PL/I for z/OS 6.1 APAR PH49506
- Enterprise PL/I for z/OS 5.3 APAR PH49425

Code Coverage

- New web-based code coverage reports and comparison reports are available. You can now view the compared source files line by line. For more information, see "Working with a code coverage report" and "Working with a code coverage comparison report" in [IBM Documentation](#).
- Java code coverage is now strategically based on open source packages, in particular JaCoCo. You can import JaCoCo results into the **Code Coverage Results** view and work with the imported results. You can still import results previously generated with IBM Java code coverage tools into the view. The Java code coverage results already in the workspace will be migrated automatically. For more information, see "Working with Java code coverage results" in [IBM Documentation](#).
- You can now specify a warning threshold, in addition to failure threshold for code coverage result status. For more information, see "Setting the code coverage acceptance level" in [IBM Documentation](#).
- When you export code coverage results in SonarQube format, you can now specify a different encoding than the default UTF-8. For more information, see "Exporting code coverage results in SonarQube format", "Starting and stopping the headless code coverage collector", "Specifying code coverage options in the startup key", and "Merging and exporting code coverage results from z/OS" in [IBM Documentation](#).

Source level debug

- If you debug programs compiled with Enterprise COBOL for z/OS Version 6 Release 2 and later, you can now specify compiler option TEST(NOSOURCE) to use the **Source** view as the default in the Eclipse IDE, or you can switch to the **Source** view during the debug session if you compile with TEST(SOURCE). With TEST(NOSOURCE), the compiler does not include the source of your program as part of your debug data whether the location of the debug data is in the load module or in the SYSDEBUG file. For more information, see "Working with different debug views" in [IBM Documentation](#).

IMS Transaction Isolation

- You can now access IMS Transaction Isolation Facility with Debug Profile Service. ADFzCC configuration is no longer needed when Debug Profile Service is running on the selected RSE connection with z/OS Debugger 16.0.0 or later. The system programmer needs to configure the IMS

Transaction Isolation API to enable this function. For more information, see "Configuring the IMS Transaction Isolation API for the Debug Profile Service" in *IBM z/OS Debugger Customization Guide*.

- You can now specify a character to be used as the job class for the isolated region when you create a debug profile for an IMS application.
For more information, see "Creating a debug profile for an IMS application using IMS Isolation with an Eclipse IDE" in *IBM Documentation*.
- Pattern matching used to filter transactions for isolation can now be limited to a range within a transaction message. For more information, see "Using IMS Transaction Isolation to create a private message-processing region and select transactions to debug" in *IBM z/OS Debugger User's Guide*.

Debug Profile Service

- On the **IBM z/OS Debugger Preferences** page, you can specify to ignore the SSL certificate errors when the Debug Profile Service that you want to connect to does not have a valid SSL certificate. For more information, see the "Setting debug preferences" topic in *IBM Documentation*.
- As a system programmer, you can now set up Debug Profile Service to use external CICS interface (EXCI) to manage debug profiles stored in the region's repository instead of using the DTCN API. For more information, see "Defining the CICS EXCI CONNECTION and SESSIONS resources" in *IBM z/OS Debugger Customization Guide*.

Property group

- You can associate property groups to avoid parsing errors in the language editors and ensure that visual debug can work properly. The property group can now be added or changed during a debug session, if you use a **z/OS Batch Application using existing JCL** or **z/OS Unix Application** launch configuration. For more information, see "Associating property groups with debug sessions" in *IBM Documentation*.

EQA_OPTS command

- Command CICSASMPGMND can now be specified to control whether z/OS Debugger allows debugging assembler programs when the language attribute of the program resource is not defined. For more information, see "CICSASMPGMND" in *IBM z/OS Debugger Reference and Messages* and "Starting z/OS Debugger for non-Language Environment programs under CICS" in *IBM z/OS Debugger User's Guide*.

What's removed from IBM z/OS Debugger

Deprecation announcement

The following features are superseded by newer features and will be removed in a future release.

- z/OS Debugger Code Coverage: You can collect code coverage with the headless code coverage collector or the Eclipse IDE.
- TEST runtime suboption VADSCPnnnnn: Use EQAXOPT CODEPAGE for a code page other than 037.
- DTCN API and ADFzCC server support: DTCN profiles are supported by Debug Profile Service, and developers can use Debug Profile Service REST API to manage debug profiles.
- IMS Isolation ADFzCC server support: IMS Isolation debug profiles in the Eclipse IDE are now supported by Debug Profile Service, which provides more IMS Isolation features.

16.0.0

- Standard mode is no longer supported. Debug Tool compatibility mode is now the only remote debug mode and is referred to as remote debug mode directly. If you use DIRECT or DBM in the TEST runtime option, Debug Tool compatibility mode is invoked instead.
- Debug Tool plug-ins are removed. If you migrate from previous releases, any Debug Tool plug-in views are automatically closed in workspaces.
The same functions are available with other features.

- You can use the z/OS Debugger Profiles view in the Eclipse IDE or the z/OS Debugger Profiles view provided with Z Open Debug to create and manage debug profiles. If you are a system programmer, you can use z/OS Debugger Profile Management to manage CICS (DTCN) profiles from all users.
- You can use the **z/OS Batch Application with existing JCL** launch configuration to dynamically instrument and submit JCL to the host.
- You can use the **Code Coverage Results** view to work with code coverage results.
- Load Module Analyzer is no longer bundled with z/OS Debugger.
- Generating code coverage for Java applications is no longer supported. You can import Java results that are generated by open source packages, in particular JaCoCo, into the **Code Coverage Results** view.
- Jython Debugger is no longer supported.
- Team debug is no longer supported.
- IMS message region templates (IBM z/OS Debugger Utilities options 4.3 Swap IMS Transaction Class and Run Transaction and option 4.4 Manage IMS Message Region Templates) are removed. Use options 4.5 IMS Transaction Isolation and option 4.6 Administer IMS Transaction Isolation Environment instead.
- TEST runtime suboption VADTCP& is no longer supported. Use TCP& instead.

Overview of IBM z/OS Debugger

IBM z/OS Debugger is the next iteration of IBM debug technology on IBM Z and consolidates the IBM Integrated Debugger and IBM Debug Tool engines into one unified technology.

IBM z/OS Debugger is a host component that supports various debug interfaces, like the Eclipse and Visual Studio Code IDEs. z/OS Debugger and the supported debug interfaces are provided with the following products:

IBM Developer for z/OS Enterprise Edition

This product is included in [IBM Application Delivery Foundation for z/OS](#). IBM Developer for z/OS Enterprise Edition provides all the debug features.

IBM Developer for z/OS Enterprise Edition currently provides debug functions in the following IDEs:

- IBM Developer for z/OS Eclipse
- Wazi for Dev Spaces, through IBM Z Open Debug
- Wazi for VS Code, through IBM Z Open Debug

IBM Developer for z/OS

IBM Developer for z/OS is a subset of IBM Developer for z/OS Enterprise Edition. IBM Developer for z/OS, previously known as IBM Developer for z Systems or IBM Rational® Developer for z Systems®, is an Eclipse-based integrated development environment for creating and maintaining z/OS applications efficiently.

IBM Developer for z/OS includes all enhancements in IBM Developer for z/OS Enterprise Edition except for the debug features noted in [Table 2 on page xxi](#).

IBM Debug for z/OS

IBM Debug for z/OS is a subset of IBM Developer for z/OS Enterprise Edition. IBM Debug for z/OS focuses on debugging solutions for z/OS application developers. See [Table 2 on page xxi](#) for the debug features supported.

IBM Debug for z/OS does not provide advanced developer features that are available in IBM Developer for z/OS Enterprise Edition.

For information about how to install the IBM Debug for z/OS Eclipse IDE, see [Installing the IBM Debug for z/OS Eclipse IDE](#).

IBM Z and Cloud Modernization Stack

IBM Z and Cloud Modernization Stack brings together component capabilities from IBM Z into an integrated platform that is optimized for Red Hat OpenShift Container Platform. With this solution, you can analyze the impact of application changes on z/OS, create and deploy APIs for z/OS applications, work on z/OS applications with cloud native tools, and standardize ID automation for z/OS. Starting from 2.0, Wazi Code is delivered in IBM Z and Cloud Modernization Stack. Wazi Code 1.x is still available in IBM Wazi Developer for Red Hat CodeReady Workspaces.

The debug functions are available in the IDEs provided with Wazi Code:

- Wazi for Dev Spaces, through IBM Z Open Debug
- Wazi for VS Code, through IBM Z Open Debug

Table 2 on page xxi maps out the features that differ in products. Not all the available features are listed. To find the features available in different remote IDEs, see [Table 3 on page xxiii](#).

	IBM Debug for z/OS	IBM Developer for z/OS	IBM Developer for z/OS Enterprise Edition	IBM Z and Cloud Modernization Stack (Wazi Code)
Main features				

Table 2. Debug feature comparison (continued)

	IBM Debug for z/OS	IBM Developer for z/OS	IBM Developer for z/OS Enterprise Edition	IBM Z and Cloud Modernization Stack (Wazi Code)
3270 interface, including z/OS Debugger Utilities	√		√	
Eclipse IDE, see Table 3 on page xxiii for feature details. ¹	√	√	√	
IBM Z Open Debug provided with the Wazi for Dev Spaces IDE, see Table 3 on page xxiii for feature details. ¹			√	√
IBM Z Open Debug provided with the Wazi for VS Code IDE, see Table 3 on page xxiii for feature details. ¹			√	√
Code Coverage features				
Compiled Language Code Coverage ²	√	√ ³	√	
Headless Code Coverage	√	√	√	
ZUnit Code Coverage ⁴		√	√	
z/OS Debugger Code Coverage (3270 and remote interfaces) ⁵	√		√	
3270 features				
z/OS Debugger full screen, batch or line mode	√		√	
IMS Isolation support	√		√	
Compiler support features				
Assembler support: Create EQALANGX files	√	√	√	

	IBM Debug for z/OS	IBM Developer for z/OS	IBM Developer for z/OS Enterprise Edition	IBM Z and Cloud Modernization Stack (Wazi Code)
Assembler support: Debugging ⁶	√	√	√ ⁷	√ ⁷
LangX COBOL support ⁸	√	√	√	
Support for Automatic Binary Optimizer (ABO)	√	√	√	

Notes:

- The following features are supported only in remote debug mode:
 - Support for 64-bit COBOL feature of z/OS for COBOL V6.3 and later
 - Support for 64-bit Enterprise PL/I for z/OS Version 5 and later
 - Support for 64-bit C/C++ feature of z/OS
 - Support for Open Enterprise SDK for Go 1.21 and 1.22.
 - Support for Open XL C/C++ for z/OS 1.1 and later.
- Code coverage does not support Go programs.
- IBM Developer for z/OS includes z/OS Debugger remote debug and compiled code coverage Eclipse interface, but does not include z/OS Debugger Code Coverage.
- ZUnit Code Coverage is only supported in Debug Tool compatibility mode.
- z/OS Debugger Code Coverage can only be enabled in the 3270 interface. This function is deprecated and will be removed in a future release.
- Debugging assembler requires that you have EQALANGX files that have been created via ADFz Common Components or a product that ships the ADFz Common Components.
- This feature is only available with the Eclipse IDE.
- LangX COBOL refers to any of the following programs:
 - A program compiled with the IBM OS/VS COBOL compiler.
 - A program compiled with the IBM VS COBOL II compiler with the NOTEST compiler option.
 - A program compiled with the IBM Enterprise COBOL for z/OS 3, 4, or 6 compiler with the NOTEST compiler option.

Feature	Eclipse-based debug interface	IBM Z Open Debug ^{1,6}
Integration with Language Editors ⁶	<ul style="list-style-type: none"> COBOL Editor² PL/I Editor² Remote C/C++ Editor² System z LPEX Editor² 	<ul style="list-style-type: none"> Z Open Editor
Visual Debug	√ ^{2,6}	
Debugging ZUnit tests	√ ⁶	
Debug profile management	√ ⁶	√

Table 3. Remote IDE debug feature comparison (continued)

Feature	Eclipse-based debug interface	IBM Z Open Debug ^{1,6}
IMS Isolation UI	√ ³	
Integration with CICS Explorer views	√ ²	
Integration with property groups	√ ^{2,6}	
Integrated launch ⁶	<ul style="list-style-type: none"> • z/OS UNIX Application launch configuration • z/OS Batch Application using existing JCL • z/OS Batch Application using a property group⁴ 	
Modules	√	
Memory	√	
Program navigation		
Step over/Next	√	√
Step into/Step in	√	√
Step return/Step out	√	√
Jump to location	√ ⁶	
Run to location/Run to cursor	√ ⁶	√
Resume/Continue	√	√
Terminate	√	√
Animated step	√	
Playback	√ ⁶	
Breakpoints		
Statement breakpoints	√	√
Entry breakpoints	√	
Source entry breakpoints	√ ⁶	
Event breakpoint	√ ⁶	
Address breakpoint	√ ⁶	
Watch breakpoint	√ ⁶	
Variables & Registers		
Variables	√	√
Registers	√	√ ⁵
Modifying variable and register values	√	√
Setting variable filter	√	
Changing variable representation	√	

Table 3. Remote IDE debug feature comparison (continued)

Feature	Eclipse-based debug interface	IBM Z Open Debug ^{1,6}
Displaying in memory view	√	
Monitors		
Displaying monitor	√	√
Modifying monitor value	√	
Changing variable representation	√	
Debug Console		
Evaluating variables and expressions		√
z/OS Debugger commands	√ ⁶	

Notes:

1. IBM Z Open Debug is provided with Wazi for Dev Spaces and Wazi for VS Code.
2. This feature is not available in IBM Debug for z/OS.
3. This feature is only available in IBM Developer for z/OS Enterprise Edition.
4. IBM Developer for z/OS does not include z/OS Debugger Code Coverage 3270 interfaces.
5. Registers are available in the **Variables** view.
6. Programs compiled with IBM Open Enterprise SDK for Go are not supported.

Chapter 1. z/OS Debugger commands

z/OS Debugger provides the following commands:

? command

Displays a list of all commands or, if used in combination with a command, displays a list of options that you can specify for that command.

►► ? — ; ►►

ALLOCATE command

The ALLOCATE command allocates a file (*ddname*) to an existing data set, a concatenation of existing data sets, or a temporary data set.

►► ALLOCATE — FILE — *ddname* — attributes — ; ►►

attributes

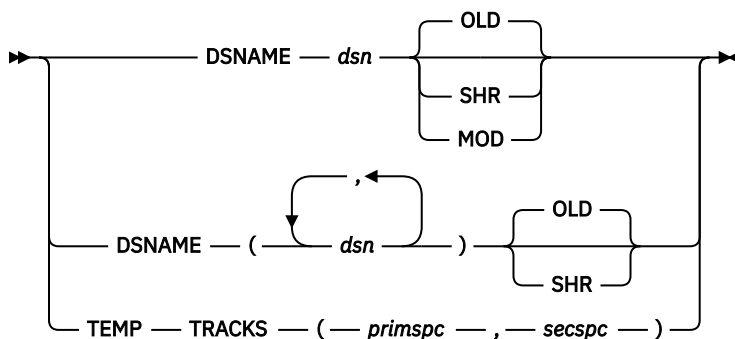

ANALYZE command (PL/I)

The ANALYZE command displays the process of evaluating an expression and the data attributes of any intermediate results.

►► ANALYZE — EXPRESSION — (— *expression* —) — ; ►►

Assignment command (assembler and disassembly)

The Assignment command copies the value of an expression to a specified memory location or register.



Assignment command (LangX COBOL)

The Assignment command assigns the value of an expression to a specified reference. It is the equivalent of the COBOL COMPUTE statement.

►► '— receiver —' — = — '— sourceexpr —' — ; ►►

Assignment command (PL/I)

The Assignment command copies the value of an expression to a specified reference.

►► *reference* — = — *expression* — ; ►►

AT ALLOCATE (PL/I)

AT ALLOCATE gives z/OS Debugger control when storage for a named controlled variable or aggregate is dynamically allocated by PL/I.

►► AT — *every_clause* — ALLOCATE — *identifier* — *command* — ; ►►

(— *identifier* —)
*

AT APPEARANCE

Gives z/OS Debugger control when the specified compile unit is found in storage.

►► AT — *every_clause* — APPEARANCE — *cu_spec* — *command* — ►►

(— *cu_spec* —)
*

►► ; ►►

AT CALL

Gives z/OS Debugger control when the application code attempts to call the specified entry point.

►► AT — *every_clause* — CALL — *entry_name* — *command* — ; ►►

(— *entry_name* —)
*

AT CHANGE

Gives z/OS Debugger control when either the program or z/OS Debugger command changes the specified variable value or storage location, and, optionally, when the specified condition is met.

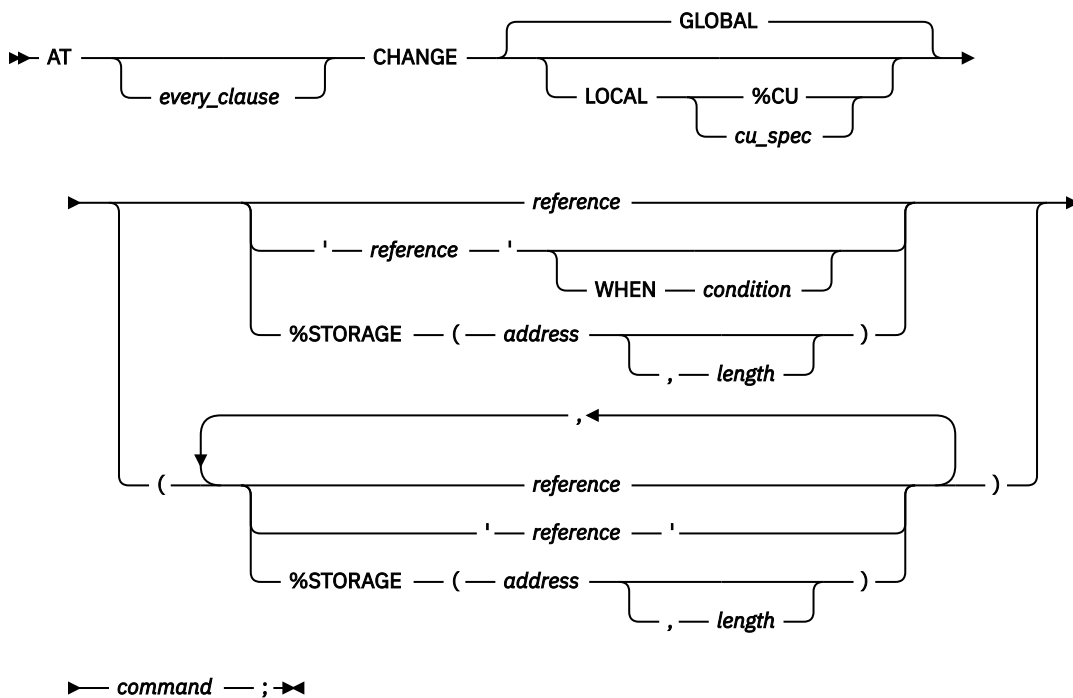

AT CHANGE (remote)

Gives z/OS Debugger control when either the program or z/OS Debugger command changes the specified variable value.

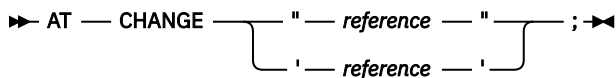

AT CURSOR (full-screen mode)

Provides a cursor controlled method for setting a statement breakpoint.

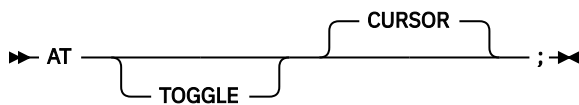

AT DATE (COBOL)

Gives z/OS Debugger control for each date processing statement within the specified block.

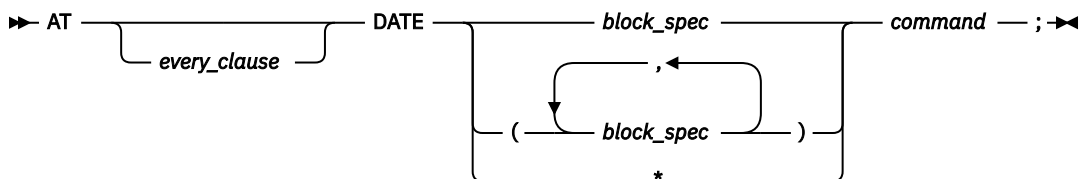

AT DELETE

Gives z/OS Debugger control when a load module is removed from storage by a Language Environment delete service, such as on completion of a successful C release(), COBOL CANCEL, or PL/I RELEASE.

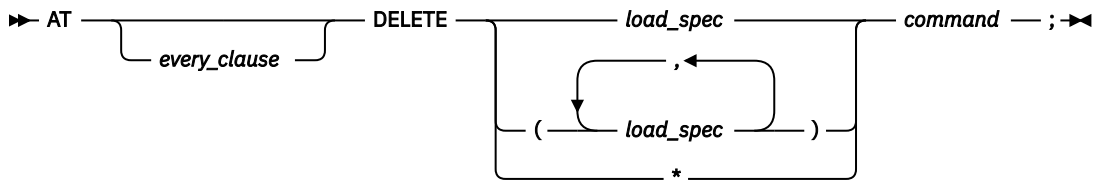

AT ENTRY

Defines a breakpoint at the specified entry point in the specified block.

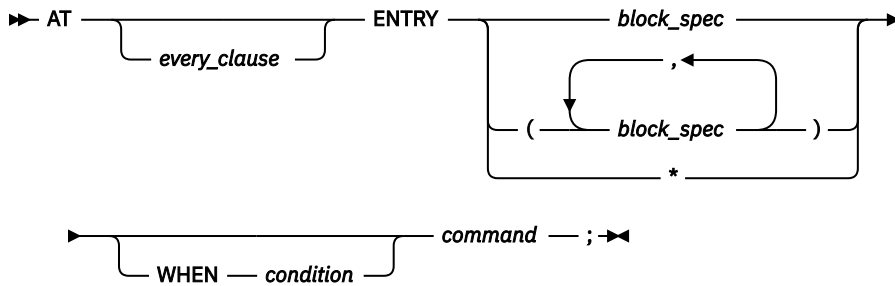

AT ENTRY (remote)

Defines a breakpoint at the specified entry point in the specified block.

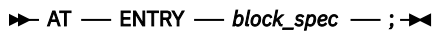

AT EXIT

Defines a breakpoint at the specified exit point in the specified block.

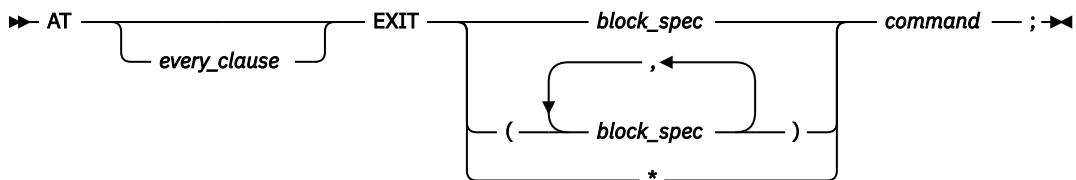

AT GLOBAL

Gives z/OS Debugger control for every instance of the specified AT-condition.

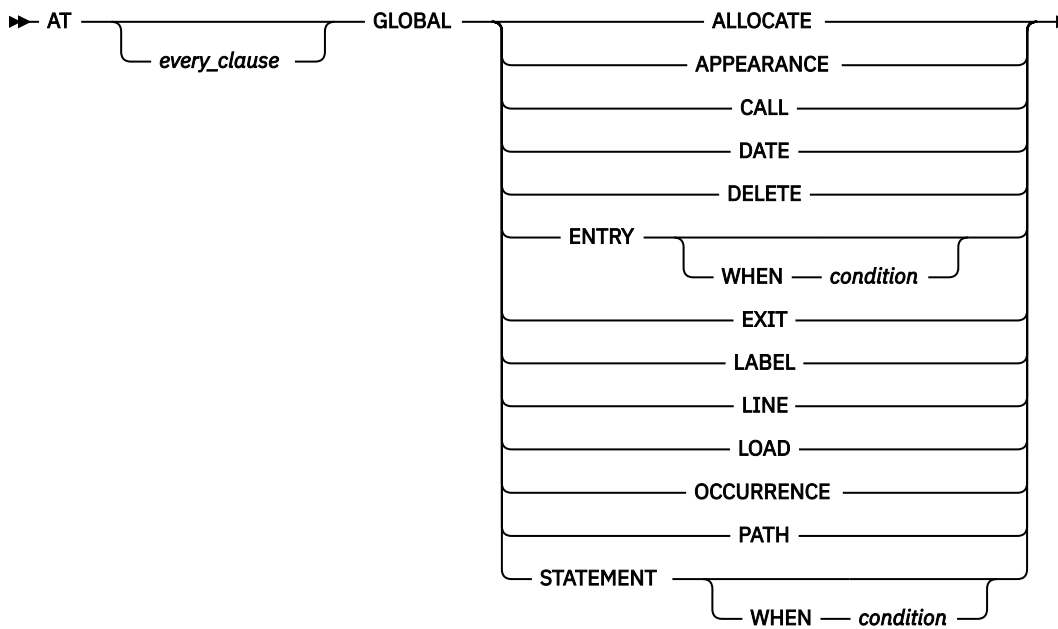

► *command* — ; ►

AT GLOBAL LABEL (remote)

Gives z/OS Debugger control for every instance of the specified AT-Label condition.

► AT — GLOBAL — LABEL — ; ►

AT LABEL

Gives z/OS Debugger control when execution has reached the specified statement label or group of labels.

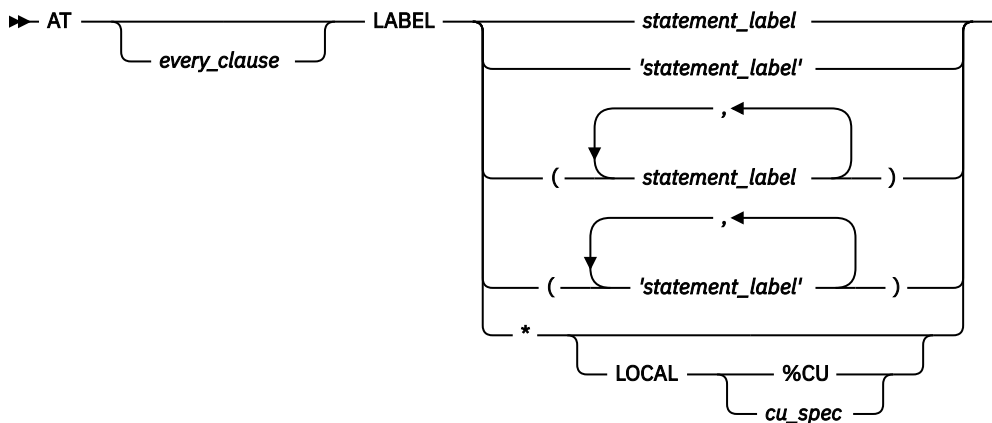

► *command* — ; ►

AT LABEL (remote)

Gives z/OS Debugger control when execution reaches the statement label that you specify.

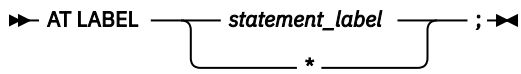

AT LINE

Gives z/OS Debugger control at the specified line. See “AT STATEMENT” on page 7.

AT LOAD

Gives z/OS Debugger control when the specified load module is brought into storage.

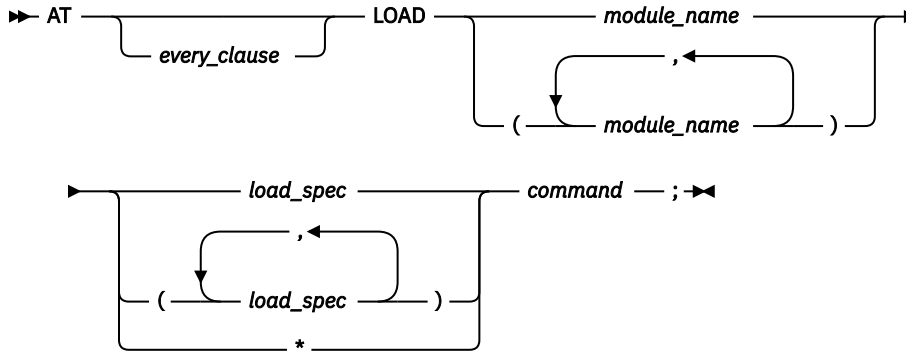

AT LOAD (remote)

Gives z/OS Debugger control when the specified load module is brought into storage.

►► AT — LOAD — *module_name* — ; ►►

AT OCCURRENCE

Gives z/OS Debugger control on a language or Language Environment condition or exception.

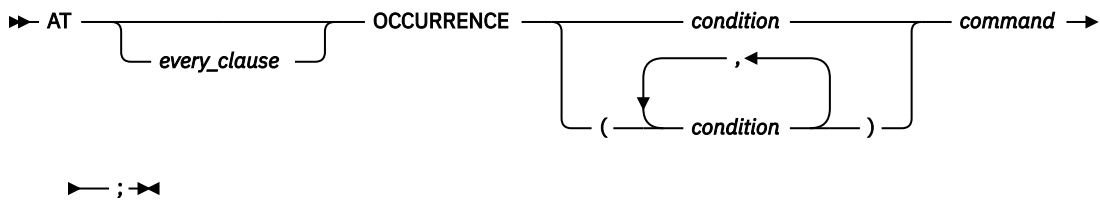

AT OFFSET (disassembly)

Gives z/OS Debugger control at the specified offset in the disassembly view.

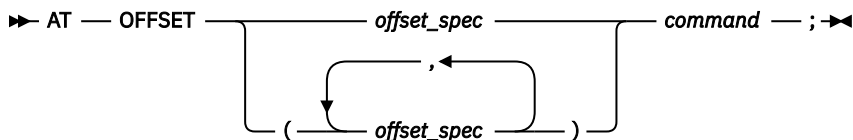

AT PATH

Gives z/OS Debugger control when the flow of control changes (at a path point). AT PATH is identical to AT GLOBAL PATH.

▶▶ AT every_clause PATH *command* ; ▶▶

AT Prefix (full-screen mode)

Sets a statement breakpoint when you issue this command through the Source window prefix area.

▶▶ AT integer ; ▶▶

AT STATEMENT

Gives z/OS Debugger control at each specified statement or line within the given set of ranges, and, optionally, when the specified condition is met.

▶▶ AT every_clause LINE STATEMENT statement_id_range command ; ▶▶
WHEN condition
(statement_id_range)
*

AT STATEMENT (remote)

Gives z/OS Debugger control at each specified statement or line.

▶▶ AT LINE STATEMENT *statement_id* ; ▶▶

AT TERMINATION

Gives z/OS Debugger control when the application program is terminated.

▶▶ AT — TERMINATION — *command* — ; ▶▶

BEGIN command (programming language neutral)

BEGIN and END delimit a sequence of one or more commands to form one longer command.

▶▶ BEGIN — ; command — END — ; ▶▶

block command (C and C++)

The `block` command allows you to group any number of z/OS Debugger commands into one command.

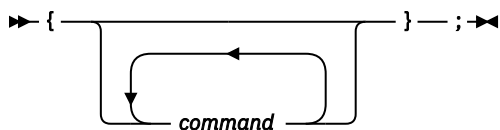

break command (C and C++)

The `break` command allows you to terminate and exit a loop (that is, `do`, `for`, and `while`) or `switch` command from any point other than the logical end.

`>> break ; <<`

CALL %CEBR

Starts the CICS Temporary Storage Browser Program.

`>> CALL %CEBR ; <<`

CALL %CECI

Starts the CICS Command Level Interpreter Program.

`>> CALL %CECI ; <<`

CALL %DUMP

Calls the Language Environment dump service to obtain a formatted dump.

`>> CALL %DUMP (options_string , title) ; <<`

CALL %FA

Starts and instructs IBM Fault Analyzer to provide a formatted dump of the current machine state.

`>> CALL %FA ; <<`

CALL %FM

Starts IBM File Manager for z/OS.

`>> CALL %FM userID BACKGROUND ; <<`

CALL %HOGAN

Starts Computer Sciences Corporation's KORE-HOGAN application, also known as SMART (System Memory Access Retrieval Tool).

►► CALL — %HOGAN — ; ►►

CALL %VER

Adds a line to the log describing the maintenance level of z/OS Debugger that you have installed on your system.

►► CALL — %VER — ; ►►

CALL entry_name (COBOL)

Calls an entry name in the application program.

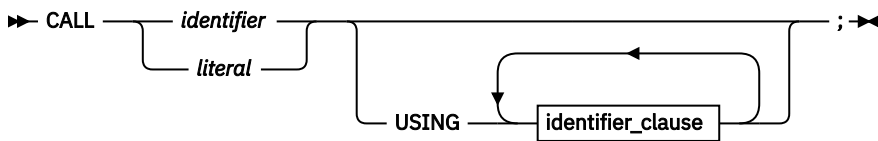

identifier_clause

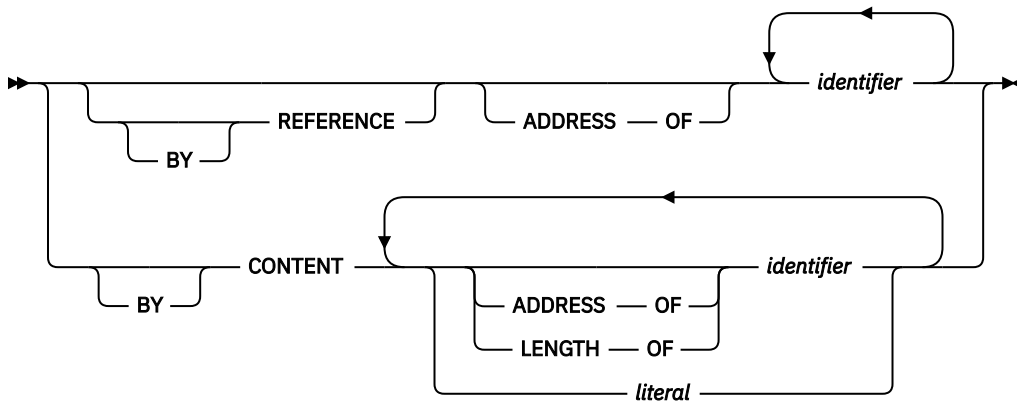

CALL procedure

Calls a procedure that has been defined with the PROCEDURE command.

►► CALL — *procedure_name* — ; ►►

CC command

Controls whether code coverage data is collected.

►► CC — START — ; ►►
 STOP

CHKSTGV

Check for a specific type of storage violation in the task you are currently debugging.

▶▶ CHKSTGV — ; ▶▶

CLEAR command

The CLEAR command removes the actions of previously issued z/OS Debugger commands.

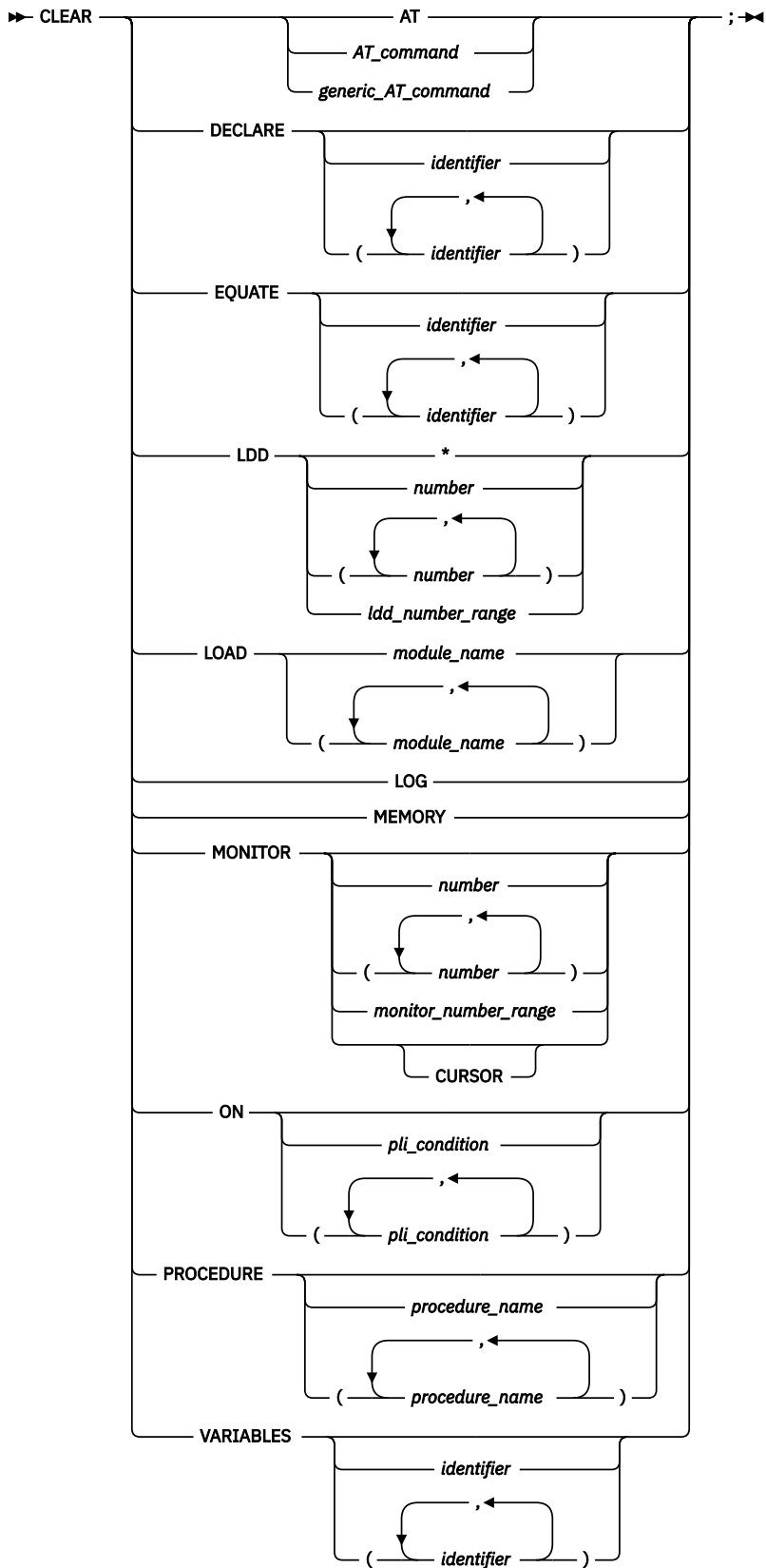

CLEAR AT (remote)

You can use the CLEAR AT command to remove actions that were completed by using the AT GLOBAL LABEL or the AT LABEL commands.

►► CLEAR AT — GLOBAL — LABEL — ; ►►
 └── LABEL — *statement_label* ──┘
 * ──┘

CLEAR prefix (full-screen mode)

Clears a breakpoint when you issue this command through the Source window prefix area.

►► CLEAR ─── ; ►►
 └── *integer* ──┘

COMMENT command

The COMMENT command can be used to insert commentary in to the session log.

►► COMMENT ─── ; ►►
 └── *commentary* ──┘

COMPUTE command (COBOL)

The COMPUTE command assigns the value of an arithmetic expression to a specified reference.

►► COMPUTE ─ *reference* ─ = ─ *expression* ─ ; ►►

CURSOR command (full-screen mode)

The CURSOR command moves the cursor between the last saved position on the z/OS Debugger session panel (excluding the header fields) and the command line.

►► CURSOR ─ ; ►►

Declarations (assembler, disassembly, and LangX COBOL)

Use declarations to create session variables and tags effective during a z/OS Debugger session.

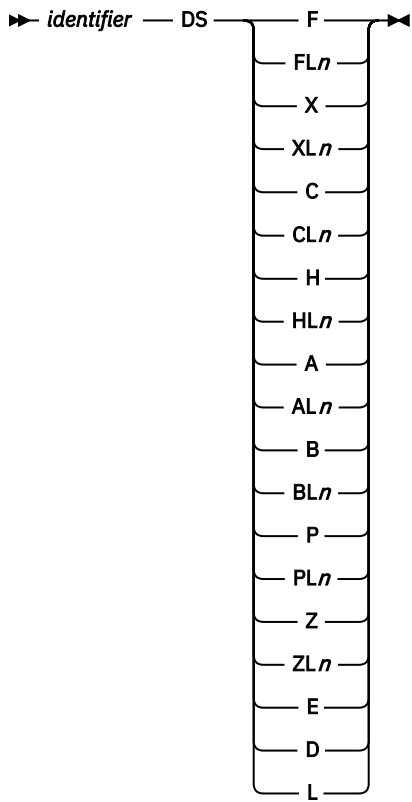

Declarations (C and C++)

Use declarations to create session variables and tags effective during a z/OS Debugger session.

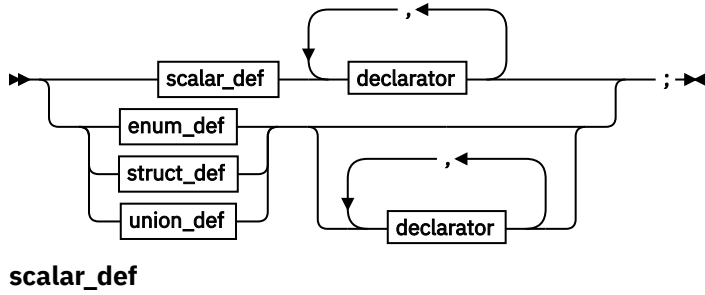

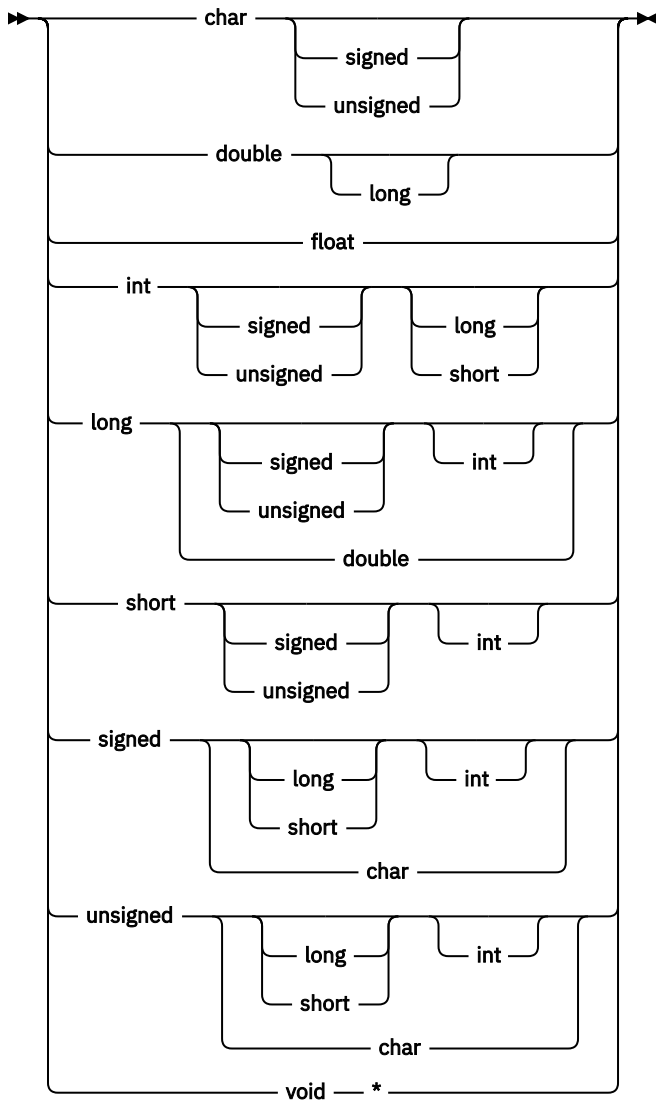

declarator

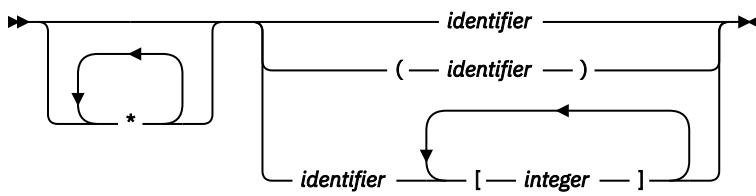

enum_def

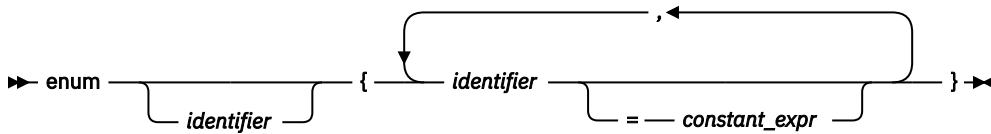

struct_def

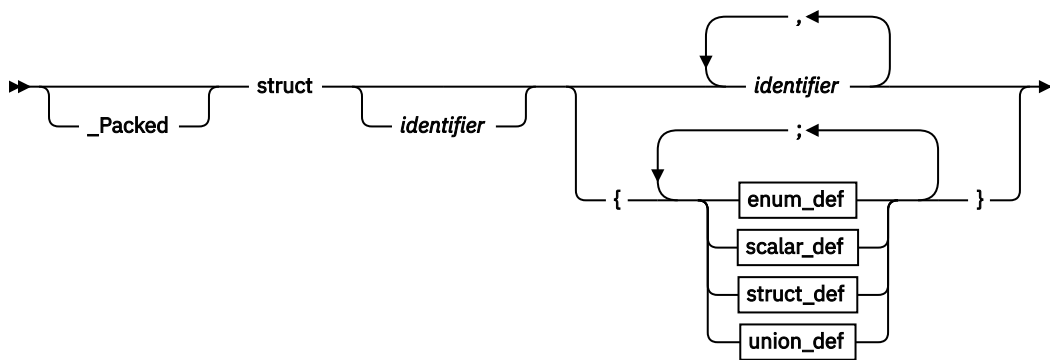

union_def

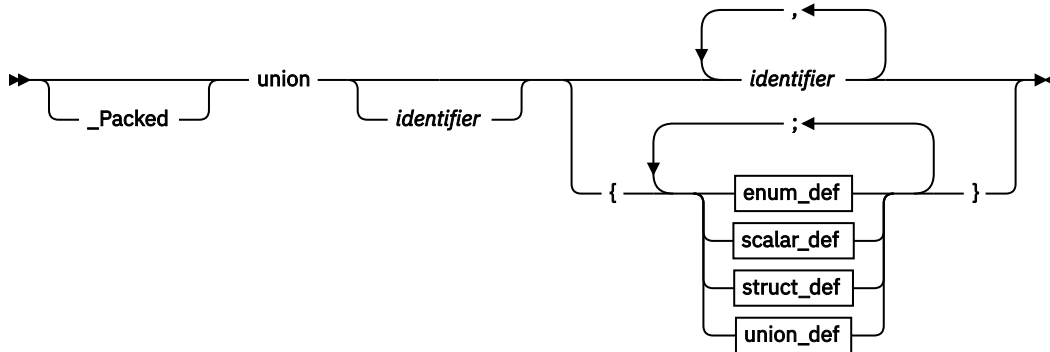

Declarations (COBOL)

Use declarations to create session variables effective during a z/OS Debugger session.

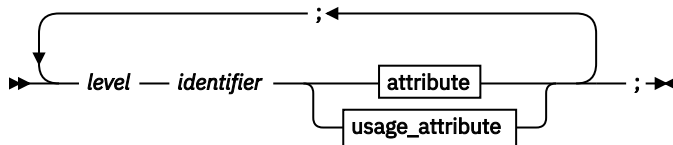

attribute

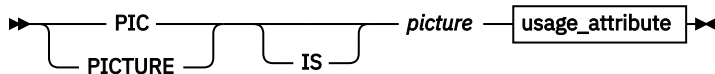

usage_attribute

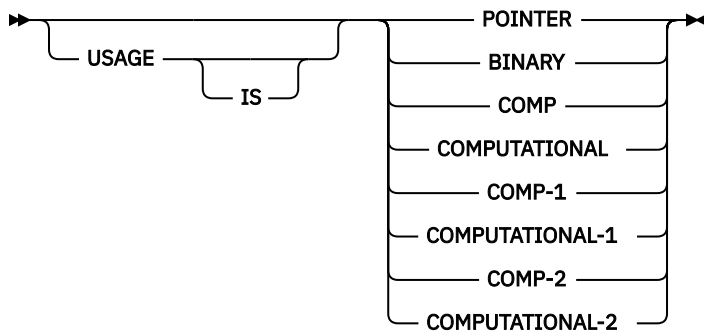

DECLARE command (PL/I)

The DECLARE command creates session variables effective during a z/OS Debugger session.

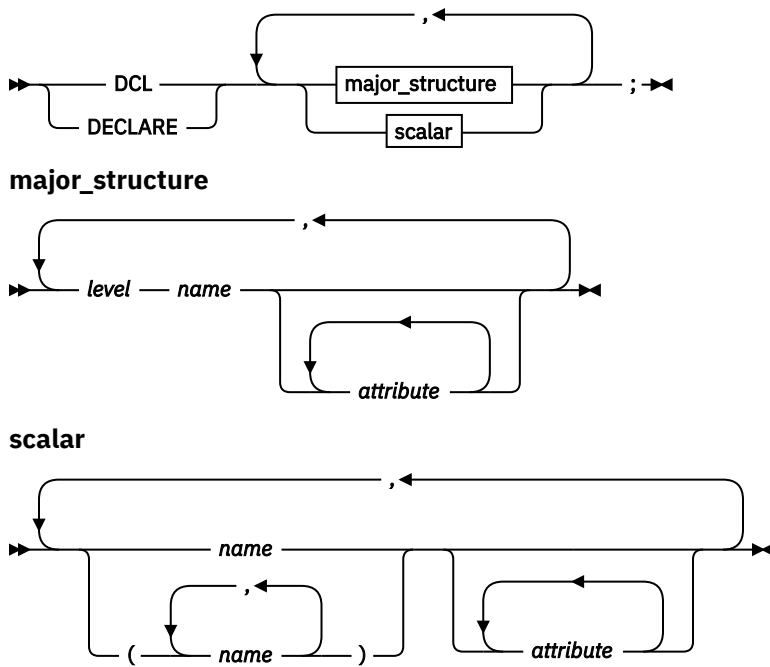

DESCRIBE command

The DESCRIBE command displays the file allocations or attributes of references, compile units, known load modules, and the runtime environment.

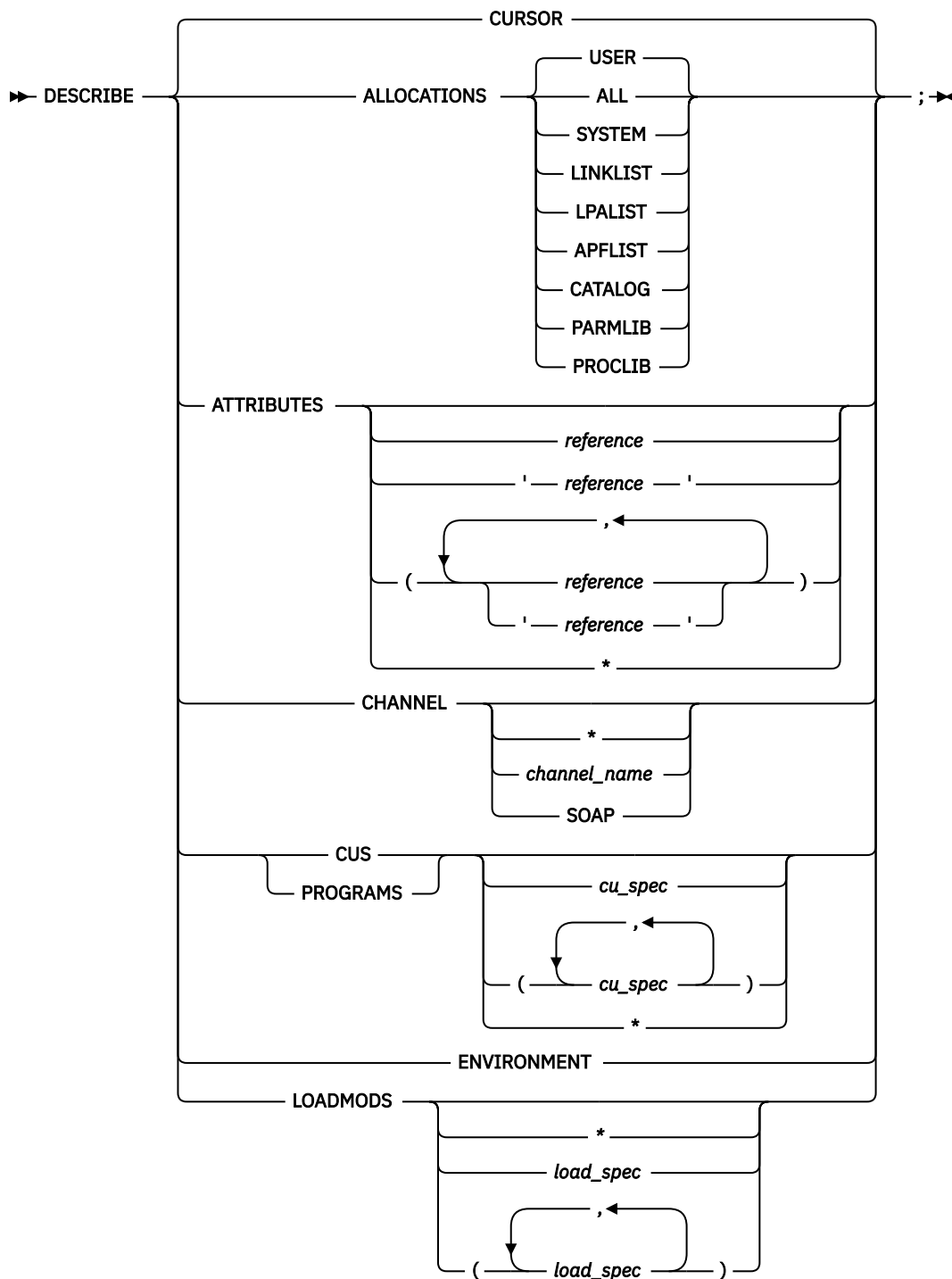

DISABLE command

The DISABLE command makes an AT breakpoint inoperative or prevents z/OS Debugger from being started by DTCN. However, the breakpoint is not cleared. Later, you can make the breakpoint operative or allow z/OS Debugger to be started by DTCN by using the ENABLE command.

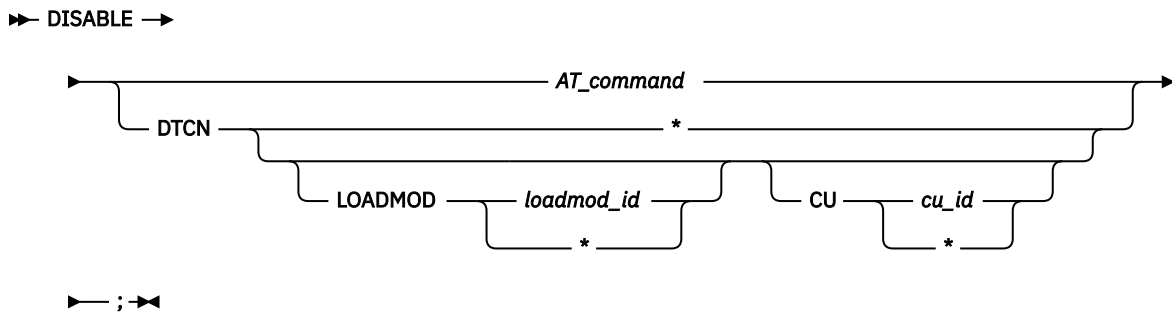

DISABLE prefix (full-screen mode)

Disables a statement breakpoint or offset breakpoint when you issue this command through the Source window prefix area.



DO command (assembler, disassembly, LangX COBOL, and COBOL)

The DO command performs one or more commands that are collected into a group.

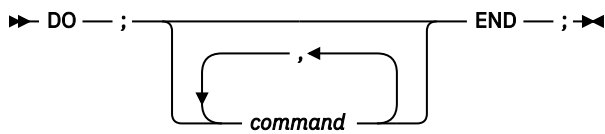

DO command (PL/I)

The DO command allows one or more commands to be collected into a group that can (optionally) be repeatedly executed.

Simple

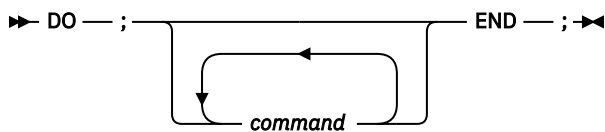

Repeating

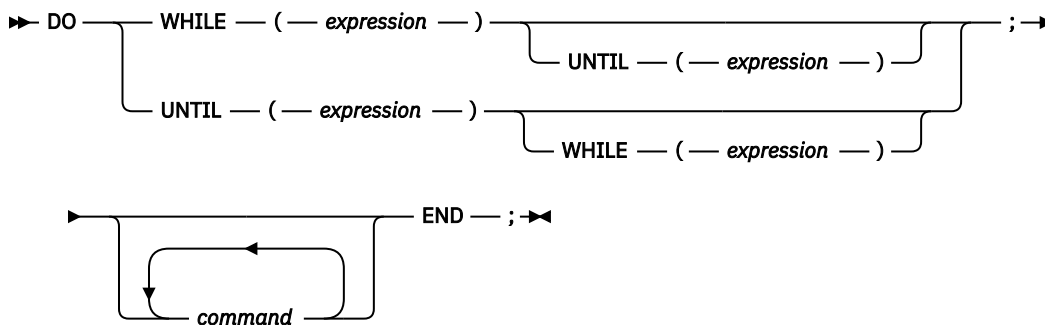

Iterative

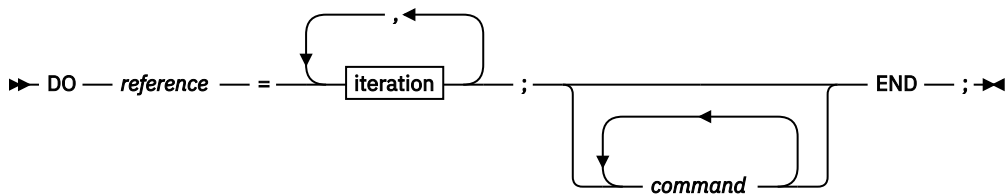

iteration

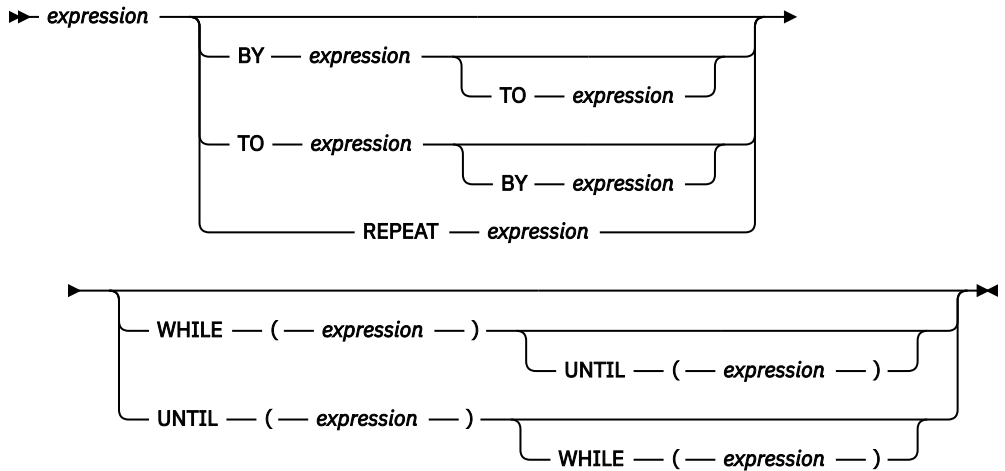

do/while command (C and C++)

The do/while command performs a command before evaluating the test expression.

►► do — *command* — while — (— *expression* —) — ; ►►

ENABLE command

The ENABLE command activates an AT or pattern match breakpoint after it was disabled.

►► ENABLE →

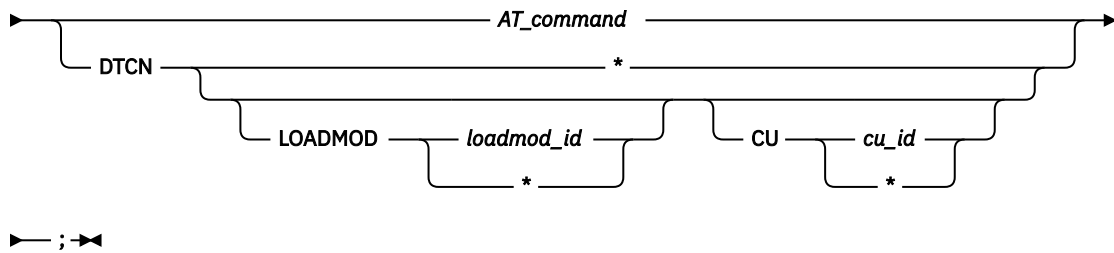

ENABLE prefix (full-screen mode)

Enables a disabled statement breakpoint or a disabled offset breakpoint when you issue this command through the Source window prefix area.

►► ENABLE — *integer* — ; ►►

EVALUATE command (COBOL)

The EVALUATE command provides a shorthand notation for a series of nested IF statements.

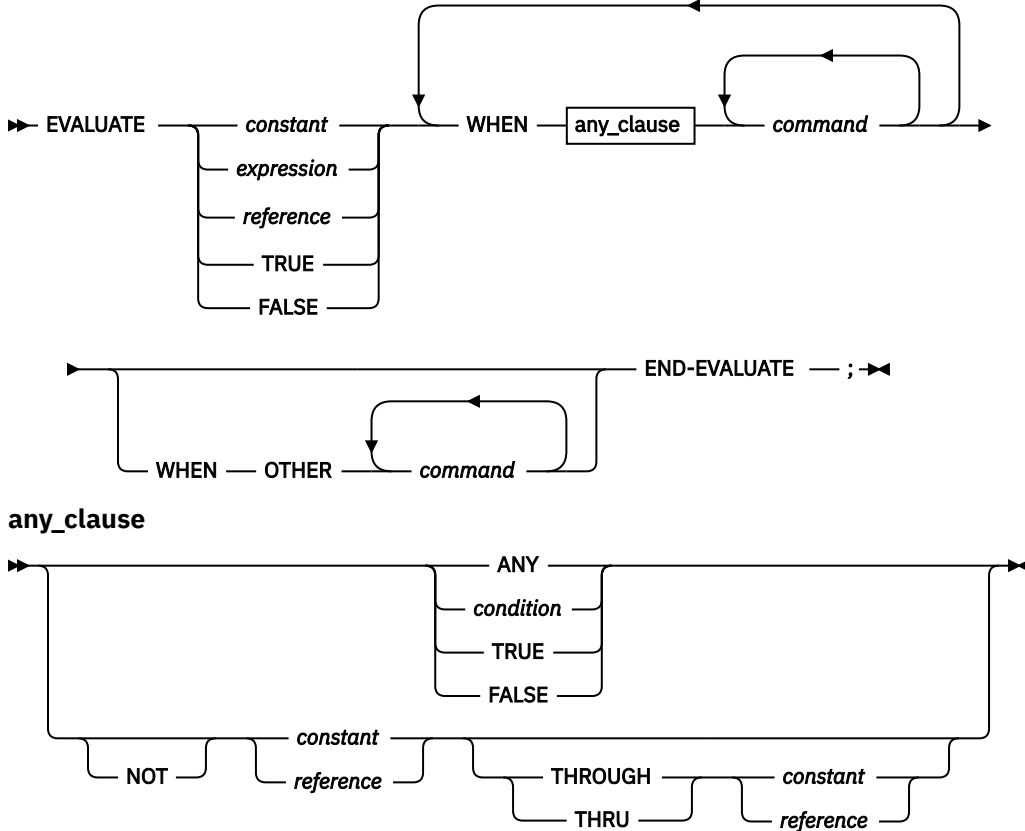

Expression command (C and C++)

The Expression command evaluates the given expression.

➤ *expression* — ;➤

FIND command

The FIND command helps you search through the Source window in full-screen and batch mode, and through the Log and Monitor windows in full-screen mode.

➤ **FIND** ➔

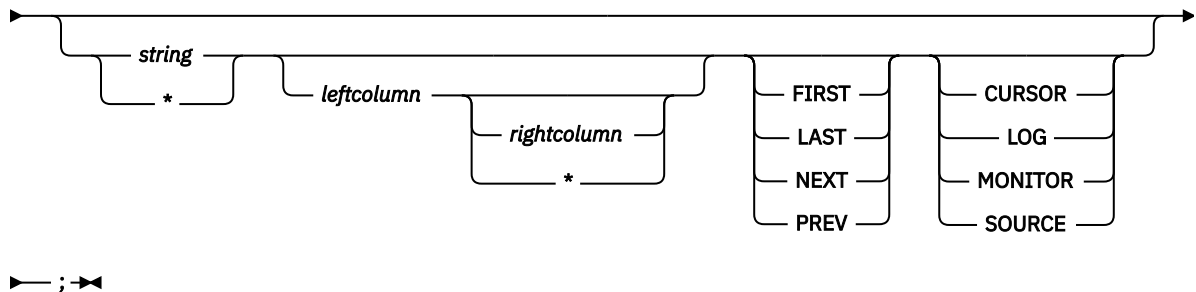

FINDBP command

The FINDBP command provides full-screen search capability for line, statement and offset breakpoints in the source object.

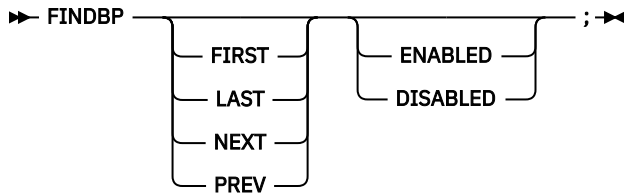

for command (C and C++)

The for command provides iterative looping similar to the C and C++ for statement.

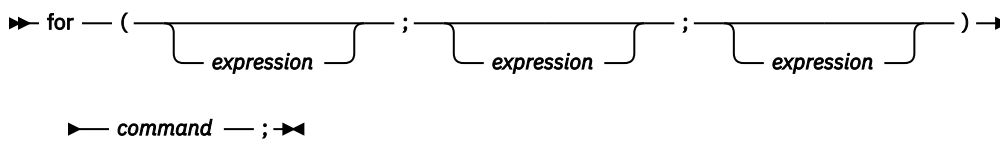

FREE command

The FREE command releases a file that is currently allocated.

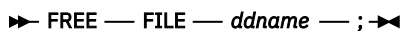

GO command

The GO command causes z/OS Debugger to start or resume running your program.

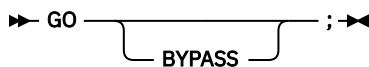

GOTO command

The GOTO command causes z/OS Debugger to resume program execution at the specified statement id.



GOTO LABEL command

The GOTO LABEL command causes z/OS Debugger to resume program execution at the specified statement label. The specified label must be in the same block. If you want z/OS Debugger to return control to you at the target location, make sure there is a breakpoint at that location.

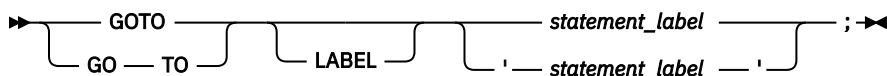

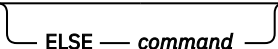

%IF command (programming language neutral)

The %IF command enables you write conditional statements that can be run in any supported programming language.

►► %IF — *condition* — THEN — *command* —  ELSE — *command* — ; ►►

IF command (assembler, disassembly, and LangX COBOL)

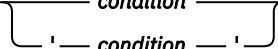
The IF command lets you conditionally perform a command.

►► IF —  *condition* — THEN — *command* —  ELSE — *command* — ; ►►



if command (C and C++)

The if command lets you conditionally perform a command.

►► if — (— *expression* —) — *command* —  else — *command* — ; ►►

IF command (COBOL)

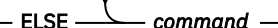
The IF command lets you conditionally perform a command.

►► IF — *condition* —  THEN — *command* —  ELSE — *command* —  END-IF — ; ►►

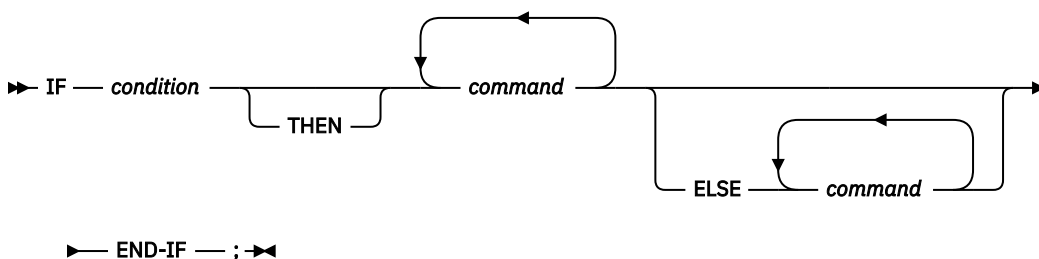

IF command (PL/I)

The IF command lets you conditionally perform a command.

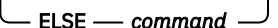
►► IF — *expression* — THEN — *command* —  ELSE — *command* — ; ►►

IMMEDIATE command (full-screen mode)

The IMMEDIATE command causes a command within a command list to be performed immediately.

►► IMMEDIATE — *command* — ; ►►

INPUT command (C and C++ and COBOL)

The INPUT command provides data for an intercepted read and is valid only when there is a read pending for an intercepted file.

▶▶ INPUT — *text* — ; ▶▶

JUMPTO command

The JUMPTO command moves the resume point to the specified statement but does not resume the program.

▶▶ JUMPTO — *statement_id* — ; ▶▶
JUMP TO

JUMPTO LABEL command

The JUMPTO command moves the resume point to the specified label but does not resume the program.

▶▶ JUMPTO — *statement_label* — ; ▶▶
JUMP TO LABEL ' *statement_label* '

LIST (blank)

Displays the Source Identification panel, where associations are made between source listings or source files shown in the source window and their program units.

LIST AT

Lists the currently defined breakpoints, including the action taken when the specified breakpoint is activated.

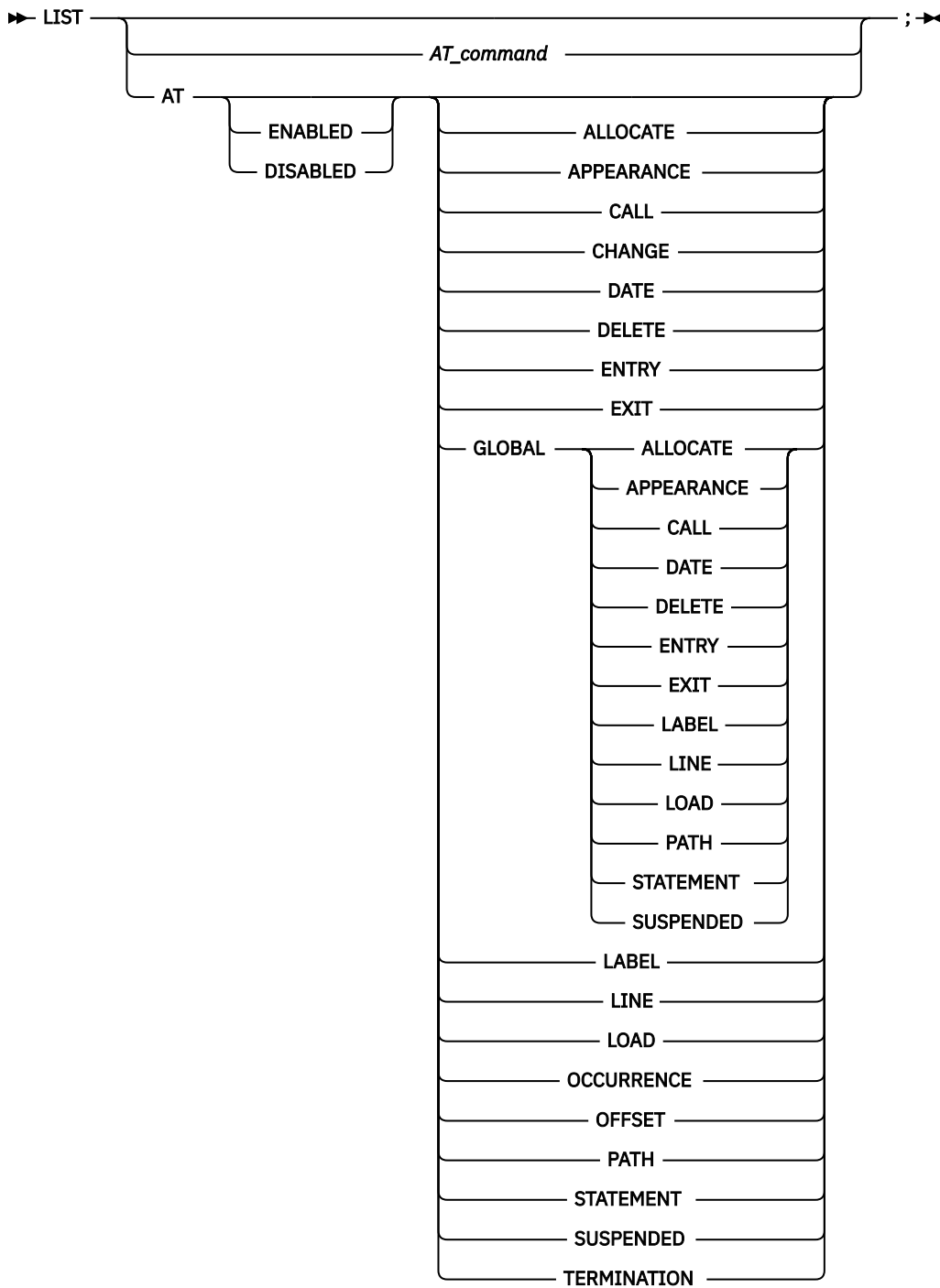

LIST AT (remote)

Lists the currently defined AT GLOBAL LABEL or AT LABEL breakpoints.

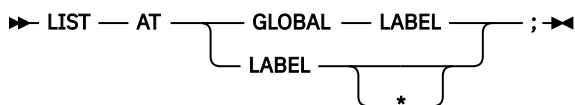

LIST CALLS

Displays the dynamic chain of active blocks.

►► LIST — CALLS — ; ►►

LIST CC command

Lists code coverage data.

►► LIST — CC —

}	NOTEXECUTED	}	NOSOURCE	}	; ►►
	EXECUTED		SOURCE		
	ALL				

LIST CONTAINER

Displays the contents of a CICS container.

►► LIST — CONTAINER —

}	channel_name	}	container_name	►

►

}	(— index —)	}
	(— sub_string_start — : — sub_string_end —)	
	(— sub_string_start — :: — sub_string_length —)	

►

}	XML	}	; ►►			
				(EBCDIC)
					ASCII	
				CODEPAGE	(— ccsid —)	

LIST CURSOR (full-screen mode)

Provides a cursor controlled method for displaying variables, structures, and arrays.

►► LIST —

}	CURSOR	}

 ; ►►

LIST DTCN

List the programs and compile units that were disabled by the DISABLE command.

►► LIST — DTCN — ; ►►

LIST expression

Displays values of expressions.

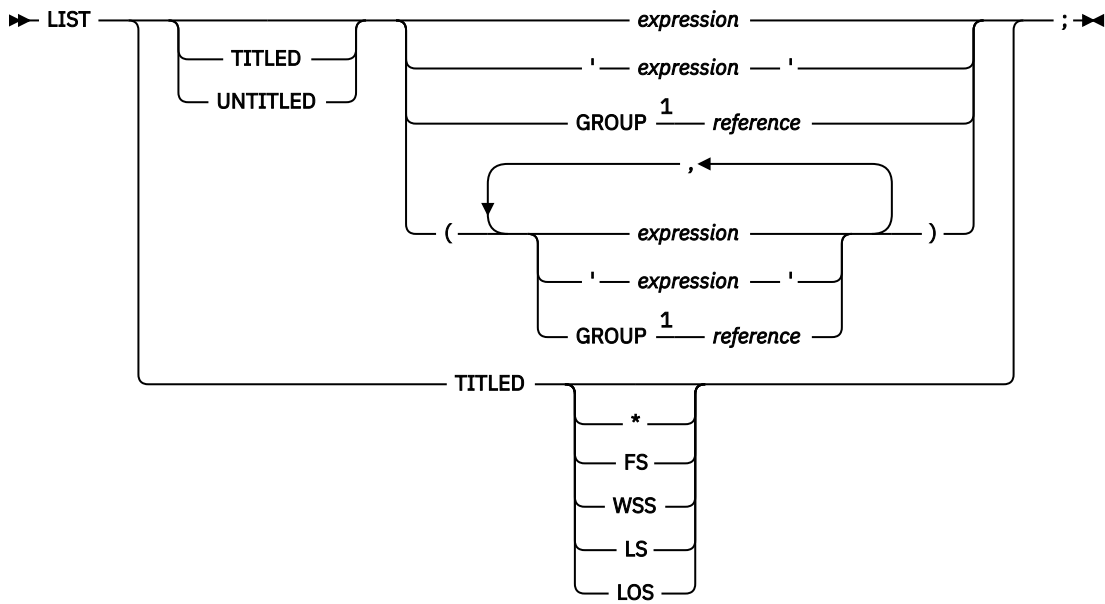

Notes:

¹ Only for COBOL.

L expression prefix

Entered through the prefix area of the Source window, displays the value of a variable or variables on that line.

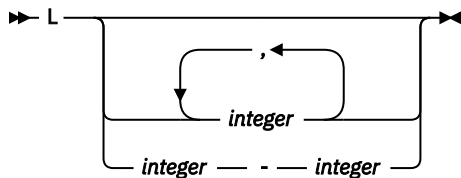

LIST FREQUENCY

Lists statement execution counts.

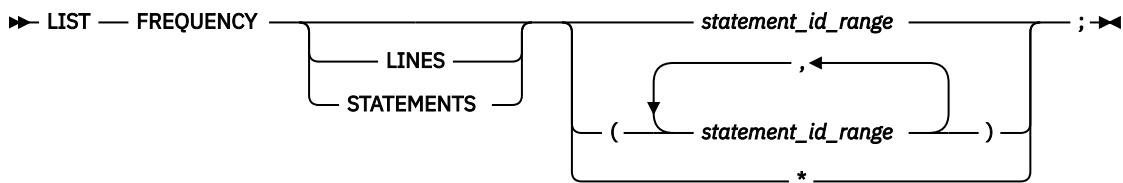

LIST LAST

Displays a list of recent entries in the history table.

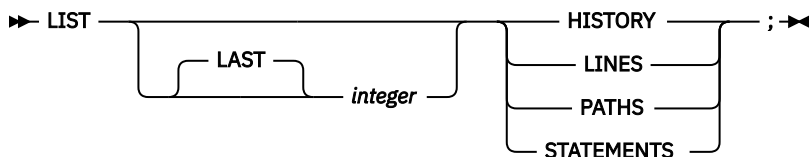

LIST LDD

Displays the list of LDD commands known to z/OS Debugger.

➤ LIST — LDD — ; ➤

LIST LINE NUMBERS

Equivalent to LIST STATEMENT NUMBERS.

LIST LINES

Equivalent to LIST STATEMENTS.

LIST MONITOR

Lists all or selected members of the current set of MONITOR commands.

➤ LIST — MONITOR — *integer* — — — *integer* — ; ➤

LIST NAMES

Lists the names of variables, programs, or z/OS Debugger procedures.

➤ LIST — NAMES — *pattern* — ➤

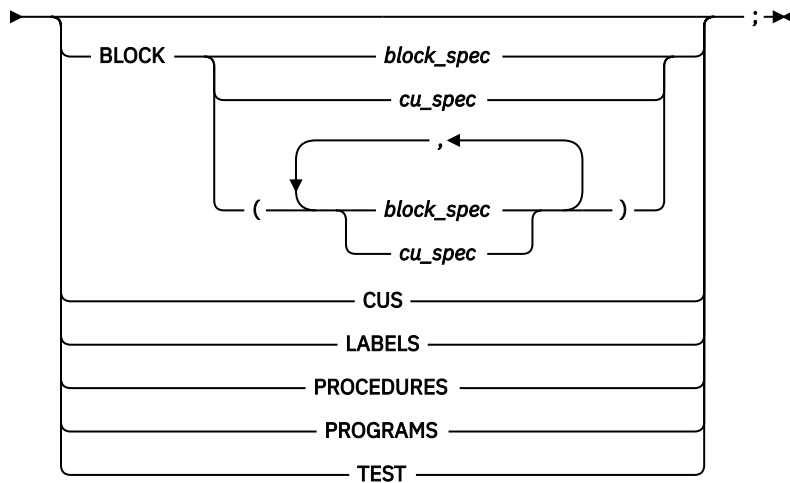

LIST NAMES LABELS (remote)

Displays the names of all section and paragraph names in a COBOL program, and the names of all instruction labels in an assembler program.

➤ LIST — NAMES — LABELS — ; ➤

LIST ON (PL/I)

Lists the action (if any) currently defined for the specified PL/I conditions.

►► LIST — ON — *pli_condition* ; ►►

LIST PROCEDURES

Lists the commands contained in the specified z/OS Debugger PROCEDURE definitions.

►► LIST — PROCEDURES — *name* ; ►►
(*name* , *name*)

LIST REGISTERS

Displays the current register contents.

►► LIST — *32BIT* — REGISTERS — ; ►►
64BIT
LONG — FLOATING — *REGISTERS*
SHORT

LIST STATEMENT NUMBERS

Lists all statement or line numbers that are valid locations for an AT LINE or AT STATEMENT breakpoint.

►► LIST — *LINE* — NUMBERS — *block_spec* ; ►►
STATEMENT — *cu_spec*
statement_id_range

LIST STATEMENTS

Lists one or more statements or lines from a file.

►► LIST — *LINES* — *statement_id_range* ; ►►
STATEMENTS

LIST STORAGE

Displays the contents of storage at a particular address in hex format.

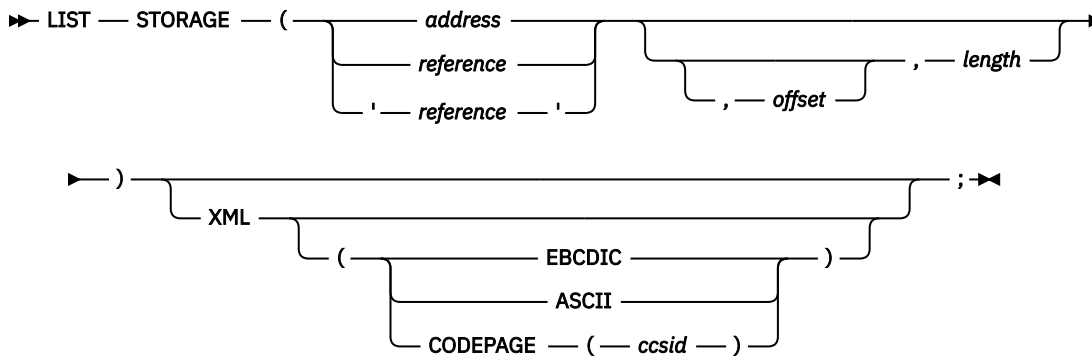

LIST TRACE LOAD command

Displays the entries in the TRACE LOAD table that is created since the TRACE LOAD START command was issued.

```
LIST TRACE LOAD ;
```

LOAD command

Specifies to load the named module using MVS LOAD services, EXEC CICS LOAD, or the Language Environment enclave-level load service for debugging purposes.

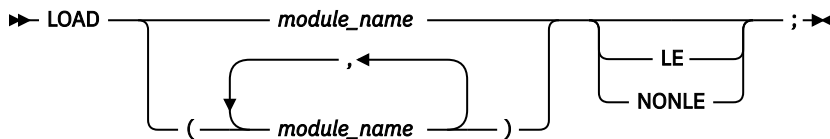

LOADDEBUGDATA (LDD)

The LOADDEBUGDATA (LDD) command requests that z/OS Debugger load the debug data for a compile unit in either of the following situations:

- The CU was written in assembler or LangX COBOL.
- Explicit debug mode is active and the CU was written in a Language Environment enabled, high-level language and compiled with the TEST or DEBUG compiler option.

LDD for assembler or LangX COBOL CU

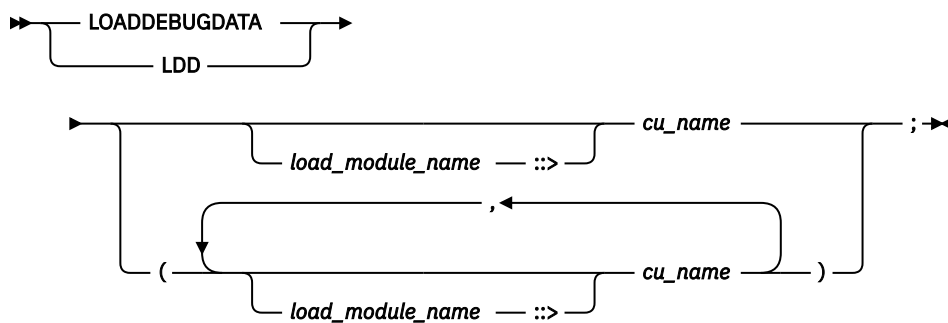

LDD for high-level language CU in explicit debug mode

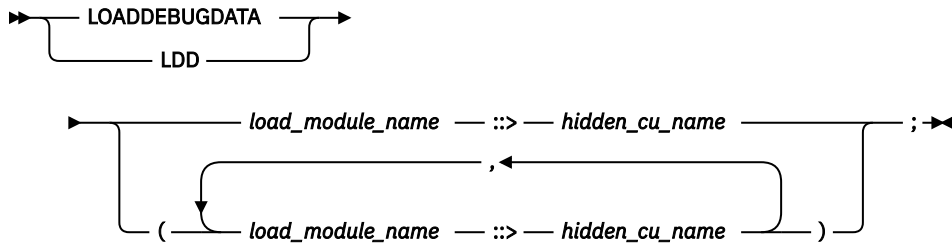

MEMORY

Identifies an address in memory and then display the contents of memory at that location in the Memory window. The Memory window displays memory in dump format.

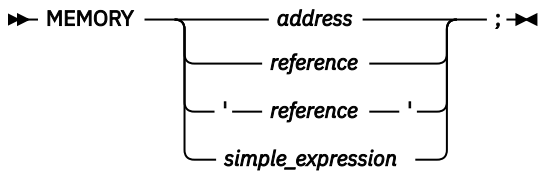

M prefix command

The M prefix command, which you enter through the prefix area of the Source window, adds variables on that line to the Monitor window.

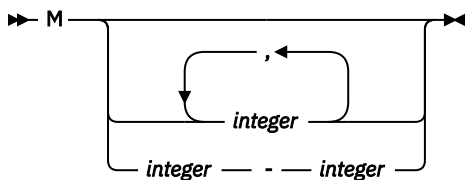

MONITOR command

The MONITOR command defines or redefines a command whose output is displayed in the monitor window (full-screen mode), terminal output (line mode), or log file (batch mode).

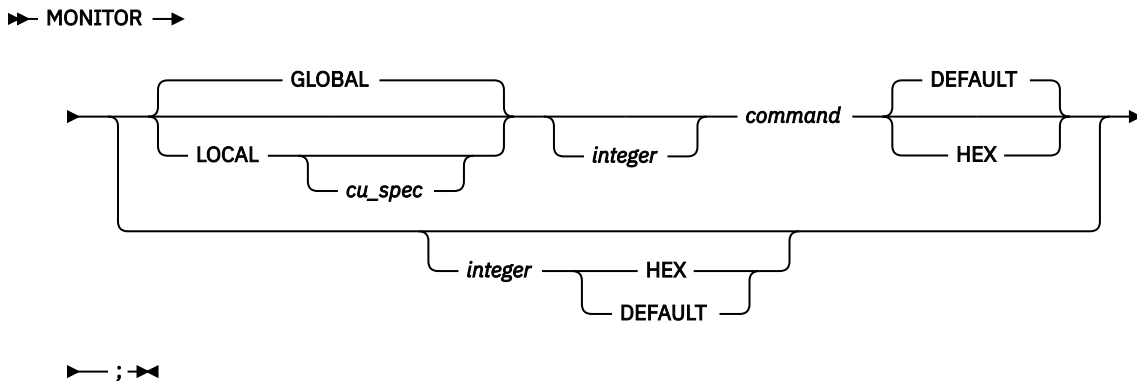

MOVE command (COBOL)

The MOVE command transfers data from one area of storage to another.

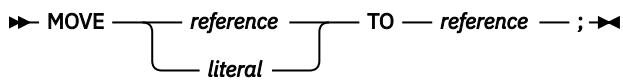

NAMES DISPLAY command

Use the NAMES DISPLAY command to indicate that you want a list of all the load modules or compile units that are currently excluded or included. If you do not specify the ALL parameter, only the names excluded by user commands appear in the list that is displayed. Names that z/OS Debugger excludes by default are not included in the list that is displayed.

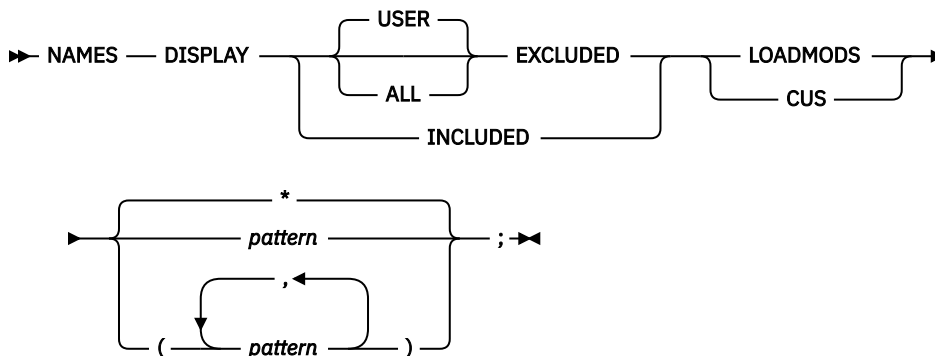

NAMES EXCLUDE command

The NAMES EXCLUDE command enables you to indicate to z/OS Debugger the names of load modules or compile units that you do not need to debug. If these are data-only modules, z/OS Debugger does not process them. If they contain executable code, z/OS Debugger might process them in some cases. See "Optimizing the debugging of large applications" in the IBM z/OS Debugger User's Guide for more information about these situations.

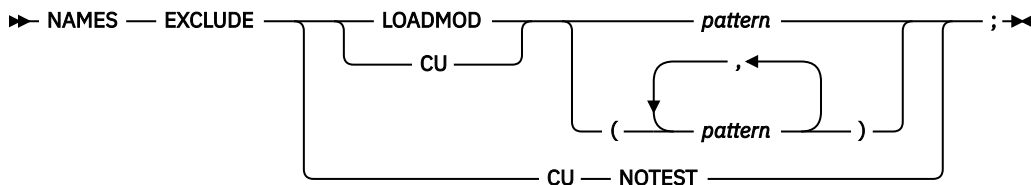

NAMES INCLUDE command

Use the NAMES INCLUDE command to indicate to z/OS Debugger that your program is a user load module or compile unit, not a system program. See "Debugging user programs that use system prefix names" in the IBM z/OS Debugger User's Guide for more information.

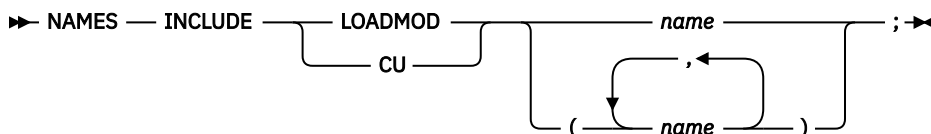

Null command

The Null command is a semicolon written where a command is expected.

`;>`

ON command (PL/I)

The ON command establishes the actions to be executed when the specified PL/I condition is raised.

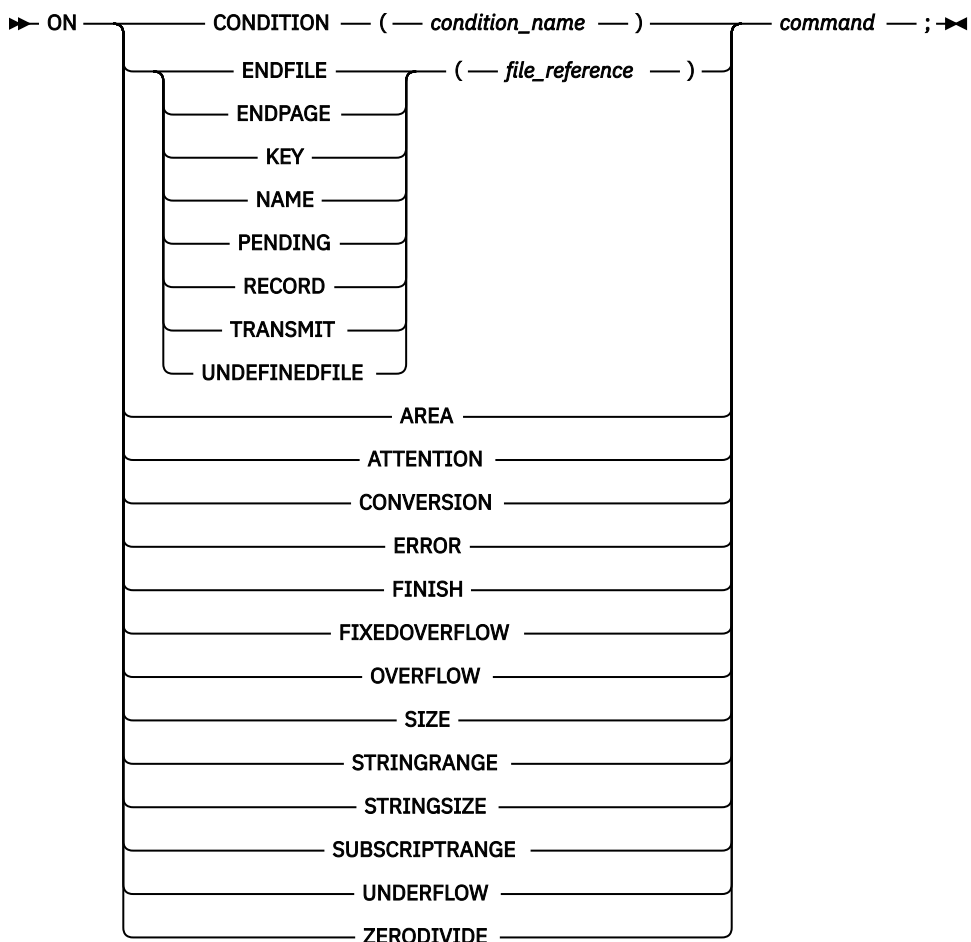

PANEL command (full-screen mode)

The PANEL command displays special panels.

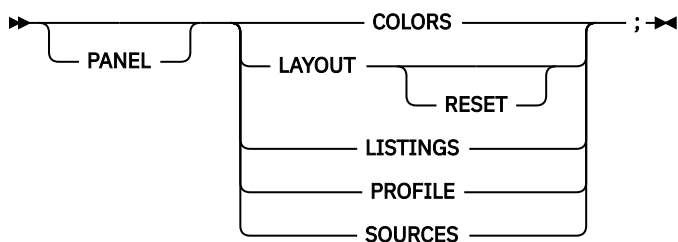

PERFORM command (COBOL)

The PERFORM command transfers control explicitly to one or more statements and implicitly returns control to the next executable statement after execution of the specified statements is completed.

Simple:

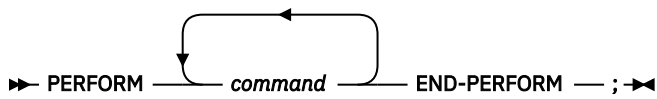

Repeating:

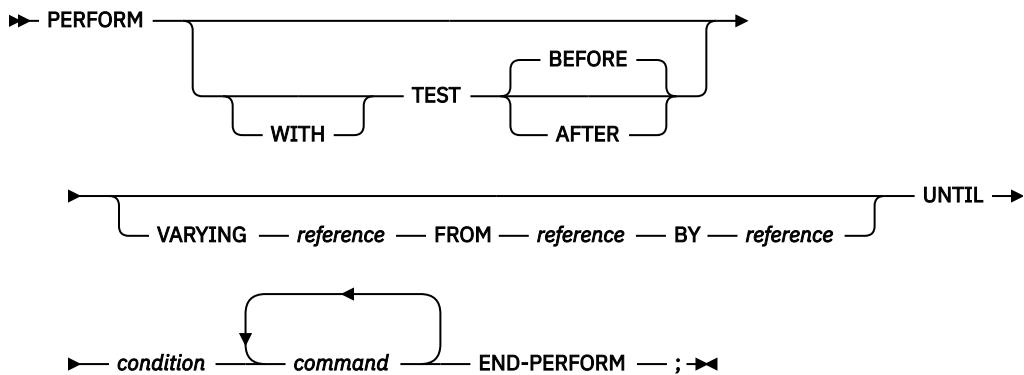

PLAYBACK BACKWARD command

The `PLAYBACK BACKWARD` command indicates to z/OS Debugger to perform `STEP` and `RUNTO` commands backward, starting from the current point and going to previous points.



PLAYBACK DISABLE command

The `PLAYBACK DISABLE` command informs z/OS Debugger to stop recording runtime environment information and discard any information recorded thus far.

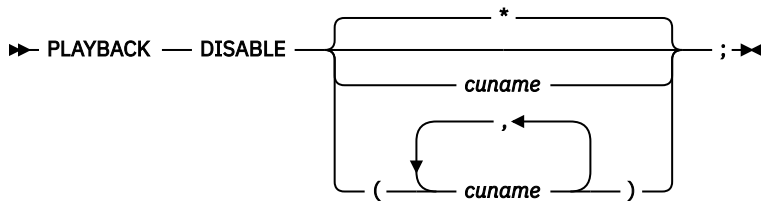

PLAYBACK ENABLE command

The `PLAYBACK ENABLE` command informs z/OS Debugger to begin recording the application runtime environment information (steps history and data history).

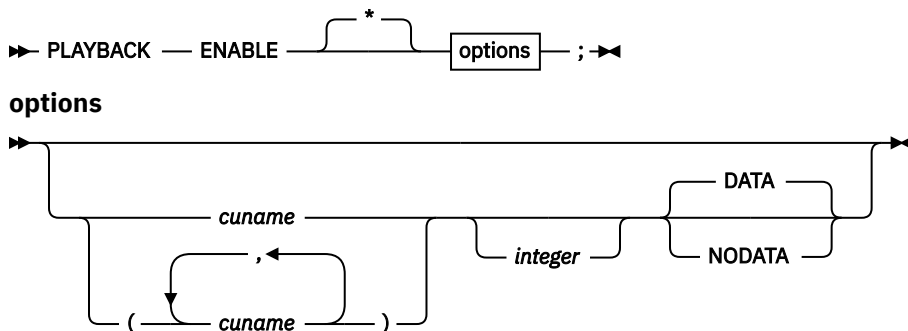

PLAYBACK FORWARD command

The PLAYBACK FORWARD command indicates to z/OS Debugger to perform STEP and RUNTO commands forward, starting from the current point and going to the next point.

▶▶ PLAYBACK — FORWARD — ; ▶▶

PLAYBACK START command

The PLAYBACK START command suspends normal debugging and informs z/OS Debugger to replay the steps it recorded.

▶▶ PLAYBACK — START — ; ▶▶

PLAYBACK STOP command

The PLAYBACK STOP command stops replaying recorded statements and resumes normal debugging at the point where the PLAYBACK START command was entered.

▶▶ PLAYBACK — STOP — ; ▶▶

POPUP command

Displays the Command pop-up window, where you can type in multiline commands.

▶▶ POPUP — *integer* — ; ▶▶

POSITION command

Positions the cursor to a specific line in the specified window.

▶▶ POSITION — *integer* —

CURSOR
LOG
MONITOR
SOURCE

 — ; ▶▶

Prefix commands (full-screen mode)

The Prefix commands apply only to source listing lines and are typed into the prefix area in the source window. For details, see the section corresponding to the command name.

The following table summarizes the forms of the Prefix commands.

Example	Description
"AT Prefix (full-screen mode)" on page 7	Defines a statement breakpoint through the Source window prefix area.
"CLEAR prefix (full-screen mode)" on page 12	Clears a breakpoint through the Source window prefix area.

Example	Description
"DISABLE prefix (full-screen mode)" on page 18	Disables a breakpoint through the Source window prefix area.
"ENABLE prefix (full-screen mode)" on page 19	Enables a disabled breakpoint through the Source window prefix area.
"LIST expression" on page 25	Displays the value of a variable or variables on that line.
"QUERY prefix (full-screen mode)" on page 38	Queries what statements have breakpoints through the Source window prefix area.
"RUNTO prefix command (full-screen mode)" on page 39	Runs the program to the location that the cursor or statement identifier indicate in the Source window prefix area.
"SHOW prefix command (full-screen mode)" on page 51	Specifies what relative statement or verb within the line is to have its frequency count shown in the suffix area.

PROCEDURE command

The PROCEDURE command allows the definition of a group of commands that can be accessed by using the CALL procedure command.

```

▶▶ name — : — PROCEDURE — ; —  command — END — ; —▶▶

```

QUALIFY RESET

This command is equivalent to SET QUALIFY RESET.

QUERY command

The QUERY command displays the current value of the specified z/OS Debugger setting, the current setting of all the z/OS Debugger settings, or the current location in the suspended program.

```

▶▶ QUERY — Attributes A through I — Attributes J through P — Attributes Q through Z — ; —▶▶

```

Attributes A through I

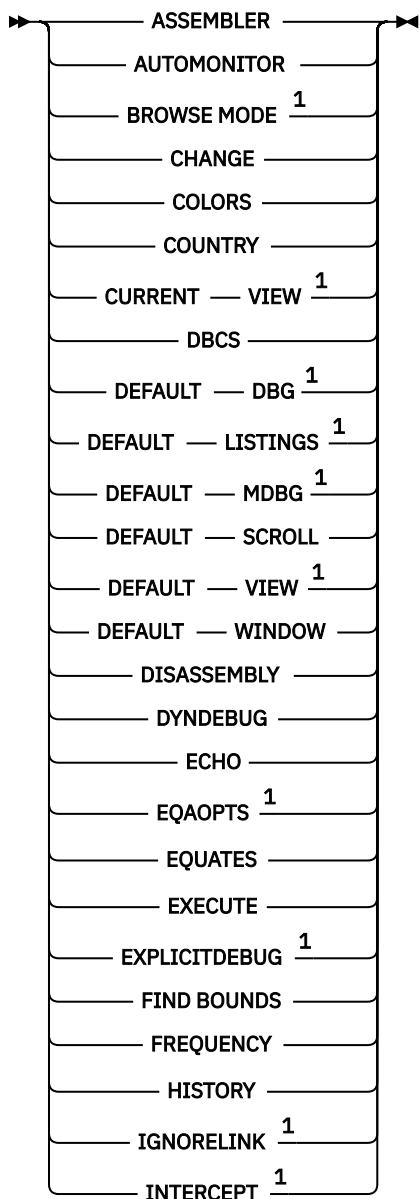

Attributes J through P

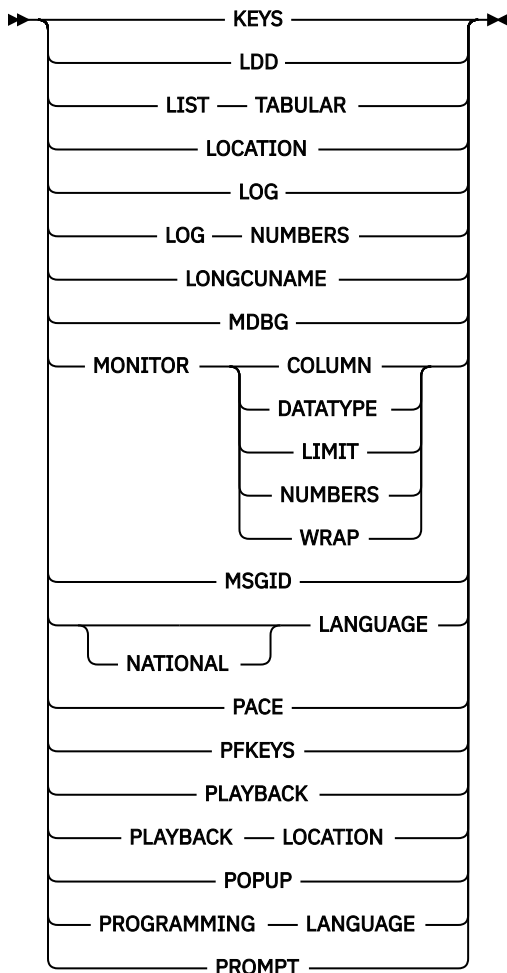

Attributes Q through Z

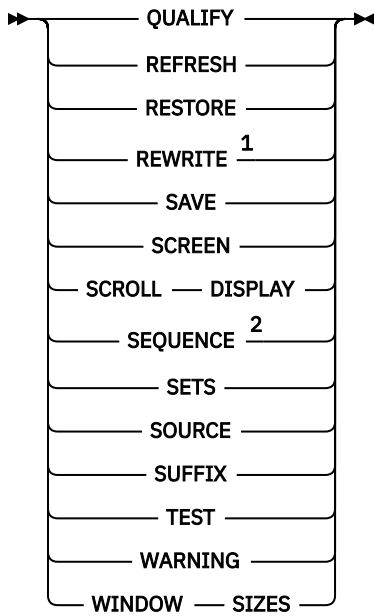

Notes:

- ¹ You can use this command in remote debug mode.
- ² Only for PL/I.

QUERY prefix (full-screen mode)

Queries what statements on a particular line have statement breakpoints when you issue this command through the Source window prefix area.

►► QUERY — ; ►►

QUIT command

The QUIT command ends a z/OS Debugger session and if an expression is specified, sets the return code.

►► QUIT — (— *expression* —) ; ►►
 ABEND
 DEBUG
 TASK

QQUIT command

The QQUIT command ends a z/OS Debugger session without further prompting.

►► QQUIT — ; ►►

RESTORE command

The RESTORE command enables you to explicitly restore the settings, breakpoints, and monitor specifications that were previously saved by the SET SAVE AUTO command when z/OS Debugger terminated.

►► RESTORE — SETTINGS ; ►►
 BPS
 MONITORS
 BPS — MONITORS
 MONITORS — BPS

RETRIEVE command (full-screen mode)

The RETRIEVE command displays the last command entered on the command line.

►► RETRIEVE — COMMAND ; ►►

RUN command

The RUN command is synonymous to the GO command.

RUNTO command

The RUNTO command runs your program to a valid executable statement without setting a breakpoint.

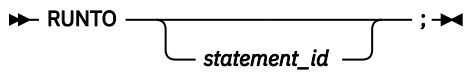

RUNTO prefix command (full-screen mode)

Runs to the statement when you issue this command through the Source window prefix area.

SCROLL command (full-screen mode)

The SCROLL command provides horizontal and vertical scrolling in full-screen mode.

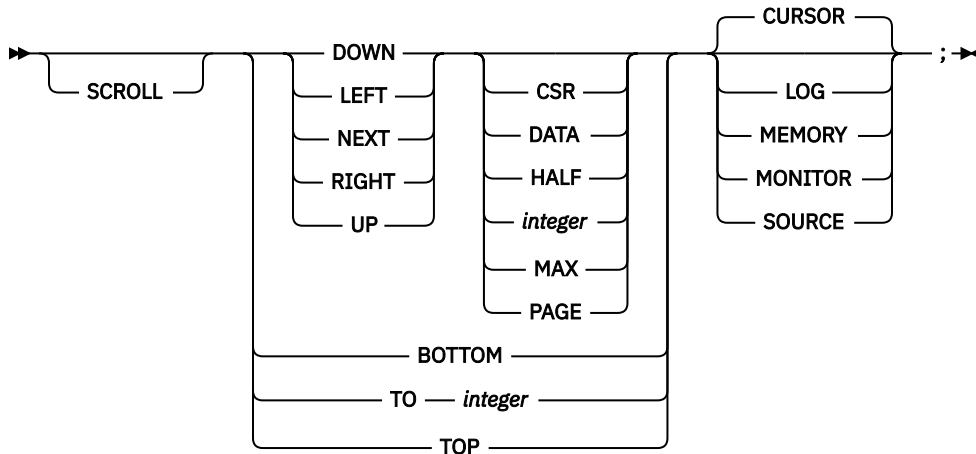

SELECT command (PL/I)

The SELECT command chooses one of a set of alternate commands.

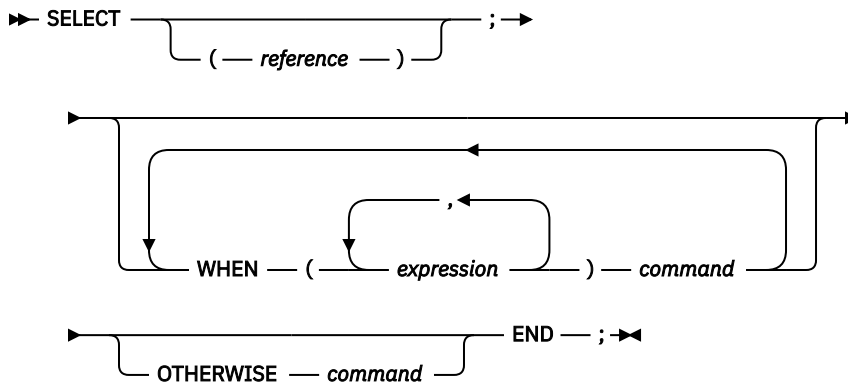

SET ASSEMBLER ON/OFF

The SET ASSEMBLER ON/OFF command displays additional information that is useful when you debug an assembler program.

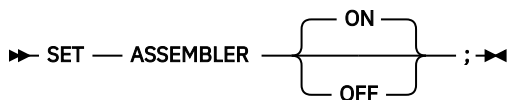

SET ASSEMBLER STEPOVER

The SET ASSEMBLER STEPOVER command specifies how z/OS Debugger processes STEP OVER commands in assembler compile units.



SET AUTOMONITOR

Controls the monitoring of data items at the statement that z/OS Debugger runs next, ran most recently, or both.

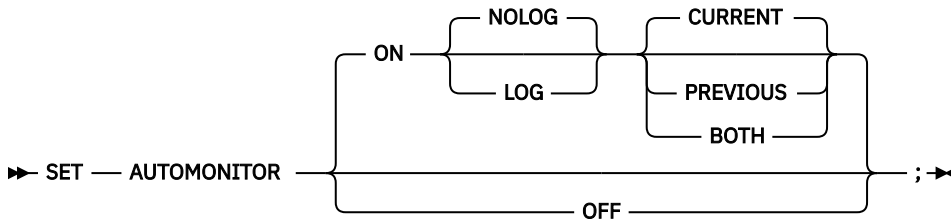

SET CHANGE

Controls the frequency of checking the AT CHANGE breakpoints.

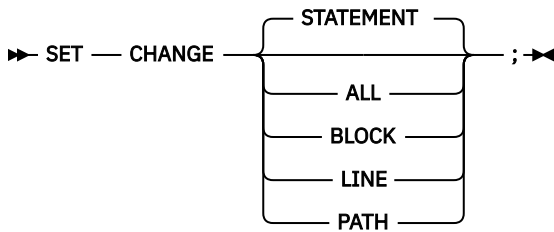

SET COLOR (full-screen and line mode)

Provides control of the color, highlighting, and intensity attributes when the SCREEN setting is ON.



color_attributes

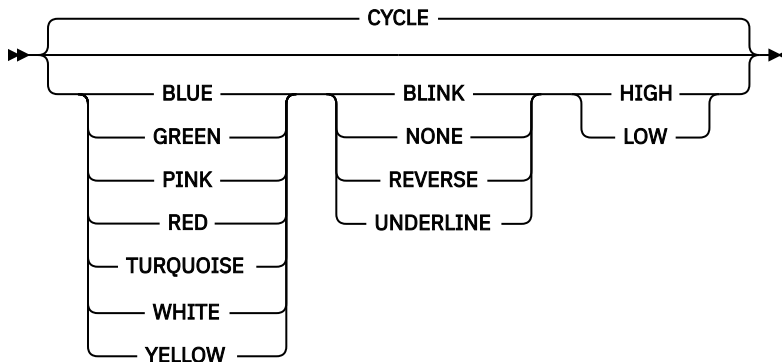

UI_elements

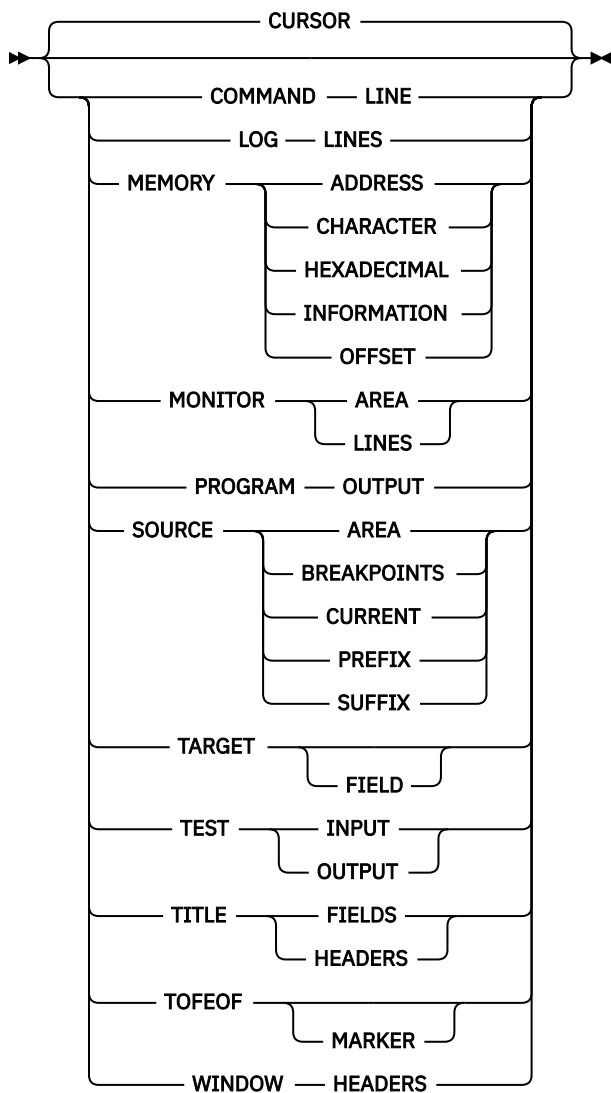

SET COUNTRY

Changes the current national country setting for the application program.

➤ SET COUNTRY *country_code* ; ➤

SET DBCS

Controls whether shift-in and shift-out codes are interpreted on input and supplied on DBCS output.

➤ SET DBCS { ON / OFF } ; ➤

SET DEFAULT DBG

Defines a default partitioned data set DD name or DS name that z/OS Debugger searches through to locate the .dbg files.

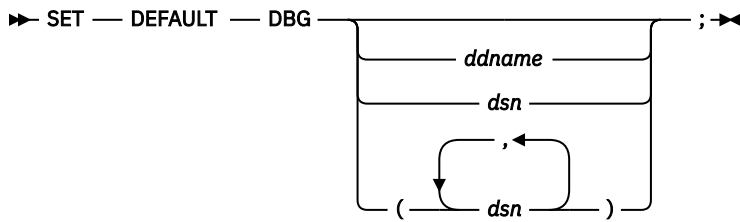

SET DEFAULT LISTINGS

Defines a default partitioned data set DD name or DS name whose members are searched for program source, listings, or separate debug files.

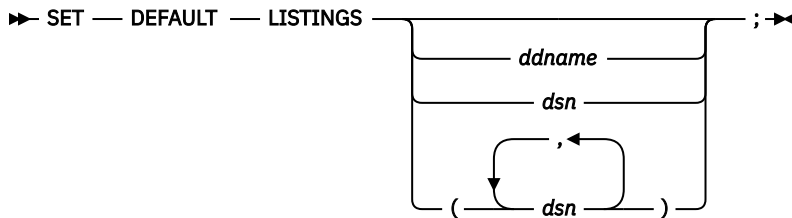

SET DEFAULT MDBG

Defines a default partitioned data set DD name or DS name that z/OS Debugger searches through to locate the .mdbg files.

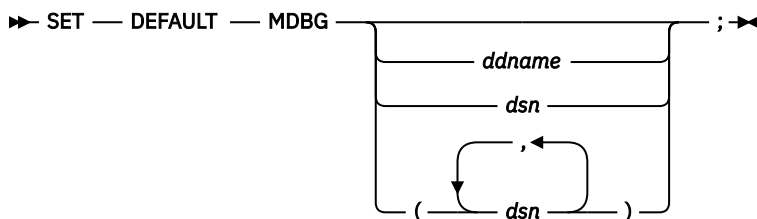

SET DEFAULT SCROLL (full-screen mode)

Sets the default scroll amount that is used when a SCROLL command is issued without the amount specified.

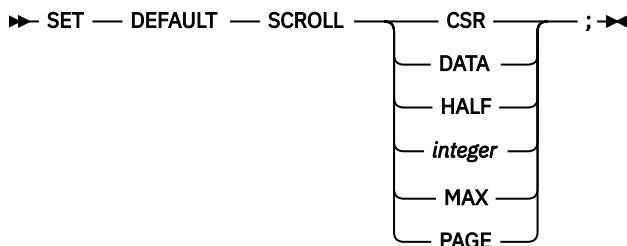

SET DEFAULT VIEW

Controls the default view for assembler compile units.

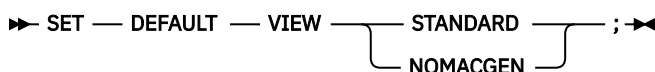

SET DEFAULT WINDOW (full-screen mode)

Specifies what window is selected when a window referencing command (for example, FIND, SCROLL, or WINDOW) is issued without explicit window identification and the cursor is outside the window areas.

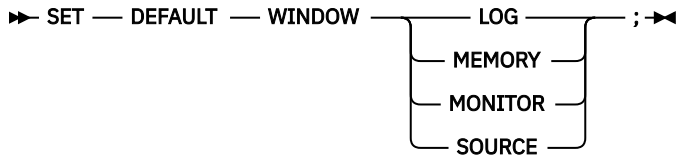

SET DISASSEMBLY

Controls whether the disassembly view is displayed in the Source window.



SET DYNDEBUG

Controls whether to activate the Dynamic Debug facility.

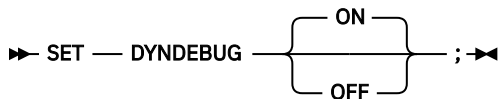

SET ECHO

Controls whether GO and STEP commands are recorded in the log window when they are not subcommands.

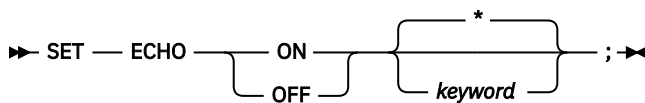

SET EQUATE

Equates a symbol to a string of characters.



SET EXECUTE

Controls whether commands from all input sources are performed or just syntax checked (primarily for checking USE files).

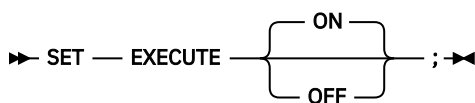

SET EXPLICITDEBUG

Controls whether explicit debug mode is active.

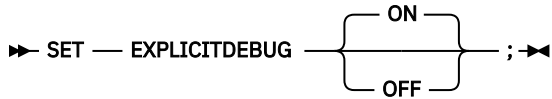

SET FIND BOUNDS

Specifies the default left and right columns for a FIND command in the Source window and in line mode that does not specify any columns information.

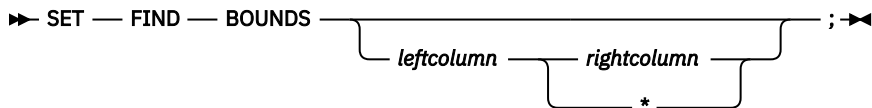

SET FREQUENCY

Controls whether statement executions are counted.

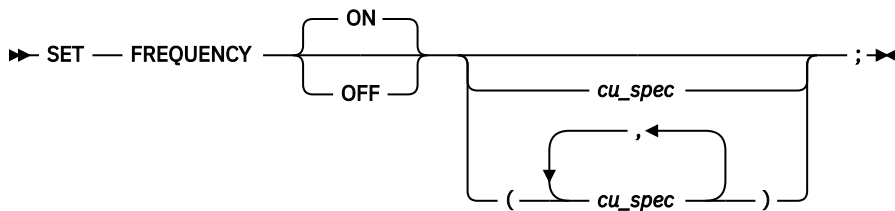

SET HISTORY

Specifies whether entries to z/OS Debugger are recorded in the history table and optionally adjusts the size of the table.

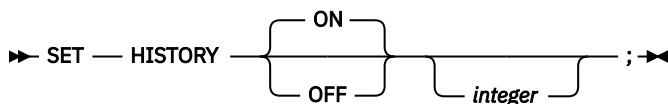

SET IGNORELINK

Specifies that any new LINK level (nested enclave) is ignored while the setting is ON.



SET INTERCEPT (C and C++)

Intercepts input to and output from specified files.

►► SET — INTERCEPT — { ON / OFF } — FILE — *file_spec* — ; ►►

SET INTERCEPT (COBOL, full-screen mode, line mode, batch mode)

Intercepts input to and output from the console.

►► SET — INTERCEPT — { ON / OFF } — CONSOLE — ; ►►

SET INTERCEPT (COBOL, remote debug mode)

Intercepts output from COBOL DISPLAY statements.

►► SET — INTERCEPT — { ON / OFF } — ; ►►

SET KEYS (full-screen and line mode)

Controls whether PF key definitions are displayed when the SCREEN setting is ON.

►► SET — KEYS — { ON / OFF } — { 12 / 24 } — ; ►►

SET LDD

Controls how debug data is loaded for assemblies containing multiple CSECTs.

►► SET — LDD — { SINGLE / ALL } — ; ►►

SET LIST BY SUBSCRIPT command (COBOL)

Controls whether z/OS Debugger displays elements in an array as they are stored in memory.

►► SET — LIST — BY — SUBSCRIPT — { ON / OFF } — ; ►►

SET LIST BY SUBSCRIPT command (Enterprise PL/I, full-screen mode only)

Controls whether z/OS Debugger displays elements in an array as they are stored in memory.

► SET — LIST — BY — SUBSCRIPT — { ON / OFF } ; ►

SET LIST TABULAR

Controls whether to format the output of the LIST command in a tabular format.

► SET — LIST — TABULAR — { OFF / ON } ; ►

SET LOG

Controls whether each command that z/OS Debugger runs and the output of that command is stored in the log file. Defines (or redefines) the name and location of the file and whether the information is appended to an existing file or is written over existing information.

► SET — LOG — { ON / OFF } ; ►

ON — FILE — *fileid* — { OLD / MOD } — OFF

KEEP — *count*

SET LOG NUMBERS (full-screen and line mode)

Controls whether line numbers are shown in the log window.

► SET — LOG — NUMBERS — { ON / OFF } ; ►

SET LONGCUNAME (C, C++, and PL/I)

Controls whether the CU name is displayed in short or long format.

► SET — LONGCUNAME — { ON / OFF } ; ►

SET MDBG (C, C++)

Associates a .mdbg file to one load module or DLL.

► SET — MDBG — (*lm_spec*) — *fileid* — ; ►

SET MONITOR (full-screen and line mode)

Controls the format and layout of variable names and values displayed in the Monitor window.

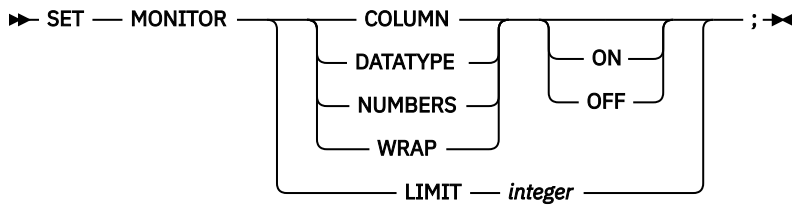

SET MSGID

Controls whether the z/OS Debugger messages are displayed with the message prefix identifiers.

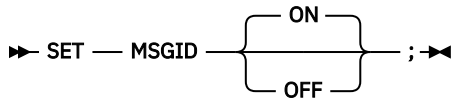

SET NATIONAL LANGUAGE

Switches your application to a different runtime national language that determines what translation is used when a message is displayed.



SET PACE

Specifies the maximum speed (in steps per second) of animated execution.

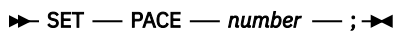

SET PFKEY

Associates a z/OS Debugger command with a Program Function key (PF key).



SET POPUP

Controls the number of lines displayed in the Command pop-up window.

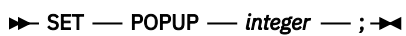

SET PROGRAMMING LANGUAGE

Sets the current programming language.

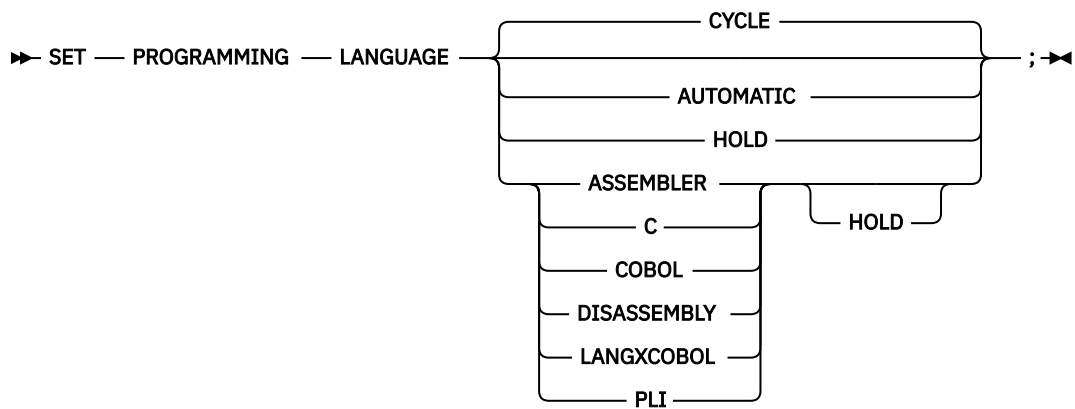

SET PROMPT (full-screen and line mode)

Controls whether the current program location is automatically shown as part of the prompt message in line mode.

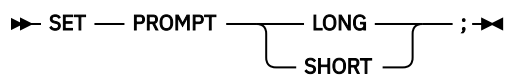

SET QUALIFY

Simplifies the identification of references and statement numbers by resetting the point of view to a new block, compile unit, or load module.

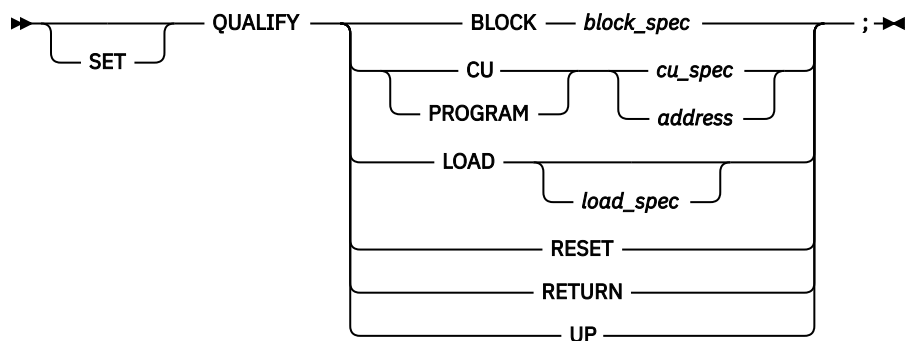

SET REFRESH (full-screen mode)

Controls screen refreshing.

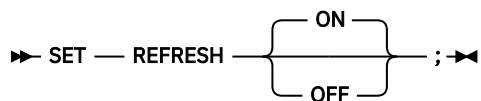

SET RESTORE

Controls the restoring of settings, breakpoints, and monitor specifications.

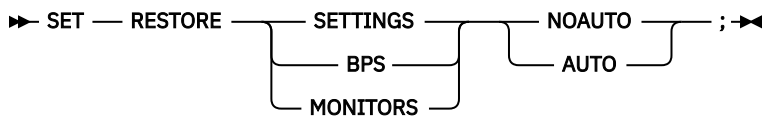

SET REWRITE (full-screen mode)

Forces a periodic screen rewrite during long sequences of output.



SET REWRITE (remote debug mode)

Sets the maximum number of COBOL DISPLAY statements that the remote debugger displays in the Debug Console.



SET SAVE

Controls the saving of settings, breakpoints, and monitor specifications.

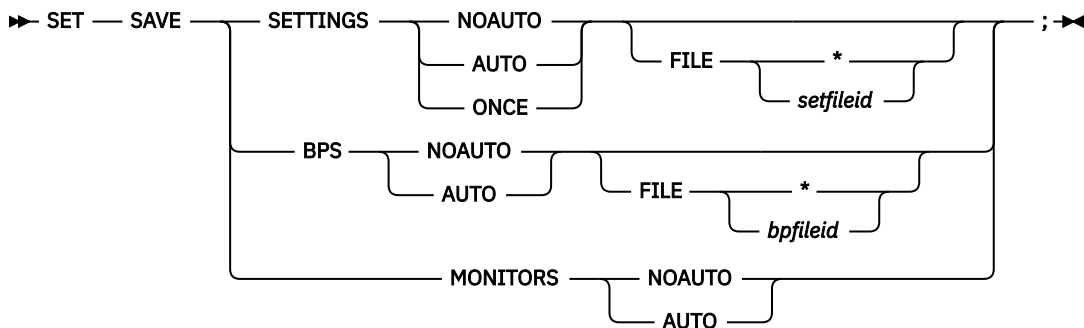

SET SCREEN (full-screen and line mode)

Controls how information is displayed on the screen.

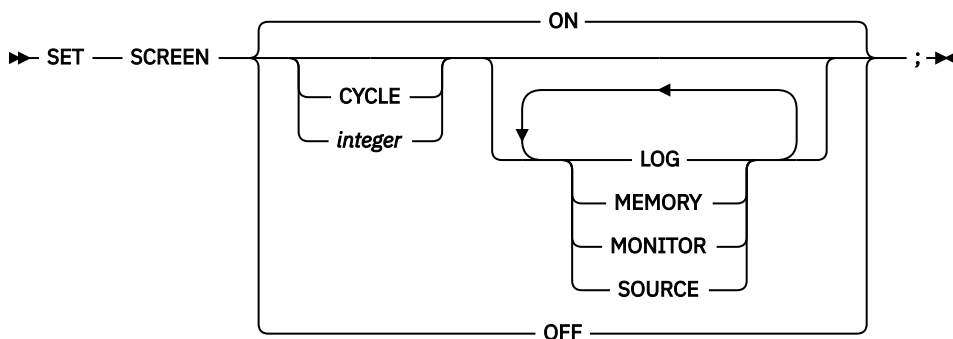

SET SCROLL DISPLAY (full-screen mode)

Controls whether the scroll field is displayed when operating in full-screen mode.



SET SEQUENCE (PL/I)

Controls whether z/OS Debugger interprets data after column 72 in a commands or preference file as a sequence number.



SET SOURCE

Associates a source file, compiler listing or separate debug file with one or more compile units.

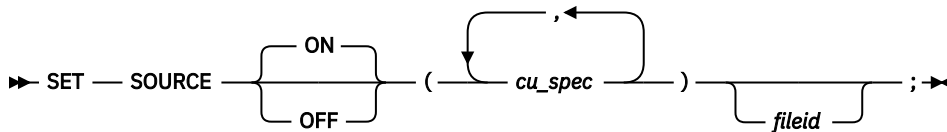

SET SUFFIX (full-screen mode)

Controls the display of frequency counts at the right edge of the Source window when in full-screen mode.

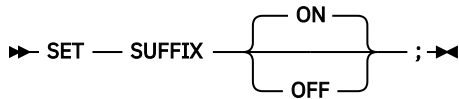

SET TEST

Overrides the initial TEST runtime options specified at invocation.

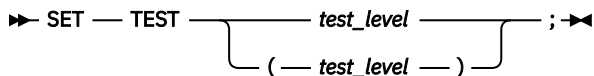

SET WARNING (C, C++, and PL/I)

Controls display of the z/OS Debugger warning messages and whether exceptions are reflected to the application program.

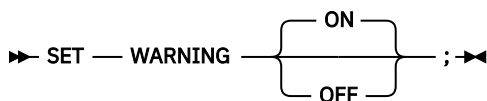

SET command (COBOL)

The SET command assigns a value to a COBOL reference.

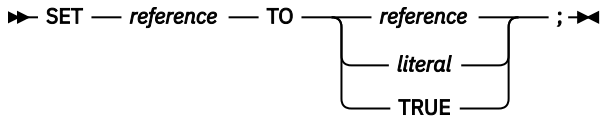

SHOW prefix command (full-screen mode)

The SHOW prefix command specifies what relative statement (for C) or relative verb (for COBOL) within the line is to have its frequency count temporarily shown in the suffix area.

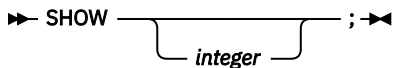

STEP command

The STEP command causes z/OS Debugger to dynamically step through a program, executing one or more program statements. In full-screen mode, it provides animated execution.

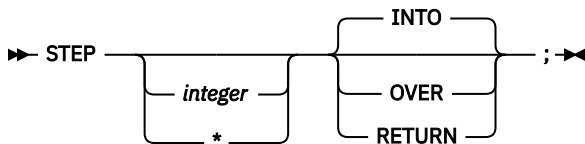

STORAGE command

The STORAGE command enables you to alter up to eight bytes of storage.

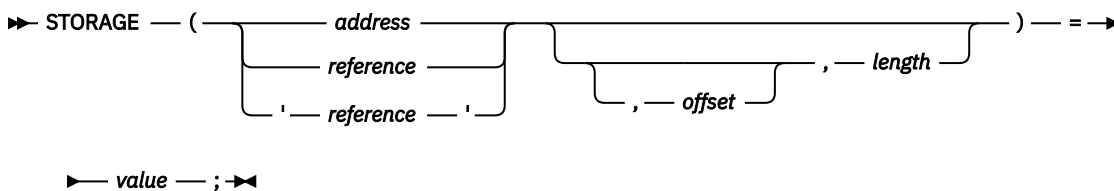

switch command (C and C++)

The switch command enables you to transfer control to different commands within the switch body, depending on the value of the switch expression.

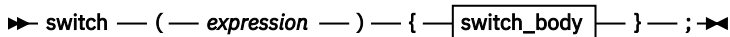

switch_body

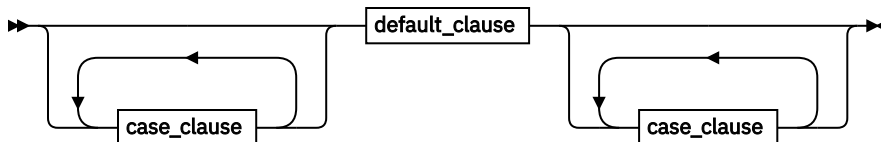

case_clause

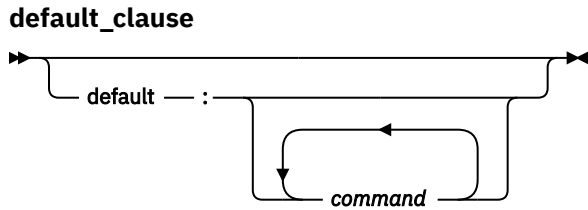
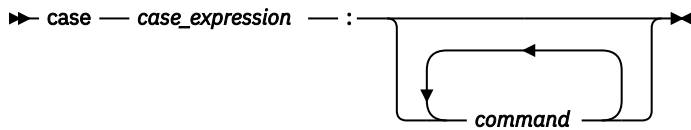

SYSTEM command

The SYSTEM command lets you issue TSO commands during a z/OS Debugger session.

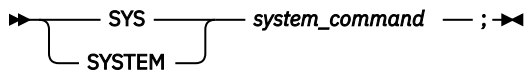

TRACE command

The TRACE command creates a trace of all load modules and DLLs loaded during a debug session. The trace can then be listed at any point during the debug session.

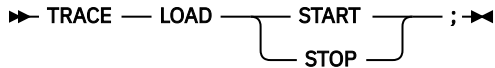

TRIGGER command

The TRIGGER command raises the specified AT-condition in z/OS Debugger, or it raises the specified programming language condition in your program.

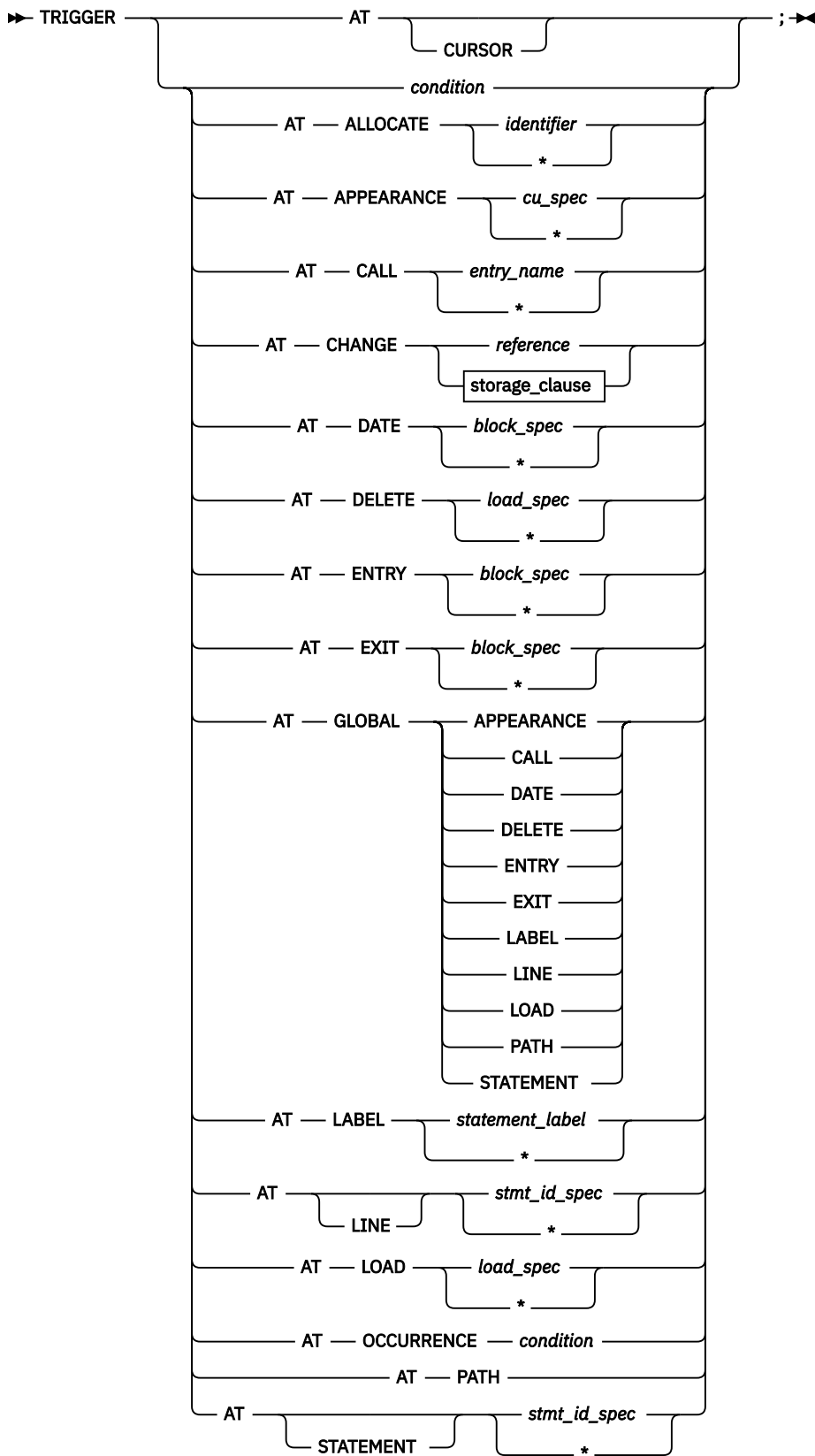

storage_clause

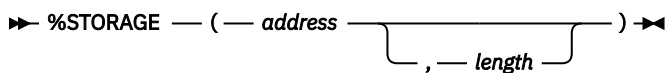

TSO command (z/OS)

The TSO command lets you issue TSO commands during a z/OS Debugger session and is valid only in a TSO environment.

➤ TSO — *tso_command* — ; ➤

USE command

The USE command causes the z/OS Debugger commands in the specified file or data set to be either performed or syntax checked.

➤ USE — *ddname* — ; ➤
 — *dsname* —

while command (C and C++)

The while command enables you to repeatedly perform the body of a loop until the specified condition is no longer met or evaluates to false.

➤ while — (— *expression* —) — *command* — ; ➤

WINDOW CLOSE

Closes the specified window in the z/OS Debugger full-screen session panel.

➤ — *WINDOW* — CLOSE — *CURSOR* — ; ➤
 — LOG —
 — MEMORY —
 — MONITOR —
 — SOURCE —

WINDOW OPEN

Opens a previously-closed window in the z/OS Debugger full-screen session panel.

➤ — *WINDOW* — OPEN — *LOG* — ; ➤
 — MEMORY —
 — MONITOR —
 — SOURCE —

WINDOW SIZE

Controls the relative size of currently visible windows in the z/OS Debugger full-screen session panel.

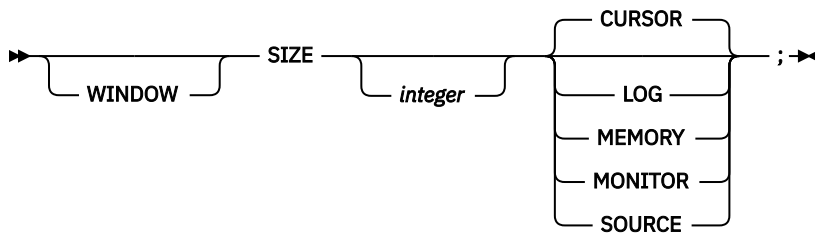

WINDOW SWAP

Replaces the logical window being displayed in a physical window with another logical window. The order of the operands is not important.

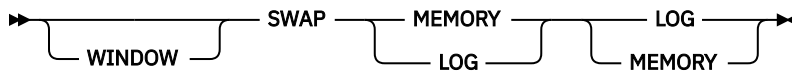

WINDOW ZOOM

Expands the indicated window to fill the entire screen or restores the screen to the currently defined window configuration.

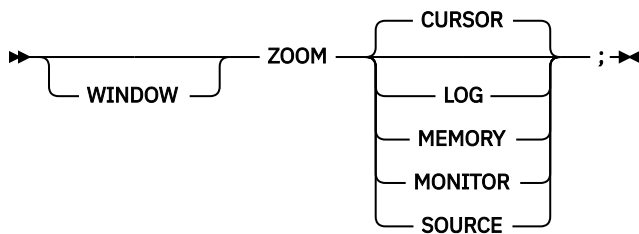

Chapter 2. z/OS Debugger built-in functions

z/OS Debugger provides you with the following built-in functions:

%CHAR (assembler, disassembly, and LangX COBOL)

Returns the EBCDIC character value of an operand.

%DEC (assembler, disassembly, and LangX COBOL)

Returns the decimal value of an operand.

%GENERATION (PL/I)

Returns a specific generation of a controlled variable in your program.

%HEX

Returns the hexadecimal value of an operand.

%INSTANCES (C, C++, and PL/I)

Returns the maximum value of %RECURSION (the most recent recursion number) for a given block.

%RECURSION (C, C++, and PL/I)

Returns a specific instance of an automatic variable or a parameter in a recursive procedure.

%WHERE (assembler, disassembly, and LangX COBOL)

Returns a string that is the address of the operand. %WHERE can be used *only* as the outermost expression in the LIST command.

Chapter 3. EQAOPTS commands (optional)

The EQAOPTS commands (formerly known as options) alter certain z/OS Debugger behaviors. This topic summarizes the syntax of the EQAOPTS commands, followed by a list briefly describing each command. For a complete description of each command and to learn how to use these commands, see *IBM z/OS Debugger Customization Guide* and *IBM z/OS Debugger Reference and Messages*.

The follow diagram describes the syntax of the EQAOPTS commands:

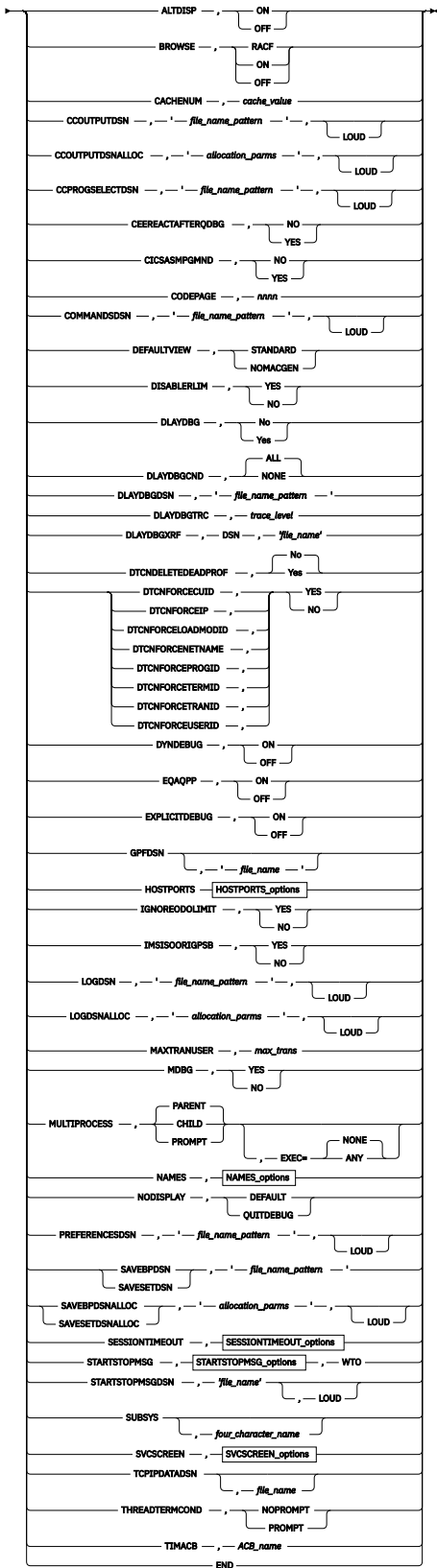

HOSTPORTS_options

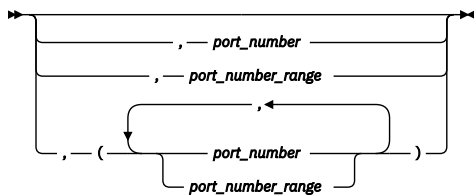

NAMES_options

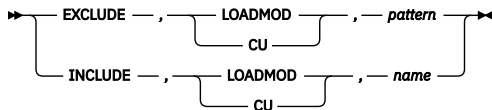

SESSIONTIMEOUT_options

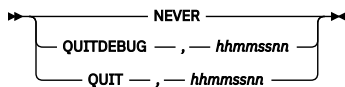

SVCSCREEN_options

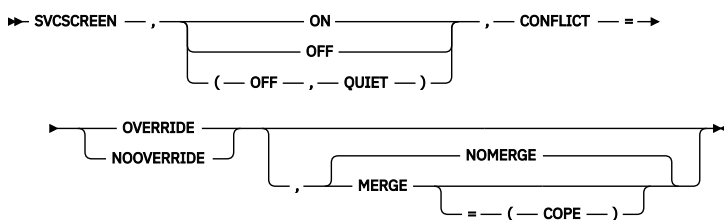

STARTSTOPMSG_options

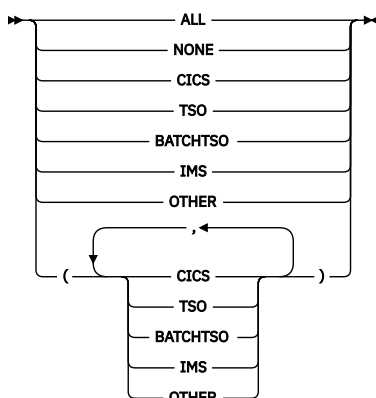

ALTDISP

Specifies whether to add a character indicator to indicate a breakpoint, the current line, or the line with found text. This command is valid only when you are using interactive MFI mode.

BROWSE

Specifies whether a user with sufficient RACF® authority to the applicable browse mode RACF facility can start z/OS Debugger in browse mode.

CACHENUM

Specifies the maximum number of program items to be held in an in-memory cache for a debug session. Increase this number to improve performance for applications which have many programs; however, a larger number also increases the storage usage by the debugged task.

CCOUTPUTDSN

Provides the data set name to be used for the Code Coverage Observation file. Specify NULLFILE if no Observation file is to be written to. You can also choose whether to display WTO messages that helps you debug processing done by this command.

CCOUTPUTDSNALLOC

Creates the CCOUTPUTDSN data set for a new user and provides the allocation parameters (in BPXWDYN format). You can also choose whether to display WTO messages that helps you debug processing done by this command.

CCPROGSELECTDSN

Provides the data set name that contains the Code Coverage Options file (which specifies the Group IDs and the PROGRAM IDs of the COBOL routines that are to be processed). Specify NULLFILE if no Code Coverage Options file is to be read. You can also choose whether to display WTO messages that helps you debug processing done by this command.

CEEREAFTERAFTERQDBG

Specifies whether to restart z/OS Debugger with CEETEST after you use QUIT DEBUG to end a debug session.

CICSASMPGMND

Controls whether z/OS Debugger allows debugging assembler programs when the language attribute of the program resource is not defined.

CODEPAGE

Indicates which code page to use so that NLS characters are properly communicated between z/OS Debugger and a remote debugger and properly displayed in full screen mode.

COMMANDSDSN

Indicates the naming pattern z/OS Debugger uses to locate the data set containing a commands file. z/OS Debugger reads a member from this commands file every time it starts.

DEFAULTVIEW

Provides a method of setting the initial value for the SET DEFAULT VIEW command.

DISABLERLIM

Controls whether z/OS Debugger disables Omegamon Resource Limiting (RLIM) during debug sessions in a CICS region.

DLAYDBG

Enables z/OS Debugger to delay the starting of a debug session until z/OS Debugger recognizes a certain program (CU).

DLAYDBGEND

Indicates whether you want z/OS Debugger to monitor condition events in the delay debug mode.

DLAYDBGDSN

Indicates that z/OS Debugger is to use the specified naming pattern when it constructs the delay debug profile data set name.

DLAYDBGTRC

Indicates that z/OS Debugger is to generate a trace during the pattern match process in the delay debug mode. z/OS Debugger uses the WTO (write to operator) command to output the trace.

DLAYDBGXRF

Indicates that you want z/OS Debugger to use the cross reference file to find the user ID when it constructs the delay debug profile data set name.

DTCNDELETEDEADPROF

Controls the deletion of DTCN profiles. A dead profile is a profile whose owner has logged off or disconnected from the CICS region.

DTCNFORCExxxx

Controls DTCN behavior for the conditions described in [Table 4 on page 63](#). When you set a DTCNFORCExxxx option to YES, DTCN forces users to specify the respective resource type. The default setting is NO.

EQAOPTS DTCNFORCExxxx command	DTCN field name
DTCNFORCECUID or DTCNFORCEPROGID	CU
DTCNFORCEIP	IP Name/Address
DTCNFORCELOADMODID	LoadMod
DTCNFORCENETNAME	NetName
DTCNFORCETERMID	Terminal Id
DTCNFORCETRANID	Transaction Id
DTCNFORCEUSERID	User Id

Related tasks

"Requiring users to specify resource types" in the *IBM z/OS Debugger Customization Guide*

DYNDEBUG

Controls the initial default for the SET DYNDEBUG command.

EQAQPP

Indicates the presence of Q++ programs.

EXPLICITDEBUG

Controls whether explicit debug mode is active.

GPFDSN

Specifies the data set name for the global preferences file.

HOSTPORTS

Specifies a host port or range of ports to use for a TCP/IP connection from the host to a workstation when using remote debug mode.

IGNOREODOLIMIT

Instructs z/OS Debugger to display COBOL table data items even when an ODO value is out of range.

IMSISSOORIGPSB

Instructs the IMS Transaction Isolation Facility to preserve the original PSB of the transaction when a message is routed to a private message processing region. This command is deprecated. It is accepted for compatibility but has no effect. The original PSB is always preserved.

LOGDSN

Indicates the naming pattern z/OS Debugger uses to locate the data set containing a log file.

LOGDSNALLOC

Indicates the allocation parameters z/OS Debugger uses to create the data set named by the LOGDSN command.

MAXTRANUSER

Defines the maximum number of IMS transactions that a single user can register using the IBM Transaction Isolation Facility.

MDBG

For z/OS XL C/C++, Version 1 Release 11, if you have compiled with the `DEBUG (FORMAT (DWARF))` compiler option, specifies whether z/OS Debugger obtains debug data from `.mdbg` or `.dbg` files.

MULTIPROCESS

Controls the behavior of z/OS Debugger when a new POSIX process is created by a `fork()` or `exec()` function in the application.

It instructs z/OS Debugger to perform any of the following tasks when a new POSIX process is created:

- Continue debugging the current process. The current process is also referred to as the PARENT process.
- Stop debugging the current process and start debugging the newly created process. The newly created process is also referred to as the CHILD process.
- Prompt you to decide whether to follow the PARENT or CHILD process.

NAMES

Provides a method of entering NAMES commands that apply before the first load module and any of the compile units contained in that load module are processed.

NODISPLAY

Controls z/OS Debugger behavior when the terminal using full-screen mode using the Terminal Interface Manager or the remote debugger are not available.

PREFERENCESDSN

Indicates the naming pattern z/OS Debugger uses to locate the data set containing a preferences file. z/OS Debugger reads this preferences file every time it starts.

SAVEBPDSN and SAVESETDSN

Specifies the data set names to be used to save the breakpoints (SAVEBPDSN) and settings (SAVESETDSN). One qualifier in each of these data set names should be &&USERID, which represents the user ID of the current user.

SAVEBPDSNALLOC and SAVESETDSNALLOC

Indicates the allocation parameters z/OS Debugger uses to create the data sets named by the SAVEBPDSN and SAVESETDSN commands.

SESSIONTIMEOUT

Establishes a timeout for idle z/OS Debugger sessions

STARTSTOPMSG

Controls whether to issue a message when each debugging session is initiated or terminated.

STARTSTOPMSGDSN

Indicates that you want z/OS Debugger to write a message in the message file when the debug session is started or stopped.

SUBSYS

Provides a 1 to 4 character subsystem name. If an Enterprise PL/I or C/C++ source file is found to have a DSORG of DA or VSAM and this parameter is supplied, then this parameter is passed to SVC 99 (dynamic allocation) through the SUBSYS text unit when z/OS Debugger allocates the source file.

SVCSCREEN

Controls z/OS Debugger's enablement of SVC screening.

TCPIPDATA DSN

Instructs z/OS Debugger to dynamically allocate the specified *file-name* to DDNAME SYSTCPD (if SYSTCPD is not already allocated).

THREADTERMCOND

Specifies whether z/OS Debugger should suppress the prompt it displays when the thread termination condition, FINISH condition, or CEE067 is raised by Language Environment.

TIMACB

Specifies an alternate Terminal Information Manager ACB name.

Related tasks

"Running the Terminal Interface Manager on more than one LPAR on the same VTAM® network" in the *IBM z/OS Debugger Customization Guide*

END

Identifies the last EQAOPTS command. You must always specify this command and make it the last command in the input stream.

Chapter 4. z/OS Debugger variables

The following table summarizes the z/OS Debugger variables. For more information about these variables, see *IBM z/OS Debugger Reference and Messages*.

z/OS Debugger variable	Value
%ADDRESS	Address of the location where your program was interrupted
%AMODE	Current [®] AMODE of the suspended program
%BLOCK	Name of the current block
%CAAADDRESS	Address of the CAA control block associated with the suspended program
%CC	(Assembler and disassembly only) Condition code from current PSW
%CONDITION	Name or number of the condition when z/OS Debugger is entered because of an AT OCCURRENCE
%COUNTRY	Current country code
%CU	Name of the primary entry point of the current compile unit
%EPA	Address of the primary entry point in the current compile unit
%EPAR _n or %EPRH _n	(Assembler, disassembly, C and C++, and PL/I only) Extended-precision floating-point registers
%EPRB _n	(Assembler and disassembly only) Extended-precision floating-point registers in binary format
%EPRD _n	(Assembler and Disassembly only) Extended-precision floating-point registers in decimal format
%FPR _n or %FPRH _n	Single-precision floating-point registers in hexadecimal format
%FPRB _n	(Assembler and Disassembly only) Single-precision floating-point registers in binary format
%FPRD _n	(Assembler and Disassembly only) Single-precision floating-point registers in decimal format
%GPR _n	32-bit base General Purpose Registers at the point of interruption in a program
%GPRG _n	64-bit General Purpose Registers at the point of interruption in a program
%GPRH _n	32-bit high General Purpose Registers at the point of interruption in a program
%HARDWARE	Type of hardware where the application is running
%LINE or %STATEMENT	Current source line number
%LOAD	Name of the load module of the current program, or an asterisk (*)
%LPR _n or %LPRH _n	Double-precision floating-point registers in hexadecimal format
%LPRB _n	(Assembler and Disassembly only) Double-precision floating-point registers in binary format

z/OS Debugger variable	Value
%LPRD <i>n</i>	(Assembler and Disassembly only) Double-precision floating-point registers in decimal format
%NLANGUAGE	National language currently in use
%PATHCODE	Integer identifying the type of change occurring when the program flow reaches a point of discontinuity, and the path condition is raised
%PLANGUAGE	Current programming language
%PROGMASK	(Assembler and disassembly only) Program mask from current PSW
%PROGRAM	Equivalent to %CU
%PSW	(Assembler and disassembly only) Current Program Status Word
%RC	Return code from the most recent z/OS Debugger command
%RSTDSETS	A value of 1 if user settings have been restored and 0 otherwise
%RUNMODE	String identifying the presentation mode of z/OS Debugger
%R <i>n</i>	32-bit base General Purpose Registers for the currently qualified assembler or disassembly CU
%STATEMENT	Equivalent to %LINE
%SUBSYSTEM	Name of the underlying subsystem, if any, where the program is running
%SYSTEM	Name of the operating system supporting the program

Chapter 5. Reference card: Frequently used z/OS Debugger commands

The following reference card provides a list of frequently used z/OS Debugger commands.

The\ reference cards are designed to be printed from a PDF file. If you are viewing this page through [IBM Documentation](#), follow these instructions to view the reference card through a PDF file and print it:

1. Click on the "PDF version" topic underneath "IBM z/OS Debugger Reference Summary" in the navigation pane. The PDF file for *IBM z/OS Debugger Reference Summary* opens.
2. In the Bookmarks (Table of Contents) view of Adobe Reader, click on the appendix heading for the reference card you want to print.
3. Scroll to the first page of the reference card, identify the page number in the Adobe Reader toolbar, then make a note of this page number. Do not use the page number printed on the bottom of the page. Scroll through the reference card to determine the number of pages it spans.
4. Click on Print in the Adobe Reader toolbar or click on **File > Print**. In the "Print Range" box, select Pages and then enter the page number you noted in the previous step, followed by a dash and the last page of the reference card. For example, if the first page of the reference card is on page 75 and the reference card spans four pages, enter "75-79" in the Pages field. If you are capable of printing in duplex, enable duplex printing. Do not alter any other setting; print these pages as you would any portrait-oriented page.
5. Click on OK or Print to start printing.

Setting breakpoints (stopping points) at statements in a program

- A** A is the abbreviation for AT. Enter through the prefix area of the Source window. Sets a breakpoint on line where A is entered.
- PF6** Sets a breakpoint on line where cursor is located.
- AT 509** Sets a breakpoint on line 509.
- AT LABEL label_name** Sets a breakpoint on a label, paragraph, or section name.

Clearing (removing) breakpoints set at statements in a program

- C** C is the abbreviation for CLEAR AT. Type a C in the prefix area of the Source window. When you press Enter, z/OS Debugger removes the breakpoint on the line where C is in the prefix area.
- PF6** Removes a breakpoint on line where cursor is located.
- CLEAR AT 509** Removes the breakpoint on line 509.
- CLEAR AT LABEL label_name** Clears a breakpoint from a label, paragraph, or section name.

Setting breakpoints (stopping points) triggered by a change in the value of a variable

- AT CHANGE ITEMNO** Sets a breakpoint that stops the program when the value of ITEMNO changes.
- Clearing (removing) breakpoints triggered by a change in the value of a variable**
- CLEAR AT CHANGE ITEMNO** Removes the breakpoint that stops the program when the value of ITEMNO changes.

Setting breakpoints (stopping points) at the entrance or exit of a program

- AT ENTRY cu_name** Sets a breakpoint that stops the program when it enters *cu_name*.
- AT ENTRY *** Sets breakpoints that stop a program whenever z/OS Debugger enters a known program.
- AT EXIT cu_name** Sets a breakpoint that stops the program when it exits *cu_name*.
- AT EXIT *** Sets breakpoints that stop a program whenever z/OS Debugger exits a known program.

Clearing (removing) breakpoints set at the entrance or exit of a program

- CLEAR AT ENTRY cu_name** Clears the breakpoint that stops the program when it enters *cu_name*.
- CLEAR AT ENTRY *** Clears all breakpoints that stop a program whenever z/OS Debugger enters a known program.
- CLEAR AT EXIT cu_name** Clears a breakpoint that stops the program when it exits *cu_name*.
- CLEAR AT EXIT *** Removes the breakpoints at every exit point in every program.

Making breakpoints conditional

- Add a WHEN clause to make breakpoints conditional.
- AT CHANGE ITEMNO WHEN ITEMNO = '0805'** Stop after the value of ITEMNO changes, but only if ITEMNO is equal to the specified value.
- AT CHANGE CUSTID WHEN ACCT-BAL > 100** Stop after the value of CUSTID changes, but only if ACCT-BAL is greater than the specified value.
- AT 509 WHEN ITEMNO = '0805'** Stop at statement 509, but only if ITEMNO is equal to the specified value.

Commands that work on all breakpoints

- LIST AT** Displays all breakpoints in the Log window.
- CLEAR AT** Clears all breakpoints.
- DISABLE AT** Temporarily disables (deactivates) all breakpoints.
- ENABLE AT** Enables (activates) all disabled breakpoints.

Identifying and loading a program's source and debug information

- SET DEFAULT LISTINGS source.info.library** Identifies a source library (PDS or PDSE) where z/OS Debugger searches for source files and debug information files. For example, SYSDEBUG files, LANGX files, and compiler listings. z/OS Debugger displays this information in the Source window.
- SET DEFAULT LISTINGS (source.info.lib1, source.info.lib2, ...)** Identifies a concatenation of source libraries (PDS or PDSE) where z/OS Debugger searches for source files and debug information files.
- LISTING or LIST** Displays a list of programs known to z/OS Debugger. Then, you can specify the name of the source file or debug information file for each program.
- LDD assembler_CSECT or LDD LangX_COBOL_program** Load debug information about *assembler_CSECT* or *LangX_COBOL_program* from the EQUALANGX file into the Source window.

<p>Displaying variables in the Monitor window</p> <p>SET AUTOMONITOR ON Automatically displays the values of variables referenced by the current statement in the Monitor window.</p> <p>SET AUTOMONITOR ON BOTH Automatically displays the values of variables referenced by both the current statement and the previously run statement in the Monitor window.</p> <p>MONITOR LIST ITEMNO Adds the ITEMNO variable and its value to the Monitor window.</p> <p>SET MONITOR DATATYPE ON Display the data types of variables.</p> <p>SET MON WRAP OFF Displays values on a single line. If the value is longer than the visible area, z/OS Debugger displays a scroll to indicate that there is more to see.</p> <p>CLEAR MONITOR Clears all items from the Monitor window.</p> <p>C C is the abbreviation for the CLEAR MONITOR command. Type in the letter C in the prefix area of the monitor window. When you press Enter, z/OS Debugger removes the variable on the line where C is in the prefix area.</p>	<p>Displaying variables in Log window and controlling Log window options</p> <p>LIST CUST-ID or LIST TITLED CUST-ID Displays the value of a variable. Only some programming languages require TITLED.</p> <p>PF4 or LIST Displays the value of a variable identified by the location of the cursor.</p> <p>LIST TITLED WSS or LS or FS or LOS Display contents of specific SECTIONS for COBOL programs. WSS means Working-Storage Section, LS means Linkage Section, FS means File Section, and LOS means Local-Storage Section.</p> <p>LIST TITLED * Displays the values of all variables.</p> <p>SET ECHO OFF z/OS Debugger does not display STEP and GO commands in the Log window. However, if a log file is open, z/OS Debugger writes them to the log file.</p> <p>SET LOG ON FILE file_name OLD Opens a log file. When z/OS Debugger opens the log file, all items it writes to the Log window are also written to the log file.</p>	<p>Controlling program execution</p> <p>STEP or PF2 Run one statement or line.</p> <p>GO or PF9 Run the program until z/OS Debugger encounters a breakpoint, the program finishes, or an abend occurs.</p> <p>RUNTO 27 Runs the program and then stops before it runs line 27.</p> <p>R R is the abbreviation of RUNTO. Type in the command in the prefix area of the Source window. When you press Enter, z/OS Debugger runs the program until it reaches the line with the R in the prefix area.</p> <p>GO BYPASS Resume running a program after encountering an abend. Enter this command immediately after an abend occurs. z/OS Debugger skips the statement that caused the abend and continues running the program from the next logical statement.</p>
<p>Changing values of variables</p> <p>Type over value displayed in the Monitor window Move cursor to value displayed in Monitor window, type in new value, then press Enter.</p> <p>MOVE 24 to ACCUM-X For COBOL programs, replace the value of ACCUM-X with 24.</p> <p>ACCUMX = 24 For some languages, replaces the value of ACCUMX with 24.</p>	<p>Refresh the Source window to display the current statement</p> <p>QUALIFY RESET Repositions source in the Source window so that z/OS Debugger displays the current program and current statement.</p> <p>Working with called programs</p> <p>STEP or STEP INTO When the current statement is a CALL, steps into the called program.</p> <p>STEP OVER When the current statement is a CALL, z/OS Debugger runs the called program but does not display it. z/OS Debugger stops at the statement after the call.</p> <p>LOAD program_name Make program_name known to z/OS Debugger.</p> <p>QUALIFY program_name Displays the program program_name in the Source window. When the program is displayed in the Source window, you can set a breakpoint or work with variables in that program.</p> <p>QUALIFY RESET Reposition to the current program and the current line.</p>	<p>Skipping (do not run) over program statements</p> <p>JUMPTO 27 Moves the point at which the program resumes execution to line 27, does not run any statements between the current point and line 27, and then pauses at line 27. When you enter a GO or STEP command, the program resumes running at line 27.</p> <p>GOTO 27 Moves the point at which the program resumes execution to line 27, does not run any statements between the current point and line 27, and then resumes running the program at line 27.</p>

Commands that work in the prefix area of the Source window

- A** A is the abbreviation for AT. Sets a breakpoint on the line.
- C** C is the abbreviation for CLEAR AT. Clears the breakpoint from the line.
- D** D is the abbreviation for DISABLE AT. Disables the breakpoint on the line.
- E** E is the abbreviation for ENABLE AT. Enables the breakpoint on the line.
- L** L is the abbreviation for LIST. Displays all variables referenced by the statement in the log. This prefix command works only for programs compiled with specific compilers.
- L1, L2, L3, ...** L is the abbreviation for LIST. Displays the first, second, third, and so on variable referenced by the statement in the log. This prefix command works only for programs compiled with specific compilers.
- M** M is the abbreviation for MONITOR LIST. Displays all variables reference by the statement in the Monitor window. This prefix command works only for programs compiled with specific compilers.
- M1, M2, M3, ...** M is the abbreviation for MONITOR LIST. Displays first, second, third, and so on variable referenced by the statement in the Monitor window. This prefix command works only for programs compiled with specific compilers.

Commands that work in the prefix area of the Monitor window

- C** C is the abbreviation for CLEAR MONITOR. Removes the variable from the Monitor window.
- D** D is the abbreviation for default. Displays the value of the variable in a format based on its declared data type.
- H** H is the abbreviation for hexadecimal. Displays the value of the variable in hexadecimal format.

Working with PF keys

- QUERY PFKEYS** Displays the PF key settings in the log.
- SET KEYS ON** z/OS Debugger displays the PF key settings for PF keys 1-12 at the bottom of the screen.
- SET KEYS ON 24** z/OS Debugger displays the PF key settings for PF keys 13-24 at the bottom of the screen.
- SET KEYS OFF** z/OS Debugger removes the PF key settings from the bottom of the screen.
- SET PF16 "MON" = MONITOR LIST** Example of assigning a command to a PF key. In this example, you assign the MONITOR LIST command to the PF16 key. When z/OS Debugger displays PF keys 13-24 at the bottom of the screen, it shows "PF16=MON".

Default PF key settings

- PF1 or PF13** ? (HELP)
- PF2 or PF14** STEP
- PF3 or PF15** END
- PF4 or PF16** LIST
- PF5 or PF17** FIND
- PF6 or PF18** AT/CLEAR
- PF7 or PF19** UP
- PF8 or PF20** DOWN
- PF9 or PF21** GO
- PF10 or PF22** ZOOM
- PF11 or PF23** ZOOM LOG
- PF12 or PF24** RETRIEVE

Displaying help for commands

- ?** Displays a list of commands
- AT ?** Example of displaying help for the AT command. Enter all or part of a command, followed by a question mark ("?") to display keywords that are valid at the location of the question mark.

Continuing a long command

- (dash at the end of a line)** To continue a long command (for example, a command that exceeds the size of the command line), type a dash at the end of a partial command and then press Enter. z/OS Debugger prompts you to enter the rest of the command.

Abbreviating commands

(use partial keywords)

You can abbreviate keywords in z/OS Debugger commands to the least number of letters that make the keyword unambiguous. For example, you can abbreviate the command MONITOR LIST VARX to MON LIST VARX or MO LIS VARX.

Ending a debugging session

- QUIT** Ends the debugging session and prompts you to verify that you want to end the debugging session.
- QQUIT** Ends the debugging session without prompting you.
- QUIT DEBUG** Ends the debugging session but program continues to run. z/OS Debugger will not be restarted.
- QUIT DEBUG TASK** This command works only for CICS. Ends debugging session but the program continues to run. z/OS Debugger will not be restarted. To start z/OS Debugger, start another iteration of a pseudo-conversational task.
- QUIT ABEND** Ends the debugging session and terminates the program with an abend at the current location.

Chapter 6. Reference card: Frequently used z/OS Debugger commands while debugging assembler programs

The following reference card provides a list of frequently used z/OS Debugger commands while debugging assembler programs. Enter all the commands on the command line, unless otherwise indicated.

The reference cards are designed to be printed from a PDF file. If you are viewing this page through [IBM Documentation](#), follow these instructions to view the reference card through a PDF file and print it:

1. Click on the "PDF version" topic underneath "IBM z/OS Debugger Reference Summary" in the navigation pane. The PDF file for *IBM z/OS Debugger Reference Summary* opens.
2. In the Bookmarks (Table of Contents) view of Adobe Reader, click on the appendix heading for the reference card you want to print.
3. Scroll to the first page of the reference card, identify the page number in the Adobe Reader toolbar, then make a note of this page number. Do not use the page number printed on the bottom of the page. Scroll through the reference card to determine the number of pages it spans.
4. Click on Print in the Adobe Reader toolbar or click on File->Print. In the "Print Range" box, select Pages and then enter the page number you noted in the previous step, followed by a dash and the last page of the reference card. For example, if the first page of the reference card is on page 75 and the reference card spans four pages, enter "75-79" in the Pages field. If you are capable of printing in duplex, enable duplex printing. Do not alter any other setting; print these pages as you would any portrait-oriented page.
5. Click on OK or Print to start printing.

Setting breakpoints (stopping points) in a program

- A** Type A in prefix area of the Source window on line where you want to set a breakpoint. Press Enter. z/OS Debugger sets a breakpoint on that line. (A is the abbreviation for AT.)
- PF6** Move cursor to line where you want to set the breakpoint. Press PF6. z/OS Debugger sets a breakpoint on that line.
- AT 509** z/OS Debugger sets a breakpoint on line 509.
- AT EXIT *** z/OS Debugger sets a breakpoint at every program exit point.
- AT ENTRY *** z/OS Debugger sets a breakpoint at every program entry point.
- AT ENTRY *curname*** z/OS Debugger sets a breakpoint at entry point of *curname*.

Clearing (removing) breakpoints set in a program

- C** Type a C in the prefix area of the Source window on a line containing a breakpoint you want to remove. Press Enter. z/OS Debugger removes the breakpoint on that line. (C is the abbreviation for CLEAR AT.)
- PF6** Move cursor to line where you want to remove the breakpoint. Press PF6. z/OS Debugger removes the breakpoint on that line.
- CLEAR AT 509** z/OS Debugger removes the breakpoint on line 509.
- CLEAR AT EXIT *** z/OS Debugger removes breakpoints from every program exit point.
- CLEAR AT ENTRY *** z/OS Debugger removes breakpoints from every program entry point.
- CLEAR AT** z/OS Debugger removes all breakpoints.

Set a deferred breakpoint

A deferred breakpoint is a breakpoint you set on a program that is not yet known to z/OS Debugger.

- AT ENTRY *curname***
If the block name is the same as *curname*, you no longer have to specify *curname* as *curname*; >*curname*.

Setting conditional breakpoints

- AT CHANGE ITEMNO**
After the value of ITEMNO changes, z/OS Debugger stops the program. ITEMNO must be known through DC, DS, or USING.
- AT CHANGE _STORAGE (R6 + 1::5)**
After the data at the address (R6+1) changes, z/OS Debugger stops the program.
- Example of how to stop when a variable reaches a specific value, display line number where program stopped, then display value of ITEMNO:
- ```
AT CHANGE ITEMNO WHEN ITEMNO = '00006' DO QUERY LOC;
LIST ('ITEMNO CHANGED HERE', ITEMNO)
END; GO; ;
```
- You can substitute ITEMNO = '00006', with ITEMNO = 6 or \_STORAGE (R6 + 1::5). The AT CHANGE, WHEN, and DO clause must be on the same line.

**Clearing (removing) conditional breakpoints**

- CLEAR AT CHANGE ITEMNO**  
z/OS Debugger removes the breakpoint that stops the program when the value of ITEMNO changes.
- Viewing data within a program**
- MONITOR LIST ITEMNO SET MON WRAP OFF**  
z/OS Debugger adds the variable ITEMNO and its current value to the Monitor window, and displays everything on one line.

**LIST ITEMNO**

z/OS Debugger adds contents of ITEMNO to the log.

**SET AUTO ON**

z/OS Debugger automatically displays values in the Monitor window.

**SET AUTO ON LOG**

z/OS Debugger automatically displays values in the log.

**Monitor window prefix commands**

Type these letters into the prefix area of the Monitor window.

- C** z/OS Debugger runs the CLEAR MONITOR *n* command, where *n* is the monitor number assigned to the variable being monitored on that line.
- H** Display the value of the variables on this line in hexadecimal format.
- DEF** Display the value of the variables on this line in their declared format.
- Changing values of variables**
- ITEMNO = '00006'**  
z/OS Debugger replaces the value of ITEMNO with 00006.

**Type over the displayed value**

In the Monitor window, if the value is between black boxes, type the new value over the displayed value.

**Working with called programs**

- STEP INTO**  
z/OS Debugger steps into the program being called and continues stepping through that program.

**STEP OVER**

z/OS Debugger runs the program being called without displaying the source for that program.

Enter the following series of commands to do the following tasks:

1. Identify *progname* to z/OS Debugger.
2. Be able to set a breakpoint in *progname*.
3. Display the source of *progname* in the Source window.

```
LOAD progname;
QUALIFY progname
QUALIFY RESET;
```

**Return to or find the next line to run****QUALIFY RESET**

z/OS Debugger displays, in the Source window, the next line it will run.

**Load assembler & OSVS COBOL debugging information**

**LDD *asmsect***  
z/OS Debugger loads debug information from EQALANGX into the Source window.

**LDD *oscob, prog***

z/OS Debugger loads debug information from EQALANGX into the Source window.

### Working with registers

**MON LI REG**  
z/OS Debugger adds all registers to the Monitor window.

**LIST STORAGE (%GPR6->+1,5);**  
z/OS Debugger display 5 bytes of storage starting at the address pointed to by register 6 plus 1 byte.

**MON LI STORAGE (R6->+1,5);**  
z/OS Debugger adds to the Monitor window the 5 bytes of storage starting at the address pointed to by register 6 plus 1 byte.

**MON LI STORAGE (R6 + 1;:5)**  
z/OS Debugger adds to the Monitor window the 5 bytes of storage starting at the address pointed to by register 6 plus 1 byte.

### Controlling program execution

**STEP**  
Run one instruction.

**PF2**  
PF key to run one instruction.

**GO**  
Run the program until it abends, encounters a breakpoint, or finishes.

**PF9**  
PF key to run the program until it abends, encounters a breakpoint, or finishes.

**JUMPTO 27**  
z/OS Debugger makes line 27 the current point of execution, but does not run line 27.

**RUNTO 27**  
z/OS Debugger runs the program to line 27, then stops.

### Saving monitors, breakpoints and settings across debugging sessions

**SAVE MONITORS**  
z/OS Debugger saves all variables being monitored in the Monitor window.

**SAVE BPS**  
z/OS Debugger saves all the breakpoints.

**SAVE SETTINGS**  
z/OS Debugger saves all the settings set by the SET command.

**RESTORE MONITORS**  
z/OS Debugger restores all the variables saved by the SAVE MONITORS command to the Monitor window.

**RESTORE BPS**  
z/OS Debugger restores all the breakpoints saved by the SAVE BPS command.

**RESTORE SETTINGS**  
z/OS Debugger restores all the settings saved by the SAVE SETTINGS command.

### Memory window

**MEMORY ITEMNO**  
z/OS Debugger displays raw storage beginning at the location of ITEMNO.

**MEMORY X'2503D008'**  
z/OS Debugger displays memory beginning base address X'2503D008'.

**SWAP MEMORY LOG**  
z/OS Debugger switches between the Memory window and the Log window.

**SET EQUATE SW= 'SWAP MEM LOG'**  
z/OS Debugger assigns the letters "SW" with the command SWAP MEMORY LOG. Afterwards, you enter SW to switch between the Memory window and the Log window.

**CICS pseudo-conversational programs**

**SET TEST ERROR**  
z/OS Debugger does not stop for Language Environment class 1 exceptions: EXEC CICS RETURN and STOP RUN in batch.

### QUIT DEBUG TASK

Stop z/OS Debugger for this task.

### Technique to bypass an abend condition

**GO BYPASS**  
Skip the exception condition and stop at the next breakpoint.

### Technique to call Fault Analyzer for DUMP

**CALL %FA**  
z/OS Debugger produces a DUMP that Fault Analyzer can use in its analysis.

### End program debugging (testing)

**QUIT**  
Ends z/OS Debugger and program stops running.

**QQUIT**  
Ends z/OS Debugger without prompt.

**QUIT DEBUG**  
Ends z/OS Debugger but program continues running.

**QUIT DEBUG TASK**  
Ends z/OS Debugger but program continues running.

**QUIT ABEND**  
Causes a ROLLBACK for IMS and Db2 programs.

### Suggested PF key settings

**PF1**  
"PF13/24"=SET KEYS 24;

**PF2**  
"KEEP"=MON LOCAL %CU LIST CURSOR;

**PF3**  
"QUIT"=QUIT;

**PF4**  
"CURRLINE"=QUALIFY RESET

**PF5**  
"FIND"=FIND;

**PF7**  
"UP"=SCROLL UP;

**PF8**  
"DOWN"=SCROLL DOWN;

**PF9**  
"GO 1"=STEP

**PF10**  
"ZOOM WIN"=IMMEDIATE ZOOM;

**PF11**  
"ZOOM LOG"=WINDOW ZOOM LOG;

**PF12**  
"GO"=GO;

**PF13**  
"PF1/12"=SET KEYS 12;

**PF14**  
"CLR KEEP"=CLEAR MONITOR;

**PF15**  
"QUIT"=QUIT;

**PF16**  
"LIST CSR"=LIST CURSOR;

**PF17**  
"FIND"=IMMEDIATE FIND;

**PF18**  
"AT/CLEAR"=AT TOGGLE;

**PF19**  
"TOP"=TOP;

**PF20**  
"BOTTOM"=BOT;

**PF21**  
"GO 1"=STEP;

**PF22**  
"ZOOM WIN"=IMMEDIATE ZOOM;

**PF23**  
"ZOOM LOG"=WINDOW ZOOM LOG;

**PF24**  
"RETRIEVE"=IMMEDIATE RETRIEVE;



## Notices

---

This information was developed for products and services offered in the U.S.A. IBM might not offer the products, services, or features discussed in this document in other countries. Consult your local IBM representative for information on the products and services currently available in your area. Any reference to an IBM product, program, or service is not intended to state or imply that only that IBM product, program, or service may be used. Any functionally equivalent product, program, or service that does not infringe any IBM intellectual property right may be used instead. However, it is the user's responsibility to evaluate and verify the operation of any non-IBM product, program, or service.

IBM may have patents or pending patent applications covering subject matter in this document. The furnishing of this document does not give you any license to these patents. You can send license inquiries, in writing, to:

IBM Corporation  
J46A/G4  
555 Bailey Avenue  
San Jose, CA 95141-1003  
U.S.A.

For license inquiries regarding double-byte (DBCS) information, contact the IBM Intellectual Property Department in your country or send inquiries, in writing, to:

Intellectual Property Licensing  
Legal and Intellectual Property Law  
IBM Japan, Ltd.  
3-2-12, Roppongi, Minato-ku, Tokyo 106-8711

The following paragraph does not apply to the United Kingdom or any other country where such provisions are inconsistent with the local law:

INTERNATIONAL BUSINESS MACHINES CORPORATION PROVIDES THIS PUBLICATION "AS IS" WITHOUT WARRANTY OF ANY KIND, EITHER EXPRESS OR IMPLIED, INCLUDING, BUT NOT LIMITED TO, THE IMPLIED WARRANTIES OF NON-INFRINGEMENT, MERCHANTABILITY OR FITNESS FOR A PARTICULAR PURPOSE.

Some states do not allow disclaimer of express or implied warranties in certain transactions; therefore, this statement might not apply to you.

This information could include technical inaccuracies or typographical errors. Changes are periodically made to the information herein; these changes will be incorporated in new editions of the publication. IBM may make improvements and/or changes in the product(s) and/or the program(s) described in this publication at any time without notice.

## Copyright license

---

This information contains sample application programs in source language, which illustrate programming techniques on various operating platforms. You may copy, modify, and distribute these sample programs in any form without payment to IBM, for the purposes of developing, using, marketing or distributing application programs conforming to the application programming interface for the operating platform for which the sample programs are written. These examples have not been thoroughly tested under all conditions. IBM, therefore, cannot guarantee or imply reliability, serviceability, or function of these programs. The sample programs are provided "AS IS", without warranty of any kind. IBM shall not be liable for any damages arising out of your use of the sample programs.

Each copy or any portion of these sample programs or any derivative work must include a copyright notice as follows:

© (your company name) (year).

Portions of this code are derived from IBM Corp. Sample Programs.  
© Copyright IBM Corp. \_enter the year or years\_.

## Privacy policy considerations

---

IBM Software products, including software as a service solutions, ("Software Offerings") may use cookies or other technologies to collect product usage information, to help improve the end user experience, or to tailor interactions with the end user, or for other purposes. In many cases no personally identifiable information is collected by the Software Offerings. Some of our Software Offerings can help enable you to collect personally identifiable information. If this Software Offering uses cookies to collect personally identifiable information, specific information about this offering's use of cookies is set forth below.

This Software Offering does not use cookies or other technologies to collect personally identifiable information.

If the configurations deployed for this Software Offering provide you as customer the ability to collect personally identifiable information from end users via cookies and other technologies, you should seek your own legal advice about any laws applicable to such data collection, including any requirements for notice and consent.

For more information about the use of various technologies, including cookies, for these purposes, see IBM's Privacy Policy at <http://www.ibm.com/privacy> and IBM's Online Privacy Statement at <http://www.ibm.com/privacy/details> in the section entitled "Cookies, Web Beacons and Other Technologies", and "the IBM Software Products and Software-as-a-Service Privacy Statement" at <http://www.ibm.com/software/info/product-privacy>.

## Programming interface information

---

This document is intended to help you debug application programs. This publication documents intended Programming Interfaces that allow you to write programs to obtain the services of z/OS Debugger.

## Trademarks and service marks

---

IBM, the IBM logo, and [ibm.com](http://www.ibm.com) are trademarks or registered trademarks of International Business Machines Corp., registered in many jurisdictions worldwide. Other product and service names might be trademarks of IBM or other companies. A current list of IBM trademarks is available on the web at "Copyright and trademark information" at [www.ibm.com/legal/copytrade.shtml](http://www.ibm.com/legal/copytrade.shtml).

Other company, product, or service names may be trademarks or service marks of others.







Product Number: 5724-T07