

z/OS
2.4

*MVS Programming: Assembler Services
Reference, Volume 2 (IAR-XCT)*



Note

Before using this information and the product it supports, read the information in [“Notices” on page 1179.](#)

This edition applies to Version 2 Release 4 of z/OS (5650-ZOS) and to all subsequent releases and modifications until otherwise indicated in new editions.

Last updated: 2021-06-24

© **Copyright International Business Machines Corporation 1988, 2021.**

US Government Users Restricted Rights – Use, duplication or disclosure restricted by GSA ADP Schedule Contract with IBM Corp.

Contents

Figures.....	xxxix
Tables.....	xli
About this information.....	xlvi
Who should use this information.....	xlvi
How to use this information.....	xlvi
z/OS information.....	xlvi
How to send your comments to IBM.....	xlvii
If you have a technical problem.....	xlviii
Summary of changes.....	xliv
Summary of changes for z/OS Version 2 Release 4.....	xliv
Summary of changes for z/OS Version 2 Release 3.....	li
Summary of changes for z/OS Version 2 Release 2 (V2R2), as updated December, 2015.....	lii
Summary of changes for z/OS Version 2 Release 2.....	lii
Chapter 1. Using the services.....	1
Compatibility of MVS macros.....	1
Addressing mode (AMODE).....	2
Address space control (ASC) mode.....	3
ALET qualification.....	3
User parameters.....	4
Telling the system about the execution environment	5
Specifying a macro version number.....	6
How to request a macro version using PLISTVER.....	6
Register use.....	7
Handling return codes and reason codes.....	7
Handling program errors.....	8
Handling environmental and system errors.....	9
Using X-macros.....	9
Macro forms.....	10
Conventional list form macros.....	10
Alternative list form macros.....	11
Coding the macros.....	11
Continuation lines.....	13
Coding the callable services.....	14
Including equate (EQU) statements.....	14
Link-editing linkage-assist routines.....	15
Service summary.....	15
Chapter 2. IARCP64 – 64-bit cell pool services.....	23
Description.....	23
Environment.....	23
Programming requirements.....	24
Restrictions.....	24
Input register information.....	24
Output register information.....	24

Performance implications.....	25
Syntax.....	25
Parameters.....	28
ABEND codes.....	34
Return and reason codes.....	34
Examples.....	35

Chapter 3. IARR2V – Convert a central storage address to a virtual storage

address.....	37
Description.....	37
Environment.....	37
Programming requirements.....	37
Restrictions.....	37
Input register information.....	37
Output register information.....	37
Performance implications.....	38
Syntax.....	38
Parameters.....	39
ABEND codes.....	40
Return and reason codes.....	40
Example 1.....	41
Example 2.....	41
Example 3.....	42
Example 4.....	42

Chapter 4. IARST64 – 64-bit storage services..... 43

Description.....	43
Environment.....	43
Programming requirements.....	44
Restrictions.....	44
Input register information.....	44
Output register information.....	44
Performance implications.....	45
Syntax.....	45
Parameters.....	47
ABEND codes.....	52
Return and reason codes.....	55

Chapter 5. IARVserv – Request to share virtual storage..... 57

Description.....	57
Environment.....	57
Programming requirements.....	57
Restrictions.....	58
Input register information.....	58
Output register information.....	58
Performance implications.....	58
Syntax.....	59
Parameters.....	60
ABEND codes.....	62
Return and reason codes.....	62
Example 1.....	64
Example 2.....	64
Example 3.....	65
Example 4.....	65
Example 5.....	65
Example 6.....	65
IARVserv—List form.....	66

IARVSERV - Execute form.....	67
------------------------------	----

Chapter 6. IARV64 – 64-bit virtual storage allocation..... 71

Description.....	71
Abend and abend reason codes.....	72
Return and reason codes.....	72
Example.....	73
REQUEST=GETSTOR option of IARV64.....	73
Environment.....	73
Programming requirements.....	74
Restrictions.....	74
Input register information.....	74
Output register information.....	74
Performance implications.....	75
Syntax.....	75
Parameters.....	77
REQUEST=CHANGEATTRIBUTE option of IARV64.....	82
REQUEST=CHANGEGUARD option of IARV64.....	87
Environment.....	87
Programming requirements.....	88
Restrictions.....	88
Input register information.....	88
Output register information.....	88
Performance implications.....	88
Syntax.....	88
Parameters.....	90
REQUEST=DETACH option of IARV64.....	93
Environment.....	93
Programming requirements.....	93
Restrictions.....	93
Input register information.....	93
Output register information.....	93
Performance implications.....	94
Syntax.....	94
Parameters.....	95
REQUEST=DISCARDATA option of IARV64.....	98
Environment.....	98
Programming requirements.....	99
Restrictions.....	99
Input register information.....	99
Output register information.....	99
Performance implications.....	99
Syntax.....	100
Parameters.....	101
REQUEST=PAGEIN option of IARV64.....	103
Environment.....	103
Programming requirements.....	103
Restrictions.....	104
Input register information.....	104
Output register information.....	104
Performance implications.....	104
Syntax.....	104
Parameters.....	105
REQUEST=PAGEOUT option of IARV64.....	107
Environment.....	107
Programming requirements.....	108
Restrictions.....	108

Input register information.....	108
Output register information.....	108
Performance implications.....	108
Syntax.....	109
Parameters.....	109
Chapter 7. IDENTIFY – Add an entry name.....	113
Description.....	113
Syntax.....	113
Parameters.....	114
Return codes.....	114
Example.....	115
Chapter 8. IEAARR – Establish an associated recovery routine (ARR).....	117
Description.....	117
Environment.....	117
Programming requirements.....	117
Restrictions.....	117
Input register information.....	117
Output register information.....	117
Performance implications.....	118
Syntax.....	118
Parameters.....	119
ABEND codes.....	122
Return codes.....	122
Example.....	122
Chapter 9. IEABRC – Relative branch macro.....	123
Description.....	123
Environment.....	123
Programming requirements.....	123
Restrictions.....	123
Register information.....	123
Performance implications.....	123
Syntax.....	123
Parameters.....	124
Example.....	124
Chapter 10. IEABRCX – Relative branch macro extension.....	125
Description.....	125
Environment.....	125
Programming requirements.....	125
Restrictions.....	125
Register information.....	125
Performance implications.....	125
Syntax.....	126
Parameters.....	126
Example.....	126
Chapter 11. IEAFP – Floating point services.....	129
Chapter 12. IEAGSF – Guarded-Storage Facility services.....	135
Chapter 13. IEAINTKN – Build incident token.....	143
Description.....	143
Environment.....	143

Programming requirements.....	143
Restrictions.....	143
Input register information.....	143
Output register information.....	143
Performance implications.....	144
Syntax.....	144
Parameters.....	144
ABEND codes.....	144
Return and reason codes.....	144
Example.....	145
Chapter 14. IEALSQRY – Linkage stack query.....	147
Description.....	147
Environment.....	147
Programming requirements.....	147
Restrictions.....	148
Input register information.....	148
Output register information.....	148
Performance implications.....	148
Syntax.....	148
ABEND codes.....	149
Return codes.....	149
Example.....	150
Chapter 15. IEAMETR – Query external time reference status.....	151
Description.....	151
Environment.....	151
Programming requirements.....	151
Restrictions.....	151
Input register information.....	151
Output register information.....	151
Performance implications.....	152
Syntax.....	152
Parameters.....	152
Return codes.....	153
Chapter 16. IEANTCR – Create a name/token pair.....	155
Description.....	155
Environment.....	155
Programming requirements.....	155
Restrictions.....	156
Input register information.....	156
Output register information.....	156
Performance implications.....	156
Syntax.....	156
Parameters.....	157
ABEND codes.....	157
Return and reason codes.....	158
Example.....	158
Chapter 17. IEANTDL – Delete a name/token pair.....	161
Description.....	161
Environment.....	161
Programming requirements.....	161
Restrictions.....	162
Input register information.....	162
Output register information.....	162

Performance implications.....	162
Syntax.....	162
Parameters.....	163
ABEND codes.....	163
Return and reason codes.....	163
Example.....	164
Chapter 18. IEANTRT – Retrieve the token from a name/token pair.....	165
Description.....	165
Environment.....	165
Programming requirements.....	165
Restrictions.....	166
Input register information.....	166
Output register information.....	166
Performance implications.....	166
Syntax.....	166
Parameters.....	167
ABEND codes.....	167
Return and reason codes.....	167
Example 1.....	168
Example 2.....	168
Chapter 19. IEAN4CR – Create a name/token pair.....	171
Description.....	171
Environment.....	171
Programming requirements.....	171
Restrictions.....	172
Input register information.....	172
Output register information.....	172
Performance implications.....	172
Syntax.....	172
Parameters.....	173
ABEND codes.....	174
Return and reason codes.....	174
Chapter 20. IEAN4DL – Delete a name/token pair.....	177
Description.....	177
Environment.....	177
Programming requirements.....	177
Restrictions.....	178
Input register information.....	178
Output register information.....	178
Performance implications.....	178
Syntax.....	178
Parameters.....	179
ABEND codes.....	179
Return and reason codes.....	179
Chapter 21. IEAN4RT – Retrieve the token from a name/token pair.....	181
Description.....	181
Environment.....	181
Programming requirements.....	181
Restrictions.....	182
Input register information.....	182
Output register information.....	182
Performance implications.....	182
Syntax.....	182

Parameters.....	183
ABEND codes.....	183
Return and reason codes.....	183
Chapter 22. IEATDUMP – Transaction dump request.....	185
Description.....	185
Environment.....	185
Programming requirements.....	186
Restrictions.....	186
Input register information.....	186
Output register information.....	186
Performance implications.....	186
Syntax.....	186
Parameters.....	189
ABEND codes.....	195
Return and reason codes.....	195
Examples.....	201
Chapter 23. IEATXDC – Transactional execution diagnostic controls.....	203
Description.....	203
Environment.....	203
Programming requirements.....	203
Restrictions.....	203
Input register information.....	203
Output register information.....	203
Performance implications.....	204
Syntax.....	204
Parameters.....	205
ABEND codes.....	205
Return codes.....	205
Examples.....	206
Chapter 24. IEVAPE – Allocate_Pause_Element.....	207
Description.....	207
Environment.....	207
Programming requirements.....	207
Restrictions.....	207
Input register information.....	207
Output register information.....	208
Performance implications.....	208
Syntax.....	208
Parameters.....	208
ABEND codes.....	209
Return codes.....	209
Chapter 25. IEVAPE2 – Allocate_Pause_Element.....	211
Description.....	211
Environment.....	211
Programming requirements.....	211
Restrictions.....	211
Input register information.....	212
Output register information.....	212
Performance implications.....	212
Syntax.....	213
Parameters.....	213
ABEND codes.....	216
Return codes.....	216

Chapter 26. IEAVDPE – Deallocate_Pause_Element.....	219
Description.....	219
Environment.....	219
Programming requirements.....	219
Restrictions.....	219
Input register information.....	219
Output register information.....	220
Performance implications.....	220
Syntax.....	220
Parameters.....	220
ABEND codes.....	221
Return codes.....	221
Chapter 27. IEAVDPE2 – Deallocate_Pause_Element.....	223
Description.....	223
Environment.....	223
Programming requirements.....	223
Restrictions.....	223
Input register information.....	223
Output register information.....	224
Performance implications.....	224
Syntax.....	224
Parameters.....	224
ABEND codes.....	225
Return codes.....	225
Chapter 28. IEAVPME2 – pause multiple elements service.....	227
Description.....	227
Environment.....	227
Programming requirements.....	227
Restrictions.....	227
Input register information.....	228
Output register information.....	228
Performance implications.....	228
Syntax.....	229
Parameters.....	229
ABEND codes.....	231
Return codes.....	231
Chapter 29. IEAVPSE – Pause service.....	235
Description.....	235
Environment.....	235
Programming requirements.....	235
Restrictions.....	235
Input register information.....	235
Output register information.....	236
Performance implications.....	236
Syntax.....	236
Parameters.....	236
ABEND codes.....	238
Return codes.....	238
Chapter 30. IEAVPSE2 – Pause service.....	241
Description.....	241
Environment.....	241
Programming requirements.....	241

Restrictions.....	241
Input register information.....	242
Output register information.....	242
Performance implications.....	242
Syntax.....	242
Parameters.....	243
ABEND codes.....	244
Return codes.....	244
Chapter 31. IEAVRLS – Release.....	247
Description.....	247
Environment.....	247
Programming requirements.....	247
Restrictions.....	247
Input register information.....	247
Output register information.....	248
Performance implications.....	248
Syntax.....	248
Parameters.....	248
ABEND codes.....	249
Return codes.....	249
Chapter 32. IEAVRLS2 – Release.....	251
Description.....	251
Environment.....	251
Programming requirements.....	251
Restrictions.....	251
Input register information.....	251
Output register information.....	252
Performance implications.....	252
Syntax.....	252
Parameters.....	252
ABEND codes.....	253
Return codes.....	253
Chapter 33. IEAVRPI – Retrieve_Pause_Element_Information service.....	257
Description.....	257
Environment.....	257
Programming requirements.....	257
Restrictions.....	257
Input register information.....	258
Output register information.....	258
Performance implications.....	258
Syntax.....	258
Parameters.....	258
ABEND codes.....	260
Return codes.....	261
Chapter 34. IEAVRPI2 – Retrieve_Pause_Element_Information service.....	263
Description.....	263
Environment.....	263
Programming requirements.....	263
Restrictions.....	264
Input register information.....	264
Output register information.....	264
Performance implications.....	264
Syntax.....	265

Parameters.....	265
ABEND codes.....	267
Return codes.....	267
Chapter 35. IEAVTPE – Test_Pause_Element service.....	269
Description.....	269
Environment.....	269
Programming requirements.....	269
Restrictions.....	269
Input register information.....	269
Output register information.....	269
Performance implications.....	270
Syntax.....	270
Parameters.....	270
ABEND codes.....	271
Return codes.....	272
Chapter 36. IEAVXFR – Transfer service.....	273
Description.....	273
Environment.....	273
Programming requirements.....	273
Restrictions.....	273
Input register information.....	273
Output register information.....	274
Performance implications.....	274
Syntax.....	274
Parameters.....	274
ABEND codes.....	276
Return codes.....	276
Chapter 37. IEAVXFR2 – Transfer service.....	279
Description.....	279
Environment.....	279
Programming requirements.....	279
Restrictions.....	279
Input register information.....	279
Output register information.....	280
Performance implications.....	280
Syntax.....	280
Parameters.....	280
ABEND codes.....	282
Return codes.....	282
Chapter 38. IEA4APE – Allocate_Pause_Element.....	285
Description.....	285
Environment.....	285
Programming requirements.....	285
Restrictions.....	285
Input register information.....	286
Output register information.....	286
Performance implications.....	286
Syntax.....	286
Parameters.....	287
ABEND codes.....	288
Return codes.....	288
Chapter 39. IEA4APE2 – Allocate_Pause_Element.....	289

Description.....	289
Environment.....	289
Programming requirements.....	289
Restrictions.....	289
Input register information.....	290
Output register information.....	290
Performance implications.....	290
Syntax.....	290
Parameters.....	291
ABEND codes.....	293
Return codes.....	293
Chapter 40. IEA4DPE - Deallocate_Pause_Element.....	295
Description.....	295
Environment.....	295
Programming requirements.....	295
Restrictions.....	295
Input register information.....	295
Output register information.....	296
Performance implications.....	296
Syntax.....	296
Parameters.....	296
ABEND codes.....	297
Return codes.....	297
Chapter 41. IEA4DPE2 – Deallocate_Pause_Element.....	299
Description.....	299
Environment.....	299
Programming requirements.....	299
Restrictions.....	299
Input register information.....	299
Output register information.....	300
Performance implications.....	300
Syntax.....	300
Parameters.....	300
ABEND codes.....	301
Return codes.....	301
Chapter 42. IEA4PME2 – 64-bit pause multiple elements service.....	303
Description.....	303
Environment.....	303
Programming requirements.....	303
Restrictions.....	303
Input register information.....	304
Output register information.....	304
Performance implications.....	304
Syntax.....	305
Parameters.....	305
ABEND codes.....	307
Return codes.....	307
Chapter 43. IEA4PSE – Pause service.....	311
Description.....	311
Environment.....	311
Programming requirements.....	311
Restrictions.....	311
Input register information.....	311

Output register information.....	312
Performance implications.....	312
Syntax.....	312
Parameters.....	312
ABEND codes.....	314
Return codes.....	314
Chapter 44. IEA4PSE2 – Pause service.....	317
Description.....	317
Environment.....	317
Programming requirements.....	317
Restrictions.....	317
Input register information.....	318
Output register information.....	318
Performance implications.....	318
Syntax.....	318
Parameters.....	319
ABEND codes.....	320
Return codes.....	320
Chapter 45. IEA4RLS – Release.....	323
Description.....	323
Environment.....	323
Programming requirements.....	323
Restrictions.....	323
Input register information.....	323
Output register information.....	324
Performance implications.....	324
Syntax.....	324
Parameters.....	324
ABEND codes.....	325
Return codes.....	325
Chapter 46. IEA4RLS2 – Release.....	327
Description.....	327
Environment.....	327
Programming requirements.....	327
Restrictions.....	327
Input register information.....	327
Output register information.....	328
Performance implications.....	328
Syntax.....	328
Parameters.....	328
ABEND codes.....	329
Return codes.....	329
Chapter 47. IEA4RPI – Retrieve_Pause_Element_Information service.....	333
Description.....	333
Environment.....	333
Programming requirements.....	333
Restrictions.....	333
Input register information.....	334
Output register information.....	334
Performance implications.....	334
Syntax.....	334
Parameters.....	335
ABEND codes.....	337

Return codes.....	337
Chapter 48. IEA4RPI2 – Retrieve_Pause_Element_Information service.....	339
Description.....	339
Environment.....	339
Programming requirements.....	339
Restrictions.....	339
Input register information.....	340
Output register information.....	340
Performance implications.....	340
Syntax.....	340
Parameters.....	341
ABEND codes.....	343
Return codes.....	343
Chapter 49. IEA4TPE – Test_Pause_Element service.....	345
Description.....	345
Environment.....	345
Programming requirements.....	345
Restrictions.....	345
Input register information.....	345
Output register information.....	345
Performance implications.....	346
Syntax.....	346
Parameters.....	346
ABEND codes.....	348
Return codes.....	348
Chapter 50. IEA4XFR – Transfer service.....	349
Description.....	349
Environment.....	349
Programming requirements.....	349
Restrictions.....	349
Input register information.....	349
Output register information.....	350
Performance implications.....	350
Syntax.....	350
Parameters.....	351
ABEND codes.....	352
Return codes.....	352
Chapter 51. IEA4XFR2 – Transfer service.....	355
Description.....	355
Environment.....	355
Programming requirements.....	355
Restrictions.....	355
Input register information.....	355
Output register information.....	356
Performance implications.....	356
Syntax.....	356
Parameters.....	356
ABEND codes.....	358
Return codes.....	358
Chapter 52. IEFDDSRV – DD service.....	361
Description.....	361
Environment.....	361

Programming requirements.....	361
Restrictions.....	362
Input register information.....	363
Output register information.....	363
Performance implications.....	363
Syntax.....	363
Parameters.....	365
ABEND codes.....	371
Return and reason codes.....	371
Chapter 53. IEFOPZQ – Query the IEFOPZ configuration.....	375
Chapter 54. IEFPRMLB – Logical parmlib support.....	387
Description.....	387
Environment.....	387
Programming requirements.....	387
Restrictions.....	388
Input register information.....	388
Output register information.....	388
Performance implications.....	388
REQUEST=ALLOCATE option of IEFPRMLB.....	388
Syntax.....	388
Parameters.....	391
ABEND codes.....	397
Return and reason codes.....	397
REQUEST=FREE option of IEFPRMLB.....	401
Syntax.....	401
Parameters.....	402
ABEND codes.....	405
Return and reason codes.....	405
Examples.....	405
REQUEST=LIST option of IEFPRMLB.....	405
Syntax.....	405
Parameters.....	406
ABEND codes.....	408
Return and reason codes.....	408
Examples.....	408
REQUEST=READMEMBER option of IEFPRMLB.....	408
Syntax.....	408
Parameters.....	410
ABEND codes.....	414
Return and reason codes.....	414
Examples.....	414
Chapter 55. IEFSSI – Dynamically query a subsystem.....	415
Description.....	415
Environment.....	415
Programming requirements.....	415
Restrictions.....	416
Input register information.....	416
Output register information.....	416
Performance implications.....	416
REQUEST=QUERY parameter of IEFSSI.....	416
Syntax for REQUEST=QUERY.....	416
Parameters for REQUEST=QUERY.....	418
ABEND codes.....	420
Return and reason codes.....	420

Example.....	421
Chapter 56. IOCINFO – Obtain MVS I/O configuration information.....	423
Description.....	423
Environment.....	423
Programming requirements.....	423
Restrictions.....	423
Input register information.....	423
Output register information.....	423
Performance implications.....	424
Syntax.....	424
Parameters.....	425
ABEND codes.....	426
Return and reason codes.....	426
IOCINFO—List form.....	427
Syntax.....	427
Parameters.....	427
IOCINFO - Execute form.....	428
Syntax.....	428
Parameters.....	429
Chapter 57. IOSCHPD – IOS CHPID description service.....	431
Description.....	431
Environment.....	431
Programming requirements.....	431
Restrictions.....	431
Input register information.....	431
Output register information.....	431
Performance implications.....	432
Syntax.....	432
Parameters.....	433
ABEND codes.....	436
Return and reason codes.....	436
Chapter 58. IOSCUMOD – IOS control unit entry build service.....	439
Description.....	439
Programming requirements.....	439
Restrictions.....	439
Performance implications.....	439
Syntax.....	439
Parameters.....	440
ABEND codes.....	441
Return and reason codes.....	441
Chapter 59. IOSSCM – Storage class memory information.....	443
Description.....	443
Environment.....	443
Programming requirements.....	443
Restrictions.....	443
Input register information.....	443
Output register information.....	443
Performance implications.....	444
Syntax.....	445
Parameters.....	445
ABEND codes.....	447
Return and reason codes.....	447

Chapter 60. ISGENQ – Global resource serialization ENQ service.....	449
Description.....	449
Environment.....	449
Programming requirements.....	450
Restrictions.....	450
Input register information.....	450
Output register information.....	450
Performance implications.....	451
Syntax.....	452
Parameters.....	454
ABEND codes.....	466
Return and reason codes.....	467
Examples.....	478
Chapter 61. ISGQUERY – Global resource serialization query service.....	481
Description.....	481
Environment.....	481
Programming requirements.....	481
Restrictions.....	482
Input register information.....	482
Output register information.....	482
Performance implications.....	483
Syntax.....	483
Parameters.....	485
ABEND codes.....	496
Return and reason codes.....	496
Examples.....	505
Chapter 62. ITTUINIT – Activate external CTRACE recording.....	509
Description.....	509
Environment.....	509
Programming requirements.....	509
Restrictions.....	510
Input register information.....	510
Output register information.....	510
Performance implications.....	510
Syntax.....	511
Parameters.....	511
Return and reason codes.....	511
Chapter 63. ITTUTERM – End external CTRACE recording.....	513
Description.....	513
Environment.....	513
Programming requirements.....	513
Restrictions.....	513
Input register information.....	513
Output register information.....	513
Performance implications.....	514
Syntax.....	514
Parameters.....	514
Return and reason codes.....	515
Chapter 64. ITTUWRIT – Queue a group of CTRACE entries.....	517
Description.....	517
Environment.....	517
Programming requirements.....	517

Restrictions.....	517
Input register information.....	518
Output register information.....	518
Performance implications.....	518
Syntax.....	518
Parameters.....	519
Return and reason codes.....	519
Chapter 65. ITZEVENT – Transaction trace EVENT record.....	521
Description.....	521
Environment.....	521
Programming requirements.....	521
Restrictions.....	521
Input register information.....	521
Output register information.....	521
Performance implications.....	522
Syntax.....	522
Parameters.....	524
ABEND codes.....	528
Return and reason codes.....	528
Examples.....	529
Chapter 66. ITZQUERY – Transaction trace query.....	531
Description.....	531
Environment.....	531
Programming requirements.....	531
Restrictions.....	531
Input register information.....	531
Output register information.....	531
Performance implications.....	532
Syntax.....	532
Parameters.....	533
ABEND codes.....	535
Return and reason codes.....	535
Chapter 67. IXGBRWSE – Browse/read a log stream.....	537
Description.....	537
Environment.....	537
Programming requirements.....	538
Restrictions.....	538
Input register information.....	539
Output register information.....	539
Performance implications.....	539
REQUEST=START option of IXGBRWSE.....	540
Syntax for REQUEST=START.....	540
Parameters for REQUEST=START.....	542
REQUEST=READCURSOR option of IXGBRWSE.....	545
Syntax for REQUEST=READCURSOR.....	545
Parameters for REQUEST=READCURSOR.....	548
REQUEST=READBLOCK option of IXGBRWSE.....	551
Syntax for REQUEST=READBLOCK.....	551
Parameters for REQUEST=READBLOCK.....	553
REQUEST=RESET option of IXGBRWSE.....	557
Syntax for REQUEST=RESET.....	557
Parameters for REQUEST=RESET.....	559
REQUEST=END option of IXGBRWSE.....	561
Syntax for REQUEST=END.....	561

Parameters for REQUEST=END.....	563
ABEND codes.....	565
Return and reason codes.....	565
Examples.....	578
Chapter 68. IXGCONN – Connect/disconnect to log stream.....	583
Description.....	583
Environment.....	583
Programming requirements.....	583
Restrictions.....	584
Input register information.....	585
Output register information.....	585
Performance implications.....	586
Syntax.....	586
Parameters.....	588
ABEND codes.....	592
Return and reason codes.....	592
Example 1.....	604
Example 2.....	605
Example 3.....	605
Example 4.....	605
Chapter 69. IXGDELET – Deleting log data from a log stream.....	607
Description.....	607
Environment.....	607
Programming requirements.....	607
Restrictions.....	608
Input register information.....	608
Output register information.....	608
Performance implications.....	608
Syntax.....	609
Parameters.....	610
ABEND codes.....	613
Return and reason codes.....	614
Examples.....	620
Chapter 70. IXGIMPRT – Import log blocks.....	623
Description.....	623
Environment.....	623
Programming requirements.....	623
Restrictions.....	623
Input register information.....	623
Output register information.....	623
Performance implications.....	624
Syntax.....	624
Parameters.....	626
ABEND codes.....	628
Return and reason codes.....	628
Example.....	636
Chapter 71. IXGINVNT – Managing the LOGR, LOGRY and LOGRZ inventory active system logger couple data set.....	637
IXGINVNT description.....	637
Environment.....	637
Programming requirements.....	638
Restrictions.....	638
Input register information.....	639

Output register information.....	639
Performance implications.....	640
REQUEST=DEFINE TYPE=LOGSTREAM option of IXGINVNT.....	640
Syntax for REQUEST=DEFINE TYPE=LOGSTREAM.....	640
Parameters for REQUEST=DEFINE,TYPE=LOGSTREAM.....	644
REQUEST=DEFINE TYPE=STRUCTURE option of IXGINVNT.....	659
Syntax for REQUEST=DEFINE TYPE=STRUCTURE.....	659
Parameters for REQUEST=DEFINE,TYPE=STRUCTURE.....	660
REQUEST=UPDATE option of IXGINVNT.....	663
Syntax for REQUEST=UPDATE.....	663
Parameters for REQUEST=UPDATE.....	666
REQUEST=CHECKDEF option of IXGINVNT.....	681
Syntax for REQUEST=CHECKDEF.....	681
Parameters for REQUEST=CHECKDEF.....	682
ABEND codes for REQUEST.....	685
Return and reason codes for REQUEST.....	685
REQUEST=DELETE option of IXGINVNT.....	705
Syntax for REQUEST=DELETE.....	705
Parameters for REQUEST=DELETE.....	707
ABEND codes for REQUEST=DELETE.....	709
Return and reason codes for REQUEST=DELETE.....	709
Example 1.....	728
Example 2.....	729
Example 3.....	729
Example 4.....	729
Example 5.....	730
Example 6.....	730
Example 7.....	730
Example 8.....	731
Example 9.....	731
Example 10.....	731
Example 11.....	732

Chapter 72. IXGOFFLD – Initiate offload to DASD log data sets..... 733

Description.....	733
Environment.....	733
Programming requirements.....	733
Restrictions.....	733
Input register information.....	734
Output register information.....	734
Performance implications.....	734
Syntax.....	734
Parameters.....	735
ABEND codes.....	737
Return and reason codes.....	737
Example.....	741

Chapter 73. IXGQUERY – Query a log stream or system logger for information.... 743

Description.....	743
Environment.....	743
Programming requirements.....	743
Restrictions.....	743
Input register information.....	744
Output register information.....	744
Performance implications.....	744
Syntax.....	744
Parameters.....	746

ABEND codes.....	749
Return and reason codes.....	749
Examples.....	753
Chapter 74. IXGUPDAT – Update log stream control information.....	755
Description.....	755
Environment.....	755
Programming requirements.....	755
Restrictions.....	755
Input register information.....	755
Output register information.....	755
Performance implications.....	756
Syntax.....	756
Parameters.....	757
ABEND codes.....	759
Return and reason codes.....	759
Example.....	763
Chapter 75. IXGWRITE – Write log data to a log stream.....	765
Description.....	765
Environment.....	765
Programming requirements.....	766
Restrictions.....	766
Input register information.....	766
Output register information.....	766
Performance implications.....	767
Syntax.....	767
Parameters.....	769
ABEND codes.....	771
Return and reason codes.....	771
Example 1.....	780
Example 2.....	781
Example 3.....	781
Chapter 76. LINK and LINKX – Pass control to a program in another load module.....	783
LINK and LINKX description.....	783
Environment.....	783
Programming requirements.....	784
Restrictions.....	784
Register information.....	784
Performance implications.....	785
Syntax.....	785
Parameters.....	786
Return and reason codes.....	787
Example 1.....	787
Example 2.....	787
LINKX – Pass control to a program in another load module.....	787
Environment.....	787
Programming requirements.....	787
Register information.....	788
Syntax.....	788
Parameters.....	789
LINK and LINKX—List form.....	791
Syntax.....	791
Parameters.....	792
LINK and LINKX—Execute form.....	792

Syntax.....	792
Parameters.....	794
Chapter 77. LOAD – Bring a load module into virtual storage.....	795
LOAD description.....	795
Environment.....	795
Programming requirements.....	795
Restrictions.....	795
Input register information.....	796
Output register information.....	796
Performance implications.....	797
Syntax.....	797
Parameters.....	798
Return and reason codes.....	799
Example 1.....	800
Example 2.....	800
LOAD—List form.....	800
Syntax.....	800
Parameters.....	801
LOAD - Execute form.....	801
Syntax.....	801
Parameters.....	802
Chapter 78. LSEXPAND – Expand the linkage stack capacity.....	803
Description.....	803
Environment.....	803
Programming requirements.....	803
Restrictions.....	803
Input register information.....	803
Output register information.....	803
Performance implications.....	804
Syntax.....	804
Parameters.....	804
ABEND codes.....	805
Return codes.....	805
Example 1.....	806
Example 2.....	806
Chapter 79. PGLOAD – Load virtual storage areas into central storage.....	807
Description.....	807
Syntax.....	807
Parameters.....	808
Example 1.....	808
Example 2.....	809
Example 3.....	809
PGLOAD—List form.....	809
Syntax.....	809
Parameters.....	809
Chapter 80. PGOUT – Page out virtual storage areas from central storage.....	811
Description.....	811
Syntax.....	811
Parameters.....	812
Example 1.....	812
Example 2.....	812
PGOUT—List form.....	812
Syntax.....	812

Parameters.....	813
Chapter 81. PGRLSE – Release virtual storage contents.....	815
Description.....	815
Syntax.....	815
Parameters.....	816
Example 1.....	816
Example 2.....	816
PGRLSE - List form.....	816
Syntax.....	816
Parameters.....	817
PGRLSE - Execute form.....	817
Syntax.....	817
Parameters.....	818
Chapter 82. PGSER – Page services.....	819
Description.....	819
Environment.....	819
Programming requirements.....	819
Restrictions.....	819
Input register information.....	819
Output register information.....	820
Performance implications.....	820
Syntax.....	820
Parameters.....	821
ABEND codes.....	822
Return and reason codes.....	823
Examples.....	824
Chapter 83. POST – Signal event completion.....	825
Description.....	825
Environment.....	825
Programming requirements.....	825
Restrictions.....	825
Input register information.....	826
Output register information.....	826
Performance implications.....	826
Syntax.....	826
Parameters.....	827
Return and reason codes.....	827
Example 1.....	827
Example 2.....	828
Chapter 84. QRYLANG – Determine languages available for message translation	829
Description.....	829
Environment.....	829
Programming requirements.....	829
Restrictions.....	829
Input register information.....	830
Output register information.....	830
Performance implications.....	830
Syntax.....	830
Parameters.....	831
Return and reason codes.....	831
Example.....	832
Chapter 85. REFPAT – Define and end a reference pattern.....	835

Description.....	835
Environment.....	835
Programming requirements.....	836
Restrictions.....	836
Input register information.....	836
Output register information.....	836
Performance implications.....	836
Syntax.....	837
Parameters.....	837
Return and reason codes.....	838
Example 1.....	839
Example 2.....	839
REFPAT—List form.....	839
Syntax.....	839
Parameters.....	840
REFPAT—Execute form.....	840
Syntax.....	840
Parameters.....	841
Chapter 86. RESERVE — Reserve a device (shared DASD).....	843
Description.....	843
Environment.....	843
Programming requirements.....	843
Restrictions.....	843
Input register information.....	844
Output register information.....	844
Syntax.....	844
Parameters.....	845
ABEND codes.....	847
Return and reason codes.....	847
Example.....	849
RESERVE—List form.....	849
Parameters.....	851
RESERVE - Execute form.....	851
Parameters.....	852
Chapter 87. RETURN — Return control.....	853
Description.....	853
Syntax.....	853
Parameters.....	853
Example.....	854
Chapter 88. SAVE — Save register contents.....	855
Description.....	855
Syntax.....	855
Parameters.....	855
Example.....	856
Chapter 89. SETRP — Set return parameters.....	857
Description.....	857
Environment.....	857
Programming requirements.....	857
Restrictions.....	857
Input register information.....	857
Output register information.....	858
Performance implications.....	858
Syntax.....	858

Parameters.....	860
ABEND codes.....	862
Return and reason codes.....	862
Example 1.....	863
Example 2.....	863
Chapter 90. SNAP and SNAPX – Dump virtual storage and continue.....	865
Description.....	865
Environment.....	865
Input register information.....	866
Output register information.....	866
Programming requirements.....	866
Restrictions.....	867
Performance implications.....	867
Syntax.....	867
Parameters.....	869
Return and reason codes.....	872
Example 1.....	872
Example 2.....	872
Example 3.....	873
Example 4.....	873
Example 5.....	873
SNAPX – Dump virtual storage and continue.....	873
Syntax.....	873
Parameters.....	875
SNAP and SNAPX—List form.....	875
Syntax.....	875
Parameters.....	877
SNAP and SNAPX—Execute form.....	877
Syntax.....	877
Parameters.....	879
Chapter 91. SPIE – Specify program interruption exit.....	881
Description.....	881
Environment.....	881
Programming requirements.....	882
Restrictions.....	882
Input register information.....	882
Output register information.....	882
Performance implications.....	883
Syntax.....	883
Parameters.....	883
ABEND codes.....	884
Return and reason codes.....	884
Example.....	884
SPIE—List form.....	885
Syntax.....	885
Parameters.....	885
SPIE - Execute form.....	885
Syntax.....	885
Parameters.....	886
Chapter 92. SPLEVEL – Set macro level.....	887
Description.....	887
Environment.....	888
Programming requirements.....	888
Restrictions.....	888

Input register information.....	888
Output register information.....	888
Performance implications.....	888
Syntax.....	888
Parameters.....	889
ABEND codes.....	889
Return and reason codes.....	889
Example 1.....	889
Example 2.....	889
Chapter 93. STAE – Specify task abnormal exit.....	891
Description.....	891
Syntax.....	891
Parameters.....	892
Return codes.....	893
Example.....	893
STAE - List form.....	893
Syntax.....	893
Parameters.....	894
STAE - Execute form.....	894
Syntax.....	895
Parameters.....	895
Example.....	896
Chapter 94. STATUS – Start and stop a subtask.....	897
Description.....	897
Environment.....	897
Programming requirements.....	897
Restrictions.....	897
Input register information.....	897
Output register information.....	897
Performance implications.....	898
Syntax.....	898
Parameters.....	898
Return codes.....	899
Example 1.....	899
Example 2.....	899
Chapter 95. STCKCONV – Store clock conversion routine.....	903
Description.....	903
Environment.....	903
Programming requirements.....	903
Restrictions.....	903
Input register information.....	903
Output register information.....	904
Performance implications.....	904
Syntax.....	904
Parameters.....	905
ABEND codes.....	906
Return codes.....	906
Example 1.....	907
Example 2.....	907
STCKCONV—List form.....	907
Syntax.....	907
Parameter.....	908
Example.....	908
STCKCONV - Execute form.....	908

Syntax.....	908
Parameters.....	909
Example.....	909
Chapter 96. STCKSYNC – Store clock synchronous service.....	911
Description.....	911
Environment.....	911
Programming requirements.....	911
Restrictions.....	911
Input register information.....	912
Output register information.....	912
Performance implications.....	912
Syntax.....	912
Parameters.....	913
ABEND codes.....	913
Return codes.....	913
Example 1.....	914
Example 2.....	914
Chapter 97. STIMER – Set interval timer.....	915
Description.....	915
Environment.....	915
Programming requirements.....	915
Restrictions.....	915
Input register information.....	916
Output register information.....	916
Performance implications.....	917
Syntax.....	917
Parameters.....	917
ABEND codes.....	919
Return and reason codes.....	919
Examples.....	920
Chapter 98. STIMERM – Set, test, cancel multiple interval timer.....	921
Description.....	921
Environment.....	922
Programming requirements.....	922
Restrictions.....	922
Input register information.....	923
Output register information.....	923
Performance implications.....	923
Syntax.....	923
Parameters.....	924
ABEND codes.....	927
Return codes.....	928
Example 1.....	929
Example 2.....	929
Example 3.....	929
Example 4.....	929
Example 5.....	930
Example 6.....	930
Example 7.....	930
Example 8.....	930
STIMERM—List form.....	930
Syntax.....	930
Parameters.....	931
Example 1.....	931

Example 2.....	931
Example 3.....	931
STIMERM - Execute form.....	931
Syntax.....	932
Parameters.....	933
Example 1.....	933
Example 2.....	933
Example 3.....	934
Chapter 99. STORAGE – Obtain and release storage.....	935
Description.....	935
Environment.....	935
Programming requirements.....	935
Restrictions.....	935
Register information.....	935
Performance implications.....	936
OBTAIN option of STORAGE.....	936
Input register information for LINKAGE=SYSTEM.....	936
Output register information for LINKAGE=SYSTEM.....	936
Input register information for LINKAGE=SVC.....	937
Output register information for LINKAGE=SVC.....	937
Syntax.....	938
Parameters.....	940
ABEND codes.....	945
Return and reason codes.....	945
RELEASE option of STORAGE.....	947
Input register information.....	947
Output register information.....	947
Syntax.....	947
Parameters.....	948
ABEND codes.....	950
Return and reason codes.....	950
Examples of the OBTAIN and RELEASE options.....	950
Chapter 100. SYMRBLD – Building a symptom record.....	953
Description.....	953
Environment.....	954
Programming requirements.....	954
Restrictions.....	954
Input register information.....	954
Output register information.....	954
Performance implications.....	955
Syntax with INITIAL option.....	955
Parameters with INITIAL option.....	956
Syntax with PRIMARY option.....	958
Parameters with PRIMARY option.....	959
Syntax with SECONDARY option.....	962
Parameters with SECONDARY option.....	963
Syntax with VARIABLE option.....	965
Parameters with VARIABLE option.....	965
Syntax with COMPLETE option.....	966
Parameters with COMPLETE option.....	967
ABEND codes with COMPLETE option.....	967
Return and reason codes (for SYMRBLD COMPLETE, INVOKE=YES).....	968
Syntax with RESET option.....	968
Parameters with RESET option.....	968
Example.....	970

Chapter 101. SYMREC – Process a symptom record.....	971
Description.....	971
Environment.....	971
Programming requirements.....	971
Restrictions.....	971
Input register information.....	972
Output register information.....	972
Performance implications.....	972
Syntax.....	972
Parameters.....	973
ABEND codes.....	973
Return and reason codes.....	973
SYMREC—List form.....	976
Syntax.....	976
Parameters.....	977
SYMREC - Execute form.....	977
Syntax.....	977
Parameters.....	977
Chapter 102. SYNCH and SYNCHX – Take a synchronous exit to a processing program.....	979
Description.....	979
Environment.....	979
Programming requirements.....	980
Restrictions.....	980
Input register information.....	980
Output register information.....	980
Performance implications.....	980
Syntax.....	980
Parameters.....	981
Return and reason codes.....	981
Example 1.....	982
Example 2.....	982
Example 3.....	982
Example 4.....	982
Example 5.....	982
SYNCHX - Take a synchronous exit to a processing program.....	982
Environment.....	982
Programming requirements.....	982
Register information.....	983
Syntax.....	983
Parameters.....	983
SYNCH and SYNCHX—List form.....	984
Syntax.....	984
Parameters.....	984
Example.....	984
SYNCH and SYNCHX—Execute form.....	985
Syntax.....	985
Parameters.....	985
Example.....	985
Chapter 103. SYSEVENT – System event.....	987
Description.....	987
Chapter 104. SYSSTATE – Identify system state.....	989
Description.....	989

Environment.....	990
Programming requirements.....	990
Restrictions.....	990
Input register information.....	990
Output register information.....	990
Performance implications.....	990
Syntax.....	990
Parameters.....	992
ABEND codes.....	994
Return and reason codes.....	994
Example 1.....	994
Example 2.....	994
Example 3.....	994
Example 4.....	994
Chapter 105. TCBTOKEN – Request or translate the TTOKEN.....	995
Description.....	995
Environment.....	995
Programming requirements.....	995
Restrictions.....	995
Input register information.....	995
Output register information.....	995
Performance implications.....	996
Syntax.....	996
Parameters.....	997
ABEND codes.....	997
Return codes.....	997
Example.....	998
TCBTOKEN—List form.....	998
Syntax.....	998
Parameters.....	999
TCBTOKEN—Execute form.....	999
Syntax.....	999
Parameters.....	1000
Chapter 106. TESTART – Tests the validity of ALETs.....	1001
Description.....	1001
Environment.....	1001
Programming requirements.....	1001
Restrictions.....	1001
Input register information.....	1001
Output register information.....	1001
Performance implications.....	1002
Syntax.....	1002
Parameters.....	1003
ABEND codes.....	1003
Return codes.....	1003
Example 1.....	1004
Example 2.....	1004
Chapter 107. TIME – Obtain time and date.....	1005
Description.....	1005
LINKAGE=SYSTEM.....	1005
Environment.....	1005
Programming requirements.....	1006
Restrictions.....	1006
Input register information.....	1006

Output register information.....	1006
Performance implications.....	1006
Syntax.....	1007
Parameters.....	1007
ABEND codes.....	1009
Return codes.....	1009
Example 1.....	1009
Example 2.....	1010
LINKAGE=SYSTEM - List form.....	1010
Syntax.....	1010
Parameters.....	1010
Example.....	1010
LINKAGE=SYSTEM - Execute form.....	1011
Syntax.....	1011
Parameters.....	1012
Example.....	1012
LINKAGE=SVC.....	1012
Environment.....	1012
Programming requirements.....	1012
Restrictions.....	1012
Input register information.....	1012
Output register information.....	1012
Performance implications.....	1013
Syntax.....	1013
Parameters.....	1014
ABEND codes.....	1015
Return and reason codes.....	1015
Example 1.....	1015
Example 2.....	1015
Example 3.....	1015
Chapter 108. TIMEUSED – Obtain accumulated CPU or vector time.....	1017
Description.....	1017
Environment.....	1017
Programming requirements.....	1017
Restrictions.....	1017
Input register information.....	1017
Output register information.....	1017
Performance implications.....	1018
Syntax.....	1018
Parameters.....	1019
ABEND codes.....	1020
Return codes.....	1021
Examples.....	1021
Chapter 109. TRANMSG – Translate messages.....	1023
Description.....	1023
Environment.....	1023
Programming requirements.....	1023
Restrictions.....	1024
Input register information.....	1024
Output register information.....	1024
Performance implications.....	1024
Syntax.....	1024
Parameters.....	1026
Return and reason codes.....	1026
Example 1.....	1030

Example 2.....	1030
Example 3.....	1032
Example 4.....	1032
Example 5.....	1033
Chapter 110. TTIMER – Test interval timer.....	1037
Description.....	1037
Environment.....	1037
Programming requirements.....	1037
Restrictions.....	1037
Input register information.....	1037
Output register information.....	1037
Performance implications.....	1038
Syntax.....	1038
Parameters.....	1038
ABEND codes.....	1039
Return codes.....	1039
Example 1.....	1039
Example 2.....	1039
Chapter 111. UCBDEVN – Return EBCDIC device number for a UCB.....	1041
Description.....	1041
Environment.....	1041
Programming requirements.....	1041
Restrictions.....	1041
Input register information.....	1042
Output register information.....	1042
Performance implications.....	1042
Syntax.....	1042
Parameters.....	1043
Return and reason codes.....	1043
Example.....	1043
Chapter 112. UCBINFO – Return information from a UCB.....	1045
Description.....	1045
Environment.....	1045
Programming requirements.....	1046
Restrictions.....	1046
Input register information.....	1046
Output register information.....	1046
Performance implications.....	1047
UCBINFO DEVCOUNT.....	1047
Syntax.....	1047
Parameters.....	1048
Return and reason codes.....	1050
Example.....	1051
UCBINFO DEVCOUNT—List form.....	1051
Parameters.....	1051
UCBINFO DEVCOUNT—Execute form.....	1052
Parameters.....	1053
UCBINFO DEVINFO.....	1053
Syntax.....	1054
Parameters.....	1054
Return and reason codes.....	1055
Example.....	1056
UCBINFO DEVINFO - List form.....	1057
Parameters.....	1057

UCBINFO DEVINFO - Execute form.....	1058
Parameters.....	1059
UCBINFO GETCDR.....	1059
Syntax.....	1059
UCBINFO GETCDR - List form.....	1060
Parameters.....	1060
UCBINFO GETCDR - Execute form.....	1061
Parameters.....	1062
UCBINFO HYPERPAVALIASES.....	1062
Syntax.....	1062
Parameters.....	1063
Return and reason codes.....	1064
Example.....	1066
UCBINFO HYPERPAVALIASES - List form.....	1066
Parameters.....	1067
UCBINFO HYPERPAVALIASES - Execute form.....	1067
Parameters.....	1068
UCBINFO PATHINFO.....	1068
Syntax.....	1068
Parameters.....	1069
Return and reason codes.....	1070
Example.....	1071
UCBINFO PATHINFO - List form.....	1072
Parameters.....	1072
UCBINFO PATHINFO - Execute form.....	1073
Parameters.....	1074
UCBINFO PATHMAP.....	1074
Syntax.....	1074
Parameters.....	1075
Return and reason codes.....	1076
Example.....	1077
UCBINFO PATHMAP - List form.....	1077
Parameters.....	1078
UCBINFO PATHMAP - Execute form.....	1078
Parameters.....	1079
UCBINFO PAVINFO.....	1079
Syntax.....	1079
Parameters.....	1081
Return and reason codes.....	1083
Example.....	1084
UCBINFO PAVINFO - List form.....	1084
Parameters.....	1085
UCBINFO PAVINFO - Execute form.....	1085
Parameters.....	1086
UCBINFO PRFXDATA.....	1087
Syntax.....	1087
Parameters.....	1088
Return and reason codes.....	1089
Example.....	1089
UCBINFO PRFXDATA - List form.....	1090
Parameters.....	1090
UCBINFO PRFXDATA - Execute form.....	1091
Parameters.....	1092
Chapter 113. UCBSAN – Scan UCBs.....	1093
Description.....	1093
Environment.....	1093

Programming requirements.....	1093
Restrictions.....	1093
Input register information.....	1093
Output register information.....	1094
Performance implications.....	1094
Syntax.....	1094
Parameters.....	1096
Return and reason codes.....	1100
UCBSCAN COPY - List form.....	1101
Syntax.....	1101
Parameters.....	1102
UCBSCAN COPY - Execute form.....	1102
Syntax.....	1102
Parameters.....	1104

Chapter 114. UPDTMPB – Update a message parameter block for substitution

data.....	1107
Description.....	1107
Environment.....	1107
Programming requirements.....	1107
Restrictions.....	1107
Input register information.....	1107
Output register information.....	1107
Performance implications.....	1108
Syntax.....	1108
Parameters.....	1109
Return and reason codes.....	1110
Example.....	1110

Chapter 115. VRADATA – Update variable recording area data.....1113

Description.....	1113
Environment.....	1113
Programming requirements.....	1113
Restrictions.....	1113
Input register information.....	1114
Output register information.....	1114
Performance implications.....	1115
Syntax.....	1115
Parameters.....	1116
ABEND codes.....	1117
Return and reason codes.....	1117
Example 1.....	1117
Example 2.....	1118

Chapter 116. WAIT – Wait for one or more events..... 1119

Description.....	1119
Environment.....	1119
Programming requirements.....	1119
Restrictions.....	1119
Input register information.....	1120
Output register information.....	1120
Performance implications.....	1120
Syntax.....	1120
Parameters.....	1121
Example.....	1122
ABEND codes.....	1122
Return and reason codes.....	1122

Example 1.....	1122
Example 2.....	1122
Example 3.....	1123
Chapter 117. WTL – Write to log.....	1125
Description.....	1125
Environment.....	1125
Programming requirements.....	1125
Restrictions.....	1126
Input register information.....	1126
Output register information.....	1126
Performance implications.....	1126
Syntax.....	1126
Parameters.....	1127
ABEND codes.....	1127
Return and reason codes.....	1127
Example 1.....	1130
Example 2.....	1130
WTL - List form.....	1130
Syntax.....	1130
Parameters.....	1130
WTL - Execute form.....	1131
Syntax.....	1131
Parameters.....	1131
Chapter 118. WTO- Write to operator.....	1133
Description.....	1133
Environment.....	1133
Programming requirements.....	1133
Restrictions.....	1134
Input register information.....	1134
Output register information.....	1134
Performance implications.....	1135
Syntax.....	1135
Parameters.....	1136
ABEND codes.....	1142
Return and reason codes.....	1142
Example 1.....	1143
Example 2.....	1143
Example 3.....	1144
Example 4.....	1144
WTO - List form.....	1145
Syntax.....	1145
Parameters.....	1147
Example.....	1147
WTO - Execute form.....	1147
Syntax.....	1147
Parameters.....	1148
Example 1.....	1148
Example 2.....	1148
Chapter 119. WTOR - Write to operator with reply.....	1149
Description.....	1149
Environment.....	1149
Programming requirements.....	1149
Restrictions.....	1150
Input register information.....	1150

Output register information.....	1150
Performance implications.....	1150
Syntax.....	1150
Parameters.....	1152
ABEND codes.....	1157
Return and reason codes.....	1157
Example 1.....	1157
Example 2.....	1157
Example 3.....	1158
WTOR - List form.....	1158
Syntax.....	1158
Parameters.....	1160
WTOR - Execute form.....	1160
Syntax.....	1160
Parameters.....	1162

Chapter 120. XCTL and XCTLX - Pass control to a program in another load

module.....	1163
XCTL and XCTLX description.....	1163
Environment.....	1164
Syntax.....	1164
Parameters.....	1165
Return and reason codes.....	1165
Example.....	1165
XCTLX - Pass control to a program in another load module.....	1166
Syntax.....	1166
Parameters.....	1166
XCTL and XCTLX - List form.....	1166
Syntax.....	1167
Parameters.....	1167
XCTL - Execute form.....	1167
Syntax.....	1167
Parameters.....	1168
XCTLX - Execute form.....	1169
Syntax.....	1169
Parameters.....	1170
Examples of passing data to the target module.....	1172
Example 1.....	1172
Example 2.....	1172
Example 3.....	1173
Example 4.....	1173

Appendix A. Accessibility.....1175

Accessibility features.....	1175
Consult assistive technologies.....	1175
Keyboard navigation of the user interface.....	1175
Dotted decimal syntax diagrams.....	1175

Notices.....1179

Terms and conditions for product documentation.....	1180
IBM Online Privacy Statement.....	1181
Policy for unsupported hardware.....	1181
Minimum supported hardware.....	1181
Programming interface information.....	1182
Trademarks.....	1182

Index..... 1183

Figures

- 1. Sample User Parameter List for Callers in AR Mode..... 5
- 2. Sample tabular syntax diagram for the TEST macro..... 12
- 3. Continuation Coding..... 14
- 4. Return Code Area Used by RESERVE.....847

Tables

1. Passing User Parameters in AR Mode.....	4
2. Execution environment characteristics and corresponding SYSSTATE parameters and global symbols.....	5
3. Service Summary.....	16
4. Return and Reason Codes for the IARCP64 Macro.....	34
5. Return and Reason Codes for the IARR2V Macro.....	40
6. Return and Reason Codes for the IARST64 Macro.....	55
7. Return and Reason Codes for the IARV SERV Macro.....	62
8. Return and Reason Codes for the IARV64 Macro.....	72
9. Return and reason codes for the IEAFP macro.....	132
10. Return and reason codes for the IEAGSF macro.....	141
11. Return Codes for IEALSQRY.....	149
12. Return Codes for the IEAMETR Macro.....	153
13. Return and Reason Codes for the IEATDUMP Macro.....	195
14. Return codes for the IEATXDC Macro.....	205
15. Authorization.....	209
16. Checkpoint/Restart Toleration - only available when the CVTPAUS4 bit is set in the CVT.....	209
17. Authorization.....	213
18. Checkpoint/Restart Toleration - only available when the CVTPAUS4 bit is set in the CVT.....	213
19. Linkage option.....	216
20. Linkages.....	231
21. Authorization.....	287
22. Checkpoint/Restart Toleration - only available when the CVTPAUS4 bit is set in the CVT.....	287

23. Linkage option.....	293
24. Linkages.....	307
25. Return and reason codes for the IEFDDSRV macro.....	371
26. Return and reason codes for the IEFOPZQ macro.....	383
27. Return and Reason Codes for the IEFPRMLB Macro.....	397
28. Return and Reason Codes for the IEFSSI Macro.....	420
29. Return and reason codes for the IOSCHPD macro.....	436
30. Return and reason codes for the IOSSCM macro.....	448
31. Return and Reason Codes for the ISGENQ Macro.....	467
32. Return and Reason Codes for the ISGQUERY Macro.....	497
33. Return and Reason Codes for the ITZEVENT Macro.....	528
34. Return and Reason Codes for the ITZQUERY Macro.....	535
35. Return and Reason Codes for the IXGBRWSE Macro.....	566
36. Return and reason codes for the IXGCONN macro.....	593
37. Return and Reason Codes for the IXGDELET Macro.....	614
38. Return and Reason Codes for the IXGIMPRT Macro.....	629
39. Valid special (graphical) characters:.....	656
40. Valid special (graphical) characters:.....	678
41. Return and Reason Codes for the IXGINVNT Macro.....	686
42. Return and Reason Codes for the IXGINVNT Macro.....	710
43. Return and Reason Codes for the IXGOFFLD Macro.....	738
44. Return and Reason Codes for the IXGQUERY Macro.....	750
45. Return and Reason Codes for the IXGUPDAT Macro.....	760
46. Return and reason codes for the IXGWRITE macro.....	772
47. Return and Reason Codes for the LSEXPAND Macro.....	805

48. Return Codes for the RESERVE Macro with the RET=TEST Parameter.....	848
49. Return Codes for the RESERVE Macro with the RET=USE Parameter.....	848
50. Return Codes for the RESERVE Macro with the RET=HAVE Parameter.....	849
51. Return and Reason Codes for the STAE Macro.....	893
52. Return Codes for the STATUS Macro.....	899
53. Return Codes for the STCKCONV Macro.....	906
54. Return Codes for the STCKSYNC Macro.....	913
55. Return Codes for the STIMERM Macro.....	928
56. Return Codes for STORAGE OBTAIN.....	945
57. Return Codes for the STORAGE RELEASE.....	950
58. Valid SDB Key Names and Literals.....	960
59. Valid Section 5 Key Names and Literals.....	966
60. Return codes for the TCBTOKEN macro.....	998
61. Return Codes for the TESTART Macro.....	1003
62. Return Codes for the TIME Macro.....	1009
63. Return and Reason Codes for the TIMEUSED Macro.....	1021
64. Return Codes for the TTIMER Macro.....	1039
65. MCSFLAG Flag Names for WTO Macro.....	1139
66. MCSFLAG Flag Names for WTOR Macro.....	1155

About this information

This information describes some of the macros (or macro instructions) that the system provides. The macros described in this information are available to any assembler language program.

Programmers who code in assembler language can use these macros to invoke the system services that they need. This document includes the detailed information — such as the function, syntax, and parameters — needed to code the macros.

Who should use this information

This information is for any programmer who is coding an assembler language program. However, if the program runs with APF authorization, runs in supervisor state or runs with system key 0-7, runs in supervisor state or with system key 0-7, or if it performs functions that are more system than application-oriented, the programmer should also refer to the following documents:

- *z/OS MVS Programming: Authorized Assembler Services Reference ALE-DYN*
- *z/OS MVS Programming: Authorized Assembler Services Reference EDT-IXG*
- *z/OS MVS Programming: Authorized Assembler Services Reference LLA-SDU*
- *z/OS MVS Programming: Authorized Assembler Services Reference SET-WTO*

Programmers using this information should have a knowledge of the computer, as described in *Principles of Operation*, as well as a knowledge of assembler language programming.

System macros require High Level Assembler. For more information about assembler language programming, see *High Level Assembler and Toolkit Feature in IBM Documentation* (www.ibm.com/docs/en/hla-and-tf/1.6).

Using this information also requires you to be familiar with the operating system and the services that programs running under it can invoke.

How to use this information

This information is one of the set of programming documents for MVS™. This set describes how to write programs in assembler language or high-level languages, such as C, FORTRAN, and COBOL. For more information about the content of this set of documents, see *z/OS Information Roadmap*.

z/OS information

This information explains how z/OS references information in other documents and on the web.

When possible, this information uses cross document links that go directly to the topic in reference using shortened versions of the document title. For complete titles and order numbers of the documents for all products that are part of z/OS, see *z/OS Information Roadmap*.

To find the complete z/OS® library, go to *IBM Documentation* (www.ibm.com/docs/en/zos).

How to send your comments to IBM

We invite you to submit comments about the z/OS product documentation. Your valuable feedback helps to ensure accurate and high-quality information.

Important: If your comment regards a technical question or problem, see instead [“If you have a technical problem”](#) on page [xlvii](#).

Submit your feedback by using the appropriate method for your type of comment or question:

Feedback on z/OS function

If your comment or question is about z/OS itself, submit a request through the [IBM RFE Community](#) (www.ibm.com/developerworks/rfe/).

Feedback on IBM® Documentation function

If your comment or question is about the IBM Documentation functionality, for example search capabilities or how to arrange the browser view, send a detailed email to IBM Documentation Support at ibmdocs@us.ibm.com.

Feedback on the z/OS product documentation and content

If your comment is about the information that is provided in the z/OS product documentation library, send a detailed email to mhvrcfs@us.ibm.com. We welcome any feedback that you have, including comments on the clarity, accuracy, or completeness of the information.

To help us better process your submission, include the following information:

- Your name, company/university/institution name, and email address
- The following deliverable title and order number: z/OS MVS Assembler Services Reference IAR-XCT, SA23-1370-50
- The section title of the specific information to which your comment relates
- The text of your comment.

When you send comments to IBM, you grant IBM a nonexclusive authority to use or distribute the comments in any way appropriate without incurring any obligation to you.

IBM or any other organizations use the personal information that you supply to contact you only about the issues that you submit.

If you have a technical problem

If you have a technical problem or question, do not use the feedback methods that are provided for sending documentation comments. Instead, take one or more of the following actions:

- Go to the [IBM Support Portal](#) (support.ibm.com).
- Contact your IBM service representative.
- Call IBM technical support.

Summary of changes

This information includes terminology, maintenance, and editorial changes. Technical changes or additions to the text and illustrations for the current edition are indicated by a vertical line to the left of the change.

Summary of changes for z/OS Version 2 Release 4

New

The following information has been added in this release:

June 2021 refresh

- The SYMBOLSUB=, REMOVECOM=, and RDSNINFO= keywords are added to the REQUEST=ALLOCATE and REQUEST=READMEMBER options of the IEFPRMLB macro. See [“REQUEST=ALLOCATE option of IEFPRMLB” on page 388](#) and [“REQUEST=READMEMBER option of IEFPRMLB” on page 408](#).
- The DSNTTEST={NO|YES} option is added to the IEATDUMP service with APAR OA60029.

September 2020 refresh

- The REQUEST=CHANGEATTRIBUTE option is added to the IARV64 service via APAR OA58289. See [REQUEST=CHANGEATTRIBUTE option of IARV64](#).

June 2020 refresh

- Clarification about the use of the COND parameter has been added in [Chapter 6, “IARV64 – 64-bit virtual storage allocation,” on page 71](#).

Prior to June 2020 refresh

- The SENSITIVE parameter has been added in [Chapter 2, “IARCP64 – 64-bit cell pool services,” on page 23](#), [Chapter 4, “IARST64 – 64-bit storage services,” on page 43](#), and [“REQUEST=GETSTOR option of IARV64” on page 73 \(APAR OA57633\)](#).
- RMODE 64-bit capabilities added to [Chapter 104, “SYSSTATE – Identify system state,” on page 989](#) and [“LOAD description” on page 795](#).
- New return and reason codes for [Chapter 67, “IXGBRWSE – Browse/read a log stream,” on page 537](#) and [Chapter 73, “IXGQUERY – Query a log stream or system logger for information,” on page 743](#) are added for system logger enhancement to support security options for log stream unique access.
- The INORIGIN parameter has been added to the IARV64 GETSTOR service. See [“REQUEST=GETSTOR option of IARV64” on page 73](#).
- The ASYNCH parameter is added to the IEAARR service. See [Chapter 8, “IEAARR – Establish an associated recovery routine \(ARR\),” on page 117](#).
- New reason code for the IARR2V macro are described in [Table 5 on page 40](#). See Locks in [“Environment” on page 37](#) for information on locks for the IARR2V macro (APAR OA57695).

Changed

The following information has been updated in this release:

June 2021 refresh

- For the RESERVE service, the description of the RET=USE parameter has been updated. See [Parameters](#).

January 2021 refresh

- The WTO macro is updated to clarify parameter ,DESC=(descriptor code). See [“Description” on page 1133](#) for more information.
- Information about the IEAFP service has been refreshed. See [Chapter 11, “IEAFP – Floating point services,” on page 129.](#)

October 2020 refresh

- For APAR OA57908, the INORIGIN parameter is updated in the IARV64 GETSTOR service. See [“REQUEST=GETSTOR option of IARV64” on page 73.](#)

September 2020 refresh

- The WTO and WTOR macros are updated to replace the value RX with RS on the CONSNAME and KEY parameters. See [“WTO - Execute form” on page 1147](#) and [“WTOR - Execute form” on page 1160](#) for more information.
- The description of the CONVERT parameter has been updated in [“REQUEST=CHANGEGUARD option of IARV64” on page 87](#) via APAR OA58289.
- The description of the STCKCONV service is updated. See [“Description” on page 903.](#)

Prior to September 2020 refresh

- An additional action was added to return code 4 for the STORAGE RELEASE option. See [“Return and reason codes” on page 950.](#)
- STG_DATACLAS, STG_MGMTCLAS, STG_STORCLAS, and STG_SIZE [“Parameters for REQUEST=UPDATE” on page 666](#) of IXGINVNT are updated in support of APAR OA53275.
- Chapter 67, [“IXGBRWSE – Browse/read a log stream,” on page 537](#), Chapter 68, [“IXGCONN – Connect/disconnect to log stream,” on page 583](#), and Chapter 71, [“IXGINVNT – Managing the LOGR, LOGRY and LOGRZ inventory active system logger couple data set,” on page 637](#) are updated for system logger enhancement to support single-system scope Couple Data Set types (LOGRY and LOGRZ) for GDPS K-system environments.
- Return and reason codes for Chapter 67, [“IXGBRWSE – Browse/read a log stream,” on page 537](#), Chapter 72, [“IXGOFFLD – Initiate offload to DASD log data sets,” on page 733](#) and Chapter 74, [“IXGUPDAT – Update log stream control information,” on page 755](#) are updated for system logger enhancement to support security options for log stream unique access.
- Chapter 68, [“IXGCONN – Connect/disconnect to log stream,” on page 583](#) is updated for system logger enhancement to support security options for log stream unique access.
- The ORIGIN= parameter on the IARV64 REQUEST=GETSTORE is updated with the contents of the address returned to the caller when MEMLIMIT is exceed and if there is a RETCODE=8, see [“,ORIGIN=origin” on page 79](#) for more information.

Deleted

The following information has been deleted in this release:

Next refresh

The X'630' and X'638' codes were incorrectly included in Chapter 60, [“ISGENQ – Global resource serialization ENQ service,” on page 449](#) and have been deleted.

June 2020 refresh

- The IARST64 service incorrectly included information about the EXECUTABLE parameter. The EXECUTABLE parameter has been removed from [Chapter 4, “IARST64 – 64-bit storage services,” on page 43.](#)

Summary of changes for z/OS Version 2 Release 3

The following information has been added, changed, or deleted in z/OS Version 2 Release 3 (V2R3). The most recent updates are listed at the top of each section.

New

- Return code 06 has been added to [Chapter 57, “IOSCHPD – IOS CHPID description service,”](#) on page 431.
- The USE2GTO32G and USE2GTO64G parameters have been added in [“REQUEST=GETSTOR option of IARV64”](#) on page 73.
- Additional AMODE descriptions have been added to [“LOAD description”](#) on page 795.
- A description has been added to the CALLRKY=YES storage key in the [“OBTAIN option of STORAGE”](#) on page 936.
- Programming description and access register contents for AR has been added to [Chapter 108, “TIMEUSED – Obtain accumulated CPU or vector time,”](#) on page 1017.
- Added new EXECUTABLE parameter for API IARV64 to [“REQUEST=GETSTOR option of IARV64”](#) on page 73.
- Added new EXECUTABLE parameter for API STORAGE to [“OBTAIN option of STORAGE”](#) on page 936.

Changed

- [“Programming requirements”](#) on page 866 in [“Description”](#) on page 865 have been slightly reorganized for clarity.
- Changes have been made to the **BUFFLEN** parameter for the BUFFER64 keyword in [Chapter 73, “IXGQUERY – Query a log stream or system logger for information,”](#) on page 743.
- Changes have been made to the MODE parameter and return code 04 in [Chapter 69, “IXGDELET – Deleting log data from a log stream,”](#) on page 607 and [Chapter 75, “IXGWRITE – Write log data to a log stream,”](#) on page 765.
- APAR OA53212 - The EXIT parameter description was clarified in [Chapter 98, “STIMERM – Set, test, cancel multiple interval timer,”](#) on page 921.
- The OSREL parameter has been updated in [Chapter 104, “SYSSTATE – Identify system state,”](#) on page 989.
- The ARCHLVL parameter has been updated in [Chapter 104, “SYSSTATE – Identify system state,”](#) on page 989.
- The DUPLEXMODE(DRXRC) is removed from [“Parameters for REQUEST=DEFINE,TYPE=LOGSTREAM”](#) on page 644 and [“Parameters for REQUEST=UPDATE”](#) on page 666.
- The STG_SIZE is updated in [“Parameters for REQUEST=DEFINE,TYPE=LOGSTREAM”](#) on page 644 and [“Parameters for REQUEST=UPDATE”](#) on page 666.

Deleted

- APAR OA53248 - Return code 1C has been removed from the [“OBTAIN option of STORAGE”](#) on page 936.

Summary of changes for z/OS Version 2 Release 2 (V2R2), as updated December, 2015

The following changes are made for z/OS Version 2 Release 2 (V2R2), as updated December, 2015. In this revision, all technical changes for z/OS V2R2 are indicated by a vertical line to the left of the change.

New

- IARV64 has a new SADMP parameter for REQUEST=GETSTOR.
- The following callable services have been added:
 - [Chapter 28, “IEAVPME2 – pause multiple elements service,” on page 227](#)
 - [Chapter 42, “IEA4PME2 – 64-bit pause multiple elements service,” on page 303 .](#)
- The IEFOPZQ macro has been added in [Chapter 53, “IEFOPZQ – Query the IEFOPZ configuration,” on page 375.](#)
- IXGWRITE has a new return code 08, reason code xxxx084E.

Changed

- IARCP64 REQUEST=FREE now accepts the INPUT_CPID parameter.
- Restrictions are updated for the following callable services:
 - [Chapter 24, “IEAVAPE – Allocate_Pause_Element,” on page 207](#)
 - [Chapter 38, “IEA4APE – Allocate_Pause_Element,” on page 285](#)
 - [Chapter 25, “IEAVAPE2 – Allocate_Pause_Element,” on page 211](#)
 - [Chapter 39, “IEA4APE2 – Allocate_Pause_Element,” on page 289.](#)

Summary of changes for z/OS Version 2 Release 2

The following information is new, changed, or deleted in z/OS Version 2 Release 2 (V2R2).

New

- The PAGEFRAMESIZE parameter has been added in [“REQUEST=GETSTOR option of IARV64” on page 73.](#)
- A new IOSSCM service has been added in [Chapter 59, “IOSSCM – Storage class memory information,” on page 443.](#)
- Option REQUEST=CHECKDEF was added to [Chapter 71, “IXGINVNT – Managing the LOGR, LOGRY and LOGRZ inventory active system logger couple data set,” on page 637.](#)

Changed

- Information about the environment, parameters, and return and reason codes has been updated in [Chapter 52, “IEFDDSRV – DD service,” on page 361.](#)
- Information about the CHPID parameter and reason codes has been updated in [Chapter 57, “IOSCHPD – IOS CHPID description service,” on page 431.](#)
- The description of the information returned in register 1 has been updated in [Chapter 77, “LOAD – Bring a load module into virtual storage,” on page 795.](#)
- Information is updated for the LOGSTREAM LS_ALLOCAHEAD attribute and log stream offload processing in [Chapter 71, “IXGINVNT – Managing the LOGR, LOGRY and LOGRZ inventory active system logger couple data set,” on page 637.](#)

Chapter 1. Using the services

Macros and callable services are programming interfaces that application programs can use to access MVS system services. This chapter provides general information and guidelines about how to use the macros and callable services accurately and efficiently. For more specific and detailed information about coding a particular macro or callable service, see the individual service description in this information.

Some of the topics covered in this chapter apply only to macros, some apply only to callable services, and some apply to both. This chapter uses the word "services" when referring to information that applies to both service types. When information applies only to one type or the other, the particular service type is specified.

Note: z/OS macros do not code to restrictions that are imposed by the COMPAT(CASE) HLASM option or its abbreviation CPAT(CASE). Therefore, you cannot rely on using COMPAT(CASE) if you use z/OS macros.

The following table lists the topics covered in this chapter and whether the topic applies to macros, callable services, or both:

Topic	Service Type
<u>Compatibility of MVS macros</u>	Macros
<u>Addressing mode (AMODE)</u>	Both
<u>Address space control (ASC) mode</u>	Both
<u>ALET qualification</u>	Both
<u>User parameters</u>	Macros
<u>Telling the system about the execution environment</u>	Macros
<u>Specifying a macro version number</u>	Macros
<u>Register use</u>	Both
<u>Handling return codes and reason codes</u>	Both
<u>Handling program errors</u>	Both
<u>Handling environmental and system errors</u>	Both
<u>Using X-macros</u>	Macros
<u>Macro forms</u>	Macros
<u>Coding the macros</u>	Macros
<u>Coding the callable services</u>	Callable Services
<u>Including equate (EQU) statements</u>	Callable Services
<u>Link-editing linkage-assist routines</u>	Callable Services
<u>Service summary</u>	Both

Compatibility of MVS macros

When IBM introduces a new version or a new release of an existing version, the new version or release supports all MVS macros from previous versions and releases. Programs assembled on an earlier level of MVS that issue macros will run on later levels of MVS.

In most cases, the reverse is also true. When you assemble programs that issue macros on a particular version and release of MVS, those programs can run on earlier versions and releases of MVS, provided you request only those functions that are supported by the earlier version and release. This is useful for

installations that write applications that might be assembled on one level of MVS, but run on a different level.

As MVS supports new architectures, addressability changes. To take best advantage of the new architectures, some macros have more than one possible expansion. You are required to have the macro expand according to the environment in which the program runs. This topic is described in this introductory information.

The problem of compatibility is not the same as selecting a macro version through the PLISTVER parameter to ensure the correct parameter list size for a macro. For selecting a parameter list version number, see [Specifying a macro version number](#).

Addressing mode (AMODE)

A program can run in addressing mode (AMODE) 24, 31, or 64. A program that executes in AMODE 24 or 31 can invoke most of the services described in this information. A program that executes in AMODE 64 has a smaller group of services that it can invoke.

In general:

- A program running in AMODE 24 cannot pass parameters or parameter addresses that are higher than 16 megabytes. However, there are exceptions. For example, a program running in AMODE 24 can:
 - Free storage above 16 megabytes using the FREEMAIN macro
 - Allocate storage above 16 megabytes using the GETMAIN macro
 - Use cell pool services for cell pools located in storage above 16 megabytes using the CPOOL macro
 - Use page services for storage locations above 16 megabytes using the PGSER macro
- A program is allowed to call a service from AMODE 64 only if the documentation for the service indicates that it supports AMODE 64.
- A program is allowed to call a service from RMODE 64 only if the documentation for the service indicates that it supports RMODE 64.
- A program running in AMODE 64 should not call a service with data, parameters, or parameter addresses that are higher than 2 gigabytes, unless the individual service description indicates that it is allowed.
- If a program running in AMODE 31 or 64 issues a service, parameters and parameter addresses can be above or below 16 megabytes, unless otherwise stated in the individual service description.

Some macros can generate code that is appropriate for programs in either AMODE 64 or 24 or 31. These macros check a global symbol set by the SYSSTATE macro. See [Telling the system about the execution environment](#) for more information.

When you call a callable service in AMODE 24 or 31, you must pass 31-bit addresses to the system service regardless of what addressing mode your program is running in. If your program is running in AMODE 24 and you use a callable service, you must set the high-order byte of parameter addresses to zeros.

You can invoke the following services in 64-bit addressing mode, subject to the “SVC or PC” restrictions mentioned later in this topic, but you cannot pass parameters and parameter addresses above 2 gigabytes: ABEND, ATTACHX, CALLDISP, CHAP, CSVQUERY, DELETE, DEQ, DETACH, DOM, DSPSERV, DYNALLOC, ENQ, ESPIE, ESTAEX, EXCP, FREEMAIN, GETMAIN, GTRACE, IARVserv, IDENTIFY, IEAARR, LINKX, LOAD, MODESET, PGSER, POST, RESERVE, SDUMPX, SETRP, STAX, STIMER, STIMERM, STORAGE, SYNCHX, TIME, TIMEUSED, TTIMER, VRADATA, WAIT, WTO, WTOR, and XCTL.

There are many services that support AMODE 64 and parameter addresses above 2 gigabytes. Examples are IRAV64, IARST64, and ISGENQ. For details on the supported addressing mode and parameter address ranges for any specific service, see the following books:

- [z/OS MVS Programming: Assembler Services Reference ABE-HSP](#)
- [z/OS MVS Programming: Assembler Services Reference IAR-XCT](#)

- [z/OS MVS Programming: Authorized Assembler Services Reference ALE-DYN](#)
- [z/OS MVS Programming: Authorized Assembler Services Reference EDT-IXG](#)
- [z/OS MVS Programming: Authorized Assembler Services Reference LLA-SDU](#)
- [z/OS MVS Programming: Authorized Assembler Services Reference SET-WTO](#)
- [z/OS MVS Programming: Sysplex Services Reference](#)

Before invoking a service in AMODE 64, you must inform system macros, by specifying SYSSTATE AMODE64=YES. You can invoke only those options that result in calling the system by an SVC or PC in AMODE 64. You cannot invoke any option that results in calling the system by a branch-entry in AMODE 64.

Unless explicitly stated otherwise, assume that a given service cannot be invoked in AMODE 64 and cannot accept data, parameters, or parameter addresses above 2 gigabytes. Such an explicit statement would include a specific reference to AMODE 64 in a macro's environment section and additional information would mention that data, parameters, and parameter addresses could be above 2 gigabytes. By contrast, an AMODE specification of "Any" means that the macro can be invoked in either AMODE 24 or 31; it does not mean that the macro can be invoked in AMODE 64.

For information about AMODE 64 and the 64-bit GPR, see [z/OS MVS Programming: Assembler Services Guide](#).

Address space control (ASC) mode

A program can run in either primary ASC mode or access register (AR) ASC mode. In primary mode, the processor uses the contents of general purpose registers (GPRs) to resolve an address to a specific location. In AR mode, the processor uses the contents of ARs as well as the contents of GPRs to resolve an address to a specific location. See [z/OS MVS Programming: Assembler Services Guide](#) for more detailed information about AR mode.

Some macros can generate code that is appropriate for programs in either primary mode or AR mode. These macros check a global symbol set by the SYSSTATE macro. See [Telling the system about the execution environment](#) for more information. [Table 1](#) lists the macros that check the global symbol.

Some services can generate code that is appropriate for programs in primary mode only. If you write a program in AR mode that invokes one or more services, check the description in this information for each service your program issues. Unless the description indicates that a service supports callers in AR mode, the service *does not* support callers in AR mode. In this case, use the SAC instruction to change the ASC mode of your program and issue the service in primary mode.

Whether the caller is in primary or AR ASC mode, the system uses ARs 0-1 and 14-15 as work registers across any service call.

ALET qualification

The address space where you can place parameters varies with the individual service:

- You can place parameters in the primary address space in all service.
- You must place parameters in the primary address space in some services.
- You can place parameters in any address space in some services.

To identify where you can locate parameters in a service, read the individual service description.

Programs in AR mode that pass parameters must use an access register and the corresponding general purpose register together (for example, access register 1 and general purpose register 1) to identify where the parameters are located. The access register must contain an access list entry token (ALET) that identifies the address space where the parameters reside. The general purpose register must identify the location of the parameters within the address space.

The only ALETs that MVS services typically accept are:

- Zero (0), which specifies that the parameters are in the caller's primary address space

- An ALET for a public entry on the caller's dispatchable unit access list (DU-AL)
- An ALET for a common area data space (CADS)

MVS services do not accept the following ALETs, and you cannot attempt to pass them to a service:

- One (1), which signifies that the parameters are in the caller's secondary address space
- An ALET that is on the caller's primary address space access list (PASN-AL) that does not represent a CADS

Throughout, this information uses the term **AR/GPR *n*** to mean an access register and its corresponding general purpose register. For example, to identify access register 1 and general purpose register 1, this information uses **AR/GPR 1**.

User parameters

Some macros that you can issue in AR mode include control parameters, user parameters, or both. Control parameters refer to the macro parameter list, and the parameters whose addresses are in the parameter list. Control parameters control the operation of the macro itself. User parameters are parameters that a user provides to be passed through to a user routine. For example, the PARAM parameter on the ATTACHX macro defines user parameters. The ATTACHX macro passes these parameters to the routine that it attaches. All other parameters on the ATTACHX macro are control parameters that control the operation of the ATTACHX macro.

Note:

1. User parameters are sometimes referred to as problem program parameters.
2. Control parameters are sometimes referred to as system parameters or control program parameters.

The macros shown in [Table 1](#) allow a caller in AR mode to pass information in the form of a parameter list (or parameter lists) to another routine. This table identifies the parameter that receives the ALET-qualified address of the parameter list and tells you where the target routine finds the ALET-qualified address.

Macro	Parameter	Location of User Parameter List Address
ATTACH/ATTACHX CALL LINK/LINKX XCTL/XCTLX	PARAM,VL=1	AR/GPR 1 contains the address of a list of addresses. When either <ul style="list-style-type: none"> • a 4-bytes-per-entry parameter list or • an 8-bytes-per-entry parameter list with PLIST8ARALETs=YES is being used, this list also contains the ALETs associated with those addresses. (See Figure 1 for the format of the 4-bytes-per-entry parameter list when it contains ALETs.)
ESTAEX	PARAM	SDWAPARM contains the address of an 8-byte area, which contains the address and ALET of the parameter list.

When an AR mode caller who is using a 4-bytes-per-entry parameter list passes ALET-qualified addresses to the called program through PARAM,VL=1 on the ATTACH/ATTACHX, CALL, LINK/LINKX, or XCTL/XCTLX macros, the system builds a list formatted as shown in [Figure 1](#). The addresses passed to the called program are at the beginning of the list, and their associated ALETs follow the addresses. The last address in the list has the high-order bit on to indicate the end of the list. For example, [Figure 1](#) shows the format of a list where an AR mode issuer of ATTACHX who is using a 4-bytes-per-entry parameter list has coded the PARAM parameter as follows:

```
PARAM=(A,B,C),VL=1
```

When an AR mode caller who is using an 8-bytes-per-entry parameter list specifies PLIST8BARALETs=YES, the system builds a parameter list with the 8-byte addresses at the beginning of the list and their associated 4-byte ALETs following the addresses.

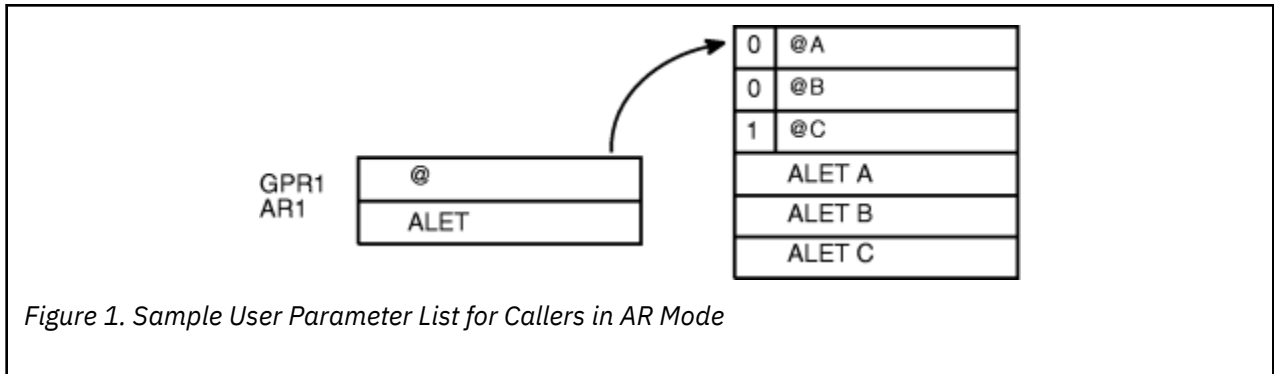

Figure 1. Sample User Parameter List for Callers in AR Mode

For information about linkage conventions, see the chapter in *z/OS MVS Programming: Assembler Services Guide*.

Telling the system about the execution environment

To generate code that is correct for the environment in which the program runs, some macros need to know one or more of the following characteristics about that environment:

- The addressing mode (AMODE) at the time the macro is issued
- The ASC mode of the program at the time the macro is issued
- The architectural level in which the program runs

For macros that are sensitive to their environment, use the SYSSTATE macro to define the environment. During the assembly stage, SYSSTATE sets one or more global symbols. Later, in your source code, the macro checks the global symbols and generates the correct code, which might mean avoiding using a z/Architecture[®] instruction or an access register. [Table 1](#) lists MVS macros and identifies macros that need to know the environmental characteristics.

IBM recommends you issue the SYSSTATE macro before you issue other macros. Once a program has issued SYSSTATE, there is no need to reissue it, unless the program switches from one AMODE to another or one ASC mode to another or has code paths that are isolated according to architecture level or operating system release. If you switch AMODE or ASC mode to a different architecture code path, issue SYSSTATE immediately after the switch to indicate the new state. In general, specify SYSSTATE ARCHLVL=2, and switch to SYSSTATE ARCHLVL=3 before issuing macros in sections of code that only run when z/OS 2.1 capabilities are available. If you do not issue the SYSSTATE macro, the system assumes the macro is issued as follows:

- In AMODE other than 64-bit
- In primary ASC mode
- Usually, in ESA/390 architectural level (but may assume z/Architecture level since all supported z/OS releases require z/Architecture level)

[Table 1](#) describes the relevant characteristics, the corresponding parameters on the SYSSTATE macro, and the global symbols the macro checks.

Characteristic	Parameter on SYSSTATE	Global symbol
AMODE of 64-bit, or either 24-bit or 31-bit	AMODE64=YES or NO	&SYSAM64
Primary or AR ASC mode	ASCENV=P or AR	&SYSASCE
Architectural level of z/Architecture	ARCHLVL=0, 1, 2, 3 or OSREL	&SYSALVL
Operating system release	ZOSVrRr	&SYSOSREL

You can issue the SYSSTATE macro with the TEST parameter in your own user-written macro to allow your macros to generate code appropriate for their execution environment.

Callable services do not check the global symbols described in this topic. To determine whether a callable service is sensitive to the AMODE, ASC mode, or the Architecture level, see the description of the individual callable service.

In early releases of MVS, the SPLEVEL macro performs a function similar to SYSSTATE. The SPLEVEL macro identifies the level of the operating system, so that you can tune a macro expansion based on that level. You can use this where macro expansions change incompatibly. Because SPLEVEL applies to levels that the system no longer supports, it is not described in this topic.

Specifying a macro version number

Often there is more than one version of a macro, differentiated by additional parameters or new or expanded function. For example, version 1 of the IXGCONN macro provides a connection to a log stream, while version 2 adds new parameters in support of resource manager programs. This is different than using the SPLEVEL macro to select a macro version level to solve problems of downward compatibility.

You can request a specific version of a macro based on the parameters you need to use in your application, but you should also be attuned to the storage constraints of the program. The version of a macro might affect the length of the parameter list generated when the macro is assembled, because when you add new parameters to a macro, the parameter list must be large enough to fit them. The size of the parameter list might grow from release to release of z/OS, perhaps affecting the amount of storage your program needs.

How to request a macro version using PLISTVER

Many macros that have one or more versions supply the PLISTVER parameter. For those that do, use the PLISTVER parameter to request a version of the macro. PLISTVER is the only parameter allowed on the list form of a macro (MF), and it determines which parameter list the system generates. PLISTVER is optional. If you omit it, the system generates a parameter list for the lowest version that will accommodate the parameters specified. This is the IMPLIED_VERSION default. Note that on the list form, the default will cause the smallest parameter list to be created.

You can also code a specific version number using *plistver*, or specify MAX:

- You can use *plistver* to code a decimal value corresponding to the version of the macro you require. The decimal value you provide determines the amount of storage allotted for the parameter list.
- You can use **MAX** to request that the system generate a parameter list for the highest version number currently available. The amount of storage allotted for the parameter list will depend on the level of the system on which the macro is assembled.

IBM recommends, if your program can tolerate additional growth, that you always specify PLISTVER=MAX on the list form of the macro. MAX ensures that the list form parameter list is always long enough to hold whatever parameters might be specified on the execute form when both forms are assembled using the save level of the system.

Hints for using PLISTVER

There are some general considerations that you should keep in mind when specifying the version of a macro with PLISTVER:

- If PLISTVER is omitted, the macro generates a parameter list of the lowest version that allows all the parameters specified to be processed.
- If you code PLISTVER=*n* and then specify any version '*n*+1' parameter, the macro will not assemble.
- If you code PLISTVER=*n* and do not specify any version '*n*' parameter, the macro will generate a version '*n*' parameter list.
- If you are using the standard form of the macro (MF=S), there is no reason you need to code the PLISTVER parameter.

- Not all macros have the same version numbers. The version numbers need not be contiguous.

The PLISTVER parameter appears in the syntax diagram and in the parameter descriptions. Within each macro description, the PLISTVER parameter description specifies the range of values and lists the parameters applicable for each version of the macro.

Register use

Some services require that the caller place information in specific general purpose registers (GPRs) or access registers (ARs) prior to issuing the service. If a service has such a requirement, the “Input Register Information” topic for the service provides that information. The topic lists only those registers that have a requirement. If a register is not specified as having a requirement, then the caller does not have to place any information in that register unless using it in register notation for a particular parameter, or using it as a base register.

Once the caller issues the service, the system can change the contents of one or more registers, and leave the contents of other registers unchanged. When control returns to the caller, each register contains one of the following values or has the following status:

- The register content is preserved and is the same as it was before the service was issued.
- The register contains a value placed there by the system for the caller's use. Examples of such values are return codes and tokens.
- The system used the register as a work register. Do not assume that the register content is the same as it was before the service was issued.

Unless otherwise defined by the individual interface, the calling program expects upon return:

- The low halves (Bits 32-63) of GPRs 0, 1, 14, 15 are not preserved; the low halves of GPRs 2-13 are preserved.
- The high halves (Bits 0-31) of GPRs 0, 1, and 15 are not preserved; the high halves of GPRs 2-14 are preserved.
- When GPR 0, 1, 14, and/or 15 is defined as unchanged, unless otherwise stated by the individual interface, that definition applies only to the low halves of those registers.
- ARs 0,1, 14, 15 are not preserved; ARs 2-13 are preserved.

For more information about linkage conventions for a calling program's registers, see the "Saving the calling program's registers" topic in the "Linkage conventions" chapter in [z/OS MVS Programming: Assembler Services Guide](#).

Some callers depend on register contents remaining the same before and after issuing a service. If the system changes the contents of registers on which the caller depends, the caller must save them before issuing the service, and restore them after the system returns control.

Many macros require that the caller have a program base register and assembler USING instruction in effect when issuing the macro; that is, the caller must have *program addressability*. AR mode programs also require that the AR associated with the caller's base GPR be set to zero. **IBM recommends** the following:

- When issuing a macro, the caller should always have program addressability in effect.
- When establishing addressability, the caller should use only registers 2 through 12.

Many macros can take advantage of relative branching when they are used with the IEABRC macro or with SYSSTATE ARCHLVL=1 or SYSSTATE ARCHLVL=2, if they are running on z/OS. If relative branching is used, the caller might then need addressability only to the static data portion of the program, and not to the executable code.

Handling return codes and reason codes

Most of the services described in this information provide return codes and reason codes. Return and reason codes indicate the outcome of the service in one of the following ways:

- Successful completion: you do not need to take any action.
- Successful or partially successful completion, with additional information supplied: you should evaluate the additional information in light of your particular program and determine if you need to take any action.
- Unsuccessful completion: some type of error has occurred, and you must take some action to correct the error.

The errors that cause unsuccessful completion fall into three broad categories:

Program errors

Errors that your program causes: you can correct these.

Environmental errors

Errors not caused directly by your program; rather, your program's request caused a limit to be exceeded, such as a storage limit, or the limit on the size of a particular data set. You might or might not be able to correct these.

System errors

Errors caused by the system: your program did nothing to cause the error, and you probably cannot correct these.

In some cases, a return or reason code can result from some combination of these errors.

The return and reason code descriptions for the services in this information indicate whether the error is a program error, an environmental error, a system error, or some combination. Whenever possible, the return and reason code descriptions give you a specific action that you can take to fix the error.

IBM recommends that you read all the return and reason codes for each service that your program issues. You can then design your program to handle as many errors as possible. When designing your program, you should allow for the possibility that future releases of MVS might add new return and reason codes to a service that your program issues.

Handling program errors

The actions to take in the case of program errors are usually straightforward. Typical examples of program errors are:

1. Breaking one of the rules of the service. For example:
 - Passing parameters that are either in the wrong format or not valid
 - Violating one of the environment requirements (addressing mode, locking requirements, dispatchable unit mode, and so on)
 - Providing insufficient storage for information to be returned by the system.
2. Causing errors related to the parameter list. For example:
 - Coding an incorrect combination of parameters
 - Coding one or more parameters on the service incorrectly
 - Inadvertently overlaying an area of the parameter list storage
 - Inadvertently destroying the pointer to the parameter list.
3. Requesting a service or function for which the calling program is not authorized, or which is not available on the system on which the program is running.

In each of the first two cases, you can correct your program. For completeness, the return and reason code descriptions give you specific actions to perform, even when it might seem obvious what the action should be.

In the third case, you might have to contact your system administrator or system programmer to obtain the necessary authorization, or to request that the service or function be made available on your system, and the return or reason code description asks you to take that step.

Note: Generally, the system does not take dumps for errors that your program causes when issuing a system service. If you require such a dump, then it is your responsibility to request one in your recovery

routine. See the topic on providing recovery in *z/OS MVS Programming: Assembler Services Guide* for information about writing recovery routines.

Handling environmental and system errors

With environmental errors, often your first action should be to rerun your program or retry the request one or more times. The following are examples of environmental errors where rerunning your program or retrying the request is appropriate:

- The request being made through the service exceeds some internal system limit. Sometimes, rerunning your program or retrying the request results in successful completion. If the problem persists, it might be an indication of a larger problem requiring you to consult your system programmer, or possibly IBM support personnel. Your system programmer might be able to tune the system or cancel users so that the limit is no longer exceeded.
- The request exceeds an installation-defined limit. If the problem persists, the action might be to contact your system programmer and request that a specification in an installation exit or parmlib member be modified.
- The system cannot obtain storage, or some other resource, for your request. If the problem persists, the action might be to check with the operator to see if another user in the installation is causing the problem, or to see if the entire installation is experiencing storage constraint problems.

You might be able to design your program to anticipate certain environmental errors and handle them dynamically.

With system errors, as with environmental errors, often your first action should be to rerun your program or retry the request one or more times. If the problem persists, you might have to contact IBM support personnel.

Whenever possible for environmental and system errors, the return or reason code description gives you either a specific action you can take, or a list of recommended actions you can try.

For some errors, providing a specific action is not possible, because the action you should take depends on your particular application, and on what is happening in your installation. In those cases, the return or reason code description gives you one or more possible causes of the error to help you to determine what action to take.

Some system errors result in return and reason codes that are provided for IBM diagnostic purposes only. In these cases, the return or reason code description asks you to record the information and provide it to the appropriate IBM support personnel.

Using X-macros

Some MVS services support callers in both primary and AR ASC mode. When the caller is in AR mode, macros must generate larger parameter lists; the increased size of the list reflects the addition of ALETs to qualify addresses, as described under [ALET qualification](#). For some MVS macros, two versions of a particular macro are available: one for callers in primary mode and one for callers in AR mode. The name of the macro for the AR mode caller is the same as the name of the macro for primary mode callers, except the AR mode macro name ends with an “X”. This information refers to these macros as **X-macros**.

The X-macros described in this information are:

- ATTACHX
- ESTAEX
- LINKX
- SNAPX
- SYNCHX
- XCTLX

The only way these macros know that a caller is in AR mode is by checking the global symbol that the SYSSTATE macro sets. Each of these macros (and corresponding non-X-macro) checks the symbol. If

SYSSTATE ASCENV=AR has been issued, the macro issues code that is valid for callers in AR mode. If it has not been issued, the macro generates code that is not valid for callers in AR mode. When your program returns to primary mode, use the SYSSTATE ASCENV=P macro to reset the global symbol.

IBM recommends that you use the X-macro regardless of whether your program is running in primary or AR mode. However, you should consider the following before deciding which macro to use:

The rules for using all X-macros, except ESTAEX, are:

- Callers in primary mode can invoke either macro.

Some parameters on the X-macros, however, are not valid for callers in primary mode. Some parameters on the non-X-macros are not valid for callers in AR mode. Check the macro descriptions for these exceptions.

- Callers in AR mode should issue the X-macros.

If a caller in AR mode issues the non-X-macro, the system substitutes the X-macro and sends a message describing the substitution.

IBM recommends you always use ESTAEX unless your program and your recovery routine are in 24-bit addressing mode, in which case, you should use ESTAE.

Macro forms

You can code most macros in three forms: standard, list, and execute. Some macros also have a modify form. When you code a macro, you use the MF parameter to select one of the forms. The list, execute and modify forms are for reenterable programs that need to change values in the parameter list of the macro. The standard form is for programs that are not reenterable, or for programs that do not change values in the parameter list.

When a program wants to change values in the parameter list of a macro, it can make the change dynamically.

However, using the standard form and changing the parameter list dynamically might cause errors. For example, after storing a new value into the inline, standard form of the parameter list, a reenterable program operating under a given task might be interrupted by the system before the program can invoke the macro. In a multiprogramming environment, another task can use the same reenterable program, and that task might change the inline parameter list again before the first task regains control. When the first task regains control, it invokes the macro. However, the inline parameter list now has the wrong values.

Through the use of the different macro forms, a program that runs in a multiprogramming environment can avoid errors related to reenterable programs. The techniques required for using the macro forms, however, are different for some macros, called alternative list form macros, than for most other macros. For the alternative list form macros, the list form description notes that different techniques are required and refers you to the information under [Alternative list form macros](#).

Conventional list form macros

With conventional list form macros, you can use the macro forms as follows:

1. Use the list form of the macro, which expands to the parameter list. Place the list form in the section of your program where you keep non-executable data, such as program constants. Do not code it in the instruction stream of your program.
2. In the instruction stream, code a GETMAIN or a STORAGE macro to obtain some virtual storage.
3. Code a move character instruction that moves the parameter list from its non-executable position in your program into the virtual storage area that you obtained.
4. For macros that have a modify form, you can code the modify form of the macro to change the parameter list. Use the address parameter of the modify form to reference the parameter list in the virtual storage area that you obtained. Thus, the parameter list that you change is the one in the virtual storage area obtained by the GETMAIN or STORAGE macro.

5. Invoke the macro by issuing the execute form of the macro. Use the address parameter of the execute form to reference the parameter list in the virtual storage area that you obtained.

With this technique, the parameter list is safe even if the first task is interrupted and a second task intervenes. When the program runs under the second task, it cannot access the parameter list in the virtual storage of the first task.

Alternative list form macros

Certain macros, called alternative list form macros, require a somewhat different technique for using the list form. With these macros, you do not move the area defined by the list form into virtual storage that you have obtained; instead, you place the area defined by the list form into a DSECT. Also, it is the list form, not the execute form, that you use to specify the address parameter that identifies the address of the storage for the parameter list. Note that no modify form is available for these macros.

You can use the macro forms for the alternative list form macros as follows:

1. Use the list form of the macro to define an area of storage that the execute form can use to store the parameters. As with other macros, do not code the list form in the instruction stream of your program.
2. In the instruction stream, code a GETMAIN or a STORAGE macro to obtain virtual storage for the list form expansion.
3. Place the area defined by the list form into a DSECT that maps a portion of the virtual storage you obtained.
4. Invoke the macro by issuing the execute form of the macro. The address parameter specified on the list form references the parameter list in the virtual storage area that you obtained.

Coding the macros

In this information, each macro description includes a syntax diagram near the beginning of the macro description. The diagram shows how to code the macro. The syntax diagram does not explain the meanings of the parameters; the meanings are explained in the parameter descriptions that follow the syntax diagram. For most macros, the syntax diagrams are in a tabular format; however, some newer macros might have syntax diagrams in the railroad track format.

The syntax tables assume that the standard begin, end, and continue columns are used. Thus, column 1 is assumed as the begin column. To change the begin, end, and continue columns, use the ICTL instruction to establish the coding format you want to use. If you do not use ICTL, the assembler recognizes the standard columns. For more information about coding the ICTL instruction, see [High Level Assembler and Toolkit Feature in IBM Documentation \(www.ibm.com/docs/en/hla-and-tf/1.6\)](http://www.ibm.com/docs/en/hla-and-tf/1.6).

Figure 1 shows a sample macro called TEST and summarizes all the coding information that is available for it. The table is divided into three zones, A, B, and C.

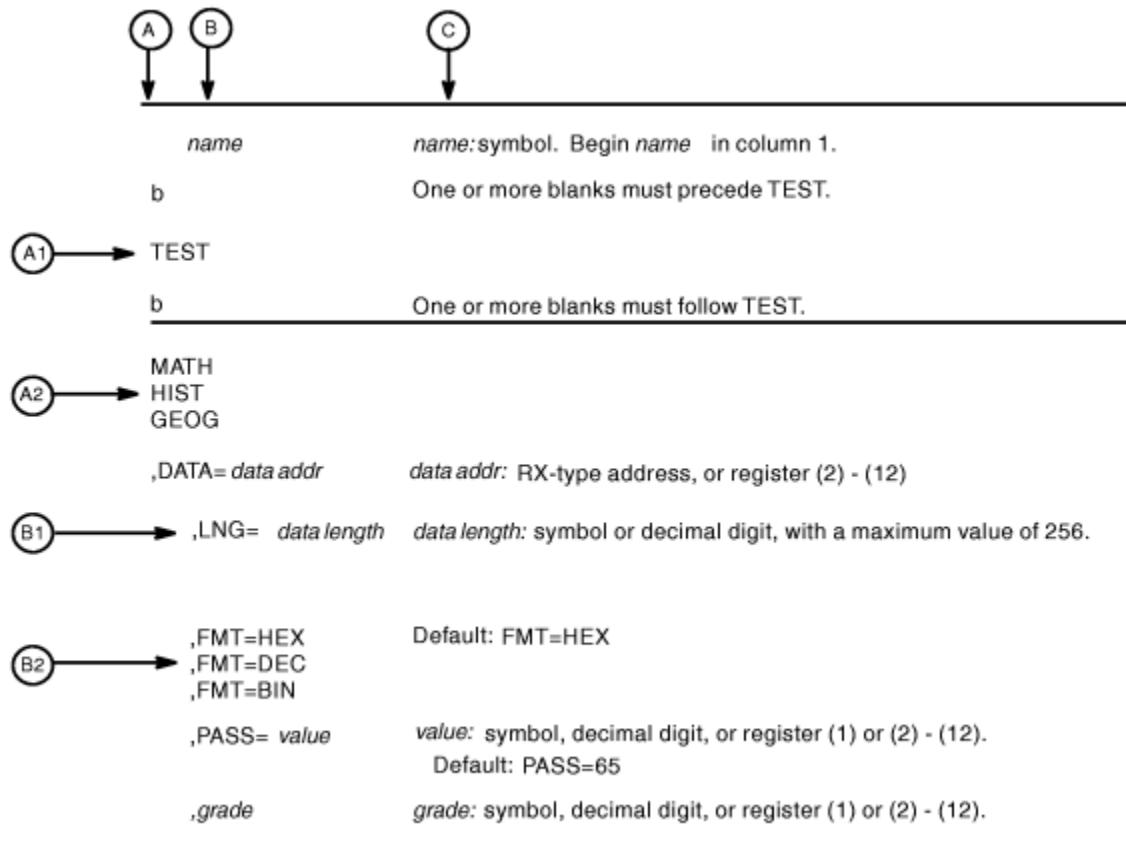

Figure 2. Sample tabular syntax diagram for the TEST macro

- Column one of the table contains zones A and B. Zone A begins at the left margin; zone B is indented from the left margin by one or more blank spaces. Column two of the table contains zone C.
- Zone A and zone B contain those parameters that are allowed for the macro. Zone A contains those parameters that are required; zone B contains those parameters that are optional.
- If a parameter appears on a single line in the diagram (that is, a line whose preceding line and following line are both blank), as shown in A1 and B1, then that is the only available choice for the particular parameter.
- If two or more parameters appear on adjacent lines (that is, with no intervening blank lines), as shown in A2 and B2, the parameters on those lines are mutually exclusive, that is, you can code any one of those parameters.
- A further distinction is made between mandatory and optional parameters. The parameter descriptions that follow the syntax table clearly identify those parameters which are optional.
- Zone C (which is the second column in the syntax table), provides additional information about coding the macro.

When substitution of a variable is indicated in zone C, the following classifications are used:

**Variable
Classification**

symbol

Any symbol valid in the assembler language. The symbol can be as long as the supported maximum length of a name entry in the assembler you are using.

Decimal digit

Any decimal digit up to and including the value indicated in the parameter description. If both symbol and decimal digit are indicated, an absolute expression is also allowed.

Register (2) - (12)

One of general purpose registers 2 through 12, specified within parentheses, previously loaded with the right-adjusted value or address indicated in the parameter description. You must set the unused high-order bits to zero. You can designate the register symbolically or with an absolute expression.

Register (0)

General purpose register 0, previously loaded with the right-adjusted value or address indicated in the parameter description. You must set the unused high-order bits to zero. Designate the register as (0) only.

Register (1)

General purpose register 1, previously loaded with the right-adjusted value or address indicated in the parameter description. You must set the unused high-order bits to zero. Designate the register as (1) only.

Register (15)

General purpose register 15, previously loaded with the right-adjusted value or address indicated in the parameter description. You must set the unused high-order bits to zero. Designate the register as (15) only.

RX-type address

Any address that is valid in an RX-type instruction (for example, LA).

RS-type address

Any address that is valid in an RS-type instruction (for example, STM).

RS-type name

Any name that is valid in an RS-type instruction (for example, STM).

A-type address

Any address that can be written in an A-type address constant.

Default

A value that is used in default of a specified value; that is, the value the system assumes if the parameter is not coded.

Rules for parameters: Use the parameters to specify the services and options to be performed, and write them according to the following rules:

- If the selected parameter is written in all capital letters (for example, MATH, HIST, or FMT=HEX), code the parameter exactly as shown.
- If the selected parameter is written in italics (for example, *grade*), substitute the indicated value, address, or name.
- If the selected parameter is a combination of capital letters and italics separated by an equal sign (for example, DATA=*data addr*), code the capital letters and equal sign as shown, and then make the indicated substitution for the italicized portion.
- Read the table from top to bottom.
- Code commas and parentheses exactly as shown.
- Positional parameters (parameters without equal signs) appear first; you must code them in the order shown. You may code keyword parameters (parameters with equal signs) in any order.
- If you select a parameter, read the second column (zone C) before proceeding to the next parameter. The second column often contains coding restrictions for the parameter.

Continuation lines

You can continue the parameter field of a macro on one or more additional lines according to the following rules:

- Enter a continuation character (not blank, and not part of the parameter coding) in column 72 of the line.
- Continue the parameter field on the next line, starting in column 16. All columns to the left of column 16 must be blank.

You can code the parameter field being continued in one of two ways. Code the parameter field through column 71, with no blanks, and continue in column 16 of the next line; or truncate the parameter field by a comma, where a comma normally falls, with at least one blank before column 71, and then continue in column 16 of the next line. Figure 1 shows an example of each method.

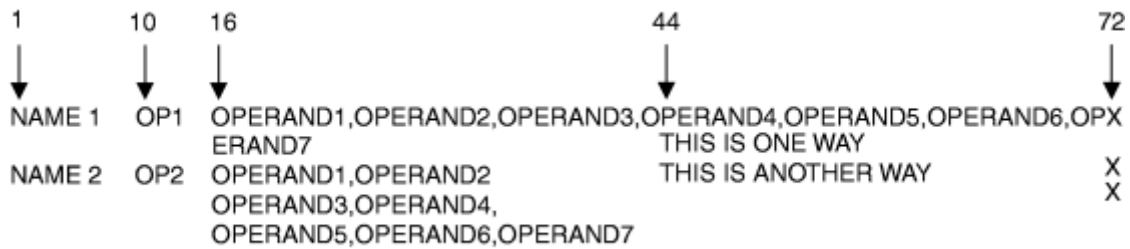

Figure 3. Continuation Coding

Coding the callable services

A callable service is a programming interface that uses the CALL macro to access system services. To code a callable service, code the CALL macro followed by the name of the callable service, and a parameter list; for example:

```
CALL service,(parameter list)
```

The syntax diagram for the sample callable service SCORE:

Syntax	Description
CALL SCORE	,(test_type ,level ,data ,format_option ,return_code)

Considerations for coding callable services are:

- You must code all the parameters in the parameter list because parameters are positional in a callable service interface. That is, the function of each parameter is determined by its position with respect to the other parameters in the list. Omitting a parameter, therefore, assigns the omitted parameter's function to the next parameter in the list.
- You must place values explicitly into all input parameters, because callable services do not set default values.
- You can use the list and execute forms of the CALL macro to preserve your program's reentrancy.

Including equate (EQU) statements

IBM supplies sets of equate (EQU) statements for use with some callable services. These statements, which you may optionally include in your source code, provide constants for use in your program. IBM provides the statements as a programming convenience to save you the trouble of coding the definitions yourself.

Note: Check the “Programming Requirements” section of the individual service description to determine if the equate statements are available for the callable service you are using. If the equate statements are

available, that section will also provide a list of the statements that are provided, along with a description of how to include them in your program.

Link-editing linkage-assist routines

Linkage-assist routines provide the connection between your program and the system services that your program requests. When using callable services, link-edit the appropriate linkage-assist routines into your program module so that, during execution, the linkage-assist routines can resolve the address of, and pass control to, the requested system services. You can also dynamically link to linkage-assist routines as an alternative to link-editing. For example, issue the LOAD macro for the linkage-assist routine, then issue a CALL to the loaded addresses.

To invoke the linkage-editor or binder, code JCL as in the following example:

```
//userid JOB 'accounting-info', 'name', CLASS=x,
// MSGCLASS=x, NOTIFY=userid, MSGLEVEL=(1,1), REGION=4096K
//LINKSTEP EXEC PGM=HEWL,
// PARM='LIST,LET,XREF,REFR,RENT'
//SYSPRINT DD SYSOUT=x
//SYSLMOD DD DSN=userid.LOADLIB, DISP=OLD
//SYSLIB DD DSN=SYS1.CSSLIB, DISP=SHR
//OBJLIB DD DSN=userid.OBJLIB, DISP=SHR
//SYSUT1 DD UNIT=SYSDA, SPACE=(TRK, (5, 2))
//SYSLIN DD *
INCLUDE OBJLIB(userpgm)
ENTRY userpgm
NAME userpgm(R)
/*
```

Note: Omitting NCAL from the linkedit parameters (as the example shows) and specifying SYS1.CSSLIB in the //SYSLIB statement, as shown, causes the addresses of all required linkage-assist routines to be automatically resolved. This statement saves you the trouble of having to specify individual linkage-assist routines in INCLUDE statements.

Service summary

Table 1 lists services described in the following:

- [z/OS MVS Programming: Assembler Services Reference ABE-HSP](#)
- [z/OS MVS Programming: Assembler Services Reference IAR-XCT](#)

For each service, the table indicates:

- Whether a program in AR ASC mode can issue the service
- Whether a program in cross memory mode can issue the service
- Whether the macro checks the SYSSTATE global macro variables
- Whether the macro can be issued in 64-bit addressing mode

Note:

1. A program running in primary ASC mode when PASN=HASN=SASN can issue any of the services listed in the table.
2. Cross memory mode means that at least one of the following conditions is true:

PASN \neq SASN

The primary address space (PASN) and the secondary address space (SASN) are different.

PASN \neq HASN

The primary address space (PASN) and the home address space (HASN) are different.

SASN \neq HASN

The secondary address space (SASN) and the home address space (HASN) are different.

For more information about functions that are available to programs in cross memory mode, see [z/OS MVS Programming: Extended Addressability Guide](#).

3. Callable services do not check the SYSSTATE or SPLEVEL global variables.

Service	Can be issued in AR ASC mode	Can be issued in cross memory mode	Checks SYSSTATE	Can be issued in 64-bit AMODE
ABEND	Yes	Yes	Yes	Yes
ALESERV	Yes	Yes	No	No
ASASYMBM	No	No	Yes	No
ATTACH	Yes (See note 1)	No	Yes	No
ATTACHX	Yes	No	Yes	Yes
BLDMPB	Yes	Yes	No	No
BLSABDPL	Yes	Yes	N/A	No
BLSACBSP	Yes	Yes	N/A	No
BLSADSY	Yes	Yes	N/A	No
BLSAPCQE	Yes	Yes	N/A	No
BLSQFXL	Yes	Yes	N/A	No
BLSQMDEF	Yes	Yes	N/A	No
BLSQMFLD	Yes	Yes	N/A	No
BLSQSHDR	Yes	Yes	N/A	No
BLSRDRPX	Yes	Yes	N/A	No
BLSRESSY	Yes	Yes	N/A	No
BLSRNAMP	Yes	Yes	N/A	No
BLSRPRD	Yes	Yes	N/A	No
BLSRPWHS	Yes	Yes	N/A	No
BLSRSASY	Yes	Yes	N/A	No
BLSRXMSP	Yes	Yes	N/A	No
BLSRXSSP	Yes	Yes	N/A	No
BLSUPPR2	Yes	Yes	N/A	No
CALL	Yes	Yes	Yes	Yes
CHAP	No	No	No	Yes
CNZCONV	Yes	Yes	No	Yes
CNZTRKR	No	Yes	No	No
CONVCON	No	Yes	No	No
CONVTOD	Yes	Yes	No	No
CPOOL	No	Yes	Yes	No
CPUTIMER	No	Yes	Yes	No
CSRCE_SRV	Yes	Yes	No	No

Table 3. Service Summary (continued)

Service	Can be issued in AR ASC mode	Can be issued in cross memory mode	Checks SYSSTATE	Can be issued in 64-bit AMODE
CSRCMPSC	Yes	Yes	Yes	No
CSREVV	No	No	N/A	No
CSRIDAC	No	No	N/A	No
CSRL16J	No	No	N/A	No
CSRPACT	Yes	Yes	N/A	No
CSRPLD	Yes	Yes	N/A	No
CSRPCON	Yes	Yes	N/A	No
CSRPDAC	Yes	Yes	N/A	No
CSRPDIS	Yes	Yes	N/A	No
CSRPEXP	Yes	Yes	N/A	No
CSRPFRE	Yes	Yes	N/A	No
CSRPF1	Yes	Yes	N/A	No
CSRPGT	Yes	Yes	N/A	No
CSRPGT1	Yes	Yes	N/A	No
CSRQCL	Yes	Yes	N/A	No
CSRQEX	Yes	Yes	N/A	No
CSRQPL	Yes	Yes	N/A	No
CSRPRFR	Yes	Yes	N/A	No
CSRPRFR1	Yes	Yes	N/A	No
CSRPRGT	Yes	Yes	N/A	No
CSRPRGT1	Yes	Yes	N/A	No
CSRREFR	No	No	N/A	No
CSRSAVE	No	No	N/A	No
CSRSCOT	No	No	N/A	No
CSRSI	No	Yes	No	No
CSRUNIC	Yes	Yes	No	No
CSRVIEW	No	No	N/A	No
CSVAPF	Yes (See note 7)	Yes	Yes	No
CSVINFO	No	No	No	No
CSVQUERY	Yes	Yes	Yes	Yes
DELETE	No	No	No	Yes
DEQ	No	No	No	Yes
DETACH	Yes	No	Yes	No

Table 3. Service Summary (continued)

Service	Can be issued in AR ASC mode	Can be issued in cross memory mode	Checks SYSSTATE	Can be issued in 64-bit AMODE
DIV	Yes	No	Yes	No
DOM	No	No	No	Yes
DSPSERV	Yes	Yes	Yes	Yes
EDTINFO	Yes	Yes	Yes	No
ENQ	No	No	No	Yes
ESPIE	No	No	No	Yes
ESTAE (See note 2)	No	No	Yes	No
ESTAEX	Yes	Yes	Yes	Yes
EVENTS	No	No	No	No
FREEMAIN	No (See note 3)	Yes	Yes	Yes
GETMAIN	No (See note 3)	Yes	Yes	Yes
GQSCAN	No	Yes	No	No
HPSERV	Yes	Yes (See note 4)	(See note 5)	No
IARCP64	Yes	Yes	Yes	Yes
IARR2V	Yes	Yes	No	Yes
IARST64	Yes	Yes	Yes	Yes
IARVSERV	Yes	Yes	Yes	No
IARV64	Yes	Yes	Yes	Yes
IDENTIFY	No	No	No	Yes
IEAARR	Yes	Yes	Yes	No
IEABRC	Yes	Yes	N/A	No
IEAINTKN	Yes	Yes	Yes	No
IEALSQRY	Yes	Yes	Yes	No
IEAMETR	Yes	Yes	Yes	No
IEANTCR	Yes	Yes	N/A	No
IEANTDL	Yes	Yes	N/A	No
IEANTRT	Yes	Yes	N/A	No
IEATDUMP	Yes	No	Yes	No
IEATXDC	Yes	Yes	Yes	Yes
IEAVAPE	No	Yes	No	No
IEAVAPE2	No	Yes	No	No
IEAVDPE	No	Yes	No	No
IEAVDPE2	No	Yes	No	No

Table 3. Service Summary (continued)

Service	Can be issued in AR ASC mode	Can be issued in cross memory mode	Checks SYSSTATE	Can be issued in 64-bit AMODE
IEAVPSE	No	Yes	No	No
IEAVPSE2	No	Yes	No	No
IEAVRLS	No	Yes	No	No
IEAVRLS2	No	Yes	No	No
IEAVRPI	No	Yes	No	No
IEAVRPI2	No	Yes	No	No
IEAVTPE	No	Yes	No	No
IEAVXFR	No	Yes	No	No
IEAVXFR2	No	Yes	No	No
IEA4APE	No	Yes	No	Yes
IEA4APE2	No	Yes	No	Yes
IEA4DPE	No	Yes	No	Yes
IEA4DPE2	No	Yes	No	Yes
IEA4PSE	No	Yes	No	Yes
IEA4PSE2	No	Yes	No	Yes
IEA4RLS	No	Yes	No	Yes
IEA4RLS2	No	Yes	No	Yes
IEA4RPI	No	Yes	No	Yes
IEA4RPI2	No	Yes	No	Yes
IEA4TPE	No	Yes	No	Yes
IEA4XFR	No	Yes	No	Yes
IEA4XFR2	No	Yes	No	Yes
IEFDDSRV	Yes	Yes	No	No
IEFSSI	Yes	No	No	No
IOCINFO	Yes	Yes	Yes	No
IOSCHPD	Yes	Yes	Yes	No
ITZEVENT	No	Yes	No	No
ITZQUERY	No	Yes	No	No
IXGBRWSE	Yes	Yes	Yes	Yes
IXGCONN	Yes	Yes	Yes	Yes
IXGDELET	Yes	Yes	Yes	Yes
IXGIMPRT	Yes	Yes	Yes	Yes
IXGINVNT	Yes	Yes	Yes	Yes

Table 3. Service Summary (continued)

Service	Can be issued in AR ASC mode	Can be issued in cross memory mode	Checks SYSSTATE	Can be issued in 64-bit AMODE
IXGOFFLD	Yes	Yes	Yes	Yes
IXGQUERY	Yes	Yes	Yes	Yes
IXGUPDAT	Yes	Yes	Yes	Yes
IXGWRITE	Yes	Yes	Yes	Yes
LINK	Yes (See note 1)	No	Yes	No
LINKX	Yes	No	Yes	Yes
LOAD	Yes	No	No	Yes
LSEXPAND	Yes	No	No	No
PGLOAD	No	No	No	No
PGOUT	No	No	No	No
PGRLSE	No	No	No	No
PGSER	No	No	No	Yes
POST	No	Yes	No	Yes
QRYLANG	Yes	Yes	No	No
REFPAT	Yes	No	Yes	No
RESERVE	No	No	No	Yes
RETURN	No	No	No	No
SAVE	No	No	No	No
SETRP	Yes	Yes	Yes	Yes
SNAP	Yes (See note 1)	No	Yes	No
SNAPX	Yes	No	Yes	No
SPIE	No	No	No	No
SPLEVEL	Yes	Yes	No	No
STAE	No	No	No	No
STATUS	Yes	Yes	No	No
STCKCONV	Yes	Yes	No	No
STCKSYNC	Yes	Yes	Yes	No
STIMER	No	No	No	Yes
STIMERM	No	No	No	Yes
STORAGE	Yes	Yes	No	Yes
SYMRBLD	Yes	Yes	Yes	No
SYMREC	No	Yes	Yes	No
SYNCH	Yes (See note 1)	No	Yes	No

Table 3. Service Summary (continued)

Service	Can be issued in AR ASC mode	Can be issued in cross memory mode	Checks SYSSTATE	Can be issued in 64-bit AMODE
SYNCHX	Yes	No	Yes	Yes
SYSSTATE	Yes	Yes	No	No
TCBTOKEN	Yes	Yes	No	No
TESTART	Yes	Yes	No	No
TIME	Yes (See note 6)	Yes (See note 6)	No	Yes
TIMEUSED	Yes	Yes	No	Yes
TRANMSG	Yes	Yes	No	No
TTIMER	No	No	No	Yes
UCBDEVN	No	No	No	No
UCBINFO	Yes	Yes	Yes	No
UCBSCAN	Yes	Yes	Yes	No
UPDTMPB	Yes	Yes	No	No
VRADATA	Yes	Yes	Yes	No
WAIT	No	Yes	No	Yes
WTL	No	No	No	No
WTO	No	No	No	Yes
WTOR	No	No	No	Yes
XCTL	Yes (See note 1)	Yes	Yes	Yes
XCTLX	Yes	Yes	Yes	No

Notes:

1. Callers can use either macro in the following macro pairs:

ATTACH or ATTACHX
 LINK or LINKX
 SNAP or SNAPX
 SYNCH or SYNCHX
 XCTL or XCTLX

IBM recommends that all callers in AR mode use the X-macros (ATTACHX, LINKX, SNAPX, SYNCHX, and XCTLX). If a program in AR mode issues ATTACH, LINK, SNAP, SYNCH, or XCTL after issuing SYSSTATE ASCENV=AR, the system substitutes the corresponding X-macro and issues a message telling you that it made the substitution.

2. The only programs that can use ESTAE are programs that are in primary mode with PASN=HASN=SASN. Callers in AR mode or in cross memory mode must use ESTAEX instead of ESTAE.

IBM recommends you always use ESTAEX unless your program and your recovery routine are in 24-bit addressing mode, in which case, you should use ESTAE.

3. Problem state AR mode callers must use the STORAGE macro instead of using GETMAIN or FREEMAIN.

4. PASN=HASN=SASN for a non-shared standard hiperspace for which an ALET is not used (the HSPALET parameter is omitted).
5. If you use the HSPALET parameter, the HSPSERV macro checks SYSSTATE.
6. Only TIME LINKAGE=SYSTEM can be issued in AR mode, and can be issued in cross memory mode. TIME LINKAGE=SVC cannot be issued in AR mode or in cross memory mode.
7. For the QUERY request, CSVAPF can be issued only in primary mode. For all other requests, CSVAPF can be issued in primary or AR mode.

Chapter 2. IARCP64 – 64-bit cell pool services

Description

Use IARCP64 to request 64-bit cell pool services.

With IARCP64, you can request to:

- Build a pool (REQUEST=BUILD).
- Obtain a cell from the pool (REQUEST=GET).
- Return a cell to the pool (REQUEST=FREE).
- Delete the pool (REQUEST=DELETE).

Note: There is diagnostic support for 64-bit cell pools in IPCS by way of the CBFORMAT command. CBF *cpid* STR(IAXCPHD) formats the cell pool header, where *cpid* is the cell pool identifier that was returned on IARCP64 REQUEST=BUILD. If you cannot locate your cell pool identifier in the dump, simply browse storage starting at X'100000000' and issue a FIND on CPHD. There are multiple cell pools, so you must look at the cell contents to make sure that you have the right pool. To see details about all of the cells in the pool, use the EXIT option as follows: CBF *cpid* STR(IAXCPHD) EXIT.

Environment

The requirements for the caller are:

Environmental factor	Requirement
Minimum authorization:	Problem state and PSW key 8-15. For IARCP64 REQUEST=GET, FREE or DELETE, the caller must be able to modify the storage for the cell pool. That means the caller must be in the same key as the cell pool or the cell pool must be in the public key (key 9). Supervisor state is required for the TRACE=YES option. APF authorization has no bearing on these services.
Dispatchable unit mode:	Task or SRB
Cross memory mode:	Any PASN, any HASN, any SASN
AMODE:	64-bit
ASC mode:	Primary or access register (AR)
Interrupt status:	Enabled for interrupts.
Locks:	<p>For the BUILD and DELETE requests, no locks can be held.</p> <p>For the GET request, the following locks must be held by the caller or must be obtainable by IARCP64:</p> <ul style="list-style-type: none"> • For requests with EXPAND=NO, the caller might hold locks but is not required to hold any. • For requests with COMMON=NO and EXPAND=YES, the caller might hold the local lock (LOCAL or CML) of the current primary address space. <p>For the FREE request, the caller might hold locks but is not required to hold any.</p>
Control parameters:	Control parameters must be in the primary address space.

Programming requirements

Specify SYSSTATE AMODE64=YES before invoking this macro.

Restrictions

None.

Input register information

Before issuing the IARCP64 macro, the caller does not have to place any information into any general-purpose register (GPR) or access register (AR) unless using it in register notation for a particular parameter, or by using it as a base register.

Output register information

When control returns to the caller, the 64-bit GPRs contain:

For REQUEST=BUILD:

Register Contents

0

Reason code in the low 32 bits if the return code is not 0. Otherwise, used as a work register by the system.

1

Used as a work register by the system.

2-13

Unchanged.

14

Used as a work register by the system.

15

Return code in the low 32 bits.

For REQUEST=GET:

Register Contents

0

Reason code in the low 32 bits if the return code is not 0. Otherwise, used as a work register by the system.

1

The address of the obtained cell.

2-12

Unchanged if REGS=SAVE was specified, used as work registers by the system if REGS=USE was specified.

13

Unchanged.

14

Used as a work register by the system.

15

Return code in the low 32 bits.

For REQUEST=FREE:

Register Contents

0-1

Used as a work register by the system.

2-12

Unchanged if REGS=SAVE was specified, used as work registers by the system if REGS=USE was specified.

13

Unchanged.

14-15

Used as a work register by the system.

For REQUEST=DELETE:

Register**Contents****0-1**

Used as a work register by the system.

2-13

Unchanged.

14-15

Used as work registers by the system.

When control returns to the caller, the ARs contain:

Register**Contents****0-1**

Used as work registers by the system.

2-13

Unchanged.

14-15

Used as work registers by the system.

Some callers depend on register contents remaining the same before and after issuing a service. If the system changes the contents of registers on which the caller depends, the caller must save them before issuing the service, and restore them after the system returns control.

Performance implications

None.

Syntax

The standard form of the IARCP64 macro is written as follows:

Syntax	Description
<i>name</i>	<i>name</i> : symbol. Begin <i>name</i> in column 1.
␣	One or more blanks must precede IARCP64.
IARCP64	
␣	One or more blanks must follow IARCP64.

Syntax	Description
REQUEST=BUILD	
REQUEST=GET	
REQUEST=FREE	
REQUEST=DELETE	
,HEADER= <i>header</i>	<i>header</i> : RS-type address or address in register (2) - (12)
,CELLSIZE= <i>cellsize</i>	<i>cellsize</i> : RS-type address or address in register (2) - (12)
,OUTPUT_CPID= <i>output_cpid</i>	<i>output_cpid</i> : RS-type address or address in register (2) - (12)
,COMMON=NO	
,OWNINGTASK=CURRENT	
,OWNINGTASK=MOTHER	
,OWNINGTASK=IPT	
,OWNINGTASK=JOBSTEP	
,OWNINGTASK=CMRO	
,DUMP=LIKERGN	
,DUMP=LIKELSQA	
,DUMP=NO	
,DUMPPRIO= <i>dumpprio</i>	<i>dumpprio</i> : RS-type address or address in register (2) - (12)
,OWNINGASID= <i>owningasid</i>	<i>owningasid</i> : RS-type address or address in register (2) - (12)
,FPROT=YES	
,FPROT=NO	
,SENSITIVE= <u>UNKNOWN</u>	Default: SENSITIVE=UNKNOWN
,SENSITIVE=YES	
,SENSITIVE=NO	

Syntax	Description
,TYPE=PAGEABLE	
,CALLERKEY=YES	
,TRAILER=COND	
,TRAILER=YES	
,TRAILER=NO	
,FAILMODE=RC	
,FAILMODE=ABEND	
,INPUT_CPID= <i>input_cpid</i>	<i>input_cpid</i> : RS-type address or address in register (2) - (12)
,CELLADDR= <i>celladdr</i>	<i>celladdr</i> : RS-type address or address in register (2) - (12)
,EXPAND=YES	
,EXPAND=NO	
,TRACE=YES	
,TRACE=NO	
,CELLNAME= <i>cellname</i>	<i>cellname</i> : RS-type address or address in register (2) - (12)
,CELLADDR= <i>celladdr</i>	<i>celladdr</i> : RS-type address or address in register (2) - (12)
,REGS=SAVE	
,REGS=USE	
,INPUT_CPID= <i>input_cpid</i>	<i>input_cpid</i> : RS-type address or address in register (2) - (12)
,RETCODE= <i>retcode</i>	<i>retcode</i> : RS-type address or register (2) - (12), (GPR15), (REG15), or (R15).
,RSNCODE= <i>rsncode</i>	<i>rsncode</i> : RS-type address or register (2) - (12), (GPR0), (GPR00), (REG0), (REG00), or (R0).
,PLISTVER= <u>IMPLIED_VERSION</u>	Default: PLISTVER=IMPLIED_VERSION

Syntax	Description
,PLISTVER=MAX	
,PLISTVER=0	
,MF= <u>S</u>	Default: MF=S
,MF=(L, <i>list addr</i>)	<i>list addr</i> : RS-type address or register (1) - (12)
,MF=(L, <i>list addr</i> , <i>attr</i>)	
,MF=(L, <i>list addr</i> , <u>0D</u>)	
,MF=(E, <i>list addr</i>)	
,MF=(E, <i>list addr</i> , <u>COMPLETE</u>)	

Parameters

The parameters are explained as follows:

name

An optional symbol, starting in column 1 that is the name on the IARCP64 macro invocation. The name must conform to the rules for an ordinary assembly language symbol.

REQUEST=BUILD

REQUEST=GET

REQUEST=FREE

REQUEST=DELETE

A required parameter that indicates the type of request.

REQUEST=BUILD

Request to build the pool. The initial pool size is 1 MB. The CELLSIZE and TRAILER specifications determine how many available cells are in the pool.

REQUEST=GET

Request to obtain a cell from the pool.

REQUEST=FREE

Request to return a cell to the pool.

Note: This request is unconditional and will abnormally end when a problem. No return and reason codes are provided; therefore, do not specify the RETCODE and RSNCODE parameters.

REQUEST=DELETE

Request to delete the pool.

Note: This request is unconditional and will abnormally end when a problem. No return and reason codes are provided; therefore, do not specify the RETCODE and RSNCODE parameters.

Parameters for REQUEST=BUILD

The following parameters are valid when you specify REQUEST=BUILD:

,HEADER=header

A required input parameter that specifies information to be placed into the pool header for potential diagnostic purposes. The information helps to identify the requester and the purpose for the pool.

To code: Specify the RS-type address, or address in register (2) - (12), of a 24-character field.

,CELLSIZE=cellsize

A required input parameter that indicates the size of a cell in the pool. The cell size can be anywhere between 1 and $(1M-8192)/2$ or 520,192 bytes. Cell size is rounded up to a quadword multiple for cell sizes less than a cache line. Cells larger than a cache line are rounded up to a cache line multiple. Cells larger than a page are rounded to start on a page boundary. The first cell in an extent is always on a page boundary. Specifying a cell size that is at least 4 bytes less than the size after rounding for boundary alignment makes room for a trailer to be inserted. See TRAILER=YES below.

To code: Specify the RS-type address, or address in register (2) - (12), of a fullword field, or specify a literal decimal value.

,OUTPUT_CPID=output_cpId

A required output parameter that is to contain the cell pool ID.

To code: Specify the RS-type address, or address in register (2) - (12), of an 8-character field.

,COMMON=NO

A required parameter that indicates if the pool is to reside in common storage.

,COMMON=NO

The pool is not to reside in common storage.

,OWNINGTASK=CURRENT**,OWNINGTASK=MOTHER****,OWNINGTASK=IPT****,OWNINGTASK=JOBSTEP****,OWNINGTASK=CMRO**

A required parameter that indicates the task to be considered as the owner of the cell pool. When this task ends, the cell pool is automatically deleted.

,OWNINGTASK=CURRENT

The current task is to be the owner. Do not specify this unless the program is in task mode.

,OWNINGTASK=MOTHER

The mother task of the current task is to be the owner. If the current task is the cross-memory resource owning task, the request fails. Do not specify this unless the program is in task mode.

,OWNINGTASK=IPT

The initial pthread task is to be the owner. If the current task or mother task is not the IPT, then this defaults to the current task as the owner. Do not specify this unless the program is in task mode.

,OWNINGTASK=JOBSTEP

The jobstep task of the current task (the task with TCB address in field TCBJSTCB of the current task's TCB) is to be the owner. Do not specify this unless the program is in task mode.

,OWNINGTASK=CMRO

The cross-memory resource-owning task of the current primary address space is to be the owner.

,DUMP=LIKERGN**,DUMP=LIKELSQA****,DUMP=NO**

A required parameter that indicates how to dump this pool.

When COMMON=NO is specified:

,DUMP=LIKERGN

Dump the pool according to the rules for RGN.

,DUMP=LIKELSQA

Dump the pool according to the rules for LSQA.

,DUMP=NO

Do not dump the pool based on the RGN and LSQA SDATA options.

,DUMPPRIO=*dumpprio*

When DUMP=LIKERGN, COMMON=NO and REQUEST=BUILD are specified, a required input parameter that contains the dump priority to be used when dumping the pool. The value can be in the range 1-99 with 1 being the highest priority. See the documentation for the GETSTOR option of the IARV64 macro for a discussion on dump priorities.

To code: Specify the RS-type address, or address in register (2) - (12), of a 1-byte field.

,OWNINGASID=*owningasid*

When OWNER=BYASID, COMMON=YES and REQUEST=BUILD are specified, a required input parameter that specifies the ASID that is to be the owner. A value of 0 is equivalent to having specified OWNER=SYSTEM.

To code: Specify the RS-type address, or address in register (2) - (12), of a halfword field.

,FPROT=YES**,FPROT=NO**

A required parameter that indicates whether the pool storage is to be fetch-protected.

,FPROT=YES

The pool storage is to be fetch-protected.

,FPROT=NO

The pool storage is not to be fetch-protected.

,SENSITIVE=UNKNOWN**,SENSITIVE=YES****,SENSITIVE=NO**

An optional keyword input that specifies whether the pool will contain data that is potentially sensitive (for instance, personal or confidential). The default is SENSITIVE=UNKNOWN.

,SENSITIVE=UNKNOWN

Specifies that the sensitivity of the data is not known. The pool may or may not contain sensitive data.

,SENSITIVE=YES

Specifies that the pool contains sensitive data.

,SENSITIVE=NO

Specifies that the pool does not contain sensitive data.

,TYPE=PAGEABLE

A required parameter that indicates the type of storage for the pool.

,TYPE=PAGEABLE

The pool storage is to be pageable.

,CALLERKEY=YES

A required parameter that indicates whether the pool storage is to be in the key of the caller of the BUILD request.

,CALLERKEY=YES

The pool storage is to be in the key of the caller.

,TRAILER=COND**,TRAILER=YES****,TRAILER=NO**

A required parameter that indicates whether the cell is to have a trailer area after the user portion of the cell, which is set on GET processing and checked on FREE processing.

Note: Requesting a trailer can cause the cell size to be increased to provide room for the trailer. This increase in size occurs before rounding for boundary alignment. For example, requesting a cell size of 4096 and TRAILER=YES results in cells being 8192 bytes. If you do not need the entire 4096 bytes, specify a cell size of 4092 bytes and now the trailer fits in the same page.

,TRAILER=COND

The cell storage should have trailer processing in the following cases:

- When the service-rounded cell size has room for the trailer without requiring a larger cell to be allocated.
- When system diagnostic controls requests that trailers be appended to cells obtained by IARCP64. If this results in trailer processing, it works as described for TRAILER=YES below.

Note: The system diagnostic control for trailers in IARCP64 cell pools is examined at BUILD time only.

,TRAILER=YES

The cell storage is to have trailer processing. If the application writes past the end of the specified cell size, it will overrun the trailer. On a FREE request, this is detected and causes an ABEND.

,TRAILER=NO

The cell storage is not to have trailer processing, even if requested by way of a system diagnostic control.

,FAILMODE=RC

,FAILMODE=ABEND

A required parameter that indicates what to do if the request is not successful.

,FAILMODE=RC

The request should return with a failure return code when there are insufficient memory resources to satisfy the request. All errors in parameter specification or parameter access results in the request abnormally ending.

,FAILMODE=ABEND

The request should abnormally end when there are insufficient memory resources to satisfy the request.

Parameters for REQUEST=GET

The following parameters are valid when you specify REQUEST=GET:

,INPUT_CPID=*input_cpid*

A required input parameter that contains the cell pool ID returned on the successful BUILD request.

To code: Specify the RS-type address, or address in register (2) - (12), of an 8-character field.

,CELLADDR=*celladdr*

An optional output parameter of the obtained cell. If CELLADDR is not specified, the cell address is left in register 1.

To code: Specify the RS-type address, or address in register (2) - (12), of an 8-byte pointer field.

,EXPAND=YES

,EXPAND=NO

A required parameter that indicates whether to attempt expanding the pool if there is no available cell.

,EXPAND=YES

Indicates that an attempt to expand the pool should be made. Each successful expansion results in a 1 MB increase in the pool size.

,EXPAND=NO

Indicates that no attempt to expand the pool should be made.

,TRACE=YES

,TRACE=NO

A required parameter that indicates whether the invocation is to be traced.

Note: Tracing is available only to supervisor state callers.

,TRACE=YES

The entry is to be traced. If you are running in supervisor state, use this option, unless performance needs dictate otherwise.

Note: TRACE=YES on GET also results in TRACE=YES on FREE, so if you use TRACE=YES, ensure that the FREE request is in supervisor state.

,TRACE=NO

The entry is not to be traced. You must use this option if running in problem state.

,FAILMODE=RC**,FAILMODE=ABEND**

A required parameter that indicates what to do if the request is not successful.

,FAILMODE=RC

The request should return with a failure return code when there are insufficient memory resources to satisfy the request. All errors in parameter specification or parameter access results in the request abnormally ending.

,FAILMODE=ABEND

The request should abnormally end when there are insufficient memory resources to satisfy the request.

,REGS=SAVE**,REGS=USE**

A required parameter that indicates how to deal with the registers.

,REGS=SAVE

The request should save and preserve the contents of 64-bit GPRs 2 - 12, starting at offset 40 in a 144-byte area pointed to by register 13.

,REGS=USE

The request can use registers 2 - 12.

Parameters for REQUEST=FREE

The following parameters are valid when you specify REQUEST=FREE:

,CELLNAME=*cellname***,CELLADDR=*celladdr***

A required input parameter that identifies the cell to free.

,CELLNAME=*cellname*

The name of the cell to free.

To code: Specify the RS-type address, or address in register (2) - (12), of a character field.

,CELLADDR=*celladdr*

The address of the cell to free.

To code: Specify the RS-type address, or address in register (2) - (12), of an 8-byte pointer field.

,INPUT_CPID=*input_cpuid*

An optional input parameter that contains the cell pool ID returned on the BUILD request.

To code: Specify the RS-type address, or address in register (2) - (12), of an 8-character field.

,REGS=SAVE**,REGS=USE**

A required parameter that indicates how to deal with the registers.

,REGS=SAVE

The request should save and preserve the contents of 64-bit GPRs 2 - 12, starting at offset 40 in a 144-byte area pointed to by register 13.

,REGS=USE

The request can use registers 2 - 12.

Parameters for REQUEST=DELETE

The following parameters are valid when you specify REQUEST=DELETE:

,INPUT_CPID=*input_cpid*

A required input parameter that contains the cell pool ID returned on the BUILD request.

To code: Specify the RS-type address, or address in register (2) - (12), of an 8-character field.

Optional parameters

The following parameters are optional:

,RETCODE=*retcode*

An optional output parameter into which the return code is to be copied from GPR 15. If you specify (GPR15), (REG15), or (R15), the value is left in GPR 15.

To code: Specify the RS-type address of a fullword field, or register (2) - (12), (GPR15), (REG15), or (R15).

,RSNCODE=*rsncode*

An optional output parameter into which the reason code is to be copied from GPR 0. If you specify (GPR0), (GPR00), (REG0), (REG00), or (R0), the value is left in GPR 0.

To code: Specify the RS-type address of a fullword field, or register (2) - (12), (GPR0), (GPR00), (REG0), (REG00), or (R0).

,PLISTVER=IMPLIED_VERSION**,PLISTVER=MAX****,PLISTVER=0**

An optional input parameter that specifies the version of the macro. PLISTVER determines which parameter list the system generates. PLISTVER is an optional input parameter on all forms of the macro, including the list form. When using PLISTVER, specify it on all macro forms used for a request and with the same value on all of the macro forms. The values are:

- **IMPLIED_VERSION**, which is the lowest version that allows all parameters specified on the request to be processed. If you omit the PLISTVER parameter, IMPLIED_VERSION is the default.
- **MAX**, if you want the parameter list to be the largest size currently possible. This size might grow from release to release and affect the amount of storage that your program needs.

If you can tolerate the size change, specify PLISTVER=MAX on the list form of the macro. Specifying MAX ensures that the list-form parameter list is always long enough to hold all the parameters you might specify on the execute form, when both are assembled with the same level of the system. In this way, MAX ensures that the parameter list does not overwrite nearby storage.

- **0**, if you use the currently available parameters.

To code: Specify one of the following

- IMPLIED_VERSION
- MAX
- A decimal value of 0

,MF=S**,MF=(L,*list addr*)****,MF=(L,*list addr,attr*)****,MF=(L,*list addr,0D*)****,MF=(E,*list addr*)****,MF=(E,*list addr,COMPLETE*)**

An optional input parameter that specifies the macro form.

Use MF=S to specify the standard form of the macro, which builds an inline parameter list and generates the macro invocation to transfer control to the service. MF=S is the default.

Use MF=L to specify the list form of the macro. Use the list form together with the execute form of the macro for applications that require reentrant code. The list form defines an area of storage that the execute form uses to store the parameters. Only the PLISTVER parameter can be coded with the list form of the macro.

Use MF=E to specify the execute form of the macro. Use the execute form together with the list form of the macro for applications that require reentrant code. The execute form of the macro stores the parameters into the storage area defined by the list form, and generates the macro invocation to transfer control to the service.

,list addr

The name of a storage area to contain the parameters. For MF=S and MF=E, this can be an RS-type address or an address in register (1)-(12).

,attr

An optional 1- to 60-character input string that you use to force boundary alignment of the parameter list. Use a value of 0F to force the parameter list to a word boundary, or 0D to force the parameter list to a doubleword boundary. If you do not code *attr*, the system provides a value of 0D.

,COMPLETE

This parameter specifies that the system is to check for required parameters and supply defaults for omitted optional parameters.

ABEND codes

The IARCP64 caller might receive abend code X'DC4'. For detailed abend code information, see [z/OS MVS System Codes](#).

Return and reason codes

When the IARCP64 macro returns control to your program:

- GPR 15 (and *retcode*, when you code RETCODE) contains a return code.
- When the value in GPR 15 is not zero, GPR 0 (and *rsncode*, when you code RSNCODE) contains a reason code.

Macro IAXSERVC provides equated symbols for the return and reason codes.

The following table identifies the hexadecimal return and reason codes and the equated symbol associated with each reason code.

Table 4. Return and Reason Codes for the IARCP64 Macro		
Hexadecimal Return Code	Hexadecimal Reason Code	Equate Symbol Meaning and Action
00	None	<p>Equate Symbol: IARCP64Rc_OK</p> <p>Meaning: IARCP64 request successful.</p> <p>Action: None required.</p> <p>BUILD Meaning: Cell pool built Action: None required.</p> <p>DELETE Meaning: Cell Pool deleted and storage freed. Action: None required.</p> <p>GET Meaning: Cell from pool obtained. Action: None required.</p> <p>FREE Meaning: Cell returned to the pool. Action: None required.</p>
04	None	<p>Equate Symbol: IARCP64Rc_Warn</p> <p>Meaning: Warning</p> <p>Action: Refer to the action provided with the specific reason code.</p>

Table 4. Return and Reason Codes for the IARCP64 Macro (continued)		
Hexadecimal Return Code	Hexadecimal Reason Code	Equate Symbol Meaning and Action
04	xx0400xx	<p>Equate Symbol: IARCP64RsnGetOutOfCells</p> <p>Meaning: The request to the IARCP64 GET service specified EXPAND=NO and the current extent is out of cells.</p> <p>Action: Either change the request to specify EXPAND=YES or write logic to deal with no cell available.</p>
08	None	<p>Equate Symbol: IARCP64Rc_Fail</p> <p>Meaning: Service failed due to running out of resources.</p> <p>Action: Refer to the action provided with the specific reason code.</p>
08	xx0401xx	<p>Equate Symbol: IARCP64RsnMemlimitExhausted</p> <p>Meaning: The request to either the IARCP64 BUILD, IARCP64 GET when the pool is being expanded or the IARST64 GET when a new extent is required was not able to obtain private storage due to the address space MEMLIMIT.</p> <p>Action: Either raise the MEMLIMIT of the address space or determine if private storage is being consumed excessively somewhere.</p>
08	xx0402xx	<p>Equate Symbol: IARCP64Rsn64BitCommonExhausted</p> <p>Meaning: The request to either the IARCP64 BUILD, IARCP64 GET when the pool is being expanded or the IARST64 GET when a new extent is required was not able to obtain common storage due to there being insufficient 64-bit common storage to satisfy the request.</p> <p>Action: For common storage, either raise the system limit on common (HVCOMMON) or determine if common storage is being consumed excessively somewhere.</p>

Examples

1. Build a pool according to the following specifications:

- Cells 32 bytes long
- In private storage
- With an owning task of the current task
- Dumped similar to "RGN" processing
- Not fetch-protected
- Pageable storage
- In key 3
- Provide a diagnostic trailer.

Note: Requesting a diagnostic trailer causes the cell size to internally be rounded up 32 - 48 bytes

- Provide return code if the request is not successful

The coding sample follows

```

IARCP64 REQUEST=BUILD,HEADER=theHeader,
          CELLSIZE=theCellsize,OUTPUT_CPID=theCPID,
          COMMON=NO,OWNINGTASK=CURRENT,DUMP=LIKERN,
          FPROT=NO,TYPE=PAGEABLE,
          CALLERKEY=NO,KEY00TOF0=theKEY,
          TRAILER=YES,FAILMODE=RC,
          RETCODE=LRETCODE,RSNCODE=LRSNCODE,
          MF=(E,IARCP64L)

( Place code to check return/reason codes here.)

theHEADER   DC   CL24           Header for pool
theCellsize DC   F'32'         32-byte cells
Key00ToF0   DC   X'30'         Key 3 (bits 0-3 of the byte)

```

```

IAXSERVC                                Return/Reason code information
DYNAREA  DSECT
LRETCODE DS    F
LRSNCODE DS    F
theCPID  DS    D
IARCP64 MF=(L,IARCP64L)

```

2. Obtain a cell from the pool.

- Do not expand the pool if no cell is available
- Provide Return Code if the request is not successful
- Save and restore registers

The coding sample follows

```

IARCP64 REQUEST=GET,INPUT_CPID=theCPID,
        CELLADDR=theCellAddr,
        EXPAND=NO,
        FAILMODE=RC,
        REGS=SAVE,
        RETCODE=LRETCODE,RSNCODE=LRSNCODE,

(Place code to check return/reason codes here.)

IAXSERVC                                Return/Reason code information
DYNAREA  DSECT
LRETCODE DS    F
LRSNCODE DS    F
theCPID  DS    D
theCellAddr DS D

```

3. Free a cell.

- Save and restore registers

The coding sample follows

```

IARCP64 REQUEST=FREE,
        CELLADDR=theCellAddr,
        REGS=SAVE

IAXSERVC                                Return/Reason code information
DYNAREA  DSECT
theCPID  DS    D
theCellAddr DS D

```

4. Delete the pool.

The coding sample follows

```

IARCP64 REQUEST=DELETE,INPUT_CPID=theCPID,
        MF=(E,IARCP64L)

IAXSERVC                                Return/Reason code information
DYNAREA  DSECT
theCPID  DS    D
IARCP64 MF=(L,IARCP64L)

```

Chapter 3. IARR2V – Convert a central storage address to a virtual storage address

Description

Use the IARR2V macro to convert a central storage address to a virtual storage address. This conversion can be useful when you have the central storage address from handling I/O or doing diagnostic support and need to know the corresponding virtual address.

When the input storage address is a central storage address that backs a single page, the system returns the ASID that indicates the address space that owns the central storage, and the STOKEN that indicates the address space or data space that uses the central storage. When a central storage address does not back any page, or backs a read-only nucleus page, the system returns a non-zero return code and reason code.

For more information on the use of the IARR2V macro, see [*z/OS MVS Programming: Assembler Services Guide*](#).

Environment

The requirements for the caller are:

Environmental factor	Requirement
Minimum authorization:	Problem state with any PSW key.
Dispatchable unit mode:	Task or SRB
Cross memory mode:	Any PASN, any HASN, any SASN
AMODE:	24-, 31- or 64-bit.
ASC mode:	Primary or access register (AR)
Interrupt status:	Enabled or disabled for I/O and external interrupts
Locks:	The caller should not hold the RSM locks or any locks higher in the locking hierarchy.
Control parameters:	None.

Programming requirements

None.

Restrictions

None.

Input register information

Before issuing the IARR2V macro, the caller does not have to place any information into any register unless using it in register notation for a particular parameter, or using it as a base register.

Output register information

When control returns to the caller, the GPRs contain:

Register Contents

- 0** ASID if return code is 0 or 4; otherwise, reason code. The ASID value is X'FFFF' if the returned virtual address represents common storage.
- 1** Virtual storage address if return code is 0 or 4; otherwise, used as a work register by the system.
- 2-13** Unchanged.
- 14** Used as a work register by the system.
- 15** Return code.

When control returns to the caller, the ARs contain:

Register Contents

- 0** First four bytes of STOKEN if return code is 0 or 4; otherwise, used as a work register by the system.
- 1** Last four bytes of STOKEN if return code is 0 or 4; otherwise, used as a work register by the system.
- 2-13** Unchanged.
- 14** Total shared view count if return code is 0 or 4; otherwise, used as a work register by the system.
- 15** Valid shared view count if return code is 0 or 4; otherwise, used as a work register by the system.

Some callers depend on register contents remaining the same before and after issuing a service. If the system changes the contents of registers on which the caller depends, the caller must save them before issuing the service, and restore them after the system returns control.

Performance implications

None.

Syntax

The standard form of the IARR2V macro is written as follows:

Syntax	Description
<i>name</i>	<i>name</i> : symbol. Begin <i>name</i> in column 1.
␣	One or more blanks must precede IARR2V.
IARR2V	
␣	One or more blanks must follow IARR2V.

Syntax	Description
RSA= <i>rsa_addr</i>	<i>rsa_addr</i> : RS-type address, or register (2) - (12).
RSA64= <i>rsa_addr64</i>	<i>rsa_addr64</i> : RS-type address, or register (2) - (12).
,VSA= <i>vsa_addr</i>	<i>vsa_addr</i> : RS-type address, or register (2) - (12).
,VSA64= <i>vsa_addr64</i>	<i>vsa_addr64</i> : RS-type address, or register (2) - (12).
,ASID= <i>asid_addr</i>	<i>asid_addr</i> : RS-type address, or register (2) - (12).
,STOKEN= <i>token_addr</i>	<i>token_addr</i> : RS-type address, or register (2) - (12).
,WORKREG= <i>work_reg</i>	<i>work_reg</i> : RS-type address, or register (2) - (12).
,WORKREG=NONE	Default: WORKREG=NONE
,NUMVIEW= <i>view_addr</i>	<i>view_addr</i> : RS-type address, or register (2) - (12).
,NUMVALID= <i>val_addr</i>	<i>val_addr</i> : RS-type address, or register (2) - (12).
,RETCODE= <i>retcode</i>	<i>retcode</i> : RS-type address, or register (2) - (12).
,RSNCODE= <i>rsncode</i>	<i>rsncode</i> : RS-type address, or register (2) - (12).

Parameters

The parameters are explained as follows:

RSA=*rsa_addr*

Specifies the name (RS-type) or address (in register 2-12) of an input fullword that contains the central storage address to be converted to a virtual storage address. This keyword is used to provide a 31-bit real address. RSA and RSA64 are mutually exclusive keywords. You must specify one or the other.

RSA64=*rsa_addr64*

Specifies the name (RS-type) or address (in register 2-12) of an input doubleword that contains the central storage address to be converted to a virtual storage address. This keyword is used to provide a 64-bit real address. RSA and RSA64 are mutually exclusive keywords. You must specify one or the other. To use this keyword, the SYSTATE macro must be invoked specifying ARCHLVL greater than 1.

,VSA=*vsa_addr*

Specifies the name (RS-type) or address (in register 2-12) of an optional output fullword that the system uses to return the virtual storage address that corresponds to the input central storage address.

,VSA64=*vsa_addr64*

Specifies the name (RS-type) or address (in register 2-12) of an optional output doubleword that the system uses to return the 64-bit virtual storage address that corresponds to the input central storage

address. VSA and VSA64 are mutually exclusive keywords. To use this keyword, the SYSTATE macro must be invoked specifying ARCHLVL greater than 1.

,ASID=*asid_addr*

Specifies the name (RS-type) or address (in register 2-12) of an optional output fullword that the system uses to return the ASID of the address space associated with the output virtual storage address. The system returns the ASID in bits 16-31 of the fullword, and clears bits 1-15 to 0. If the input central storage address backs a page that is shared through the use of the IARVSRV macro, the system sets bit 0 to 1; otherwise, bit 0 contains 0.

,STOKEN=*stoken_addr*

Specifies the name (RS-type) or address (in register 2-12) of an optional 8-character output field that the system uses to return the STOKEN for the address space or data space associated with the output virtual storage address.

,WORKREG=*work_reg*

,WORKREG=NONE

Specifies whether the system is to return a page sharing view count. If you want the system to return a page sharing view count, specify *work-reg* as a digit from 2 through 12 that identifies a GPR/AR pair that the system can use as work registers. WORKREG=*work_reg* is required if you code NUMVIEW or NUMVALID.

WORKREG=NONE is the default and specifies that the system is not to return the sharing count.

,NUMVIEW=*view_addr*

Specifies the name (RS-type) or address (in register 2-12) of an optional output fullword that the system uses to return the number of page sharing views associated with the input central storage address. This number is non-zero only if the system sets bit 0 of the ASID. NUMVIEW=*view_addr* is required with the WORKREG=*work_reg* parameter.

,NUMVALID=*val_addr*

Specifies the name (RS-type) or address (in register 2-12) of an optional output fullword that the system uses to return the number of valid page sharing views associated with the input central storage address. A valid page must be currently defined in central storage. This number is non-zero only if the system sets bit 0 of the *asid_addr*. NUMVALID=*val_addr* is required with the WORKREG=*work_reg* parameter.

,RETCODE=*retcode*

Specifies the name (RS-type) or address (in register 2-12) of an optional output fullword into which the system copies the return code from GPR 15.

,RSNCODE=*rsncode*

Specifies the name (RS-type) or address (in register 2-12) of an optional output fullword into which the system copies the a reason code from GPR 0.

ABEND codes

None.

Return and reason codes

When the IARR2V macro returns control to your program, GPR 15 (and *retcode* if you coded RETCODE) contains the return code. If the return code is not 0 or 4, GPR 0 (and *rsncode* if you coded RSNCODE) contains the reason code.

Hexadecimal Return Code	Hexadecimal Reason Code	Meaning and Action
00	None	<p>Meaning: The IARR2V request completed successfully. The address returned in the VSA parameter represents an address space page.</p> <p>Action: None required.</p>

Table 5. Return and Reason Codes for the IARR2V Macro (continued)

Hexadecimal Return Code	Hexadecimal Reason Code	Meaning and Action
04	None	Meaning: The IARR2V request completed successfully. The address returned in the VSA parameter represents a data space page. Action: None required.
08	xx0001xx	Meaning: Program error. The IARR2V request was unsuccessful because the input central storage address was not within the bounds of central storage. Action: Check your input central storage address and rerun the program.
08	xx0002xx	Meaning: Program error. The IARR2V request was unsuccessful because the frame corresponding to the input central storage address was not assigned to a page. Action: Check your input central storage address and rerun the program.
08	xx0003xx	Meaning: Program error. The IARR2V request was unsuccessful because the frame corresponding to the input central storage address contains shared data, but no virtual address for any accessible address space (either home, primary, or secondary) corresponds to the frame. Action: Check your input central storage address and rerun the program.
08	xx0004xx	Meaning: System error. The IARR2V request was recursively invoked. Action: Record the return code and reason code and supply them to the appropriate IBM support personnel.
08	xx0005xx	Meaning: Program error. The IARR2V request was unsuccessful because the frame corresponding to the input central storage address was assigned, but the data space STOKEN could not be found. Action: Check your input central storage address and rerun the program.
08	xx0006xx	Meaning: Program error. The IARR2V request was unsuccessful because the virtual address is above 2G and the caller did not specify VSA64. Action: Specify VSA64 on the IARR2V invocation.
08	xx0007xx	Meaning: The frame corresponding to the input real storage is used to back a high virtual shared page but the address space does not have access to it (none of its home, primary, or secondary address space did the ShareMemObj) Action: None.

Example 1

Convert the central storage address in variable VSA and place the result in variable VSAOUT.

```

      LRA   1,VSA
      LR    5,1
INVOKE1  IARR2V RSA=(5),VSA=VSAOUT
      .
      VSA   DS   F
      VSAOUT DS  F

```

Example 2

Same as Example 1, but return ASID in variable ASIDO.

```

INVOKE2  IARR2V RSA=(5),ASID=ASIDO
      .
      ASIDO  DS   F

```

Example 3

Same as Example 1, but return STOKEN in variable STOKO.

```
INVOKE3 IARR2V RSA=(5),STOKEN=STOKO
      .
      STOKO DS F
```

Example 4

Obtain the total and valid number of page sharing views associated with the input address. WORKREG is required.

```
INVOKE4 IARR2V RSA=(5),WORKREG=(6),NUMVIEW=VIEWS, NUMVALID=VALS
      .
      VIEWS DS F
      VALS DS F
```

Chapter 4. IARST64 – 64-bit storage services

Description

Use IARST64 to request 64-bit Storage Services.

With IARST64, you can request services to:

- Obtain storage (REQUEST=GET)
- Return storage (REQUEST=FREE)

Note: There is diagnostic support for 64-bit cell pools, which are created by IARST64, in IPCS using the CBFORMAT command. To locate the cell pool of interest, you need to follow the pointers from HP1, to HP2, to the CPHD. For common storage, the HP1 is located in the ECVT. CBF ECVT formats the ECVT, then does a FIND on HP1. Extract the address of the HP1 from the ECVT and CBF addrhp1 STR(IAXHP1) formats the HP1. Each entry in the HP1 represents an attribute set (storage key, storage type(pageable, DREF, FIXED), and Fetch-Protection (ON or OFF)). The output from this command contains CBF commands for any connected HP2s. Select the CBF command of interest and run it to format the HP2. The HP2 consists of pointers to cell pool headers for different sizes. Choose the size of interest and select the command that looks like this to format the cell pool header:

```
CBF addrhchphd STR(IAXCPHD)
```

To see details about all of the cells in the pool, use the EXIT option as follows:

```
CBF addrhchphd STR(IAXCPHD) EXIT
```

For private storage, the HP1 is anchored in the STCB. The quickest way to locate the HP1 is to run the SUMMARY FORMAT command for the address space of interest. Locate the TCB that owns the storage of interest and then scroll down to the formatted STCB. The HP1 field contains the address of the HP1. From here, the processing is the same as described for common storage.

Environment

The requirements for the caller are:

Environmental factor	Requirement
Minimum authorization:	Use of the COMMON=YES, TYPE=DREF, TYPE=FIXED, OWNINGTASK=RCT, or the Key00ToF0 parameter with a value other than 9 requires the caller to be running in key 0-7. Use of MEMLIMIT=NO requires key 0-7 or supervisor state. All other options have a minimum authorization of problem state and PSW key 8-15.
Dispatchable unit mode:	Task or SRB
Cross memory mode:	Any PASN, any HASN, any SASN
AMODE:	64-bit
ASC mode:	Primary or access register (AR)
Interrupt status:	<ul style="list-style-type: none"> • The caller can be enabled or disabled for interrupts when requesting storage that is defined as COMMON=YES and TYPE=DREF or TYPE=FIXED. • For all other parameter combinations, the caller must be enabled for interrupts.

Environmental factor**Requirement****Locks:**

For the GET request, the following locks can be held by the caller or must be obtainable by IARST64:

- For requests with COMMON=NO, the locking restrictions are the same as for IARV64 REQUEST=GETSTOR.

For the FREE request, the caller might hold locks but is not required to hold any.

Control parameters:

Control parameters must be in the primary address space.

Programming requirements

None.

Restrictions

None.

Input register information

When REGS=SAVE is not used, the caller does not have to place any information into any general-purpose register (GPR) or access register (AR) unless using it in register notation for a particular parameter, or using it as a base register.

Before issuing the IARST64 macro with REGS=SAVE, the caller must ensure that the following GPR contains the specified information:

**Register
Contents****13**

Address of a 144-byte area within which the 88 bytes beginning at offset 40 can be modified.

Before issuing the IARST64 macro, the caller does not have to place any information into any access register (AR) unless using it in register notation for a particular parameter, or using it as a base register.

Output register information

When control returns to the caller, the 64-bit GPRs contain:

For REQUEST=GET

**Register
Contents****0**

Reason code in the low 32 bits if the return code is not 0. Otherwise, used as a work register by the system.

1

The address of the obtained storage.

2-12

Unchanged if REGS=SAVE was specified, used as work registers by the system if REGS=USE was specified.

13

Unchanged.

14

Used as a work register by the system.

15

Return code in the low 32 bits.

For REQUEST=FREE

Register**Contents****0-1**

Used as a work register by the system.

2-12

- Unchanged, if REGS=SAVE was specified.
- Used as work registers by the system, if REGS=USE was specified.

13

Unchanged.

14-15

Used as a work register by the system.

When control returns to the caller, the ARs contain:

Register**Contents****0-1**

Used as work registers by the system.

2-13

Unchanged.

14-15

Used as work registers by the system.

Some callers depend on register contents to remain the same before and after issuing a service. If the system changes the contents of registers on which the caller depends, the caller must save them before issuing the service, and restore them after the system returns control.

Performance implications

None.

Syntax

The IARST64 macro is written as follows:

Syntax	Description
<i>name</i>	<i>name</i> : symbol. Begin <i>name</i> in column 1.
␣	One or more blanks must precede IARST64.
IARST64	
␣	One or more blanks must follow IARST64.
REQUEST=GET	

Syntax	Description
REQUEST=FREE	
,SIZE= <i>size</i>	<i>size</i> : RS-type address or address in register (2) - (12)
,AREAADDR= <i>areaaddr</i>	<i>areaaddr</i> : RS-type address or address in register (2) - (12)
,COMMON=NO	
,COMMON=YES	
,OWNINGTASK=CURRENT	
,OWNINGTASK=MOTHER	
,OWNINGTASK=IPT	
,OWNINGTASK=JOBSTEP	
,OWNINGTASK=CMRO	
,OWNINGTASK=RCT	
,MEMLIMIT= <u>YES</u>	Default: MEMLIMIT=YES
,MEMLIMIT=NO	
,LOCALSYSAREA= <u>NO</u>	Default: LOCALSYSAREA=NO
,LOCALSYSAREA=YES	
,OWNER=HOME	
,OWNER=PRIMARY	
,OWNER=SECONDARY	
,OWNER=SYSTEM	
,OWNER=BYASID	
,OWNINGASID= <i>owningasid</i>	<i>owningasid</i> : RS-type address or address in register (2) - (12)
,FPROT=YES	
,FPROT=NO	
,SENSITIVE= <u>UNKNOWN</u>	Default: SENSITIVE=UNKNOWN
,SENSITIVE=YES	

Syntax	Description
,SENSITIVE=NO	
,TYPE=PAGEABLE	
,TYPE=DREF	
,TYPE=FIXED	
,CALLERKEY=YES	
,CALLERKEY=NO	
,KEY00TOF0= <i>key00tof0</i>	<i>key00tof0</i> : RS-type address or address in register (2) - (12)
,FAILMODE=RC	
,FAILMODE=ABEND	
,REGS=SAVE	
,REGS=USE	
,AREANAME= <i>areaname</i>	<i>areaname</i> : RS-type address or address in register (2) - (12)
,AREAADDR= <i>areaaddr</i>	<i>areaaddr</i> : RS-type address or address in register (2) - (12)
,REGS=SAVE	
,REGS=USE	
,RETCODE= <i>retcode</i>	<i>retcode</i> : RS-type address or register (2) - (12), (GPR15), (REG15), or (R15).
,RSNCODE= <i>rsncode</i>	<i>rsncode</i> : RS-type address or register (2) - (12), (GPR0), (GPR00), (REG0), (REG00), or (R0).

Parameters

The parameters are explained as follows:

name

An optional symbol, starting in column 1 that is the name on the IARST64 macro invocation. The name must conform to the rules for an ordinary assembler language symbol.

REQUEST=GET

REQUEST=FREE

A required parameter that indicates the type of request.

REQUEST=GET

This parameter gets storage.

REQUEST=FREE

This parameter returns storage.

Note:

This request is unconditional, and will abnormally end if there is a problem. No return and reason codes are provided, so do not specify the RETCODE and RSNCODE parameters.

,SIZE=size

When REQUEST=GET is specified, a required input parameter that indicates the size of the storage to be obtained. The size can be anywhere 1 - 128 K bytes. The size is rounded up to the power of 2. So cell sizes are 64, 128, 256, 512, 1024, 2048, 4096, 8192, 16,384, 32,768, 65,536 and 131,072 bytes. The smallest cell size that contains the request is used. If the requested size is at least 4 bytes less than the rounded up cell size, a trailer will be added to check for storage overruns. For storage that is larger than what IARST64 supports, consider using IARCP64 or IARV64 GETSTOR or GETCOMMON. Do not specify a value that exceeds 128 K or incorrect results can ensue.

To code: Specify the RS-type address, or address in register (2)-(12), of a fullword field, or specify a literal decimal value.

,AREAADDR=areaaddr

When REQUEST=GET is specified, an optional output parameter, of the obtained storage. If AREAADDR is not specified, the cell address is left in register 1.

To code: Specify the RS-type address, or address in register (2)-(12), of an 8-byte pointer field.

,COMMON=NO**,COMMON=YES**

When REQUEST=GET is specified, a required parameter that indicates if the pool is to reside in common storage.

,COMMON=NO

This parameter indicates that the pool is not to reside in common storage.

,COMMON=YES

This parameter indicates that the pool is to reside in common storage.

,OWNINGTASK=CURRENT**,OWNINGTASK=MOTHER****,OWNINGTASK=IPT****,OWNINGTASK=JOBSTEP****,OWNINGTASK=CMRO****,OWNINGTASK=RCT**

When COMMON=NO and REQUEST=GET are specified, a required parameter that indicates the task that is to be considered the owner.

,OWNINGTASK=CURRENT

This parameter indicates that the current task is to be the owner. Do not specify this parameter unless the program is in task mode.

,OWNINGTASK=MOTHER

This parameter indicates that the mother task of the current task is to be the owner. If the current task is the cross-memory resource owning task, the request will fail. Do not specify this parameter unless the program is in task mode.

,OWNINGTASK=IPT

This parameter indicates that the initial pthread task (subtask running under UNIX System Services) is to be the owner. If the current task or mother task is not the IPT, then this will default to the current task as the owner. Do not specify this unless the program is in task mode.

,OWNINGTASK=JOBSTEP

This parameter indicates that the jobstep task of the current task (the task with TCB address in field TCBJSTCB of the current task's TCB) is to be the owner. Do not specify this unless the program is in task mode.

,OWNINGTASK=CMRO

This parameter indicates that the cross-memory resource-owning task is to be the owner.

,OWNINGTASK=RCT

This parameter indicates that the region control task (RCT) is to be the owner. You must be key 0-7 to request this option.

,MEMLIMIT=YES**,MEMLIMIT=NO**

When COMMON=NO and REQUEST=GET are specified, an optional parameter that indicates whether MEMLIMIT applies if an additional 1 M segment is obtained to satisfy the request. The default is MEMLIMIT=YES.

,MEMLIMIT=YES

This parameter indicates that MEMLIMIT applies.

,MEMLIMIT=NO

This parameter indicates that MEMLIMIT does not apply.

,LOCALSYSAREA=NO**,LOCALSYSAREA=YES**

When Common=NO and request=GET are specified, an optional parameter that specifies whether this is an explicit allocation request for 64-bit virtual storage in the local system area. The LOCALSYSAREA parameter can be used only by callers running in supervisor state or with a PSW key 0-7. THE DEFAULT IS LOCALSYSAREA=NO.

,LOCALSYSAREA=NO

The request will not be satisfied from the local system area.

,LOCALSYSAREA=YES

The request is to be satisfied from the local system area. The storage that is obtained with this keyword will not be copied during Fork processing. The use of local system area storage does not preclude checkpoint or restart from succeeding.

,OWNER=HOME**,OWNER=PRIMARY****,OWNER=SECONDARY****,OWNER=SYSTEM****,OWNER=BYASID**

When COMMON=YES and REQUEST=GET are specified, a required parameter that designates the owner of the storage.

,OWNER=HOME

This parameter indicates that the home address space is to be the owner.

,OWNER=PRIMARY

This parameter indicates that the primary address space is to be the owner.

,OWNER=SECONDARY

This parameter indicates that the secondary address space is to be the owner.

,OWNER=SYSTEM

This parameter indicates that the system is to be the owner. Use this only when there is no specific address space, which can be considered the owner.

,OWNER=BYASID

This parameter indicates that the owner is the ASID specified by the OwingASID parameter.

,OWNINGASID=owningasid

When OWNER=BYASID, COMMON=YES and REQUEST=GET are specified, a required input parameter that specifies the ASID that is to be the owner. A value of 0 is equivalent to having specified OWNER=SYSTEM. Do not specify a value which exceeds 32767 or incorrect results can ensue.

To code: Specify the RS-type address, or address in register (2)-(12), of a halfword field, or specify a literal decimal value.

,FPROT=YES

,FPROT=NO

When REQUEST=GET is specified, a required parameter that indicates if the pool storage is to be fetch-protected.

,FPROT=YES

This parameter indicates that the pool storage is to be fetch-protected.

,FPROT=NO

This parameter indicates that the pool storage is not to be fetch-protected.

,SENSITIVE=UNKNOWN

,SENSITIVE=YES

,SENSITIVE=NO

When REQUEST=GET is specified, an optional keyword input that specifies whether the memory will contain data that is potentially sensitive (for instance, personal or confidential). The default is SENSITIVE=UNKNOWN.

,SENSITIVE=UNKNOWN

Specifies that the sensitivity of the data is not known. The memory may or may not contain sensitive data.

,SENSITIVE=YES

Specifies that the memory contains sensitive data.

,SENSITIVE=NO

Specifies that the memory does not contain sensitive data.

,TYPE=PAGEABLE

,TYPE=DREF

,TYPE=FIXED

When REQUEST=GET is specified, a required parameter that indicates the type of storage for the pool.

,TYPE=PAGEABLE

This parameter indicates that the pool storage is to be pageable.

,TYPE=DREF

This parameter indicates that the pool storage is to be disabled-reference (DREF).

,TYPE=FIXED

This parameter indicates that the pool storage is to be page-fixed.

,CALLERKEY=YES

,CALLERKEY=NO

When REQUEST=GET is specified, a required parameter that indicates if the pool storage is to be in the key of the caller of the GET request.

,CALLERKEY=YES

This parameter indicates that the pool storage is to be in the key of the caller.

,CALLERKEY=NO

This parameter indicates that the pool storage is not to be in the key of the caller, but instead in the key specified by the Key00ToF0 parameter.

,KEY00TOF0=key00tofo

When CALLERKEY=NO and REQUEST=GET are specified, a required input parameter that indicates the key for the pool storage. The value should be in the range X'00' to X'70' (that is, the key 0 - 7 in the high-order 4 bits of the byte) for a caller that is key 0. For callers in key 1 - 7, there is no reason to use this parameter. The value X'90' is the only accepted key for a caller that is key 8 - 15. Be sure that the value is a multiple of 16 within the required range or incorrect results can occur.

To code: Specify the RS-type address, or address in register (2) - (12), of a one-byte field.

,FAILMODE=RC**,FAILMODE=ABEND**

When REQUEST=GET is specified, a required parameter that indicates what to do if the GET request is not successful due to out of memory in the requested area conditions.

,FAILMODE=RC

This parameter returns with a failure return code.

Note: There are cases for which an ABEND occurs regardless of the specification of FAILMODE=RC.

,FAILMODE=ABEND

This parameter abnormally ends.

,REGS=SAVE**,REGS=USE**

When REQUEST=GET is specified, a required parameter that indicates how to deal with the registers.

,REGS=SAVE

This parameter saves and preserves the contents of 64-bit GPRs 2 - 12 starting at offset 40 in a 144-byte area pointed to by register 13.

,REGS=USE

This parameter indicates that the system uses registers 2 - 12 as work registers and does not restore them.

,AREANAME=*areaname***,AREAADDR=*areaaddr***

When REQUEST=FREE is specified, a required input parameter.

,AREANAME=*areaname*

A parameter that is the area to free.

To code: Specify the RS-type address, or address in register (2)-(12), of a character field.

,AREAADDR=*areaaddr*

A parameter that contains the address of the area to free.

To code: Specify the RS-type address, or address in register (2)-(12), of an 8-byte pointer field.

,REGS=SAVE**,REGS=USE**

When REQUEST=FREE is specified, a required parameter that indicates how to deal with the registers.

,REGS=SAVE

This parameter saves and preserves the contents of 64-bit GPRs 2 - 12 starting at offset 40 in a 144-byte area pointed to by register 13.

,REGS=USE

This parameter indicates that you can use registers 2 - 12.

,RETCODE=*retcode*

An optional output parameter into which the return code is to be copied from GPR 15. If you specify 15, GPR15, or R15 (within or without parentheses), the value will be left in GPR15.

To code: Specify the RS-type address of a fullword field, or register (2)-(12), (GPR15), (REG15), or (R15).

,RSNCODE=*rsncode*

An optional output parameter into which the reason code is to be copied from GPR 0. If you specify 0, 00, GPR0, GPR00, REG0, REG00, or R0 (within or without parentheses), the value will be left in GPR0.

To code: Specify the RS-type address of a fullword field, or register (0) or (2)-(12), (0), (GPR0), (GPR00), (REG0), (REG00), or (R0).

ABEND codes

The IARST64 caller might receive abend code X'DC4'. For detailed abend code information, see [z/OS MVS System Codes](#).

In the following IARST64 abend reason codes, the bytes designated "xx" are for diagnostic purposes and have no significance to the external interface. Equate IARST64AbendRsncodeMask has been provided to let you build a mask to ignore those bytes.

Hexadecimal Reason Code	Equate Symbol Meaning and Action
xx0410xx	<p>Equate Symbol: IARST64AbendRsnCellAddrLow</p> <p>Meaning: The storage address passed to the IARST64 FREE service is within a megabyte used for storage pools, but the address is less than the address of the first usable storage address.</p> <p>Action: Correct the address passed to IARST64 FREE, making sure it is the same address that was returned from IARST64 GET.</p>
xx0413xx	<p>Equate Symbol: IARST64AbendRsnCellNotInExtent</p> <p>Meaning: The request was to the IARCP64 or IARST64 FREE service and the address of the storage passed in, is not within the bounds of a cell pool.</p> <p>Action: The address passed to IARST64 REQUEST=FREE must be the same as the address obtained from IARST64 REQUEST=GET.</p>
xx0419xx	<p>Equate Symbol: IARST64AbendRsnCellOverRun</p> <p>Meaning: The request was to the IARCP64 or IARST64 FREE service and the trailer data at the end of the cell was detected as being overrun. If the overrun is sufficiently large, it will cause damage to the following cell. The caller is abnormally ended so they can fix the code to not use more storage than requested.</p> <p>Action: Determine whether the storage has been overrun or whether the trailer data was overlaid by some other code. Fix the code so it only uses the amount of storage requested.</p>
xx041Axx	<p>Equate Symbol: IARST64AbendRsnCellNotInUse</p> <p>Meaning: The request was to the IARCP64 or IARST64 FREE service and the address of the storage passed in, is already in the freed state. This will happen when an application frees the storage twice.</p> <p>Action: Determine whether the current application is freeing the storage twice or whether it is using a cell that some other storage is freeing twice.</p>
xx041Bxx	<p>Equate Symbol: IARST64AbendRsnNotOnCellBoundary</p> <p>Meaning: The request was to the IARCP64 or IARST64 FREE service and the address of the storage passed in is not on a cell boundary in the cell pool from which the GET request was satisfied.</p> <p>Action: When freeing storage with IARST64 REQUEST=FREE, make sure to specify the address that was returned by IARST64 REQUEST=GET.</p>
xx041Cxx	<p>Equate Symbol: IARST64AbendRsnIARV64Error</p> <p>Meaning: During processing of IARST64 GET, a call to the IARV64 service for GETSTOR, GETCOMMON, PAGEFIX, or PROTECT failed. The failing return code from IARV64 was placed in register 2 before the abend. The failing reason code from IARV64 was placed in register 3 before the abend.</p> <p>Action: Examine the return and reason code as documented under IARV64 to determine if the problem is one that you can resolve.</p>

Hexadecimal Reason Code	Equate Symbol Meaning and Action
xx0420xx	<p>Equate Symbol: IARST64AbendRsnCphaNotQueue</p> <p>Meaning: The cell pool header authorized area was not queued to the owning task as expected. This could happen due to storage overlays or the caller bypassing the IARST64 macro and PCing directly to the service with incorrect input parameters.</p> <p>Action: Make sure that the application is using the IARST64 macro to request storage. If the problem persists, collect a dump and contact IBM Service.</p>
xx0425xx	<p>Equate Symbol: IARST64AbendRsnPoolNotInCallerKey</p> <p>Meaning: The request to IARST64 GET was against a storage pool that was not in the key of the caller. Normally this will abend with an OC4, but if the pool is out of cells and is in storage that is not fetch-protected, the pool expand routine verifies that the caller can modify this storage pool.</p> <p>Action: You must be in a key that has the ability to modify the pool storage for the request to be processed.</p>
xx0426xx	<p>Equate Symbol: IARST64AbendRsnPrimaryExtentOverlaid</p> <p>Meaning: The request to IARST64 or IARCP64 GET was against a storage pool where the primary extent control information has been overlaid.</p> <p>Action: Collect a dump and report the problem to IBM.</p>
xx0427xx	<p>Equate Symbol: IARST64AbendRsnSecondaryExtentOverlaid</p> <p>Meaning: The request to IARST64 or IARCP64 GET was against a storage pool where the secondary extent control information has been overlaid.</p> <p>Action: Collect a dump and report the problem to IBM.</p>
xx0428xx	<p>Equate Symbol: IARST64AbendRsnUnexpectedError</p> <p>Meaning: During processing of IARST64 GET an unexpected abend occurred. An SDUMP should have been generated.</p> <p>Action: Collect the dump and report the problem to IBM.</p>
xx0511xx	<p>Equate Symbol: IARST64AbendRsnKeyGT7Common</p> <p>Meaning: The request to IARST64 GET was for common storage, but the requested or caller was greater than key 7. You cannot allocate common storage in key 8 or above.</p> <p>Action: Correct the key passed to IARST64 GET or change your request to get private storage.</p>
xx0512xx	<p>Equate Symbol: IARST64AbendRsnGetMotherFromCmro</p> <p>Meaning: The request was to the IARST64 GET service and specified OWNINGTASK(MOTHER), but the caller is running on the CMRO task. You can't request the mother task be the storage owner from the CMRO task.</p> <p>Action: Either specify CMRO as the owner or specify RCT if you want the storage to persist across termination of the CMRO.</p>
xx0514xx	<p>Equate Symbol: IARST64AbendRsnGetNotRctOrCmro</p> <p>Meaning: The request was to the IARST64 GET service for private storage and the caller was running in cross memory mode or SRB mode. In these environments, the OWNINGTASK parameter must be set to RCT or CMRO. Neither of these were specified, so the request is failed.</p> <p>Action: Specify the OWNINGTASK parameter as RCT or CMRO.</p>

Hexadecimal Reason Code	Equate Symbol Meaning and Action
xx0515xx	<p>Equate Symbol: IARST64AbendRsnGetCellSizeZero</p> <p>Meaning: The request was to the IARST64 GET service and specified a length of zero.</p> <p>Action: Specify a length between 1 and 128 K.</p>
xx0516xx	<p>Equate Symbol: IARST64AbendRsnGetNotAuth</p> <p>Meaning: The request was to the IARST64 GET service and specified a parameter that requires the caller to be running in key 0-7. The caller is not authorized to use authorized options of COMMON, DREF, FIXED, OWNINGTASK(RCT), CALLERKEY(NO) and Key00ToF0 set to a system key.</p> <p>Action: Either run the code in key 0-7 or do not use authorized options.</p>
xx0517xx	<p>Equate Symbol: IARST64AbendRsnGetCellSizeTooBig</p> <p>Meaning: The request was to the IARST64 GET service and specified a length greater than 128 K.</p> <p>Action: Specify a size between 1 and 128 K. If larger storage is needed, consider using IARCP64 or IARV64 GETSTOR or GETCOMMON.</p>
xx0518xx	<p>Equate Symbol: IARST64AbendRsnGetKeyNot9</p> <p>Meaning: The request was to the IARST64 GET service and specified a CALLERKEY(NO) and a value for Key00ToF0 that was not key 9 and the caller is not authorized.</p> <p>Action: The only key that an unauthorized user can specify is key 9. Either request key 9 or change the specification to CALLERKEY(YES).</p>
xx0529xx	<p>Equate Symbol: IARST64AbendRsnGetSizeTooBig</p> <p>Meaning: The call to the IARST64 GET service specified a cell size larger than the maximum size supported.</p> <p>Action: Specify a size between 1 and 128 K. If a larger storage area is needed, consider using IARCP64 or IARV64 REQUEST=GETSTOR or GETCOMMON.</p>
xx052Axx	<p>Equate Symbol: IARST64AbendRsnValidationError</p> <p>Meaning: The call to the IARST64 GET service detected a validation error when locating the storage pool to be used. Possible cause is storage overlay of the storage pool control block in the caller's key.</p> <p>Action: Collect a dump and report the problem to IBM.</p>
xx052Bxx	<p>Equate Symbol: IARST64AbendRsnMemLimitNoUnauth</p> <p>Meaning: The call to the IARST64 GET service requested MEMLIMIT=NO, but is running unauthorized (key 8-15 and problem program state).</p> <p>Action: Either specify MEMLIMIT=YES or call from an authorized environment.</p>
xx052Cxx	<p>Equate Symbol: IARST64AbendRsnCellLT4Gig</p> <p>Meaning: The call to the IARCP64 or IARST64 FREE service was passed a cell address less than 4 Gig, so it can't possibly be a valid cell address in a 64 bit cell pool.</p> <p>Action: Only pass a storage address that was obtained with IARCP64 or IARST64 GET.</p>
xx052Dxx	<p>Equate Symbol: IARST64AbendRsnLocalSysAreaYesUnauth</p> <p>Meaning: The call to the IARST64 GET service requested LOCALSYSAREA=YES, but is running unauthorized (key 8-15 and problem program state).</p> <p>Action: Either specify LOCALSYSAREA=NO or CALL from an authorized environment.</p>

Hexadecimal Reason Code	Equate Symbol Meaning and Action
xx052Exx	<p>Equate Symbol: IARST64AbendRsnKeyGT7</p> <p>Meaning: The call to the IARST64 GET service requested private storage with CALLERKEY (NO) and KEY00TOF0 greater than key 7 when the CALLERKEY was less than key 8. An authorized caller cannot request unauthorized storage.</p> <p>Action: Correct the key of the requested storage or change the caller key.</p>

Return and reason codes

When the IARST64 macro returns control to your program:

- GPR 15 (and *retcode*, when you code RETCODE) contains a return code.
- When the value in GPR 15 is not zero, GPR 0 (and *rsncode*, when you code RSNCODE) contains a reason code.

Macro IAXSERVC provides equate symbols for the return and reason codes.

The following table identifies the hexadecimal return and reason codes and the equate symbol associated with each reason code.

Hexadecimal Return Code	Hexadecimal Reason Code	Equate Symbol Meaning and Action
00	None	<p>Equate Symbol: IARST64Rc_OK</p> <p>Meaning: IARST64 request successful.</p> <p>Action: None required.</p> <p>GET Meaning: storage obtained of requested size and attributes Action: None required.</p> <p>FREE Meaning: storage freed Action: None required.</p>
08	None	<p>Equate Symbol: IARST64Rc_Fail</p> <p>Meaning: Service failed due to running out of resources.</p> <p>Action: Refer to the action provided with the specific reason code.</p>
08	xx0401xx	<p>Equate Symbol: IARST64RsnMemlimitExhausted</p> <p>Meaning: The request to the IARST64 GET service was not able to obtain storage due to address space limits.</p> <p>Action: Either raise the MEMLIMIT of the address space or determine if private storage is being consumed excessively somewhere.</p>
08	xx0402xx	<p>Equate Symbol: IARST64Rsn64BitCommon Exhausted</p> <p>Meaning: The request to the IARST64 GET service was not able to obtain storage due to system limits.</p> <p>Action: For common storage, either raise the system limit on common (HVCOMMON) or determine if common storage is being consumed excessively somewhere.</p>
08	xx0403xx	<p>Equate Symbol: IARST64RsnMemlimitZero</p> <p>Meaning: The request to IARST64 GET was not able to obtain private storage due to the address space MEMLIMIT being set to zero.</p> <p>Action: Either set the MEMLIMIT of the address space to a nonzero value or if authorized, specify MEMLIMIT=NO on the IARST64 GET call to tell the service to bypass the address space MEMLIMIT.</p>

Examples

Example 1

Obtain storage.

Operations:

- 32-byte area
- In private storage
- With an owning task of the current task
- Dumped similar to "LSQA" processing (triggered by DREF or FIXED)
- Fetch-protected
- DREF storage
- In Key 7
- Provide Return Code if the request is not successful
- Save and restore registers

The code is as follows:

```
IARST64 REQUEST=GET,
  AREAADDR=theAreaAddr,
  SIZE=theAreaSize,
  COMMON=NO,OWNINGTASK=CURRENT,
  FPROT=YES,TYPE=DREF,
  CALLERKEY=NO,KEY00TOF0=theKEY,
  FAILMODE=RC,
  REGS=SAVE,
  RETCODE=LRETCODE,RSNCODE=LRSNCODE,
```

(Place code to check return code or reason codes here.)

```
theAreaSize DC F'32'
theKey     DC X'70'
IAXSERVC
DYNAREA   DSECT
LRETCODE  DS  F
LRSNCODE  DS  F
theAreaAddr DS D
```

Example 2

Free the storage.

Operation: Save and restore registers.

The code is as follows:

```
IARST64 REQUEST=FREE,
  AREAADDR=theAreaAddr,
  REGS=SAVE,
```

(There is no return code or reason code from IARST64 REQUEST=FREE.)

```
IAXSERVC
DYNAREA   DSECT
LRETCODE  DS  F
LRSNCODE  DS  F
theAreaAddr DS D
```

Chapter 5. IARVSERV – Request to share virtual storage

Description

Use the IARVSERV macro to define virtual storage areas to be shared by programs. This sharing can reduce the amount of processor storage required and the I/O necessary to support many applications that process large amounts of data. It also provides a way for programs executing in 24 bit addressing mode to access data residing above 16 megabytes.

Using IARVSERV allows programs to share data in virtual storage without the central storage constraints and processor overhead of other methods of sharing data. The type of storage access is controlled so that you can choose to allow read only or writing to the shared data with several variations. The type of storage access is called a **view**. Data to be shared is called the **source**. The source is the original data or the virtual storage that contains the data to be shared. This data is made accessible through an obtained storage area called the **target**. The source and target form a **sharing group**.

Through the IARVSERV macro, you can:

- Request that a virtual storage area (source) be eligible to be shared through a target view (SHARE parameter).
- Request that the source and targets no longer be shared (UNSHARE parameter).
- Request that the type of storage access to the data be changed.

See *z/OS MVS Programming: Assembler Services Guide* for more information about sharing data through the use of the IARVSERV macro.

Environment

The requirements for the caller are:

Environmental factor	Requirement
Minimum authorization:	Problem state with PSW key that allows access to the source, target, or both, depending on the value specified through the TARGET_VIEW parameter. See <i>z/OS MVS Programming: Assembler Services Guide</i> for additional information.
Dispatchable unit mode:	Task or SRB.
Cross memory mode:	Any PASN, any HASN, any SASN.
AMODE:	31- or 64-bit.
ASC mode:	Primary or access register (AR).
Interrupt status:	Enabled for I/O and external interrupts.
Locks:	The caller may hold the local lock, but is not required to hold any locks.
Control parameters:	Control parameters must be in the primary address space.

Programming requirements

- You must specify a range list that is mapped by the IARVRL macro. This is done using the RANGLIST parameter. For information on the IARVRL macro, see *z/OS MVS Data Areas* in the *z/OS Internet library* (www.ibm.com/servers/resourcelink/svc00100.nsf/pages/zosInternetLibrary).

IARVSERV macro

- The calling program can use IARVSERV only to share data that resides within the address space, or in a data space that the calling program created.
- Before your program issues the IARVSERV macro, it must use the GETMAIN, STORAGE, or DSPSERV macro to obtain storage for the source, target, or both.
- Attributes for storage depend on the subpool specified on the GETMAIN, STORAGE, or DSPSERV macros.

Restrictions

The following restriction apply:

- For the SHARE parameter, the source area must not contain pages in the nucleus (read-only, extended read-only, read-write and extended read-write areas).

Input register information

Before issuing the IARVSERV macro, the caller does not have to place any information into any register unless using it in register notation for a particular parameter, or using it as a base register.

Output register information

When control returns to the caller, the GPRs contain:

Register

Contents

0

Reason code, if GPR 15 contains a non-zero return code; otherwise, used as a work register by the system.

1

Used as a work register by the system.

2-13

Unchanged.

14

Used as a work register by the system.

15

Return code.

When control returns to the caller, the ARs contain:

Register

Contents

0-1

Used as work registers by the system.

2-13

Unchanged.

14-15

Used as work registers by the system.

Some callers depend on register contents remaining the same before and after issuing a service. If the system changes the contents of registers on which the caller depends, the caller must save them before issuing the service, and restore them after the system returns control.

Performance implications

Take care when using the RETAIN=YES parameter value. With RETAIN=YES, storage is not returned to the system which reduces the amount available to the system and other programs, thus potentially affecting system performance.

In order to expedite the return of all internal control blocks for the shared storage back to the system, IBM recommends issuing IARVSERV UNSHARE against all views for both source and target that are originally shared. For an example of how to code the UNSHARE parameter, see the example in this book.

Syntax

The standard form of the IARVSERV macro is written as follows:

Syntax	Description
<i>name</i>	<i>name</i> : symbol. Begin <i>name</i> in column 1.
␣	One or more blanks must precede IARVSERV.
IARVSERV	
␣	One or more blanks must follow IARVSERV.
SHARE	
UNSHARE	
CHANGEACCESS	
,RANGLIST= <i>ranglist_addr</i>	<i>ranglist_addr</i> : RS-type address, or register (2) - (12).
,NUMRANGE= <i>numrange_addr</i>	<i>numrange_addr</i> : RS-type address, or register (2) - (12). Default: 1 range
,TARGET_VIEW=READONLY	
,TARGET_VIEW=SHAREDWRITE	
,TARGET_VIEW=UNIQUEWRITE	
,TARGET_VIEW=TARGETWRITE	
,TARGET_VIEW=LIKESOURCE	
,TARGET_VIEW=HIDDEN	
,COPYNOW	
,RETAIN=NO	Default: RETAIN=NO
,RETAIN=YES	
,PLISTVER=IMPLIED_VERSION	

Syntax	Description
,PLISTVER=MAX	Default: IMPLIED_VERSION
,PLISTVER= <i>plistver</i>	<i>plistver</i> : 0

Parameters

The SHARE, UNSHARE, and CHANGEACCESS parameters designate the services of the IARVSERV macro, and are mutually exclusive.

The parameters are explained as follows:

SHARE

Requests that the source be made shareable through the target to create a sharing group. When you issue the IARVSERV macro with SHARE, you must specify the RANGLIST and the TARGET_VIEW parameters. The NUMRANGE parameter is optional.

UNSHARE

Requests that the specified virtual storage no longer be used to access shared storage. When you issue the IARVSERV macro with UNSHARE, you must specify the RANGLIST parameter. The NUMRANGE, and RETAIN parameters are optional. Using the RETAIN parameter can allow the target area data to remain available to other programs that can access the target area.

CHANGEACCESS

Requests that the type of access to the specified virtual storage be changed. When you issue the IARVSERV macro with CHANGEACCESS, you must specify the RANGLIST and the TARGET_VIEW parameters. The NUMRANGE parameter is optional.

,RANGLIST=*ranglist_addr*

Specifies the name (RS-type) or address (in register 2-12) of a required input fullword that contains the address of the range list. The range list consists of a number of entries (as specified by NUMRANGE) where each entry is 28 bytes long. A mapping of each entry is provided through the mapping macro IARVRL.

,NUMRANGE=*numrange_addr*

Specifies the name (RS-type) or address (in register 2-12) of an optional parameter that provides the number of entries in the supplied RANGLIST. The value specified must be no greater than 16 entries. If you do not specify NUMRANGE, the system assumes the range list contains only one entry.

,TARGET_VIEW=READONLY

,TARGET_VIEW=SHAREDWRITE

,TARGET_VIEW=UNIQUEWRITE

,TARGET_VIEW=TARGETWRITE

,TARGET_VIEW=LIKESOURCE

,TARGET_VIEW=HIDDEN

Specifies the way you want to share storage when used on storage not already part of a sharing group, or how you want to change or add storage access to the sharing group for storage already shared.

The keywords that are valid for TARGET_VIEW and their meanings follow:

READONLY

Specifies that the target can be used only to read shared data. Any attempt to alter shared data by writing into the target will cause a program check.

SHAREDWRITE

Specifies that the target can be used to read or modify shared data. When a program changes data in the target, the new data becomes visible among all those programs that have READONLY and SHAREDWRITE access to the source. Those programs with UNIQUEWRITE access to the source will not see the changed data.

UNIQUEWRITE

Specifies that the target can be used to read shared data and to retain a private copy of the shared data should the source or any target get altered. When another user of the target modifies the data, the page in the target containing the modified data becomes a private copy that is unique to that user (with UNIQUEWRITE) and not accessible to any other program.

TARGETWRITE

Specifies that the target can be used to read shared data and retain a private copy of the shared data if this view of the shared data is altered. When another user of the target area writes new data into the target area, any page in the target area containing the new data becomes a private copy that is unique and is not seen by to any other user. The page is no longer a member of any sharing group. The original source data is unchanged. When a SHAREDWRITE view of the data gets altered, the TARGETWRITE view will see those changes.

LIKESOURCE

Specifies that the view type for the new target area is to be the same as the current view of the source. If the source is not currently shared, a copy of the source is made to the new target as if COPYNOW had been coded.

HIDDEN

Specifies that the data in the target area will be inaccessible until the view type is changed to READONLY, SHAREDWRITE, UNIQUEWRITE, or TARGETWRITE. Any attempt to access a hidden target area will cause a program check.

,COPYNOW

Specifies whether the target should get a copy of the source data when using UNIQUEWRITE or LIKESOURCE. You can use COPYNOW only when you specify TARGET_VIEW=UNIQUEWRITE or TARGET_VIEW=LIKESOURCE.

,RETAIN=YES**,RETAIN=NO**

Specifies whether a copy of the shared data is to be retained in the target after the system finishes processing the UNSHARE request.

RETAIN=YES

Specifies that the target view should retain a copy of the shared data. Using UNSHARE with RETAIN=YES requires the system to allocate new resources to back the target area.

RETAIN=NO

Specifies that the contents of the target area are unpredictable. To ensure zeroes, the user should issue a PGSER RELEASE or DSPSERV RELEASE on the area after unsharing it. RETAIN=NO is the default.

Note: PGRLSE, PGSER RELEASE, PGSER FREE with RELEASE=Y, and PGFREE RELEASE=Y may ignore some or all of the pages in the input range and will not notify the caller if this was done.

Any pages in the input range that match any of the following conditions will be skipped, and processing continues with the next page in the range:

- Storage is not allocated or all pages in a segment have not yet been referenced.
- Page is in PSA, SQA or LSQA.
- Page is V=R. Effectively, it's fixed.
- Page is in BLDL, (E)PLPA, or (E)MLPA.
- Page has a page fix in progress or a nonzero FIX count.
- Pages with COMMIT in progress or with DISASSOCIATE in progress.

,PLISTVER=IMPLIED_VERSION**,PLISTVER=MAX****,PLISTVER=*plistver***

Specifies the version of the macro. PLISTVER determines which parameter list the system generates. PLISTVER is an optional input parameter on all forms of the macro, including the list form. When using

PLISTVER, specify it on all macro forms used for a request and with the same value on all of the macro forms. The values are:

- **IMPLIED_VERSION**, which is the lowest version that allows all parameters specified on the request to be processed. If you omit the PLISTVER parameter, IMPLIED_VERSION is the default.
- **MAX**, if you want the parameter list to be the largest size currently possible. This size might grow from release to release and affect the amount of storage that your program needs.

If you can tolerate the size change, IBM recommends that you always specify PLISTVER=MAX on the list form of the macro. Specifying MAX ensures that the list-form parameter list is always long enough to hold all the parameters you might specify on the execute form; in this way, MAX ensures that the parameter list does not overwrite nearby storage.

- **0**, if you use the currently available parameters.

To code, specify in this input parameter one of the following:

- IMPLIED_VERSION
- MAX
- A decimal value of 0

ABEND codes

IARVSERV might abnormally terminate with the abend code X'6C5'. See [z/OS MVS System Codes](#) for an explanation and programmer response.

Return and reason codes

When the IARVSERV macro returns control to your program, GPR 15 contains the return code. If the return code is not 0, GPR 0 contains the reason code.

Hexadecimal Return Code	Hexadecimal Reason Code	Meaning and Action
00	None	Meaning: The IARVSERV request completed successfully. Action: None required.
04	xx0101xx	Meaning IARVSERV SHARE completed successfully. The processor does not support SHARE for UNIQUEWRITE. A unique copy of the target was made by the system. Action: None required.
04	xx0102xx	Meaning: IARVSERV SHARE completed successfully. However, the system found a condition that would lead to a storage requirement conflict for sharing with UNIQUEWRITE. For example, the source might be in non-pageable storage. A copy of the target was made by the system to avoid this conflict. Action: None required. However, you might want to correct the storage conflict.

Table 7. Return and Reason Codes for the IARVSERV Macro (continued)

Hexadecimal Return Code	Hexadecimal Reason Code	Meaning and Action
04	xx0103xx	<p>Meaning: IARVSERV SHARE found that some source pages were not obtained using the GETMAIN or STORAGE macros, or the source and target keys do not match and the request is for a UNIQUEWRITE target view. If the corresponding target pages were obtained using the GETMAIN or STORAGE macro, then they have been made first reference.</p> <p>Action: This is not necessarily an error. If you think you should not get this reason code, check program to be sure GETMAIN or STORAGE is issued and storage is of the same storage key for all source and target storage prior to using IARVSERV.</p>
04	xx0203xx	<p>Meaning: IARVSERV UNSHARE completed successfully. However, the system has overridden the RETAIN=NO option and kept a copy of the data in the target.</p> <p>Action: None required. However, you may want to correct your use of DIV.</p>
04	xx0204xx	<p>Meaning: IARVSERV UNSHARE completed successfully. The system has overridden the RETAIN=YES option because the shared data is associated with a DIV object, and the target area is not the original window mapped to the DIV object. The data in the target is unpredictable.</p> <p>Action: None required.</p>
04	xx0205xx	<p>Meaning: IARVSERV UNSHARE completed successfully. Some pages in the target area no longer belong to any sharing group. This could be due to a copy being created by UNIQUEWRITE, or a second invocation of UNSHARE on the same view.</p> <p>Action: None required.</p>
04	xx0301xx	<p>Meaning: IARVSERV CHANGEACCESS completed successfully. The processor does not support CHANGEACCESS for UNIQUEWRITE, and a unique copy of the target page was made.</p> <p>Action: None required.</p>
04	xx030Cxx	<p>Meaning: IARVSERV CHANGEACCESS completed successfully. The system processed a CHANGEACCESS request for UNIQUEWRITE or TARGETWRITE for non-shared pages as a SHAREDWRITE request.</p> <p>Action: None required.</p>
08	xx0104xx	<p>Meaning: Environmental error. An unauthorized user attempted to share more pages than allowed by the installation.</p> <p>Action: Contact your system programmer to find out your installation limit and reduce the number of shared pages.</p>

<i>Table 7. Return and Reason Codes for the IARVSERV Macro (continued)</i>		
Hexadecimal Return Code	Hexadecimal Reason Code	Meaning and Action
08	xx0105xx	Meaning: Environmental error. IARVSERV SHARE was requested with TARGETWRITE, but the SOP hardware feature was not available. Action: Contact your system programmer to find out when the SOP feature might become available.
08	xx0305xx	Meaning: Environmental error. IARVSERV CHANGEACCESS was requested with TARGETWRITE, but the SOP hardware feature was not available. Action: Contact your system programmer to find out when the SOP feature may become available.
0C	xx010Axx	Meaning: Environmental error. IARVSERV SHARE cannot complete the request because of a shortage of resources. Action: Retry the request one or more times to see if resources become available. Contact the system programmer to determine resources available to you.
0C	xx013Cxx	Meaning: System error. IARVSERV SHARE cannot complete the request because a required page is unavailable or lost. Action: Check the paging data set for possible I/O errors. Refer to X'028' abend description in z/OS MVS System Codes for paging error advice.
0C	xx020Bxx	Meaning: System error. IARVSERV UNSHARE cannot complete the request because of a required page being unavailable or lost. Action: Check the logrec data set for possible I/O errors. Refer to X'028' abend description in z/OS MVS System Codes for paging error advice.
0C	xx030Bxx	Meaning: System error. IARVSERV CHANGEACCESS cannot complete the request because of a required page being unavailable or lost. Action: Check the logrec data set for possible I/O errors. Refer to X'028' abend description in z/OS MVS System Codes for paging error advice.

Example 1

Issue a request to share eight pages as read-only, and use a register to specify the address of the range list.

```
SERV1  IARVSERV SHARE ,RANGLIST=(4) ,TARGET_VIEW=READONLY
*      IARVRL
```

Example 2

Issue UNSHARE for the pages in Example 1, and specify that the system is not to retain the shared data.

```
SERV2    IARVSERV UNSHARE,RANGLIST=(4),RETAIN=NO
*
        IARVRL
```

Example 3

Issue a request to share pages as read-only, and use an RS-type address to specify the location of the range list address.

```
SERV3    IARVSERV SHARE,RANGLIST=VRLPTR,TARGET_VIEW=READONLY
*
VRLPTR   DC      A(MYVRL1)
MYVRL1   DS      7F
        IARVRL
```

Example 4

Issue a request to share pages as target write.

```
SERV4    IARVSERV SHARE,RANGLIST=(5),TARGET_VIEW=TARGETWRITE
*
        IARVRL
```

Example 5

Issue a request to change access for hidden.

```
SERV5    IARVSERV CHANGEACCESS,RANGLIST=(5),TARGET_VIEW=HIDDEN
*
        IARVRL
```

Example 6

```
* The following example share one page of storage
* for both source and target using readonly view,
* and use a register to specify the address of the range list

* Clear the VRL share list. This will clear also the Stoken and
* the Alet fields for both Source and Target
XC      VRLSHAR,VRLSHAR      Clear VRL share list
* Obtain storage for Source (one page only)
TITLE 'IARVSERV- GET SOURCE STORAGE - ONE PAGE'
STORAGE OBTAIN,LENGTH=4096
ST      1,SADDR      Store Source address
* Obtain storage for Target (one page only)
TITLE 'IARVSERV- GET TARGET STORAGE - ONE PAGE'
STORAGE OBTAIN,LENGTH=4096
ST      1,TADDR      Store Target address

* Set the VRL share list
TITLE 'IARVSERV- SET VRL LIST FOR SHARE'
LA      1,1          Load number of pages to share
ST      1,VRLNUMPG   Store it in VRL share list
L       1,SADDR      Load Source address
ST      1,VRLSVSA    Store it in VRL share list
L       1,TADDR      Load Target address
ST      1,VRLTVSA    Store it in VRL share list

*
LA      7,VRLSHAR    Get address of VRLSHAR list
ST      7,VRLPTR     Store it in VRLPTR
LA      7,VRLPTR     Save address of rangelist

* Now issue share for both Source and Target
TITLE 'IARVSERV- SHARE THE STORAGE'
IARVSERV SHARE,
RANGLIST=(7),
NUMRANGE=1,
TARGET_VIEW=READONLY

* The declares for example
*
```

```

VRLSHAR DS    0XL28
VRLSVSA DS    A
VRLSSTK1 DS   XL4
VRLSALET DS   F
VRLNUMPG DS   A
VRLTVSA DS    A
VRLTSTK1 DS   XL4
VRLTALET DS   F
VREND1 DS    0F
VRLPTR DS     XL4
SADDR DS     XL4      Address for Source storage
TADDR DS     XL4      Address for Target storage

* The following example illustrates how to expediate the return
* of all control blocks used to manage the shared storage by
* unsharing both Source and Target views which were shared in
* the previous example
  TITLE 'IARVSERV- SET VRL UNSHARE LIST'
* Clear the VRL unshare list. This will clear also the Stoken
* and the Alet fields for both Source and Target in all ranges
* of the list
  XC,VRLUNSH,VRLUNSH
* Set first range in the VRL unshare list
  LA 1,1          Load number of pages to unshare
  ST 1,SNUMPG1    Store it for first range
  L 1,TADDR       Get target address
  ST 1,TVSA1      Save it in the target address
* Set second range in the VRL unshare list
  LA 1,1          Load number of pages to unshare
  ST 1,SNUMPG2    Store it for second range
  L 1,SADDR       Get source address
  ST 1,TVSA2      Save it in the target address
*
  LA 7,VRLUNSH    Get address of VRL unshare list
  ST 7,VRLPTR     Store it in VRLPTR
  LA 7,VRLPTR     Save address of rangelist

* Now issue unshare for both Source and Target
  TITLE 'IARVSERV- UNSHARE THE STORAGE'
  IARVSERV UNSHARE,
  RANGLIST=(7),
  NUMRANGE=2
* The declares for example
*
  VRLUNSH DS    0XL56
  SVSA1 DS     A
  SSTK1 DS     XL4
  SALET1 DS    F
  SNUMPG1 DS   A
  TVSA1 DS     A
  TSTK1 DS     XL4
  TALET1 DS    F
  SVSA2 DS     A
  SSTK2 DS     XL4
  SALET2 DS    F
  SNUMPG2 DS   A
  TVSA2 DS     A
  TSTK2 DS     XL4
  TALET2 DS    F
  VREND2 DS    0F

```

IARVSERV—List form

Use the list form of the IARVSERV macro together with the execute form of the macro for applications that require reentrant code. The list form of the macro defines an area of storage, which the execute form of the macro uses to contain the parameters.

The list form of the IARVSERV macro is written as follows:

Syntax	Description
<i>name</i>	<i>name</i> : symbol. Begin <i>name</i> in column 1.
b	One or more blanks must precede IARVSERV.

Syntax	Description
IARVSERV	
␣	One or more blanks must follow IARVSERV.
,PLISTVER=IMPLIED_VERSION	
,PLISTVER=MAX	Default: IMPLIED_VERSION
,PLISTVER= <i>plistver</i>	<i>plistver</i> : 0
MF=(L, <i>list addr</i>)	<i>list addr</i> : symbol.
MF=(L, <i>list addr,attr</i>)	<i>attr</i> : 1- to 60-character input string.
MF=(L, <i>list addr</i> ,0D)	Default: 0D

The parameters are explained under the standard form of the IARVSERV macro with the following exception:

MF=(L,*list addr*)

MF=(L,*list addr,attr*)

MF=(L,*list addr*,0D)

Specifies the list form of the IARVSERV macro.

list addr is the name of a storage area to contain the parameters.

attr is an optional 1- to 60-character input string, which can contain any value that is valid on an assembler DS pseudo-op. You can use this parameter to force boundary alignment of the parameter list. If you do not code *attr*, the system provides a value of 0D, which forces the parameter list to a doubleword boundary.

IARVSERV - Execute form

Use the execute form of the IARVSERV macro together with the list form of the macro for applications that require reentrant code. The execute form of the macro stores the parameters into the storage area defined by the list form.

The execute form of the IARVSERV macro is written as follows:

Syntax	Description
<i>name</i>	<i>name</i> : symbol. Begin <i>name</i> in column 1.
␣	One or more blanks must precede IARVSERV.
IARVSERV	
␣	One or more blanks must follow IARVSERV.

Syntax	Description
SHARE	
UNSHARE	
CHANGEACCESS	
,RANGLIST= <i>ranglist_addr</i>	<i>ranglist_addr</i> : RS-type address, or address in register (2) - (12).
,NUMRANGE= <i>numrange_addr</i>	<i>numrange_addr</i> : RS-type address, or address in register (2) - (12).
	Default: 1 range
,TARGET_VIEW=READONLY	
,TARGET_VIEW=SHAREDWRITE	
,TARGET_VIEW=UNIQUEWRITE	
,TARGET_VIEW=TARGETWRITE	
,TARGET_VIEW=LIKESOURCE	
,TARGET_VIEW=HIDDEN	
,COPYNOW	
,RETAIN=NO	Default: RETAIN=NO
,RETAIN=YES	
,PLISTVER=IMPLIED_VERSION	
,PLISTVER=MAX	Default: IMPLIED_VERSION
,PLISTVER= <i>plistver</i>	<i>plistver</i> : 0
,MF=(E, <i>list addr</i>)	<i>list addr</i> : RX-type address or address in register (2) - (12).
,MF=(E, <i>list addr</i> ,COMPLETE)	Default: COMPLETE
,MF=(E, <i>list addr</i> ,NOCHECK)	

The parameters are explained under the standard form of the IARVSERV macro with the following exception:

,MF=(E,*list addr*)

,MF=(E,*list addr*,COMPLETE)

,MF=(E,*list addr*,NOCHECK)

Specifies the execute form of the IARVSERV macro.

list addr specifies the area that the system uses to contain the parameters.

COMPLETE, which is the default, specifies that the system is to check for required parameters and supply defaults for omitted optional parameters.

NOCHECK specifies that the system is not to check for required parameters and is not to supply defaults for omitted optional parameters.

Chapter 6. IARV64 – 64-bit virtual storage allocation

Description

The IARV64 macro allows a program to use the full range of virtual storage in an address space that is supported by 64-bit addresses. The macro creates and frees storage areas above the two gigabyte address and manages the physical frames behind the storage. Each storage area is a multiple of one megabyte in size and begins on a megabyte boundary. You can think of the IARV64 macro as the GETMAIN/FREEMAIN, PGSER or STORAGE macro for virtual storage above the two gigabyte address.

The two gigabyte address in the address space is marked by a virtual line called the bar. The bar separates storage below the two gigabyte address, called below the bar, from storage above the two gigabyte address, called above the bar. Programs use the IARV64 macro to obtain storage above the bar in "chunks" of virtual storage called memory objects. Your installation can set a limit on the use of the address space above the bar for a single address space. The limit is called the MEMLIMIT.

When you create a memory object you can specify a guard area (not accessible) and a usable area. Later, you can change all or some of a guard area into an accessible area and vice versa.

The following services are provided:

GETSTOR

Create a memory object. ([“REQUEST=GETSTOR option of IARV64” on page 73](#))

CHANGEATTRIBUTE

Change an attribute of storage within one or more memory objects. ([REQUEST=CHANGEATTRIBUTE option of IARV64](#))

CHANGEGUARD

Request that a specified range in a memory object be changed from the guard state to the usable state or vice versa. ([“REQUEST=CHANGEGUARD option of IARV64” on page 87](#))

DETACH

Free one or more memory objects. ([“REQUEST=DETACH option of IARV64” on page 93](#))

DISCARDATA

Discard data within physical pages of one or more memory objects. ([“REQUEST=DISCARDATA option of IARV64” on page 98](#))

PAGEIN

Notify the system that data within physical pages of one or more memory objects are needed in the near future. ([“REQUEST=PAGEIN option of IARV64” on page 103](#))

PAGEOUT

Notify the system that data within physical pages of one or more memory objects will not be used in the near future. ([“REQUEST=PAGEOUT option of IARV64” on page 107](#))

For guidance information on the use of 64-bit virtual storage allocation, see [z/OS MVS Programming: Assembler Services Guide](#).

After the separate descriptions of each individual Request are the following sections which apply to all of the Requests:

- The abend codes in [“Abend and abend reason codes” on page 72](#),
- The return and reason codes in [“Return and reason codes” on page 72](#), and
- Examples of using IARV64 in [“Example” on page 73](#)

Note: The examples apply to REQUEST=GETSTOR and DETACH.

Facts associated with these services:

- A segment represents one megabyte of virtual storage on a one megabyte boundary.
- The limit of the amount of storage per address space allowed to be used above the bar is called the MEMLIMIT. This is similar to the REGION parameter for storage below the bar. The following category of storage does not count against the MEMLIMIT:
 - The guard area in a memory object.

Abend and abend reason codes

Regardless of specifying COND=NO or COND=YES, IARV64 might abnormally terminate with hexadecimal abend code DC2 and a 4-byte unique reason code. See the description of the COND parameter for each IARV64 request type being issued, and see [DC2](#) in *z/OS MVS System Codes* for an explanation of the abend and programmer response.

Return and reason codes

When the IARV64 macro returns control to your program:

- GPR 15 (and *retcode*, when you code RETCODE) contains a return code.
- When the value in GPR 15 is not zero, GPR 0 (and *rsncode*, when you code RSNCODE) contains a reason code.

If you are coding a conditional request (COND=YES), check the results of the request by validating the return and reason codes. Note that COND=YES does not necessarily prevent abends.

The following table identifies the hexadecimal return and reason codes. IBM support personnel may request the entire reason code, including the **xx** value.

Table 8. Return and Reason Codes for the IARV64 Macro		
Hexadecimal Return Code	Hexadecimal Reason Code	Meaning and Action
00	–	Meaning: Successful completion Action: None required
02	–	Meaning: Successful completion, with exception. For a LIST request, IARV64 requests have been issued since the previous call to LIST. Action: Re-issue the call if you need the information pertaining to those recent IARV64 requestsets.
04	–	Meaning: Successful completion, with exception. For a LIST request, that there are additional MOMBs which were not returned on this calls to LIST. Action: Issue the LIST call again to get the additional information.
06	–	Meaning: Successful completion, with exception. For a LIST request, there are additional MOMBs which were not returned on this calls to LIST and IARV64 requests have been issued since the previous call to LIST. Action: Issue the LIST call again to get the additional information.

Table 8. Return and Reason Codes for the IARV64 Macro (continued)

Hexadecimal Return Code	Hexadecimal Reason Code	Meaning and Action
08	–	<p>Meaning: The request is rejected because of non-system failure.</p> <p>This reason code can be issued for a conditional IARV64 request. In this case, this reason code is the same as the DC2 reason code issued from an unconditional IARV64 request. See DC2 in <i>z/OS MVS System Codes</i> for an explanation and programmer response. If the reason code is not in DC2, it has one of the following meanings:</p> <p>For a DETACH request, there were no memory objects deleted because none matched the user token provided.</p> <p>For a LIST request, there were no memory objects returned because no memory objects match the selection criteria.</p> <p>Action: For a DETACH request, make sure that the user token was correct.</p> <p>For a LIST request, no action is required.</p> <p>For other requests, see DC2 in <i>z/OS MVS System Codes</i> for an explanation and programmer response.</p>

Example

Operation:

1. Get 2 MB above the bar
2. Free the storage

The code is as follows.

```

SYSSTATE AMODE64=YES
*****
* Get storage above 2G *
*****
      IARV64 REQUEST=GETSTOR,SEGMENTS=NUMSEG, *
              ORIGIN=0, *
              RETCODE=LRETCODE,RSNCODE=LRSNCODE, *
              MF=(E,V64L)
*
* Place code to check return/reason codes here
*
*****
* Free the storage *
*****
      IARV64 REQUEST=DETACH,MEMOBJSTART=0, *
              RETCODE=LRETCODE,RSNCODE=LRSNCODE, *
              MF=(E,V64L)
*
* Place code to check return/reason codes here
*
NUMSEG  DC    AD(2)
ONEMEG  DC    AD(256)
DYNAREA DSECT
LRETCODE DS    F
LRSNCODE DS    F
0        DS    AD
      IARV64 MF=(L,V64L)

```

REQUEST=GETSTOR option of IARV64

REQUEST=GETSTOR allows you to create a memory object.

Note: For more information on GETSTOR requests, see the *z/OS MVS Programming: Extended Addressability Guide*.

Environment

The requirements for the caller are:

Environmental factor	Requirement
Minimum authorization:	Problem state and PSW key 8-15.
Dispatchable unit mode:	Task or SRB
Cross memory mode:	Any PASN, any HASN, any SASN A problem state caller running in PSW key 8-15 can use GETSTOR/DETACH only when the primary address space is the home address space.
AMODE:	31- or 64-bit
ASC mode:	Primary or access register (AR)
Interrupt status:	Enabled for I/O and external interrupts
Locks:	No locks may be held.
Control parameters:	Control parameters must be in the primary address space.

Programming requirements

None.

Restrictions

No data space ALETs can be specified.

Input register information

Before issuing the IARV64 macro, the caller does not have to place any information into any register unless using it in register notation for a particular parameter, or using it as a base register.

Output register information

When control returns to the caller, the GPRs contain:

Register

Contents

0

Reason code, if GPR 15 is non-zero

1

Used as a work register by the system

2-13

Unchanged

14

Used as a work register by the system

15

Return code

When control returns to the caller, the ARs contain:

Register

Contents

0-1

Used as work registers by the system

2-13

Unchanged

14-15

Used as work registers by the system

Some callers depend on register contents remaining the same before and after issuing a service. If the system changes the contents of registers on which the caller depends, the caller must save them before issuing the service, and restore them after the system returns control.

Performance implications

None

Syntax

The REQUEST=GETSTOR option of the IARV64 macro is written as follows:

Syntax	Description
<i>name</i>	<i>name</i> : symbol. Begin <i>name</i> in column 1.
␣	One or more blanks must precede IARV64.
IARV64	
␣	One or more blanks must follow IARV64.
REQUEST=GETSTOR	
,COND= <u>NO</u>	Default: COND=NO
,COND=YES	
,SEGMENTS= <i>segments</i>	<i>segments</i> : RS-type address or address in register (2) - (12).
,PAGEFRAMESIZE= <u>4K</u>	Default: PAGEFRAMESIZE=4K
,PAGEFRAMESIZE=PAGEABLE1MEG	
,FPROT= <u>YES</u>	Default: FPROT=YES
,FPROT=NO	
,SENSITIVE= <u>UNKNOWN</u>	Default: SENSITIVE=UNKNOWN
,SENSITIVE=YES	
,SENSITIVE=NO	

Syntax	Description
,SVCDUMPRGN= <u>YES</u>	Default: SVCDUMPRGN=YES
,SVCDUMPRGN=NO	
,USERTKN= <i>usertkn</i>	<i>usertkn</i> : RS-type address or address in register (2) - (12).
,USERTKN= <u>NO_USERTKN</u>	Default: USERTKN=NO_USERTKN
,GUARDSIZE= <i>guardsize</i>	<i>guardsize</i> : RS-type address or address in register (2) - (12).
,GUARDSIZE= <u>0</u>	Default: GUARDSIZE=0
,GUARDSIZE64= <i>guardsize64</i>	<i>guardsize64</i> : RS-type address or address in register (2) - (12).
,GUARDSIZE64= <u>0</u>	Default: GUARDSIZE64=0
,GUARDLOC= <u>LOW</u>	Default: GUARDLOC=LOW
,GUARDLOC=HIGH	
,TTOKEN= <i>ttoken</i>	<i>ttoken</i> : RS-type address or address in register (2) - (12).
,TTOKEN= <u>NO_TTOKEN</u>	Default: TTOKEN=NO_TTOKEN
,ORIGIN= <i>origin</i>	<i>origin</i> : RS-type address or address in register (2) - (12).
,SADMP= <u>DEFAULT</u>	Default: SADMP=DEFAULT
,SADMP=YES	
,SADMP=NO	
,INORIGIN= <i>inorigin</i>	<i>inorigin</i> : RS-type address or address in register (2) - (12).
,INORIGIN= <u>NO_INORIGIN</u>	Default: INORIGIN=NO_INORIGIN
,USE2GTO32G= <u>NO</u>	Default: USE2GTO32G=NO
,USE2GTO32G=YES	
,USE2GTO64G= <u>NO</u>	Default: USE2GTO64G=NO
,USE2GTO64G=YES	
,EXECUTABLE= <u>SYSTEM_RULES</u>	Default: EXECUTABLE=SYSTEM_RULES
,EXECUTABLE=YES	
,EXECUTABLE=NO	

Syntax	Description
,RETCODE= <i>retcode</i>	<i>retcode</i> : RS-type address or register (2) - (12).
,RSNCODE= <i>rsncode</i>	<i>rsncode</i> : RS-type address or register (2) - (12).
,PLISTVER= <u>IMPLIED_VERSION</u>	Default: PLISTVER=IMPLIED_VERSION
,PLISTVER=MAX	
,PLISTVER=0, 1	
,MF= <u>S</u>	Default: MF=S
,MF=(L, <i>list addr</i>)	<i>list addr</i> : RS-type address or register (1) - (12)
,MF=(L, <i>list addr</i> , <i>attr</i>)	
,MF=(L, <i>list addr</i> , <u>OD</u>)	
,MF=(E, <i>list addr</i>)	
,MF=(E, <i>list addr</i> , <u>COMPLETE</u>)	

Parameters

The parameters are explained as follows:

name

An optional symbol, starting in column 1, that is the name on the IARV64 macro invocation. The name must conform to the rules for an ordinary assembler language symbol.

REQUEST=GETSTOR

A required parameter. REQUEST=GETSTOR creates a memory object. Problem state routines running in PSW key 8-15 can use GETSTOR only when primary = home. When the memory object owner terminates, the memory object will be freed.

,COND=NO

,COND=YES

An optional parameter that specifies whether the request is unconditional or conditional. The default is COND=NO.

,COND=NO

The request is unconditional. The request will be abnormally ended when the request cannot be satisfied.

,COND=YES

The request is conditional. The request will not be abnormally ended for resource unavailability.

When you code COND=YES and there is insufficient storage to satisfy the request, instead of the request being abnormally ended, the request will complete but a return code will be set to indicate that the request could not be completed successfully. Use of COND=YES does not prevent all abnormal terminations. For instance, if the request has incorrect or inconsistent parameters, the system abnormally terminates the active unit of work.

,SEGMENTS=segments

A required input parameter that specifies the size of the memory object requested in megabytes. This must be a non-zero value. The amount of storage requested that is not in the guard state is charged against the MEMLIMIT for the address space where the memory object is to be created.

To code: Specify the RS-type address, or address in register (2) - (12), of a doubleword field.

,PAGEFRAMESIZE=4K**,PAGEFRAMESIZE=PAGEABLE1MEG**

An optional input parameter that specifies the size of the page frames to back the virtual storage mapped by the allocated memory object.

,PAGEFRAMESIZE=4K

The memory object is backed by 4 K page frames, if available. This is the default value.

,PAGEFRAMESIZE=PAGEABLE1MEG

The memory object is backed by pageable 1 M page frames at first reference, unless none are available. If none are available, the object is backed by 4 K page frames.

,FPROT=YES**,FPROT=NO**

An optional parameter that specifies whether the memory object should be fetch protected. The default is FPROT=YES.

,FPROT=YES

The entire memory object will be fetch protected. A program must have a PSW key that matches the storage key of the memory object (or have PSW key 0) to reference data in the memory object.

,FPROT=NO

The memory object will not be fetch protected.

,SENSITIVE=UNKNOWN**,SENSITIVE=YES****,SENSITIVE=NO**

An optional keyword input that specifies whether the memory object will contain data that is potentially sensitive (for instance, private or confidential). The default is SENSITIVE=UNKNOWN.

,SENSITIVE=UNKNOWN

Specifies that the sensitivity of the data is not known. The memory object may or may not contain sensitive data.

,SENSITIVE=YES

Specifies that the memory object contains sensitive data.

,SENSITIVE=NO

Specifies that the memory object does not contain sensitive data.

,SVCDUMPRGN=YES**,SVCDUMPRGN=NO**

An optional parameter that specifies whether the memory object should be included in an SVC dump when region is requested. The default is SVCDUMPRGN=YES.

,SVCDUMPRGN=YES

The memory object is included in an SVC dump when RGN is dumped. This is equivalent to DUMP=LIKERGN.

,SVCDUMPRGN=NO

The memory object is only included in an SVC dump when explicitly requested.

,USERTKN=*usertkn***,USERTKN=NO USERTKN**

An optional input parameter that identifies the user token to be associated with the memory object. This can be used on a later DETACH request to free all memory objects associated with this value.

To avoid inadvertent collisions in the values specified, the left word (bits 0 - 31) of the user token must be binary zeros for a problem state program. The system enforces this requirement. The right word (bits 32-63) should represent the virtual address of some storage related to the caller, which could be a control block address, an entry point address, and so on, which is used as an application choice.

The convention for supervisor state program is that the left word (bits 0 - 31) should represent an address of some storage related to the caller. The system enforces the rule that the left word is non-zero for supervisor state callers. The format for the right word (bits 32 - 63) is a choice left to the caller.

If you specify NO_USERTKN, the default is that no user token is supplied to associate this memory object with others. The default is NO_USERTKN.

To code: Specify the RS-type address, or address in register (2) - (12), of a doubleword field.

,GUARDSIZE=*guardsize*

,GUARDSIZE=0

GUARDSIZE and GUARDSIZE64 are mutually exclusive keys. This set is optional; only one key may be specified. A fullword integer input parameter that indicates the number of megabytes of guard area to be created at the high or low end of the memory object. Guard areas cannot be referenced and when referenced will cause a program check. Guard area does not count against the MEMLIMIT. A guard area can be reduced through CHANGEguard CONVERT=FROMguard.

GUARDSIZE must not be larger than the size of the memory object. The default is 0.

To code: Specify the RS-type address, or address in register (2) - (12), of a fullword field.

,GUARDSIZE64=*guardsize64*

,GUARDSIZE64=0

GUARDSIZE64 belongs to a set of mutually exclusive keys. This set is optional; only one key may be specified. A doubleword integer input parameter that indicates the number of megabytes of guard area to be created at the high or low end of the memory object. Guard areas cannot be referenced and when referenced will cause a program check. Guard area does not count against the MEMLIMIT. A guard area can be reduced through CHANGEguard CONVERT=FROMguard.

GUARDSIZE64 must not be larger than the size of the memory object. The default is 0.

To code: Specify the RS-type address, or address in register (2) - (12), of a doubleword field.

,GUARDLOC=LOW

,GUARDLOC=HIGH

An optional parameter that specifies whether the guard location is at the low virtual end of the memory object or the high virtual end. The default is GUARDLOC=LOW.

,GUARDLOC=LOW

The guard areas are created starting from the origin of the memory object, that is, from the low virtual end.

,GUARDLOC=HIGH

The guard areas are created at the end of the memory object, that is, at the high virtual end.

,Ttoken=*ttoken*

,Ttoken=NO_Ttoken

An optional input parameter that identifies the task to assume ownership of the memory object. The Ttoken is returned by the TCBtoken macro.

If Ttoken is specified, the task identified by the Ttoken becomes the owner of the memory object. If Ttoken is not specified, the currently dispatched task becomes the owner of the memory object.

The Ttoken parameter must be used by an caller that is an SRB.

When the Ttoken parameter is used by problem state program with PSW key 8 - 15, the target task must represent the calling task OR the job step task for the calling task OR the mother task. A caller cannot assign ownership to a task above the job step task.

A memory object will be freed when its owning task terminates.

If the Ttoken parameter is not specified, and the caller is a task (rather than an SRB), the currently dispatched task will become the owner of the memory object. An SRB will be abnormally ended if the Ttoken parameter does not specify a valid Ttoken. The default is NO_Ttoken.

To code: Specify the RS-type address, or address in register (2) - (12), of a 16-character field.

,ORIGIN=*origin*

A required output parameter that contains the lowest address of the memory object. Note that when GUARDLOC=LOW is specified, the lowest address will point to a guard area, which will cause an

ABEND if referenced. For GUARDLOC=LOW, the first usable area is the origin plus the size of the guard area.

Note: If MEMLIMIT is exceeded and RETCODE=8, then the address will be set to 7FFFF000 to cause an ABEND if referenced.

To code: Specify the RS-type address, or address in register (2) - (12), of an eight-byte pointer field.

,SADMP=DEFAULT

,SADMP=YES

,SADMP=NO

An optional keyword input that specifies whether the memory object is to be captured in a stand-alone dump.

SADMP=DEFAULT

When PAGEFRAMESIZE is not 2G, the memory object should be captured in a stand-alone dump.

When PAGEFRAMESIZE is 2G, the memory object should not be captured in a stand-alone dump unless explicitly requested by the stand-alone dump program.

SADMP=YES

The memory object should be captured in a stand-alone dump.

SADMP=NO

The memory object should not be captured in a stand-alone dump unless explicitly requested by the stand-alone dump program.

Default: SADMP=DEFAULT

,INORIGIN=inorigin

An optional 8-byte input parameter that contains the address of the desired storage to be obtained. The address must be on a 1 MB boundary. No part of the requested area can be in the 0 - 2G area, the 64-bit common area, or the 64-bit shared area. When a specific virtual area is requested (USE2GTO32G, USE2GTO64G), the entire INORIGIN requested area must be in that specific virtual area.

To code: Specify the RS-type address, or address in register (2) - (12), of an eight-byte pointer field.

, USE2GTO32G = NO

, USE2GTO32G = YES

An optional keyword input that specifies whether this is an explicit allocation request for 64-bit virtual storage in the 2G to 32G virtual storage area. IBM suggests that you not use this parameter because Java and other language runtimes use it. If there is not enough memory available in this range, the language runtimes could fail to start, or there could be increased memory usage and reduced performance. This parameter relates to usage of the compressed references feature, which is documented in *z/OS User Guide for IBM SDK, Java Technology Edition*.

Check the RCEUSE2GTO32GAREAOK bit in the IARRCE macro to ensure that the system supports this keyword.

USE2GTO32G=NO

The request is not to be satisfied from the 2G to 32G virtual storage area.

USE2GTO32G=YES

The request is to be satisfied from the 2G to 32G virtual storage area. You cannot specify USE2GTO32G=YES with USE2GTO64G=YES. When you specify USE2GTO32G=YES, the system ignores USE2GTO64G=NO.

Default: USE2GTO32G=NO

, USE2GTO64G = NO

, USE2GTO64G = YES

An optional keyword input that specifies whether this is an explicit allocation request for 64-bit virtual storage in the 2G to 64G virtual storage area. IBM suggests that you not use this parameter because Java and other language runtimes use it. If there is not enough memory available in this range, the language runtimes could fail to start, or there could be increased memory usage and reduced

performance. This parameter relates to usage of the compressed references feature, which is documented in *z/OS User Guide for IBM SDK, Java Technology Edition*.

Check the RCE_USE2GTO64GENABLE bit in the IARRCE macro to ensure that the system supports this keyword.

USE2GTO64G=NO

The request is not to be satisfied from the 2G to 64G virtual storage area.

USE2GTO32G=YES

The request is to be satisfied from the 2G to 64G virtual storage area. You cannot specify USE2GTO64G=YES with USE2GTO32G=YES. When you specify USE2GTO64G=YES, the system ignores USE2GTO32G=NO.

Default: USE2GTO64G=NO

,EXECUTABLE=SYSTEM_RULES

,EXECUTABLE=YES

,EXECUTABLE=NO

Specifies if code can be executed from the obtained storage on a system that has implemented instruction-execution-protection. The default parameter is ,EXECUTABLE=SYSTEM_RULES.

,EXECUTABLE=SYSTEM_RULES

This parameter indicates that code will obey the current system default.

,EXECUTABLE=YES

This parameter indicates that code is able to be executed from the obtained storage.

,EXECUTABLE=NO

This parameter indicates that code will not be able to be executed from the obtained storage on a system that has implemented instruction-execution-protection. The specification of NO will be ignored when executed on a system that has not implemented instruction-execution-protection or is not running an appropriate level of z/OS.

,RETCODE=retcode

An optional output parameter into which the return code is to be copied from GPR 15.

To code: Specify the RS-type address of a fullword field, or register (2) - (12).

,RSNCODE=rsncode

An optional output parameter into which the reason code is to be copied from GPR 0.

To code: Specify the RS-type address of a fullword field, or register (2) - (12).

,PLISTVER=IMPLIED_VERSION

,PLISTVER=MAX

,PLISTVER=0, 1

An optional input parameter that specifies the version of the macro. PLISTVER determines which parameter list the system generates. PLISTVER is an optional input parameter on all forms of the macro, including the list form. When using PLISTVER, specify it on all macro forms used for a request and with the same value on all of the macro forms. The values are:

- **IMPLIED_VERSION**, which is the lowest version that allows all parameters specified on the request to be processed. If you omit the PLISTVER parameter, IMPLIED_VERSION is the default.
- **MAX**, if you want the parameter list to be the largest size currently possible. This size might grow from release to release and affect the amount of storage that your program needs.

If you can tolerate the size change, IBM recommends that you always specify PLISTVER=MAX on the list form of the macro. Specifying MAX ensures that the list-form parameter list is always long enough to hold all the parameters you might specify on the execute form, when both are assembled with the same level of the system. In this way, MAX ensures that the parameter list does not overwrite nearby storage.

- **0**, if you use the currently available parameters.
- **1**, supports both the following parameters and parameters from version 0:

- CONVERTSIZE64
- CONVERTSTART
- GUARDSIZE64

To code: Specify one of the following:

- IMPLIED_VERSION
- MAX
- A decimal value of 0 or 1

,MF=S

,MF=(L,list addr)

,MF=(L,list addr,attr)

,MF=(L,list addr,OD)

,MF=(E,list addr)

,MF=(E,list addr,COMPLETE)

An optional input parameter that specifies the macro form.

Use MF=S to specify the standard form of the macro, which builds an inline parameter list and generates the macro invocation to transfer control to the service. MF=S is the default.

Use MF=L to specify the list form of the macro. Use the list form together with the execute form of the macro for applications that require reentrant code. The list form defines an area of storage that the execute form uses to store the parameters. Only the PLISTVER parameter may be coded with the list form of the macro.

Use MF=E to specify the execute form of the macro. Use the execute form together with the list form of the macro for applications that require reentrant code. The execute form of the macro stores the parameters into the storage area defined by the list form, and generates the macro invocation to transfer control to the service.

,list addr

The name of a storage area to contain the parameters. For MF=S and MF=E, this can be an RS-type address or an address in register (1) - (12).

,attr

An optional 1- to 60-character input string that you use to force boundary alignment of the parameter list. Use a value of 0F to force the parameter list to a word boundary, or 0D to force the parameter list to a doubleword boundary. If you do not code *attr*, the system provides a value of 0D.

,COMPLETE

Specifies that the system is to check for required parameters and supply defaults for omitted optional parameters.

REQUEST=CHANGEATTRIBUTE option of IARV64

REQUEST=CHANGEATTRIBUTE requests to change an attribute of storage within one or more memory objects.

Environment

The requirements for the caller are:

Environmental factor	Requirement
Minimum authorization:	Problem state and PSW key 8 - 15 that matches the storage key of the memory object to be changed.
Dispatchable unit mode:	Task or SRB.
Cross memory mode:	Any PASN, any HASN, any SASN.

Environmental factor	Requirement
AMODE:	31- or 64-bit.
ASC mode:	Primary or access register (AR).
Interrupt status:	Enabled for I/O and external interrupts.
Locks:	A local lock may be held.
Control parameters:	Control parameters must be in the primary address space and can reside both below and above the bar.

Programming requirements

None.

Restrictions

Before issuing the IARV64 REQUEST=CHANGEATTRIBUTE macro, it is the caller's responsibility to check that the RCE_SensitiveSupportApplied and RCE_ChangeAttributeApplied bits in the IARRCE macro are set to 1.

This macro supports multiple versions. Some keywords are unique to certain versions. See the PLISTVER parameter description.

Input register information

Before issuing the IARV64 macro, the caller does not have to place any information into any register unless using it in register notation for a particular parameter or using it as a base register.

Output register information

When control returns to the caller, the GPRs contain:

Register

Contents

- 0**
Reason code, if GPR 15 is non-zero
- 1**
Used as a work register by the system
- 2 - 13**
Unchanged
- 14**
Used as a work register by the system
- 15**
Return code

When control returns to the caller, the ARs contain:

Register

Contents

- 0 - 1**
Used as work registers by the system
- 2 - 13**
Unchanged
- 14 - 15**
Used as work registers by the system

Some callers depend on register contents remaining the same before and after issuing a service. If the system changes the contents of registers on which the caller depends, the caller must save them before issuing the service, and restore them after the service returns control.

Performance implications

None.

Syntax

The REQUEST=CHANGEATTRIBUTE option of the IARV64 macro is written as follows:

Syntax	Description
<i>name</i>	<i>name</i> : symbol. Begin <i>name</i> in column 1.
␣	One or more blanks must precede IARV64.
IARV64	
␣	One or more blanks must follow IARV64.
REQUEST=CHANGEATTRIBUTE	
,RANGLIST= <i>ranglist</i>	<i>ranglist</i> : RS-type address or address in register (2) - (12)
,SENSITIVE=UNKNOWN	
,SENSITIVE=YES	
,SENSITIVE=NO	
,NUMRANGE= <i>numrange</i>	<i>numrange</i> : RS-type address or address in register (2) - (12)
,NUMRANGE= <u>1</u>	Default: NUMRANGE=1
,RETCODE= <i>retcode</i>	<i>retcode</i> : RS-type address or register (2) - (12), or (15), (GPR15)
,RSNCODE= <i>rsncode</i>	<i>rsncode</i> : RS-type address or register (2) - (12), or (00), (GPR0)
,PLISTVER= <u>IMPLIED_VERSION</u>	Default: PLISTVER=IMPLIED_VERSION
,PLISTVER=MAX	
,PLISTVER=5	The PLISTVER value can be 5 or higher.

Syntax	Description
,MF= <u>S</u>	Default: MF=S
,MF=(L, <i>list addr</i>)	<i>list addr</i> : RS-type address or register (1) - (12).
,MF=(L, <i>list addr,attr</i>)	
,MF=(L, <i>list addr,0D</i>)	
,MF=(E, <i>list addr</i>)	
,MF=(E, <i>list addr,COMPLETE</i>)	

Parameters

The parameters are described as follows:

name

An optional symbol, starting in column 1, that is the name on the IARV64 macro invocation. The name must conform to the rules for an ordinary assembler language symbol.

REQUEST=CHANGEATTRIBUTE

A required parameter that notifies the system that an attribute of the specified range or ranges is to be changed. This request is only supported when the RCE_ChangeAttributeApplied bit in IARRCE is set.

Minimum authorization required: For a problem state program running in PSW key 8 - 15, the PSW key of the caller must match the storage key of the memory object to be changed.

,RANGLIST=*ranglist*

A required input parameter that contains the address of a list of a number of entries (as specified by NUMRANGE) where each entry is 16 bytes long. Each entry contains the following fields:

VSA

An 8-byte field that denotes the starting virtual address of the data to be changed. The value must be on a page (4K) boundary.

The specified address must be within storage obtained by one of the following services:

- IARV64 GETSTOR
- IARV64 GETCOMMON
- IARV64 GETSHARED

Changing the SENSITIVE attribute is not allowed for memory objects obtained by the following services:

- IARST64
- IARCP64

AMOUNT

An 8-byte field that contains the number of 4K pages to be changed. The specified number of pages, starting with the VSA, must lie within a single memory object.

To code: Specify the RS-type address, or address in register (2) - (12), of an 8-byte pointer field.

,SENSITIVE=[UNKNOWN|YES|NO]

A required parameter that specifies the data type attribute to be assigned to the pages. Marking data as sensitive allows installations to easily remove it from certain system diagnostics.

,SENSITIVE=UNKNOWN

Specifies that the data type of the pages is not known. The pages may or may not contain sensitive data.

,SENSITIVE=YES

Specifies that the pages contain sensitive data.

,SENSITIVE=NO

Specifies that the pages do not contain sensitive data.

,NUMRANGE=[numrange|1]

An optional input parameter that specifies the number of entries in the supplied range list.

The specified value must be less than or equal to 16. The default is 1.

When multiple range list entries are provided, they can be a mixture of private, common, and shared memory objects.

To code: Specify the RS-type address, or address in register (2) - (12), of a fullword field, or specify a literal decimal value.

,RETCODE=retcode

An optional output parameter into which the return code is to be copied from GPR 15.

To code: Specify the RS-type address of a fullword field, or register (2) - (12), or (15), (GPR15).

,RSNCODE=rsncode

An optional output parameter into which the reason code is to be copied from GPR 0.

To code: Specify the RS-type address of a fullword field, or register (2) - (12), or (00), (GPR0).

,PLISTVER=IMPLIED_VERSION**,PLISTVER=MAX****,PLISTVER=5**

An optional input parameter that specifies the version of the macro. PLISTVER determines which parameter list the system generates. PLISTVER is an optional input parameter on all forms of the macro, including the list form. When using PLISTVER, specify it on all macro forms used for a request and with the same value on all of the macro forms.

The SENSITIVE keyword requires a version level of 5 or higher.

The values are:

- **IMPLIED_VERSION**, which is the lowest version that allows all parameters specified on the request to be processed. If you omit the PLISTVER parameter, IMPLIED_VERSION is the default.
- **MAX**, if you want the parameter list to be the largest size currently possible. This size might grow from release to release and affect the amount of storage that your program needs.

If you can tolerate the size change, IBM recommends that you always specify PLISTVER=MAX on the list form of the macro. Specifying MAX ensures that the list-form parameter list is always long enough to hold all the parameters you might specify on the execute form, when both are assembled with the same level of the system. In this way, MAX ensures that the parameter list does not overwrite nearby storage.

- **5**, supports both the following parameter and the parameters from lower versions:
 - SENSITIVE

To code: Specify one of the following:

- **IMPLIED_VERSION**
- **MAX**
- A decimal value of 5 or higher

,MF=S
,MF=(L,list addr)
,MF=(L,list addr,attr)
,MF=(L,list addr,0D)
,MF=(E,list addr)
,MF=(E,list addr,COMPLETE)

An optional input parameter that specifies the macro form.

Use MF=S to specify the standard form of the macro, which builds an inline parameter list and generates the macro invocation to transfer control to the service. MF=S is the default.

Use MF=L to specify the list form of the macro. Use the list form together with the execute form of the macro for applications that require reentrant code. The list form defines an area of storage that the execute form uses to store the parameters. Only the PLISTVER parameter may be coded with the list form of the macro.

Use MF=E to specify the execute form of the macro. Use the execute form together with the list form of the macro for applications that require reentrant code. The execute form of the macro stores the parameters into the storage area defined by the list form, and generates the macro invocation to transfer control to the service.

,list addr

The name of a storage area to contain the parameters. For MF=S and MF=E, this can be an RS-type address or an address in register (1)-(12).

,attr

An optional 1- to 60-character input string that you use to force boundary alignment of the parameter list. Use a value of 0F to force the parameter list to a word boundary, or 0D to force the parameter list to a doubleword boundary. If you do not code *attr*, the system provides a value of 0D.

,COMPLETE

Specifies that the system is to check for required parameters and supply defaults for omitted optional parameters.

REQUEST=CHANGEGUARD option of IARV64

REQUEST=CHANGEGUARD requests that a specified amount of a memory object be changed from the guard area to the usable area or vice versa.

Environment

The requirements for the caller are:

Environmental factor	Requirement
Minimum authorization:	Problem state and PSW key 8-15.
Dispatchable unit mode:	Task or SRB
Cross memory mode:	PASN=HASN
AMODE:	31- or 64-bit
ASC mode:	Primary or access register (AR)
Interrupt status:	Enabled for I/O and external interrupts
Locks:	No locks may be held.
Control parameters:	Control parameters must be in the primary address space.

Programming requirements

None.

Restrictions

No data space ALETs can be specified.

Input register information

Before issuing the IARV64 macro, the caller does not have to place any information into any register unless using it in register notation for a particular parameter, or using it as a base register.

Output register information

When control returns to the caller, the GPRs contain:

Register

Contents

0

Reason code, if GPR 15 is non-zero

1

Used as a work register by the system

2-13

Unchanged

14

Used as a work register by the system

15

Return code

When control returns to the caller, the ARs contain:

Register

Contents

0-1

Used as work registers by the system

2-13

Unchanged

14-15

Used as work registers by the system

Some callers depend on register contents remaining the same before and after issuing a service. If the system changes the contents of registers on which the caller depends, the caller must save them before issuing the service, and restore them after the system returns control.

Performance implications

None

Syntax

The REQUEST=CHANGEGUARD option of the IARV64 macro is written as follows:

Syntax	Description
<i>name</i>	<i>name</i> : symbol. Begin <i>name</i> in column 1.

Syntax	Description
␣	One or more blanks must precede IARV64.
IARV64	
␣	One or more blanks must follow IARV64.
REQUEST=CHANGEGUARD	
,CONVERT=TOGUARD	
,CONVERT=FROMGUARD	
,COND= <u>NO</u>	Default: COND=NO
,COND=YES	
,MEMOBJSTART= <i>memobjstart</i>	<i>memobjstart</i> : RS-type address or address in register (2) - (12).
,CONVERTSTART= <i>convertstart</i>	<i>convertstart</i> : RS-type address or address in register (2) - (12).
,CONVERTSIZE= <i>convertsize</i>	<i>convertsize</i> : RS-type address or address in register (2) - (12).
,CONVERTSIZE64= <i>convertsize64</i>	<i>convertsize64</i> : RS-type address or address in register (2) - (12).
,RETCODE= <i>retcode</i>	<i>retcode</i> : RS-type address or register (2) - (12).
,RSNCODE= <i>rsncode</i>	<i>rsncode</i> : RS-type address or register (2) - (12).
,PLISTVER= <u>IMPLIED_VERSION</u>	Default: PLISTVER=IMPLIED_VERSION
,PLISTVER=MAX	
,PLISTVER=0, 1	
,MF= <u>S</u>	Default: MF=S
,MF=(L, <i>list addr</i>)	<i>list addr</i> : RS-type address or register (1) - (12).
,MF=(L, <i>list addr,attr</i>)	
,MF=(L, <i>list addr,0D</i>)	
,MF=(E, <i>list addr</i>)	

Syntax	Description
,MF=(E, <i>list addr</i> ,COMPLETE)	

Parameters

The parameters are explained as follows:

name

An optional symbol, starting in column 1, that is the name on the IARV64 macro invocation. The name must conform to the rules for an ordinary assembler language symbol.

REQUEST=CHANGEGUARD

A required parameter. REQUEST=CHANGEGUARD changes the amount of guard area in the specified memory object. It changes part of the memory object from a guard area to a usable area, or vice-versa.

If the CHANGEGUARD service finds a PAGEFIXed area in the area to be converted into a guard area, the caller will be abnormally ended.

For a problem state program running in PSW key (8–15), the PSW key of the caller must match the storage key of the memory object, and the memory object must be owned by one of the following:

- The calling task
- The job step task
- An ancestor task up through the job step task

,CONVERT=TOGUARD

,CONVERT=FROMGUARD

A required parameter that specifies whether to add or remove guard areas.

,CONVERT=TOGUARD

Convert the specified number of usable areas to the guard areas. The sensitive state of the guard area will be reset to the memory object's original state, and the data in the converted areas will be released. This operation reduces the amount of virtual storage that contributes toward the MEMLIMIT for the address space.

When GUARDLOC=LOW was specified, the first usable virtual address in the memory object is increased.

When GUARDLOC=HIGH was specified, the last usable virtual address in the memory object is decreased.

,CONVERT=FROMGUARD

Convert the specified amount of guard area to be usable area. The converted (now usable) area will appear as pages of zeros. This operation increases the amount of area that contributes toward the MEMLIMIT for the address space.

When GUARDLOC=LOW was specified, the first usable virtual address in the memory object is decreased.

When GUARDLOC=HIGH was specified, the last usable virtual address in the memory object is increased.

,COND=NO

,COND=YES

An optional input parameter that specifies an unconditional or conditional request. The default is COND=NO.

,COND=NO

The request is unconditional. The request will be abnormally ended when the request cannot be satisfied.

,COND=YES

The request is conditional. The request will not be abnormally ended when a MEMLIMIT violation would occur.

Use of COND=YES does not prevent all abnormal terminations. For instance, if the request has incorrect or inconsistent parameters, the system abnormally ends the active unit of work. When you code COND=YES and there is insufficient storage to satisfy the request, instead of the request being abnormally ended, the request will complete but a return code will be set to indicate that the request could not be completed successfully.

,MEMOBJSTART=memobjstart

CONVERSTART and MEMOBJSTART are a set of mutually exclusive keys. This set is required; only one keyword must be specified. An input parameter that belongs to a required set of mutually exclusive keys. It contains the address of the first byte in the memory object.

Specifying MEMOBJSTART will change the guard area only at the beginning or the end of the memory object. Whether the guard area is at the beginning or the end is specified on the IARV64 REQUEST=GETSTOR GUARDLOC=[HIGH|LOW]

To code: Specify the RS-type address, or address in register (2)-(12), of an eight byte pointer field.

,CONVERTSTART=convertstart

CONVERSTART and MEMOBJSTART are a set of mutually exclusive keys. This set is required; only one keyword must be specified. An input parameter that belongs to a required set of mutually exclusive keys. CONVERTSTART specifies the address to add a guard area (continuing to the virtual address specified by adding the bytes defined in CONVERTSIZE to CONVERTSTART minus one) when CONVERT(TOGUARD) is requested, and specifies the address to remove from the guard area (continuing to the virtual address space specified by adding the bytes defined by CONVERTSIZE to CONVERTSTART minus one) when CONVERT(FROMGUARD) is requested.

Two contiguous guard areas will be consolidated into one contiguous guard area whenever possible. For example, if the guard area that was defined when the memory object was created is contiguous with a guard area created using CONVERTSTART, then the two guard areas are combined into one.

Specifying MEMOBJSTART will change the guard area only at the beginning or the end of the memory object. Whether the guard area is at the beginning or the end is specified on the IARV64 REQUEST=GETSTOR GUARDLOC=[HIGH|LOW]

IBM recommends that if CONVERTSTART is used to manage the guard areas within a memory object that all REQUEST=CHANGEGUARD use CONVERTSTART.

To code: Specify the RS-type address, or address in register (2)-(12), of an eight-byte pointer field.

,CONVERTSIZE=convertsize

CONVERTSIZE64 and CONVERTSIZE are a set of mutually exclusive keys. This set is required; only one key must be specified. A fullword integer input parameter, that indicates the number of contiguous megabytes that should be removed from the guard area (FROMGUARD) or that should be changed to being part of the guard area (TOGUARD).

For CONVERT=TOGUARD, CONVERTSIZE must not be larger than the number of usable pages in the memory object to allow successful completion. For CONVERT=FROMGUARD, CONVERTSIZE must not be larger than the number of remaining pages in the guard area of the memory object to allow successful completion.

To code: Specify the RS-type address, or address in register (2)-(12), of a fullword field.

,CONVERTSIZE64=convertsize64

CONVERTSIZE64 and CONVERTSIZE are a set of mutually exclusive keys. This set is required; only one key must be specified. A doubleword integer input parameter, that indicates the number of contiguous megabytes that should be removed from the guard area (FROMGUARD) or that should be changed to being part of the guard area (TOGUARD).

For CONVERT=TOGUARD and MEMOBJSTART, CONVERTSIZE or CONVERTSIZE64 must not be larger than the number of usable pages in the memory object to allow successful completion. For

CONVERT=FROMGUARD, CONVERTSIZE must not be larger than the number of remaining pages in the default guard area of the memory object to allow successful completion.

To code: Specify the RS-type address, or address in register (2)-(12), of a doubleword field.

,RETCODE=retcode

An optional output parameter into which the return code is to be copied from GPR 15.

To code: Specify the RS-type address of a fullword field, or register (2)-(12).

,RSNCODE=rsncode

An optional output parameter into which the reason code is to be copied from GPR 0.

To code: Specify the RS-type address of a fullword field, or register (2)-(12).

,PLISTVER=IMPLIED_VERSION

,PLISTVER=MAX

,PLISTVER=0, 1

An optional input parameter that specifies the version of the macro. PLISTVER determines which parameter list the system generates. PLISTVER is an optional input parameter on all forms of the macro, including the list form. When using PLISTVER, specify it on all macro forms used for a request and with the same value on all of the macro forms. The values are:

- **IMPLIED_VERSION**, which is the lowest version that allows all parameters specified on the request to be processed. If you omit the PLISTVER parameter, IMPLIED_VERSION is the default.
- **MAX**, if you want the parameter list to be the largest size currently possible. This size might grow from release to release and affect the amount of storage that your program needs.

If you can tolerate the size change, IBM recommends that you always specify PLISTVER=MAX on the list form of the macro. Specifying MAX ensures that the list-form parameter list is always long enough to hold all the parameters you might specify on the execute form, when both are assembled with the same level of the system. In this way, MAX ensures that the parameter list does not overwrite nearby storage.

- **0**, if you use the currently available parameters.
- **1**, supports both the following parameters and parameters from version 0:
 - CONVERTSIZE64
 - CONVERTSTART
 - GUARDSIZE64

To code: Specify one of the following:

- IMPLIED_VERSION
- MAX
- A decimal value of 0 or 1

,MF=S

,MF=(L,list addr)

,MF=(L,list addr,attr)

,MF=(L,list addr,0D)

,MF=(E,list addr)

,MF=(E,list addr,COMPLETE)

An optional input parameter that specifies the macro form.

Use MF=S to specify the standard form of the macro, which builds an inline parameter list and generates the macro invocation to transfer control to the service. MF=S is the default.

Use MF=L to specify the list form of the macro. Use the list form together with the execute form of the macro for applications that require reentrant code. The list form defines an area of storage that the execute form uses to store the parameters. Only the PLISTVER parameter may be coded with the list form of the macro.

Use MF=E to specify the execute form of the macro. Use the execute form together with the list form of the macro for applications that require reentrant code. The execute form of the macro stores the parameters into the storage area defined by the list form, and generates the macro invocation to transfer control to the service.

,list addr

The name of a storage area to contain the parameters. For MF=S and MF=E, this can be an RS-type address or an address in register (1)-(12).

,attr

An optional 1- to 60-character input string that you use to force boundary alignment of the parameter list. Use a value of 0F to force the parameter list to a word boundary, or 0D to force the parameter list to a doubleword boundary. If you do not code *attr*, the system provides a value of 0D.

,COMPLETE

Specifies that the system is to check for required parameters and supply defaults for omitted optional parameters.

REQUEST=DETACH option of IARV64

REQUEST=DETACH allows you to free one or more memory objects.

Environment

The requirements for the caller are:

Environmental factor	Requirement
Minimum authorization:	Problem state and PSW key 8-15.
Dispatchable unit mode:	Task or SRB
Cross memory mode:	Any PASN, any HASN, any SASN Note: that problem state caller running in PSW key 8-15 can use GETSTOR/DETACH only when primary = home.
AMODE:	31- or 64-bit
ASC mode:	Primary or access register (AR)
Interrupt status:	Enabled for I/O and external interrupts
Locks:	No locks may be held.
Control parameters:	Control parameters must be in the primary address space.

Programming requirements

None.

Restrictions

No data space ALETs can be specified.

Input register information

Before issuing the IARV64 macro, the caller does not have to place any information into any register unless using it in register notation for a particular parameter, or using it as a base register.

Output register information

When control returns to the caller, the GPRs contain:

IARV64 macro

Register Contents

- 0** Reason code, if GPR 15 is non-zero
- 1** Used as a work register by the system
- 2-13** Unchanged
- 14** Used as a work register by the system
- 15** Return code

When control returns to the caller, the ARs contain:

Register Contents

- 0-1** Used as work registers by the system
- 2-13** Unchanged
- 14-15** Used as work registers by the system

Some callers depend on register contents remaining the same before and after issuing a service. If the system changes the contents of registers on which the caller depends, the caller must save them before issuing the service, and restore them after the system returns control.

Performance implications

None

Syntax

The REQUEST=DETACH option of the IARV64 macro is written as follows:

Syntax	Description
<i>name</i>	<i>name</i> : symbol. Begin <i>name</i> in column 1.
␣	One or more blanks must precede IARV64.
IARV64	
␣	One or more blanks must follow IARV64.
REQUEST=DETACH	
,MATCH= <u>SINGLE</u>	Default: MATCH=SINGLE
,MATCH=USERTOKEN	

Syntax	Description
,MEMOBJSTART= <i>memobjstart</i>	<i>memobjstart</i> : RS-type address or address in register (2) - (12).
,USERTKN= <i>usertkn</i>	<i>usertkn</i> : RS-type address or address in register (2) - (12).
,USERTKN= <u>NO_USERTKN</u>	Default: USERTKN=NO_USERTKN
,USERTKN= <i>usertkn</i>	<i>usertkn</i> : RS-type address or address in register (2) - (12).
,OWNER= <u>YES</u>	Default: OWNER=YES
,TTOKEN= <i>ttoken</i>	<i>ttoken</i> : RS-type address or address in register (2) - (12).
,TTOKEN= <u>NO_TTOKEN</u>	Default: TTOKEN=NO_TTOKEN
,COND= <u>NO</u>	Default: COND=NO
,COND=YES	
,RETCODE= <i>retcode</i>	<i>retcode</i> : RS-type address or register (2) - (12).
,RSNCODE= <i>rsncode</i>	<i>rsncode</i> : RS-type address or register (2) - (12).
,PLISTVER= <u>IMPLIED_VERSION</u>	Default: PLISTVER=IMPLIED_VERSION
,PLISTVER=MAX	
,PLISTVER=0, 1	
,MF= <u>S</u>	Default: MF=S
,MF=(L, <i>list addr</i>)	<i>list addr</i> : RS-type address or register (1) - (12).
,MF=(L, <i>list addr,attr</i>)	
,MF=(L, <i>list addr,0D</i>)	
,MF=(E, <i>list addr</i>)	
,MF=(E, <i>list addr,COMPLETE</i>)	

Parameters

The parameters are explained as follows:

name

An optional symbol, starting in column 1, that is the name on the IARV64 macro invocation. The name must conform to the rules for an ordinary assembler language symbol.

REQUEST=DETACH

A required parameter. REQUEST=DETACH frees one or more memory objects. Note that problem state programs running in PSW key (8-15) can use this function only when primary = home.

A memory object can be affected by DETACH when MATCH=SINGLE USERTKN=NO_USERTKN is specified, even when the memory object has an associated user token. Other invocations of DETACH will affect memory objects only when a matching user token is passed.

All I/O into each memory object specified must be complete before the DETACH is requested. If the DETACH service finds a PAGEFIXed page in the memory object, the memory object will be not be freed, but any prior pages will have indeterminate data and the caller will be abnormally ended.

,MATCH=SINGLE**,MATCH=USERTOKEN**

An optional parameter that indicates which memory objects are to be freed. The default is MATCH=SINGLE.

,MATCH=SINGLE

specifies that the input contains MEMOBJSTART for a single memory object.

,MATCH=USERTOKEN

specifies that the input contains a user token that was passed to GETSTOR. Note that memory objects not associated with a user token are not affected. (Such objects would have to have been created using GETSTOR NOUSERTKN). If you code MATCH=USERTOKEN, COND=YES and no matching user token exists, the system returns a return code instead of abending the caller. All memory objects associated with this user token are to be freed.

If the system encounters an error in processing a qualifying memory object (e.g. unexpected pagefixed page), the processing ends. The system does not process that page or any further pages or memory objects and abends the caller.

,MEMOBJSTART=memobjstart

When MATCH=SINGLE is specified, a required input parameter that contains the address of the first byte in the memory object.

To code: Specify the RS-type address, or address in register (2)-(12), of an eight-byte pointer field.

,USERTKN=usertkn**,USERTKN=NO_USERTKN**

When MATCH=SINGLE is specified, an optional input parameter that identifies the user token to uniquely identify the memory object, as previously passed to GETSTOR.

When the memory object is not associated with the input token value, it will not be processed. The default is NO_USERTKN.

To code: Specify the RS-type address, or address in register (2)-(12), of a doubleword field.

,USERTKN=usertkn

When MATCH=USERTOKEN is specified, a required input parameter that identifies the user token.

To code: Specify the RS-type address, or address in register (2)-(12), of a doubleword field.

,OWNER=YES

An optional parameter that specifies whether the owning task still exists. The default is OWNER=YES.

,OWNER=YES

The owning task must still exist (it may be in termination however). The TTOKEN is provided or defaulted for the owning task.

,TTOKEN=ttoken**,TTOKEN=NO_TTOKEN**

When OWNER=YES is specified, an optional input parameter that identifies the task that owns the memory object. The TTOKEN is returned by the TCBTOKEN macro.

If TTOKEN is not specified, the task issuing the DETACH request must be the owner of the memory object.

When the TTOKEN parameter is used by problem state programs with PSW key 8-15, the target task must represent the calling task OR the jobstep task for the calling task OR the mother task. The mother task may not be given however when the calling task is itself a jobstep task.

If the TTOKEN parameter is not specified, and the caller is a TCB, the currently dispatched task must be the owner of the memory object. When OWNER YES is specified by an SRB, the caller will be abnormally ended if the TTOKEN value is not supplied. The default is NO_TTOKEN.

To code: Specify the RS-type address, or address in register (2)-(12), of a 16-character field.

,COND=NO

,COND=YES

An optional parameter that specifies whether the request is unconditional or conditional. In all cases the request will be abnormally ended for invalid requests, including violation of environmental restrictions. The default is COND=NO.

,COND=NO

The request is unconditional. The request will be abnormally ended when the request cannot be satisfied.

,COND=YES

The request is conditional. A REQUEST=DETACH, MATCH=USERTOKEN which does not select any memory objects will not be abnormally ended.

Use of COND=YES does not prevent all abnormal terminations. For instance, if the request has incorrect or inconsistent parameters, the system abnormally terminates the active unit of work.

,RETCODE=retcode

An optional output parameter into which the return code is to be copied from GPR 15.

To code: Specify the RS-type address of a fullword field, or register (2)-(12).

,RSNCODE=rsncode

An optional output parameter into which the reason code is to be copied from GPR 0.

To code: Specify the RS-type address of a fullword field, or register (2)-(12).

,PLISTVER=IMPLIED_VERSION

,PLISTVER=MAX

,PLISTVER=0, 1

An optional input parameter that specifies the version of the macro. PLISTVER determines which parameter list the system generates. PLISTVER is an optional input parameter on all forms of the macro, including the list form. When using PLISTVER, specify it on all macro forms used for a request and with the same value on all of the macro forms. The values are:

- **IMPLIED_VERSION**, which is the lowest version that allows all parameters specified on the request to be processed. If you omit the PLISTVER parameter, IMPLIED_VERSION is the default.
- **MAX**, if you want the parameter list to be the largest size currently possible. This size might grow from release to release and affect the amount of storage that your program needs.

If you can tolerate the size change, IBM recommends that you always specify PLISTVER=MAX on the list form of the macro. Specifying MAX ensures that the list-form parameter list is always long enough to hold all the parameters you might specify on the execute form, when both are assembled with the same level of the system. In this way, MAX ensures that the parameter list does not overwrite nearby storage.

- **0**, if you use the currently available parameters.
- **1**, supports both the following parameters and parameters from version 0:
 - CONVERTSIZE64
 - CONVERTSTART
 - GUARDSIZE64

To code: Specify one of the following:

- IMPLIED_VERSION
- MAX
- A decimal value of 0 or 1

,MF=S

,MF=(L,list addr)

,MF=(L,list addr,attr)

,MF=(L,list addr,OD)

,MF=(E,list addr)

,MF=(E,list addr,COMPLETE)

An optional input parameter that specifies the macro form.

Use MF=S to specify the standard form of the macro, which builds an inline parameter list and generates the macro invocation to transfer control to the service. MF=S is the default.

Use MF=L to specify the list form of the macro. Use the list form together with the execute form of the macro for applications that require reentrant code. The list form defines an area of storage that the execute form uses to store the parameters. Only the PLISTVER parameter may be coded with the list form of the macro.

Use MF=E to specify the execute form of the macro. Use the execute form together with the list form of the macro for applications that require reentrant code. The execute form of the macro stores the parameters into the storage area defined by the list form, and generates the macro invocation to transfer control to the service.

,list addr

The name of a storage area to contain the parameters. For MF=S and MF=E, this can be an RS-type address or an address in register (1)-(12).

,attr

An optional 1- to 60-character input string that you use to force boundary alignment of the parameter list. Use a value of 0F to force the parameter list to a word boundary, or 0D to force the parameter list to a doubleword boundary. If you do not code *attr*, the system provides a value of 0D.

,COMPLETE

Specifies that the system is to check for required parameters and supply defaults for omitted optional parameters.

REQUEST=DISCARDATA option of IARV64

REQUEST=DISCARDATA allows you to discard data within physical pages of one or more memory objects.

Environment

The requirements for the caller are:

Environmental factor	Requirement
Minimum authorization:	Problem state and PSW key 8-15. The caller must be running in supervisor state or with PSW key 0-7 or have a PSW key that matches the storage key of the memory object to be cleared by DISCARDATA.
Dispatchable unit mode:	Task or SRB
Cross memory mode:	Any PASN, any HASN, any SASN
AMODE:	31- or 64-bit

Environmental factor	Requirement
ASC mode:	Primary or access register (AR)
Interrupt status:	Enabled for I/O and external interrupts
Locks:	No locks may be held.
Control parameters:	Control parameters must be in the primary address space and can reside both below and above the bar.

Programming requirements

None.

Restrictions

No data space ALETs can be specified.

Input register information

Before issuing the IARV64 macro, the caller does not have to place any information into any register unless using it in register notation for a particular parameter, or using it as a base register.

Output register information

When control returns to the caller, the GPRs contain:

Register	Contents
0	Reason code, if GPR 15 is non-zero
1	Used as a work register by the system
2-13	Unchanged
14	Used as a work register by the system
15	Return code

When control returns to the caller, the ARs contain:

Register	Contents
0-1	Used as work registers by the system
2-13	Unchanged
14-15	Used as work registers by the system

Some callers depend on register contents remaining the same before and after issuing a service. If the system changes the contents of registers on which the caller depends, the caller must save them before issuing the service, and restore them after the system returns control.

Performance implications

None

Syntax

The REQUEST=DISCARDDATA option of the IARV64 macro is written as follows:

Syntax	Description
<i>name</i>	<i>name</i> : symbol. Begin <i>name</i> in column 1.
b	One or more blanks must precede IARV64.
IARV64	
b	One or more blanks must follow IARV64.
REQUEST=DISCARDDATA	
,KEEPREAL= <u>YES</u>	Default: KEEPREAL=YES
,KEEPREAL=NO	
,CLEAR= <u>YES</u>	Default: CLEAR=YES
,CLEAR=NO	
,RANGLIST= <i>ranglist</i>	<i>ranglist</i> : RS-type address or address in register (2) - (12).
,NUMRANGE= <i>numrange</i>	<i>numrange</i> : RS-type address or address in register (2) - (12).
,NUMRANGE= <u>1</u>	Default: NUMRANGE=1
,RETCODE= <i>retcode</i>	<i>retcode</i> : RS-type address or register (2) - (12).
,RSNCODE= <i>rsncode</i>	<i>rsncode</i> : RS-type address or register (2) - (12).
,PLISTVER= <u>IMPLIED_VERSION</u>	Default: PLISTVER=IMPLIED_VERSION
,PLISTVER=MAX	
,PLISTVER=0, 1	
,MF= <u>S</u>	Default: MF=S
,MF=(L, <i>list addr</i>)	<i>list addr</i> : RS-type address or register (1) - (12).
,MF=(L, <i>list addr</i> , <i>attr</i>)	
,MF=(L, <i>list addr</i> , <u>0D</u>)	

Syntax	Description
,MF=(E, <i>list addr</i>)	
,MF=(E, <i>list addr</i> , <u>COMPLETE</u>)	

Parameters

The parameters are explained as follows:

name

An optional symbol, starting in column 1, that is the name on the IARV64 macro invocation. The name must conform to the rules for an ordinary assembler language symbol.

REQUEST=DISCARDATA

A required parameter. REQUEST=DISCARDATA discards the data within the specified ranges.

Areas of the memory object that are PAGEFIXed, or are guard areas in the address space identified by the input ALET will not be discarded. If the DISCARDATA service finds a PAGEFIXed area or guard area in the area to be discarded, the caller will be abnormally ended. However, any prior pages processed will have data in an indeterminate state when CLEAR=NO is used, and KEEPREAL=YES is also used or set as the default.

The caller must be in supervisor state or have PSW key 0-7 or have a PSW key that matches the storage key of the memory object to be cleared.

,KEEPREAL=YES

,KEEPREAL=NO

An optional parameter that specifies whether the real frames backing the pages to be discarded are to be freed or not. The default is KEEPREAL=YES.

,KEEPREAL=YES

The real frames backing the pages to be discarded are not to be freed unless there is shortage in real storage.

,KEEPREAL=NO

The real frames backing the pages to be discarded are to be freed. In this case, the CLEAR keyword value is ignored.

,CLEAR=YES

,CLEAR=NO

An optional parameter that specifies whether the data in the range should become binary zeros. The default is CLEAR=YES.

,CLEAR=YES

The data will become binary zeros.

,CLEAR=NO

The data will be indeterminate.

,RANGLIST=*ranglist*

A required input parameter, of a range list. The range list consists of a number of entries (as specified by NUMRANGE) where each entry is 16 bytes long. A description of the fields in each entry is as follows:

VSA

denotes the starting address of the data to be acted on.

The address specified must be within a created memory object returned by GETSTOR

The value provided must always be on a physical page boundary.

The length of this field is 8 bytes.

NUMPAGES

contains the number of physical pages in the area.

The number of pages specified starting with the specified VSA must lie within the memory object.

The length of this field is 8 bytes.

To code: Specify the RS-type address, or address in register (2)-(12), of an eight-byte pointer field.

,NUMRANGE=numrange**,NUMRANGE=1**

An optional input parameter that specifies the number of entries in the supplied range list.

The value specified must be no greater than 16. The default is 1.

To code: Specify the RS-type address, or address in register (2)-(12), of a fullword field.

,RETCODE=retcode

An optional output parameter into which the return code is to be copied from GPR 15.

To code: Specify the RS-type address of a fullword field, or register (2)-(12).

,RSNCODE=rsncode

An optional output parameter into which the reason code is to be copied from GPR 0.

To code: Specify the RS-type address of a fullword field, or register (2)-(12).

,PLISTVER=IMPLIED_VERSION**,PLISTVER=MAX****,PLISTVER=0, 1**

An optional input parameter that specifies the version of the macro. PLISTVER determines which parameter list the system generates. PLISTVER is an optional input parameter on all forms of the macro, including the list form. When using PLISTVER, specify it on all macro forms used for a request and with the same value on all of the macro forms. The values are:

- **IMPLIED_VERSION**, which is the lowest version that allows all parameters specified on the request to be processed. If you omit the PLISTVER parameter, IMPLIED_VERSION is the default.
- **MAX**, if you want the parameter list to be the largest size currently possible. This size might grow from release to release and affect the amount of storage that your program needs.

If you can tolerate the size change, IBM recommends that you always specify PLISTVER=MAX on the list form of the macro. Specifying MAX ensures that the list-form parameter list is always long enough to hold all the parameters you might specify on the execute form, when both are assembled with the same level of the system. In this way, MAX ensures that the parameter list does not overwrite nearby storage.

- **0**, if you use the currently available parameters.
- **1**, supports both the following parameters and parameters from version 0:
 - CONVERTSIZE64
 - CONVERTSTART
 - GUARDSIZE64

To code: Specify one of the following:

- IMPLIED_VERSION
- MAX
- A decimal value of 0 or 1

,MF=S
,MF=(L,list addr)
,MF=(L,list addr,attr)
,MF=(L,list addr,OD)
,MF=(E,list addr)
,MF=(E,list addr,COMPLETE)

An optional input parameter that specifies the macro form.

Use MF=S to specify the standard form of the macro, which builds an inline parameter list and generates the macro invocation to transfer control to the service. MF=S is the default.

Use MF=L to specify the list form of the macro. Use the list form together with the execute form of the macro for applications that require reentrant code. The list form defines an area of storage that the execute form uses to store the parameters. Only the PLISTVER parameter may be coded with the list form of the macro.

Use MF=E to specify the execute form of the macro. Use the execute form together with the list form of the macro for applications that require reentrant code. The execute form of the macro stores the parameters into the storage area defined by the list form, and generates the macro invocation to transfer control to the service.

,list addr

The name of a storage area to contain the parameters. For MF=S and MF=E, this can be an RS-type address or an address in register (1)-(12).

,attr

An optional 1- to 60-character input string that you use to force boundary alignment of the parameter list. Use a value of 0F to force the parameter list to a word boundary, or 0D to force the parameter list to a doubleword boundary. If you do not code *attr*, the system provides a value of 0D.

,COMPLETE

Specifies that the system is to check for required parameters and supply defaults for omitted optional parameters.

REQUEST=PAGEIN option of IARV64

REQUEST=PAGEIN notifies the system that data within physical pages of one or more memory objects are needed in the near future.

Environment

The requirements for the caller are:

Environmental factor	Requirement
Minimum authorization:	Problem state and PSW key 8-15.
Dispatchable unit mode:	Task or SRB
Cross memory mode:	Any PASN, any HASN, any SASN
AMODE:	31- or 64-bit
ASC mode:	Primary or access register (AR)
Interrupt status:	Enabled for I/O and external interrupts
Locks:	No locks may be held.
Control parameters:	Control parameters must be in the primary address space.

Programming requirements

None.

Restrictions

No data space ALETs can be specified.

Input register information

Before issuing the IARV64 macro, the caller does not have to place any information into any register unless using it in register notation for a particular parameter, or using it as a base register.

Output register information

When control returns to the caller, the GPRs contain:

Register

Contents

0

Reason code, if GPR 15 is non-zero

1

Used as a work register by the system

2-13

Unchanged

14

Used as a work register by the system

15

Return code

When control returns to the caller, the ARs contain:

Register

Contents

0-1

Used as work registers by the system

2-13

Unchanged

14-15

Used as work registers by the system

Some callers depend on register contents remaining the same before and after issuing a service. If the system changes the contents of registers on which the caller depends, the caller must save them before issuing the service, and restore them after the system returns control.

Performance implications

None

Syntax

The REQUEST=PAGEIN option of the IARV64 macro is written as follows:

Syntax	Description
<i>name</i>	<i>name</i> : symbol. Begin <i>name</i> in column 1.
␣	One or more blanks must precede IARV64.

Syntax	Description
IARV64	
b	One or more blanks must follow IARV64.
REQUEST=PAGEIN	
,RANGLIST= <i>ranglist</i>	<i>ranglist</i> : RS-type address or address in register (2) - (12).
,NUMRANGE= <i>numrange</i>	<i>numrange</i> : RS-type address or address in register (2) - (12).
,NUMRANGE= <u>1</u>	Default: NUMRANGE=1
,RETCODE= <i>retcode</i>	<i>retcode</i> : RS-type address or register (2) - (12).
,RSNCODE= <i>rsncode</i>	<i>rsncode</i> : RS-type address or register (2) - (12).
,PLISTVER= <u>IMPLIED_VERSION</u>	Default: PLISTVER=IMPLIED_VERSION
,PLISTVER=MAX	
,PLISTVER=0, 1	
,MF= <u>S</u>	Default: MF=S
,MF=(L, <i>list addr</i>)	<i>list addr</i> : RS-type address or register (1) - (12).
,MF=(L, <i>list addr,attr</i>)	
,MF=(L, <i>list addr,0D</i>)	
,MF=(E, <i>list addr</i>)	
,MF=(E, <i>list addr,COMPLETE</i>)	

Parameters

The parameters are explained as follows:

name

An optional symbol, starting in column 1, that is the name on the IARV64 macro invocation. The name must conform to the rules for an ordinary assembler language symbol.

REQUEST=PAGEIN

A required parameter. REQUEST=PAGEIN notifies the system that data within the specified ranges is needed in the near future and should be, if possible, retrieved from auxiliary storage. An attempt to PAGEIN a range which contains a guard area will cause an ABEND.

The caller must be in supervisor state OR system (0-7) PSW key OR be in a PSW key which matches the key of the memory object storage to be paged out.

,RANGLIST=*ranglist*

A required input parameter, of a range list. The range list consists of a number of entries (as specified by NUMRANGE) where each entry is 16 bytes long. A description of the fields in each entry is as follows:

VSA

denotes the starting virtual address of the data to be acted on.

The virtual address specified must be within an allocated memory object returned by GETSTOR

It must always be on a physical page boundary.

The length of this field is 8 bytes.

NUMPAGES

contains the number of physical pages in the area.

The number of pages specified starting with the specified VSA must lie within a single memory object.

The length of this field is 8 bytes.

To code: Specify the RS-type address, or address in register (2)-(12), of an eight-byte pointer field.

,NUMRANGE=*numrange***,NUMRANGE=1**

An optional input parameter that specifies the number of entries in the supplied range list.

The value specified must be no greater than 16. The default is 1.

To code: Specify the RS-type address, or address in register (2)-(12), of a fullword field.

,RETCODE=*retcode*

An optional output parameter into which the return code is to be copied from GPR 15.

To code: Specify the RS-type address of a fullword field, or register (2)-(12).

,RSNCODE=*rsncode*

An optional output parameter into which the reason code is to be copied from GPR 0.

To code: Specify the RS-type address of a fullword field, or register (2)-(12).

,PLISTVER=IMPLIED_VERSION**,PLISTVER=MAX****,PLISTVER=0, 1**

An optional input parameter that specifies the version of the macro. PLISTVER determines which parameter list the system generates. PLISTVER is an optional input parameter on all forms of the macro, including the list form. When using PLISTVER, specify it on all macro forms used for a request and with the same value on all of the macro forms. The values are:

- **IMPLIED_VERSION**, which is the lowest version that allows all parameters specified on the request to be processed. If you omit the PLISTVER parameter, IMPLIED_VERSION is the default.
- **MAX**, if you want the parameter list to be the largest size currently possible. This size might grow from release to release and affect the amount of storage that your program needs.

If you can tolerate the size change, IBM recommends that you always specify PLISTVER=MAX on the list form of the macro. Specifying MAX ensures that the list-form parameter list is always long enough to hold all the parameters you might specify on the execute form, when both are assembled with the same level of the system. In this way, MAX ensures that the parameter list does not overwrite nearby storage.

- **0**, if you use the currently available parameters.
- **1**, supports both the following parameters and parameters from version 0:
 - CONVERTSIZE64
 - CONVERTSTART

– GUARDSIZE64

To code: Specify one of the following:

- IMPLIED_VERSION
- MAX
- A decimal value of 0 or 1

,MF=S

,MF=(L,*list addr*)

,MF=(L,*list addr*,*attr*)

,MF=(L,*list addr*,*OD*)

,MF=(E,*list addr*)

,MF=(E,*list addr*,COMPLETE**)**

An optional input parameter that specifies the macro form.

Use MF=S to specify the standard form of the macro, which builds an inline parameter list and generates the macro invocation to transfer control to the service. MF=S is the default.

Use MF=L to specify the list form of the macro. Use the list form together with the execute form of the macro for applications that require reentrant code. The list form defines an area of storage that the execute form uses to store the parameters. Only the PLISTVER parameter may be coded with the list form of the macro.

Use MF=E to specify the execute form of the macro. Use the execute form together with the list form of the macro for applications that require reentrant code. The execute form of the macro stores the parameters into the storage area defined by the list form, and generates the macro invocation to transfer control to the service.

,*list addr*

The name of a storage area to contain the parameters. For MF=S and MF=E, this can be an RS-type address or an address in register (1)-(12).

,*attr*

An optional 1- to 60-character input string that you use to force boundary alignment of the parameter list. Use a value of 0F to force the parameter list to a word boundary, or 0D to force the parameter list to a doubleword boundary. If you do not code *attr*, the system provides a value of 0D.

,COMPLETE****

Specifies that the system is to check for required parameters and supply defaults for omitted optional parameters.

REQUEST=PAGEOUT option of IARV64

REQUEST=PAGEOUT notifies the system that data within physical pages of one or more memory objects will not be used in the near future.

Environment

The requirements for the caller are:

Environmental factor	Requirement
Minimum authorization:	Problem state and PSW key 8-15.
Dispatchable unit mode:	Task or SRB
Cross memory mode:	Any PASN, any HASN, any SASN
AMODE:	31- or 64-bit
ASC mode:	Primary or access register (AR)
Interrupt status:	Enabled for I/O and external interrupts

IARV64 macro

Environmental factor

Locks:

Control parameters:

Requirement

No locks may be held.

Control parameters must be in the primary address space and can reside both below and above the bar.

Programming requirements

None.

Restrictions

No data space ALETs can be specified.

Input register information

Before issuing the IARV64 macro, the caller does not have to place any information into any register unless using it in register notation for a particular parameter, or using it as a base register.

Output register information

When control returns to the caller, the GPRs contain:

Register

Contents

0

Reason code, if GPR 15 is non-zero

1

Used as a work register by the system

2-13

Unchanged

14

Used as a work register by the system

15

Return code

When control returns to the caller, the ARs contain:

Register

Contents

0-1

Used as work registers by the system

2-13

Unchanged

14-15

Used as work registers by the system

Some callers depend on register contents remaining the same before and after issuing a service. If the system changes the contents of registers on which the caller depends, the caller must save them before issuing the service, and restore them after the system returns control.

Performance implications

None

Syntax

The REQUEST=PAGEOUT option of the IARV64 macro is written as follows:

Syntax	Description
<i>name</i>	<i>name</i> : symbol. Begin <i>name</i> in column 1.
␣	One or more blanks must precede IARV64.
IARV64	
␣	One or more blanks must follow IARV64.
REQUEST=PAGEOUT	
,RANGLIST= <i>ranglist</i>	<i>ranglist</i> : RS-type address or address in register (2) - (12).
,NUMRANGE= <i>numrange</i>	<i>numrange</i> : RS-type address or address in register (2) - (12).
,NUMRANGE= <u>1</u>	Default: NUMRANGE=1
,RETCODE= <i>retcode</i>	<i>retcode</i> : RS-type address or register (2) - (12).
,RSNCODE= <i>rsncode</i>	<i>rsncode</i> : RS-type address or register (2) - (12).
,PLISTVER= <u>IMPLIED_VERSION</u>	Default: PLISTVER=IMPLIED_VERSION
,PLISTVER=MAX	
,PLISTVER=0, 1	
,MF= <u>S</u>	Default: MF=S
,MF=(L, <i>list addr</i>)	<i>list addr</i> : RS-type address or register (1) - (12)
,MF=(L, <i>list addr</i> , <i>attr</i>)	
,MF=(L, <i>list addr</i> , <u>0D</u>)	
,MF=(E, <i>list addr</i>)	
,MF=(E, <i>list addr</i> , <u>COMPLETE</u>)	

Parameters

The parameters are explained as follows:

name

An optional symbol, starting in column 1, that is the name on the IARV64 macro invocation. The name must conform to the rules for an ordinary assembler language symbol.

REQUEST=PAGEOUT

A required parameter. REQUEST=PAGEOUT Notifies the system that data within the specified ranges will not be used in the near future, i.e. for time measured in seconds (or longer), and hence are good candidates for paging.

Areas of the memory object that are PAGEFIXed or are in guard areas will not be affected.

,RANGLIST=*ranglist*

A required input parameter. The range list consists of a number of entries (as specified by NUMRANGE) where each entry is 16 bytes long. A description of the fields in each entry is as follows:

VSA

denotes the starting address of the data to be acted on.

The address specified must be within a created memory object returned by GETSTOR

The value provided must always be on a physical page boundary.

The length of this field is 8 bytes.

NUMPAGES

contains the number of physical pages in the area.

The number of pages specified starting with the specified VSA must lie within a single memory object.

The length of this field is 8 bytes.

To code: Specify the RS-type address, or address in register (2)-(12), of an eight-byte pointer field.

,NUMRANGE=*numrange***,NUMRANGE=1**

An optional input parameter that specifies the number of entries in the supplied range list.

The value specified must be no greater than 16. The default is 1.

To code: Specify the RS-type address, or address in register (2)-(12), of a fullword field.

,RETCODE=*retcode*

An optional output parameter into which the return code is to be copied from GPR 15.

To code: Specify the RS-type address of a fullword field, or register (2)-(12).

,RSNCODE=*rsncode*

An optional output parameter into which the reason code is to be copied from GPR 0.

To code: Specify the RS-type address of a fullword field, or register (2)-(12).

,PLISTVER=IMPLIED_VERSION**,PLISTVER=MAX****,PLISTVER=0, 1**

An optional input parameter that specifies the version of the macro. PLISTVER determines which parameter list the system generates. PLISTVER is an optional input parameter on all forms of the macro, including the list form. When using PLISTVER, specify it on all macro forms used for a request and with the same value on all of the macro forms. The values are:

- **IMPLIED_VERSION**, which is the lowest version that allows all parameters specified on the request to be processed. If you omit the PLISTVER parameter, IMPLIED_VERSION is the default.
- **MAX**, if you want the parameter list to be the largest size currently possible. This size might grow from release to release and affect the amount of storage that your program needs.

If you can tolerate the size change, IBM recommends that you always specify PLISTVER=MAX on the list form of the macro. Specifying MAX ensures that the list-form parameter list is always long enough to hold all the parameters you might specify on the execute form, when both are assembled

with the same level of the system. In this way, MAX ensures that the parameter list does not overwrite nearby storage.

- **0**, if you use the currently available parameters.
- **1**, supports both the following parameters and parameters from version 0:
 - CONVERTSIZE64
 - CONVERTSTART
 - GUARDSIZE64

To code: Specify one of the following:

- IMPLIED_VERSION
- MAX
- A decimal value of 0 or 1

,MF=S

,MF=(L,list addr)

,MF=(L,list addr,attr)

,MF=(L,list addr,0D)

,MF=(E,list addr)

,MF=(E,list addr,COMPLETE)

An optional input parameter that specifies the macro form.

Use MF=S to specify the standard form of the macro, which builds an inline parameter list and generates the macro invocation to transfer control to the service. MF=S is the default.

Use MF=L to specify the list form of the macro. Use the list form together with the execute form of the macro for applications that require reentrant code. The list form defines an area of storage that the execute form uses to store the parameters. Only the PLISTVER parameter may be coded with the list form of the macro.

Use MF=E to specify the execute form of the macro. Use the execute form together with the list form of the macro for applications that require reentrant code. The execute form of the macro stores the parameters into the storage area defined by the list form, and generates the macro invocation to transfer control to the service.

,list addr

The name of a storage area to contain the parameters. For MF=S and MF=E, this can be an RS-type address or an address in register (1)-(12).

,attr

An optional 1- to 60-character input string that you use to force boundary alignment of the parameter list. Use a value of 0F to force the parameter list to a word boundary, or 0D to force the parameter list to a doubleword boundary. If you do not code *attr*, the system provides a value of 0D.

,COMPLETE

Specifies that the system is to check for required parameters and supply defaults for omitted optional parameters.

Chapter 7. IDENTIFY – Add an entry name

Description

The IDENTIFY macro is used to add an entry name to a copy of a load module currently in virtual storage. The copy must be one of the following:

- A copy that satisfied the requirements of a LOAD macro issued during the execution of the current task.
- The last load module given control, if control was passed to the load module using a LINK, LINKX, ATTACH, ATTACHX, XCTL, or XCTLX macro.

Note: The IDENTIFY macro may not be issued by an asynchronous exit routine. The IDENTIFY macro assigns the identified entry point as reentrant. Callers issuing this macro should be sure that their programs have been marked as reenterable.

The IDENTIFY service sets the addressing mode of the entry name that was added equal to the addressing mode of the major entry name. The system assigns the major entry name according to how the load module was constructed.

- If the load module was constructed using the linkage editor (and brought into virtual storage via program fetch or virtual fetch, the major entry name is the name of the load module in the partitioned data set directory (not an alias to that member).
- If the load module was brought into storage by the loader, the major entry name is either the name that the user provided as input to the loader or the name that the loader used as a default.

If an authorized caller creates an entry name for a module in the link pack area, the IDENTIFY service places an entry for the alias on the active link pack area queue. If an unauthorized caller creates an entry name for a module in the link pack area, the IDENTIFY service places an entry for the alias on the task's job pack queue.

If an unauthorized caller creates an entry name for an authorized module, the IDENTIFY service marks the new entry as unauthorized. In all other cases, the new entry name receives the same level of authorization as the main entry point.

The caller cannot have an EUT FRR established.

Syntax

The IDENTIFY macro is written as follows:

Syntax	Description
<i>name</i>	<i>name</i> : Symbol. Begin <i>name</i> in column 1.
␣	One or more blanks must precede IDENTIFY.
IDENTIFY	
␣	One or more blanks must follow IDENTIFY.
EP= <i>entry name</i>	<i>entry name</i> : Symbol

IDENTIFY macro

Syntax	Description
EPLOC= <i>entry name addr</i>	<i>entry name addr</i> : RX-type address, or register (0) or (2) - (12).
,ENTRY= <i>entry addr added</i>	<i>entry addr added</i> : RX-type address, or register (1) or (2) - (12).
,ENTRY64= <i>entry addr added</i>	<i>entry addr added</i> : RX-type address, or register (1) or (2) - (12).

Parameters

The parameters are explained as follows:

EP=*entry name*

EPLOC=*entry name addr*

Specifies the entry name or address of the entry name. The name does not have to correspond to any symbol or name in the load module, and must not correspond to any name, alias, or added entry name for a load module in the link pack area queue, or the job pack area of the job step. If EPLOC is coded, the name must be padded to eight bytes, if necessary.

,ENTRY=*entry addr added*

Specifies the virtual storage address of the entry point being added. If the program that issues the IDENTIFY macro is running in 24-bit addressing mode, the value for *entry addr added* must be a 24-bit address.

Note: If bit 31 of the entry point address is on, the system will turn it off.

,ENTRY64=*entry addr added*

Specifies the virtual storage address of the entry point being added. Use this when the virtual storage address is greater than 2G.

Return codes

When control is returned, register 15 contains one of the following return codes:

Hexadecimal Return Code	Meaning
00	Successful completion of requested function.
04	Entry name and address already exist.
08	Entry name duplicates the major name of a load module currently in virtual storage; entry address was not added.
0C	Entry address is not within an eligible load module; entry address was not added.
10	Request issued by an asynchronous exit routine; entry address was not added.
14	Entry name duplicates the name already used for a minor entry or for an entry created by another IDENTIFY request, and the entry point addresses are different; the current request is rejected.
18-1C	An internal error occurred. Record the return code and contact the appropriate IBM support personnel.
24	An unexpected error occurred.
28	The address specified by the EPLOC parameter was fetch protected.
2C	An internal error occurred. Record the return code and contact the appropriate IBM support personnel.

Hexadecimal Return Code	Meaning
30	Unsuccessful processing due to a system queue area (SQA) storage shortage.
34	Unsuccessful processing due to a local system queue area (LSQA) storage shortage.
38	Unsuccessful processing due an error in the job pack area. Record the return code and contact the appropriate IBM support personnel.

Example

Add an entry name (PGMTAL2A) to a load module in virtual storage. Register 3 contains the entry point address.

```
IDENTIFY    EP=PGMTAL2A, ENTRY=(R3)
```

Chapter 8. IEAARR – Establish an associated recovery routine (ARR)

Description

IEAARR allows you to request that the system establish an associated recovery routine (ARR) while calling a target routine. In this case, the system performs the stacking PC instruction, then give control to your routine (the target routine). When the target routine returns control, the system issues the corresponding PR instruction. Asynchronous exist processing will be prohibited while the ARR is running.

Environment

The requirements for the caller are:

Environmental factor	Requirement
Minimum authorization:	Problem state and PSW key 8-15
Dispatchable unit mode:	Task
Cross memory mode:	Any PASN, any HASN, any SASN
AMODE:	31-bit or 64-bit
ASC mode:	Primary or access register (AR)
Interrupt status:	Enabled or disabled for I/O and external interrupts
Locks:	The caller is not required to hold any locks on entry. The caller may hold the local, CMS, or CPU lock.
Control parameters:	None.

Programming requirements

The caller must include the IHAECVT mapping macro.

Restrictions

IEAARR must not be issued while a functional recovery routine (FRR) is established.

TARGETSTATE=PROB should only be issued by a caller currently running in problem state.

TARGETSTATE=SUP should only be issued by a caller currently running in supervisor state.

Input register information

Before issuing the IEAARR macro, the caller does not have to place any information into any general purpose register (GPR) or access register (AR) unless using it in register notation for a particular parameter, or using it as a base register.

Output register information

When control returns to the caller, the GPRs contain:

Register
Contents

0

The value placed in register 0 by the target routine prior to its returning to the system.

IEAARR macro

1

The value placed in register 1 by the target routine prior to its returning to the system.

2-13

Unchanged

14

Used as a work register by the system

15

The value placed in register 15 by the target routine prior to its returning to the system.

When control returns to the caller, the ARs contain:

Register

Contents

0

The value placed in access register 0 by the target routine prior to its returning to the system.

1

The value placed in access register 1 by the target routine prior to its returning to the system.

2-13

Unchanged

14

Used as a work register by the system

15

The value placed in access register 15 by the target routine prior to its returning to the system.

Some callers depend on register contents remaining the same before and after issuing a service. If the system changes the contents of registers on which the caller depends, the caller must save them before issuing the service, and restore them after the system returns control.

Performance implications

None.

Syntax

The IEAARR macro is written as follows:

Syntax	Description
<i>name</i>	<i>name</i> : symbol. Begin <i>name</i> in column 1.
␣	One or more blanks must precede IEAARR.
IEAARR	
␣	One or more blanks must follow IEAARR.
ARRPTR= <i>arrptr</i>	<i>arrptr</i> : RX-type address or address in register (2) - (12).
ARR= <i>arr</i>	<i>arr</i> : RX-type address or address in register (2) - (12).
,DYNSTORAGE= <u>AVAIL</u>	Default: DYNSTORAGE=AVAIL

Syntax	Description
,DYNSTORAGE=NOTAVAIL	
,ARRPARAMPTR= <i>arrparamptr</i>	<i>arrparamptr</i> : RX-type address or address in register (2) - (12).
,ARRPARAMPTR64= <i>arrparamptr64</i>	<i>arrparamptr64</i> : RX-type address or address in register (2)-(12), of a 64-bit pointer field.
,ARRPARAM= <i>arrparamp</i>	<i>arrparamp</i> : RX-type address or address in register (2) - (12).
,ARRPARAM64= <i>arrparam64</i>	<i>arrparam64</i> : RX-type address or address in register (2) - (12).
,PARAMPTR= <i>paramptr</i>	<i>paramptr</i> : RX-type address or address in register (2) - (12).
,PARAMPTR64= <i>paramptr64</i>	<i>paramptr64</i> : RX-type address or address in register (2)-(12), of a 64-bit pointer field.
,PARAM= <i>param</i>	<i>param</i> : RX-type address or address in register (2) - (12).
,PARAM64= <i>param64</i>	<i>param64</i> : RX-type address or address in register (2) - (12).
,TARGETPTR= <i>targetptr</i>	<i>targetptr</i> : RX-type address or address in register (2) - (12).
,TARGET= <i>target</i>	<i>target</i> : RX-type address or address in register (2) - (12).
,TARGETSTATE=PROB	
,TARGETSTATE=SUP	
,ASYNCH=NO	Default: ASYNCH=NO
,ASYNCH=YES	

Parameters

The parameters are explained as follows:

name

An optional symbol, starting in column 1, that is the name on the IEAARR macro invocation. The name must conform to the rules for an ordinary assembler language symbol.

DYNSTORAGE=AVAIL

DYNSTORAGE=NOTAVAIL

An optional parameter that indicates whether this routine is sensitive to your having dynamic storage. The default is DYNSTORAGE=AVAIL.

DYNSTORAGE=AVAIL

Indicates that you have dynamic storage available.

DYNSTORAGE=NOTAVAIL

Indicates that you do not have dynamic storage available. The parameters are defined so that you can place each parameter value in a register and in so doing avoid the need to place parameter values into dynamic storage.

ARRPTR=arrptr

When DYNSTORAGE=AVAIL is in effect, a required input parameter that contains the address of the associated recovery routine. This routine gets control from RTM according to normal z/OS recovery protocols. As it is an ARR, it will get control in AMODE 31.

To code: Specify the RX-type address, or address in register (2)-(12), of a pointer field.

ARR=arr

When DYNSTORAGE=NOTAVAIL is specified, a required input parameter that is the associated recovery routine. This routine gets control from RTM according to normal z/OS recovery protocols. As it is an ARR, it will get control in AMODE 31.

To code: Specify the RX-type address, or address in register (2)-(12), of the associated recovery routine.

,ARRPARAMPTR=arrparamptr

When DYNSTORAGE=AVAIL is in effect and SYSSTATE AMODE64=YES is not in effect, a required input parameter that contains the address of the parameter area that is to be passed to the ARR upon error. The address is placed in the first four bytes of the area pointed to by SDWAPARM and in GPR 2. Note that the second four bytes of the area pointed to by SDWAPARM will not contain interface information.

To code: Specify the RX-type address, or address in register (2)-(12), of a pointer field.

,ARRPARAM=arrparam

When DYNSTORAGE=NOTAVAIL is specified and SYSSTATE AMODE64=YES is not in effect, a required input parameter that is the parameter area that is to be passed to the ARR upon error. The address is placed in the first four bytes of the area pointed to by SDWAPARM and in GPR 2. Note that the second four bytes of the area pointed to by SDWAPARM will not contain interface information.

To code: Specify the RX-type address, or address in register (2)-(12), of the parameter area.

,ARRPARAMPTR64=arrparamptr64

When DYNSTORAGE=AVAIL is in effect and SYSSTATE AMODE64=YES is in effect, a required 8-byte input parameter that contains the address of the parameter area that is to be passed to the ARR upon error. The address is placed in the 8-byte area pointed by SDWAPARM and in the 64-bit GPR 2.

To code: Specify the RX-type address, or address in register (2)-(12), of a 64-bit pointer field.

,ARRPARAM64=arrparam64

When DYNSTORAGE=NOTAVAIL is specified and SYSSTATE AMODE64=YES is in effect, a required 8-byte input parameter that is the parameter area that is to be passed to the ARR upon error. The address is placed in the 8-byte area pointed by SDWAPARM and in the 64-bit GPR 2.

To code: Specify the RX-type address, or address in register (2)-(12), of the parameter area.

,PARAMPTR=paramptr

When DYNSTORAGE=AVAIL is in effect and SYSSTATE AMODE64=YES is not in effect, a required input parameter that contains the address of a parameter that is to be passed to the target routine in GPR 1.

To code: Specify the RX-type address, or address in register (2)-(12), of a pointer field.

,PARAM=param

When DYNSTORAGE=NOTAVAIL is specified and SYSSTATE AMODE64=YES is not in effect, a required input parameter that is the parameter that is to be passed to the target routine in GPR 1.

To code: Specify the RX-type address, or address in register (2)-(12), of the parameter.

,PARAMPTR64=paramptr64

When DYNSTORAGE=AVAIL is in effect and SYSSTATE AMODE64=YES is in effect, a required 8-byte input parameter that contains the address of the parameter that is to be passed to the target routine in 64-bit GPR 1.

To code: Specify the RX-type address, or address in register (2)-(12), of a 64-bit pointer field.

,PARAM64=param64

When DYNSTORAGE=NOTAVAIL is specified and SYSSTATE AMODE64=YES is in effect, a required 8-byte input parameter that is to be passed to the target routine in 64-bit GPR 1.

To code: Specify the RX-type address, or address in register (2)-(12), of the parameter.

,TARGETPTR=*targetptr*

When DYNSTORAGE=AVAIL is in effect, a required input parameter that contains the address of the routine to which the system is to branch after establishing the ARR. The target routine will get control in the same key and state as the IEAARR caller, in AMODE 31, with the following input registers:

General Purpose Registers:

**Register
Contents**

0	Not part of the intended interface
1	Address of parameter area provided by IEAARR caller
2-13	Unchanged from the IEAARR caller
14	The return address
15	The address of the target routine

Access Registers:

**Register
Contents**

0-1	Not part of the intended interface
2-13	Unchanged from the IEAARR caller
14	Not part of the intended interface
15	Not part of the intended interface

The target routine gets control with one more entry on the linkage stack than existed when IEAARR was called. That linkage stack entry contains the caller's registers 2-13 which can be extracted using the EREG instruction if needed.

The target routine need not save any registers, but is expected to return to the address provided in GPR 14 on entry. The target routine can pass information back to the caller of IEAARR by placing it in GPR/AR 0, 1, and/or 15. The IEAARR caller will resume immediately after the IEAARR macro expansion.

The target routine gets control with its primary and secondary ASNs, which are both the same as the primary ASN when IEAARR was invoked.

To code: Specify the RX-type address, or address in register (2)-(12), of a pointer field.

,TARGET=*target*

When DYNSTORAGE=NOTAVAIL is specified, a required input parameter that is the routine to which the system is to branch after establishing the ARR. The target routine interface is identical to that described under the TARGETPTR parameter.

To code: Specify the RX-type address, or address in register (2)-(12), of the target routine.

,TARGETSTATE=PROB

,TARGETSTATE=SUP

A required parameter that indicates the requested PSW state of the target routine.

,TARGETSTATE=PROB

Indicates that the target routine is to get control in problem state. This should only be used by a caller currently in problem state.

,TARGETSTATE=SUP

Indicates that the target routine is to get control in supervisor state. This should only be used by a caller currently in supervisor state.

,ASYNCH=NO**,ASYNCH=YES**

An optional parameter that identifies the ASYNCH attribute for the ARR. The definition of the ASYNCH attribute can be found in [ESTAE](#) and [ESTAEX](#) in *z/OS MVS Programming: Assembler Services Reference ABE-HSP*. The default is ASYNCH=NO.

,ASYNCH=NO

Indicates that the ARR is to have the ASYNCH=NO attribute.

,ASYNCH=YES

Indicates that the ARR is to have the ASYNCH=YES attribute.

ABEND codes

The caller may get the following abend code:

0C2-02

TARGETSTATE=SUP was requested by a caller currently running in problem state.

Return codes

None.

Example

Branch to the target routine pointed to by field TP, and establish as an ARR the routine pointed to by field AP. Pass to the target area in register 1 the contents of field PP. Make sure that the ARR will get access to the contents of field APP (which ordinarily would contain the address of a parameter area). Make sure that the target routine gets control in problem state (which implies that the caller of IEARR should currently be running in problem state).

The code is as follows.

```
IEAARR TARGETPTR=TP,ARRPTR=AP,PARAMPTR=PP,
      ARRPARAMPTR=APP,TARGETSTATE=PROB
      ...
```

Chapter 9. IEABRC – Relative branch macro

Description

The IEABRC macro defines macros to intercept and change various base-displacement branch instructions to their relative branch equivalents. Many macros contain base-displacement branches that could functionally be relative branches. In order to write an assembler routine that both uses these macros and uses relative branching, you can use IEABRC to enable those macros to use relative branches. Changing base-displacement branch instructions to their relative branch equivalents can eliminate code addressability issues.

Note: Using IEABRC does not guarantee that all macros can be invoked without code addressability. Some macros still require addressability to the location where the macro is invoked.

Environment

Because IEABRC is not an executable macro, there are no specific environment requirements.

Programming requirements

None.

Restrictions

IEABRC converts branch condition instructions to relative branch condition instructions except when both of the following conditions are true:

- The branch target ends with ")"
- A "(" in the 2nd or subsequent characters of the branch target is not preceded by "+" or "-"

For example:

B X(15)

Remains a base/displacement branch

B X+(15)

Converted to a relative branch

B X+Y

Converted to a relative branch

Register information

Because IEABRC is not an executable macro, there is no need to save and restore register contents.

Performance implications

None.

Syntax

The IEABRC macro is written prior to any base/displacement branch that needs to be converted to a relative branch as follows:

Syntax	Description

Syntax	Description
‡	One or more blanks must precede COPY.
COPY IEABRC	
‡	One or more blanks must follow IEABRC.

Parameters

IEABRC has no parameters of its own.

Example

The following example converts a base/displacement branch to a relative branch:

```

TEST      CSECT
R12       EQU    12
          USING  STATICAREA, R12
          COPY   IEABRC
          ENQ    (QNAME, RNAME, E, RNAMELEN, SYSTEM)
STATICAREA DC  D'0'
QNAME     DC    CL8'THEQNAME'
RNAME     DC    CL8'THERNAME'
RNAMELEN  EQU   L'RNAME
          END    TEST

```

Chapter 10. IEABRCX – Relative branch macro extension

Description

The IEABRCX macro defines macros to intercept and change various base-displacement branch instructions to their relative branch equivalents. Many macros contain base-displacement branches that could functionally be relative branches. In order to write an assembler routine that both uses these macros and uses relative branching, you can use IEABRCX to enable those macros to use relative branches. Changing base-displacement branch instructions to their relative branch equivalents can eliminate code addressability issues.

Note:

1. Using IEABRCX does not guarantee that all macros can be invoked without code addressability. Some macros still require addressability to the location where the macro is invoked.
2. IBM recommends using IEABRCX instead of IEABRC because IEABRCX provides additional functionality. Using IEABRCX DEFINE is equivalent to using COPY IEABRC.

Environment

There are no specific environment requirements.

Programming requirements

None.

Restrictions

IEABRCX converts branch condition instructions to relative branch condition instructions except when both of the following conditions are true:

- The branch target ends with ")"
- A "(" in the 2nd or subsequent characters of the branch target is not preceded by "+" or "-"

For example:

B X(15)

Remains a base/displacement branch

B X+(15)

Converted to a relative branch

B X+Y

Converted to a relative branch

Register information

IEABRCX changes no registers, so there is no need to save and restore register contents.

Performance implications

None.

Syntax

The IEABRCX macro is written prior to any base/displacement branch that needs to be converted to a relative branch as follows:

Syntax	Description
	One or more blanks must precede IEABRCX.
IEABRCX	
	One or more blanks must follow IEABRCX.
DEFINE	
PUSH	
DISABLE	
ENABLE	
POP	

Parameters

The parameters are explained as follows:

DEFINE

Defines and enables the conversion. It must be placed prior to any base/displacement branch that needs to be converted to a relative branch. It must precede any uses of IEABRCX with other options. At the point of issuing IEABRCX DEFINE, the state of conversions is enabled.

PUSH

Saves the current state (enabled or disabled). At any point in the assembly, the number of PUSH's must not exceed the number of POP's by 255 or an assembler error might result. You must have issued IEABRCX DEFINE prior to this.

DISABLE

Disables the conversions so that subsequent base-displacement branches revert to their normal form. You must have issued IEABRCX DEFINE prior to this.

ENABLE

Enables the conversions so that subsequent base-displacement branches are converted. You must have issued IEABRCX DEFINE prior to this.

POP

Restores to the previous state. A corresponding PUSH must exist or an assembler error might result. You must have issued IEABRCX DEFINE prior to this.

Example

The following example enables conversion of a base/displacement branch to a relative branch, saves the current state, disables the conversion, then restores the previous state.

```

TEST    CSECT
R12     EQU    12
        USING STATICAREA,R12
        IEABRCX DEFINE
        ENQ    (QNAME,RNAME,E,RNAMELEN,SYSTEM)

```

```
IEABRCX PUSH      Save the current state
IEABRCX DISABLE  Disable conversion
-- base/displacement branches not converted
IEABRCX POP       Restore the previous state
ENQ (QNAME,RNAME2,E,RNAME2LEN,SYSTEM)
STATICAREA DC D'0'
QNAME DC CL8'THEQNAME'
RNAME DC CL8'THERNAME'
RNAMELEN EQU L'RNAME
RNAME2 DC CL9'THERNAME2'
RNAME2LEN EQU L'RNAME2
END TEST
```

Chapter 11. IEAFP – Floating point services

Description

IEAFP STOP allows you to request that, for your work unit, the system stop its status saving of the additional floating point status provided with the binary floating point architecture. This status consists of the additional floating point (AFP) registers (FPRs 1, 3, 5, 7-15) and the floating point control (FPC) register. It will also stop its saving of the vector register status.

You would typically use this service only when you are a server task which "subdispatches" unrelated units of work (for instance, CICS transactions). To avoid subsequent units of work being penalized by the floating point actions of previous units of work, the additional FP status saving function of the operating system can be turned off. When a unit of work actually begins to use FP, all appropriate status saving will be resumed.

IEAFP START allows you to request that, for your work unit, the system prepare for subsequent saving of vector register status. You would typically use this if your work unit is an SRB or (for a task) if your first usage of vector registers might be while disabled for I/O and external interrupts or while holding a lock other than the LOCAL lock.

IEAFP STOPVECTOR is similar to IEAFP STOP but affects only the vector register status saving. It leaves unchanged the floating point register status saving.

Environment

The requirements for the caller are:

Environmental factor	Requirement
Minimum authorization:	Problem state and PSW key 8 - 15.
Dispatchable unit mode:	Task or SRB.
Cross memory mode:	Any PASN, any HASN, any SASN.
AMODE:	31-bit.
ASC mode:	Primary or access register (AR).
Interrupt status:	Enabled or disabled for I/O and external interrupts.
Locks:	The caller is not required to hold any locks on entry. For STOP or STOPVECTOR, the caller may hold the local, CMS, or CPU lock. For START, the caller may hold the LOCAL lock (not a CML).
Control parameters:	None.

Programming requirements

The caller can include the IHAFPRET mapping macro to get equate symbols for the return and reason codes provided by the IEAFP macro.

Restrictions

IEAFP must not be issued from an asynchronous exit routine.

Input register information

Before issuing the IEAFP macro, the caller does not have to place any information into any general purpose register (GPR) or access register (AR) unless using it in register notation for a particular parameter, or using it as a base register.

Output register information

When control returns to the caller, the GPRs contain:

Register

Contents

0

Reason code, when GPR 15 is non-zero

1

Used as a work register by the system

2 - 13

Unchanged

14 - 15

Used as a work register by the system

15

Return code

When control returns to the caller, the ARs contain:

Register

Contents

0 - 1

Used as work registers by the system

2 - 13

Unchanged

14 - 15

Used as work registers by the system

Some callers depend on register contents remaining the same before and after issuing a service. If the system changes the contents of registers on which the caller depends, the caller must save them before issuing the service, and restore them after the system returns control.

Performance implications

None.

Syntax

The IEAFP macro is written as follows:

Syntax	Description
<i>name</i>	<i>name</i> : symbol. Begin <i>name</i> in column 1.
␣	One or more blanks must precede IEAFP.
IEAFP	

Syntax	Description
└	One or more blanks must follow IEAFP.
START	
STOP	
STOPVECTOR	
,RETCODE= <i>retcode</i>	<i>retcode</i> : RS-type address or register (2) - (12) or (15), (GPR15), (REG15), or (R15).
,RSNCODE= <i>rsncode</i>	<i>rsncode</i> : RS-type address or register (0) or (2) - (12), (00), (GPR0), (GPR00), (REG0), (REG00), or (R0).

Parameters

The parameters are explained as follows:

name

An optional symbol, starting in column 1, that is the name on the IEAFP macro invocation. The name must conform to the rules for an ordinary assembler language symbol.

START

STOP

STOPVECTOR

A required input parameter.

START

A parameter keyword that indicates to prepare for saving additional floating point status, and vector status. Resources will be allocated at this point so that initial use may occur with fewer restrictions.

To code: Specify a value.

STOP

A parameter keyword that indicates to stop saving additional floating point status and vector status until such time as a new operation requires it. Resources will not be freed until termination of the work unit, making re-starting faster.

To code: Specify a value.

STOPVECTOR

A parameter keyword that indicates to stop saving vector register status until such time as a new vector operation requires it. Saving of additional floating point status will continue.

To code: Specify a value.

,RETCODE=*retcode*

An optional output parameter into which the return code is to be copied from GPR 15. If you specify 15, GPR15, REG15, or R15 (within or without parentheses), the value will be left in GPR 15.

To code: Specify the RS-type address of a fullword field, or register (2) - (12) or (15), (GPR15), (REG15), or (R15).

,RSNCODE=rsncode

An optional output parameter into which the reason code is to be copied from GPR 0. If you specify 0, 00, GPR0, GPR00, REG0, REG00, or R0 (within or without parentheses), the value will be left in GPR 0.

To code: Specify the RS-type address of a fullword field, or register (0) or (2) - (12), (00), (GPR0), (GPR00), (REG0), (REG00), or (R0).

ABEND codes

None.

Return and reason codes

When the IEAFP macro returns control to your program:

- GPR 15 (and *retcode*, when you code RETCODE) contains a return code.
- When the value in GPR 15 is not zero, GPR 0 (and *rsncode*, when you code RSNCODE) contains a reason code.

Macro IHAFPRET provides equate symbols for the return and reason codes.

The following table identifies the hexadecimal return and reason codes and the equate symbol associated with each reason code. IBM support personnel may request the entire reason code, including the xxxx value.

Return code	Reason code	Equate symbol, meaning, and action
0	–	Equate symbol: IeafpRc_OK Meaning: IEAFP request successful. Action: None required.
8	–	Equate symbol: IeafpRc_InvParm Meaning: IEAFP request specifies parameters that are not valid. Action: Refer to the action provided with the specific reason code.
8	xxxx0801	Equate symbol: IeafpRsnBadFunction Meaning: Incorrect value passed to target routine. Action: Check for possible storage overlay.
C	–	Equate symbol: IeafpRc_Env Meaning: Environmental error Action: Refer to the action provided with the specific reason code.
C	xxxx0C01	Equate symbol: IeafpRsnFromAsynchExit Meaning: IEAFP was issued from an asynchronous exit routine. Action: Avoid issuing IEAFP from an asynchronous exit routine.
C	xxxx0C02	Equate symbol: IeafpRsnFromNonPreemptibleSRB Meaning: IEAFP START was issued from an SRB that was a non-preemptible SRB. Action: Avoid issuing IEAFP from a non-preemptible SRB.

Table 9. Return and reason codes for the IEAFP macro (continued)		
Return code	Reason code	Equate symbol, meaning, and action
C	xxxx0C03	<p>Equate symbol: IeafpRsnFromNotBITCB</p> <p>Meaning: IEAFP START was issued from a task that was not the jobstep program task nor a subtask of that task.</p> <p>Action: When using IEAFP START from a task, do so only from the jobstep program task or a subtask of that task.</p>
C	xxxx0C04	<p>Equate symbol: IeafpRsnLocked</p> <p>Meaning: IEAFP START was issued when holding a lock other than the LOCAL lock.</p> <p>Action: Avoid using IEAFP START when holding a lock other than the LOCAL lock.</p>
C	xxxx0C05	<p>Equate symbol: IeafpRsnNoStorage</p> <p>Meaning: Necessary system storage could not be obtained. For a task mode request, it is LSQA storage. For an SRB mode request, it is ESQA storage.</p> <p>Action: If issued in task mode, use IEAFP START at an earlier time in the jobstep. If issued in SRB mode, arrange for some current user of ESQA storage to release it or run this after a re-IPL after ensuring additional ESQA storage availability for that IPL.</p>
C	xxxx0C06	<p>Equate symbol: IeafpRsnSuperBit</p> <p>Meaning: IEAFP START was issued from a work unit with at least one bit on in the PSASUPER word. A DIE is one such kind of work unit.</p> <p>Action: Avoid issuing IEAFP from a DIE or any other work unit running with PSASUPER on.</p>

Examples

Example 1: Stop additional status saving.

The code is as follows:

```
IEAFP STOP
```

Chapter 12. IEAGSF – Guarded-Storage Facility services

Environment

The requirements for the caller are:

Environmental Factor	Requirement
Minimum authorization:	Problem state and PSW key 8-15
Dispatchable unit mode:	Task
Cross memory mode:	For START and STOP: Any PASN, any HASN, any SASN. For UPDATE: PASN=HASN
AMODE:	31- or 64-bit
ASC mode:	Primary or access register (AR)
Interrupt status:	Enabled for I/O and external interrupts
Locks:	The caller is not required to hold any locks on entry, but may hold the LOCAL lock.
Control parameters:	Control parameters must be in the primary address space.

Programming Requirements

Control parameters must be below the 2G line.

Include the IHAGSRET mapping macro to get equate symbols for the return and reason codes provided by the IEAGSF macro.

Restrictions

IEAGSF is only available if the CVTGSF bit is on.

IEAGSF must not be issued from an SRB or an asynchronous exit routine (IRB).

IEAGSF must not be issued for a task above the jobstep program TCB.

Supervisor-state or system key users must not use this facility if unauthorized programs can run in the same address space because unauthorized programs have the ability to change the GSF controls.

The caller must not have an FRR established when invoking IEAGSF UPDATE.

Input Register Information

Before issuing the IEAGSF macro, the caller does not have to place any information into any general purpose register (GPR) or access register (AR) unless using it in register notation for a particular parameter, or using it as a base register.

Output Register Information

When control returns to the caller, the GPRs contain:

**Register
Contents**

IEAGSF macro

0

Reason code, when GPR 15 is non-zero

1

Used as a work register by the system

2-13

Unchanged

14-15

Used as a work register by the system

15

Return code

When control returns to the caller, the ARs contain:

Register

Contents

0-1

Used as work registers by the system

2-13

Unchanged

14-15

Used as work registers by the system

Some callers depend on register contents remaining the same before and after issuing a service. If the system changes the contents of registers on which the caller depends, the caller must save them before issuing the service, and restore them after the system returns control.

Performance Implications

None.

Syntax

main diagram

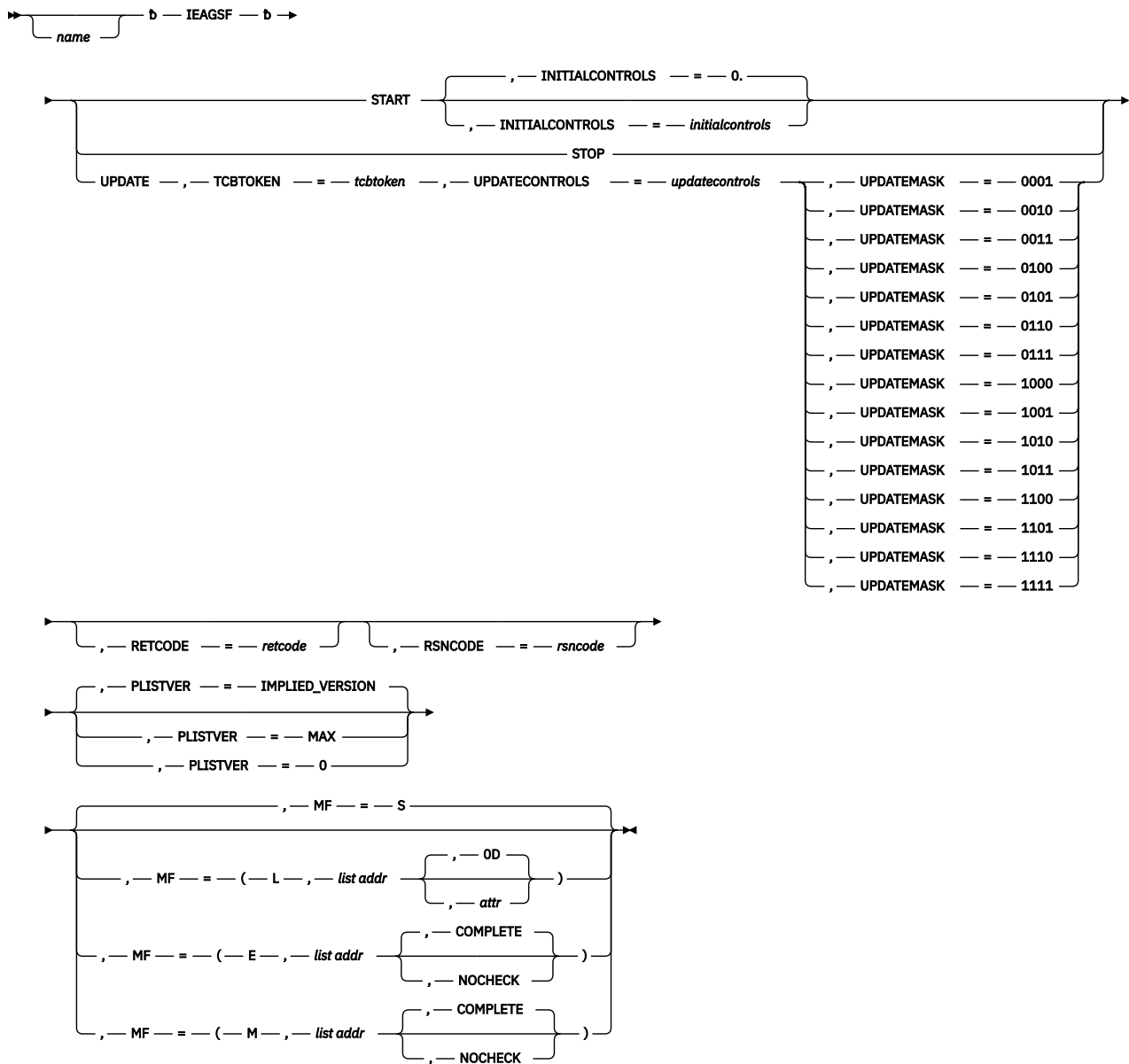

Parameters

The parameters are explained as follows:

name

An optional symbol, starting in column 1, that is the name on the IEAGSF macro invocation. The name must conform to the rules for an ordinary assembler language symbol.

,INITIALCONTROLS=initialcontrols

,INITIALCONTROLS=0.

When **START** is specified, an optional input parameter, which contains the initial GSF controls (GSCB) to be used. See the description of the Guarded-Storage Control Block in the z/Architecture Principles of Operation manual. The default is 0. The initial GSCB will be set to zeros.

To code: Specify the RS-type address, or address in register (2) - (12), of a 32-character field.

,MF=S
,MF=(L,list addr)
,MF=(L,list addr,attr)
,MF=(L,list addr,OD)
,MF=(E,list addr)
,MF=(E,list addr,COMPLETE)
,MF=(E,list addr,NOCHECK)
,MF=(M,list addr)
,MF=(M,list addr,COMPLETE)
,MF=(M,list addr,NOCHECK)

An optional input parameter that specifies the macro form.

Use MF=S to specify the standard form of the macro, which builds an inline parameter list and generates the macro invocation to transfer control to the service. MF=S is the default.

Use MF=L to specify the list form of the macro. Use the list form together with the execute form of the macro for applications that require reentrant code. The list form defines an area of storage that the execute form uses to store the parameters. Only the PLISTVER parameter may be coded with the list form of the macro.

Use MF=E to specify the execute form of the macro. Use the execute form together with the list form of the macro for applications that require reentrant code. The execute form of the macro stores the parameters into the storage area defined by the list form, and generates the macro invocation to transfer control to the service.

Use MF=M together with the list and execute forms of the macro for service routines that need to provide different options according to user-provided input. Use the list form to define a storage area; use the modify form to set the appropriate options; then use the execute form to call the service.

IBM recommends that you use the modify and execute forms of IEAGSF in the following order:

- Use IEAGSF ...MF=(M,list-addr,COMPLETE) specifying appropriate parameters, including all required ones.
- Use IEAGSF ...MF=(M,list-addr,NOCHECK), specifying the parameters that you want to change.
- Use IEAGSF ...MF=(E,list-addr,NOCHECK), to execute the macro.

,list addr

The name of a storage area to contain the parameters. For MF=S, MF=E, and MF=M, this can be an RS-type address or an address in register (1) - (12).

,attr

An optional 1- to 60-character input string that you use to force boundary alignment of the parameter list. Use a value of 0F to force the parameter list to a word boundary, or 0D to force the parameter list to a doubleword boundary. If you do not code *attr*, the system provides a value of 0D.

,COMPLETE

Specifies that the system is to check for required parameters and supply defaults for omitted optional parameters.

,NOCHECK

Specifies that the system is not to check for required parameters and is not to supply defaults for omitted optional parameters. When using the NOCHECK option, be sure that it is preceded by a modify or execute form invocation that specifies or defaults to the COMPLETE option. This ensures that the parameter list is initialized completely.

,PLISTVER=IMPLIED_VERSION

,PLISTVER=MAX

,PLISTVER=0

An optional input parameter that specifies the version of the macro. PLISTVER determines which parameter list the system generates. PLISTVER is an optional input parameter on all forms of the macro, including the list form. When using PLISTVER, specify it on all macro forms used for a request and with the same value on all of the macro forms. The values are:

- **IMPLIED_VERSION**, which is the lowest version that allows all parameters specified on the request to be processed. If you omit the PLISTVER parameter, IMPLIED_VERSION is the default.
- **MAX**, if you want the parameter list to be the largest size currently possible. This size might grow from release to release and affect the amount of storage that your program needs.

If you can tolerate the size change, IBM recommends that you always specify PLISTVER=MAX on the list form of the macro. Specifying MAX ensures that the list-form parameter list is always long enough to hold all the parameters you might specify on the execute form, when both are assembled with the same level of the system. In this way, MAX ensures that the parameter list does not overwrite nearby storage.

- **0**, if you use the currently available parameters.

To code: Specify one of the following:

- IMPLIED_VERSION
- MAX
- A decimal value of 0

,RETCODE=retcode

An optional output parameter into which the return code is to be copied from GPR 15. If you specify 15, GPR15, REG15, or R15 (within or without parentheses), the value will be left in GPR 15.

To code: Specify the RS-type address of a fullword field, or register (2) - (12) or (15), (GPR15), (REG15), or (R15). Do not specify with MF=M.

,RSNCODE=rsncode

An optional output parameter into which the reason code is to be copied from GPR 0. If you specify 0, 00, GPR0, GPR00, REG0, REG00, or R0 (within or without parentheses), the value will be left in GPR 0.

To code: Specify the RS-type address of a fullword field, or register (0) or (2) - (12), (00), (GPR0), (GPR00), REG0), (REG00), or (R0). Do not specify with MF=M.

START

A required input parameter keyword that indicates that the system should start the Guarded-Storage Facility and start the saving of Guarded-Storage Facility control information for the current TCB.

To code: Specify a value.

,STOP

A required input parameter keyword that indicates that the system should stop the saving of Guarded-Storage Facility control information and stop the Guarded-Storage Facility for the current TCB. Note that MF= is not supported (or needed) for IEAGSF STOP.

To code: Specify a value.

,TCBTOKEN=tcbtoken

When UPDATE is specified, a required input parameter, which contains the TCBTOKEN of the task to be updated. All of that task's subtasks will also be updated. The TCBTOKEN must be valid and must represent the jobstep program task or a subtask of the jobstep program task.

To code: Specify the RS-type address, or address in register (2) - (12), of a 16-character field.

,UPDATE

A required input parameter keyword that indicates that the system should synchronously update the Guarded-Storage Facility control information for the input TCB and all of its subtasks. Any tasks which have not issued IEAGSF START will be ignored.

To code: Specify a value.

,UPDATECONTROLS=updatecontrols

When UPDATE is specified, a required input parameter, which contains a new GSF Control Block ('GSCB') to be used. See the description of the Guarded-Storage Control Block in the z/Architecture Principles of Operation manual.

To code: Specify the RS-type address, or address in register (2) - (12), of a 32-character field.

,UPDTEMASK=0001
,UPDTEMASK=0010
,UPDTEMASK=0011
,UPDTEMASK=0100
,UPDTEMASK=0101
,UPDTEMASK=0110
,UPDTEMASK=0111
,UPDTEMASK=1000
,UPDTEMASK=1001
,UPDTEMASK=1010
,UPDTEMASK=1011
,UPDTEMASK=1100
,UPDTEMASK=1101
,UPDTEMASK=1110
,UPDTEMASK=1111

When UPDATE is specified, a required parameter, which specifies a mask that describes which of the 4 doublewords of each task's GSCB are to be updated using the new GSCB specified by UPDATECONTROLS. Use caution when updating the fourth doubleword - you may not want multiple tasks sharing the GSEPL that it points to.

,UPDTEMASK=0001

specifies that only the fourth doubleword is to be updated.

,UPDTEMASK=0010

specifies that only the third doubleword is to be updated.

,UPDTEMASK=0011

specifies that only the third and fourth doubleword are to be updated.

,UPDTEMASK=0100

specifies that only the second doubleword is to be updated.

,UPDTEMASK=0101

specifies that only the second and fourth doubleword are to be updated.

,UPDTEMASK=0110

specifies that only the second and third doublewords are to be updated.

,UPDTEMASK=0111

specifies that only the second, third, and fourth doublewords are to be updated.

,UPDTEMASK=1000

specifies that only the first doubleword is to be updated.

,UPDTEMASK=1001

specifies that only the first and fourth doublewords are to be updated.

,UPDTEMASK=1010

specifies that only the first and third doublewords are to be updated.

,UPDTEMASK=1011

specifies that only the first and third and fourth doublewords are to be updated.

,UPDTEMASK=1100

specifies that only the first and second doublewords are to be updated.

,UPDTEMASK=1101

specifies that only the first and second and fourth doublewords are to be updated.

,UPDTEMASK=1110

specifies that only the first and second and third doublewords are to be updated.

,UPDTEMASK=1111

specifies that all four doublewords are to be updated.

ABEND Codes

None.

Return and Reason codes

When the IEAGSF macro returns control to your program:

- GPR 15 (and *retcode*, when you code RETCODE) contains a return code.
- When the value in GPR 15 is not zero, GPR 0 (and *rsncode*, when you code RSNCODE) contains a reason code.

Macro IHAGSRET provides equate symbols for the return and reason codes.

The following table identifies the hexadecimal return and reason codes and the equate symbol associated with each reason code. IBM support personnel may request the entire reason code, including the xxxx value.

Table 10. Return and reason codes for the IEAGSF macro		
Return code	Reason code	Equate symbol, meaning and action
0	–	Equate symbol: IeaGsfRc_OK Meaning: IEAGSF request successful. Action: None required.
8	–	Equate symbol: IeaGsfRc_InvParm Meaning: IEAGSF request specifies parameters that are not valid. Action: Refer to the action provided with the specific reason code.
8	xxxx0801	Equate symbol: IeaGsfRsnBadFunction Meaning: Incorrect value passed to target routine. Action: Check for possible storage overlay.
8	xxxx0802	Equate symbol: IeaGsfRsnUpdateTcbBad Meaning: The TCB specified by the TTOKEN for an IEAGSF UPDATE request is no longer valid, or is terminating, or is neither the jobstep program task nor a subtask of the jobstep program task. Action: N/A
C	–	Equate symbol: IeaGsfRc_Env Meaning: Environmental error Action: Refer to the action provided with the specific reason code.
C	xxxx0C01	Equate symbol: IeaGsfRsnFromAsynchExit Meaning: IEAGSF was issued from an asynchronous exit routine. Action: Avoid issuing IEAGSF from an asynchronous exit routine.
C	xxxx0C02	Equate symbol: IeaGsfRsnFromSRB Meaning: IEAGSF was issued from an SRB. Action: Avoid issuing IEAGSF from an SRB.

<i>Table 10. Return and reason codes for the IEAGSF macro (continued)</i>		
Return code	Reason code	Equate symbol, meaning and action
C	xxxx0C03	<p>Equate symbol: IeaGsfRsnFromNotBITCB</p> <p>Meaning: IEAGSF was issued from a task that was neither the jobstep program task nor a subtask of the jobstep task.</p> <p>Action: Only issue IEAGSF from the jobstep program task or a subtask of that task.</p>
C	xxxx0C04	<p>Equate symbol: IeaGsfRsnLocked</p> <p>Meaning: IEAGSF was issued while holding a lock other than the LOCAL lock.</p> <p>Action: Avoid issuing IEAGSF while holding a lock other than the LOCAL lock.</p>
C	xxxx0C05	<p>Equate symbol: IeaGsfRsnNoStorage</p> <p>Meaning: Necessary system storage could not be obtained from LSQA.</p> <p>Action: Use IEAGSF START at an earlier time in the jobstep.</p>
C	xxxx0C06	<p>Equate symbol: IeaGsfRsnSuperBit</p> <p>Meaning: IEAGSF was issued from a work unit with at least one bit on in the PSASUPER word.</p> <p>Action: Avoid issuing IEAGSF from a work unit running with a PSASUPER bit on.</p>
C	xxxx0C07	<p>Equate symbol: IeaGsfRsnNotAvailable</p> <p>Meaning: The Guarded-Storage Facility is not available on this system.</p> <p>Action: Ensure that the hardware supports this facility.</p>
C	xxxx0C08	<p>Equate symbol: IeaGsfRsnUpdateInXM</p> <p>Meaning: IEAGSF UPDATE has been called with a Primary address space that is different than the Home address space.</p> <p>Action: Only invoke IEAGSF UPDATE with the Primary address space equal to the Home address space.</p>

Example

Start using the Guarded-Storage Facility with an initial GSCB:

The code is as follows.

```
IEAGSF START,INITIALCONTROLS=MYGSCB
```

Chapter 13. IEAINTKN – Build incident token

Description

Use the IEAINTKN macro to build an incident token. You can pass the token to other routines to identify related pieces of problem data.

Normally you will not need to use an IEAINTKN macro because the system generates an incident token when an SVC dump is requested and an incident token is not provided. For example, the system provides an incident token when it processes an SDUMPX macro without an INTOKEN parameter.

Environment

The requirements for the caller are:

Environmental factor	Requirement
Minimum authorization:	Problem state with PSW key 8-15
Dispatchable unit mode:	Task or SRB
Cross memory mode:	Any PASN, any HASN, any SASN
AMODE:	24- or 31- bit
ASC mode:	Primary or access register (AR)
Interrupt Status:	Enabled or disabled for I/O and external interrupts
Locks:	The caller may hold locks, but is not required to hold any.

Programming requirements

- Place the TOKEN area in the primary address space or, for AR-mode callers, in an address space or data space that is addressable through an ALET that you provide.
- Include the CVT mapping macro.

Restrictions

None.

Input register information

Before issuing the IEAINTKN macro, the caller does not have to place any information into any register unless using it in register notation for a particular parameter, or using it as a base register.

Output register information

When control returns to the caller, the general purpose registers (GPRs) contain:

Register Contents

0-1

Used as work registers by the system

2-13

Unchanged

IEAINTKN macro

14-15

Used as work registers by the system

When control returns to the caller, the access registers (ARs) contain:

Register Contents

0-1

Used as work registers by the system

2-13

Unchanged

14-15

Used as work registers by the system

Some callers depend on register contents remaining the same before and after issuing a service. If the system changes the contents of registers on which the caller depends, the caller must save them before issuing the service, and restore them after the system returns control.

Performance implications

None.

Syntax

The standard form of the IEAINTKN macro is written as follows:

Syntax	Description
<i>name</i>	<i>name</i> : Symbol. Begin <i>name</i> in column 1.
␣	One or more blanks must precede IEAINTKN.
IEAINTKN	
␣	One or more blanks must follow IEAINTKN.
,TOKEN= <i>inctoken addr</i>	<i>inctoken addr</i> : RX-type address or register (2) - (12).

Parameters

The parameters are explained as follows:

TOKEN=*inctoken addr*

Specifies the address of a 32-character area where the system builds the incident token. The area must begin on a doubleword boundary.

ABEND codes

None.

Return and reason codes

None.

Example

Provide an incident token in the area named MYTOKEN.

```
IEAINTKN TOKEN=MYTOKEN
.
.
.
MYTOKEN DS 0D          Align parameter on double word boundary
        DS CL32       Incident token
        CVT ,         CVT mapping
```

Chapter 14. IEALSQRY – Linkage stack query

Description

The linkage stack query macro IEALSQRY checks the level of the current entry on the linkage stack relative to the level of the entry associated with the most recent recovery routine. The output of the macro is a value (in the TOKEN parameter) a recovery routine can use to ensure that a retry routine runs with the appropriate linkage stack entry. If the return code is not zero, the value in TOKEN is not valid.

Your program is to pass the value in TOKEN to a recovery routine. When the recovery routine gets control, it can place that value in the SDWA field SDWALSLV. That action ensures that, when a retry routine gets control, it has the correct linkage stack level. For information about how to use the value in TOKEN, see the topic about the linkage stack at a retry routine in *z/OS MVS Programming: Assembler Services Guide*.

The output of IEALSQRY depends upon the current environment and on the recovery environment that exists:

- If at least one ESTAE-type recovery routine is in effect, the output depends on the most recently activated routine:
 - If it is a STAE or STAI routine, a return code of 8 is returned.
 - If it is an ESTAE or ESTAEX for the current RB, the value returned is the difference between the current level of the linkage stack and the level of the stack at the time the ESTAE or ESTAEX was activated.
 - If it is an ESTAI, the value returned is the difference between the current level of the linkage stack and the level of the stack at the time the newest PRB that is older than the oldest non-PRB was created (or simply the newest PRB if all the RBs are PRBs).
- If no STAEs, ESTAEXs, ESTAEs exist for this RB and no ESTAI or STAI are in effect, a return code of 8 is returned.

See *z/OS MVS Programming: Assembler Services Guide* for further information about the use of the SDWALSLV field.

Environment

The requirements for the caller are:

Environmental factor	Requirement
Minimum authorization:	Problem state, PSW key 8-15
Dispatchable unit mode:	Task
Cross memory mode:	Any PASN, any HASN, any SASN
Amode:	24- or 31-bit
ASC mode:	Primary or access register (AR)
Interrupt status:	Enabled or disabled for I/O and external interrupts
Locks:	No locks are required.
Control parameters:	Control parameters must be in the primary address space.

Programming requirements

None.

Restrictions

None.

Input register information

Before issuing the IEALSQRY macro, the caller does not have to place any information into a general purpose register (GPR) or access register (AR).

Output register information

When control returns to the caller from IEALSQRY, the GPRs contain:

Register

Contents

0

Output token value, which is copied to the area specified by the TOKEN parameter.

1

Used as a work register by the system.

2-13

Unchanged.

14

Used as a work register by the system.

15

Return code.

When control returns to the caller from IEALSQRY, the access registers (ARs) contain:

Register

Contents

0-1

Used as work registers by the system.

2-13

Unchanged.

14 and 15

Used as work registers by the system.

Performance implications

This macro should not be used in a performance-sensitive program.

Syntax

The standard form of the IEALSQRY macro is written as follows:

Syntax	Description
<i>name</i>	<i>name</i> : symbol. Begin <i>name</i> in column 1.
␣	One or more blanks must precede IEALSQRY.
IEALSQRY	

Syntax	Description
␣	One or more blanks must follow IEALSQRY.
	Valid parameters
TOKEN= <i>token</i>	<i>token</i> : RS-type address or register (1) - (12). Default : Leave token in GPR 0.
,RETCODE= <i>retcode</i>	<i>retcode</i> : RS-type address, or register (2) - (12). Default : No retcode processing.

The parameters are explained as follows:

TOKEN=*token*

Specifies a halfword area (or the address of the area in register (1)-(12)) where the system places a value that indicates the difference between the number of linkage stack entries present when the recovery routine was activated and the number that are currently present. A recovery routine can place this value in field SDWALSLV (in mapping macro IHASDWA) to ensure that the retry routine runs with the proper level of the linkage stack. If you do not use TOKEN, you can find the value in GPR 0.

RETCODE=*retcode*

Specifies a fullword output variable (or register (2)-(12)) into which the system copies the return code GPR 15. If you do not use RETCODE, you can find the return code in GPR 15.

ABEND codes

The IEALSQRY caller might receive abend code X'B78'. For detailed abend code information, see [z/OS MVS System Codes](#).

Return codes

When control returns to the caller, register 15 contains one of the following decimal return codes (hexadecimal values are shown in parentheses):

Return Code	Meaning and Action
0 (0)	Meaning : Successful completion. A valid value is in the TOKEN parameter. Action : None required.
4 (4)	Meaning : The system encountered a linkage stack entry that violates the authorization or stacking-PC conditions that are required for successful retry. Action : Avoid using the token when retrying. You cannot retry to the current linkage stack level.
8 (8)	Meaning : No recovery routine of the proper type exists. Either no recovery routine exists or the most recently activated recovery routine is STAE or STAI. Action : Avoid using the token when retrying. You cannot retry to the current linkage stack level.

Table 11. Return Codes for IEALSQRY (continued)

Return Code	Meaning and Action
16 (10)	Meaning: System error. Action: Report the problem to IBM. Avoid using the token when retrying. You cannot retry to the current linkage stack level.

Example

Obtain the value that a recovery routine can place in SDWALSLV:

```
        IEALSQRY TOKEN=MYTOKEN
        .
        MYTOKEN DS      H          Output TOKEN
```

Chapter 15. IEAMETR – Query external time reference status

Description

IEAMETR can be used to query external time reference (ETR) status and connection information for the current MVS image. This information is returned in the output area specified by the OUTAREA keyword.

Environment

The requirements for the caller are:

Environmental factor	Requirement
Minimum authorization:	Any state or key
Dispatchable unit mode:	Task mode
Cross memory mode:	Any PASN, any HASN, any SASN
AMODE:	31-bit
ASC mode:	Primary or access register
Interrupt status:	Enabled for I/O and external interrupts
Locks:	None
Control parameters:	Must be in the primary address space

Programming requirements

None.

Restrictions

None.

Input register information

Before issuing the IEAMETR macro, the caller does not have to place any information into any register unless using it in register notation for a particular parameter, or using it as a base register.

Before issuing the IEAMETR macro, the caller does not have to place any information into any AR unless using it in register notation for a particular parameter, or using it as a base register.

Output register information

When control returns to the caller, the GPRs contain:

Register

Contents

0-1

Used as work registers by the system

2-13

Unchanged

14

Used as a work register by the system

IEAMETR macro

15

Return code

When control returns to the caller, the ARs contain:

Register

Contents

0-1

Used as work registers by the system

2-13

Unchanged

14-15

Used as work registers by the system

Performance implications

None.

Syntax

The IEAMETR macro is written as follows:

Syntax	Description
<i>xlabel</i>	<i>xlabel</i> : Optional symbol. Begin <i>xlabel</i> in column 1. The name must conform to the rules for an ordinary assembler language symbol. DEFAULT: No name.
␣	One or more blanks must precede IEAMETR.
IEAMETR	
␣	One or more blanks must follow IEAMETR.
OUTADDR= <i>xoutaddr</i>	
,MF=S	Default: S
,MF=(L,xmfctrl,xmfattr OD)	
,MF=(E,xmfctrl,COMPLETE)	

Parameters

The parameters are explained as follows:

OUTADDR=*xoutaddr*

A required input parameter that contains the address of the 24-byte output area to receive the output. The area is mapped by macro IHAETRI.

To code: Specify the RS-type address, or address in register (2)-(12), of a pointer field.

,MF=S | L | E

Optional keyword input that specifies the macro form.

S

Specifies the standard form of the macro. Generates code to put the parameters into an in-line parameter list and invoke the desired service. Full checking for required macro keys is done along with supplying defaults for omitted optional parameters.

DEFAULT: S

L

Specifies the list form of the macro. Defines an area to be used for the parameter list. Any other macro parameters are flagged as errors.

E

Specifies the execute form of the macro. Generates code to put the parameters into the parameter list specified by `xmfcrtl` and provides syntax checking with default setting.

,xmfcrtl

Required input. It is the name of a storage for the parameter list.

,xmfcrtl | OD

Optional 60 character input string that varies from 1 to 60 characters. It can contain any value that is valid on an assembler DS pseudo-op. You can use this parameter to force boundary alignment of the parameter list.

DEFAULT: OD. OD forces the parameter list to a doubleword boundary.

,xmfcrtl

Required input. It is the name (RS-type), or address in register (1)-(12), of a storage area for the parameter list.

,COMPLETE

Optional keyword input that specifies the degree of macro parameter syntax checking.

DEFAULT: COMPLETE. Checking for required macro keys is done, and defaults are supplied for omitted optional parameters.

Return codes

Hexadecimal Return Code	Meaning and Action
00	Meaning: ETR status and port data was successfully obtained. Action: None.
04	Meaning: ETR status information is available, but port is not. Action: None.
08	Meaning: No status or port data is available. Action: None.
0C	Meaning: The parameter list is not in the user's primary address space. Action: Use a parameter list in the primary address space.

Chapter 16. IEANTCR – Create a name/token pair

Description

Call the IEANTCR service to create a name/token pair.

Environment

The requirements for the caller are:

Environmental factor	Requirement
Minimum authorization:	Problem state, with any PSW key
Dispatchable unit mode:	Task
Cross memory mode:	Any PASN, any HASN, any SASN
AMODE:	31-bit
ASC mode:	Primary or access register (AR)
Interrupt status:	Enabled for I/O and external interrupts
Locks:	No locks held
Control parameters:	The parameter list and all parameters must reside in the caller's primary address space.

Programming requirements

Before you use name/token services, you can optionally include the IEANTASM macro to invoke name/token services equate (EQU) statements. IEANTASM provides the following constants for use in your program:

```

* Name/Token Level Constants
*
IEANT_TASK_LEVEL          EQU    1
IEANT_HOME_LEVEL         EQU    2
IEANT_PRIMARY_LEVEL      EQU    3
IEANT_SYSTEM_LEVEL      EQU    4
IEANT_TASKAUTH_LEVEL     EQU   11
IEANT_HOMEAUTH_LEVEL     EQU   12
IEANT_PRIMARYAUTH_LEVEL  EQU   13
*
* Name/Token Persistence Constants
*
IEANT_NOPERSIST          EQU    0
IEANT_PERSIST           EQU    1
IEANT_NOCHECKPOINT      EQU    0
IEANT_CHECKPOINTOK      EQU    2
*
* Name/Token Return Code Constants
*
IEANT_OK                 EQU    0
IEANT_DUP_NAME           EQU    4
IEANT_NOT_FOUND         EQU    4
IEANT_24BITMODE         EQU    8
IEANT_NOT_AUTH          EQU   16
IEANT_SRB_MODE          EQU   20
IEANT_LOCK_HELD         EQU   24
IEANT_LEVEL_INVALID     EQU   28
IEANT_NAME_INVALID      EQU   32
IEANT_PERSIST_INVALID   EQU   36
IEANT_AR_INVALID        EQU   40
IEANT_UNEXPECTED_ERR    EQU   64

```

Restrictions

None.

Input register information

Before issuing the IEANTCR callable service, the caller does not have to place any information into any register unless using it in register notation for a particular parameter, or using it as a base register.

Output register information

When control returns to the caller, the general purpose registers (GPRs) contain:

Register Contents

0-1
Used as work registers by the system

2-13
Unchanged

14
Used as a work register by the system

15
Return code

When control returns to the caller, the access registers (ARs) contain:

Register Contents

0-1
Used as work registers by the system

2-13
Unchanged

14-15
Used as work registers by the system

Some callers depend on register contents remaining the same before and after issuing a service. If the system changes the contents of registers on which the caller depends, the caller must save them before issuing the service, and restore them after the system returns control.

Performance implications

None.

Syntax

Write the call as shown on the syntax diagram. You must code all parameters on the CALL statement in the order shown.

Syntax	Description
CALL IEANTCR	,(level ,user_name ,user_token ,persist_option ,return_code)

Link edit your program with a linkage-assist routine (also called a stub) in SYS1.CSSLIB unless you use one of the following techniques as an alternative to CALL IEANTCR:

```

1.  LOAD EP=IEANTCR
    Save the entry point address
    ...
    Put the saved entry point address into R15
    CALL (15),(...)

2.  L    15,X'10'
    L    15,X'220'(15,0)
    L    15,X'14'(15,0)
    L    15,X'04'(15,0)
    CALL (15),(...)

```

This second technique requires AMODE=31, and, before the CALL is issued, verification that the IEANTCR service is supported by the system (in the CVT, both the CVTOSEXT and the CVTOS390 bits are set on).

Parameters

The parameters are explained as follows:

(level

Specifies a fullword that contains an integer indicating the level of the name/token pair:

- 1 - Task
- 2 - Home address space
- 3 - Primary address space.

,user_name

Specifies the 16-byte area containing the name of the name/token pair that the user creates. The bytes of the name may have any value. The name may contain blanks, integers, or addresses.

Names must be unique within a level. Here are some examples.

- Two task-level name/token pairs owned by the same task cannot have the same name. However, two task-level name/token pairs owned by different tasks can have the same name.
- Two home-address-space-level name/token pairs in the same address space cannot have the same name. However, two home-address-space-level name/token pairs in different address spaces can have the same name.

Because of these unique requirements you must avoid using the same names that IBM uses for name/token pairs. Do not use the following names:

- Names that begin with A through I
- Names that begin with X'00'.

,user_token

Specifies the 16-byte area containing the token of the name/token pair that the user creates.

,persist_option

Specifies a fullword that contains an integer indicating if Checkpoint/Restart can be issued if the program has this task-level name/token pair.

- 0 - checkpoint is not permitted
- 2 - checkpoint is permitted.

Note: Only task-level name/token pairs can permit checkpoint. You must specify 0 for all other levels.

,return_code)

Specifies a fullword to contain the return code from the IEANTCR service.

ABEND codes

The caller might encounter abend X'AC7' with a reason code of either X'00030000' or X'00030001'. See [z/OS MVS System Codes](#) for an explanation and responses for these codes.

Return and reason codes

When IEANTCR returns control to your program, GPR 15 and *return_code* contain a return code. The following table identifies return codes in hexadecimal and decimal, tells what each means, and recommends an action that you should take:

Hexadecimal Return Code	Decimal Return Code	Meaning and Action
00	0	Meaning: The operation was successful. Action: None.
04	4	Meaning: The <i>user_name</i> specified already exists. Action: Choose a different <i>user_name</i> .
08	8	Meaning: The request is rejected because the caller is in 24-bit addressing mode. Action: Change your program to 31-bit addressing mode.
10	16	Meaning: An unauthorized caller attempted to create a system-level name/token pair. Action: Check which level of name/token pair you are creating.
18	24	Meaning: The caller held locks. Action: Release all locks before issuing IEANTCR.
1C	28	Meaning: The caller specified an incorrect <i>level</i> . Action: Respecify the correct <i>level</i> . Valid values are 1, 2, or 3.
20	32	Meaning: The caller specified an incorrect <i>user_name</i> . Action: Respecify the correct <i>user_name</i> .
24	36	Meaning: The caller specified an incorrect <i>persist_option</i> . Action: <ul style="list-style-type: none"> • For task-level name/token pairs, you must specify zero or two for the <i>persist_option</i>. • For home or primary address space level name/token pairs, you must specify zero for the <i>persist_option</i>.
28	40	Meaning: The caller was in AR ASC mode and AR1 was not zero. Action: Change your program to primary mode or make sure the parameter list is in the primary address space.
40	64	Meaning: A system error occurred while handling the request. Action: Retry the request.

Example

Initialize the name/token fields, and create, retrieve, and delete a task-level name/token pair.

```
TITLE 'NAME/TOKEN EXAMPLE PROGRAM'
NTIDSAMP CSECT
```

```

NTIDSAMP AMODE 31
NTIDSAMP RMODE ANY
          BAKR R14,0          SAVE CALLING PROGRAM'S
                                REGISTERS AND RETURN LOCATION
*                                ESTABLISH BASE REG
          LR R12,R15
          USING NTIDSAMP,R12
*****
* INITIALIZE THE NAME AND TOKEN FIELDS *
*****
          MVC NAME,=CL16'NTIDSAMP NAME ' INITIALIZE NAME FIELD
          MVC TOKEN,NAME          FOR EXAMPLE, MAKE TOKEN THE
                                SAME AS THE NAME
*
*****
* TASK LEVEL CREATE EXAMPLE *
*****
          CALL IEANTCR,(LEVEL,NAME,TOKEN,PERSOPT,RETCODE)
*****
          CLC RETCODE,=F'0'      IS RETURN CODE 0?
          BNE ABEND              NO, GO ABEND
          EJECT
*****
* TASK LEVEL RETRIEVE EXAMPLE *
*****
          CALL IEANTRT,(LEVEL,NAME,TOKEN,RETCODE)
*****
          CLC RETCODE,=F'0'      IS RETURN CODE 0?
          BNE ABEND              NO, GO ABEND
          EJECT
*****
* TASK LEVEL DELETE EXAMPLE *
*****
          CALL IEANTDL,(LEVEL,NAME,RETCODE)
*****
          CLC RETCODE,=F'0'      IS RETURN CODE 0?
          BNE ABEND              NO, GO ABEND
          EJECT
          SLR R15,R15            SET RETURN CODE OF ZERO
EXIT      PR                    RETURN TO CALLER
          EJECT
ABEND     ABEND X'BAD'          ABEND IF NONZERO RETURN CODE
          EJECT
*****
* NAME/TOKEN VARIABLE DECLARES *
*****
          IEANTASM
          EJECT
*****
* Constants and data areas *
*****
LEVEL     DC A(IEANT_TASK_LEVEL) Task level
NAME      DS CL16              Name for name/token pair
TOKEN     DS XL16              Token for name/token pair
PERSOPT   DC A(IEANT_NOPERSIST) Persist option
RETCODE   DS F                 Return code
*****
* EQUATES
*****
R1        EQU 1
R12       EQU 12
R13       EQU 13
R14       EQU 14
R15       EQU 15
END       NTIDSAMP

```

Chapter 17. IEANTDL – Delete a name/token pair

Description

Call the IEANTDL service to delete a name/token pair.

Environment

The requirements for the caller are:

Environmental factor	Requirement
Minimum authorization:	Problem state and any PSW key Note: Problem-state programs with PSW key 8 - 15 cannot delete name/token pairs created by supervisor-state or PSW key 0 - 7 programs.
Dispatchable unit mode:	Task
Cross memory mode:	Any PASN, any HASN, any SASN
AMODE:	31-bit
ASC mode:	Primary or access register (AR)
Interrupt status:	Enabled for I/O and external interrupts
Locks:	No locks held
Control parameters:	The parameter list and all parameters must reside in the caller's primary address space.

Programming requirements

Before you use name/token services, you can optionally include the IEANTASM macro to invoke name/token services equate (EQU) statements. IEANTASM provides the following constants for use in your program:

```
* Name/Token Level Constants
*
IEANT_TASK_LEVEL          EQU    1
IEANT_HOME_LEVEL         EQU    2
IEANT_PRIMARY_LEVEL      EQU    3
IEANT_SYSTEM_LEVEL       EQU    4
IEANT_TASKAUTH_LEVEL     EQU   11
IEANT_HOMEAUTH_LEVEL     EQU   12
IEANT_PRIMARYAUTH_LEVEL  EQU   13
*
* Name/Token Persistence Constants
*
IEANT_NOPERSIST          EQU    0
IEANT_PERSIST            EQU    1
*
* Name/Token Return Code Constants
*
IEANT_OK                  EQU    0
IEANT_DUP_NAME            EQU    4
IEANT_NOT_FOUND           EQU    4
IEANT_24BITMODE          EQU    8
IEANT_NOT_AUTH            EQU   16
IEANT_SRB_MODE            EQU   20
IEANT_LOCK_HELD          EQU   24
IEANT_LEVEL_INVALID      EQU   28
IEANT_NAME_INVALID       EQU   32
IEANT_PERSIST_INVALID    EQU   36
```

IEANTDL callable service

IEANT_AR_INVALID	EQU	40
IEANT_UNEXPECTED_ERR	EQU	64

Restrictions

None.

Input register information

Before issuing the IEANTDL callable service, the caller does not have to place any information into any register unless using it in register notation for a particular parameter, or using it as a base register.

Output register information

When control returns to the caller, the general purpose registers (GPRs) contain:

Register

Contents

0-1

Used as work registers by the system

2-13

Unchanged

14

Used as a work register by the system

15

Return code

When control returns to the caller, the access registers (ARs) contain:

Register

Contents

0-1

Used as work registers by the system

2-13

Unchanged

14-15

Used as work registers by the system

Some callers depend on register contents remaining the same before and after issuing a service. If the system changes the contents of registers on which the caller depends, the caller must save them before issuing the service, and restore them after the system returns control.

Performance implications

None.

Syntax

Write the call as shown on the syntax diagram. You must code all parameters on the CALL statement in the order shown.

Syntax	Description
CALL IEANTDL	,(level ,user_name ,return_code)

Link edit your program with a linkage-assist routine (also called a stub) in SYS1.CSSLIB unless you use one of the following techniques as an alternative to CALL IEANTDL:

```

1.  LOAD EP=IEANTDL
    Save the entry point address
    ...
    Put the saved entry point address into R15
    CALL (15),(...)

2.  L   15,X'10'
    L   15,X'220'(15,0)
    L   15,X'14'(15,0)
    L   15,X'0C'(15,0)
    CALL (15),(...)

```

This second technique requires AMODE=31, and, before the CALL is issued, verification that the IEANTDL service is supported by the system (in the CVT, both the CVT0SEXT and the CVTOS390 bits are set on).

Parameters

The parameters are explained as follows:

(level

Specifies a fullword that contains an integer indicating the level of the name/token pair you wish to delete:

- 1 - Task
- 2 - Home address space
- 3 - Primary address space.

,user_name

Specifies the 16-byte area containing the name of the name/token pair to be deleted.

,return_code)

Specifies a fullword to contain the return code from the IEANTDL service.

ABEND codes

The caller might encounter abend X'AC7' with a reason code of either X'00030000' or X'00030001'. See [z/OS MVS System Codes](#) for an explanation and responses to these codes.

Return and reason codes

When IEANTDL returns control to your program, GPR 15 and *return_code* contain a return code. The following table identifies return codes in hexadecimal and decimal, tells what each means, and recommends an action that you should take:

Hexadecimal Return Code	Decimal Return Code	Meaning and Action
00	0	Meaning: The operation was successful. Action: None.

Hexadecimal Return Code	Decimal Return Code	Meaning and Action
04	4	Meaning: The request is rejected because the system could not find the requested name/token pair. Action: Check the <i>user_name</i> you specified.
08	8	Meaning: The request is rejected because the caller is in 24-bit addressing mode. Action: Change your program to 31-bit addressing mode.
10	16	Meaning: An unauthorized caller attempted to delete a system-level name/token pair or a name/token pair created by an authorized program. Action: Check which level of name/token pair you are deleting.
18	24	Meaning: The caller held locks. Action: Release all locks before issuing IEANTDL.
1C	28	Meaning: The caller specified an incorrect <i>level</i> . Action: Respecify the correct <i>level</i> . Valid values are 1, 2, or 3.
20	32	Meaning: The caller specified an incorrect <i>user_name</i> . Action: Respecify the correct <i>user_name</i> .
28	40	Meaning: The caller was in AR ASC mode and AR1 was not zero. Action: Change your program to primary mode or make sure the parameter list is in the primary address space.
40	64	Meaning: A system error occurred while handling the request. Action: Retry the request.

Example

For a complete example of creating, retrieving, and deleting a task-level name/token pair, see the IEANTCR callable service.

Chapter 18. IEANTRT – Retrieve the token from a name/token pair

Description

Call the IEANTRT service to retrieve the token from a name/token pair. For example, you can use IEANTRT to obtain the name of the logrec recording medium, which is either the name of the logrec data set or the name of the logrec log stream.

Environment

The requirements for the caller are:

Environmental factor	Requirement
Minimum authorization:	Problem state and any PSW key
Dispatchable unit mode:	Task
Cross memory mode:	Any PASN, any HASN, any SASN
AMODE:	31-bit
ASC mode:	Primary or access register (AR)
Interrupt status:	Enabled for I/O and external interrupts
Locks:	The caller can hold a local, CML, or CMS lock; however, no locks are required.
Control parameters:	The parameter list and all parameters must reside in the caller's primary address space.

Programming requirements

Before you use name/token services, you can optionally include macro IEANTASM to invoke name/token services equate (EQU) statements. IEANTASM provides the following constants for use in your program:

```
* Name/Token Level Constants
*
IEANT_TASK_LEVEL          EQU    1
IEANT_HOME_LEVEL         EQU    2
IEANT_PRIMARY_LEVEL      EQU    3
IEANT_SYSTEM_LEVEL       EQU    4
IEANT_TASKAUTH_LEVEL     EQU   11
IEANT_HOMEAUTH_LEVEL     EQU   12
IEANT_PRIMARYAUTH_LEVEL  EQU   13
*
* Name/Token Persistence Constants
*
IEANT_NOPERSIST          EQU    0
IEANT_PERSIST           EQU    1
*
* Name/Token Return Code Constants
*
IEANT_OK                 EQU    0
IEANT_DUP_NAME           EQU    4
IEANT_NOT_FOUND          EQU    4
IEANT_24BITMODE          EQU    8
IEANT_NOT_AUTH           EQU   16
IEANT_SRB_MODE           EQU   20
IEANT_LOCK_HELD          EQU   24
IEANT_LEVEL_INVALID     EQU   28
IEANT_NAME_INVALID       EQU   32
IEANT_PERSIST_INVALID    EQU   36
```

IEANTRT callable service

IEANT_AR_INVALID	EQU	40
IEANT_UNEXPECTED_ERR	EQU	64

To obtain the name of the logrec data set or the name of the logrec log stream, you can include the IFBNTASM macro, as well as the IEANTASM macro, in your program. See [“Example 2” on page 168](#) for the list of definitions IFBNTASM provides.

Restrictions

Do not call the IEANTRT callable service with the *user_name* and *user_token* parameters in the same storage location.

Input register information

Before issuing the IEANTRT callable service, the caller does not have to place any information into any register unless using it in register notation for a particular parameter, or using it as a base register.

Output register information

When control returns to the caller, the general purpose registers (GPRs) contain:

Register

Contents

0-1

Used as work registers by the system

2-13

Unchanged

14

Used as a work register by the system

15

Return code

When control returns to the caller, the access registers (ARs) contain:

Register

Contents

0-1

Used as work registers by the system

2-13

Unchanged

14-15

Used as work registers by the system

Some callers depend on register contents remaining the same before and after issuing a service. If the system changes the contents of registers on which the caller depends, the caller must save them before issuing the service, and restore them after the system returns control.

Performance implications

None.

Syntax

Write the call as shown on the syntax diagram. You must code all parameters on the CALL statement in the order shown.

Syntax	Description
CALL IEANTRT	,(level ,user_name ,user_token ,return_code)

Link edit your program with a linkage-assist routine (also called a stub) in SYS1.CSSLIB unless you use one of the following techniques as an alternative to CALL IEANTRT:

```

1.  LOAD EP=IEANTRT
    Save the entry point address
    ...
    Put the saved entry point address into R15
    CALL (15),(...)

2.  L    15,X'10'
    L    15,X'220'(15,0)
    L    15,X'14'(15,0)
    L    15,X'08'(15,0)
    CALL (15),(...)

```

This second technique requires AMODE=31, and, before the CALL is issued, verification that the IEANTCR service is supported by the system (in the CVT, both the CVTOSEXT and the CVTOS390 bits are set on).

Parameters

The parameters are explained as follows:

(level

Specifies a fullword that contains an integer indicating the level of the name/token pair from which you want to retrieve the token:

- 1 - Task
- 2 - Home address space
- 3 - Primary address space
- 4 - System.

,user_name

Specifies the 16-byte area containing the name of the requested name/token pair.

,user_token

Specifies the 16-byte area to contain the token of the requested name/token pair.

,return_code)

Specifies a fullword to contain the return code from the IEANTRT service.

ABEND codes

None.

Return and reason codes

When IEANTRT returns control to your program, GPR 15 and *return_code* contain a return code. The following table identifies return codes in hexadecimal and decimal, tells what each means, and recommends an action that you should take:

Hexadecimal Return Code	Decimal Return Code	Meaning and Action
00	0	Meaning: The operation was successful. Action: None.
04	4	Meaning: The request is rejected because the system could not find the requested name/token pair. Action: Check the <i>user_name</i> you specified.
08	8	Meaning: The request is rejected because the caller is in 24-bit addressing mode. Action: Change your program to 31-bit addressing mode.
1C	28	Meaning: The caller specified an incorrect <i>level</i> . Action: Respecify the correct <i>level</i> . Valid values are 1, 2, 3, or 4.
40	64	Meaning: A system error occurred while handling the request. Action: Retry the request.

Example 1

For a complete example of creating, retrieving, and deleting a task-level name/token pair, see the IEANTCR callable service.

Example 2

Following is an example of using Name/Token services to obtain the name of the logrec data set or logrec log stream. (Note that because the routine is not reentrant, module IEANTRT is first loaded and then called.) IEANTRT returns a token that contains a pointer to the name of the logrec data set or logrec log stream.

Before you use name/token services, you can optionally include macro IFBNTASM which provides the following definitions for use in your program:

```

* IFBNTASM Parameters
IFBNT_DSNLOGREC      DC      CL16'DSNLOGREC      '      System level
*
IFBNT_VERSION1      EQU      X'01'      First version of IFBNT_TOKEN
IFBNT_VERSION2      EQU      X'02'      Second version of IFBNT_TOKEN
IFBNT_LATEST_VERSION EQU      X'02'      Latest version of IFBNT_TOKEN
*
IFBNT_TOKEN         DSECT    ,          Token area
IFBNT_LOGREC_NAME_PTR DS      A          Address of the LOGREC data
*                                     set name area
IFBNT_VERSION       DS      X          Version of IFBNT_LOGREC
IFBNT_RESV1         DS      X          Reserved for IBM
IFBNT_LENGTH        DS      XL2       Length of IFBNT_LOGREC area
IFBNT_RESV2         DS      CL8       Reserved for IBM
*
IFBNT_LOGREC        DSECT    ,          Pointed to by
*                                     IFBNT_LOGREC_NAME_PTR
IFBNT_LOGREC_NAME   DS      CL44      LOGREC data set name or
*                                     no data set name string (see
*                                     comments at end of mapping)
IFBNT_LOGREC_CURRENT DS      XL1      Current Logrec recording
*                                     medium
IFBNT_LOGREC_PREVIOUS DS      XL1     Previous Logrec recording
*                                     medium
IFBNT_LOGREC_LOGSTREAM DS      CL26   Logrec log stream name,
*                                     only filled in when
*                                     IFBNT_USE_LOGSTREAM is
*                                     the current medium

```

```

IFBNT_LOGREC_LEN      EQU      *-IFBNT_LOGREC Length of IFBNT_LOGREC
*
*****
* The following values are used in the following fields:
*   IFBNT_LOGREC_CURRENT
*   IFBNT_LOGREC_PREVIOUS
*****
IFBNT_USE_DATASET     EQU      X'01'      Logrec data set being used
IFBNT_USE_LOGSTREAM   EQU      X'02'      Logrec log stream being used
IFBNT_IGNORE_RECORDS  EQU      X'03'      Logrec recording is ignored
*
*****
* If a Logrec data set was not defined during the IPL of the system
* then the following string will appear in field
* IFBNT_LOGREC_NAME = '...NO.LOGREC.DATA.SET.DEFINED...'
*****

```

IFBNT_TOKEN provides a DSECT to map the returned token area.

IFBNT_LOGREC_NAME_PTR contains the address of the logrec data set name.

IFBNT_LOGREC provides a DSECT to map the logrec recording medium.

IFBNT_LOGREC_NAME contains the name of the installation-defined logrec data set or no data set name, if the recording medium is other than a data set.

```

                TITLE 'DSNLOGREC Name/Token Retrieve Example Routine'
IFBNTXMP AMODE 31
IFBNTXMP RMODE ANY
IFBNTXMP CSECT
                BAKR R14,0                Save calling program's
*                                           registers and return location
                LR R12,R15                Establish base ref
                USING IFBNTXMP,R12        Set addressability
                MODID BRANCH=YES
*****
* Initialize the NAME field
*****
                MVC NAME,IFBNT_DSNLOGREC  Request DSNLOGREC name
*****
* System level DSNLOGREC Retrieve example
*****
                LOAD EP=IEANTRT           Get address of IEANTRT routine
                LR R15,R0                  Set address for Call
                CALL (15),(LEVEL,NAME,TOKEN,RETCODE)
*
                LA R15,IEANT_OK           Get successful return code value
                C R15,RETCODE             Was TOKEN Returned?
                BNE ABEND                  No, Go ABEND
                EJECT
*****
* Get the installation specified LOGREC data set name
*****
                LA R2,TOKEN                Set pointer to TOKEN area
                USING IFBNT_TOKEN,R2       Set addressability
*                                           DSNLOGREC TOKEN area
                L R2,IFBNT_LOGREC_NAME_PTR Get pointer to data set name
                DROP R2                    Free up register 2
                USING IFBNT_LOGREC,R2     Set addressability to
*                                           LOGREC data set name area
*****
* If you are interested in obtaining the log stream name, reference
* IFBNT_LOGREC_LOGSTREAM instead of IFBNT_LOGREC_NAME here,
* using the MVC command to move the log stream name to your
* own program's area.
*****
                MVC LOGRNAME,IFBNT_LOGREC_NAME Move LOGREC data set name
*                                           to own area
                DROP R2                    Free up register 2
EXIT DS 0H                                         Return point
                SLR R15,R15                Set return code of zero
                PR                           Return to caller
                EJECT
ABEND ABEND X'BAD'                                ABEND if non-zero return code
                EJECT

```

```

*****
* Local working storage declares
*****

```

IEANTRT callable service

```
NAME      DS      CL16          Name for Name/Token pair
TOKEN     DS      XL16          Token for Name/Token Pair
RETCODE   DS      F            Return code from IEANTRT
LOGRNAME  DS      CL44          Area for LOGREC data set name
*
*****
* Constant and Equates
*****
LEVEL     DC      A(IEANT_SYSTEM_LEVEL)  SYSTEM LEVEL
R0        EQU     0
R1        EQU     1
R2        EQU     2
R11       EQU     11
R12       EQU     12
R13       EQU     13
R14       EQU     14
R15       EQU     15
          EJECT
*****
* NAME/TOKEN SYSTEM LEVEL DSNLOGREC VARIABLE DECLARES
*****
          IFBNTASM
          EJECT
*****
* NAME/TOKEN VARIABLE DECLARES
*****
          IEANTASM
          END    IFBNTXMP
```

Chapter 19. IEAN4CR – Create a name/token pair

Description

Call the IEAN4CR service to create a name/token pair.

Environment

The requirements for the caller are:

Environmental factor	Requirement
Minimum authorization:	Problem state, with any PSW key
Dispatchable unit mode:	Task
Cross memory mode:	Any PASN, any HASN, any SASN
AMODE:	64-bit
ASC mode:	Primary or access register (AR)
Interrupt status:	Enabled for I/O and external interrupts
Locks:	No locks held
Control parameters:	The parameter list and all parameters must reside in the caller's primary address space.

Programming requirements

Before you use name/token services, you can optionally include the IEANTASM macro to invoke name/token services equate (EQU) statements. IEANTASM provides the following constants for use in your program:

```
* Name/Token Level Constants
*
IEANT_TASK_LEVEL          EQU    1
IEANT_HOME_LEVEL         EQU    2
IEANT_PRIMARY_LEVEL      EQU    3
IEANT_SYSTEM_LEVEL       EQU    4
IEANT_TASKAUTH_LEVEL     EQU   11
IEANT_HOMEAUTH_LEVEL     EQU   12
IEANT_PRIMARYAUTH_LEVEL  EQU   13
*
* Name/Token Persistence Constants
*
IEANT_NOPERSIST          EQU    0
IEANT_PERSIST           EQU    1
IEANT_NOCHECKPOINT      EQU    0
IEANT_CHECKPOINTOK      EQU    2
*
* Name/Token Return Code Constants
*
IEANT_OK                 EQU    0
IEANT_DUP_NAME           EQU    4
IEANT_NOT_FOUND          EQU    4
IEANT_24BITMODE          EQU    8
IEANT_NOT_AUTH           EQU   16
IEANT_SRB_MODE           EQU   20
IEANT_LOCK_HELD         EQU   24
IEANT_LEVEL_INVALID     EQU   28
IEANT_NAME_INVALID      EQU   32
IEANT_PERSIST_INVALID   EQU   36
IEANT_AR_INVALID        EQU   40
IEANT_UNEXPECTED_ERR    EQU   64
```

Restrictions

None.

Input register information

Before issuing the IEAN4CR callable service, the caller does not have to place any information into any register unless using it in register notation for a particular parameter, or using it as a base register.

Output register information

When control returns to the caller, the general purpose registers (GPRs) contain:

Register Contents

0-1
Used as work registers by the system

2-13
Unchanged

14
Used as a work register by the system

15
Return code

When control returns to the caller, the access registers (ARs) contain:

Register Contents

0-1
Used as work registers by the system

2-13
Unchanged

14-15
Used as work registers by the system

Some callers depend on register contents remaining the same before and after issuing a service. If the system changes the contents of registers on which the caller depends, the caller must save them before issuing the service, and restore them after the system returns control.

Performance implications

None.

Syntax

Write the call as shown on the syntax diagram. You must code all parameters on the CALL statement in the order shown.

Syntax	Description
SYSSTATE AMODE64=YES	

Syntax	Description
CALL IEAN4CR	,(level ,user_name ,user_token ,persist_option ,return_code)

Link edit your program with a linkage-assist routine (also called a stub) in SYS1.CSSLIB unless you use one of the following techniques as an alternative to CALL IEAN4CR:

```

1.  LOAD EP=IEAN4CR
    Save the 8-byte entry point address with bit 63 changed to 0
    ...
    Put the saved entry point address with bit 63 changed to 0 into 64-bit R15
    CALL (15),(...)

2.  LLGT 15,X'10'
    L    15,X'220'(15,0)
    L    15,X'14'(15,0)
    L    15,X'7C'(15,0)
    CALL (15),(...)

```

Both of these alternate techniques require verification that the IEAN4CR service is available (in the CVT, bit CVTZOS_V1R11 is on indicating that the program is running on z/OS V1R11 or a later release).

Parameters

The parameters are explained as follows:

(level

Specifies a fullword that contains an integer indicating the level of the name/token pair:

- 1 - Task
- 2 - Home address space
- 3 - Primary address space.

,user_name

Specifies the 16-byte area containing the name of the name/token pair that the user creates. The bytes of the name may have any value. The name may contain blanks, integers, or addresses.

Names must be unique within a level. Here are some examples.

- Two task-level name/token pairs owned by the same task cannot have the same name. However, two task-level name/token pairs owned by different tasks can have the same name.
- Two home-address-space-level name/token pairs in the same address space cannot have the same name. However, two home-address-space-level name/token pairs in different address spaces can have the same name.

Because of these unique requirements you must avoid using the same names that IBM uses for name/token pairs. Do not use the following names:

- Names that begin with A through I
- Names that begin with X'00'.

,user_token

Specifies the 16-byte area containing the token of the name/token pair that the user creates.

,persist_option

Specifies a fullword that contains an integer indicating if Checkpoint/Restart can be issued if the program has this task-level name/token pair.

IEAN4CR callable service

- 0 - checkpoint is not permitted
- 2 - checkpoint is permitted.

Note: Only task-level name/token pairs can permit checkpoint. You must specify 0 for all other levels.

,return_code)

Specifies a fullword to contain the return code from the IEAN4CR service.

ABEND codes

The caller might encounter abend X'AC7' with a reason code of either X'00030000' or X'00030001'. See [z/OS MVS System Codes](#) for an explanation and responses for these codes.

Return and reason codes

When IEAN4CR returns control to your program, GPR 15 and *return_code* contain a return code. The following table identifies return codes in hexadecimal and decimal, tells what each means, and recommends an action that you should take:

Hexadecimal Return Code	Decimal Return Code	Meaning and Action
00	0	Meaning: The operation was successful. Action: None.
04	4	Meaning: The <i>user_name</i> specified already exists. Action: Choose a different <i>user_name</i> .
08	8	Meaning: The request is rejected because the caller is in 24-bit addressing mode. Action: Change your program to 64-bit addressing mode.
10	16	Meaning: An unauthorized caller attempted to create a system-level name/token pair. Action: Check which level of name/token pair you are creating.
18	24	Meaning: The caller held locks. Action: Release all locks before issuing IEAN4CR.
1C	28	Meaning: The caller specified an incorrect <i>level</i> . Action: Respecify the correct <i>level</i> . Valid values are 1, 2, or 3.
20	32	Meaning: The caller specified an incorrect <i>user_name</i> . Action: Respecify the correct <i>user_name</i> .
24	36	Meaning: The caller specified an incorrect <i>persist_option</i> . Action: <ul style="list-style-type: none">• For task-level name/token pairs, you must specify zero or two for the <i>persist_option</i>.• For home or primary address space level name/token pairs, you must specify zero for the <i>persist_option</i>.

Hexadecimal Return Code	Decimal Return Code	Meaning and Action
28	40	Meaning: The caller was in AR ASC mode and AR1 was not zero. Action: Change your program to primary mode or make sure the parameter list is in the primary address space.
40	64	Meaning: A system error occurred while handling the request. Action: Retry the request.

Chapter 20. IEAN4DL – Delete a name/token pair

Description

Call the IEAN4DL service to delete a name/token pair.

Environment

The requirements for the caller are:

Environmental factor	Requirement
Minimum authorization:	Problem state and any PSW key Note: Problem-state programs with PSW key 8 - 15 cannot delete name/token pairs created by supervisor-state or PSW key 0 - 7 programs.
Dispatchable unit mode:	Task
Cross memory mode:	Any PASN, any HASN, any SASN
AMODE:	64-bit
ASC mode:	Primary or access register (AR)
Interrupt status:	Enabled for I/O and external interrupts
Locks:	No locks held
Control parameters:	The parameter list and all parameters must reside in the caller's primary address space.

Programming requirements

Before you use name/token services, you can optionally include the IEANTASM macro to invoke name/token services equate (EQU) statements. IEANTASM provides the following constants for use in your program:

```
* Name/Token Level Constants
*
IEANT_TASK_LEVEL      EQU    1
IEANT_HOME_LEVEL     EQU    2
IEANT_PRIMARY_LEVEL  EQU    3
IEANT_SYSTEM_LEVEL   EQU    4
IEANT_TASKAUTH_LEVEL EQU   11
IEANT_HOMEAUTH_LEVEL EQU   12
IEANT_PRIMARYAUTH_LEVEL EQU  13
*
* Name/Token Persistence Constants
*
IEANT_NOPERSIST      EQU    0
IEANT_PERSIST       EQU    1
*
* Name/Token Return Code Constants
*
IEANT_OK              EQU    0
IEANT_DUP_NAME        EQU    4
IEANT_NOT_FOUND       EQU    4
IEANT_24BITMODE      EQU    8
IEANT_NOT_AUTH        EQU   16
IEANT_SRB_MODE        EQU   20
IEANT_LOCK_HELD      EQU   24
IEANT_LEVEL_INVALID  EQU   28
IEANT_NAME_INVALID   EQU   32
IEANT_PERSIST_INVALID EQU   36
```

IEAN4DL callable service

IEANT_AR_INVALID	EQU	40
IEANT_UNEXPECTED_ERR	EQU	64

Restrictions

None.

Input register information

Before issuing the IEAN4DL callable service, the caller does not have to place any information into any register unless using it in register notation for a particular parameter, or using it as a base register.

Output register information

When control returns to the caller, the general purpose registers (GPRs) contain:

Register

Contents

0-1

Used as work registers by the system

2-13

Unchanged

14

Used as a work register by the system

15

Return code

When control returns to the caller, the access registers (ARs) contain:

Register

Contents

0-1

Used as work registers by the system

2-13

Unchanged

14-15

Used as work registers by the system

Some callers depend on register contents remaining the same before and after issuing a service. If the system changes the contents of registers on which the caller depends, the caller must save them before issuing the service, and restore them after the system returns control.

Performance implications

None.

Syntax

Write the call as shown on the syntax diagram. You must code all parameters on the CALL statement in the order shown.

Syntax	Description
SYSSTATE AMODE64=YES	

Syntax	Description
CALL IEAN4DL	,(level ,user_name ,return_code)

Link edit your program with a linkage-assist routine (also called a stub) in SYS1.CSSLIB unless you use one of the following techniques as an alternative to CALL IEAN4DL:

1. LOAD EP=IEAN4DL
Save the 8-byte entry point address with bit 63 changed to 0
...
Put the saved entry point address with bit 63 changed to 0 into 64-bit R15
CALL (15),(...)
2. LLGT 15,X'10'
L 15,X'220'(15,0)
L 15,X'14'(15,0)
L 15,X'84'(15,0)
CALL (15),(...)

Both of these alternate techniques require verification that the IEAN4DL service is available (in the CVT, bit CVTZOS_V1R11 is on indicating that the program is running on z/OS V1R11 or a later release).

Parameters

The parameters are explained as follows:

(level

Specifies a fullword that contains an integer indicating the level of the name/token pair you wish to delete:

- 1 - Task
- 2 - Home address space
- 3 - Primary address space.

,user_name

Specifies the 16-byte area containing the name of the name/token pair to be deleted.

,return_code)

Specifies a fullword to contain the return code from the IEAN4DL service.

ABEND codes

The caller might encounter abend X'AC7' with a reason code of either X'00030000' or X'00030001'. See [z/OS MVS System Codes](#) for an explanation and responses to these codes.

Return and reason codes

When IEAN4DL returns control to your program, GPR 15 and *return_code* contain a return code. The following table identifies return codes in hexadecimal and decimal, tells what each means, and recommends an action that you should take:

Hexadecimal Return Code	Decimal Return Code	Meaning and Action
00	0	Meaning: The operation was successful. Action: None.

Hexadecimal Return Code	Decimal Return Code	Meaning and Action
04	4	<p>Meaning: The request is rejected because the system could not find the requested name/token pair.</p> <p>Action: Check the <i>user_name</i> you specified.</p>
08	8	<p>Meaning: The request is rejected because the caller is in 24-bit addressing mode.</p> <p>Action: Change your program to 64-bit addressing mode.</p>
10	16	<p>Meaning: An unauthorized caller attempted to delete a system-level name/token pair or a name/token pair created by an authorized program.</p> <p>Action: Check which level of name/token pair you are deleting.</p>
18	24	<p>Meaning: The caller held locks.</p> <p>Action: Release all locks before issuing IEAN4DL.</p>
1C	28	<p>Meaning: The caller specified an incorrect <i>level</i>.</p> <p>Action: Respecify the correct <i>level</i>. Valid values are 1, 2, or 3.</p>
20	32	<p>Meaning: The caller specified an incorrect <i>user_name</i>.</p> <p>Action: Respecify the correct <i>user_name</i>.</p>
28	40	<p>Meaning: The caller was in AR ASC mode and AR1 was not zero.</p> <p>Action: Change your program to primary mode or make sure the parameter list is in the primary address space.</p>
40	64	<p>Meaning: A system error occurred while handling the request.</p> <p>Action: Retry the request.</p>

Chapter 21. IEAN4RT – Retrieve the token from a name/token pair

Description

Call the IEAN4RT service to retrieve the token from a name/token pair. For example, you can use IEAN4RT to obtain the name of the logrec recording medium, which is either the name of the logrec data set or the name of the logrec log stream.

Environment

The requirements for the caller are:

Environmental factor	Requirement
Minimum authorization:	Problem state and any PSW key
Dispatchable unit mode:	Task
Cross memory mode:	Any PASN, any HASN, any SASN
AMODE:	64-bit
ASC mode:	Primary or access register (AR)
Interrupt status:	Enabled for I/O and external interrupts
Locks:	The caller can hold a local, CML, or CMS lock; however, no locks are required.
Control parameters:	The parameter list and all parameters must reside in the caller's primary address space.

Programming requirements

Before you use name/token services, you can optionally include macro IEANTASM to invoke name/token services equate (EQU) statements. IEANTASM provides the following constants for use in your program:

```
* Name/Token Level Constants
*
IEANT_TASK_LEVEL          EQU    1
IEANT_HOME_LEVEL         EQU    2
IEANT_PRIMARY_LEVEL      EQU    3
IEANT_SYSTEM_LEVEL      EQU    4
IEANT_TASKAUTH_LEVEL     EQU   11
IEANT_HOMEAUTH_LEVEL     EQU   12
IEANT_PRIMARYAUTH_LEVEL  EQU   13
*
* Name/Token Persistence Constants
*
IEANT_NOPERSIST          EQU    0
IEANT_PERSIST           EQU    1
*
* Name/Token Return Code Constants
*
IEANT_OK                 EQU    0
IEANT_DUP_NAME           EQU    4
IEANT_NOT_FOUND         EQU    4
IEANT_24BITMODE         EQU    8
IEANT_NOT_AUTH          EQU   16
IEANT_SRB_MODE          EQU   20
IEANT_LOCK_HELD         EQU   24
IEANT_LEVEL_INVALID     EQU   28
IEANT_NAME_INVALID      EQU   32
IEANT_PERSIST_INVALID   EQU   36
```

IEAN4RT callable service

IEANT_AR_INVALID	EQU	40
IEANT_UNEXPECTED_ERR	EQU	64

To obtain the name of the logrec data set or the name of the logrec log stream, you can include the IFBNTASM macro, as well as the IEANTASM macro, in your program. See [“Example 2” on page 168](#) for the list of definitions IFBNTASM provides.

Restrictions

Do not call the IEAN4RT callable service with the *user_name* and *user_token* parameters in the same storage location.

Input register information

Before issuing the IEAN4RT callable service, the caller does not have to place any information into any register unless using it in register notation for a particular parameter, or using it as a base register.

Output register information

When control returns to the caller, the general purpose registers (GPRs) contain:

Register Contents

0-1
Used as work registers by the system

2-13
Unchanged

14
Used as a work register by the system

15
Return code

When control returns to the caller, the access registers (ARs) contain:

Register Contents

0-1
Used as work registers by the system

2-13
Unchanged

14-15
Used as work registers by the system

Some callers depend on register contents remaining the same before and after issuing a service. If the system changes the contents of registers on which the caller depends, the caller must save them before issuing the service, and restore them after the system returns control.

Performance implications

None.

Syntax

Write the call as shown on the syntax diagram. You must code all parameters on the CALL statement in the order shown.

Syntax	Description
SYSSTATE AMODE64=YES	

Syntax	Description
CALL IEAN4RT	,(level ,user_name ,user_token ,return_code)

Link edit your program with a linkage-assist routine (also called a stub) in SYS1.CSSLIB unless you use one of the following techniques as an alternative to CALL IEAN4RT:

```

1.  LOAD EP=IEAN4RT
    Save the 8-byte entry point address with bit 63 changed to 0
    ...
    Put the saved entry point address with bit 63 changed to 0 into 64-bit R15
    CALL (15),(...)

2.  LLGT 15,X'10'
    L    15,X'220'(15,0)
    L    15,X'14'(15,0)
    L    15,X'80'(15,0)
    CALL (15),(...)

```

Both of these alternate techniques require verification that the IEAN4RT service is available (in the CVT, bit CVTZOS_V1R11 is on indicating that the program is running on z/OS V1R11 or a later release).

Parameters

The parameters are explained as follows:

(level

Specifies a fullword that contains an integer indicating the level of the name/token pair from which you want to retrieve the token:

- 1 - Task
- 2 - Home address space
- 3 - Primary address space
- 4 - System.

,user_name

Specifies the 16-byte area containing the name of the requested name/token pair.

,user_token

Specifies the 16-byte area to contain the token of the requested name/token pair.

,return_code)

Specifies a fullword to contain the return code from the IEAN4RT service.

ABEND codes

None.

Return and reason codes

When IEAN4RT returns control to your program, GPR 15 and *return_code* contain a return code. The following table identifies return codes in hexadecimal and decimal, tells what each means, and recommends an action that you should take:

Hexadecimal Return Code	Decimal Return Code	Meaning and Action
00	0	Meaning: The operation was successful. Action: None.
04	4	Meaning: The request is rejected because the system could not find the requested name/token pair. Action: Check the <i>user_name</i> you specified.
08	8	Meaning: The request is rejected because the caller is in 24-bit addressing mode. Action: Change your program to 64-bit addressing mode.
1C	28	Meaning: The caller specified an incorrect <i>level</i> . Action: Respecify the correct <i>level</i> . Valid values are 1, 2, 3, or 4.
40	64	Meaning: A system error occurred while handling the request. Action: Retry the request.

Chapter 22. IEATDUMP – Transaction dump request

Description

Transaction dump is a service used to request an unformatted dump of virtual storage to a data set, similar to a SYSDUMP. It is invoked with the IEATDUMP assembler macro, which issues SVC 51. The service is available to both authorized and unauthorized callers; however, not all functions are available to unauthorized callers. If an unauthorized caller requests a transaction dump with authorized keywords, the request will be rejected and message IEA820I will be issued indicating this condition. The transaction dump can be written to one or more automatically allocated data sets by specifying a data set name pattern, similar to the pattern used for the operator DUMPDS NAME=parameter. Automatic allocation reduces the exposure that a dump is truncated because of space constraints, and is done using the generic allocation unit name of SYSALLDA. When a dump is written, messages IEA822I or IEA827I are issued indicating whether the dump is complete or partial.

When a transaction dump is written, a dump directory record describing the dump may be written. The dump directory to be used is specified on the dump request using the IDX keyword. If no dump directory is specified on the request, the directory allocated to IPCSDDIR in the current job step will be used. If no dump directory is specified and IPCSDDIR is not allocated, no record describing the dump will be written.

Dump suppression occurs using symptoms available in the current SDWA or a symptom string may be provided (via the SYMREC keyword). If a symptom string is provided and an SDWA exists, the symptom string is used for suppression purposes. Statistics for dump suppression are contained in the DAE data set and are not differentiated from SYSDUMPs. If a dump is requested but not taken because it was suppressed, message IEA820I is issued indicating this condition.

Environment

The requirements for the caller are:

Environmental factor	Requirement
Minimum authorization:	Problem state and PSW key 8-15. Use of some keywords is restricted to authorized callers (supervisor state, PSW key 0-7 or APF-authorized).
Dispatchable unit mode:	Task
Cross memory mode:	PASN=HASN=SASN
AMODE:	24- or 31-bit
ASC mode:	Primary or access register (AR)
Interrupt status:	Enabled for I/O and external interrupts
Locks:	The caller must not hold any locks.
Control parameters:	Control parameters must be in the primary address space or, for AR-mode callers, must be in an address/data space that is addressable through a public entry on the caller's dispatchable unit access list (DU-AL). The caller-provided title, data set name, dump index name, symptom record, incident token, problem description area and storage list area all have the same requirements and restrictions as the control parameters.

Programming requirements

None.

Restrictions

The caller may not have any FRRs established.

An IEATDUMP cannot succeed when another process within the task is exclusively holding the SYSZTIOT enqueue. Instead, a SVC dump would probably occur.

Input register information

Before issuing the IEATDUMP macro, the caller does not have to place any information into any general purpose register (GPR) unless using it in register notation for a particular parameter, or using it as a base register.

Before issuing the IEATDUMP macro, the caller does not have to place any information into any access register (AR) unless using it in register notation for a particular parameter, or using it as a base register.

Output register information

When control returns to the caller, the GPRs contain:

Register

Contents

0

Reason code

1

Used as a work register by the system

2-14

Unchanged

15

Return code

When control returns to the caller, the ARs contain:

Register

Contents

0-1

Used as work registers by the system

2-13

Unchanged

14-15

Used as work registers by the system

Performance implications

None.

Syntax

The parameters DCB, DCBAD, and ASYNC=YES are no longer supported.

The IEATDUMP macro is written as follows:

Syntax	Description
<i>name</i>	<i>name</i> : symbol. Begin <i>name</i> in column 1.

Syntax	Description
␣	One or more blanks must precede IEATDUMP.
IEATDUMP	
␣	One or more blanks must follow IEATDUMP.
DSNAD= <i>dsnad</i>	<i>dsnad</i> : RS-type address or register (2) - (12).
DSN= <i>dsn</i>	<i>dsn</i> : RS-type address or register (2) - (12).
DDNAME= <i>ddname</i>	<i>ddname</i> : RS-type address or register (2) - (12).
DSNTEST=NO	Default: DSNTEST=NO
DSNTEST=YES	
,HDRAD= <i>hdrad</i>	<i>hdrad</i> : RS-type address or register (2) - (12).
,HDR= <i>hdr</i>	<i>hdr</i> : RS-type address or register (2) - (12).
,IDXAD= <i>idxad</i>	<i>idxad</i> : RS-type address or register (2) - (12).
,IDX= <i>idx</i>	<i>idx</i> : RS-type address or register (2) - (12).
,SYMRECAD= <i>symrecad</i>	<i>symrecad</i> : RS-type address or register (2) - (12).
,SYMREC= <i>symrec</i>	<i>symrec</i> : RS-type address or register (2) - (12).
,INTOKENAD= <i>intokenad</i>	<i>intokenad</i> : RS-type address or register (2) - (12).
,INTOKEN= <i>intoken</i>	<i>intoken</i> : RS-type address or register (2) - (12).
,PROBDESCAD= <i>probdescad</i>	<i>probdescad</i> : RS-type address or register (2) - (12).
,PROBDESC= <i>probdesc</i>	<i>probdesc</i> : RS-type address or register (2) - (12).
,LISTAD= <i>listad</i>	<i>listad</i> : RS-type address or register (2) - (12).
,LIST= <i>list</i>	<i>list</i> : RS-type address or register (2) - (12).
,SUBPLSTAD= <i>subplstad</i>	<i>subplstad</i> : RS-type address or register (2) - (12).
,SUBPLST= <i>subplst</i>	<i>subplst</i> : RS-type address or register (2) - (12).
,DSPLISTAD= <i>dsplistad</i>	<i>dsplistad</i> : RS-type address or register (2) - (12).

IEATDUMP transaction dump

Syntax	Description
,DSPLIST= <i>dsplist</i>	<i>dsplist</i> : RS-type address or register (2) - (12).
,SDATA= <u>DEFS</u>	Default: SDATA=DEFS
,SDATA=ALLNUC	
,SDATA=CSA	
,SDATA=GRSQ	
,SDATA=LPA	
,SDATA=LSQA	
,SDATA=NUC	
,SDATA=RGN	
,SDATA=SQA	
,SDATA=SUM	
,SDATA=SWA	
,SDATA=TRT	
,SDATA=PSA	
,ASYNC= <u>NO</u>	Default: ASYNC=NO
,ECBAD= <i>ecbad</i>	<i>ecbad</i> : RS-type address or register (2) - (12).
,ECB= <i>ecb</i>	<i>ecb</i> : RS-type address or register (2) - (12).
,RETCODE= <i>retcode</i>	<i>retcode</i> : RS-type address or register (2) - (12).
,RSNCODE= <i>rsncode</i>	<i>rsncode</i> : RS-type address or register (2) - (12).
,PLISTVER= <u>IMPLIED_VERSION</u>	Default: PLISTVER=IMPLIED_VERSION
,PLISTVER=MAX	
,PLISTVER=1	
,MF= <u>S</u>	Default: MF=S
,MF=(L, <i>list addr</i>)	<i>list addr</i> : RS-type address or register (1) - (12).
,MF=(L, <i>list addr,attr</i>)	
,MF=(L, <i>list addr,0D</i>)	
,MF=(E, <i>list addr</i>)	
,MF=(E, <i>list addr,COMPLETE</i>)	

Syntax	Description
,MF=(E, <i>list addr</i> ,NOCHECK)	
,MF=(M, <i>list addr</i>)	
,MF=(M, <i>list addr</i> ,COMPLETE)	
,MF=(M, <i>list addr</i> ,NOCHECK)	

Parameters

The parameters DCB, DCBAD, and ASYNC=YES are no longer supported, and are removed from this information.

The parameters are explained as follows:

name

An optional symbol, starting in column 1, that is the name on the IEATDUMP macro invocation. The name must conform to the rules for an ordinary assembler language symbol.

DSNAD=dsnad

DSN=dsn

DDNAME=ddname

A required input parameter. The output dump data set should have the attributes of RECFM=FB and LRECL=4160.

DSNAD=dsnad

A 4-byte field which contains the address of the area of the name pattern used to create the data set that is to contain the dump. The format of the area is described in the DSN field which follows.

To code: Specify the RS-type address, or address in register (2) - (12), of a pointer field.

DSN=dsn

A 2- to 101-character input area that contains the name pattern used to create the data set that is to contain the dump. The format of the area begins with a single byte specifying the length of the name pattern, which must not be greater than 100. The name pattern immediately follows that byte. The name pattern has a series of attributes: it is similar to that used by the operator DUMPDS NAME= parameter, except that &SEQ is not supported, and there is no default name pattern available; the use of system symbols is supported; and it must resolve to a valid data set name which can be allocated from the caller's task. When used with the REMOTE= parameter, the generated name must be unique for each requested address space (&JOBNAME is one recommended addition to the pattern to accomplish this).

In addition, IEATDUMP also recognizes the symbol &DS. (Dump Section) on the end of the name pattern. When present, IEATDUMP allocates the first data set for dumping, ending with "001". If this runs out of disk space or uses up all 16 extents before the dump is completed, dumping will be continued to data sets with the same name, but ending in "002","003", and so on, until the entire dump is written. Each of these data sets are allocated with a primary extent size of 500M and a secondary extent size of 500M, but it is possible to change these values by providing ACS routines that are driven by DFSMS.

Remember to combine all of the data sets into one data set by using IPCS COPYDUMP, before using IPCS to view the diagnostic data.

To code: Specify the RS-type address, or address in register (2) - (12), of a 2- to 101-character field.

DDNAME=ddname

An 8-character input field that is the name of the DD representing the data set that is to contain the dump. The DD must be allocated when IEATDUMP is invoked. The system will open this DD.

To code: Specify the RS-type address, or address in register (2) - (12), of an 8-character field.

DSNTEST={NO|YES}

An optional keyword input that determines whether a Transaction dump will be attempted, or that only the DSN or DSNAD specified name pattern will be tested. On systems without the support, executing programs run as if DSNTEST=NO was specified. The RtctDsnTest bit of the IHARTCT macro will indicate if the support is available.

DEFAULT=NO**DSNTEST=NO**

The default specifying that a Transaction dump should be attempted. Processing is identical to that when the parameter is not specified.

DSNTEST=YES

Transaction dump processing should only attempt to allocate the data set using the DSN or DSNAD specified name pattern

,HDRAD=hdrad**,HDR=hdr**

A required input parameter.

,HDRAD=hdrad

A 4-byte field which contains the address of a parameter of the dump title. The format of the area is a single byte specifying the length of the title followed by the title itself.

To code: Specify the RS-type address, or address in register (2) - (12), of a pointer field.

,HDR=hdr

A 2- to 101-character input area that contains the dump title. The format of the area is a single byte specifying the length of the title followed by the title itself. The title has a maximum length of 100 characters.

To code: Specify the RS-type address, or address in register (2) - (12), of a 2- to 101-character field.

,IDXAD=idxad**,IDX=idx**

An optional input parameter.

,IDXAD=idxad

A 4-byte field which contains the address of a parameter of an area that contains the name of the dump index which is to contain information about the dump after the dump is written. The format of the area is a single byte specifying the length of the dump index data set name followed by the name itself. The data set must be an existing IPCS dump directory. The data set will be allocated from the caller's address space.

To code: Specify the RS-type address, or address in register (2) - (12), of a pointer field.

,IDX=idx

A 2- to 45-character input area that contains the name of the dump index which is to contain information about the dump after the dump is written. The format of the area is a single byte specifying the length of the dump index data set name followed by the name itself. The name of the dump index data set has a maximum length of 44 characters. The data set must be an existing IPCS dump directory. The data set will be allocated from the caller's address space.

To code: Specify the RS-type address, or address in register (2) - (12), of a 2- to 45-character field.

,SYMRECAD=symrecad**,SYMREC=symrec**

An optional input parameter.

,SYMRECAD=symrecad

A 4-byte field which contains the address of a parameter of a valid symptom record for DAE to use for dump suppression. This area is built using SYMRBLD and mapped by ADSR. This area has a maximum length of 1900 bytes.

To code: Specify the RS-type address, or address in register (2) - (12), of a pointer field.

,SYMREC=*symrec*

A parameter of a valid symptom record for DAE to use for dump suppression. This area is built using SYMRBLD and mapped by ADSR. This area has a maximum length of 1900 bytes.

To code: Specify the RS-type address, or address in register (2) - (12), of a character field.

,INTOKENAD=*intokenad*

,INTOKEN=*intoken*

An optional input parameter.

,INTOKENAD=*intokenad*

A 4-byte field which contains the address of a parameter of a 32-byte area that contains an incident token previously built by the IEAINTKN macro.

To code: Specify the RS-type address, or address in register (2) - (12), of a pointer field.

,INTOKEN=*intoken*

A parameter of a 32-byte area that contains an incident token previously built by the IEAINTKN macro.

To code: Specify the RS-type address, or address in register (2) - (12), of a 32-character field.

,PROBDESCAD=*probdescad*

,PROBDESC=*probdesc*

An optional input parameter.

,PROBDESCAD=*probdescad*

A 4-byte field which contains the address of a parameter of an area that contains information describing the problem. This area has a maximum length of 1024 bytes.

To code: Specify the RS-type address, or address in register (2) - (12), of a pointer field.

,PROBDESC=*probdesc*

A parameter of an area that contains information describing the problem. This area has a maximum length of 1024 bytes.

To code: Specify the RS-type address, or address in register (2) - (12), of a character field.

,LISTAD=*listad*

,LIST=*list*

An optional input parameter.

,LISTAD=*listad*

A 4-byte field which contains the address of a parameter of a list of starting and ending addresses of areas to be dumped. The high-order bit of the last ending address is set to 1; the high-order bit of all other addresses is 0. This area has a maximum length of 240 bytes.

To code: Specify the RS-type address, or address in register (2) - (12), of a pointer field.

,LIST=*list*

A parameter of a list of starting and ending addresses of areas to be dumped. The high-order bit of the last ending address is set to 1; the high-order bit of all other addresses is 0. This area has a maximum length of 240 bytes.

To code: Specify the RS-type address, or address in register (2) - (12), of a character field.

,SUBPLSTAD=*subplstad*

,SUBPLST=*subplst*

An optional input parameter.

,SUBPLSTAD=*subplstad*

A 4-byte field which contains the address of a parameter of a list of subpool numbers to be dumped. The first halfword is the number subpools in the list and must be on a fullword boundary. Each entry is two bytes.

To code: Specify the RS-type address, or address in register (2) - (12), of a pointer field.

,SUBPLST=*subplst*

A parameter of a list of subpool numbers to be dumped. The first halfword is the number subpools in the list and must be on a fullword boundary. Each entry is two bytes.

To code: Specify the RS-type address, or address in register (2) - (12), of a character field.

,DSPLISTAD=*dsplistad***,DSPLIST=***dsplist*

An optional input parameter.

,DSPLISTAD=*dsplistad*

A 4-byte field which contains the address of a parameter of a list of data space storage to be dumped. The first word is the total size of the DSPLIST. The next eight characters is the STOKEN of the data space to be dumped. A full word indicates the number of ranges to be dumped for that STOKEN. Then, 2 full words for each range, which are the starting and ending addresses of the range. More than one STOKEN may be specified per DSPLIST.

To code: Specify the RS-type address, or address in register (2) - (12), of a pointer field.

,DSPLIST=*dsplist*

A parameter of a list of data space storage to be dumped. The first word is the total size of the DSPLIST. The next eight characters is the STOKEN of the data space to be dumped. A full word indicates the number of ranges to be dumped for that STOKEN. Then, 2 full words for each range, which are the starting and ending addresses of the range. More than one STOKEN may be specified per DSPLIST.

To code: Specify the RS-type address, or address in register (2) - (12), of a character field.

,SDATA=DEFS**,SDATA=**ALLNUC**,SDATA=**CSA**,SDATA=**GRSQ**,SDATA=**LPA**,SDATA=**LSQA**,SDATA=**NUC**,SDATA=**RGN**,SDATA=**SQA**,SDATA=**SUM**,SDATA=**SWA**,SDATA=**TRT**,SDATA=**PSA

An optional parameter that specifies what system data should be provided in the transaction dump. No fetch-protected storage which is inaccessible in the caller's key will be dumped. The default is SDATA=DEFS.

,SDATA=DEFS

The following SDATA options are included in the dump: LSQA, NUC, PSA, RGN, SQA, SUM, SWA, and TRT.

,SDATA=ALLNUC

All of DAT-on nucleus, including page-protected areas, and all of the DAT-off nucleus.

,SDATA=CSA

Common storage area and virtual storage for 64-bit addressable memory objects created using one of the following services:

- IARV64 REQUEST=GETCOMMON, DUMP=LIKECSA
- IARCP64 COMMON=YES, DUMP=LIKECSA
- IARST64 COMMON=YES, TYPE=PAGEABLE

,SDATA=GRSQ

Global resource serialization (ENQ/DEQ/RESERVE) queues.

,SDATA=LPA

Link pack area for this job.

,SDATA=LSQA

Local system queue area and virtual storage for 64-bit addressable memory objects created using one of the following services:

- IARV64 REQUEST=GETSTOR , DUMP=LIKELSQA
- IARCP64 COMMON=NO , DUMP=LIKELSQA
- IARST64 COMMON=NO

,SDATA=NUC

Non-page-protected areas of the DAT-on nucleus.

,SDATA=RGN

Entire private area including virtual storage for 64-bit addressable memory objects created using the following services:

- IARV64 REQUEST=GETSTOR , DUMP=LIKERGN
- IARV64 REQUEST=GETSTOR , SVCDUMPRGN=YES
- IARCP64 COMMON=NO , DUMP=LIKERGN
- IARST64 COMMON=NO

,SDATA=SQA

System queue area and virtual storage for 64-bit addressable memory objects created using one of the following services:

- IARV64 REQUEST=GETCOMMON , DUMP=LIKESQA
- IARCP64 COMMON=YES , DUMP=LIKESQA
- IARST64 COMMON=YES , TYPE=FIXED
- IARST64 COMMON=YES , TYPE=DREF

,SDATA=SUM

Requests the summary dump function.

,SDATA=SWA

Scheduler work area.

,SDATA=TRT

System trace data.

,SDATA=PSA

Prefixed save area.

One or more values may be specified for the SDATA parameter. If more than one value is specified, group the values within parentheses.

,ASYNC=NO

An optional parameter that specifies whether the transaction dump should be taken synchronously. The default is ASYNC=NO.

,ASYNC=NO

The transaction dump should be taken synchronously.

,ECBAD=ecbad**,ECB=ecb**

An optional input parameter.

,ECBAD=ecbad

A 4-byte field which contains the address of a parameter of an ECB to be posted when the entire dump has been written. This area must be on a word boundary.

To code: Specify the RS-type address, or address in register (2) - (12), of a pointer field.

,ECB=ecb

A parameter of an ECB to be posted when the entire dump has been written. This area must be on a word boundary.

To code: Specify the RS-type address, or address in register (2) - (12), of a 4-character field.

,RETCODE=retcode

An optional output parameter into which the return code is to be copied from GPR 15.

To code: Specify the RS-type address of a fullword field, or register (2) - (12).

,RSNCODE=rsncode

An optional output parameter into which the reason code is to be copied from GPR 0.

To code: Specify the RS-type address of a fullword field, or register (2) - (12).

,PLISTVER=IMPLIED_VERSION**,PLISTVER=MAX****,PLISTVER=1**

An optional input parameter that specifies the version of the macro. PLISTVER determines which parameter list the system generates. PLISTVER is an optional input parameter on all forms of the macro, including the list form. When using PLISTVER, specify it on all macro forms used for a request and with the same value on all of the macro forms. The values are:

- **IMPLIED_VERSION**, which is the lowest version that allows all parameters specified on the request to be processed. If you omit the PLISTVER parameter, IMPLIED_VERSION is the default.
- **MAX**, if you want the parameter list to be the largest size currently possible. This size might grow from release to release and affect the amount of storage that your program needs.

If you can tolerate the size change, IBM recommends that you always specify PLISTVER=MAX on the list form of the macro. Specifying MAX ensures that the list-form parameter list is always long enough to hold all the parameters you might specify on the execute form; in this way, MAX ensures that the parameter list does not overwrite nearby storage.

- **1**, if you use the currently available parameters.

To code: Specify one of the following:

- IMPLIED_VERSION
- MAX
- A decimal value of 1

,MF=S**,MF=(L,list addr)****,MF=(L,list addr,attr)****,MF=(L,list addr,OD)****,MF=(E,list addr)****,MF=(E,list addr,COMPLETE)****,MF=(E,list addr,NOCHECK)****,MF=(M,list addr)****,MF=(M,list addr,COMPLETE)****,MF=(M,list addr,NOCHECK)**

An optional input parameter that specifies the macro form.

Use MF=S to specify the standard form of the macro, which builds an inline parameter list and generates the macro invocation to transfer control to the service. MF=S is the default.

Use MF=L to specify the list form of the macro. Use the list form together with the execute form of the macro for applications that require reentrant code. The list form defines an area of storage that the execute form uses to store the parameters. Only the PLISTVER parameter may be coded with the list form of the macro.

Use MF=E to specify the execute form of the macro. Use the execute form together with the list form of the macro for applications that require reentrant code. The execute form of the macro stores the

parameters into the storage area defined by the list form, and generates the macro invocation to transfer control to the service.

Use MF=M together with the list and execute forms of the macro for service routines that need to provide different options according to user-provided input. Use the list form to define a storage area; use the modify form to set the appropriate options; then use the execute form to call the service.

IBM recommends that you use the modify and execute forms of IEATDUMP in the following order:

- Use IEATDUMP ...MF=(M,list-addr,COMPLETE) specifying appropriate parameters, including all required ones.
- Use IEATDUMP ...MF=(M,list-addr,NOCHECK), specifying the parameters that you want to change.
- Use IEATDUMP ...MF=(E,list-addr,NOCHECK), to execute the macro.

,list addr

The name of a storage area to contain the parameters. For MF=S, MF=E, and MF=M, this can be an RS-type address or an address in register (1)-(12).

,attr

An optional 1- to 60-character input string that you use to force boundary alignment of the parameter list. Use a value of 0F to force the parameter list to a word boundary, or 0D to force the parameter list to a doubleword boundary. If you do not code *attr*, the system provides a value of 0D.

,COMPLETE

Specifies that the system is to check for required parameters and supply defaults for omitted optional parameters.

,NOCHECK

Specifies that the system is not to check for required parameters and is not to supply defaults for omitted optional parameters.

ABEND codes

None.

Return and reason codes

When the IEATDUMP macro returns control to your program:

- GPR 15 (and *retcode*, if you coded RETCODE) contains a return code.
- When the value in GPR 15 is not zero, GPR 0 (and *rsncode*, if you coded RSNCODE) contains a reason code.

X'00000000'

A complete dump was written.

X'00000004'

A partial dump was written.

X'00000008'

No dump was written.

X'0000000C'

Internal processing error. No dump was written.

X'00000010'

Unexpected return code from IEAVAD00.

Table 13. Return and Reason Codes for the IEATDUMP Macro		
Return Code	Reason Code	Meaning and Action
00000000	00000000	Meaning: A complete dump was written. Action: None.

Table 13. Return and Reason Codes for the IEATDUMP Macro (continued)

Return Code	Reason Code	Meaning and Action
00000004	00000001	Meaning: The dump was truncated because the data set was too small. Action: Reissue IEATDUMP with a larger data set or use the DSN DSNAD parameter to allocate the dump data set automatically.
00000004	00000002	Meaning: Contention detected when attempting to set tasks in the address space non-dispatchable. Action: Data in dump may be inconsistent. Reissue IEATDUMP.
00000004	00000003	Meaning: Unable to add dump data set to dump index. Action: Verify that the dump index specified on the IDX parameter is correct and reissue IEATDUMP.
00000004	00000004	Meaning: Unable to allocate transaction dump data set. Action: See allocation failure messages. Reissue IEATDUMP.
00000004	00000006	Meaning: Maximum amount of dump sections reached (999). Action: Dump less memory, or use ACS routines to increase the size of the data sets. Reissue IEATDUMP.
00000004	00000007	Meaning: The system has filled one of the range tables. Action: Dump less memory. If the problem still exists, contact the IBM Support Center.
00000004	00000008	Meaning: The data space used for the IEATDUMP has been filled. No more than 2 gigabytes of data can be collected. Action: Do one of the following: <ul style="list-style-type: none"> • Remove unnecessary dump options. • Specify smaller memory ranges. • Use the extended data set support by either: <ul style="list-style-type: none"> – Preallocating a large capacity data set and use the DDNAME parameter. – Refer to the use of the &DS symbol for the DSN parameter's data set name pattern.
00000008	00000000	Meaning: For DSNTTEST=YES, a dump data set was successfully allocated and deleted. Hence, no dump data set is available, but the pattern is useful. Typically, no dump data set is available, but the pattern should be useful. Action: The dump data set pattern resulted in the successful allocation of a data set. Normal IEATDUMP requests should not fail simply because the specified name pattern conflicts with installation conventions.
00000008	00000001	Meaning: The address of the transaction dump parameter list was zero. Action: Ensure register 1 is non-zero when the transaction dump is requested. Reissue IEATDUMP.
00000008	00000002	Meaning: The dump was suppressed by CHNGDUMP. Action: Issue CHNGDUMP SET,SYSDUMP or CHNGDUMP RESET,SYSDUMP. Reissue IEATDUMP.
00000008	00000003	Meaning: The dump was suppressed by SLIP. Action: Delete SLIP trap with SLIP DEL command. Reissue IEATDUMP.
00000008	00000004	Meaning: The ALET for the transaction dump parameter list was not valid. Action: Ensure that access register 1 has a valid ALET when the transaction dump is requested. Reissue IEATDUMP.
00000008	00000005	Meaning: The transaction dump parameter list was not addressable. Action: Ensure that the entire transaction dump parameter list is addressable via register 1 (and access register 1 if running in AR ASC mode) when the transaction dump is requested. Reissue IEATDUMP.

Table 13. Return and Reason Codes for the IEATDUMP Macro (continued)

Return Code	Reason Code	Meaning and Action
00000008	00000006	Meaning: The transaction dump parameter list version number was not valid. Action: Ensure the transaction dump request was built using the IEATDUMP macro for the system on which the dump was requested. Reissue IEATDUMP.
00000008	00000007	Meaning: The length of the transaction dump parameter list did not match the parameter list version number. Action: Ensure the transaction dump request was built using the IEATDUMP macro for the system on which the dump was requested. Reissue IEATDUMP.
00000008	00000008	Meaning: No DDNAME, DSN(AD), or DSP_STOKEN was specified. Action: Reissue IEATDUMP with the DDNAME, DSN(AD) or DSP_STOKEN keyword.
00000008	00000009	Meaning: Both DDNAME and DSN(AD) keywords were specified. Action: Reissue IEATDUMP with either the DDNAME or DSN(AD) keyword.
00000008	0000000C	Meaning: The ALET for the DSN(AD) keyword was not valid. Action: Ensure that the access register for the DSN(AD) has a valid ALET when the transaction dump is requested. Reissue IEATDUMP.
00000008	0000000D	Meaning: The DSN(AD) was not addressable. Action: Ensure that the entire DSN(AD) is addressable using the specified address (and ALET if running in AR ASC mode) when the transaction dump is requested. Reissue IEATDUMP.
00000008	0000000E	Meaning: No HDR(AD) keyword was specified. Action: Reissue IEATDUMP with the HDR(AD) keyword.
00000008	0000000F	Meaning: The ALET for the HDR(AD) keyword was not valid. Action: Ensure that the access register for the HDR(AD) has a valid ALET when the transaction dump is requested. Reissue IEATDUMP.
00000008	00000010	Meaning: The HDR(AD) was not addressable. Action: Ensure that the entire HDR(AD) is addressable using the specified address (and ALET if running in AR ASC mode) when the transaction dump is requested. Reissue IEATDUMP.
00000008	00000011	Meaning: The specified HDR(AD) was longer than 100 characters. Action: Reissue IEATDUMP with a shorter header.
00000008	00000012	Meaning: The ALET for the IDX(AD) keyword was not valid. Action: Ensure that the access register for the IDX(AD) has a valid ALET when the transaction dump is requested. Reissue IEATDUMP.
00000008	00000013	Meaning: The IDX(AD) was not addressable. Action: Ensure that the entire IDX(AD) is addressable using the specified address (and ALET if running in AR ASC mode) when the transaction dump is requested. Reissue IEATDUMP.
00000008	00000014	Meaning: The IDX(AD) keyword did not specify a valid data set name after symbol substitution. Action: Reissue IEATDUMP with an IDX keyword that resolves to a valid dump index data set name.
00000008	00000015	Meaning: The ALET for the SYMREC(AD) keyword was not valid. Action: Ensure that the access register for the SYMREC(AD) has a valid ALET when the transaction dump is requested. Reissue IEATDUMP.

IEATDUMP transaction dump

Table 13. Return and Reason Codes for the IEATDUMP Macro (continued)		
Return Code	Reason Code	Meaning and Action
00000008	00000016	Meaning: The SYMREC(AD) was not addressable. Action: Ensure that the entire SYMREC(AD) is addressable using the specified address (and ALET if running in AR ASC mode) when the transaction dump is requested. Reissue IEATDUMP.
00000008	00000017	Meaning: The specified SYMREC(AD) was not valid. Either ADSRID not set to 'SR' or primary symptom string offset or length not initialized. Action: Reissue IEATDUMP with a valid symptom record.
00000008	00000018	Meaning: The ALET for the INTOKEN(AD) keyword was not valid. Action: Ensure that the access register for the INTOKEN(AD) has a valid ALET when the transaction dump is requested. Reissue IEATDUMP.
00000008	00000019	Meaning: The INTOKEN(AD) was not addressable. Action: Ensure that the entire INTOKEN(AD) is addressable using the specified address (and ALET if running in AR ASC mode) when the transaction dump is requested. Reissue IEATDUMP.
00000008	0000001A	Meaning: The ALET for the REMOTE(AD) keyword was not valid. Action: Ensure that the access register for the REMOTE(AD) has a valid ALET when the transaction dump is requested. Reissue IEATDUMP.
00000008	0000001B	Meaning: The REMOTE(AD) was not addressable. Action: Ensure that the entire REMOTE(AD) is addressable using the specified address (and ALET if running in AR ASC mode) when the transaction dump is requested. Reissue IEATDUMP.
00000008	0000001C	Meaning: The specified REMOTE(AD) was not valid. Action: Reissue IEATDUMP with a valid remote area.
00000008	0000001D	Meaning: The ALET for the LIST(AD) keyword was not valid. Action: Ensure that the access register for the LIST(AD) has a valid ALET when the transaction dump is requested. Reissue IEATDUMP.
00000008	0000001E	Meaning: The LIST(AD) was not addressable. Action: Ensure that the entire LIST(AD) is addressable using the specified address (and ALET if running in AR ASC mode) when the transaction dump is requested. Reissue IEATDUMP.
00000008	0000001F	Meaning: The specified LIST(AD) was not valid. A range in the storage list had a start address greater than its ending address. Action: Reissue IEATDUMP with a valid storage list.
00000008	00000020	Meaning: The dump was rejected because the caller's authorization was insufficient for requested function(s). Action: Verify authorization and requested functions. Reissue IEATDUMP.
00000008	00000021	Meaning: The DSN(AD) keyword did not specify a valid data set name after symbol substitution. Action: Reissue IEATDUMP with a DSN keyword that resolves to a valid dump data set name.
00000008	00000022	Meaning: The DSN(AD) keyword specified a data set name that was too long. Action: Reissue IEATDUMP with a DSN(AD) keyword that resolves to a shorter dump data set name.
00000008	00000023	Meaning: The DSN(AD) keyword specified a data set name that contained a bad symbol. Action: Reissue IEATDUMP with a DSN(AD) keyword that does not contain bad symbols.

Table 13. Return and Reason Codes for the IEATDUMP Macro (continued)

Return Code	Reason Code	Meaning and Action
00000008	00000024	Meaning: Unable to create data space to capture transaction dump. Action: Remedy cause of DSPSERV CREATE failure or request transaction dump specifying DDNAME or including the &DS. symbol in the DSN template.
00000008	00000025	Meaning: Unable to add transaction dump data space to access list. Action: Remedy cause of ALESERV ADD failure or request transaction dump specifying DDNAME. Reissue IEATDUMP.
00000008	00000026	Meaning: Unable to allocate transaction dump data set. Action: Look at allocation failure messages. Reissue IEATDUMP.
00000008	00000027	Meaning: The transaction dump was suppressed by DAE. Action: If you do not wish transaction dumps to be suppressed on an installation basis, issue the SET DAE=xx console command specifying an ADYSETxx member that does not specify SYSMDUMP(SUPPRESS). If you do not wish transaction dumps to be suppressed on an application basis, include the VRANODAE key in the VRADATA of your recovery routine. Reissue IEATDUMP.
00000008	00000028	Meaning: An error occurred writing the first record to the data space or dump data set. Action: Ensure the STOKEN and origin for the specified data space are correctly specified. Ensure that the specified DD is allocated when the transaction dump is requested. Reissue IEATDUMP.
00000008	00000029	Meaning: The ALET for the PROBDDESC(AD) keyword was not valid. Action: Ensure that the access register for the PROBDDESC(AD) has a valid ALET when the transaction dump is requested. Reissue IEATDUMP.
00000008	0000002A	Meaning: The PROBDDESC(AD) was not addressable. Action: Ensure that the entire PROBDDESC(AD) is addressable using the specified address (and ALET if running in AR ASC mode) when the transaction dump is requested. Reissue IEATDUMP.
00000008	0000002B	Meaning: The specified PROBDDESC(AD) was not valid. Action: Reissue IEATDUMP with a valid problem description area.
00000008	0000002C	Meaning: The ALET for the SUBPLST(AD) keyword was not valid. Action: Ensure that the access register for the SUBPLST(AD) has a valid ALET when the transaction dump is requested. Reissue IEATDUMP.
00000008	0000002D	Meaning: The SUBPLST(AD) was not addressable. Action: Ensure that the entire SUBPLST(AD) is addressable using the specified address (and ALET if running in AR ASC mode) when the transaction dump is requested. Reissue IEATDUMP.
00000008	0000002E	Meaning: The specified SUBPLST(AD) was not valid. An invalid subpool was specified. Action: Reissue IEATDUMP with a valid subpool list.
00000008	0000002F	Meaning: The ALET for the DSPLIST(AD) keyword was not valid. Action: Ensure that the access register for the DSPLIST(AD) has a valid ALET when the transaction dump is requested. Reissue IEATDUMP.
00000008	00000030	Meaning: The DSPLIST(AD) was not addressable. Action: Ensure that the entire DSPLIST(AD) is addressable using the specified address (and ALET if running in AR ASC mode) when the transaction dump is requested. Reissue IEATDUMP.

IEATDUMP transaction dump

Table 13. Return and Reason Codes for the IEATDUMP Macro (continued)		
Return Code	Reason Code	Meaning and Action
00000008	00000031	Meaning: The specified DSPLIST(AD) was not valid. An invalid data space was specified. Action: Reissue IEATDUMP with a valid data space list.
00000008	00000032	Meaning: The ALET for the ECB(AD) keyword was not valid. Action: Ensure that the access register for the ECB(AD) has a valid ALET when the transaction dump is requested. Reissue IEATDUMP.
00000008	00000033	Meaning: The ECB(AD) was not addressable. Action: Ensure that the entire ECB(AD) is addressable using the specified address (and ALET if running in AR ASC mode) when the transaction dump is requested. Reissue IEATDUMP.
00000008	00000034	Meaning: The specified ECB(AD) was not valid. The ECB was not on a fullword boundary. Action: Reissue IEATDUMP with an ECB.
00000008	00000035	Meaning: OPEN failed for the dump data set. Action: Determine why OPEN failed and reissue IEATDUMP.
00000008	00000036	Meaning: Dump data set has invalid block size. Action: Correct the block size and reissue IEATDUMP.
00000008	00000037	Meaning: The DSP_RECORDS@ field was not accessible. Action: Correct the problem and reissue IEATDUMP.
00000008	00000038	Meaning: The DCB parameter is not supported on IEATDUMP. Action: Remove the DCB parameter and reissue IEATDUMP.
00000008	00000039	Meaning: The ASYNC=YES is not supported on IEATDUMP. Action: Change to ASYNC=NO and reissue IEATDUMP.
00000008	0000003A	Meaning: The &DS. symbol was found in the midst of the dump DSN name pattern. Action: Place the &DS symbol at the end of the DSN name pattern and reissue IEATDUMP.
00000008	0000003B	Meaning: This IEATDUMP was not taken because another dump was already running in the address space. Action: None.
00000008	0000003C	Meaning: For DSNTTEST=YES, a dump data set could not be allocated. Action: The dump data set name pattern specified via the DSN or DSNAD parameter resulted in a data set name that conflicts with installation conventions. Change the pattern to adhere to those conventions.
0000000C	00000001	Meaning: Unable to obtain storage for transaction dump from subpool 230 below the line. Action: Determine why storage is not available and reissue IEATDUMP.
0000000C	00000002	Meaning: Unable to establish recovery environment for transaction dump. Action: Determine why ESTSEX failed and reissue IEATDUMP.
0000000C	00000003	Meaning: Unable to obtain storage for transaction dump from subpool 245 above the line. Action: Determine why storage is not available and reissue IEATDUMP.

Table 13. Return and Reason Codes for the IEATDUMP Macro (continued)

Return Code	Reason Code	Meaning and Action
000000C	0000004	Meaning: Unable to obtain storage for transaction dump from subpool 231 above the line. Action: Determine why storage is not available and reissue IEATDUMP.
000000C	0000005	Meaning: Unable to obtain storage for transaction dump from subpool 239 above the line. Action: Determine why storage is not available and reissue IEATDUMP.
000000C	0000006	Meaning: Unable to obtain storage for transaction dump from subpool 239 above the line. Action: Determine why storage is not available and reissue IEATDUMP.
000000C	0000007	Meaning: Unable to obtain storage for transaction dump from subpool 239 above the line. Action: Determine why storage is not available and reissue IEATDUMP.
000000C	0000008	Meaning: Unable to obtain storage for transaction dump from subpool 250 above the line. Action: Determine why storage is not available and reissue IEATDUMP.
000000C	0000009	Meaning: Unable to obtain storage for transaction dump from subpool 230 above the line. Action: Determine why storage is not available and reissue IEATDUMP.
000000C	000000A	Meaning: Unable to obtain storage for transaction dump from subpool 230 below the line. Action: Determine why storage is not available and reissue IEATDUMP.
000000C	000000B	Meaning: Unable to obtain storage for transaction dump from subpool 253 above the line. Action: Determine why storage is not available and reissue IEATDUMP.
000000C	000000C	Meaning: Unable to obtain high virtual private storage for transaction dump. Action: Determine why an authorized IARV64 MEMLIMIT(NO) request failed to get storage and reissue IEATDUMP.
000000C	000000D	Meaning: Unable to obtain high virtual common storage for transaction dump. Action: Determine why storage is not available and reissue IEATDUMP.
000000C	000000F	Meaning: IEAVTDMP's recovery received control. One possible reason is that the SYSZTIOT enqueue is being held exclusively by another process running under this task. It is not possible for the IEATDUMP to successfully complete. Action: The assistance of a system programmer is needed for associated SVC dumps. In the case of a SYSZTIOT enqueue, the problem is not in IEATDUMP processing. The diagnosis of any issues requires data collection using SLIP and/or SDUMPX, and not IEATDUMP.
0000010	xxxxxxx	Meaning: Unexpected return code from IEAVAD00. Return code from IEAVAD00 returned as reason code. Action: Inform the system programmer.

Examples

An example using DSN:

```

IEATDUMP DSN=DUMPDSN ,HDR=DUMPTTL2
.
.
.
DUMPDSN DC AL1(E2-S2)
S2      DC C 'HLQ.TDUMP.D&&YYMDD..T&&HHMSS..&&SYSNAME..&&JOBNAME.'
```

IEATDUMP transaction dump

```
E2      EQU      *
DUMPTTL2 DC      AL1(E3-S3)
S3      DC      C'IEADUMP TO AUTOMATICALLY ALLOCATED DATA SET'
E3      EQU      *
```

Chapter 23. IEATXDC – Transactional execution diagnostic controls

Description

In support of the diagnostic controls of transactional execution, as defined in the *z/Architecture Principles of Operation*, the following services are provided:

For the current task,

- Indicate the scope of the diagnostic controls.
- Set the diagnostic controls for "no abort".
- Set the diagnostic controls for "abort every".
- Set the diagnostic controls for "abort random".

Environment

The requirements for the caller are:

Environmental factor	Requirement
Minimum authorization:	Problem state with PSW key 8-15.
Dispatchable unit mode:	Task
Cross memory mode:	Any PASN, any HASN, any SASN
AMODE:	31- or 64-bit
ASC mode:	Primary or access register (AR)
Interrupt status:	Enabled or disabled for I/O and external interrupts
Locks:	None.
Control parameters:	None.

Programming requirements

None.

Restrictions

None.

Input register information

Before issuing the IEATXDC macro, the caller does not have to place any information into any general purpose register (GPR).

Before issuing the IEATXDC macro, the caller does not have to place any information into any access register (AR).

Output register information

When control returns to the caller, the GPRs contain:

**Register
Contents**

IEATXDC macro

0-1

Used as work registers by the system

2-13

Unchanged

14

Used as a work register by the system

15

Return code

When control returns to the caller, the ARs contain:

Register

Contents

0-1

Used as work registers by the system

2-13

Unchanged

14-15

Used as work registers by the system

Performance implications

None.

Syntax

The IEATXDC macro is written as follows:

Syntax	Description
<i>name</i>	<i>name</i> : symbol. Begin <i>name</i> in column 1.
␣	One or more blanks must precede IEATXDC.
IEATXDC	
␣	One or more blanks must follow IEATXDC.
SCOPE=PROBLEM	
SCOPE=ALL	
,OPERATION=NO_ABORT	
,OPERATION=SET EVERY	
,OPERATION=SET_RANDOM	
,RETCODE= <i>retcode</i>	<i>retcode</i> : RS-type address or register (2) - (12) or (15), (GPR15), (REG15), or (R15).

Syntax	Description

Parameters

The parameters are explained as follows:

name

An optional symbol, starting in column 1, that is the name on the IEATXDC macro invocation. The name must conform to the rules for an ordinary assembler language symbol.

SCOPE=PROBLEM

SCOPE=ALL

A required parameter that identifies the scope of the diagnostic controls.

SCOPE=PROBLEM

indicates that the diagnostic controls apply only for problem state transactional execution.

SCOPE=ALL

is treated the same as SCOPE=PROBLEM.

,OPERATION=NO_ABORT

,OPERATION=SET_EVERY

,OPERATION=SET_RANDOM

A required parameter that identifies the type of operation to perform.

,OPERATION=NO_ABORT

indicates to set the transactional diagnostic controls for this task so that the system will not apply its SET_EVERY or SET_RANDOM rules. Transactions themselves may still abort for all the defined architectural reasons.

,OPERATION=SET_EVERY

indicates to set the transactional diagnostic controls for this task to request abort of every nonconstrained transaction.

,OPERATION=SET_RANDOM

indicates to set the transactional diagnostic controls for this task to request abort of random nonconstrained transactions.

,RETCODE=*retcode*

An optional output parameter into which the return code is to be copied from GPR 15. If you specify 15, GPR15, REG15, or R15 (within or without parentheses), the value will be left in GPR 15.

To code: Specify the RS-type address of a fullword field, or register (2)-(12) or (15), (GPR15), (REG15), or (R15).

ABEND codes

None.

Return codes

When the IEATXDC macro returns control to your program, GPR 15 (and *retcode*, when you code RETCODE) contains a return code.

The following table identifies the hexadecimal return and reason codes.

<i>Table 14. Return codes for the IEATXDC Macro</i>	
Return Code	Meaning and Action
0	Meaning: Successful completion. Diagnostic controls are set to the requested value Action: None required.

Table 14. Return codes for the IEATXDC Macro (continued)

Return Code	Meaning and Action
4	<p>Meaning: Warning. The machine does not support transactional execution. Diagnostic controls are not set.</p> <p>Action: Avoid calling IEATXDC when the machine does not support transactional execution.</p>
8	<p>Meaning: Unexpected input.</p> <p>Action: Check for possible storage overlay.</p>
12	<p>Meaning: Service called in SRB mode.</p> <p>Action: Avoid using IEATXDC in SRB mode.</p>

Examples

None.

Chapter 24. IEAVAPE – Allocate_Pause_Element

Description

Allocate_Pause_Element obtains a pause element token (PET), which uniquely identifies a pause element. The PET is used as input to the following services:

- Pause
- Release
- Transfer
- Deallocate_Pause_Element

Environment

The requirements for the caller are:

Environmental factor	Requirement
Minimum authorization:	Problem state and any PSW key.
Dispatchable unit mode:	Task
Cross memory mode:	PASN=HASN=SASN
AMODE:	31-bit
ASC mode:	Primary
Interrupt status:	Enabled for I/O and external interrupts
Locks:	No locks held.
Control parameters:	Must be in the primary address space and addressable by the caller.

Programming requirements

Either link the calling program's object code with the linkable stub routine (IEACSS from SYS1.CSSLIB), or load the calling program and then call the service. The high-level language (HLL) definitions for the callable service are:

HLL Definition	Description
IEAASM	390 Assembler declarations
IEAC	C/390 and C++/390 declarations

Restrictions

When the calling program specifies `auth_level=IEA_UNAUTHORIZED`, the caller must be in task mode and can only release another task in its home address space. All pause element tokens (PETs) used when `auth_level=IEA_UNAUTHORIZED` must have been obtained using an authorization level of `IEA_UNAUTHORIZED`.

Only 2040 unauthorized PETs may be allocated at any one time in an address space.

Input register information

Before calling `Allocate_Pause_Element`, the caller must ensure that the following general purpose registers (GPRs) contain the specified information:

IEAVAPE callable service

Register Contents

- 1** Address of the parameter address list.
- 13** Address of a 72-byte register save area.

Output register information

When control returns to the caller, the GPRs contain:

Register Contents

- 0-1** Used as work registers by the system
- 2-13** Unchanged
- 14** Used as work registers by the system
- 15** Return Code

When control returns to the caller, the ARs contain:

Register Contents

- 0-1** Used as work registers by the system
- 2-13** Unchanged
- 14-15** Used as work registers by the system

Some callers depend on register contents remaining the same before and after issuing a service. If the system changes the contents of registers on which the caller depends, the caller must save them before issuing the service, and restore them after the system returns control.

Performance implications

None.

Syntax

Syntax	Description
CALL IEAVAPE	(return_code ,auth_level ,pause_element_token)

Parameters

The parameters are explained as follows:

- return_code**
Returned parameter

- Type: Integer
- Character Set: N/A
- Length: 4 bytes

Contains the return code from the Allocate_Pause_Element service.

,auth_level

Supplied parameter

- Type: Integer
- Character Set: N/A
- Length: 4 bytes

Represents one or more possible levels of the pause element being allocated. The calling program can use the constants defined in IEAASM or IEAC, as appropriate. The level desired results from adding the values of the required types together. The authorization type is not optional.

For instance, the level to allocate authorized pause elements that are checkpoint/restart tolerant is IEA_AUTHORIZED + IEA_CHECKPOINTOK, or 3.

The following levels are supported:

IEAASM and IEAC defined constants	Value (hexadecimal)	Meaning
IEA_UNAUTHORIZED	0	When using the allocated pause element through other services, either auth_level IEA_UNAUTHORIZED or IEA_AUTHORIZED can be used.
IEA_AUTHORIZED	1	When using the allocated pause element through other services, auth_level=IEA_AUTHORIZED will be required. Caller must be both key 0 and supervisor state.

IEAASM and IEAC defined constants	Value (hexadecimal)	Meaning
IEA_CHECKPOINTOK	2	The application can tolerate the pause elements' not being restored upon a restart after a checkpoint.

Note: If the IEA_CHECKPOINTOK value is not added to the authorization value, checkpoints cannot be taken when an allocated pause element exists.

,pause_element_token

Returned parameter

- Type: Character string
- Character Set: N/A
- Length: 16 bytes

Contains the pause element token that identifies the pause element which you can use to synchronize the processing of a task.

ABEND codes

None.

Return codes

When the service returns control to the resource manager, GPR 15 and return_code contain a hexadecimal return code.

IEAVAPE callable service

Return code in: Decimal (Hex) Equate symbol	Meaning and Action
00 (0) IEA_SUCCESS	Meaning: Successful completion. Action: None.
24 (18) IEA_LOCK_HELD	Meaning: Program error. If the auth_level indicates AUTHORIZED, locks other than the local lock are held. If the auth_level indicates UNAUTHORIZED, locks are held. The system rejects the service call. Action: Check the calling program for a probable coding error. Correct the program and rerun it.
36 (24) IEA_UNSUPPORTED_MVS_RELEASE	Meaning: Environmental error. The system release does not support this service. The system rejects the service call. Action: Run the program on a system that supports the service.
56 (38) IEA_NO_PETS_AVAILABLE	Meaning: There are no pause element tokens available. Action: Retry the request later.
64 (40) IEA_PE_NOT_HOME	Meaning: Program error. The auth_level value specified in the call is not valid. The system rejects the service call. Action: Check the calling program for a probable coding error. Correct the program and rerun it.
68 (44) IEA_XFER_TO_SELF	Meaning: Program error. The calling program is not in primary ASC mode, which this service requires. The system rejects the service call. Action: Check the calling program for a probable coding error. Correct the program and rerun it.
72 (48) IEA_XFER_FAILED	Meaning: Environmental error. The system could not obtain storage for a pause element. The system rejects the service call. Action: Retry the request later. If the problem persists, consult your system programmer.
4095 (FFF) IEA_UNEXPECTED_ERROR	Meaning: This service routine encountered an unexpected error. The system rejects this service request. Action: Contact IBM support.

Chapter 25. IEAVAPE2 – Allocate_Pause_Element

Description

Allocate_Pause_Element obtains a pause element token (PET), which uniquely identifies a pause element. The PET is used as input to the following services:

- Pause
- Release
- Transfer
- Deallocate_Pause_Element

Environment

The requirements for the caller are:

Environmental factor	Requirement
Minimum authorization:	Problem state and any PSW key
Dispatchable unit mode:	Task
Cross memory mode:	PASN=HASN=SASN
AMODE:	31-bit
ASC mode:	Primary
Interrupt status:	Enabled for I/O and external interrupts
Locks:	No locks held
Control parameters:	Must be in the primary address space and addressable by the caller.

Programming requirements

Either link the calling program's object code with the linkable stub routine (IEACSS from SYS1.CSSLIB) or have the calling program LOAD and then CALL the service. The high-level language (HLL) definitions for the callable service are:

HLL Definition	Description
IEAASM	390 Assembler declarations
IEAC	C/390 and C++/390 declarations

Restrictions

Pause elements that are created with `pause_element_auth_level=IEA_UNAUTHORIZED` may only be used by callers in task mode and can only be released from a task in their home address space.

Only 2040 unauthorized PETs may be allocated at any one time in an address space.

Allocate_Pause_Element cannot be used by tasks that are higher in the task tree than the cross memory resource owning task (the top, or first, job step task in the address space).

Key 1-15 or problem state callers must specify linkage as `IEA_LINKAGE_SVC` and `pause_element_owner_stoken` as binary zero.

Input register information

Before calling `Allocate_Pause_Element`, the caller must ensure that the following general purpose registers (GPRs) contain the specified information:

Register	Contents
----------	----------

- | | |
|-----------|--|
| 1 | Address of the parameter address list. |
| 13 | Address of a 72-byte register save area. |

Output register information

When control returns to the caller, the GPRs contain:

Register	Contents
----------	----------

- | | |
|-------------|---------------------------------------|
| 0-1 | Used as work registers by the system |
| 2-13 | Unchanged |
| 14 | Used as a work register by the system |
| 15 | Return code |

When control returns to the caller, the ARs contain:

Register	Contents
----------	----------

- | | |
|--------------|--------------------------------------|
| 0-1 | Used as work registers by the system |
| 2-13 | Unchanged |
| 14-15 | Used as work registers by the system |

Some callers depend on register contents remaining the same before and after issuing a service. If the system changes the contents of registers on which the caller depends, the caller must save them before issuing the service, and restore them after the system returns control.

Performance implications

None.

Syntax

Syntax	Description
CALL IEAVAPE2	,(return_code ,pause_element_auth_level ,pause_element_token ,pause_element_owner_stoken ,owner_termination_release_code ,linkage)

Parameters

The parameters are explained as follows:

return_code

Returned parameter

- Type: Integer
- Character Set: N/A
- Length: 4 bytes

Contains the return code from the Allocate_Pause_Element service.

,pause_element_auth_level

Supplied parameter

- Type: Integer
- Character Set: N/A
- Length: 4 bytes

Represents one or more possible levels of the pause element being allocated. The calling program can use the constants defined in IEAASM or IEAC, as appropriate. The level desired results from adding the values of the required types together. The authorization type is not optional.

For instance, the level to allocate authorized pause elements that are checkpoint/restart tolerant is IEA_AUTHORIZED + IEA_CHECKPOINTOK, or 3.

The following levels are supported:

IEAASM and IEAC defined constants	Value (hexadecimal)	Meaning
IEA_UNAUTHORIZED	0	When using the allocated pause element through other services, either pause_element_auth_level IEA_UNAUTHORIZED or IEA_AUTHORIZED can be used.
IEA_AUTHORIZED	1	When using the allocated pause element through other services, pause_element_auth_level =IEA_AUTHORIZED is required. Caller must be both key 0 and supervisor state.

IEAASM and IEAC defined constants	Value (hexadecimal)	Meaning
IEA_CHECKPOINTOK	2	The application can tolerate the pause elements' not being restored upon a restart after a checkpoint.

Note: If the IEA_CHECKPOINTOK value is not added to the authorization value, checkpoints cannot be taken when an allocated pause element exists.

,pause_element_token

Returned parameter

- Type: Character string
- Character Set: N/A
- Length: 16 bytes

Contains the pause element token that identifies a pause element which you can use to synchronize the processing of a task or SRB.

,pause_element_owner_stoken

Supplied parameter

- Type: Character string
- Character Set: N/A
- Length: 8 bytes

Specifies the space token (STOKEN) of the address space which is to be considered the owner of the Pause Element being allocated. Specify one of the following values:

- Binary zero: indicate the system should make the current primary address space the owner of the Pause Element. This is the only value valid for key 8-15 problem state callers.
- A valid STOKEN, indicate the system should make the address space with the matching STOKEN the owner for the pause element.

When the CMRO task (the first job step task) of an address space terminates, the system will release and deallocate any pause elements owned by the CMRO task's home address space. The table below describes exactly when the system will release and/or deallocate a Pause Element:

Allocation Service version:	Deallocation Rules
IEAVAPE	<p>The PE will be deallocated by the system when one of the following events occurs:</p> <ul style="list-style-type: none"> • The PE was never used to pause a task or SRB and the CMRO task for the space which allocated it terminates. • The PE is being used to pause a task or SRB which is asynchronously terminated via CALLRTM TYPE=ABTERM (for example, cancel or detach) or a PURGEDQ. • The CMRO task of the home address space of the task or SRB which last used the PE terminates and the PE is not being used to pause an SRB. <p>The home address space of the task or SRB which last used the PE terminates</p>

Allocation Service version:	Deallocation Rules
IEVAPE2	<p>The PE will be deallocated by the system when one of the following events occurs:</p> <ul style="list-style-type: none"> • The CMRO task of the address space specified by <code>pause_element_owner_stoken</code> terminates. If the PE is being used to pause a DU when the CMRO task terminates, the system will release the DU using the <code>owner_termination_release_code</code> before the PE is deallocated. Note that in this case, the UPET returned will be 16 bytes of binary zeros, an invalid value. • The PE is being used to pause a task or SRB which is asynchronously terminated via <code>CALLRTM TYPE=ABTERM</code> (for example, cancel or detach) or a <code>PURGEDQ</code>. • The PE is being used to pause a task or SRB when the home address space of the task or SRB is terminated • The CMRO task of the home address space of the task or SRB which last used the PE terminates and the PE is not being used to pause an SRB <p>The home address space of the task or SRB which last used the PE terminates. Note: A PE is considered as "being used to pause a task or SRB," when the PE is not Reset or Prereleased.</p>

,owner_termination_release_code

Supplied parameter

- Type: Character string
- Character Set: N/A
- Length: 3 bytes

Specifies the release code which will be returned to a paused DU if the system deallocates the pause element while it is being used to pause a task or SRB, due to the CMRO task of its owning address space terminating.

Note: If the system deallocates a PE due to its owner terminating while the PE was not being used to pause a task or SRB, future attempts to use the PE will fail with a return code indicating the PETOKEN was stale or the PE is in an invalid state.

linkage

Supplied parameter

- Type: Integer
- Character Set: N/A
- Length: 4 bytes

Specifies how the `Allocate_Pause_Element` service routine is to be invoked. The following options are supported:

Table 19. Linkage option		
Variable	Value (hexadecimal)	Meaning
IEA_LINKAGE_SVC	0	The Allocate_Pause_Element service routine will be invoked via an SVC linkage. This option can be used when in non-cross memory task mode, any key, and either problem state or supervisor state.
IEA_LINKAGE_BRANCH	1	The Allocate_Pause_Element service routine will be invoked via a branch instruction. The caller must be in both key 0 and supervisor state. This option must be selected when in SRB mode.

ABEND codes

None.

Return codes

When the service returns control to the resource manager, GPR 15 and return_code contain a hexadecimal return code.

Return code in: Decimal (Hex)	Equate Symbol	Meaning and Action
00 (0)	IEA_SUCCESS	Meaning: Successful completion. Action: None.
24 (18)	IEA_LOCK_HELD	Meaning: Program error. One or more locks other than the local lock are held. The system rejects the service call. Action: Check the calling program for a probable coding error. Correct the program and rerun it.
36 (24)	IEA_UNSUPPORTED_MVS_RELEASE	Meaning: Environmental error. The system release does not support this service. The system rejects the service call. Action: Run the program on a system that supports the service.
40 (28)	IEA_INVALID_AUTHCODE	Meaning: Program error. The pause_element_auth_level value specified in the call is not valid. The system rejects the service call. Action: Check the calling program for a probable coding error. Correct the program and rerun it.
44 (2C)	IEA_INVALID_MODE	Meaning: Program error. The calling program is not in primary ASC mode, which this service requires. The system rejects the service call. Action: Check the calling program for a probable coding error. Correct the program and rerun it.
48 (30)	IEA_OUT_OF_STORAGE	Meaning: Environmental error. The system could not obtain storage for a pause element. The system rejects the service call. Action: Retry the request later. If the problem persists, consult your system programmer.
56 (38)	IEA_NO_PETS_AVAILABLE	Meaning: There are no pause element tokens available. Action: Retry the request later.

Return code in: Decimal (Hex)	Equate Symbol	Meaning and Action
4095 (FFF)	IEA_UNEXPECTED_ERROR	<p>Meaning: This service routine encountered an unexpected error. The system rejects this service request.</p> <p>Action: Contact IBM support.</p>
84 (54)	IEA_INVALID_LINKAGE	<p>Meaning: Program error. The linkage value specified is not valid. The system rejects the service call</p> <p>Action: Check the calling program for a probable coding error. Correct the program and rerun it.</p>
88 (58)	IEA_INVALID_OWNER_STOKEN	<p>Meaning: Program error. The stoken specified for pause_element_owner_stoken is not valid.</p> <p>Action: Obtain the correct stoken of the target and reissue the call</p>
96 (60)	IEA_UNAUTH_NONZERO_OWNER_STOKEN	<p>Meaning: Program error. A key 8-15 problem state caller specified a nonzero value for pause_element_owner_stoken</p> <p>Action: Check the calling program for a probable coding error. Correct the program and rerun it.</p>
100 (64)	IEA_INVALID_AUTHLVL_AUTHCODE	<p>Meaning: The pause_element_auth_level value specified in the call is not valid. The system rejects the service call.</p> <p>Action: Check the calling program for a probable coding error. Correct the program and rerun it.</p>

Chapter 26. IEAVDPE – Deallocate_Pause_Element

Description

Deallocate_Pause_Element frees a pause element that is no longer needed.

Environment

The requirements for the caller are:

Environmental factor	Requirement
Minimum authorization:	Problem state and any PSW key.
Dispatchable unit mode:	Task
Cross memory mode:	PASN=HASN=SASN
AMODE:	31-bit addressing mode.
ASC mode:	Primary mode.
Interrupt status:	Enabled for I/O and external interrupts
Locks:	No locks held.
Control parameters:	Must be in the primary address space and addressable by the caller.

Programming requirements

Either link the calling program's object code with the linkable stub routine (IEACSS from SYS1.CSSLIB), or load the calling program and then call the service. The high-level language (HLL) definitions for the callable service are:

HLL Definition	Description
IEAASM	390 Assembler declarations
IEAC	C/390 and C++/390 declarations

Restrictions

When the calling program specifies `auth_level=IEA_UNAUTHORIZED`, the caller must be in task mode and can only release another task in its home address space. All pause element tokens (PETs) used when `auth_level=IEA_UNAUTHORIZED` must have been obtained using an authorization level of `IEA_UNAUTHORIZED`.

Input register information

Before calling `Deallocate_Pause_Element`, the caller must ensure that the following general purpose registers (GPRs) contain the specified information:

Register

Contents

- 1** Address of the parameter address list.
- 13** Address of a 72-byte register save area.

Output register information

When control returns to the caller, the GPRs contain:

Register Contents

0-1

Used as work registers by the system

2-13

Unchanged

14

Used as a work register by the system

15

Return code

When control returns to the caller, the access registers (ARs) contain:

Register Contents

0-1

Used as work registers by the system

2-13

Unchanged

14-15

Used as a work register by the system

Some callers depend on register contents remaining the same before and after issuing a service. If the system changes the contents of registers on which the caller depends, the caller must save them before issuing the service, and restore them after the system returns control.

Performance implications

None.

Syntax

Write the call as shown on the syntax diagram. You must code all parameters on the CALL statement in the order shown.

Syntax	Description
CALL IEAVDPE	,(return_code ,auth_level ,pause_element_token)

Parameters

The parameters are explained as follows:

return_code

Returned parameter

- Type: Integer
- Character Set: N/A
- Length: 4 bytes

Contains the return code from the Deallocate_Pause_Element service.

,auth_level

Supplied parameter

- Type: Integer
- Character Set: N/A
- Length: 4 bytes

Indicates the maximum authorization level of the pause element being deallocated. IEAASM and IEAC define constants IEA_UNAUTHORIZED and IEA_AUTHORIZED, which the calling program can use. The following levels are supported:

Variable	Value (HEX)	Meaning
IEA_UNAUTHORIZED	0	This pause element being deallocated must have been allocated with auth_level=IEA_UNAUTHORIZED.

,pause_element_token

Supplied parameter

- Type: Character string
- Character Set: N/A
- Length: 16 bytes

Contains the pause element token that identifies the pause element that is no longer needed.

ABEND codes

None.

Return codes

When the service returns control to the resource manager, GPR 15 and return_code contain a hexadecimal return code.

Return code in: Decimal (Hex) Equate symbol	Meaning and Action
00 (00) IEA_SUCCESS	Meaning: Successful completion Action: None.
04 (04)	Meaning: Program error. The specified pause element token is not valid. The system rejects the service call. Action: Check the calling program for a probable coding error. Correct the program and rerun it.
08 (08) IEA_PE_TOKEN_STALE	Meaning: The specified pause element token is stale; that is, it was valid but has been used on the Pause or Transfer service. This service requires the updated PET returned on Pause or Transfer. Action: Check the calling program for a probable coding error. Correct the program and rerun it.
24 (18) IEA_LOCK_HELD	Meaning: Program error. The caller is holding one or more locks; no locks must be held. The system rejects the service call. Action: Check the calling program for a probable coding error. Correct the program and rerun it.

IEAVDPE callable service

Return code in: Decimal (Hex) Equate symbol	Meaning and Action
32 (20) IEA_PE_BAD_STATE	<p>Meaning: Program error. The pause element associated with the specified pause element token is not valid or has already been paused. A paused PE must be released before it is deallocated. This return code also can indicate that the address space associated with the pause element is ending or has ended and that the system freed the pause element.</p> <p>Action: Check the calling program for a probable coding error. Correct the program and rerun it.</p>
36 (24) IEA_UNSUPPORTED_MVS_RELEASE	<p>Meaning: Environmental error. The system release does not support this service. The system rejects the service call.</p> <p>Action: Run the program on a system that supports the service.</p>
40 (28) IEA_INVALID_AUTHCODE	<p>Meaning: Program error. The auth_level value specified in the call is not valid. The system rejects the service call.</p> <p>Action: Check the calling program for a probable coding error. Correct the program and rerun it.</p>
44 (2C) IEA_INVALID_MODE	<p>Meaning: Program error. The calling program is not in primary ASC mode, which this service requires. The system rejects the service call.</p> <p>Action: Check the calling program for a probable coding error. Correct the program and rerun it.</p>
60 (3C) IEA_AUTH_TOKEN	<p>Meaning: Program error. The caller specified auth_level=UNAUTHORIZED, but the pause element token was allocated with auth_level=AUTHORIZED. The system rejects the service call.</p> <p>Action: Program error. The specified pause element token is not valid. The system rejects the service call.</p>
64 (40) IEA_PE_NOT_HOME	<p>Meaning: Program error. The caller specified auth_level=UNAUTHORIZED, but the pause element token was for a pause element allocated to another address.</p> <p>Action: Check the calling program for a probable coding error. Correct the program and rerun it.</p>
4095 (FFF) IEA_UNEXPECTED_ERROR	<p>Meaning: This service routine encountered an unexpected error. The system rejects this service request.</p> <p>Action: Contact IBM support.</p>

Chapter 27. IEAVDPE2 – Deallocate_Pause_Element

Description

Deallocate_Pause_Element frees a pause element that is no longer needed.

Environment

The requirements for the caller are:

Environmental factor	Requirement
Minimum authorization:	Problem state and any PSW key
Dispatchable unit mode:	Task
Cross memory mode:	PASN=HASN=SASN
AMODE:	31-bit addressing mode.
ASC mode:	Primary mode.
Interrupt status:	Enabled for I/O and external interrupts.
Locks:	No locks held.
Control parameters:	Must be in the primary address space and addressable by the caller.

Programming requirements

Either link the object code of the calling program with the linkable stub routine (IEACSS from SYS1.CSSLIB) or have the calling program LOAD and then CALL the service. The high-level language (HLL) definitions for the callable service are:

HLL Definition	Description
IEAASM	390 Assembler declarations
IEAC	C/390 and C++/390 declarations

Restrictions

Pause elements that are created with `pause_element_auth_level=IEA_UNAUTHORIZED` may only be used by callers in task mode and can only be released from a task in their home address space.

Key 1-15 or problem state callers must specify linkage as `IEA_LINKAGE_SVC`.

Input register information

Before calling `Deallocate_Pause_Element`, the caller must ensure that the following general purpose registers (GPRs) contain the specified information:

Register

Contents

- 1** Address of the parameter address list.
- 13** Address of a 72-byte register save area.

Output register information

When control returns to the caller, the GPRs contain:

Register Contents

0-1

Used as work registers by the system

2-13

Unchanged

14

Used as a work register by the system

15

Return code

When control returns to the caller, the access registers (ARs) contain:

Register Contents

0-1

Used as work registers by the system

2-13

Unchanged

14-15

Used as a work register by the system

Some callers depend on register contents remaining the same before and after issuing a service. If the system changes the contents of registers on which the caller depends, the caller must save them before issuing the service, and restore them after the system returns control.

Performance implications

None.

Syntax

Write the call as shown on the syntax diagram. You must code all parameters on the CALL statement in the order shown.

Syntax	Description
CALL IEAVDPE2	,(return_code ,pause_element_token ,linkage)

Parameters

The parameters are explained as follows:

return_code

Returned parameter

- Type: Integer
- Character Set: N/A
- Length: 4 bytes

Contains the return code from the Deallocate_Pause_Element service.

,pause_element_token

Supplied parameter

- Type: Character string
- Character Set: N/A
- Length: 16 bytes

Contains the pause element token that identifies the pause element that is no longer needed.

linkage

Supplied parameter

- Type: Integer
- Character Set: N/A
- Length: 4 bytes

Specifies how the Deallocate_Pause_Element service routine is to be invoked. The following options are supported:

Variable	Value (hexadecimal)	Meaning
IEA_LINKAGE_SVC	0	The Deallocate_Pause_Element service routine will be invoked by an SVC linkage. This option can be used when in non-cross memory task mode, in any key, and in either problem state or supervisor state.
IEA_LINKAGE_BRANCH	1	The Deallocate_Pause_Element service routine will be invoked by a branch instruction. The caller must be in both key 0 and supervisor state. This option must be selected when in SRB mode.

ABEND codes

None.

Return codes

When the service returns control to the resource manager, GPR 15 and return_code contain a hexadecimal return code.

Return code in: Decimal (Hex)	Equate symbol	Meaning and Action
00 (00)	IEA_SUCCESS	Meaning: Successful completion Action: None.
04 (04)	IEA_PE_TOKEN_BAD	Meaning: Program error. The specified pause element token is not valid. The system rejects the service call. Action: Check the calling program for a probable coding error. Correct the program and rerun it.
08 (08)	IEA_PE_TOKEN_STALE	Meaning: The specified pause element token is stale; that is, it was valid but has been used on the Pause or Transfer service. This service requires the updated PET returned on Pause or Transfer. Action: Check the calling program for a probable coding error. Correct the program and rerun it.
24 (18)	IEA_LOCK_HELD	Meaning: Program error. One or more locks other than the local lock are held. The system rejects the service call. Action: Check the calling program for a probable coding error. Correct the program and rerun it.

IEAVDPE2 callable service

Return code in: Decimal (Hex)	Equate symbol	Meaning and Action
32 (20)	IEA_PE_BAD_STATE	<p>Meaning: Program error. The pause element associated with the specified pause element token is invalid or has already been paused. A paused PE must be released before it is deallocated. This return code also can indicate that the address space associated with the pause element is ending or has ended and that the system freed the pause element.</p> <p>Action: Check the calling program for a probable coding error. Correct the program and rerun it.</p>
36 (24)	IEA_UNSUPPORTED_MVS_RELEASE	<p>Meaning: Environmental error. The system release does not support this service. The system rejects the service call.</p> <p>Action: Run the program on a system that supports the service.</p>
44 (2C)	IEA_INVALID_MODE	<p>Meaning: Program error. The calling program is not in primary ASC mode, which this service requires. The system rejects the service call.</p> <p>Action: Check the calling program for a probable coding error. Correct the program and rerun it.</p>
64 (40)	IEA_PE_NOT_HOME	<p>Meaning: Program error. The pause element token was for an unauthorized pause element allocated to another address space.</p> <p>Action: Check the calling program for a probable coding error. Correct the program and rerun it.</p>
84 (54)	IEA_INVALID_LINKAGE	<p>Meaning: Program error. The linkage value specified is not valid. The system rejects the service call.</p> <p>Action: Check the calling program for a probable coding error. Correct the program and rerun it.</p>
4095 (FFF)	IEA_UNEXPECTED_ERROR	<p>Meaning: This service routine encountered an unexpected error. The system rejects this service request.</p> <p>Action: Contact IBM support.</p>

Chapter 28. IEAVPME2 – pause multiple elements service

Description

IEAVPME2 is a callable service that can be used to pause on one or more pause element tokens (PETs). When the specified number of pause elements (PEs) represented by PETs has been released, you receive control back with the following:

- A list of PETs that you can use to pause on again
- An indication of which PEs were released
- Their release codes.

Environment

The requirements for the caller are:

Environmental factor	Requirement
Minimum authorization:	<ul style="list-style-type: none"> • Pproblem state and any PSW key.
Dispatchable unit mode:	<ul style="list-style-type: none"> • For LINKAGE=BRANCH: Task or SRB • For LINKAGE=SVC: Task
Cross memory mode:	<ul style="list-style-type: none"> • For LINKAGE=BRANCH: any PASN, any HASN, any SASN • For LINKAGE=SVC: PASN=SASN=HASN
AMODE:	31-bit addressing mode.
ASC mode:	Primary mode.
Interrupt status:	Enabled for I/O and external interrupts.
Locks:	No locks held.
Control parameters:	Must be in the primary address space and addressable by the caller.

Programming requirements

Either link the calling program's object code with the linkable stub routine (IEACSS from SYS1.CSSLIB), or load the calling program and then call the service. The high-level language (HLL) definitions for the callable service are:

HLL Definition	Description
IEAASM	390 Assembler declarations
IEAC	C/390 and C++/390 declarations

Restrictions

Pause elements that are created with `pause_element_auth_level=IEA_UNAUTHORIZED` may only be used by callers in task mode and can only be released from a task in their home address space.

Key 1-15 or problem state callers must specify linkage as `IEA_LINKAGE_SVC`. `IEA_LINKAGE_SVC` is limited to pausing upon no more than 1000 PETs.

Pause cannot be used by tasks that are higher in the task tree than the cross memory resource owning task (the EXEC PGM=xxx task).

Input register information

Before calling the Pause service, the caller must ensure that the following general purpose registers (GPRs) contain the specified information:

Register Contents

1

Address of the parameter address list.

13

Note that register 13 is not required to contain any particular value. See the **workarea** parameter description.

Output register information

When control returns to the caller, the GPRs contain:

Register Contents

0-1

Used as work registers by the system

2-13

Unchanged

14

Used as work registers by the system

15

Return code.

Note that this service saves and restores full 64-bit GPRs.

When control returns to the caller, the ARs contain:

Register Contents

0-1

Used as work registers by the system

2-13

Unchanged

14-15

Used as work registers by the system

Some callers depend on register contents remaining the same before and after issuing a service. If the system changes the contents of registers on which the caller depends, the caller must save them before issuing the service, and restore them after the system returns control.

Performance implications

There is a maximum number of PETs which can be processed very quickly by IEAVPME2 without doing additional GETMAINS and FREEMAINS. That number is currently 16.

Syntax

Syntax	Description
CALL IEAVPME2	(return_code ,pause_element_token_list ,updated_pause_element_token_list ,release_code_list ,number_of_PETs_in_each_list ,number_of_PEs_to_release ,linkage ,workarea)

Link-edit your program with a linkage-assist routine (also called a stub) in SYS1.CSSLIB unless you use one of the following techniques as an alternative to CALL IEAVPME2:

- ```
LOAD EP=IEAVPME2
Save the entry point address...
Put the saved entry point address into R15
CALL (15),(...)
```
- ```
L    15,X'10'(0,0)
L    15,X'220'(15,0)
L    15,X'14'(15,0)
L    15,X'100'(15,0)
CALL (15),(...)
```

Parameters

The parameters are explained as follows:

return_code

Returned parameter

- Type: Integer
- Character Set: N/A
- Length: 4 bytes

Contains the highest return code from the Pause service (multiple return codes are possible when more than one PET has been specified – *seerelease_code_list*). When the low-order bit of the return code is on, *release_code_list* contains the return codes for individual PETs rather than release codes.

Note that no pause has actually occurred if the return code is non-zero. In this situation, any PETs which have been released remain released.

,pause_element_token_list

Supplied parameter

- Type: Character string
- Character Set: N/A
- Length: 16 bytes times the number of PEs you want to pause on

A list of the PETs identifying the PEs you want to pause on. *Number_of_PETs_in_each_list* specifies how many PETs are in the list.

,updated_pause_element_token_list

Returned parameter

- Type: Character string
- Character Set: N/A

- Length: 16 bytes times the number of PEs you want to pause on

If *return_code* is 0, a list of the PETs returned by Pause Multiple Elements. Each entry corresponds to an entry in the *pause_element_token_list*. For each PE that was released, the system puts an updated PET into this list. For PEs that are not released, the entry contains the PET from the original *pause_element_token_list*. These new PETs must be used in place of the PETs specified in *pause_element_token_list* or *pause_element_token* on future calls to the Pause, Release, Transfer, or Deallocate_Pause_Element service. The first byte of each entry in *release_code_list* identifies which PEs were released. *Number_of_PETs_in_each_list* specifies how many PETs are in the list.

If *return_code* is not 0, the PETs are not updated and this list is not returned.

If the paused *workunit* was released by the system (the release code is the *owner_termination_release_code* specified on the IEAVAPE2 allocation), the PET returned in that slot will be 16 bytes of binary zeros, an invalid value.

,release_code_list

Returned parameter

- Type: Fullword
- Character Set: N/A
- Length: 4 bytes times the number of PEs you want to pause on

Each entry corresponds to an entry in the *pause_element_token_list*.

If *return_code* is 0, the pause was successful and has been released. For each PE that was Released, the system puts X'01' into the first byte and the release code for that PET into the second through fourth bytes of the full-word entry for that PET. For PEs which are not released, the entry contains binary zeroes.

If *return_code* is 5, 9, D, 21, 35, 3D, or 41, a problem was found with at least one of the PETs specified in *pause_element_token_list* and the pause request did not complete. The individual return code for each PET is in the second through fourth bytes of the *release_code_list* entry for that PET. Each PET with a return code of 0 would have been paused on if all the other PETs in the list had received return codes of 0.

Note: These return codes are the equivalent of return codes 4, 8, C, 20, 34, 3C, and 40 for IEAVPSE2 (Pause single), with the addition of a low-order bit to signify that the *release_code_list* contains individual PET return codes.

If *return_code* contains any other value, the pause request did not complete and *release_code_list* does not contain any meaningful information.

,number_of_PETs_in_each_list

Supplied parameter

Number_of_PETs_in_each_list specifies how many entries are in *release_code_list*.

- Type: Integer
- Character Set: N/A
- Length: 4 bytes

This number specifies how many PETs you want to Pause on. This number also specifies the number of entries in *pause_element_token_list*, *updated_pause_element_token_list*, and *release_code_list*. For SVC entry callers, the maximum number that can be specified is 1000.

,number_of_PEs_to_release

Supplied parameter

Number_of_PETs_in_each_list specifies how many entries are in *release_code_list*.

- Type: Integer
- Character Set: N/A
- Length: 4 bytes

This number specifies how many PEs must be released before control is returned back to the issuer of Pause Multiple Elements. This number must be at least 1 and no more than *number_of_PETs_in_each_list*.

Note that if more PEs than this number were released before IEAVPME2 was issued (pre-released), the number of updated PETs in *updated_pause_element_token_list* will be the actual number released.

,linkage

Supplied parameter

- Type: Integer
- Character Set: N/A
- Length: 4 bytes

Specifies how the Pause service routine is to be invoked. The following options are supported:

Variable	Value	Meaning
IEA_LINKAGE_SVC	0	The Pause service routine will be invoked by an SVC linkage. This option can be used when in non-cross memory task mode, in any key, and in either problem state or supervisor state.
IEA_LINKAGE_BRANCH	1	The Pause service routine will be invoked by a branch instruction. The caller must be in both key 0 and supervisor state. This option must be selected when in SRB mode.

,workarea

Supplied parameter

- Type: Character string
- Character Set: N/A
- Length: 216 bytes

Specifies a work area on a doubleword boundary in which the Pause service routine will save information about the caller including the caller's registers. This can be the same area that R13 points to if the first 216 bytes of that area can be used as an F7SA savearea.

ABEND codes

None. However, note that you may receive a GETMAIN abend if this service is unable to obtain storage needed to process the PETs.

Return codes

When IEAVPME2 returns control to your program, if GPR 15 contains 0, 5, 9, D, 21, 35, 3D, or 41, *release_code_list* contains information about the status of each PET that was specified. If GPR 15 contains any other value, *release_code_list* does not contain any meaningful information.

Return code in: Decimal (Hex)	Equate Symbol	Meaning and Action
00 (0)	IEA_SUCCESS	Meaning: Successful completion. Action: None.
05 (05)	IEA_PE_TOKEN_BAD	Meaning: Program error. The specified pause element token is not valid. The system rejects the service call. Action: Check the calling program for a probable coding error. Correct the program and rerun it.

Return code in: Decimal (Hex)	Equate Symbol	Meaning and Action
09 (09)	IEA_PE_TOKEN_STALE	<p>Meaning: The specified pause element token is stale; that is, it was valid but has been used on the Pause or Transfer service. This service requires the updated PET returned on Pause or Transfer.</p> <p>Action: Check the calling program for a probable coding error. Correct the program and rerun it.</p>
13 (0D)	IEA_DUPLICATE_PAUSE	<p>Meaning: The work unit has already been paused using the specified pause element token. The system rejects the service call.</p> <p>Action: Check the calling program for a probable coding error. Correct the program and rerun it.</p>
24 (18)	IEA_LOCK_HELD	<p>Meaning: Program error. The caller is holding one or more locks; no locks may be held. The system rejects the service call.</p> <p>Action: Check the calling program for a probable coding error. Correct the program and rerun it.</p>
33 (21)	IEA_PE_BAD_STATE	<p>Meaning: Program error. The pause element associated with the pause element token specified in the call is not in a valid state. The system rejects the service call.</p> <p>Action: Check the calling program for a probable coding error, such as attempting to perform a pause or transfer using a pause element token that has already been used to pause or transfer by another unit of work. Correct the program and rerun it.</p>
36 (24)	IEA_UNSUPPORTED_MVS_RELEASE	<p>Meaning: Environmental error. The system release does not support this service. The system rejects the service call.</p> <p>Action: Run the program on a system that supports the service.</p>
44 (2C)	IEA_INVALID_MODE	<p>Meaning: Program error. The calling program is not in primary ASC mode, which this service requires. The system rejects the service call.</p> <p>Action: Check the calling program for a probable coding error. Correct the program and rerun it.</p>
53 (35)	IEA_ALREADY_SUSPENDED	<p>Meaning: The pause element was already paused.</p> <p>Action: Check the calling program for a probable coding error. Correct the program and rerun it.</p>
61 (3D)	IEA_AUTH_LEVEL_MISMATCH	<p>Meaning: Program error. The caller was in problem state or key 8, but the pause element token was allocated with <i>pause_element_auth_level</i>=IEA_AUTHORIZED. The system rejects the service call.</p> <p>Action: Program error. The specified pause element token is not valid. The system rejects the service call.</p>
65 (41)	IEA_PE_NOT_HOME_PM	<p>Meaning: Program error. The pause element token was for a pause element allocated with <i>pause_element_auth_level</i>=IEA_AUTHORIZED to another address space.</p> <p>Action: Check the calling program for a probable coding error. Correct the program and rerun it.</p>
76 (4C)	IEA_ABENDED_47B	<p>Meaning: After an SRB received abend 47B, it invoked IEAVPSE. It is not valid to invoke IEAVPME2 after receiving abend 47B.</p> <p>Action: Update the calling program to not invoke IEAVPME2 after abend 47B.</p>

Return code in: Decimal (Hex)	Equate Symbol	Meaning and Action
80 (50)	IEA_INSUSPEND_EXIT	<p>Meaning: The suspend exit specified on SUSPEND with SPTOKEN of an SRB invoked IEAVPME2. It is not valid to invoke IEAVPME2 from a suspend exit.</p> <p>Action: Update the calling program to not invoke IEAVPME2 from a suspend exit.</p>
84 (54)	IEA_INVALID_LINKAGE	<p>Meaning: Program error. The linkage value specified is not valid. The system rejects the service call.</p> <p>Action: Check the calling program for a probable coding error. Correct the program and rerun it.</p>
104 (68)	IEA_INVALID_NUMBER_OF_PETS	<p>Meaning: Program error. The number of PETS specified for Pause Multiple was 0 or for SVC entry users more than 1000. The system rejects the service call.</p> <p>Action: Check the calling program for a probable coding error. Correct the program and rerun it.</p>
108 (6C)	IEA_INVALID_NUMBER_TO_RELEASE	<p>Meaning: Program error. The number of PEs to release is 0 or greater than the number of PETS specified for Pause Multiple. The system rejects the service call.</p> <p>Action: Check the calling program for a probable coding error. Correct the program and rerun it.</p>
4094 (FFE)	IEA_ERROR_PETS_INVALIDATED	<p>Meaning: Pause processing has encountered an error and cannot complete the Pause request. This input PETS have been invalidated. This return code is only issued for Pause Multiple requests.</p> <p>Action: Do not return the PETS to the system using the Deallocate Pause Elements services. Note that new PEs must be obtained before attempting to pause again.</p>
4095 (FFF)	IEA_UNEXPECTED_ERROR	<p>Meaning: This service routine encountered an unexpected error. The system rejects this service request.</p> <p>Action: Contact IBM support.</p>

Chapter 29. IEAVPSE – Pause service

Description

Call Pause to make the current task non-dispatchable. Once you pause a task, it remains non-dispatchable until a Release service specifying the same PET is called. That is, the program issuing the Pause does not receive control back until after the Release occurs.

If a Release service specifying the same PET is called before Pause, the system returns control immediately to the calling program, and the task is not paused.

When you use Pause, it returns an updated PET; you use this updated PET to either deallocate or reuse the Process Engine.

Environment

The requirements for the caller are:

Environmental factor	Requirement
Minimum authorization:	Problem state and any PSW key.
Dispatchable unit mode:	Task or SRB
Cross memory mode:	PASN=HASN=SASN
AMODE:	31-bit addressing mode.
ASC mode:	Primary mode.
Interrupt status:	Enabled for I/O and external interrupts
Locks:	No locks held.
Control parameters:	Must be in the primary address space and addressable by the caller.

Programming requirements

Either link the calling program's object code with the linkable stub routine (IEACSS from SYS1.CSSLIB), or load the calling program and then call the service. The high-level language (HLL) definitions for the callable service are:

HLL Definition	Description
IEAASM	390 Assembler declarations
IEAC	C/390 and C++/390 declarations

Restrictions

When the calling program is running `auth_level=IEA_UNAUTHORIZED`, the caller must be in task mode and can only pause another task in its home address space. All pause element tokens (PETs) used when `auth_level=IEA_UNAUTHORIZED` must have been obtained using an authorization level of `IEA_UNAUTHORIZED`.

Input register information

Before calling the Pause service, the caller must ensure that the following general-purpose registers (GPRs) contain the specified information:

**Register
Contents**

- 1** Address of the parameter address list.
- 13** Address of a 72-byte register save area.

Output register information

When control returns to the caller, the GPRs contain:

**Register
Contents**

- 0-1** Used as work registers by the system.
- 2-13** Unchanged
- 14** Used as work registers by the system.
- 15** Return code.

When control returns to the caller, the access registers (ARs) contain:

**Register
Contents**

- 0-1** Used as work registers by the system.
- 2-13** Unchanged
- 14-15** Used as a work register by the system.

Some callers depend on register contents remaining the same before and after issuing a service. If the system changes the contents of registers on which the caller depends, the caller must save them before issuing the service, and restore them after the system returns control.

Performance implications

None.

Syntax

Syntax	Description
CALL IEAVPSE	,(return_code ,auth_level ,pause_element_token ,updated_pause_element_token ,release_code)

Parameters

The parameters are explained as follows:

return_code

Returned parameter:

- Type: Integer
- Character Set: N/A
- Length: 4 bytes

Contains the return code from the Pause service.

,auth_level

Supplied parameter:

- Type: Integer
- Character Set: N/A
- Length: 4 bytes

Indicates the maximum level that the specified pause element was allocated with. IEAASM and IEAC define constant IEA_UNAUTHORIZED, which the calling program can use. The following levels are supported:

Variable	Value (HEX)	Meaning
IEA_UNAUTHORIZED	0	The pause element being paused must have been allocated with auth_level=IEA_UNAUTHORIZED.

,pause_element_token

Supplied parameter:

- Type: Character string
- Character Set: N/A
- Length: 16 bytes

A pause element token that identifies the pause element being used to pause the current task. You obtain the PET from the Allocate_Pause_Element service.

Once you use a PET in a call to the Pause service, you cannot reuse the PET on a second call to Pause or on a call to Transfer. The Pause service returns a new PET in **updated_pause_element_token**. The new PET now identifies the pause element used to Pause the task; use the new PET the next time you make a Pause request using the same Pause element.

,updated_pause_element_token

Returned parameter:

- Type: Character string
- Character Set: N/A
- Length: 16 bytes

A new pause element token that identifies the pause element that is originally identified by the PET specified in **pause_element_token**, which cannot be reused after a successful call to Pause.

,release_code

Returned parameter:

- Type: Character string
- Character Set: N/A
- Length: 3 bytes

The release code, which is specified by the issuer of the Release service. A Release that specified this code released the task from the paused condition.

ABEND codes

Abend Code	Reason Code	Description
AC7	001A0001	This is an internal error. Contact IBM support.

Return codes

When the service returns control to your program, GPR 15 contains one of the following return codes:

Return code in: Decimal (Hex) Equate symbol	Meaning and Action
00 (00) IEA_SUCCESS	Meaning: Successful completion. Action: None
04 (04)	Meaning: Program error. The specified pause element token is not valid. The system rejects the service call. Action: Check the calling program for a probable coding error. Correct the program and rerun it.
08 (08) IEA_PE_TOKEN_STALE	Meaning: The specified pause element token is stale; that is, it was valid but has been used on the Pause or Transfer service. This service requires the updated PET be returned on Pause or Transfer. Action: Check the calling program for a probable coding error. Correct the program and rerun it.
12 (0C) IEA_DUPLICATE_PAUSE	Meaning: The work unit has already been paused using the specified pause element token. The system rejects the service call. Action: Check the calling program for a probable coding error. Correct the program and rerun it.
24 (18) IEA_LOCK_HELD	Meaning: Program error. The caller is holding one or more locks; no locks must be held. The system rejects the service call. Action: Check the calling program for a probable coding error. Correct the program and rerun it.
32 (20) IEA_PE_BAD_STATE	Meaning: Program error. The pause element associated with the pause element token specified in the call is not in a valid state. The system rejects the service call. Action: Check the calling program for a probable coding error, such as attempting to perform a Pause or Transfer using a pause element token that has already been used to Pause or Transfer by another unit of work. Correct the program and rerun it.
36 (24) IEA_UNSUPPORTED_MVS_RELEASE	Meaning: Environmental error. The system release does not support this service. The system rejects the service call. Action: Run the program on a system that supports the service.
40 (28) IEA_INVALID_AUTHCODE	Meaning: Program error. The auth_level value specified in the call is not valid. The system rejects the service call. Action: Check the calling program for a probable coding error. Correct the program and rerun it.
44 (2C) IEA_INVALID_MODE	Meaning: Program error. The calling program is not in primary ASC mode, which this service requires. The system rejects the service call. Action: Check the calling program for a probable coding error. Correct the program and rerun it.
52 (34) IEA_ALREADY_SUSPENDED	Meaning: The pause element was already paused. Action: Check the calling program for a probable coding error and correct the program and rerun it.

Return code in: Decimal (Hex) Equate symbol	Meaning and Action
60 (3C) IEA_AUTH_TOKEN	<p>Meaning: Program error. The caller specified auth_level=UNAUTHORIZED, but the pause element token was allocated with auth_level=AUTHORIZED. The system rejects the service call. Rejects the service call.</p> <p>Action: Program error. The specified pause element token is not valid. The system rejects the service call.</p>
64 (40) IEA_PE_NOT_HOME	<p>Meaning: Program error. The caller specified auth_level=UNAUTHORIZED, but the pause element token was for a pause element allocated to another address.</p> <p>Action: Check the calling program for a probable coding error. Correct the program and rerun it.</p>
4095 (FFF) IEA_UNEXPECTED_ERROR	<p>Meaning: This service routine encountered an unexpected error. The system rejects this service request.</p> <p>Action: Contact IBM support.</p>

Chapter 30. IEAVPSE2 – Pause service

Description

Call Pause to make the current task or SRB nondispatchable. When you pause a task or SRB, it remains nondispatchable until a Release or Transfer specifying the same PET is called. That is, the program issuing the Pause does not receive control back until after the Release or Transfer occurs. Then, the returned `release_code` contains a value supplied by the associated Release or Transfer request.

If a Release service specifying the same PET is called before Pause, the system returns control immediately to the calling program, and the task or SRB is not paused.

When you use Pause, it returns an updated PET; you use this updated PET to either deallocate or reuse the Process Engine (PE).

Environment

The requirements for the caller are:

Environmental factor	Requirement
Minimum authorization:	Problem state and any PSW key
Dispatchable unit mode:	Task
Cross memory mode:	PASN=HASN=SASN
AMODE:	31-bit addressing mode.
ASC mode:	Primary mode.
Interrupt status:	Enabled for I/O and external interrupts.
Locks:	No locks held.
Control parameters:	Must be in the primary address space and addressable by the caller.

Programming requirements

Either link the object code of the calling program with the linkable stub routine (IEACSS from SYS1.CSSLIB) or have the calling program LOAD and then CALL the service. The high-level language (HLL) definitions for the callable service are:

HLL Definition	Description
IEAASM	390 Assembler declarations
IEAC	C/390 and C++/390 declarations

Restrictions

Pause elements that are created with `pause_element_auth_level=IEA_UNAUTHORIZED` can be used only by callers in task mode and can be released only from a task in their home address space.

Key 1-15 or problem state callers must specify linkage as `IEA_LINKAGE_SVC`.

Pause cannot be used by tasks that are higher in the task tree than the cross memory resource owning task (the top, or first, job step task in the address space).

Input register information

Before calling the Pause service, the caller must ensure that the following general purpose registers (GPRs) contain the specified information:

Register Contents

- 1** Address of the parameter address list.
- 13** Address of a 72-byte register save area.

Output register information

When control returns to the caller, the GPRs contain:

Register Contents

- 0-1** Used as work registers by the system
- 2-13** Unchanged
- 14** Used as work registers by the system
- 15** Return code

When control returns to the caller, the access registers (ARs) contain:

Register Contents

- 0-1** Used as work registers by the system
- 2-13** Unchanged
- 14-15** Used as a work register by the system

Some callers depend on register contents remaining the same before and after issuing a service. If the system changes the contents of registers on which the caller depends, the caller must save them before issuing the service, and restore them after the system returns control.

Performance implications

None.

Syntax

Syntax	Description
CALL IEAVPSE2	,(return_code ,pause_element_token ,updated_pause_element_token ,release_code ,linkage)

Parameters

The parameters are explained as follows:

return_code

Returned parameter

- Type: Integer
- Character Set: N/A
- Length: 4 bytes

Contains the return code from the Pause service.

,pause_element_token

Supplied parameter

- Type: Character string
- Character Set: N/A
- Length: 16 bytes

A pause element token that identifies the pause element being used to pause the current task or SRB. You obtain the PET from the Allocate_Pause_Element service.

When you use a PET in a call to the Pause service, you cannot reuse the PET on a second call to Pause or on a call to Transfer. The Pause service returns a new PET in updated_pause_element_token. The new PET now identifies the pause element used to pause the task or SRB; use the new PET the next time you make a Pause request using the same Pause element.

,updated_pause_element_token

Returned parameter

- Type: Character string
- Character Set: N/A
- Length: 16 bytes

A new pause element token that identifies the pause element originally identified by the PET specified in pause_element_token. This new PET must be used in place of the PET specified in pause_element_token on future calls to the Pause, Release, Transfer, or Deallocate_Pause_Element service. If the paused workunit was released by the system (the release code is the owner_termination_release_code specified on the IEAVAPE1 allocation), the PET returned will be 16 bytes of binary zeros, an invalid value.

,release_code

Returned parameter

- Type: Character string
- Character Set: N/A
- Length: 3 bytes

The release code, specified by the issuer of the Release service. A Release that specified this code released the task or SRB from its paused condition.

linkage

Supplied parameter

- Type: Integer
- Character Set: N/A
- Length: 4 bytes

Specifies how the Pause service routine is to be invoked. The following options are supported:

IEAVPSE2 callable service

Variable	Value (hexadecimal)	Meaning
IEA_LINKAGE_SVC	0	The Pause service routine will be invoked by an SVC linkage. This option can be used when in non-cross memory task mode, in any key, and either problem state or supervisor state.
IEA_LINKAGE_BRANCH	1	The Pause service routine will be invoked by a branch instruction. The caller must be in both key 0 and supervisor state. This option must be selected when in SRB mode.

ABEND codes

Abend Code	Reason Code	Description
AC7	001A0001	This is an internal error. Contact IBM support.

Return codes

When the service returns control to your program, GPR 15 contains one of the following return codes:

Return code in: Decimal (Hex)	Equate symbol	Meaning and Action
00 (00)	IEA_SUCCESS	Meaning: Successful completion. Action: None
04 (04)	IEA_PE_TOKEN_BAD	Meaning: Program error. The specified pause element token is not valid. The system rejects the service call. Action: Check the calling program for a probable coding error. Correct the program and rerun it.
08 (08)	IEA_PE_TOKEN_STALE	Meaning: The specified pause element token is stale; that is, it was valid but has been used on the Pause or Transfer service. This service requires the updated PET returned on Pause or Transfer. Action: Check the calling program for a probable coding error. Correct the program and rerun it.
12 (0C)	IEA_DUPLICATE_PAUSE	Meaning: The work unit has already been paused using the specified pause element token. The system rejects the service call. Action: Check the calling program for a probable coding error. Correct the program and rerun it.
24 (18)	IEA_LOCK_HELD	Meaning: Program error. The caller is holding one or more locks; no locks must be held. The system rejects the service call. Action: Check the calling program for a probable coding error. Correct the program and rerun it.
32 (20)	IEA_PE_BAD_STATE	Meaning: Program error. The pause element associated with the pause element token specified in the call is not in a valid state. The system rejects the service call. Action: Check the calling program for a probable coding error, such as attempting to perform a Pause or Transfer using a pause element token that has already been used to Pause or Transfer by another unit of work. Correct the program and rerun it.
36 (24)	IEA_UNSUPPORTED_MVS_RELEASE	Meaning: Environmental error. The system release does not support this service. The system rejects the service call. Action: Run the program on a system that supports the service.

Return code in: Decimal (Hex)	Equate symbol	Meaning and Action
44 (2C)	IEA_INVALID_MODE	<p>Meaning: Program error. The calling program is not in primary ASC mode, which this service requires. The system rejects the service call.</p> <p>Action: Check the calling program for a probable coding error. Correct the program and rerun it.</p>
52 (34)	IEA_ALREADY_SUSPENDED	<p>Meaning: The pause element was already paused.</p> <p>Action: Check the calling program for a probable coding error and correct the program and rerun it.</p>
60 (3C)	IEA_AUTH_TOKEN	<p>Meaning: Program error. The caller was in Problem state or key 8, but the pause element token was allocated with pause_element_auth_level=IEA_AUTHORIZED. The system rejects the service call.</p> <p>Action: Program error. The specified pause element token is not valid. The system rejects the service call.</p>
64 (40)	IEA_PE_NOT_HOME	<p>Meaning: Program error. The pause element token was for a pause element allocated with pause_element_auth_level=IEA_UNAUTHORIZED to another address space.</p> <p>Action: Check the calling program for a probable coding error. Correct the program and rerun it.</p>
76 (4C)	IEA_ABENDED_47B	<p>Meaning: After an SRB received ABEND 47B, it invoked IEAVPSE2. It is not valid to invoke IEAVPSE2 after receiving ABEND 47B.</p> <p>Action: Update the calling program to not invoke IEAVPSE2 after ABEND 47B.</p>
80 (50)	IEA_IN_SUSPEND_EXIT	<p>Meaning: The suspend exit specified on SUSPEND with SPTOKEN of an SRB invoked IEAVPSE2. It is not valid to invoke IEAVPSE2 from a suspend exit.</p> <p>Action: Update the calling program to not invoke IEAVPSE2 from a suspend exit.</p>
84 (54)	IEA_INVALID_LINKAGE	<p>Meaning: Program error. The linkage value specified is not valid. The system rejects the service call.</p> <p>Action: Check the calling program for a probable coding error. Correct the program and rerun it.</p>
4095 (FFF)	IEA_UNEXPECTED_ERROR	<p>Meaning: This service routine encountered an unexpected error. The system rejects this service request.</p> <p>Action: Contact IBM support.</p>

Chapter 31. IEAVRLS – Release

Description

Call Release to remove a task that has been paused, or to keep a task from being paused. Although a pause element can be used multiple times to pause a task, a pause element token can be used to successfully pause and release a task only once. Each time a pause element is used, the system generates a new PET to identify the pause element. The system returns the new updated PET on calls to the Pause and Transfer services.

Environment

The requirements for the caller are:

Environmental factor	Requirement
Minimum authorization:	Problem state and any PSW key.
Dispatchable unit mode:	Task
Cross memory mode:	PASN=HASN=SASN
AMODE:	31-bit addressing mode.
ASC mode:	Primary mode.
Interrupt status:	Enabled for I/O and external interrupts.
Locks:	No locks held.
Control parameters:	Must be in the primary address space and addressable by the caller.

Programming requirements

Either link the calling program's object code with the linkable stub routine (IEACSS from SYS1.CSSLIB), or load the calling program and then call the service. The high-level language (HLL) definitions for the callable service are:

HLL Definition	Description
IEAASM	390 Assembler declarations
IEAC	C/390 and C++/390 declarations

Restrictions

When the calling program specifies `auth_level=IEA_UNAUTHORIZED`, the caller must be in task mode and can only release another task in its home address space. All pause element tokens (PETs) used when `auth_level=IEA_UNAUTHORIZED` must have been obtained using an authorization level of `IEA_UNAUTHORIZED`.

Input register information

Before calling the Release service, the caller must ensure that the following general purpose (GPRs) contain the specified information:

Register Contents

IEAVRLS callable service

- 1** Address of the parameter address list.
- 13** Address of a 72-byte register save area.

Output register information

When control returns to the caller, the general purpose registers (GPRs) contain:

Register Contents

- 0-1** Used as work registers by the system
- 2-13** Unchanged
- 14** Used as a work register by the system
- 15** Return code

When control returns to the caller, the access registers (ARs) contain:

Register Contents

- 0-1** Used as work registers by the system
- 2-13** Unchanged
- 14-15** Used as a work register by the system

Some callers depend on register contents remaining the same before and after issuing a service. If the system changes the contents of registers on which the caller depends, the caller must save them before issuing the service, and restore them after the system returns control.

Performance implications

None.

Syntax

Syntax	Description
CALL IEAVRLS	,(return_code ,auth_level ,target_du_pause_element_token ,target_du_release_code)

Parameters

The parameters are explained as follows:

- return_code**
Returned parameter

- Type: Integer
- Character Set: N/A
- Length: 4 bytes

Contains the return from the Release service.

,auth_level

Supplied Parameter

- Type: Integer
- Character Set: N/A
- Length: 4 bytes

Indicates the maximum authorization level that the specified pause element was allocated with. IEAASM and IEAC define constants IEA_UNAUTHORIZED and IEA_AUTHORIZED, which the calling program can use. The following levels are supported:

Variable	Value (HEX)	Meaning
IEA_UNAUTHORIZED	0	The pause element being released must have been allocated with auth_level=IEA_UNAUTHORIZED.

,target_du_pause_element_token

Supplied parameter

- Type: Character string
- Character Set: N/A
- Length: 16 bytes

Contains the pause element token that identifies the pause element used to pause the task. If the PET identifies a pause element that has not been paused (that is, the task has not been paused), the task will not be paused. However, the value specified in target_du_release_code will be returned to the caller of Pause.

,target_du_release_code

Supplied parameter

- Type: Character string
- Character Set: N/A
- Length: 3 bytes

Contains the release code returned to the caller of Pause or Transfer service that used (or will use) the same PET to pause a task. If your program is not using this code for communication, set this field to zero.

ABEND codes

None.

Return codes

When the service returns control to the resource manager, GPR 15 and return_code contain a hexadecimal return code.

Return code in: Decimal (Hex) Equate symbol	Meaning and Action
00 (00) IEA_SUCCESS	Meaning: Successful completion. Action: None.

IEAVRLS callable service

Return code in: Decimal (Hex) Equate symbol	Meaning and Action
04 (04) IEA_PE_TOKEN_BAD	<p>Meaning: The specified pause element token is not valid. The system rejects the service call.</p> <p>Action: Check the calling program for a probable coding error. Correct the program and rerun it.</p>
08 (08) IEA_PE_TOKEN_STALE	<p>Meaning: The specified pause element token is stale; that is, it was valid but has been used on the Pause or Transfer service. This service requires the updated PET be returned on Pause or Transfer.</p> <p>Action: Check the calling program for a probable coding error. Correct the program and rerun it.</p>
16 (10) IEA_SLEEP_DISRUPTED	<p>Meaning: RTM has terminated the task; no release is necessary.</p> <p>Action: None</p>
20 (14) IEA_SPACE_TERMINATING	<p>Meaning: The address space that contains the task that is terminating; no release is necessary.</p> <p>Action: None</p>
24 (18) IEA_LOCK_HELD	<p>Meaning: Program error. The caller is holding one or more locks; no locks must be held. The system rejects the service call.</p> <p>Action: Check the calling program for a probable coding error. Correct the program and rerun it.</p>
32 (20) IEA_PE_BAD_STATE	<p>Meaning: Program error. The pause element associated with the pause element token specified is invalid or has already been prereleased.</p> <p>Action: Check the calling program for a probable coding error. Correct the program and rerun it.</p>
36 (24) IEA_UNSUPPORTED_MVS_RELEASE	<p>Meaning: Environmental error. The system release does not support this service. The system rejects the service call.</p> <p>Action: Run the program on a system that supports the service.</p>
40 (28) IEA_INVALID_AUTHCODE	<p>Meaning: Program error. The auth_level value specified in the call is not valid. The system rejects the service call.</p> <p>Action: Check the calling program for a probable coding error. Correct the program and rerun it.</p>
44 (2C) IEA_INVALID_MODE	<p>Meaning: Program error. The calling program is not in primary ASC mode, which this service requires. The system rejects the service call.</p> <p>Action: Check the calling program for a probable coding error. Correct the program and rerun it.</p>
60 (3C) IEA_AUTH_TOKEN	<p>Meaning: Program error. The caller specified auth_level=UNAUTHORIZED, but the pause element token was allocated with auth_level=AUTHORIZED. The system rejects the service call.</p> <p>Action: Program error. The specified pause element token is not valid. The system rejects the service call.</p>
64 (40) IEA_PE_NOT_HOME	<p>Meaning: Program error. The caller specified auth_level=UNAUTHORIZED, but the pause element token was for a pause element allocated to another address.</p> <p>Action: Check the calling program for a probable coding error. Correct the program and rerun it.</p>
4095 (FFF) IEA_UNEXPECTED_ERROR	<p>Meaning: This service routine encountered an unexpected error. The system rejects this service request.</p> <p>Action: Contact IBM support.</p>

Chapter 32. IEAVRLS2 – Release

Description

Call Release to remove a task or SRB that has been paused, or to keep a task or SRB from being paused.

Although a pause element can be used multiple times to pause a task or SRB, a pause element token can be used to successfully pause and release a task or SRB only once. Each time a pause element is used, the system generates a new PET to identify the pause element. The system returns the new updated PET on calls to the Pause and Transfer services.

Environment

The requirements for the caller are:

Environmental factor	Requirement
Minimum authorization:	Problem state and any PSW key
Dispatchable unit mode:	Task
Cross memory mode:	PASN=HASN=SASN
AMODE:	31-bit addressing mode.
ASC mode:	Primary mode.
Interrupt status:	Enabled for I/O and external interrupts.
Locks:	No locks held.
Control parameters:	Must be in the primary address space and addressable by the caller.

Programming requirements

Either link the object code of the calling program with the linkable stub routine (IEACSS from SYS1.CSSLIB) or have the calling program LOAD and then CALL the service. The high-level language (HLL) definitions for the callable service are:

HLL Definition	Description
IEAASM	390 Assembler declarations
IEAC	C/390 and C++/390 declarations

Restrictions

Pause elements that are created with `pause_element_auth_level=IEA_UNAUTHORIZED` may only be used by callers in task mode and can only be released from a task in their home address space.

Key 1-15 or problem state callers must specify linkage as `IEA_LINKAGE_SVC`.

Release cannot be used by tasks that are higher in the task tree than the cross memory resource owning task (the top, or first, job step task in the address space).

Input register information

Before calling the Release service, the caller must ensure that the following general purpose (GPRs) contain the specified information:

IEAVRLS2 callable service

Register Contents

- 1** Address of the parameter address list.
- 13** Address of a 72-byte register save area.

Output register information

When control returns to the caller, the general purpose registers (GPRs) contain:

Register Contents

- 0-1** Used as work registers by the system
- 2-13** Unchanged
- 14** Used as a work register by the system
- 15** Return code

When control returns to the caller, the access registers (ARs) contain:

Register Contents

- 0-1** Used as work registers by the system
- 2-13** Unchanged
- 14-15** Used as a work register by the system

Some callers depend on register contents remaining the same before and after issuing a service. If the system changes the contents of registers on which the caller depends, the caller must save them before issuing the service, and restore them after the system returns control.

Performance implications

None.

Syntax

Syntax	Description
CALL IEAVRLS2	,(return_code ,,target_du_pause_element_token ;target_du_release_code ;linkage)

Parameters

The parameters are explained as follows:

return_code

Returned parameter

- Type: Integer
- Character Set: N/A
- Length: 4 bytes

Contains the return from the Release service.

,target_du_pause_element_token

Supplied parameter

- Type: Character string
- Character Set: N/A
- Length: 16 bytes

Contains the pause element token that identifies the pause element used to pause a task or SRB. You obtain the PET from the Allocate_Pause_Element service.

When you use a PET in a call to the Pause service, you cannot reuse the PET on a second call to Pause or on a call to Transfer. The Pause service returns a new PET in updated_pause_element_token. The new PET now identifies the pause element used to pause the task or SRB; use the new PET the next time you make a Pause request using the same Pause element.

,target_du_release_code

Supplied parameter

- Type: Character string
- Character Set: N/A
- Length: 4 bytes

Contains the release code returned to the caller of Pause or Transfer service that used (or will use) the same PET to pause a task or SRB. If your program is not using this code for communication, set this field to zero.

linkage

Supplied parameter

- Type: Integer
- Character Set: N/A
- Length: 4 bytes

Specifies how the Release service routine is to be invoked. The following options are supported:

Variable	Value (hexadecimal)	Meaning
IEA_LINKAGE_SVC	0	The Release service routine will be invoked by an SVC linkage. This option can be used when in non-cross memory task mode, in any key, and either problem state or supervisor state.
IEA_LINKAGE_BRANCH	1	The Release service routine will be invoked by a branch instruction. The caller must be in both key 0 and supervisor state. This option must be selected when in SRB mode.

ABEND codes

None.

Return codes

When the service returns control to the resource manager, GPR 15 and return_code contain a hexadecimal return code.

IEAVRLS2 callable service

Return code: Decimal (Hex)	Equate symbol	Meaning and Action
00 (00)	IEA_SUCCESS	Meaning: Successful completion. Action: None.
04 (04)	IEA_PE_TOKEN_BAD	Meaning: The specified pause element token is not valid. The system rejects the service call. Action: Check the calling program for a probable coding error. Correct the program and rerun it.
08 (08)	IEA_PE_TOKEN_STALE	Meaning: The specified pause element token is stale; that is, it was valid but has been used on the Pause or Transfer service. This service requires the updated PET returned on Pause or Transfer. Action: Check the calling program for a probable coding error. Correct the program and rerun it.
16 (10)	IEA_SLEEP_INTERRUPTED	Meaning: RTM has terminated the task or SRB; no release is necessary. Action: None
20 (14)	IEA_SPACE_TERMINATING	Meaning: The address space that contains the task or SRB is terminating; no release is necessary. Action: None
24 (18)	IEA_LOCK_HELD	Meaning: Program error. The caller is holding one or more locks; other than the local lock, CMS, or CPU lock, no locks may be held. The system rejects the service call. Action: Check the calling program for a probable coding error. Correct the program and rerun it.
32 (20)	IEA_PE_BAD_STATE	Meaning: Program error. The pause element associated with the pause element token specified is invalid or has already been prereleased. Action: Check the calling program for a probable coding error. Correct the program and rerun it.
36 (24)	IEA_UNSUPPORTED_MVS_RELEASE	Meaning: Environmental error. The system release does not support this service. The system rejects the service call. Action: Run the program on a system that supports the service.
44 (2C)	IEA_INVALID_MODE	Meaning: Program error. The calling program is not in primary ASC mode, which this service requires. The system rejects the service call. Action: Check the calling program for a probable coding error. Correct the program and rerun it.
60 (3C)	IEA_AUTH_TOKEN	Meaning: Program error. The caller was in Problem state or key 8, but the pause element token was allocated with pause_element_auth_level=IEA_AUTHORIZED. The system rejects the service call. Action: Program error. The specified pause element token is not valid. The system rejects the service call.
64 (40)	IEA_PE_NOT_HOME	Meaning: Program error. The pause element token was for a pause element allocated with pause_element_auth_level=IEA_UNAUTHORIZED to another address space. Action: Check the calling program for a probable coding error. Correct the program and rerun it.
84 (54)	IEA_INVALID_LINKAGE	Meaning: Program error. The linkage value specified is not valid. The system rejects the service call. Action: Check the calling program for a probable coding error. Correct the program and rerun it.

Return code: Decimal (Hex)	Equate symbol	Meaning and Action
4095 (FFF)	IEA_UNEXPECTED_ERROR	Meaning: This service routine encountered an unexpected error. The system rejects this service request. Action: Contact IBM support.

Chapter 33. IEAVRPI – Retrieve_Pause_Element_Information service

Description

Call Retrieve_Pause_Element_Information to get information about a pause element. The information returned includes:

- Its authorization level
- The address space that currently owns it
- Its current state (Reset, Prereleased, Paused, or Released)
- If its state is Prereleased or Released, its Release Code

An authorized program can use Retrieve_Pause_Element_Information to test the validity of a pause element passed by an unauthorized program. The authorized program can do this to ensure that it does not perform any operation, such as releasing the pause element, unless the unauthorized program is also able to perform the same operation.

Environment

The requirements for the caller are:

Environmental factor	Requirement
Minimum authorization:	Problem state and any PSW key
Dispatchable unit mode:	Task
Cross memory mode:	PASN=HASN=SASN
AMODE:	31-bit addressing mode
ASC mode:	Primary mode
Interrupt status:	Enabled for I/O and external interrupts.
Locks:	No locks held.
Control parameters:	Must be in the primary address space and addressable by the caller.

Programming requirements

Either link the calling program's object code with the linkable stub routine (IEACSS from SYS1.CSSLIB) or have the calling program LOAD and then CALL the service. The high-level language (HLL) definitions for the callable service are:

HLL Definition	Description
IEAASM	390 Assembler declarations
IEAC	C/390 and C++/390 declarations

Restrictions

None.

Input register information

Before calling the Retrieve_Pause_Element_Information service, the caller does not need to place any information into any register, unless using it in register notation for the parameters, or using it as a base register.

Output register information

When control returns to the caller, the GPRs contain:

Register Contents

0-1

Used as work registers by the system

2-13

Unchanged

14

Used as a work register by the system

15

Return code

When control returns to the caller, the access registers (ARs) contain:

Register Contents

0-1

Used as work registers by the system

2-13

Unchanged

14-15

Used as work registers by the system

Some callers depend on register contents remaining the same before and after issuing a service. If the system changes the contents of registers on which the caller depends, the caller must save them before issuing the service, and restore them after the system returns control.

Performance implications

None.

Syntax

Syntax	Description
CALL IEAVRPI	,(return_code ,auth_level ,pause_element_token ,authorization ,owner ,state ,release_code)

Parameters

The parameters are explained as follows:

return_code

Returned parameter

- Type: Integer
- Character Set: N/A
- Length: 4 bytes

Contains the return code from the Retrieve_Pause_Element_Information service.

,auth_level

Supplied parameter

- Type: Integer
- Character Set: N/A
- Length: 4 bytes

Indicates the caller's authorization level. The following levels are supported: IEAASM and IEAC define constants IEA_UNAUTHORIZED and IEA_AUTHORIZED, which can be used by the calling program.

Variable	Value (hexadecimal)	Meaning
IEA_UNAUTHORIZED	0	The caller is not key 0 and supervisor state.
IEA_AUTHORIZED	1	The caller is both key 0 and supervisor state.

,pause_element_token

Supplied parameter

- Type: Character string
- Character Set: N/A
- Length: 16 bytes

A pause element token that identifies the pause element for which information will be returned. You obtain the PET from the Allocate_Pause_Element service.

,authorization

Returned parameter

- Type: Integer
- Character Set: N/A
- Length: 4 bytes

The authorization level of the creator of the pause element specified by the input PET.

One of the following values:

IEAASM and IEAC defined constants	Value (hexadecimal)	Meaning
IEA_UNAUTHORIZED	0	The caller is not key 0 and supervisor state.
IEA_AUTHORIZED	1	The caller is not key 0 and supervisor state.
IEA_UNAUTHORIZED + IEA_CHECKPOINTOK	2	Unauthorized PET that can tolerate the pause elements' not being restored upon a restart after a checkpoint.
IEA_AUTHORIZED + IEA_CHECKPOINTOK	3	Authorized PET that can tolerate the pause elements' not being restored upon a restart after a checkpoint.

,owner

Returned parameter

- Type: Character string
- Character Set: N/A

IEAVRPI callable service

- Length: 8 bytes

The Token of the address space that currently owns the pause element specified by the input PET.

,state

Returned parameter

- Type: Integer
- Character Set: N/A
- Length: 4 bytes

The state of the pause element specified by the input PET.

Note: The value returned is the state at the time the service obtained it. The state may have changed after it was obtained.

State Constant Hexadecimal (Decimal)	Meaning
IEAV_PET_PRERELEASED 1 (1)	The PE was released before any task or SRB was suspended on it, and no task or SRB has attempted to pause it.
IEAV_PET_RESET 2 (2)	The PE is not being used to make any task or SRB nondispatchable. If the PE is used in an attempt to pause the current task or SRB, the task or SRB will be made nondispatchable.
IEAV_PET_RELEASED 40 (64)	The task RB or SRB is currently dispatchable, but control has not been returned to the task or SRB following a call to the Pause or Transfer service. A call to the Release or Transfer service has released the task or SRB. In either case, control has not been returned to the caller of the Pause or Transfer service. The system has not transitioned the PE into the RESET state.
IEAV_PET_PAUSED 80 (128)	A task RB or SRB is currently nondispatchable. Its dispatchability is controlled by the PE.

,release_code

Returned parameter

- Type: Character string
- Character Set: N/A
- Length: 3 bytes

The release code, specified by the issuer of the Release service. A Release that specified this code released the task or SRB from its paused condition.

Note: The returned value is random if the state parameter is not IEAV_PET_RELEASED or IEAV_PET_PRERELEASED.

ABEND codes

None.

Return codes

When the service returns control to your program, GPR 15 contains one of the following return codes:

Return code in: Decimal (Hex)	Equate symbol	Meaning and Action
00 (00)	IEA_SUCCESS	Meaning: Successful completion. Action: None
04 (04)	IEA_PE_TOKEN_BAD	Meaning: Program error. The specified pause element token is not valid. The system rejects the service call. Action: Check the calling program for a probable coding error. Correct the program and rerun it.
08 (08)	IEA_PE_TOKEN_STALE	Meaning: The specified pause element token is stale; that is, it was valid but has been used on the Pause or Transfer service. This service requires the updated PET returned on Pause or Transfer. Action: Check the calling program for a probable coding error. Correct the program and rerun it.
24 (18)	IEA_LOCK_HELD	Meaning: Program error. The caller is holding one or more locks; no locks must be held. The system rejects the service call. Action: Check the calling program for a probable coding error. Correct the program and rerun it.
36 (24)	IEA_UNSUPPORTED_MVS_RELEASE	Meaning: Environmental error. The system release does not support this service. The system rejects the service call. Action: Run the program on a system that supports the service.
44 (2C)	IEA_INVALID_MODE	Meaning: Program error. The calling program is not in primary ASC mode, which this service requires. The system rejects the service call. Action: Check the calling program for a probable coding error. Correct the program and rerun it.
60 (3C)	IEA_AUTH_TOKEN	Meaning: Program error. The caller specified an unauthorized auth_level type, but a pause element token allocated with an authorized auth_level type was encountered. The system rejects the service call. Action: Program error. The specified pause element token is not valid. The system rejects the service call.
64 (40)	IEA_PE_NOT_HOME	Meaning: Program error. The caller specified an unauthorized auth_level type, but a pause element token for a pause element allocated to another address space was specified. Action: Check the calling program for a probable coding error. Correct the program and rerun it.
4095 (FFF)	IEA_UNEXPECTED_ERROR	Meaning: This service routine encountered an unexpected error. The system rejects this service request. Action: Contact IBM support.

Chapter 34. IEAVRPI2 – Retrieve_Pause_Element_Information service

Description

Call Retrieve_Pause_Element_Information to get information about a pause element. The information returned includes:

- Its authorization level
- Its current state (Reset, Prereleased, Paused, or Released)
- If its state is Prereleased or Released, its Release Code
- The token of the owner of the pause element (See [IEAVAPE – Allocate_Pause_Element](#) for details of ownership).
- The token of the home address space of the task or SRB which is paused by the pause element.

An authorized program can use Retrieve_Pause_Element_Information to test the validity of a pause element passed by an unauthorized program. The authorized program may do this to ensure that it does not perform any operation, such as releasing the pause element, unless the unauthorized program is also able to perform the same operation.

Environment

The requirements for the caller are:

Environmental factor	Requirement
Minimum authorization:	Problem state and any PSW key
Dispatchable unit mode:	Task
Cross memory mode:	PASN=HASN=SASN
AMODE:	31-bit addressing mode.
ASC mode:	Primary mode.
Interrupt status:	Enabled for I/O and external interrupts.
Locks:	No locks held.
Control parameters:	Must be in the primary address space and addressable by the caller.

Programming requirements

Either link the calling program's object code with the linkable stub routine (IEACSS from SYS1.CSSLIB) or have the calling program LOAD and then CALL the service. The high-level language (HLL) definitions for the callable service are:

HLL Definition	Description
IEAASM	390 Assembler declarations
IEAC	C/390 and C++/390 declarations

Key 2-15 or problem state callers must specify linkage as IEA_LINKAGE_SVC.

Restrictions

Pause elements that are created with `pause_element_auth_level=IEA_UNAUTHORIZED` may only be used by callers in task mode and can only be released from a task in their home address space.

Input register information

Before calling the `Retrieve_Pause_Element_Information` service, the caller must ensure that the following general purpose registers (GPRs) contain the specified information:

Register**Contents****1**

Address of the parameter address list

13

Address of a 72-byte register save area

Output register information

When control returns to the caller, the GPRs contain:

Register**Contents****0-1**

Used as work registers by the system

2-13

Unchanged

14

Used as a work register by the system

15

Return code

When control returns to the caller, the access registers (ARs) contain:

Register**Contents****0-1**

Used as work registers by the system

2-13

Unchanged

14-15

Used as work registers by the system

Some callers depend on register contents remaining the same before and after issuing a service. If the system changes the contents of registers on which the caller depends, the caller must save them before issuing the service, and restore them after the system returns control.

Performance implications

None.

Syntax

Syntax	Description
CALL IEAVRPI2	,(return_code ,pause_element_auth_level ,pause_element_token ,linkage ,owner_stoken ,current_stoken ,state ,release_code)

Parameters

The parameters are explained as follows:

return_code

Returned parameter

- Type: Integer
- Character Set: N/A
- Length: 4 bytes

Contains the return code from the Retrieve_Pause_Element_Information service.

,pause_element_auth_level

Returned parameter

- Type: Integer
- Character Set: N/A
- Length: 4 bytes

Indicates the authorization level with which the pause element specified by the input PET was allocated. The following levels are supported:

Variable	Value (hexadecimal)	Meaning
IEA_PET_UNAUTHORIZED	0	The pause element was allocated with pause_element_auth_level=IEA_UNAUTHORIZED.
IEA__PET_AUTHORIZED	1	The pause element was allocated with pause_element_auth_level=IEA_AUTHORIZED.

,pause_element_token

Supplied parameter

- Type: Character string
- Character Set: N/A
- Length: 16 bytes

A pause element token that identifies the pause element for which information will be returned. You obtain the PET from the Allocate_Pause_Element service.

linkage

Supplied parameter

- Type: Integer
- Character Set: N/A

IEAVRPI2 callable service

- Length: 4 bytes

Specifies how the Retrieve_Pause_Element_Information service routine is to be invoked. The following options are supported:

Variable	Value (hexadecimal)	Meaning
IEA_LINKAGE_SVC	0	The Retrieve_Pause_Element_Information service routine will be invoked by an SVC linkage. This option can be used when in non-cross memory task mode, in any key, and in either problem state or supervisor state.
IEA_LINKAGE_BRANCH	1	The Retrieve_Pause_Element_Information service routine will be invoked by a branch instruction. The caller must be in both key 0 and supervisor state. This option must be selected when in SRB mode.

,owner_stoken

Returned parameter

- Type: Character string
- Character Set: N/A
- Length: 8 bytes

Specifies the stoken of the address space that currently owns the pause element specified by the input PET. The owner of a PE allocated by IEAVAPE2 is static and specified on the IAVEAPE2 call. The owner of a PE allocated by IEAVAPE is dynamic. See [IEAVAPE — Allocate_Pause_Element](#) for details.

,current_stoken

Returned parameter

- Type: Character string
- Character Set: N/A
- Length: 8 bytes

If the value returned in state is IEA_PET_PAUSED, The stoken of the home address space of the task or SRB which is paused by the specified pause element. If the value in state is not IEA_PET_PAUSED, the information returned in this parameter is undefined.

,state

Returned parameter

- Type: Integer
- Character Set: N/A
- Length: 4 bytes

The state of the pause element specified by the input PET.

Note: The value returned is the state at the time the service obtained it. The state may have changed after it was obtained.

State Constant Hexadecimal (Decimal)	Meaning
IEAV_PET_PRERELEASED 1 (1)	The PE was released before any task or SRB was suspended on it, and no task or SRB has attempted to pause it.

State Constant Hexadecimal (Decimal)	Meaning
IEAV_PET_RESET 2 (2)	The PE is not being used to make any task or SRB nondispatchable. If the PE is used in an attempt to pause the current task or SRB, the task or SRB will be made nondispatchable.
IEAV_PET_RELEASED 40 (64)	The task RB or SRB is currently dispatchable, but control has not been returned to the task or SRB following a call to the Pause or Transfer service. A call to the Release or Transfer service has released the task or SRB. In either case, control has not been returned to the caller of the Pause or Transfer service. The system has not transitioned the PE into the RESET state.
IEAV_PET_PAUSED 80 (128)	A task RB or SRB is currently nondispatchable. Its dispatchability is controlled by the PE.

,release_code

Returned parameter

- Type: Character string
- Character Set: N/A
- Length: 3 bytes

The release code, specified by the issuer of the Release service. A Release that specified this code released the task or SRB from its paused condition.

Note: The returned value is random if the state parameter is not IEAV_PET_RELEASED or IEAV_PET_PRERELEASED.

ABEND codes

None.

Return codes

When the service returns control to your program, GPR 15 contains one of the following return codes:

Return code: Decimal (Hex)	Equate symbol	Meaning and Action
00 (00)	IEA_SUCCESS	Meaning: Successful completion. Action: None
04 (04)	IEA_PE_TOKEN_BAD	Meaning: Program error. The specified pause element token is not valid. The system rejects the service call. Action: Check the calling program for a probable coding error. Correct the program and rerun it.
08 (08)	IEA_PE_TOKEN_STALE	Meaning: The specified pause element token is stale; that is, it was valid but has been used on the Pause or Transfer service. This service requires the updated PET returned on Pause or Transfer. Action: Check the calling program for a probable coding error. Correct the program and rerun it.

IEAVRPI2 callable service

Return code: Decimal (Hex)	Equate symbol	Meaning and Action
24 (18)	IEA_LOCK_HELD	<p>Meaning: Program error. The caller is holding one or more locks; no locks must be held. The system rejects the service call.</p> <p>Action: Check the calling program for a probable coding error. Correct the program and rerun it.</p>
36 (24)	IEA_UNSUPPORTED_MVS_RELEASE	<p>Meaning: Environmental error. The system release does not support this service. The system rejects the service call.</p> <p>Action: Run the program on a system that supports the service.</p>
40 (28)	IEA_INVALID_AUTHCODE	<p>Meaning: Program error. The pause_element_auth_level value specified in the call is not valid. The system rejects the service call.</p> <p>Action: Check the calling program for a probable coding error. Correct the program and rerun it.</p>
44 (2C)	IEA_INVALID_MODE	<p>Meaning: Program error. The calling program is not in primary ASC mode, which this service requires. The system rejects the service call.</p> <p>Action: Check the calling program for a probable coding error. Correct the program and rerun it.</p>
60 (3C)	IEA_AUTH_LEVEL_MISMATCH	<p>Meaning: Program error. The caller was in Problem state or key 8, but the pause element token was allocated with pause_element_auth_level=IEA_AUTHORIZED. The system rejects the service call.</p> <p>Action: Program error. The specified pause element token is not valid. The system rejects the service call.</p>
84 (54)	IEA_INVALID_LINKAGE	<p>Meaning: Program error. The linkage value specified is not valid. The system rejects the service call.</p> <p>Action: Check the calling program for a probable coding error. Correct the program and rerun it.</p>
4095 (FFF)	IEA_UNEXPECTED_ERROR	<p>Meaning: This service routine encountered an unexpected error. The system rejects this service request.</p> <p>Action: Contact IBM support.</p>

Chapter 35. IEAVTPE – Test_Pause_Element service

Description

Call Test_Pause_Element to test a pause element and determine its state. If its state is Prereleased or Released, the pause element's release code will also be returned.

To ensure minimal overhead when you use the service, Test_Pause_Element establishes no recovery. You are responsible for supplying any needed recovery to handle errors that occur due to invalid input pause element Tokens or call state errors.

Environment

The requirements for the caller are:

Environmental factor	Requirement
Minimum authorization:	Problem state and any PSW key
Dispatchable unit mode:	Task
Cross memory mode:	PASN=HASN=SASN
AMODE:	31-bit addressing mode.
ASC mode:	Primary mode.
Interrupt status:	Enabled for I/O and external interrupts.
Locks:	No locks held.
Control parameters:	Must be in the primary address space and addressable by the caller.

Programming requirements

Either link the calling program's object code with the linkable stub routine (IEACSS from SYS1.CSSLIB) or have the calling program LOAD and then CALL the service. The high-level language (HLL) definitions for the callable service are:

HLL Definition	Description
IEAASM	390 Assembler declarations
IEAC	C/390 and C++/390 declarations

Restrictions

None.

Input register information

Before calling the Test_Pause_Element service, the caller does not have to place any information into any register, unless using it in register notation for the parameters, or using it as a base register.

Output register information

When control returns to the caller, the GPRs contain:

Register	Contents
----------	----------

IEAVTPE callable service

0-1

Used as work registers by the system

2-13

Unchanged

14

Used as a work register by the system

15

Return code

When control returns to the caller, the access registers (ARs) contain:

Register

Contents

0-1

Used as work registers by the system

2-13

Unchanged

14-15

Used as work registers by the system

Some callers depend on register contents remaining the same before and after issuing a service. If the system changes the contents of registers on which the caller depends, the caller must save them before issuing the service, and restore them after the system returns control.

Performance implications

None.

Syntax

Syntax	Description
CALL IEAVTPE	,(return_code ,pause_element_token ,state ,release_code)

Parameters

The parameters are explained as follows:

return_code

Returned parameter

- Type: Integer
- Character Set: N/A
- Length: 4 bytes

Contains the return code from the Test_Pause_Element service.

,pause_element_token

Supplied parameter

- Type: Character string
- Character Set: N/A
- Length: 16 bytes

A pause element token that identifies the pause element for which information is to be returned. You obtain the PET from the Allocate_Pause_Element service.

,state

Returned parameter

- Type: Integer
- Character Set: N/A
- Length: 4 bytes

The state of the pause element specified by the input PET.

Note: The value returned is the state at the time the service obtained it. The state may have changed after it was obtained.

State Constant Hexadecimal (Decimal)	Meaning
IEAV_PET_PRERELEASED 1 (1)	The PE was released before any task or SRB was suspended on it, and no task or SRB has attempted to pause it.
IEAV_PET_RESET 2 (2)	The PE is not being used to make any task or SRB nondispatchable. If the PE is used in an attempt to pause the current task or SRB, the task or SRB will be made nondispatchable.
IEAV_PET_RELEASED 40 (64)	The task RB or SRB is currently dispatchable, but control has not been returned to the task or SRB following a call to the Pause or Transfer service. A call to the Release or Transfer service has released the task or SRB. In either case, control has not been returned to the caller of the Pause or Transfer service. The system has not transitioned the PE into the RESET state.
IEAV_PET_PAUSED 80 (128)	A task RB or SRB is currently nondispatchable. Its dispatchability is controlled by the PE.

,release_code

Returned parameter

- Type: Character string
- Character Set: N/A
- Length: 3 bytes

The release code, specified by the issuer of the Release service. A Release that specified this code released the task or SRB from its paused condition.

Note: The returned value is random if the state parameter is not IEAV_PET_RELEASED or IEAV_PET_PRERELEASED.

ABEND codes

None.

Return codes

When the service returns control to your program, GPR 15 contains one of the following return codes:

Return code in: Decimal (Hex)	Equate symbol	Meaning and Action
00 (00)	IEA_SUCCESS	Meaning: Successful completion. Action: None
04 (04)	IEA_PE_TOKEN_BAD	Meaning: Program error. The specified pause element token is not valid. The system rejects the service call. Action: Check the calling program for a probable coding error. Correct the program and rerun it.
08 (08)	IEA_PE_TOKEN_STALE	Meaning: The specified pause element token is stale; that is, it was valid but has been used on the Pause or Transfer service. This service requires the updated PET returned on Pause or Transfer. Action: Check the calling program for a probable coding error. Correct the program and rerun it.

Chapter 36. IEAVXFR – Transfer service

Description

Call the Transfer service to release a paused task, and, when possible, give it immediate control. This service can also, optionally, pause the task under which the Transfer request is made. If the caller does not request that its task be paused, the caller's task remains dispatchable.

Environment

The requirements for the caller are:

Environmental factor	Requirement
Minimum authorization:	Problem state and any PSW key.
Dispatchable unit mode:	Task
Cross memory mode:	PASN=HASN=SASN
AMODE:	31-bit addressing mode.
ASC mode:	Primary mode.
Interrupt status:	Enabled for I/O and external interrupts
Locks:	No Locks held.
Control parameters:	Must be in the primary address space and addressable by the caller.

Programming requirements

Either link the calling program's object code with the linkable stub routine (IEACSS from SYS1.CSSLIB), or load the calling program and then call the service. The high-level language (HLL) definitions for the callable service are:

HLL Definition	Description
IEAASM	390 Assembler declarations
IEAC	C/390 and C++/390 declarations

Restrictions

When the calling program specifies `auth_level=IEA_UNAUTHORIZED`, the caller must be in task mode and can only transfer to another task in its home address space. All pause element tokens (PETs) used when `auth_level=IEA_UNAUTHORIZED` must have been obtained using an authorization level of `IEA_UNAUTHORIZED`.

Input register information

Before calling the Transfer service, the caller must ensure that the following general purpose registers (GPRs) contain the specified information:

Register Contents

- 1 Address of the parameter address list.

13

Address of a 72-byte register save area.

Output register information

When control returns to the caller, the general purpose registers (GPRs) contain:

Register Contents

0-1

Used as work registers by the system

2-13

Unchanged

14

Used as a work register by the system

15

Return code

When control returns to the caller, the access registers (ARs) contain:

Register Contents

0-1

Used as work registers by the system

2-14

Unchanged

15

Used as a work register by the system

Some callers depend on register contents remaining the same before and after issuing a service. If the system changes the contents of registers on which the caller depends, the caller must save them before issuing the service, and restore them after the system returns control.

Performance implications

None.

Syntax

Syntax	Description
CALL IEAVXFR	,(return_code ,auth_level ,current_du_pause_element_token ,updated_pause_element_token ,current_du_release_code ,target_du_pause_element_token ,target_du_release_code)

Parameters

The parameters are explained as follows:

return_code

Returned parameter

- Type: Integer
- Character Set: N/A
- Length: 4 bytes

Contains the return code from the Transfer service.

,auth_level

Supplied parameter

- Type: Integer
- Character Set: N/A
- Length: 4 bytes

Indicates the maximum authorization level of the pause element being deallocated. IEAASM and IEAC define constants IEA_UNAUTHORIZED and IEA_AUTHORIZED, which the calling program can use. The following levels are supported:

Variable	Value (HEX)	Meaning
IEA_UNAUTHORIZED	0	The pause elements must have been allocated with auth_level=_UNAUTHORIZED.

,current_du_pause_element_token

Supplied parameter

- Type: Character string
- Character Set: N/A
- Length: 16 bytes

Contains a pause element token that identifies the pause element used to pause the current task. Once a PET is used on a call to the Pause service, it cannot be reused on a second call to Pause or as a current_du_pause_element_token on Transfer. A new PET is returned to updated_pause_element_token. The new PET now properly defines the pause element and should be used the next time a pause, transfer, release, or deallocate_pause_element request is made using the same pause element.

If the value specified is 16-bytes of binary zeros, the current task will not be paused. The updated_pause_element_token and current_du_release_code will be unpredictable.



CAUTION: Do not specify the same PET for both current_du_pause_element_token and target_pause_element_token.

,updated_pause_element_token

Returned parameter

- Type: Character string
- Character Set: N/A
- Length: 16 bytes

Contains a new pause element token that identifies the pause element originally identified by the PET specified in current_du_pause_element_token. The PET originally specified in current_du_pause_element_token cannot be reused after a successful call to Pause or Transfer.

If you set the current_du_pause_element_token to zeros, the contents of updated_pause_element_token are unpredictable.

,current_du_release_code

Returned parameter

- Type: Character string
- Character Set: N/A
- Length: 3 bytes

IEAVXFR callable service

Contains the release code set by the issuer of the Release or Transfer service that released the current task from its paused condition.

If you set the `current_du_pause_element_token` to zero, the contents are unpredictable.

,target_du_pause_element_token

Supplied parameter

- Type: Character string
- Character Set: N/A
- Length: 16 bytes

Contains a pause element token that identifies the pause element to release the target task. Any PET that specifies a pause element not currently being used to pause a task is valid. When a PET for a previously released pause element is used to try to pause a task, the task is not paused; however, the value specified in `target_du_release_code` will still be returned to the caller of Pause or Transfer.

If the task was paused and is now dispatchable, the task will immediately be given control on the current processor.



CAUTION: Do not use the same PET for both `current_du_pause_element_token` and `target_du_pause_element_token`.

,target_du_release_code

Supplied parameter

- Type: Character string
- Character Set: N/A
- Length: 3 bytes

Contains the release code returned to the issuer of the Pause or Transfer service that is used (or will use) the same PET to pause a task.

ABEND codes

None.

Return codes

When the service returns control to the resource manager, GPR 15 and `return_code` contain a hexadecimal return code.

Return Code in: Decimal (Hex)	Equate symbol	Meaning and Action
00 (00)	IEA_SUCCESS	Meaning: Successful completion. Action: None
04 (04)	IEA_PE_TOKEN_BAD	Meaning: Program error. The specified pause element token is not valid. The system rejects the service call. Action: Check the calling program for a probable coding error. Correct the program and rerun it.
08 (08)	IEA_PE_TOKEN_STALE	Meaning: The specified pause element token is stale; that is, it was valid but has been used on the Pause or Transfer service. This service requires the updated PET returned on Pause or Transfer. Action: Check the calling program for a probable coding error. Correct the program and rerun it.

Return Code in: Decimal (Hex)	Equate symbol	Meaning and Action
12 (0C)	IEA_DUPLICATE_PAUSE	<p>Meaning: The work unit has already been paused using the specified pause element token. The system rejects the service call.</p> <p>Action: Check the calling program for a probable coding error. Correct the program and rerun it.</p>
16 (10)	IEA_SLEEP_DISRUPTED	<p>Meaning: RTM has terminated the task; no release is necessary.</p> <p>Action: None</p>
20 (14)	IEA_SPACE_TERMINATING	<p>Meaning: The address space that contains the task is terminating; no release is necessary.</p> <p>Action: None</p>
24 (18)	IEA_LOCK_HELD	<p>Meaning: Program error. The caller is holding one or more locks; no locks must be held. The system rejects the service call.</p> <p>Action: Check the calling program for a probable coding error. Correct the program and rerun it.</p>
32 (20)	IEA_PE_BAD_STATE	<p>Meaning: Program error. The pause element associated with the pause element token specified in the call is not in a valid state. The system rejects the service call.</p> <p>Action: Check the calling program for a probable coding error, such as attempting to perform a Pause or Transfer using a pause element token that has already been used to Pause or Transfer by another unit of work. Correct the program and rerun it.</p>
36 (24)	IEA_UNSUPPORTED_MVS_RELEASE	<p>Meaning: Environmental error. The system release does not support this service. The system rejects the service call.</p> <p>Action: Run the program on a system that supports the service.</p>
40 (28)	IEA_INVALID_AUTHCODE	<p>Meaning: Program error. The auth_level value specified in the call is not valid. The system rejects the service call.</p> <p>Action: Check the calling program for a probable coding error. Correct the program and rerun it.</p>
44 (2C)	IEA_INVALID_MODE	<p>Meaning: Program error. The calling program is not in primary ASC mode, which this service requires. The system rejects the service call.</p> <p>Action: Check the calling program for a probable coding error. Correct the program and rerun it.</p>
52 (34)	IEA_ALREADY_SUSPENDED	<p>Meaning: The pause element was already paused.</p> <p>Action: Check the calling program for a probable coding error and correct the program and rerun it.</p>
60 (3C)	IEA_AUTH_TOKEN	<p>Meaning: Program error. The caller specified auth_level=UNAUTHORIZED, but the pause element token was allocated with auth_level=AUTHORIZED. The system rejects the service call.</p> <p>Action: Program error. The specified pause element token is not valid. The system rejects the service call.</p>

IEAVXFR callable service

Return Code in: Decimal (Hex)	Equate symbol	Meaning and Action
64 (40)	IEA_PE_NOT_HOME	Meaning: Program error. The caller specified <code>auth_level=UNAUTHORIZED</code> , but the pause element token was for a pause element allocated to another address. Action: Check the calling program for a probable coding error. Correct the program and rerun it.
68 (44)	IEA_XFER_TO_SELF	Meaning: Program error. The specified <code>current_du_pause_element_token</code> and <code>target_du_pause_element_token</code> are the same. Action: Check the calling program for a probable coding error. Correct the program and rerun it.
72 (48)	IEA_XFER_FAILED	Meaning: The transfer failed, and the <code>current_du_pause_element_token</code> is no longer useable. Action: Reissue the transfer request using the <code>updated_du_pause_element_token</code> . Deallocate the <code>current_du_pause_element_token</code> .
4095 (FFF)	IEA_UNEXPECTED_ERROR	Meaning: This service routine encountered an unexpected error. The system rejects this service request. Action: Contact IBM support.

Chapter 37. IEAVXFR2 – Transfer service

Description

Call the Transfer service to release a paused task or SRB, and, when possible, give it immediate control. This service can also, optionally, pause the task or SRB under which the Transfer request is made. If the caller does not request that its task or SRB be paused, the caller's task or SRB remains dispatchable.

Environment

The requirements for the caller are:

Environmental factor	Requirement
Minimum authorization:	Problem state and any PSW key
Dispatchable unit mode:	Task
Cross memory mode:	PASN=HASN=SASN
AMODE:	31-bit addressing mode.
ASC mode:	Primary mode.
Interrupt status:	Enabled for I/O and external interrupts.
Locks:	No locks held.
Control parameters:	Must be in the primary address space and addressable by the caller.

Programming requirements

Either link the object code of the calling program with the linkable stub routine (IEACSS from SYS1.CSSLIB) or have the calling program LOAD and then CALL the service. The high-level language (HLL) definitions for the callable service are:

HLL Definition	Description
IEAASM	390 Assembler declarations
IEAC	C/390 and C++/390 declarations

Restrictions

Pause elements that are created with `pause_element_auth_level=IEA_UNAUTHORIZED` may only be used by callers in task mode and can only be released from a task in their home address space.

Key 1-15 or problem state callers must specify linkage as `IEA_LINKAGE_SVC`.

Transfer cannot be used by tasks that are higher in the task tree than the cross memory resource owning task (the top, or first, job step task in the address space).

Input register information

Before calling the Transfer service, the caller must ensure that the following general purpose registers (GPRs) contain the specified information:

**Register
Contents**

IEAVXFR2 callable service

- 1** Address of the parameter address list.
- 13** Address of a 72-byte register save area.

Output register information

When control returns to the caller, the general purpose registers (GPRs) contain:

Register Contents

- 0-1** Used as work registers by the system
- 2-13** Unchanged
- 14** Used as a work register by the system
- 15** Return code

When control returns to the caller, the access registers (ARs) contain:

Register Contents

- 0-1** Used as work registers by the system
- 2-14** Unchanged
- 15** Used as a work register by the system

Some callers depend on register contents remaining the same before and after issuing a service. If the system changes the contents of registers on which the caller depends, the caller must save them before issuing the service, and restore them after the system returns control.

Performance implications

None.

Syntax

Syntax	Description
CALL IEAVXFR2	,(return_code ,current_du_pause_element_token ,updated_pause_element_token ,current_du_release_code ,target_du_pause_element_token ,target_du_release_code ,linkage)

Parameters

The parameters are explained as follows:

return_code

Returned parameter

- Type: Integer
- Character Set: N/A
- Length: 4 bytes

Contains the return code from the Transfer service.

,current_du_pause_element_token

Supplied parameter

- Type: Character string
- Character Set: N/A
- Length: 16 bytes

Contains a pause element token that identifies the pause element that is being or will be used to pause a task or SRB. When a PET is used on a call to the Pause service, it cannot be reused on a second call to Pause or as a `current_du_pause_element_token` on Transfer. A new PET is returned to `update_pause_element_token`. The new PET properly defines the pause element and should be used the next time a pause, transfer, release, or `deallocate_pause_element` request is made using the same pause element.

If the value specified is 16-bytes of binary zeros, the current task or SRB is not paused. The `updated_pause_element_token` and `current_du_release_code` will be unpredictable.



CAUTION: Do not specify the same PET for both `current_du_pause_element_token` and `target_du_pause_element_token`.

,updated_pause_element_token

Returned parameter

- Type: Character string
- Character Set: N/A
- Length: 16 bytes

Contains a new pause element token that identifies the pause element originally identified by the PET specified in `current_du_pause_element_token`. The PET originally specified in `current_du_pause_element_token` cannot be reused after a successful call to Pause or Transfer.

If you set the `current_du_pause_element_token` to zeros, the contents of `updated_pause_element_token` are unpredictable.

,current_du_release_code

Returned parameter

- Type: Character string
- Character Set: N/A
- Length: 3 bytes

Contains the release code set by the issuer of the Release or Transfer service that released the current task or SRB from its paused condition.

If you set the `current_du_pause_element_token` to zero, the contents are unpredictable.

,target_du_pause_element_token

Supplied parameter

- Type: Character string
- Character Set: N/A
- Length: 16 bytes

IEAVXFR2 callable service

Contains a pause element token that identifies a pause element that is being or will be used to pause a task or SRB. If the task or SRB is paused, it will be released, and, if possible, be given control. If the task or SRB is not paused using the specified pause element, it will not be paused when an attempt to pause is made. In either case the task or SRB will be returned the value specified in `target_du_release_code`.



CAUTION: Do not use the same PET for both `current_du_pause_element_token` and `target_du_pause_element_token`.

,`target_du_release_code`

Supplied parameter

- Type: Character string
- Character Set: N/A
- Length: 3 bytes

Contains the release code returned to the issuer of the Pause or Transfer service used (or will use) the PET specified in `target_du_pause_element_token` to pause a task or SRB.

linkage

Supplied parameter

- Type: Integer
- Character Set: N/A
- Length: 4 bytes

Specifies how the Transfer service routine is to be invoked. The following options are supported:

Variable	Value (hexadecimal)	Meaning
IEA_LINKAGE_SVC	0	The Transfer service routine will be invoked by an SVC linkage. This option can be used when in non-cross memory task mode, in any key, and either problem state or supervisor state.
IEA_LINKAGE_BRANCH	1	The Transfer service routine will be invoked by a branch instruction. The caller must be in both key 0 and supervisor state. This option must be selected when in SRB mode.

ABEND codes

None.

Return codes

When the service returns control to the resource manager, GPR 15 and `return_code` contain a hexadecimal return code.

Return Code in: Decimal (Hex)	Equate symbol	Meaning and Action
00 (00)	IEA_SUCCESS	Meaning: Successful completion. Action: None
04 (04)	IEA_PE_TOKEN_BAD	Meaning: Program error. The specified pause element token is not valid. The system rejects the service call. Action: Check the calling program for a probable coding error. Correct the program and rerun it.

Return Code in: Decimal (Hex)	Equate symbol	Meaning and Action
08 (08)	IEA_PE_TOKEN_STALE	<p>Meaning: The specified pause element token is stale; that is, it was valid but has been used on the Pause or Transfer service. This service requires the updated PET returned on Pause or Transfer.</p> <p>Action: Check the calling program for a probable coding error. Correct the program and rerun it.</p>
12 (0C)	IEA_DUPLICATE_PAUSE	<p>Meaning: The work unit has already been paused using the specified pause element token. The system rejects the service call.</p> <p>Action: Check the calling program for a probable coding error. Correct the program and rerun it.</p>
16 (10)	IEA_SLEEP_INTERRUPTED	<p>Meaning: RTM has terminated the task or SRB; no release is necessary.</p> <p>Action: None</p>
20 (14)	IEA_SPACE_TERMINATING	<p>Meaning: The address space that contains the task or SRB is terminating; no release is necessary.</p> <p>Action: None</p>
24 (18)	IEA_LOCK_HELD	<p>Meaning: Program error. If a current_du_pause_element_token of 16 bytes of binary zeros is specified, one or more locks other than the local lock are held. Otherwise, one or more locks are held. The system rejects the service call.</p> <p>Action: Check the calling program for a probable coding error. Correct the program and rerun it.</p>
32 (20)	IEA_PE_BAD_STATE	<p>Meaning: Program error. The pause element associated with the pause element token specified in the call is not in a valid state. The system rejects the service call.</p> <p>Action: Check the calling program for a probable coding error, such as attempting to perform a Pause or Transfer using a pause element token that has already been used to Pause or Transfer by another unit of work. Correct the program and rerun it.</p>
36 (24)	IEA_UNSUPPORTED_MVS_RELEASE	<p>Meaning: Environmental error. The system release does not support this service. The system rejects the service call.</p> <p>Action: Run the program on a system that supports the service.</p>
44 (2C)	IEA_INVALID_MODE	<p>Meaning: Program error. The calling program is not in primary ASC mode, which this service requires. The system rejects the service call.</p> <p>Action: Check the calling program for a probable coding error. Correct the program and rerun it.</p>
52 (34)	IEA_ALREADY_SUSPENDED	<p>Meaning: The pause element was already paused.</p> <p>Action: Check the calling program for a probable coding error and correct the program and rerun it.</p>
60 (3C)	IEA_AUTH_TOKEN	<p>Meaning: Program error. The caller was in Problem state or key 8, but the pause element token was allocated with pause_element_auth_level=IEA_AUTHORIZED. The system rejects the service call.</p> <p>Action: Program error. The specified pause element token is not valid. The system rejects the service call.</p>
64 (40)	IEA_PE_NOT_HOME	<p>Meaning: Program error. The pause element token was for a pause element allocated with pause_element_auth_level=IEA_UNAUTHORIZED to another address space.</p> <p>Action: Check the calling program for a probable coding error. Correct the program and rerun it.</p>

IEAVXFR2 callable service

Return Code in: Decimal (Hex)	Equate symbol	Meaning and Action
68 (44)	IEA_XFER_TO_SELF	<p>Meaning: Program error. The specified <code>current_du_pause_element_token</code> and <code>target_du_pause_element_token</code> are the same.</p> <p>Action: Check the calling program for a probable coding error. Correct the program and rerun it.</p>
72 (48)	IEA_XFER_FAILED	<p>Meaning: The transfer failed, and the <code>current_du_pause_element_token</code> is no longer usable.</p> <p>Action: Reissue the transfer request using the <code>updated_du_pause_element_token</code>. Deallocate the <code>current_du_pause_element_token</code>.</p>
84 (54)	IEA_INVALID_LINKAGE	<p>Meaning: Program error. The linkage value specified is not valid. The system rejects the service call.</p> <p>Action: Check the calling program for a probable coding error. Correct the program and rerun it.</p>
4095 (FFF)	IEA_UNEXPECTED_ERROR	<p>Meaning: This service routine encountered an unexpected error. The system rejects this service request.</p> <p>Action: Contact IBM support.</p>

Chapter 38. IEA4APE – Allocate_Pause_Element

Description

Allocate_Pause_Element obtains a pause element token (PET), which uniquely identifies a pause element. The PET is used as input to the following services:

- Pause
- Release
- Transfer
- Deallocate_Pause_Element

Environment

The requirements for the caller are:

Environmental factor	Requirement
Minimum authorization:	Problem state and any PSW key.
Dispatchable unit mode:	Task
Cross memory mode:	PASN=HASN=SASN
AMODE:	64-bit
RMODE:	Includes 64-bit
ASC mode:	Primary
Interrupt status:	Enabled for I/O and external interrupts
Locks:	No locks held.
Control parameters:	Must be in the primary address space and addressable by the caller.

Programming requirements

Either link the object code of the calling program with the linkable stub routine (IEA4CSS from SYS1.CSSLIB), or load the calling program and then call the service. The high-level language (HLL) definitions for the callable service are:

HLL Definition	Description
IEAASM	390 Assembler declarations
IEAC	C/390 and C++/390 declarations

Restrictions

When the calling program specifies `auth_level=IEA_UNAUTHORIZED`, the caller must be in task mode and can only release another task in its home address space. All pause element tokens (PETs) used when `auth_level=IEA_UNAUTHORIZED` must have been obtained using an authorization level of `IEA_UNAUTHORIZED`.

Only 2040 unauthorized PETs may be allocated at any one time in an address space.

Input register information

Before calling `Allocate_Pause_Element`, the caller must ensure that the following general purpose registers (GPRs) contain the specified information:

Register Contents

- 1** Address of the parameter address list.
- 13** Address of a 144-byte register save area.

Output register information

When control returns to the caller, the GPRs contain:

Register Contents

- 0-1** Used as work registers by the system
- 2-13** Unchanged
- 14** Used as work registers by the system
- 15** Return Code

When control returns to the caller, the ARs contain:

Register Contents

- 0-1** Used as work registers by the system
- 2-13** Unchanged
- 14-15** Used as work registers by the system

Some callers depend on register contents remaining the same before and after issuing a service. If the system changes the contents of registers on which the caller depends, the caller must save them before issuing the service, and restore them after the system returns control.

Performance implications

None.

Syntax

Syntax	Description
<code>SYSSTATE AMODE64=YES</code>	
<code>CALL IEA4APE</code>	,(return_code ,auth_level ,pause_element_token)

Parameters

The parameters are explained as follows:

return_code

Returned parameter

- Type: Integer
- Character Set: N/A
- Length: 4 bytes

Contains the return code from the Allocate_Pause_Element service.

,auth_level

Supplied parameter

- Type: Integer
- Character Set: N/A
- Length: 4 bytes

Represents one or more possible levels of the pause element being allocated. The calling program can use the constants that are defined in IEAASM or IEAC. The level needed is derived by adding the values of the required types together. The authorization type is required.

For example, the level to allocate authorized pause elements that are checkpoint- or restart-tolerant is IEA_AUTHORIZED + IEA_CHECKPOINTOK, or 3.

The following levels are supported:

<i>Table 21. Authorization</i>		
IEAASM and IEAC defined constants	Value (hexadecimal)	Meaning
IEA_UNAUTHORIZED	0	When using the allocated pause element through other services, either auth_level IEA_UNAUTHORIZED or IEA_AUTHORIZED can be used.
IEA_AUTHORIZED	1	When using the allocated pause element through other services, auth_level=IEA_AUTHORIZED will be required. Caller must be both key 0 and supervisor state.

<i>Table 22. Checkpoint/Restart Toleration - only available when the CVTPAUS4 bit is set in the CVT.</i>		
IEAASM and IEAC defined constants	Value (hexadecimal)	Meaning
IEA_CHECKPOINTOK	2	The application can tolerate the pause elements' not being restored upon a restart after a checkpoint.

Note: If the IEA_CHECKPOINTOK value is not added to the authorization value, checkpoints cannot be taken when an allocated pause element exists.

,pause_element_token

Returned parameter

- Type: Character string
- Character Set: N/A
- Length: 16 bytes

Contains the pause element token that identifies the pause element that you can use to synchronize the processing of a task.

ABEND codes

None.

Return codes

When the service returns control to the resource manager, GPR 15 and return_code contain a hexadecimal return code.

Return code in: Decimal (Hex) Equate symbol	Meaning and Action
00 (0) IEA_SUCCESS	Meaning: Successful completion. Action: None.
24 (18) IEA_LOCK_HELD	Meaning: Program error. If the auth_level indicates AUTHORIZED, locks other than the local lock are held. If the auth_level indicates UNAUTHORIZED, locks are held. The system rejects the service call. Action: Check the calling program for a probable coding error. Correct the program and rerun it.
36 (24) IEA_UNSUPPORTED_MVS_RELEASE	Meaning: Environmental error. The system release does not support this service. The system rejects the service call. Action: Run the program on a system that supports the service.
56 (38) IEA_NO_PETS_AVAILABLE	Meaning: There are no pause element tokens available. Action: Retry the request later.
64 (40) IEA_PE_NOT_HOME	Meaning: Program error. The auth_level value specified in the call is not valid. The system rejects the service call. Action: Check the calling program for a probable coding error. Correct the program and rerun it.
68 (44) IEA_XFER_TO_SELF	Meaning: Program error. The calling program is not in primary ASC mode, which this service requires. The system rejects the service call. Action: Check the calling program for a probable coding error. Correct the program and rerun it.
72 (48) IEA_XFER_FAILED	Meaning: Environmental error. The system could not obtain storage for a pause element. The system rejects the service call. Action: Retry the request later. If the problem persists, consult your system programmer.
4095 (FFF) IEA_UNEXPECTED_ERROR	Meaning: This service routine encountered an unexpected error. The system rejects this service request. Action: Search problem reporting databases for a fix for the problem. If no fix exists, contact the IBM Support Center.

Chapter 39. IEA4APE2 – Allocate_Pause_Element

Description

Allocate_Pause_Element obtains a pause element token (PET), which uniquely identifies a pause element. The PET is used as input to the following services:

- Pause
- Release
- Transfer
- Deallocate_Pause_Element

Environment

The requirements for the caller are:

Environmental factor	Requirement
Minimum authorization:	Problem state and any PSW key
Dispatchable unit mode:	Task
Cross memory mode:	PASN=HASN=SASN
AMODE:	64-bit
RMODE:	Includes 64-bit
ASC mode:	Primary
Interrupt status:	Enabled for I/O and external interrupts.
Locks:	No locks held.
Control parameters:	Must be in the primary address space and addressable by the caller.

Programming requirements

Either link the object code of the calling program with the linkable stub routine (IEA4CSS from SYS1.CSSLIB) or load the calling program and then call the service. The high-level language (HLL) definitions for the callable service are:

HLL Definition	Description
IEAASM	390 Assembler declarations
IEAC	C/390 and C++/390 declarations

Restrictions

Pause elements that are created with `pause_element_auth_level=IEA_UNAUTHORIZED` may only be used by callers in task mode and can only be released from a task in their home address space.

Only 2040 unauthorized PETs may be allocated at any one time in an address space.

Allocate_Pause_Element cannot be used by tasks that are higher in the task tree than the cross memory resource owning task (the top, or first, job step task in the address space).

Input register information

Before calling Allocate_Pause_Element, the caller must ensure that the following general purpose registers (GPRs) contain the specified information:

Register Contents

- 1** Address of the parameter address list.
- 13** Address of a 144-byte register save area.

Output register information

When control returns to the caller, the GPRs contain:

Register Contents

- 0-1** Used as work registers by the system
- 2-13** Unchanged
- 14** Used as a work register by the system
- 15** Return code

When control returns to the caller, the ARs contain:

Register Contents

- 0-1** Used as work registers by the system
- 2-13** Unchanged
- 14-15** Used as work registers by the system

Some callers depend on register contents remaining the same before and after issuing a service. If the system changes the contents of registers on which the caller depends, the caller must save them before issuing the service, and restore them after the system returns control.

Performance implications

None.

Syntax

Syntax	Description
SYSSTATE AMODE64=YES	

Syntax	Description
CALL IEA4APE2	<pre> ,(return_code ,pause_element_token ,pause_element_owner_stoken ,owner_termination_release_code ,linkage) </pre>

Parameters

The parameters are explained as follows:

return_code

Returned parameter

- Type: Integer
- Character Set: N/A
- Length: 4 bytes

Contains the return code from the Allocate_Pause_Element service.

,pause_element_token

Returned parameter

- Type: Character string
- Character Set: N/A
- Length: 16 bytes

Contains the pause element token that identifies a pause element that you can use to synchronize the processing of a task or SRB.

,pause_element_owner_stoken

Supplied parameter

- Type: Character string
- Character Set: N/A
- Length: 8 bytes

Specifies the space token (STOKEN) of the address space which is to be considered the owner of the Pause Element being allocated. Specify one of the following values:

- Binary zero: indicate the system should make the current primary address space the owner of the Pause Element. This is the only value valid for key 8-15 problem state callers.
- A valid STOKEN, indicate the system should make the address space with the matching STOKEN the owner for the pause element.

When the CMRO task (the first job step task) of an address space terminates, the system will release and deallocate any pause elements owned by the CMRO task's home address space. The table below describes exactly when the system will release and/or deallocate a Pause Element:

Allocation Service version:	Deallocation Rules
IEA4APE	<p>The PE will be deallocated by the system when one of the following events occurs:</p> <ul style="list-style-type: none"> • The PE was never used to pause a task or SRB and the CMRO task for the space which allocated it terminates. • The PE is being used to pause a task or SRB which is asynchronously terminated via CALLRTM TYPE=ABTERM (for example, cancel or detach) or a PURGEDQ. • The CMRO task of the home address space of the task or SRB which last used the PE terminates and the PE is not being used to pause an SRB. <p>The home address space of the task or SRB which last used the PE terminates</p>
IEA4APE2	<p>The PE will be deallocated by the system when one of the following events occurs:</p> <ul style="list-style-type: none"> • The CMRO task of the address space specified by pause_element_owner_stoken terminates. If the PE is being used to pause a DU when the CMRO task terminates, the system will release the DU using the owner_termination_release_code before the PE is deallocated. Note that in this case, the UPET returned will be 16 bytes of binary zeros, an invalid value. • The PE is being used to pause a task or SRB which is asynchronously terminated via CALLRTM TYPE=ABTERM (for example, cancel or detach) or a PURGEDQ. • The PE is being used to pause a task or SRB when the home address space of the task or SRB is terminated • The CMRO task of the home address space of the task or SRB which last used the PE terminates and the PE is not being used to pause an SRB <p>The home address space of the task or SRB which last used the PE terminates. Note: A PE is considered as "being used to pause a task or SRB," when the PE is not Reset or Prereleased.</p>

,owner_termination_release_code

Supplied parameter

- Type: Character string
- Character Set: N/A
- Length: 3 bytes

Specifies the release code which will be returned to a paused DU if the system deallocates the pause element while it is being used to pause a task or SRB, due to the CMRO task of its owning address space terminating.

Note: If the system deallocates a PE due to its owner terminating while the PE was not being used to pause a task or SRB, future attempts to use the PE will fail with a return code indicating the PETOKEN was stale or the PE is in an invalid state.

linkage

Supplied parameter

- Type: Integer
- Character Set: N/A
- Length: 4 bytes

Specifies how the Allocate_Pause_Element service routine is to be invoked. The following options are supported:

Variable	Value (hexadecimal)	Meaning
IEA_LINKAGE_SVC	0	The Allocate_Pause_Element service routine will be invoked via an SVC linkage. This option can be used when in non-cross memory task mode, any key, and either problem state or supervisor state.
IEA_LINKAGE_BRANCH	1	The Allocate_Pause_Element service routine will be invoked via a branch instruction. The caller must be in both key 0 and supervisor state. This option must be selected when in SRB mode.

ABEND codes

None.

Return codes

When the service returns control to the resource manager, GPR 15 and the return_code parameter contain a hexadecimal return code.

Return code in: Decimal (Hex)	Equate Symbol	Meaning and Action
00 (0)	IEA_SUCCESS	Meaning: Successful completion. Action: None.
24 (18)	IEA_LOCK_HELD	Meaning: Program error. One or more locks other than the local lock are held. The system rejects the service call. Action: Check the calling program for a probable coding error. Correct the program and rerun it.
36 (24)	IEA_UNSUPPORTED_MVS_RELEASE	Meaning: Environmental error. The system release does not support this service. The system rejects the service call. Action: Run the program on a system that supports the service.
40 (28)	IEA_INVALID_AUTHCODE	Meaning: Program error. The pause_element_auth_level value specified in the call is not valid. The system rejects the service call. Action: Check the calling program for a probable coding error. Correct the program and rerun it.
44 (2C)	IEA_INVALID_MODE	Meaning: Program error. The calling program is not in primary ASC mode, which this service requires. The system rejects the service call. Action: Check the calling program for a probable coding error. Correct the program and rerun it.

IEA4APE2 callable service

Return code in: Decimal (Hex)	Equate Symbol	Meaning and Action
48 (30)	IEA_OUT_OF_STORAGE	<p>Meaning: Environmental error. The system could not obtain storage for a pause element. The system rejects the service call.</p> <p>Action: Retry the request later. If the problem persists, consult your system programmer.</p>
56 (38)	IEA_NO_PETS_AVAILABLE	<p>Meaning: There are no pause element tokens available.</p> <p>Action: Try the request again later.</p>
4095 (FFF)	IEA_UNEXPECTED_ERROR	<p>Meaning: This service routine encountered an unexpected error. The system rejects this service request.</p> <p>Action: Search problem reporting databases for a fix for the problem. If no fix exists, contact the IBM Support Center.</p>

Chapter 40. IEA4DPE - Deallocate_Pause_Element

Description

Deallocate_Pause_Element frees a pause element that is no longer needed.

Environment

The requirements for the caller are:

Environmental factor	Requirement
Minimum authorization:	Problem state and any PSW key.
Dispatchable unit mode:	Task
Cross memory mode:	PASN=HASN=SASN
AMODE:	64-bit
RMODE:	Includes 64-bit
ASC mode:	Primary mode.
Interrupt status:	Enabled for I/O and external interrupts
Locks:	No locks held.
Control parameters:	Must be in the primary address space and addressable by the caller.

Programming requirements

Either link the object code of the calling program with the linkable stub routine (IEA4CSS from SYS1.CSSLIB), or load the calling program and then call the service. The high-level language (HLL) definitions for the callable service are:

HLL Definition	Description
IEAASM	390 Assembler declarations
IEAC	C/390 and C++/390 declarations

Restrictions

When the calling program specifies `auth_level=IEA_UNAUTHORIZED`, the caller must be in task mode and can only release another task in its home address space. All pause element tokens (PETs) used when `auth_level=IEA_UNAUTHORIZED` must have been obtained using an authorization level of `IEA_UNAUTHORIZED`.

Input register information

Before calling `Deallocate_Pause_Element`, the caller must ensure that the following general purpose registers (GPRs) contain the specified information:

Register Contents

- 1 Address of the parameter address list.

13

Address of a 144-byte register save area.

Output register information

When control returns to the caller, the GPRs contain:

**Register
Contents****0-1**

Used as work registers by the system

2-13

Unchanged

14

Used as a work register by the system

15

Return code

When control returns to the caller, the access registers (ARs) contain:

**Register
Contents****0-1**

Used as work registers by the system

2-13

Unchanged

14-15

Used as a work register by the system

Some callers depend on register contents remaining the same before and after issuing a service. If the system changes the contents of registers on which the caller depends, the caller must save them before issuing the service, and restore them after the system returns control.

Performance implications

None.

Syntax

Write the call as shown on the syntax diagram. You must code all parameters on the CALL statement in the order shown.

Syntax	Description
SYSSTATE AMODE64=YES	
CALL IEA4DPE	,(return_code ,auth_level ,pause_element_token)

Parameters

The parameters are explained as follows:

return_code

Returned parameter

- Type: Integer
- Character Set: N/A
- Length: 4 bytes

Contains the return code from the Deallocate_Pause_Element service.

,auth_level

Supplied parameter

- Type: Integer
- Character Set: N/A
- Length: 4 bytes

Indicates the maximum authorization level of the pause element being deallocated. The calling program can use constant IEA_UNAUTHORIZED defined by IEAASM and IEAC. The following levels are supported:

Variable	Value (HEX)	Meaning
IEA_UNAUTHORIZED	0	This pause element being deallocated must have been allocated with auth_level=IEA_UNAUTHORIZED.

,pause_element_token

Supplied parameter

- Type: Character string
- Character Set: N/A
- Length: 16 bytes

Contains the pause element token that identifies the pause element that is no longer needed.

ABEND codes

None.

Return codes

When the service returns control to the resource manager, GPR 15 and return_code contain a hexadecimal return code.

Return code in: Decimal (Hex) Equate symbol	Meaning and Action
00 (00) IEA_SUCCESS	Meaning: Successful completion. Action: None.
04 (04)	Meaning: Program error. The specified pause element token is not valid. The system rejects the service call. Action: Check the calling program for a probable coding error. Correct the program and rerun it.
08 (08) IEA_PE_TOKEN_STALE	Meaning: The specified pause element token is stale; that is, it was valid but has been used on the Pause or Transfer service. This service requires the updated PET be returned on Pause or Transfer. Action: Check the calling program for a probable coding error. Correct the program and rerun it.

IEA4DPE callable service

Return code in: Decimal (Hex) Equate symbol	Meaning and Action
24 (18) IEA_LOCK_HELD	<p>Meaning: Program error. The caller is holding one or more locks; no locks must be held. The system rejects the service call.</p> <p>Action: Check the calling program for a probable coding error. Correct the program and rerun it.</p>
32 (20) IEA_PE_BAD_STATE	<p>Meaning: Program error. The pause element associated with the specified pause element token specified is invalid or has already been paused. A paused PE must be released before it is deallocated. This return code also can indicate that the address space associated with the pause element is ending or has ended and that the system freed the pause element.</p> <p>Action: Check the calling program for a probable coding error. Correct the program and rerun it.</p>
36 (24) IEA_UNSUPPORTED_MVS_RELEASE	<p>Meaning: Environmental error. The system release does not support this service. The system rejects the service call.</p> <p>Action: Run the program on a system that supports the service.</p>
40 (28) IEA_INVALID_AUTHCODE	<p>Meaning: Program error. The auth_level value specified in the call is not valid. The system rejects the service call.</p> <p>Action: Check the calling program for a probable coding error. Correct the program and rerun it.</p>
44 (2C) IEA_INVALID_MODE	<p>Meaning: Program error. The calling program is not in primary ASC mode, which this service requires. The system rejects the service call.</p> <p>Action: Check the calling program for a probable coding error. Correct the program and rerun it.</p>
60 (3C) IEA_AUTH_TOKEN	<p>Meaning: Program error. The caller specified auth_level=UNAUTHORIZED, but the pause element token was allocated with auth_level=AUTHORIZED. The system rejects the service call.</p> <p>Action: Program error. The specified pause element token is not valid. The system rejects the service call.</p>
64 (40) IEA_PE_NOT_HOME	<p>Meaning: Program error. The caller specified auth_level=UNAUTHORIZED, but the pause element token was for a pause element allocated to another address.</p> <p>Action: Check the calling program for a probable coding error. Correct the program and rerun it.</p>
4095 (FFF) IEA_UNEXPECTED_ERROR	<p>Meaning: This service routine encountered an unexpected error. The system rejects this service request.</p> <p>Action: Search problem reporting databases for a fix for the problem. If no fix exists, contact the IBM Support Center.</p>

Chapter 41. IEA4DPE2 – Deallocate_Pause_Element

Description

Deallocate_Pause_Element frees a pause element that is no longer needed.

Environment

The requirements for the caller are:

Environmental factor	Requirement
Minimum authorization:	Problem state and any PSW key
Dispatchable unit mode:	Task
Cross memory mode:	PASN=HASN=SASN
AMODE:	64-bit
RMODE:	Includes 64-bit
ASC mode:	Primary mode.
Interrupt status:	Enabled for I/O and external interrupts.
Locks:	No locks held.
Control parameters:	Must in the primary address space and addressable by the caller.

Programming requirements

Either link the object code of the calling program with the linkable stub routine (IEA4CSS from SYS1.CSSLIB) or load the calling program and then call the service. The high-level language (HLL) definitions for the callable service are:

HLL Definition	Description
IEAASM	390 Assembler declarations
IEAC	C/390 and C++/390 declarations

Restrictions

Pause elements that are created with `pause_element_auth_level=IEA_UNAUTHORIZED` may only be used by callers in task mode and can only be released from a task in their home address space.

Input register information

Before calling Deallocate_Pause_Element, the caller must ensure that the following general purpose registers (GPRs) contain the specified information:

Register

Contents

- 1** Address of the parameter address list.
- 13** Address of a 144-byte register save area.

Output register information

When control returns to the caller, the GPRs contain:

Register Contents

0-1

Used as work registers by the system

2-13

Unchanged

14

Used as a work register by the system

15

Return code

When control returns to the caller, the access registers (ARs) contain:

Register Contents

0-1

Used as work registers by the system

2-13

Unchanged

14-15

Used as a work register by the system

Some callers depend on register contents remaining the same before and after issuing a service. If the system changes the contents of registers on which the caller depends, the caller must save them before issuing the service, and restore them after the system returns control.

Performance implications

None.

Syntax

Write the call as shown on the syntax diagram. You must code all parameters on the CALL statement in the order shown.

Syntax	Description
SYSSTATE AMODE64=YES	
CALL IEA4DPE2	,(return_code ,pause_element_token ,linkage)

Parameters

The parameters are explained as follows:

return_code

Returned parameter

- Type: Integer
- Character Set: N/A
- Length: 4 bytes

Contains the return code from the Deallocate_Pause_Element service.

,pause_element_token

Supplied parameter

- Type: Character string
- Character Set: N/A
- Length: 16 bytes

Contains the pause element token that identifies the pause element that is no longer needed.

linkage

Supplied parameter

- Type: Integer
- Character Set: N/A
- Length: 4 bytes

Specifies how the Deallocate_Pause_Element service routine is to be invoked. The following options are supported:

Variable	Value (hexadecimal)	Meaning
IEA_LINKAGE_SVC	0	The Deallocate_Pause_Element service routine will be invoked by an SVC linkage. This option can be used when in non-cross memory task mode, in any key, and in either problem state or supervisor state.
IEA_LINKAGE_BRANCH	1	The Deallocate_Pause_Element service routine will be invoked by a branch instruction. The caller must be in both key 0 and supervisor state. This option must be selected when in SRB mode.

ABEND codes

None.

Return codes

When the service returns control to the resource manager, GPR 15 and the return_code parameter contain a hexadecimal return code.

Return code in: Decimal (Hex)	Equate symbol	Meaning and Action
00 (00)	IEA_SUCCESS	Meaning: Successful completion Action: None.
04 (04)	IEA_PE_TOKEN_BAD	Meaning: Program error. The specified pause element token is not valid. The system rejects the service call. Action: Check the calling program for a probable coding error. Correct the program and rerun it.
08 (08)	IEA_PE_TOKEN_STALE	Meaning: The specified pause element token is stale; that is, it was valid but has been used on the Pause or Transfer service. This service requires the updated PET returned on Pause or Transfer. Action: Check the calling program for a probable coding error. Correct the program and rerun it.
24 (18)	IEA_LOCK_HELD	Meaning: Program error. One or more locks other than the local lock are held. The system rejects the service call. Action: Check the calling program for a probable coding error. Correct the program and rerun it.

IEA4DPE2 callable service

Return code in: Decimal (Hex)	Equate symbol	Meaning and Action
32 (20)	IEA_PE_BAD_STATE	<p>Meaning: Program error. The pause element associated with the specified pause element token is invalid or has already been paused. A paused PE must be released before it is deallocated. This return code also can indicate that the address space associated with the pause element is ending or has ended and that the system freed the pause element.</p> <p>Action: Check the calling program for a probable coding error. Correct the program and rerun it.</p>
36 (24)	IEA_UNSUPPORTED_MVS_RELEASE	<p>Meaning: Environmental error. The system release does not support this service. The system rejects the service call.</p> <p>Action: Run the program on a system that supports the service.</p>
44 (2C)	IEA_INVALID_MODE	<p>Meaning: Program error. The calling program is not in primary ASC mode, which this service requires. The system rejects the service call.</p> <p>Action: Check the calling program for a probable coding error. Correct the program and rerun it.</p>
64 (40)	IEA_PE_NOT_HOME	<p>Meaning: Program error. The pause element token was for an unauthorized pause element allocated to another address space.</p> <p>Action: Check the calling program for a probable coding error. Correct the program and rerun it.</p>
4095 (FFF)	IEA_UNEXPECTED_ERROR	<p>Meaning: This service routine encountered an unexpected error. The system rejects this service request.</p> <p>Action: Search problem reporting databases for a fix for the problem. If no fix exists, contact the IBM Support Center.</p>

Chapter 42. IEA4PME2 – 64-bit pause multiple elements service

Description

IEA4PME2 is a callable service that can be used to pause on one or more pause element tokens (PETs). It is entered in 64-bit mode and the addresses in the parameter list are 64 bits long. When the specified number of pause elements (PEs) represented by PETs has been released, you receive control back with the following:

- A list of PETs that you can use to pause on again
- An indication of which PEs were released
- Their release codes.

Environment

The requirements for the caller are:

Environmental factor	Requirement
Minimum authorization:	<ul style="list-style-type: none"> • Problem state and any PSW key.
Dispatchable unit mode:	<ul style="list-style-type: none"> • For LINKAGE=BRANCH: Task or SRB • For LINKAGE=SVC: Task
Cross memory mode:	<ul style="list-style-type: none"> • For LINKAGE=BRANCH: any PASN, any HASN, any SASN • For LINKAGE=SVC: PASN=SASN=HASN
AMODE:	31-bit addressing mode.
ASC mode:	Primary mode.
Interrupt status:	Enabled for I/O and external interrupts.
Locks:	No locks held.
Control parameters:	Must be in the primary address space and addressable by the caller.

Programming requirements

Either link the calling program's object code with the linkable stub routine (IEACSS from SYS1.CSSLIB), or load the calling program and then call the service. The high-level language (HLL) definitions for the callable service are:

HLL Definition	Description
IEAASM	390 Assembler declarations
IEAC	C/390 and C++/390 declarations

Restrictions

Pause elements that are created with `pause_element_auth_level=IEA_UNAUTHORIZED` may only be used by callers in task mode and can only be released from a task in their home address space.

Key 1-15 or problem state callers must specify linkage as IEA_LINKAGE_SVC. IEA_LINKAGE_SVC is limited to pausing upon no more than 1000 PETs.

Pause cannot be used by tasks that are higher in the task tree than the cross memory resource owning task (the EXEC PGM=xxx task).

Input register information

Before calling the Pause service, the caller must ensure that the following general purpose registers (GPRs) contain the specified information:

Register

Contents

1

Address of the parameter address list.

13

Note that register 13 is not required to contain any particular value. See the **workarea** parameter description.

Output register information

When control returns to the caller, the GPRs contain:

Register

Contents

0-1

Used as work registers by the system

2-13

Unchanged

14

Used as work registers by the system

15

Return code.

Note that this service saves and restores full 64-bit GPRs.

When control returns to the caller, the ARs contain:

Register

Contents

0-1

Used as work registers by the system

2-13

Unchanged

14-15

Used as work registers by the system

Some callers depend on register contents remaining the same before and after issuing a service. If the system changes the contents of registers on which the caller depends, the caller must save them before issuing the service, and restore them after the system returns control.

Performance implications

There is a maximum number of PETs which can be processed very quickly by IEAVPME2 without doing additional GETMAINS and FREEMAINS. That number is currently 16.

Syntax

Syntax	Description
CALL IEA4PME2	(return_code ,pause_element_token_list ,updated_pause_element_token_list ,release_code_list ,number_of_PETs_in_each_list ,number_of_PEs_to_release ,linkage ,workarea)

Link-edit your program with a linkage-assist routine (also called a stub) in SYS1.CSSLIB unless you use one of the following techniques as an alternative to CALL IEA4PME2:

- ```
LOAD EP=IEA4PME2
Save the 8-byte entry point address with bit 63 changed to 0 (...)
Put the saved entry point address with bit 63 changed to 0 into 64-bit R15
CALL (15),(...)
```
- ```
LLGT 15,X'10'(0,0)
L    15,X'220'(15,0)
L    15,X'14'(15,0)
L    15,X'104'(15,0)
CALL (15),(...)
```

Parameters

The parameters are explained as follows:

return_code

Returned parameter

- Type: Integer
- Character Set: N/A
- Length: 4 bytes

Contains the highest return code from the Pause service (multiple return codes are possible when more than one PET has been specified – *seerelease_code_list*). When the low-order bit of the return code is on, *release_code_list* contains the return codes for individual PETs rather than release codes.

Note that no pause has actually occurred if the return code is non-zero. In this situation, any PETs which have been released remain released.

,pause_element_token_list

Supplied parameter

- Type: Character string
- Character Set: N/A
- Length: 16 bytes times the number of PEs you want to pause on

A list of the PETs identifying the PEs you want to pause on. *Number_of_PETs_in_each_list* specifies how many PETs are in the list.

,updated_pause_element_token_list

Returned parameter

- Type: Character string
- Character Set: N/A

- Length: 16 bytes times the number of PEs you want to pause on

If *return_code* is 0, a list of the PETs returned by Pause Multiple Elements. Each entry corresponds to an entry in the *pause_element_token_list*. For each PE that was released, the system puts an updated PET into this list. For PEs that are not released, the entry contains the PET from the original *pause_element_token_list*.

These new PETs must be used in place of the PETs specified in *pause_element_token_list* or *pause_element_token* on future calls to the Pause, Release, Transfer, or Deallocate_Pause_Element service. The first byte of each entry in *release_code_list* identifies which PEs were released. *Number_of_PETs_in_each_list* specifies how many PETs are in the list.

If *return_code* is not 0, the PETs are not updated and this list is not returned.

If the paused *workunit* was released by the system (the release code is the *owner_termination_release_code* specified on the IEAVAPE2 allocation), the PET returned in that slot will be 16 bytes of binary zeros, an invalid value.

,release_code_list

Returned parameter

- Type: Fullword
- Character Set: N/A
- Length: 4 bytes times the number of PEs you want to pause on

Each entry corresponds to an entry in the *pause_element_token_list*.

If *return_code* is 0, the pause was successful and has been released. For each PE that was Released, the system puts X'01' into the first byte and the release code for that PET into the second through fourth bytes of the full-word entry for that PET. For PEs which are not released, the entry contains binary zeroes.

If *return_code* is 5, 9, D, 21, 35, 3D, or 41, a problem was found with at least one of the PETs specified in *pause_element_token_list* and the pause request did not complete.

The individual return code for each PET is in the second through fourth bytes of the *release_code_list* entry for that PET. Each PET with a return code of 0 would have been paused on if all the other PETs in the list had received return codes of 0. If *return_code* contains any other value, the pause request did not complete and *release_code_list* does not contain any meaningful information.

Note: These return codes are the equivalent of return codes 4, 8, C, 20, 34, 3C, and 40 for IEAVPSE2 (Pause single), with the addition of a low-order bit to signify that the *release_code_list* contains individual PET return codes.

,number_of_PETs_in_each_list

Supplied parameter

Number_of_PETs_in_each_list specifies how many entries are in *release_code_list*.

- Type: Integer
- Character Set: N/A
- Length: 4 bytes

This number specifies how many PETs you want to Pause on. This number also specifies the number of entries in *pause_element_token_list*, *updated_pause_element_token_list*, and *release_code_list*. For SVC entry callers, the maximum number that can be specified is 1000.

,number_of_PEs_to_release

Supplied parameter

Number_of_PETs_in_each_list specifies how many entries are in *release_code_list*.

- Type: Integer
- Character Set: N/A
- Length: 4 bytes

This number specifies how many PEs must be released before control is returned back to the issuer of Pause Multiple Elements. This number must be at least 1 and no more than *number_of_PETs_in_each_list*.

Note that if more PEs than this number were released before IEAVPME2 was issued (pre-released), the number of updated PETs in *updated_pause_element_token_list* will be the actual number released.

,linkage

Supplied parameter

- Type: Integer
- Character Set: N/A
- Length: 4 bytes

Specifies how the Pause service routine is to be invoked. The following options are supported:

Variable	Value	Meaning
IEA_LINKAGE_SVC	0	The Pause service routine will be invoked by an SVC linkage. This option can be used when in non-cross memory task mode, in any key, and in either problem state or supervisor state.
IEA_LINKAGE_BRANCH	1	The Pause service routine will be invoked by a branch instruction. The caller must be in both key 0 and supervisor state. This option must be selected when in SRB mode.

,workarea

Supplied parameter

- Type: Character string
- Character Set: N/A
- Length: 216 bytes

Specifies a work area on a doubleword boundary in which the Pause service routine will save information about the caller including the caller's registers. This can be the same area that R13 points to if the first 216 bytes of that area can be used as an F7SA savearea.

ABEND codes

None. However, note that you may receive a GETMAIN abend if this service is unable to obtain storage needed to process the PETs.

Return codes

When IEAVPME2 returns control to your program, if GPR 15 contains 0, 5, 9, D, 21, 35, 3D, or 41, *release_code_list* contains information about the status of each PET that was specified. If GPR 15 contains any other value, *release_code_list* does not contain any meaningful information.

Return code in: Decimal (Hex)	Equate Symbol	Meaning and Action
00 (0)	IEA_SUCCESS	Meaning: Successful completion. Action: None.
05 (05)	IEA_PE_TOKEN_BAD	Meaning: Program error. The specified pause element token is not valid. The system rejects the service call. Action: Check the calling program for a probable coding error. Correct the program and rerun it.

IEA4PME2 callable service

Return code in: Decimal (Hex)	Equate Symbol	Meaning and Action
09 (09)	IEA_PE_TOKEN_STALE	<p>Meaning: The specified pause element token is stale; that is, it was valid but has been used on the Pause or Transfer service. This service requires the updated PET returned on Pause or Transfer.</p> <p>Action: Check the calling program for a probable coding error. Correct the program and rerun it.</p>
13 (0D)	IEA_DUPLICATE_PAUSE	<p>Meaning: The work unit has already been paused using the specified pause element token. The system rejects the service call.</p> <p>Action: Check the calling program for a probable coding error. Correct the program and rerun it.</p>
24 (18)	IEA_LOCK_HELD	<p>Meaning: Program error. The caller is holding one or more locks; no locks may be held. The system rejects the service call.</p> <p>Action: Check the calling program for a probable coding error. Correct the program and rerun it.</p>
33 (21)	IEA_PE_BAD_STATE	<p>Meaning: Program error. The pause element associated with the pause element token specified in the call is not in a valid state. The system rejects the service call.</p> <p>Action: Check the calling program for a probable coding error, such as attempting to perform a pause or transfer using a pause element token that has already been used to pause or transfer by another unit of work. Correct the program and rerun it.</p>
36 (24)	IEA_UNSUPPORTED_MVS_RELEASE	<p>Meaning: Environmental error. The system release does not support this service. The system rejects the service call.</p> <p>Action: Run the program on a system that supports the service.</p>
44 (2C)	IEA_INVALID_MODE	<p>Meaning: Program error. The calling program is not in primary ASC mode, which this service requires. The system rejects the service call.</p> <p>Action: Check the calling program for a probable coding error. Correct the program and rerun it.</p>
53 (35)	IEA_ALREADY_SUSPENDED	<p>Meaning: The pause element was already paused.</p> <p>Action: Check the calling program for a probable coding error. Correct the program and rerun it.</p>
61 (3D)	IEA_AUTH_LEVEL_MISMATCH	<p>Meaning: Program error. The caller was in problem state or key 8, but the pause element token was allocated with <i>pause_element_auth_level</i>=IEA_AUTHORIZED. The system rejects the service call.</p> <p>Action: Program error. The specified pause element token is not valid. The system rejects the service call.</p>
65 (41)	IEA_PE_NOT_HOME_PM	<p>Meaning: Program error. The pause element token was for a pause element allocated with <i>pause_element_auth_level</i>=IEA_AUTHORIZED to another address space.</p> <p>Action: Check the calling program for a probable coding error. Correct the program and rerun it.</p>
76 (4C)	IEA_ABENDED_47B	<p>Meaning: After an SRB received abend 47B, it invoked IEA4PME2. It is not valid to invoke IEA4PME2 after receiving abend 47B.</p> <p>Action: Update the calling program to not invoke IEA4PME2 after abend 47B.</p>

Return code in: Decimal (Hex)	Equate Symbol	Meaning and Action
80 (50)	IEA_INSUSPEND_EXIT	<p>Meaning: The suspend exit specified on SUSPEND with SPTOKEN of an SRB invoked IEA4PME2. It is not valid to invoke IEA4PME2 from a suspend exit.</p> <p>Action: Update the calling program to not invoke IEA4PME2 from a suspend exit.</p>
84 (54)	IEA_INVALID_LINKAGE	<p>Meaning: Program error. The linkage value specified is not valid. The system rejects the service call.</p> <p>Action: Check the calling program for a probable coding error. Correct the program and rerun it.</p>
104 (68)	IEA_INVALID_NUMBER_OF_PETS	<p>Meaning: Program error. The number of PETS specified for Pause Multiple was 0 or for SVC entry users more than 1000. The system rejects the service call.</p> <p>Action: Check the calling program for a probable coding error. Correct the program and rerun it.</p>
108 (6C)	IEA_INVALID_NUMBER_TO_RELEASE	<p>Meaning: Program error. The number of PEs to release is 0 or greater than the number of PETS specified for Pause Multiple. The system rejects the service call.</p> <p>Action: Check the calling program for a probable coding error. Correct the program and rerun it.</p>
4094 (FFE)	IEA_ERROR_PETS_INVALIDATED	<p>Meaning: Pause processing has encountered an error and cannot complete the Pause request. This input PETS have been invalidated. This return code is only issued for Pause Multiple requests.</p> <p>Action: Do not return the PETS to the system using the Deallocate Pause Elements services. Note that new PEs must be obtained before attempting to pause again.</p>
4095 (FFF)	IEA_UNEXPECTED_ERROR	<p>Meaning: This service routine encountered an unexpected error. The system rejects this service request.</p> <p>Action: Contact IBM support.</p>

Chapter 43. IEA4PSE – Pause service

Description

Call IEA4PSE service to make the current task nondispatchable. After you pause a task, it remains nondispatchable until a release service specifying the same PET is called. That is, the program issuing the pause does not receive control back until after the release occurs.

If a release service specifying the same PET is called before pause, the system returns control immediately to the calling program, and the task is not paused.

When you use pause, it returns an updated PET. Use this updated PET to either deallocate or reuse the PE.

Environment

The requirements for the caller are:

Environmental factor	Requirement
Minimum authorization:	Problem state and any PSW key.
Dispatchable unit mode:	Task
Cross memory mode:	PASN=HASN=SASN
AMODE:	64-bit
RMODE:	Includes 64-bit
ASC mode:	Primary mode
Interrupt status:	Enabled for I/O and external interrupts.
Locks:	No locks held.
Control parameters:	Must be in the primary address space and addressable by the caller.

Programming requirements

Either link the object code of the calling program with the linkable stub routine (IEA4CSS from SYS1.CSSLIB), or load the calling program and then call the service. The high-level language (HLL) definitions for the callable service are:

HLL Definition	Description
IEAASM	390 Assembler declarations
IEAC	C/390 and C++/390 declarations

Restrictions

When the calling program is running `auth_level=IEA_UNAUTHORIZED`, the caller must be in task mode and can only pause another task in its home address space. All pause element tokens (PETs) used when `auth_level=IEA_UNAUTHORIZED` must have been obtained using an authorization level of `IEA_UNAUTHORIZED`.

Input register information

Before calling the Pause service, the caller must ensure that the following general purpose registers (GPRs) contain the specified information:

Register Contents

- 1** Address of the parameter address list.
- 13** Address of a 144-byte register save area.

Output register information

When control returns to the caller, the GPRs contain:

Register Contents

- 0-1** Used as work registers by the system
- 2-13** Unchanged
- 14** Used as work registers by the system
- 15** Return code

When control returns to the caller, the access registers (ARs) contain:

Register Contents

- 0-1** Used as work registers by the system
- 2-13** Unchanged
- 14-15** Used as a work register by the system

Some callers depend on register contents remaining the same before and after issuing a service. If the system changes the contents of registers on which the caller depends, the caller must save them before issuing the service, and restore them after the system returns control.

Performance implications

None.

Syntax

Syntax	Description
SYSSTATE AMODE64=YES	
CALL IEA4PSE	,(return_code ,auth_level ,pause_element_token ,updated_pause_element_token ,release_code)

Parameters

The parameters are explained as follows:

return_code

Returned parameter

- Type: Integer
- Character Set: N/A
- Length: 4 bytes

Contains the return code from the Pause service.

,auth_level

Supplied parameter

- Type: Integer
- Character Set: N/A
- Length: 4 bytes

Indicates the maximum level that the specified pause element was allocated with. IEAASM and IEAC define constants IEA_UNAUTHORIZED and IEA_AUTHORIZED, which the calling program can use. The following levels are supported:

Variable	Value (HEX)	Meaning
IEA_UNAUTHORIZED	0	The pause element being paused must have been allocated with auth_level=IEA_UNAUTHORIZED.
IEA_AUTHORIZED	1	The pause element being paused must have been allocated with auth_level=IEA_AUTHORIZED.

,pause_element_token

Supplied parameter

- Type: Character string
- Character Set: N/A
- Length: 16 bytes

A pause element token that identifies the pause element being used to pause the current task. You can obtain the PET from the Allocate_Pause_Element service.

When you use a PET in a call to the pause service, you cannot reuse the PET on a second call to pause or on a call to transfer. The pause service returns a new PET in updated_pause_element_token. The new PET now identifies the pause element used to pause the task; use the new PET the next time when you make a pause request using the same pause element.

,updated_pause_element_token

Returned parameter

- Type: Character string
- Character Set: N/A
- Length: 16 bytes

A new pause element token that identifies the pause element originally identified by the PET specified in pause_element_token, which cannot be reused after a successful call to Pause.

,release_code

Returned parameter

- Type: Character string
- Character Set: N/A
- Length: 3 bytes

The release code, specified by the issuer of the Release service. A Release that specified this code released the task from its paused condition.

ABEND codes

Abend Code	Reason Code	Description
AC7	001A0001	This is an internal error. Contact IBM support.

Return codes

When the service returns control to your program, GPR 15 contains one of the following return codes:

Return code in: Decimal (Hex) Equate symbol	Meaning and Action
00 (00) IEA_SUCCESS	Meaning: Successful completion. Action: None.
04 (04)	Meaning: Program error. The specified pause element token is not valid. The system rejects the service call. Action: Check the calling program for a probable coding error. Correct the program and rerun it.
08 (08) IEA_PE_TOKEN_STALE	Meaning: The specified pause element token is stale; that is, it was valid but has been used on the Pause or Transfer service. This service requires the updated PET be returned on Pause or Transfer. Action: Check the calling program for a probable coding error. Correct the program and rerun it.
12 (0C) IEA_DUPLICATE_PAUSE	Meaning: The work unit has already been paused using the specified pause element token. The system rejects the service call. Action: Check the calling program for a probable coding error. Correct the program and rerun it.
24 (18) IEA_LOCK_HELD	Meaning: Program error. The caller is holding one or more locks; no locks must be held. The system rejects the service call. Action: Check the calling program for a probable coding error. Correct the program and rerun it.
32 (20) IEA_PE_BAD_STATE	Meaning: Program error. The pause element associated with the pause element token specified in the call is not in a valid state. The system rejects the service call. Action: Check the calling program for a probable coding error, such as attempting to perform a Pause or Transfer using a pause element token that has already been used to Pause or Transfer by another unit of work. Correct the program and rerun it.
36 (24) IEA_UNSUPPORTED_MVS_RELEASE	Meaning: Environmental error. The system release does not support this service. The system rejects the service call. Action: Run the program on a system that supports the service.
40 (28) IEA_INVALID_AUTHCODE	Meaning: Program error. The auth_level value specified in the call is not valid. The system rejects the service call. Action: Check the calling program for a probable coding error. Correct the program and rerun it.
44 (2C) IEA_INVALID_MODE	Meaning: Program error. The calling program is not in primary ASC mode, which this service requires. The system rejects the service call. Action: Check the calling program for a probable coding error. Correct the program and rerun it.
52 (34) IEA_ALREADY_SUSPENDED	Meaning: The pause element was already paused. Action: Check the calling program for a probable coding error and correct the program and rerun it.

Return code in: Decimal (Hex) Equate symbol	Meaning and Action
60 (3C) IEA_AUTH_TOKEN	<p>Meaning: Program error. The caller specified auth_level=UNAUTHORIZED, but the pause element token was allocated with auth_level=AUTHORIZED. The system rejects the service call.</p> <p>Action: Program error. The specified pause element token is not valid. The system rejects the service call.</p>
64 (40) IEA_PE_NOT_HOME	<p>Meaning: Program error. The caller specified auth_level=UNAUTHORIZED, but the pause element token was for a pause element allocated to another address.</p> <p>Action: Check the calling program for a probable coding error. Correct the program and rerun it.</p>
4095 (FFF) IEA_UNEXPECTED_ERROR	<p>Meaning: This service routine encountered an unexpected error. The system rejects this service request.</p> <p>Action: Search problem reporting databases for a fix for the problem. If no fix exists, contact the IBM Support Center.</p>

Chapter 44. IEA4PSE2 – Pause service

Description

Call IEA4PSE2 service to make the current task or SRB nondispatchable. After you pause a task or SRB, it remains nondispatchable until a release or transfer specifying the same PET is called. That is, the program issuing the pause does not receive control back until after the RELEASE or TRANSFER occurs. At that time, the returned `release_code` contains a value supplied by the associated release or transfer request.

If a release service specifying the same PET is called before pause, the system returns control immediately to the calling program, and the task or SRB is not paused.

When you use pause, it returns an updated PET. Use this updated PET to either deallocate or reuse the PE.

Environment

The requirements for the caller are:

Environmental factor	Requirement
Minimum authorization:	Problem state and any PSW key
Dispatchable unit mode:	Task
Cross memory mode:	PASN=HASN=SASN
AMODE:	64-bit
RMODE:	Includes 64-bit
ASC mode:	Primary mode
Interrupt status:	Enabled for I/O and external interrupts.
Locks:	No locks held.
Control parameters:	Must be in the primary address space and addressable by the caller.

Programming requirements

Either link the object code of the calling program with the linkable stub routine (IEA4CSS from SYS1.CSSLIB) or load the calling program and then call the service. The high-level language (HLL) definitions for the callable service are:

HLL Definition	Description
IEAASM	390 Assembler declarations
IEAC	C/390 and C++/390 declarations

Restrictions

Pause elements that are created with `pause_element_auth_level=IEA_UNAUTHORIZED` may only be used by callers in task mode and can only be released from a task in their home address space.

Pause cannot be used by tasks that are higher in the task tree than the cross memory resource owning task (the top, or first, job step task in the address space).

Input register information

Before calling the Pause service, the caller must ensure that the following general purpose registers (GPRs) contain the specified information:

Register Contents

- 1** Address of the parameter address list.
- 13** Address of a 144-byte register save area.

Output register information

When control returns to the caller, the GPRs contain:

Register Contents

- 0-1** Used as work registers by the system
- 2-13** Unchanged
- 14** Used as work registers by the system
- 15** Return code

When control returns to the caller, the access registers (ARs) contain:

Register Contents

- 0-1** Used as work registers by the system
- 2-13** Unchanged
- 14-15** Used as a work register by the system

Some callers depend on register contents remaining the same before and after issuing a service. If the system changes the contents of registers on which the caller depends, the caller must save them before issuing the service, and restore them after the system returns control.

Performance implications

None.

Syntax

Syntax	Description
SYSSTATE AMODE64=YES	
CALL IEA4PSE2	,(return_code ,pause_element_token ,updated_pause_element_token ,release_code ,linkage)

Parameters

The parameters are explained as follows:

return_code

Returned parameter

- Type: Integer
- Character Set: N/A
- Length: 4 bytes

Contains the return code from the Pause service.

,pause_element_token

Supplied parameter

- Type: Character string
- Character Set: N/A
- Length: 16 bytes

A pause element token that identifies the pause element being used to pause the current task or SRB. You obtain the PET from the Allocate_Pause_Element service.

When you use a PET in a call to the pause service, you cannot reuse the PET on a second call to pause or on a call to Transfer. The pause service returns a new PET in updated_pause_element_token. The new PET now identifies the pause element used to pause the task or SRB; use the new PET the next time when you make a Pause request using the same pause element.

,updated_pause_element_token

Returned parameter

- Type: Character string
- Character Set: N/A
- Length: 16 bytes

A new pause element token that identifies the pause element originally identified by the PET specified in pause_element_token. This new PET must be used in place of the PET specified in pause_element_token on future calls to the Pause, Release, Transfer, or Deallocate_Pause_Element service.

,release_code

Returned parameter

- Type: Character string
- Character Set: N/A
- Length: 3 bytes

The release code is specified by the issuer of the release service, which can release the task or SRB of the paused condition.

,linkage

Supplied parameter

- Type: Integer
- Character Set: N/A
- Length: 4 bytes

Specifies how the Pause service routine is to be invoked. The following options are supported:

Variable	Value (hexadecimal)	Meaning
IEA_LINKAGE_SVC	0	The Pause service routine will be invoked by an SVC linkage. This option can be used when in non-cross memory task mode, in any key, and either problem state or supervisor state.
IEA_LINKAGE_BRANCH	1	The Pause service routine will be invoked by a branch instruction. The caller must be in both key 0 and supervisor state. This option must be selected when in SRB mode.

ABEND codes

Abend Code	Reason Code	Description
AC7	001A0001	This is an internal error. Contact IBM support.

Return codes

When the service returns control to your program, GPR 15 contains one of the following return codes:

Return code in: Decimal (Hex)	Equate symbol	Meaning and Action
00 (00)	IEA_SUCCESS	Meaning: Successful completion. Action: None
04 (04)	IEA_PE_TOKEN_BAD	Meaning: Program error. The specified pause element token is not valid. The system rejects the service call. Action: Check the calling program for a probable coding error. Correct the program and rerun it.
08 (08)	IEA_PE_TOKEN_STALE	Meaning: The specified pause element token is stale; that is, it was valid but has been used on the Pause or Transfer service. This service requires the updated PET returned on Pause or Transfer. Action: Check the calling program for a probable coding error. Correct the program and rerun it.
12 (0C)	IEA_DUPLICATE_PAUSE	Meaning: The work unit has already been paused using the specified pause element token. The system rejects the service call. Action: Check the calling program for a probable coding error. Correct the program and rerun it.
24 (18)	IEA_LOCK_HELD	Meaning: Program error. The caller is holding one or more locks; no locks must be held. The system rejects the service call. Action: Check the calling program for a probable coding error. Correct the program and rerun it.
32 (20)	IEA_PE_BAD_STATE	Meaning: Program error. The pause element associated with the pause element token specified in the call is not in a valid state. The system rejects the service call. Action: Check the calling program for a probable coding error, such as attempting to perform a Pause or Transfer using a pause element token that has already been used to Pause or Transfer by another unit of work. Correct the program and rerun it.

Return code in: Decimal (Hex)	Equate symbol	Meaning and Action
36 (24)	IEA_UNSUPPORTED_MVS_RELEASE	<p>Meaning: Environmental error. The system release does not support this service. The system rejects the service call.</p> <p>Action: Run the program on a system that supports the service.</p>
44 (2C)	IEA_INVALID_MODE	<p>Meaning: Program error. The calling program is not in primary ASC mode, which this service requires. The system rejects the service call.</p> <p>Action: Check the calling program for a probable coding error. Correct the program and rerun it.</p>
52 (34)	IEA_ALREADY_SUSPENDED	<p>Meaning: The pause element was already paused.</p> <p>Action: Check the calling program for a probable coding error and correct the program and rerun it.</p>
60 (3C)	IEA_AUTH_TOKEN	<p>Meaning: Program error. The caller was in Problem state or key 8, but the pause element token was allocated with pause_element_auth_level=IEA_AUTHORIZED. The system rejects the service call.</p> <p>Action: Program error. The specified pause element token is not valid. The system rejects the service call.</p>
64 (40)	IEA_PE_NOT_HOME	<p>Meaning: Program error. The pause element token was for a pause element allocated with pause_element_auth_level=IEA_UNAUTHORIZED to another address space.</p> <p>Action: Check the calling program for a probable coding error. Correct the program and rerun it.</p>
76 (4C)	IEA_ABENDED_47B	<p>Meaning: After an SRB received ABEND 47B, it invoked IEA4PSE2. It is not valid to invoke IEA4PSE2 after receiving ABEND 47B.</p> <p>Action: Update the calling program to not invoke IEA4PSE2 after ABEND 47B.</p>
80 (50)	IEA_IN_SUSPEND_EXIT	<p>Meaning: The suspend exit specified on SUSPEND with SPTOKEN of an SRB invoked IEA4PSE2. It is not valid to invoke IEA4PSE2 from a suspend exit.</p> <p>Action: Update the calling program to not invoke IEA4PSE2 from a suspend exit.</p>
4095 (FFF)	IEA_UNEXPECTED_ERROR	<p>Meaning: This service routine encountered an unexpected error. The system rejects this service request.</p> <p>Action: Search problem reporting databases for a fix for the problem. If no fix exists, contact the IBM Support Center.</p>

Chapter 45. IEA4RLS – Release

Description

Call IEA4RLS service to remove a task that has been paused, or to keep a task from being paused. Although a pause element can be used multiple times to pause a task, a pause element token can be used to successfully pause and release a task only once. Each time a pause element is used, the system generates a new PET to identify the pause element. The system returns the new updated PET on calls to the pause and transfer services.

Environment

The requirements for the caller are:

Environmental factor	Requirement
Minimum authorization:	Problem state and any PSW key.
Dispatchable unit mode:	Task
Cross memory mode:	PASN=HASN=SASN
AMODE:	64-bit
ASC mode:	Primary mode.
Interrupt status:	Enabled for I/O and external interrupts.
Locks:	No locks held.
Control parameters:	Must be in the primary address space and addressable by the caller.

Programming requirements

Either link the calling program's object code with the linkable stub routine (IEA4CSS from SYS1.CSSLIB), or load the calling program and then call the service. The high-level language (HLL) definitions for the callable service are:

HLL Definition	Description
IEAASM	390 Assembler declarations
IEAC	C/390 and C++/390 declarations

Restrictions

When the calling program specifies `auth_level=IEA_UNAUTHORIZED`, the caller must be in task mode and can only release another task in its home address space. All pause element tokens (PETs) used when `auth_level=IEA_UNAUTHORIZED` must have been obtained using an authorization level of `IEA_UNAUTHORIZED`.

Input register information

Before calling the Release service, the caller must ensure that the following general purpose (GPRs) contain the specified information:

Register Contents

IEA4RLS callable service

- 1** Address of the parameter address list.
- 13** Address of a 144-byte register save area.

Output register information

When control returns to the caller, the general purpose registers (GPRs) contain:

Register Contents

- 0-1** Used as work registers by the system
- 2-13** Unchanged
- 14** Used as a work register by the system
- 15** Return code

When control returns to the caller, the access registers (ARs) contain:

Register Contents

- 0-1** Used as work registers by the system
- 2-13** Unchanged
- 14-15** Used as a work register by the system

Some callers depend on register contents remaining the same before and after issuing a service. If the system changes the contents of registers on which the caller depends, the caller must save them before issuing the service, and restore them after the system returns control.

Performance implications

None.

Syntax

Syntax	Description
SYSSTATE AMODE64=YES	
CALL IEA4RLS	,(return_code ,auth_level ,target_du_pause_element_token ,target_du_release_code)

Parameters

The parameters are explained as follows:

return_code

Returned parameter

- Type: Integer
- Character Set: N/A
- Length: 4 bytes

Contains the return from the Release service.

,auth_level

Supplied Parameter

- Type: Integer
- Character Set: N/A
- Length: 4 bytes

Indicates the maximum authorization level that the specified pause element was allocated with. The calling program can use constant IEA_UNAUTHORIZED defined by IEAASM and IEAC. The following levels are supported:

Variable	Value (HEX)	Meaning
IEA_UNAUTHORIZED	0	The pause element being released must have been allocated with auth_level=IEA_UNAUTHORIZED.

,target_du_pause_element_token

Supplied parameter

- Type: Character string
- Character Set: N/A
- Length: 16 bytes

Contains the pause element token that identifies the pause element used to pause the task. If the PET identifies a pause element that has not been paused, the task is paused. However, the value specified in target_du_release_code is returned to the caller of pause.

,target_du_release_code

Supplied parameter

- Type: Character string
- Character Set: N/A
- Length: 3 bytes

Contains the release code returned to the caller of pause or transfer service that used or will use the same PET to pause a task. If your program is not using this code for communication, set this field to zero.

ABEND codes

None.

Return codes

When the service returns control to the resource manager, GPR 15 and the return_code parameter contain a hexadecimal return code.

Return code in: Decimal (Hex) Equate symbol	Meaning and Action
00 (00) IEA_SUCCESS	Meaning: Successful completion. Action: None.
04 (04) IEA_PE_TOKEN_BAD	Meaning: The specified pause element token is not valid. The system rejects the service call. Action: Check the calling program for a probable coding error. Correct the program and rerun it.
08 (08) IEA_PE_TOKEN_STALE	Meaning: The specified pause element token is stale; that is, it was valid but has been used on the Pause or Transfer service. This service requires the updated PET be returned on Pause or Transfer. Action: Check the calling program for a probable coding error. Correct the program and rerun it.
16 (10) IEA_SLEEP_INTERRUPTED	Meaning: RTM has ended the task; no release is necessary. Action: None.
20 (14) IEA_SPACE_TERMINATING	Meaning: The address space that contains the task is terminating; no release is necessary. Action: None.
24 (18) IEA_LOCK_HELD	Meaning: Program error. The caller is holding one or more locks; no locks must be held. The system rejects the service call. Action: Check the calling program for a probable coding error. Correct the program and rerun it.
32 (20) IEA_PE_BAD_STATE	Meaning: Program error. The pause element associated with the pause element token specified is not valid or has already been prereleased. Action: Check the calling program for a probable coding error. Correct the program and rerun it.
36 (24) IEA_UNSUPPORTED_MVS_RELEASE	Meaning: Environmental error. The system release does not support this service. The system rejects the service call. Action: Run the program on a system that supports the service.
40 (28) IEA_INVALID_AUTHCODE	Meaning: Program error. The auth_level value specified in the call is not valid. The system rejects the service call. Action: Check the calling program for a probable coding error. Correct the program and rerun it.
44 (2C) IEA_INVALID_MODE	Meaning: Program error. The calling program is not in primary ASC mode, which this service requires. The system rejects the service call. Action: Check the calling program for a probable coding error. Correct the program and rerun it.
60 (3C) IEA_AUTH_TOKEN	Meaning: Program error. The caller specified auth_level=UNAUTHORIZED, but the pause element token was allocated with auth_level=AUTHORIZED. The system rejects the service call. Action: Program error. The specified pause element token is not valid. The system rejects the service call.
64 (40) IEA_PE_NOT_HOME	Meaning: Program error. The caller specified auth_level=UNAUTHORIZED, but the pause element token was for a pause element allocated to another address. Action: Check the calling program for a probable coding error. Correct the program and rerun it.
4095 (FFF) IEA_UNEXPECTED_ERROR	Meaning: This service routine encountered an unexpected error. The system rejects this service request. Action: Contact IBM support.

Chapter 46. IEA4RLS2 – Release

Description

Call IEA4RLS2 service to remove a task or SRB that has been paused, or to keep a task or SRB from being paused.

Although a pause element can be used multiple times to pause a task or SRB, a pause element token can be used to successfully pause and release a task or SRB only once. Each time a pause element is used, the system generates a new PET to identify the pause element. The system returns the new updated PET on calls to the pause and transfer services.

Environment

The requirements for the caller are:

Environmental factor	Requirement
Minimum authorization:	Problem state and any PSW key
Dispatchable unit mode:	Task
Cross memory mode:	PASN=HASN=SASN
AMODE:	64-bit
ASC mode:	Primary mode.
Interrupt status:	Enabled for I/O and external interrupts.
Locks:	No locks held.
Control parameters:	Must be in the primary address space and addressable by the caller.

Programming requirements

Either link the object code of the calling program with the linkable stub routine (IEA4CSS from SYS1.CSSLIB) or load the calling program and then call the service. The high-level language (HLL) definitions for the callable service are:

HLL Definition	Description
IEAASM	390 Assembler declarations
IEAC	C/390 and C++/390 declarations

Restrictions

Pause elements that are created with `pause_element_auth_level=IEA_UNAUTHORIZED` may only be used by callers in task mode and can only be released from a task in their home address space.

Release cannot be used by tasks that are higher in the task tree than the cross memory resource owning task (the top, or first, job step task in the address space).

Input register information

Before calling the Release service, the caller must ensure that the following general purpose (GPRs) contain the specified information:

Register Contents

- 1** Address of the parameter address list.
- 13** Address of a 144-byte register save area.

Output register information

When control returns to the caller, the general purpose registers (GPRs) contain:

Register Contents

- 0-1** Used as work registers by the system
- 2-13** Unchanged
- 14** Used as a work register by the system
- 15** Return code

When control returns to the caller, the access registers (ARs) contain:

Register Contents

- 0-1** Used as work registers by the system
- 2-13** Unchanged
- 14-15** Used as a work register by the system

Some callers depend on register contents remaining the same before and after issuing a service. If the system changes the contents of registers on which the caller depends, the caller must save them before issuing the service, and restore them after the system returns control.

Performance implications

None.

Syntax

Syntax	Description
SYSSTATE AMODE64=YES	
CALL IEA4RLS2	,(return_code ,target_du_pause_element_token ,target_du_release_code ,linkage)

Parameters

The parameters are explained as follows:

return_code

Returned parameter

- Type: Integer
- Character Set: N/A
- Length: 4 bytes

Contains the return from the Release service.

,target_du_pause_element_token

Supplied parameter

- Type: Character string
- Character Set: N/A
- Length: 16 bytes

Contains the pause element token that identifies the pause element used to pause a task or SRB. If the PET identifies a pause element that has not been paused, the task is paused. However, the value specified in target_du_release_code is returned to the caller of pause.

,target_du_release_code

Supplied parameter

- Type: Character string
- Character Set: N/A
- Length: 3 bytes

Contains the release code returned to the caller of pause or transfer service that used or will use the same PET to pause a task or SRB. If the program is not using this code for communication, set this field to zero.

linkage

Supplied parameter

- Type: Integer
- Character Set: N/A
- Length: 4 bytes

Specifies how the Release service routine is to be invoked. The following options are supported:

Variable	Value (hexadecimal)	Meaning
IEA_LINKAGE_SVC	0	The Release service routine will be invoked by an SVC linkage. This option can be used when in non-cross memory task mode, in any key, and either problem state or supervisor state.
IEA_LINKAGE_BRANCH	1	The Release service routine will be invoked by a branch instruction. The caller must be in both key 0 and supervisor state. This option must be selected when in SRB mode.

ABEND codes

None.

Return codes

When the service returns control to the resource manager, GPR 15 and the return_code parameter contain a hexadecimal return code.

IEA4RLS2 callable service

Return code in: Decimal (Hex)	Equate symbol	Meaning and Action
00 (00)	IEA_SUCCESS	Meaning: Successful completion. Action: None.
04 (04)	IEA_PE_TOKEN_BAD	Meaning: The specified pause element token is not valid. The system rejects the service call. Action: Check the calling program for a probable coding error. Correct the program and rerun it.
08 (08)	IEA_PE_TOKEN_STALE	Meaning: The specified pause element token is stale; that is, it was valid but has been used on the Pause or Transfer service. This service requires the updated PET returned on Pause or Transfer. Action: Check the calling program for a probable coding error. Correct the program and rerun it.
16 (10)	IEA_SLEEP_DISRUPTED	Meaning: RTM has terminated the task or SRB; no release is necessary. Action: None
20 (14)	IEA_SPACE_TERMINATING	Meaning: The address space that contains the task or SRB is terminating; no release is necessary. Action: None
24 (18)	IEA_LOCK_HELD	Meaning: Program error. The caller is holding one or more locks; other than the local lock, CMS, or CPU lock, no locks may be held. The system rejects the service call. Action: Check the calling program for a probable coding error. Correct the program and rerun it.
32 (20)	IEA_PE_BAD_STATE	Meaning: Program error. The pause element associated with the pause element token specified is invalid or has already been prereleased. Action: Check the calling program for a probable coding error. Correct the program and rerun it.
36 (24)	IEA_UNSUPPORTED_MVS_RELEASE	Meaning: Environmental error. The system release does not support this service. The system rejects the service call. Action: Run the program on a system that supports the service.
44 (2C)	IEA_INVALID_MODE	Meaning: Program error. The calling program is not in primary ASC mode, which this service requires. The system rejects the service call. Action: Check the calling program for a probable coding error. Correct the program and rerun it.
60 (3C)	IEA_AUTH_TOKEN	Meaning: Program error. The caller was in Problem state or key 8, but the pause element token was allocated with pause_element_auth_level=IEA_AUTHORIZED. The system rejects the service call. Action: Program error. The specified pause element token is not valid. The system rejects the service call.
64 (40)	IEA_PE_NOT_HOME	Meaning: Program error. The pause element token was for a pause element allocated with pause_element_auth_level=IEA_UNAUTHORIZED to another address space. Action: Check the calling program for a probable coding error. Correct the program and rerun it.

Return code in: Decimal (Hex)	Equate symbol	Meaning and Action
4095 (FFF)	IEA_UNEXPECTED_ERROR	<p>Meaning: This service routine encountered an unexpected error. The system rejects this service request.</p> <p>Action: Search problem reporting databases for a fix for the problem. If no fix exists, contact the IBM Support Center.</p>

Chapter 47. IEA4RPI – Retrieve_Pause_Element_Information service

Description

Call Retrieve_Pause_Element_Information to get information about a pause element. The information returned includes:

- The authorization level of the pause element
- The address space that currently owns the pause element
- The current state (reset, prereleased, paused, or released) of the pause element
- If the state of the pause element is prereleased or released, the release code of the pause element

An authorized program can use Retrieve_Pause_Element_Information to test the validity of a pause element passed by an unauthorized program. The authorized program can do this to ensure that it does not perform any operation, such as releasing the pause element, unless the unauthorized program is also able to perform the same operation.

Environment

The requirements for the caller are:

Environmental factor	Requirement
Minimum authorization:	Problem state and any PSW key
Dispatchable unit mode:	Task
Cross memory mode:	PASN=HASN=SASN
AMODE:	64-bit
RMODE:	Includes 64-bit
ASC mode:	Primary mode.
Interrupt status:	Enabled for I/O and external interrupts.
Locks:	No locks held.
Control parameters:	Must be in the primary address space and addressable by the caller.

Programming requirements

Either link the object code of calling program with the linkable stub routine (IEA4CSS from SYS1.CSSLIB), or load the calling program and then call the service. The high-level language (HLL) definitions for the callable service are:

HLL Definition	Description
IEAASM	390 Assembler declarations
IEAC	C/390 and C++/390 declarations

Restrictions

None.

Input register information

Before calling the Retrieve_Pause_Element_Information service, the caller does not need to place any information into any register, unless using it in register notation for the parameters, or using it as a base register.

Output register information

When control returns to the caller, the GPRs contain:

Register Contents

0-1

Used as work registers by the system

2-13

Unchanged

14

Used as a work register by the system

15

Return code

When control returns to the caller, the access registers (ARs) contain:

Register Contents

0-1

Used as work registers by the system

2-13

Unchanged

14-15

Used as work registers by the system

Some callers depend on register contents remaining the same before and after issuing a service. If the system changes the contents of registers on which the caller depends, the caller must save them before issuing the service, and restore them after the system returns control.

Performance implications

None.

Syntax

Syntax	Description
SYSSTATE AMODE64=YES	
CALL IEA4RPI	,(return_code ,auth_level ,pause_element_token ,authorization ,owner ,state ,release_code)

Parameters

The parameters are explained as follows:

return_code

Returned parameter

- Type: Integer
- Character Set: N/A
- Length: 4 bytes

Contains the return code from the Retrieve_Pause_Element_Information service.

,auth_level

Returned parameter

- Type: Integer
- Character Set: N/A
- Length: 4 bytes

Indicates the caller's authorization level. The following levels are supported: IEAASM and IEAC define constants IEA_UNAUTHORIZED and IEA_AUTHORIZED, which can be used by the calling program.

Variable	Value (hexadecimal)	Meaning
IEA_UNAUTHORIZED	0	The caller is not key 0 and supervisor state.
IEA_AUTHORIZED	1	The caller is both key 0 and supervisor state.

,pause_element_token

Supplied parameter

- Type: Character string
- Character Set: N/A
- Length: 16 bytes

A pause element token that identifies the pause element for which information will be returned. You can obtain the PET from the Allocate_Pause_Element service.

,authorization

Returned parameter

- Type: Integer
- Character Set: N/A
- Length: 4 bytes

The authorization level of the creator of the pause element specified by the input PET.

One of the following values:

IEAASM and IEAC defined constants	Value (hexadecimal)	Meaning
IEA_UNAUTHORIZED	0	The caller is not key 0 and supervisor state.
IEA_AUTHORIZED	1	The caller is not key 0 and supervisor state.
IEA_UNAUTHORIZED + IEA_CHECKPOINTOK	2	Unauthorized PET that can tolerate the pause elements' not being restored upon a restart after a checkpoint.
IEA_AUTHORIZED + IEA_CHECKPOINTOK	3	Authorized PET that can tolerate the pause elements' not being restored upon a restart after a checkpoint.

,owner

Returned parameter

IEA4RPI callable service

- Type: Character string
- Character Set: N/A
- Length: 8 bytes

The token of the address space that currently owns the pause element specified by the input PET.

,state

Returned parameter

- Type: Integer
- Character Set: N/A
- Length: 4 bytes

The state of the pause element specified by the input PET.

Note: The value returned is the state at the time the service obtained it. The state might have changed after it was obtained.

State Constant Hexadecimal (Decimal)	Meaning
IEA4_PET_PRERELEASED 1 (1)	The PE was released before any task or SRB was suspended on it, and no task or SRB has attempted to pause it.
IEA4_PET_RESET 2 (2)	The PE is not being used to make any task or SRB nondispatchable. If the PE is used in an attempt to pause the current task or SRB, the task or SRB will be made nondispatchable.
IEA4_PET_RELEASED 40 (64)	The task RB or SRB is currently dispatchable, but control has not been returned to the task or SRB following a call to the Pause or Transfer service. A call to the Release or Transfer service has released the task or SRB. In either case, control has not been returned to the caller of the Pause or Transfer service. The system has not transited the PE into the RESET state.
IEA4_PET_PAUSED 80 (128)	A task RB or SRB is currently nondispatchable. Its dispatchability is controlled by the PE.

,release_code

Returned parameter

- Type: Character string
- Character Set: N/A
- Length: 3 bytes

The release code is specified by the issuer of the release service, which can release the task or SRB from the paused condition.

Note: The returned value is random if the state parameter is not IEA4_PET_RELEASED or IEA4_PET_PRERELEASED.

ABEND codes

None.

Return codes

When the service returns control to your program, GPR 15 contains one of the following return codes:

Return code in: Decimal (Hex)	Equate symbol	Meaning and Action
00 (00)	IEA_SUCCESS	Meaning: Successful completion. Action: None.
04 (04)	IEA_PE_TOKEN_BAD	Meaning: Program error. The specified pause element token is not valid. The system rejects the service call. Action: Check the calling program for a probable coding error. Correct the program and rerun it.
08 (08)	IEA_PE_TOKEN_STALE	Meaning: The specified pause element token is stale; that is, it was valid but has been used on the Pause or Transfer service. This service requires the updated PET returned on Pause or Transfer. Action: Check the calling program for a probable coding error. Correct the program and rerun it.
24 (18)	IEA_LOCK_HELD	Meaning: Program error. The caller is holding one or more locks; no locks must be held. The system rejects the service call. Action: Check the calling program for a probable coding error. Correct the program and rerun it.
36 (24)	IEA_UNSUPPORTED_MVS_RELEASE	Meaning: Environmental error. The system release does not support this service. The system rejects the service call. Action: Run the program on a system that supports the service.
44 (2C)	IEA_INVALID_MODE	Meaning: Program error. The calling program is not in primary ASC mode, which this service requires. The system rejects the service call. Action: Check the calling program for a probable coding error. Correct the program and rerun it.
60 (3C)	IEA_AUTH_TOKEN	Meaning: Program error. The caller specified an unauthorized auth_level type, but a pause element token allocated with an authorized auth_level type was encountered. The system rejects the service call. Action: Program error. The specified pause element token is not valid. The system rejects the service call.
64 (40)	IEA_PE_NOT_HOME	Meaning: Program error. The caller specified an unauthorized auth_level type, but a pause element token for a pause element allocated to another address space was specified. Action: Check the calling program for a probable coding error. Correct the program and rerun it.
4095 (FFF)	IEA_UNEXPECTED_ERROR	Meaning: This service routine encountered an unexpected error. The system rejects this service request. Action: Search problem reporting databases for a fix for the problem. If no fix exists, contact the IBM Support Center.

Chapter 48. IEA4RPI2 – Retrieve_Pause_Element_Information service

Description

Call Retrieve_Pause_Element_Information to get information about a pause element. The information returned includes:

- The authorization level of the pause element
- The address space that currently owns the pause element
- The current state (reset, prereleased, paused, or released) of the pause element
- If the state of the pause element is prereleased or released, the release code of the pause element

An authorized program can use Retrieve_Pause_Element_Information to test the validity of a pause element passed by an unauthorized program. The authorized program can do this to ensure that it does not perform any operation, such as releasing the pause element, unless the unauthorized program is also able to perform the same operation.

Environment

The requirements for the caller are:

Environmental factor	Requirement
Minimum authorization:	Problem state and any PSW key
Dispatchable unit mode:	Task
Cross memory mode:	PASN=HASN=SASN
AMODE:	64-bit
RMODE:	Includes 64-bit
ASC mode:	Primary mode.
Interrupt status:	Enabled for I/O and external interrupts.
Locks:	No locks held.
Control parameters:	Must be in the primary address space and addressable by the caller.

Programming requirements

Either link the object code of calling program with the linkable stub routine (IEA4CSS from SYS1.CSSLIB), or load the calling program and then call the service. The high-level language (HLL) definitions for the callable service are:

HLL Definition	Description
IEAASM	390 Assembler declarations
IEAC	C/390 and C++/390 declarations

Restrictions

Pause elements that are created with `pause_element_auth_level=IEA_UNAUTHORIZED` may only be used by callers in task mode and can only be released from a task in their home address space.

Input register information

Before calling the Retrieve_Pause_Element_Information service, the caller does not need to place any information into any register, unless using it in register notation for the parameters, or using it as a base register.

Output register information

When control returns to the caller, the GPRs contain:

Register Contents

0-1

Used as work registers by the system

2-13

Unchanged

14

Used as a work register by the system

15

Return code

When control returns to the caller, the access registers (ARs) contain:

Register Contents

0-1

Used as work registers by the system

2-13

Unchanged

14-15

Used as work registers by the system

Some callers depend on register contents remaining the same before and after issuing a service. If the system changes the contents of registers on which the caller depends, the caller must save them before issuing the service, and restore them after the system returns control.

Performance implications

None.

Syntax

Syntax	Description
SYSSTATE AMODE64=YES	
CALL IEA4RPI2	,(return_code ,pause_element_token ,linkage ,owner ,current_stoken ,authorization ,state ,release_code)

Parameters

The parameters are explained as follows:

return_code

Returned parameter

- Type: Integer
- Character Set: N/A
- Length: 4 bytes

Contains the return code from the Retrieve_Pause_Element_Information service.

,pause_element_token

Supplied parameter

- Type: Character string
- Character Set: N/A
- Length: 16 bytes

A pause element token that identifies the pause element for which information will be returned. You can obtain the PET from the Allocate_Pause_Element service.

linkage

Supplied parameter

- Type: Integer
- Character Set: N/A
- Length: 4 bytes

Specifies how the Retrieve_Pause_Element_Information service routine is to be invoked. The following options are supported:

Variable	Value (hexadecimal)	Meaning
IEA_LINKAGE_SVC	0	The Retrieve_Pause_Element_Information service routine will be invoked by an SVC linkage. This option can be used when in non-cross memory task mode, in any key, and in either problem state or supervisor state.
IEA_LINKAGE_BRANCH	1	The Retrieve_Pause_Element_Information service routine will be invoked by a branch instruction. The caller must be in both key 0 and supervisor state. This option must be selected when in SRB mode.

,owner

Returned parameter

- Type: Character string
- Character Set: N/A
- Length: 8 bytes

The Stoken of the address space that currently owns the pause element specified by the input PET.

,current_stoken

Returned parameter

- Type: Character string
- Character Set: N/A
- Length: 8 bytes

If the value returned in state is IEA_PET_PAUSED, The token of the home address space of the task or SRB which is paused by the specified pause element. If the value in state is not IEA_PET_PAUSED, the information returned in this parameter is undefined.

,authorization

Returned parameter

- Type: Integer
- Character Set: N/A
- Length: 4 bytes

The authorization level of the creator of the pause element specified by the input PET.

One of the following values:

IEAASM and IEAC defined constants	Value (hexadecimal)	Meaning
IEA_UNAUTHORIZED	0	The caller is not supervisor state or not key 0.
IEA_AUTHORIZED	1	The caller is supervisor state and key 0.
IEA_UNAUTHORIZED + IEA_CHECKPOINTOK	2	Unauthorized PET that can tolerate the pause elements' not being restored upon a restart after a checkpoint.
IEA_AUTHORIZED + IEA_CHECKPOINTOK	3	Authorized PET that can tolerate the pause elements' not being restored upon a restart after a checkpoint.

,state

Returned parameter

- Type: Integer
- Character Set: N/A
- Length: 4 bytes

The state of the pause element specified by the input PET.

Note: The value returned is the state at the time the service obtained it. The state might have changed after it was obtained.

State Constant Hexadecimal (Decimal)	Meaning
IEA4_PET_PRERELEASED 1 (1)	The PE was released before any task or SRB was suspended on it, and no task or SRB has attempted to pause it.
IEA4_PET_RESET 2 (2)	The PE is not being used to make any task or SRB nondispatchable. If the PE is used in an attempt to pause the current task or SRB, the task or SRB will be made nondispatchable.
IEA4_PET_RELEASED 40 (64)	The task RB or SRB is currently dispatchable, but control has not been returned to the task or SRB following a call to the Pause or Transfer service. A call to the Release or Transfer service has released the task or SRB. In either case, control has not been returned to the caller of the Pause or Transfer service. The system has not transited the PE into the RESET state.

State Constant Hexadecimal (Decimal)	Meaning
IEA4_PET_PAUSED 80 (128)	A task RB or SRB is currently nondispatchable. Its dispatchability is controlled by the PE.

,release_code

Returned parameter

- Type: Character string
- Character Set: N/A
- Length: 3 bytes

The release code is specified by the issuer of the release service, which can release the task or SRB from the paused condition.

Note: The returned value is random if the state parameter is not IEA4_PET_RELEASED or IEA4_PET_PRERELEASED.

ABEND codes

None.

Return codes

When the service returns control to your program, GPR 15 contains one of the following return codes:

Return code in: Decimal (Hex)	Equate symbol	Meaning and Action
00 (00)	IEA_SUCCESS	Meaning: Successful completion. Action: None.
04 (04)	IEA_PE_TOKEN_BAD	Meaning: Program error. The specified pause element token is not valid. The system rejects the service call. Action: Check the calling program for a probable coding error. Correct the program and rerun it.
08 (08)	IEA_PE_TOKEN_STALE	Meaning: The specified pause element token is stale; that is, it was valid but has been used on the Pause or Transfer service. This service requires the updated PET returned on Pause or Transfer. Action: Check the calling program for a probable coding error. Correct the program and rerun it.
24 (18)	IEA_LOCK_HELD	Meaning: Program error. The caller is holding one or more locks; no locks must be held. The system rejects the service call. Action: Check the calling program for a probable coding error. Correct the program and rerun it.
36 (24)	IEA_UNSUPPORTED_MVS_RELEASE	Meaning: Environmental error. The system release does not support this service. The system rejects the service call. Action: Run the program on a system that supports the service.

IEA4RPI2 callable service

Return code in: Decimal (Hex)	Equate symbol	Meaning and Action
40 (28)	IEA_INVALID_AUTHCODE	<p>Meaning: Program error. The pause_element_auth_level value specified in the call is not valid. The system rejects the service call.</p> <p>Action: Check the calling program for a probable coding error. Correct the program and rerun it.</p>
44 (2C)	IEA_INVALID_MODE	<p>Meaning: Program error. The calling program is not in primary ASC mode, which this service requires. The system rejects the service call.</p> <p>Action: Check the calling program for a probable coding error. Correct the program and rerun it.</p>
60 (3C)	IEA_AUTH_TOKEN	<p>Meaning: Program error. The caller was in Problem state or key 8, but the pause element token was allocated with pause_element_auth_level=IEA_AUTHORIZED. The system rejects the service call.</p> <p>Action: Program error. The specified pause element token is not valid. The system rejects the service call.</p>
64 (40)	IEA_PE_NOT_HOME	<p>Meaning: Program error. The pause element token was for a pause element allocated with pause_element_auth_level=IEA_UNAUTHORIZED to another address space.</p> <p>Action: Check the calling program for a probable coding error. Correct the program and rerun it.</p>
4095 (FFF)	IEA_UNEXPECTED_ERROR	<p>Meaning: This service routine encountered an unexpected error. The system rejects this service request.</p> <p>Action: Search problem reporting databases for a fix for the problem. If no fix exists, contact the IBM Support Center.</p>

Chapter 49. IEA4TPE – Test_Pause_Element service

Description

Call Test_Pause_Element to test a pause element and determine its state. If the state is prereleased or released, the release code of the pause element also is returned.

To ensure minimal overhead when you use the service, Test_Pause_Element establishes no recovery. You are responsible for supplying any needed recovery to handle errors that occur because of the incorrect input pause element tokens or call state errors.

Environment

The requirements for the caller are:

Environmental factor	Requirement
Minimum authorization:	Problem state and any PSW key
Dispatchable unit mode:	Task
Cross memory mode:	PASN=HASN=SASN
AMODE:	64-bit
ASC mode:	Primary mode.
Interrupt status:	Enabled for I/O and external interrupts.
Locks:	No locks held.
Control parameters:	Must be in the primary address space and addressable by the caller.

Programming requirements

Either link the object code of the calling program with the linkable stub routine (IEA4CSS from SYS1.CSSLIB), or load the calling program and then call the service. The high-level language (HLL) definitions for the callable service are:

HLL Definition	Description
IEAASM	390 Assembler declarations
IEAC	C/390 and C++/390 declarations

Restrictions

None.

Input register information

Before calling the Test_Pause_Element service, the caller does not have to place any information into any register, unless using the input register in register notation for the parameters, or using the input register as a base register.

Output register information

When control returns to the caller, the GPRs contain:

IEA4TPE callable service

Register Contents

0-1

Used as work registers by the system

2-13

Unchanged

14

Used as a work register by the system

15

Return code

When control returns to the caller, the access registers (ARs) contain:

Register Contents

0-1

Used as work registers by the system

2-13

Unchanged

14-15

Used as work registers by the system

Some callers depend on register contents remaining the same before and after issuing a service. If the system changes the contents of registers on which the caller depends, the caller must save them before issuing the service, and restore them after the system returns control.

Performance implications

None.

Syntax

Syntax	Description
SYSSTATE AMODE64=YES	
CALL IEA4TPE	,(return_code ,pause_element_token ,state ,release_code)

Parameters

The parameters are explained as follows:

return_code

Returned parameter

- Type: Integer
- Character Set: N/A
- Length: 4 bytes

Contains the return code from the Test_Pause_Element service.

,pause_element_token

Supplied parameter

- Type: Character string
- Character Set: N/A
- Length: 16 bytes

A pause element token that identifies the pause element for which information is to be returned. You can obtain the PET from the Allocate_Pause_Element service.

,state

Returned parameter

- Type: Integer
- Character Set: N/A
- Length: 4 bytes

The state of the pause element specified by the input PET.

Note: The value returned is the state at the time the service obtained it. The state might have changed after it was obtained.

State Constant Hexadecimal (Decimal)	Meaning
IEA4_PET_PRERELEASED 1 (1)	The PE was released before any task or SRB was suspended on it, and no task or SRB has attempted to pause it.
IEA4_PET_RESET 2 (2)	The PE is not being used to make any task or SRB nondispatchable. If the PE is used in an attempt to pause the current task or SRB, the task or SRB is made nondispatchable.
IEA4_PET_RELEASED 40 (64)	The task RB or SRB is currently dispatchable, but control has not been returned to the task or SRB following a call to the Pause or Transfer service. A call to the release or transfer service has released the task or SRB. In either case, control has not been returned to the caller of the pause or transfer service. The system has not change the PE into the RESET state.
IEA4_PET_PAUSED 80 (128)	A task RB or SRB is currently nondispatchable. Its dispatchability is controlled by the PE.

,release_code

Returned parameter

- Type: Character string
- Character Set: N/A
- Length: 3 bytes

The release code is specified by the issuer of the Release service, which released the task or SRB from the paused condition.

Note: The returned value is random if the state parameter is not IEA4_PET_RELEASED or IEA4_PET_PRERELEASED.

ABEND codes

None.

Return codes

When the service returns control to your program, GPR 15 contains one of the following return codes:

Return code in: Decimal (Hex)	Equate symbol	Meaning and Action
00 (00)	IEA_SUCCESS	Meaning: Successful completion. Action: None.
04 (04)	IEA_PE_TOKEN_BAD	Meaning: Program error. The specified pause element token is not valid. The system rejects the service call. Action: Check the calling program for a probable coding error. Correct the program and rerun it.
08 (08)	IEA_PE_TOKEN_STALE	Meaning: The specified pause element token is stale; that is, it was valid but has been used on the Pause or Transfer service. This service requires the updated PET returned on Pause or Transfer. Action: Check the calling program for a probable coding error. Correct the program and rerun it.

Chapter 50. IEA4XFR – Transfer service

Description

Call IEA4XFR service to release a paused task, and, when possible, give the task immediate control. This service can also, optionally, pause the task under which the transfer request is made. If the caller does not request that its task be paused, the caller's task remains dispatchable.

Environment

The requirements for the caller are:

Environmental factor	Requirement
Minimum authorization:	Problem state and any PSW key.
Dispatchable unit mode:	Task
Cross memory mode:	PASN=HASN=SASN
AMODE:	64-bit
RMODE:	Includes 64-bit
ASC mode:	Primary mode.
Interrupt status:	Enabled for I/O and external interrupts
Locks:	No Locks held.
Control parameters:	Must be in the primary address space and addressable by the caller.

Programming requirements

Either link the object code of the calling program with the linkable stub routine (IEA4CSS from SYS1.CSSLIB), or load the calling program and then call the service. The high-level language (HLL) definitions for the callable service are:

HLL Definition	Description
IEAASM	390 Assembler declarations
IEAC	C/390 and C++/390 declarations

Restrictions

When the calling program specifies `auth_level=IEA_UNAUTHORIZED`, the caller must be in task mode and can only transfer to another task in its home address space. All pause element tokens (PETs) used when `auth_level=IEA_UNAUTHORIZED` must have been obtained using an authorization level of `IEA_UNAUTHORIZED`.

Input register information

Before calling the Transfer service, the caller must ensure that the following general purpose registers (GPRs) contain the specified information:

Register Contents

- 1** Address of the parameter address list.
- 13** Address of a 144-byte register save area.

Output register information

When control returns to the caller, the general purpose registers (GPRs) contain:

Register Contents

- 0-1** Used as work registers by the system
- 2-13** Unchanged
- 14** Used as a work register by the system
- 15** Return code

When control returns to the caller, the access registers (ARs) contain:

Register Contents

- 0-1** Used as work registers by the system
- 2-14** Unchanged
- 15** Used as a work register by the system

Some callers depend on register contents remaining the same before and after issuing a service. If the system changes the contents of registers on which the caller depends, the caller must save them before issuing the service, and restore them after the system returns control.

Performance implications

None.

Syntax

Syntax	Description
SYSSTATE AMODE64=YES	
CALL IEA4XFR	,(return_code ,auth_level ,current_du_pause_element_token ,updated_pause_element_token ,current_du_release_code ,target_du_pause_element_token ,target_du_release_code)

Parameters

The parameters are explained as follows:

return_code

Returned parameter

- Type: Integer
- Character Set: N/A
- Length: 4 bytes

Contains the return code from the transfer service.

,auth_level

Supplied parameter

- Type: Integer
- Character Set: N/A
- Length: 4 bytes

Indicates the maximum authorization level of the pause element being deallocated. The calling program can use constant IEA_UNAUTHORIZED that is defined by IEAASM and IEAC. The following levels are supported:

Variable	Value (HEX)	Meaning
IEA_UNAUTHORIZED	0	The pause elements must have been allocated with auth_level=_UNAUTHORIZED.

,current_du_pause_element_token

Supplied parameter

- Type: Character string
- Character Set: N/A
- Length: 16 bytes

Contains a pause element token that identifies the pause element used to pause the current task. When a PET is used on a call to the pause service, it cannot be reused on a second call to pause or as a current_du_pause_element_token on transfer. A new PET is returned to updated_pause_element_token. The new PET now properly defines the pause element and should be used the next time when a pause, transfer, release, or deallocate_pause_element request is using the same pause element.

If the value specified is 16-bytes of binary zeros, the current task will not be paused. The updated_pause_element_token and current_du_release_code are unpredictable.



CAUTION: Do not specify the same PET for both current_du_pause_element_token and target_pause_element_token.

,updated_pause_element_token

Returned parameter

- Type: Character string
- Character Set: N/A
- Length: 16 bytes

Contains a new pause element token that identifies the pause element originally identified by the PET specified in current_du_pause_element_token. The PET originally specified in current_du_pause_element_token cannot be reused after a successful call to pause or transfer service.

If you set the current_du_pause_element_token to zeros, the contents of updated_pause_element_token are unpredictable.

,current_du_release_code

Returned parameter

- Type: Character string
- Character Set: N/A
- Length: 3 bytes

Contains the release code set by the issuer of the release or transfer service that released the current task from the paused condition.

If you set the `current_du_pause_element_token` to zero, the contents are unpredictable.

,target_du_pause_element_token

Supplied parameter

- Type: Character string
- Character Set: N/A
- Length: 16 bytes

Contains a pause element token that identifies the pause element to release the target task. Any PET that specifies a pause element not currently being used to pause a task is valid. When a PET for a previously released pause element is used to try to pause a task, the task is not paused; however, the value specified in `target_du_release_code` will still be returned to the caller of pause or transfer service.

If the task was paused and is now dispatchable, the task will immediately be given control on the current processor.



CAUTION: Do not use the same PET for both `current_du_pause_element_token` and `target_du_pause_element_token`.

,target_du_release_code

Supplied parameter

- Type: Character string
- Character Set: N/A
- Length: 3 bytes

Contains the release code returned to the caller of the pause or transfer service that used (or will use) the same PET to pause a task.

ABEND codes

None.

Return codes

When the service returns control to the resource manager, GPR 15 and the `return_code` parameter contain a hexadecimal return code.

Return Code in: Decimal (Hex)	Equate symbol	Meaning and Action
00 (00)	IEA_SUCCESS	Meaning: Successful completion. Action: None.
04 (04)	IEA_PE_TOKEN_BAD	Meaning: Program error. The specified pause element token is not valid. The system rejects the service call. Action: Check the calling program for a probable coding error. Correct the program and rerun it.

Return Code in: Decimal (Hex)	Equate symbol	Meaning and Action
08 (08)	IEA_PE_TOKEN_STALE	<p>Meaning: The specified pause element token is stale; that is, it was valid but has been used on the Pause or Transfer service. This service requires the updated PET returned on Pause or Transfer.</p> <p>Action: Check the calling program for a probable coding error. Correct the program and rerun it.</p>
12 (0C)	IEA_DUPLICATE_PAUSE	<p>Meaning: The work unit has already been paused using the specified pause element token. The system rejects the service call.</p> <p>Action: Check the calling program for a probable coding error. Correct the program and rerun it.</p>
16 (10)	IEA_SLEEP_DISRUPTED	<p>Meaning: RTM has terminated the task; no release is necessary.</p> <p>Action: None</p>
20 (14)	IEA_SPACE_TERMINATING	<p>Meaning: The address space that contains the task is terminating; no release is necessary.</p> <p>Action: None</p>
24 (18)	IEA_LOCK_HELD	<p>Meaning: Program error. The caller is holding one or more locks; no locks must be held. The system rejects the service call.</p> <p>Action: Check the calling program for a probable coding error. Correct the program and rerun it.</p>
32 (20)	IEA_PE_BAD_STATE	<p>Meaning: Program error. The pause element associated with the pause element token specified in the call is not in a valid state. The system rejects the service call.</p> <p>Action: Check the calling program for a probable coding error, such as attempting to perform a Pause or Transfer using a pause element token that has already been used to Pause or Transfer by another unit of work. Correct the program and rerun it.</p>
36 (24)	IEA_UNSUPPORTED_MVS_RELEASE	<p>Meaning: Environmental error. The system release does not support this service. The system rejects the service call.</p> <p>Action: Run the program on a system that supports the service.</p>
40 (28)	IEA_INVALID_AUTHCODE	<p>Meaning: Program error. The auth_level value specified in the call is not valid. The system rejects the service call.</p> <p>Action: Check the calling program for a probable coding error. Correct the program and rerun it.</p>
44 (2C)	IEA_INVALID_MODE	<p>Meaning: Program error. The calling program is not in primary ASC mode, which this service requires. The system rejects the service call.</p> <p>Action: Check the calling program for a probable coding error. Correct the program and rerun it.</p>
52 (34)	IEA_ALREADY_SUSPENDED	<p>Meaning: The pause element was already paused.</p> <p>Action: Check the calling program for a probable coding error and correct the program and rerun it.</p>

IEA4XFR callable service

Return Code in: Decimal (Hex)	Equate symbol	Meaning and Action
60 (3C)	IEA_AUTH_TOKEN	<p>Meaning: Program error. The caller specified auth_level=UNAUTHORIZED, but the pause element token was allocated with auth_level=AUTHORIZED. The system rejects the service call.</p> <p>Action: Program error. The specified pause element token is not valid. The system rejects the service call.</p>
64 (40)	IEA_PE_NOT_HOME	<p>Meaning: Program error. The caller specified auth_level=UNAUTHORIZED, but the pause element token was for a pause element allocated to another address.</p> <p>Action: Check the calling program for a probable coding error. Correct the program and rerun it.</p>
68 (44)	IEA_XFER_TO_SELF	<p>Meaning: Program error. The specified current_du_pause_element_token and target_du_pause_element_token are the same.</p> <p>Action: Check the calling program for a probable coding error. Correct the program and rerun it.</p>
72 (48)	IEA_XFER_FAILED	<p>Meaning: The transfer failed, and the current_du_pause_element_token is no longer useable.</p> <p>Action: Reissue the transfer request using the updated_du_pause_element_token. Deallocate the current_du_pause_element_token.</p>
4095 (FFF)	IEA_UNEXPECTED_ERROR	<p>Meaning: This service routine encountered an unexpected error. The system rejects this service request.</p> <p>Action: Search problem reporting databases for a fix for the problem. If no fix exists, contact the IBM Support Center.</p>

Chapter 51. IEA4XFR2 – Transfer service

Description

Call IEA4XFR2 service to release a paused task or SRB, and, when possible, give the task or SRB immediate control. This service can also, optionally, pause the task or SRB under which the transfer request is made. If the caller does not request that its task or SRB be paused, the caller's task or SRB remains dispatchable.

Environment

The requirements for the caller are:

Environmental factor	Requirement
Minimum authorization:	Problem state and any PSW key
Dispatchable unit mode:	Task
Cross memory mode:	PASN=HASN=SASN
AMODE:	64-bit
RMODE:	Includes 64-bit
ASC mode:	Primary mode.
Interrupt status:	Enabled for I/O and external interrupts.
Locks:	No locks held.
Control parameters:	Must be in the primary address space and addressable by the caller.

Programming requirements

Either link the calling program's object code with the linkable stub routine (IEA4CSS from SYS1.CSSLIB) or load the calling program and then call the service. The high-level language (HLL) definitions for the callable service are:

HLL Definition	Description
IEAASM	390 Assembler declarations
IEAC	C/390 and C++/390 declarations

Restrictions

Pause elements that are created with `pause_element_auth_level=IEA_UNAUTHORIZED` may only be used by callers in task mode and can only be released from a task in their home address space.

Transfer cannot be used by tasks that are higher in the task tree than the cross memory resource owning task (the top, or first, job step task in the address space).

Input register information

Before calling the Transfer service, the caller must ensure that the following general purpose registers (GPRs) contain the specified information:

Register Contents

- 1** Address of the parameter address list.
- 13** Address of a 144-byte register save area.

Output register information

When control returns to the caller, the general purpose registers (GPRs) contain:

Register Contents

- 0-1** Used as work registers by the system
- 2-13** Unchanged
- 14** Used as a work register by the system
- 15** Return code

When control returns to the caller, the access registers (ARs) contain:

Register Contents

- 0-1** Used as work registers by the system
- 2-14** Unchanged
- 15** Used as a work register by the system

Some callers depend on register contents remaining the same before and after issuing a service. If the system changes the contents of registers on which the caller depends, the caller must save them before issuing the service, and restore them after the system returns control.

Performance implications

None.

Syntax

Syntax	Description
SYSSTATE AMODE64=YES CALL IEA4XFR2	,(return_code ,current_du_pause_element_token ,updated_pause_element_token ,current_du_release_code ,target_du_pause_element_token ,target_du_release_code ,linkage)

Parameters

The parameters are explained as follows:

return_code

Returned parameter

- Type: Integer
- Character Set: N/A
- Length: 4 bytes

Contains the return code from the Transfer service.

,current_du_pause_element_token

Supplied parameter

- Type: Character string
- Character Set: N/A
- Length: 16 bytes

Contains a pause element token that identifies the pause element that is being or will be used to pause a task or SRB. When a PET is used on a call to the pause service, it cannot be reused on a second call to pause or as a `current_du_pause_element_token` on transfer. A new PET is returned to `update_pause_element_token`. The new PET now properly defines the pause element and should be used the next time when a pause, transfer, release, or `deallocate_pause_element` request is using the same pause element.

If the value specified is 16-bytes of binary zeros, the current task or SRB will not be paused. The `updated_pause_element_token` and `current_du_release_code` are unpredictable.



CAUTION: Do not specify the same PET for both `current_du_pause_element_token` and `target_pause_element_token`.

,updated_pause_element_token

Returned parameter

- Type: Character string
- Character Set: N/A
- Length: 16 bytes

Contains a new pause element token that identifies the pause element originally identified by the PET specified in `current_du_pause_element_token`. The PET originally specified in `current_du_pause_element_token` cannot be reused after a successful call to Pause or Transfer.

If you set the `current_du_pause_element_token` to zeros, the contents of `updated_pause_element_token` are unpredictable.

,current_du_release_code

Returned parameter

- Type: Character string
- Character Set: N/A
- Length: 3 bytes

Contains the release code set by the issuer of the release or transfer service that released the current task or SRB from the paused condition.

If you set the `current_du_pause_element_token` to zero, the contents are unpredictable.

,target_du_pause_element_token

Supplied parameter

- Type: Character string
- Character Set: N/A
- Length: 16 bytes

Contains a pause element token that identifies a pause element that is being or will be used to pause a task or SRB. If the task or SRB is paused, it will be released, and, if possible, be given control. If the task or SRB is not paused using the specified pause element, it will not be paused when an attempt to pause is made. In either case the task or SRB will be returned the value specified in `target_release_code`.



CAUTION: Do not use the same PET for both `current_du_pause_element_token` and `target_du_pause_element_token`.

,`target_du_release_code`

Supplied parameter

- Type: Character string
- Character Set: N/A
- Length: 3 bytes

Contains the release code returned to the caller of the pause or transfer service used (or will use) the PET specified in `target_du_pause_element_token` to pause a task or SRB.

linkage

Supplied parameter

- Type: Integer
- Character Set: N/A
- Length: 4 bytes

Specifies how the Transfer service routine is to be invoked. The following options are supported:

Variable	Value (hexadecimal)	Meaning
IEA_LINKAGE_SVC	0	The Transfer service routine will be invoked by an SVC linkage. This option can be used when in non-cross memory task mode, in any key, and either problem state or supervisor state.
IEA_LINKAGE_BRANCH	1	The Transfer service routine will be invoked by a branch instruction. The caller must be in both key 0 and supervisor state. This option must be selected when in SRB mode.

ABEND codes

None.

Return codes

When the service returns control to the resource manager, GPR 15 and the `return_code` parameter contain a hexadecimal return code.

Return Code in: Decimal (Hex)	Equate symbol	Meaning and Action
00 (00)	IEA_SUCCESS	Meaning: Successful completion. Action: None
04 (04)	IEA_PE_TOKEN_BAD	Meaning: Program error. The specified pause element token is not valid. The system rejects the service call. Action: Check the calling program for a probable coding error. Correct the program and rerun it.

Return Code in: Decimal (Hex)	Equate symbol	Meaning and Action
08 (08)	IEA_PE_TOKEN_STALE	<p>Meaning: The specified pause element token is stale; that is, it was valid but has been used on the Pause or Transfer service. This service requires the updated PET returned on Pause or Transfer.</p> <p>Action: Check the calling program for a probable coding error. Correct the program and rerun it.</p>
12 (0C)	IEA_DUPLICATE_PAUSE	<p>Meaning: The work unit has already been paused using the specified pause element token. The system rejects the service call.</p> <p>Action: Check the calling program for a probable coding error. Correct the program and rerun it.</p>
16 (10)	IEA_SLEEP_DISRUPTED	<p>Meaning: RTM has terminated the task or SRB; no release is necessary.</p> <p>Action: None</p>
20 (14)	IEA_SPACE_TERMINATING	<p>Meaning: The address space that contains the task or SRB is terminating; no release is necessary.</p> <p>Action: None</p>
24 (18)	IEA_LOCK_HELD	<p>Meaning: Program error. If a current_du_pause_element_token of 16 bytes of binary zeros is specified, one or more locks other than the local lock are held. Otherwise, one or more locks are held. The system rejects the service call.</p> <p>Action: Check the calling program for a probable coding error. Correct the program and rerun it.</p>
32 (20)	IEA_PE_BAD_STATE	<p>Meaning: Program error. The pause element associated with the pause element token specified in the call is not in a valid state. The system rejects the service call.</p> <p>Action: Check the calling program for a probable coding error, such as attempting to perform a Pause or Transfer using a pause element token that has already been used to Pause or Transfer by another unit of work. Correct the program and rerun it.</p>
36 (24)	IEA_UNSUPPORTED_MVS_RELEASE	<p>Meaning: Environmental error. The system release does not support this service. The system rejects the service call.</p> <p>Action: Run the program on a system that supports the service.</p>
44 (2C)	IEA_INVALID_MODE	<p>Meaning: Program error. The calling program is not in primary ASC mode, which this service requires. The system rejects the service call.</p> <p>Action: Check the calling program for a probable coding error. Correct the program and rerun it.</p>
52 (34)	IEA_ALREADY_SUSPENDED	<p>Meaning: The pause element was already paused.</p> <p>Action: Check the calling program for a probable coding error and correct the program and rerun it.</p>
60 (3C)	IEA_AUTH_TOKEN	<p>Meaning: Program error. The caller was in Problem state or key 8, but the pause element token was allocated with pause_element_auth_level=IEA_AUTHORIZED. The system rejects the service call.</p> <p>Action: Program error. The specified pause element token is not valid. The system rejects the service call.</p>

IEA4XFR2 callable service

Return Code in: Decimal (Hex)	Equate symbol	Meaning and Action
64 (40)	IEA_PE_NOT_HOME	<p>Meaning: Program error. The pause element token was for a pause element allocated with pause_element_auth_level=IEA_UNAUTHORIZED to another address space.</p> <p>Action: Check the calling program for a probable coding error. Correct the program and rerun it.</p>
68 (44)	IEA_XFER_TO_SELF	<p>Meaning: Program error. The specified current_du_pause_element_token and target_du_pause_element_token are the same.</p> <p>Action: Check the calling program for a probable coding error. Correct the program and rerun it.</p>
72 (48)	IEA_XFER_FAILED	<p>Meaning: The transfer failed, and the current_du_pause_element_token is no longer usable.</p> <p>Action: Reissue the transfer request using the updated_du_pause_element_token. Deallocate the current_du_pause_element_token.</p>
4095 (FFF)	IEA_UNEXPECTED_ERROR	<p>Meaning: This service routine encountered an unexpected error. The system rejects this service request.</p> <p>Action: Search problem reporting databases for a fix for the problem. If no fix exists, contact the IBM Support Center.</p>

Chapter 52. IEFDDSRV – DD service

Description

Use the IEFDDSRV macro to obtain or modify DD-related information to its caller. The IEFDDSRV service currently performs the following functions:

RETRIEVE DEVENTRY

Returns the unit control block (UCB) addresses of the devices allocated to the input DD request. For DDs that are allocated with the NOCAPTURE option, the addresses of the actual UCBs are returned; otherwise, the addresses of the captured UCBs are returned for above 16MB devices, and the addresses of the actual UCBs are returned for below 16MB devices.

EXTRACT TYPE=DEVIOENTRY

Returns the UCB addresses and selected I/O information of the devices allocated to the input DD request. Regardless of options specified on the allocation request, the 31-bit addresses of the actual UCBs are returned for all devices.

MODIFY TYPE=FEATURE

Sets the allocation feature according to the input specification. This function only affects future allocation requests, and does not affect existing batch and dynamic allocations that are initiated before the MODIFY FEATURE request.

MODIFY TYPE=ALLOCATION

Updates an outstanding DD allocation in all of the associated allocation and scheduler component control blocks, such as the TIOT, SIOT, and so on.

Environment

The requirements for the caller are:

Environmental factor	Requirement
Minimum authorization:	Problem or supervisor state, and any PSW key.
Dispatchable unit mode:	Task.
Cross memory mode:	<ul style="list-style-type: none"> PASN=HASN=SASN for MODIFY TYPE=ALLOCATION and MODIFY TYPE=FEATURE. Any PASN, any HASN, any SASN for all other functions.
AMODE:	24- or 31-bit.
ASC mode:	Primary or Access register (AR).
Interrupt status:	Enabled for I/O and external interrupts.
Locks:	<ul style="list-style-type: none"> For RETRIEVE DEVENTRY and EXTRACT TYPE=DEVIOENTRY, authorized callers may hold the local lock. Non-authorized callers cannot hold any locks. For MODIFY, no locks may be held.
Control parameters:	Control parameters must be in the primary address space.

Programming requirements

- For RETRIEVE DEVENTRY and EXTRACT TYPE=DEVIOENTRY:

If your program is authorized, there are certain situations when your program must provide or inherit serialization on the SYSZTIOT resource before using UCB addresses that are returned from the IEFDDSRV macro. The situations are one of the following:

- You code the DDNAME parameter.
- You code the DSABPTR parameter and your program does not have a DCB or ACB that has been open to the DD name since your program got the DSAB address.

If an authorized caller supplies the address of a DCB or ACB, this serialization is not necessary, and the returned UCB information remains valid until the DCB or ACB is closed. This serialization is also not necessary if your program codes DSABPTR and has a DCB or ACB that has been open since the program got the DSAB address.

For unauthorized callers, this service ensures that the TIOT resource is properly serialized during its execution.

For more information, see "Serialization of Resources" under "Programming considerations for using the DYNALLOC macro" in *z/OS MVS Programming: Authorized Assembler Services Guide*.

- For MODIFY ALLOCATION and MODIFY FEATURE:

An authorized caller may hold exclusive serialization on the SYSZTIOT resource. If not provided, the IEFDDSRV service obtains and holds the resource while performing the requested function, and releases it before returning to the caller. Authorized callers holding SYSZTIOT shared will be failed with return code 12, reason 12 (DDSRV_TIOTENQ_FAIL).

For unauthorized callers, the IEFDDSRV service obtains and releases the necessary SYSZTIOT serialization on behalf of the caller. For more information, see "Serialization of Resources" under "Programming considerations for using the DYNALLOC macro" in *z/OS MVS Programming: Authorized Assembler Services Guide*.

Restrictions

In cross-memory mode:

- For RETRIEVE DEVENTRY, EXTRACT TYPE=DEVIOENTRY and MODIFY TYPE=FEATURE:

When running in cross-memory mode, the DSAB/TIOT information is obtained from the user's home address space.

- For MODIFY TYPE=ALLOCATION:

Cross-memory mode is not supported.

Using the returned UCBs:

- For RETRIEVE DEVENTRY:

The user must ensure that the UCBs are not dynamically deleted.

The returned UCB addresses may be either 31-bit accessible actual UCB addresses or 24-bit accessible actual or captured UCB addresses. A captured UCB address is only valid in the address space in which it is originally allocated. The returned UCB addresses are only valid if the devices remain allocated after the execution of the DD service.

In some cases, this service may not return a device UCB, but instead may return a zero UCB address or the address of a dummy UCB. This may occur for DDs that represent DD DUMMY requests, VIO data sets, SYSOUT data sets, in-stream data sets, and some SMS-managed data sets. A dummy UCB can be identified using the UCBDUMMY field in the UCB. A dummy UCB may not have all of the UCB segments that a device UCB may have and not all services that are used for processing device UCBs may support dummy UCBs.

- For EXTRACT TYPE=DEVIOENTRY:

The user must ensure that the UCBs are not dynamically deleted.

The returned UCB addresses are always uncaptured UCB addresses and remain valid unless the UCBs are dynamically deleted.

In some cases, this service may not return a device UCB, but instead may return a zero UCB address or the address of a dummy UCB. This may occur for DDs that represent DD DUMMY requests, VIO data sets, SYSOUT data sets, in-stream data sets, and some SMS-managed data sets. A dummy UCB can be identified using the UCBDUMMY field in the UCB. A dummy UCB may not have all of the UCB segments that a device UCB may have and not all services that are used for processing device UCBs may support dummy UCBs.

- This macro supports multiple versions. Some keywords are unique to certain versions. See the PLISTVER parameter description.

Input register information

There are no input register requirements for issuing the IEFDDSRV macro.

Output register information

When control returns to the caller, the GPRs contain:

Register

Contents

0

Reason code

1

Used as a work register by the system

2-13

Unchanged

14

Used as a work register by the system

15

Return code

When control returns to the caller, the ARs contain:

Register

Contents

0-1

Used as work registers by the system

2-13

Unchanged

14-15

Used as work registers by the system

Performance implications

None.

Syntax

The standard form of the IEFDDSRV macro is written as follows:

Syntax	Description
<i>name</i>	<i>name</i> : Symbol. Begin <i>name</i> in column 1.

Syntax	Description
␣	One or more blanks must precede IEFDDSRV.
IEFDDSRV	
␣	One or more blanks must follow IEFDDSRV.
RETRIEVE	
,DEVENTRY	
,DDNAME= <i>ddname</i>	<i>ddname</i> : RS-type address or register (2) - (12) ASM only.
,DSABPTR= <i>dsabptr</i>	<i>dsabptr</i> : RS-type address or register (2) - (12) ASM only.
,DCBPTR= <i>dcbptr</i>	<i>dcbptr</i> : RS-type address or register (2) - (12) ASM only.
,ACBPTR= <i>acbptr</i>	<i>acbptr</i> : RS-type address or register (2) - (12) ASM only.
,SUBPOOL= <i>subpool</i>	<i>subpool</i> : RS-type address, or register (2)-(12) ASM only.
	Default: SUBPOOL=0
,DEVAREA= <i>devarea</i>	<i>devarea</i> : RS-type address or register (2) - (12).
,LOC=BELOW	Default: LOC=BELOW
,LOC=ANY	
EXTRACT	
,TYPE=DEVIOENTRY	Default: TYPE=DEVIOENTRY
,DDNAME= <i>ddname</i>	<i>ddname</i> : RS-type address or register (2) - (12) ASM only.
,DSABPTR= <i>dsabptr</i>	<i>dsabptr</i> : RS-type address or register (2) - (12) ASM only.
,DCBPTR= <i>dcbptr</i>	<i>dcbptr</i> : RS-type address or register (2) - (12) ASM only.
,ACBPTR= <i>acbptr</i>	<i>acbptr</i> : RS-type address or register (2) - (12) ASM only.
,SUBPOOL= <i>subpool</i>	<i>subpool</i> : RS-type address, or register (2)-(12) ASM only.
	Default: SUBPOOL=0
,DEVIOAREA= <i>devioarea</i>	<i>devioarea</i> : RS-type address, or register (2)-(12).
MODIFY	
,TYPE=ALLOCATION	Default: TYPE=ALLOCATION
,DDNAME= <i>ddname</i>	<i>ddname</i> : RS-type address or register (2) - (12) ASM only.
,DSABPTR= <i>dsabptr</i>	<i>dsabptr</i> : RS-type address or register (2) - (12) ASM only.
,NEWDDNAME= <i>newddname</i>	<i>newddname</i> : RS-type address, or register (2)-(12).
,TYPE=FEATURE	
,DSENQMGMT=NO_CHANGE	
,DSENQMGMT=MEMORY	

Syntax	Description
,TCBPTR= <i>tcbptr</i>	<i>tcbptr</i> : RS-type address, or register (2)-(12).
,RETCODE= <i>retcode</i>	
,RSNCODE= <i>rsncode</i>	
,PLISTVER=IMPLIED_VERSION	
,PLISTVER=MAX	
,PLISTVER=0	
,PLISTVER=1	
,MF=S	Default: MF=S
,MF=(L, <i>list addr</i>)	
,MF=(L, <i>list addr,attr</i>)	
,MF=(L, <i>list addr,OD</i>)	
,MF=(E, <i>list addr</i>)	
,MF=(E, <i>list addr,COMPLETE</i>)	
,MF=(E, <i>list addr,NOCHECK</i>)	

Parameters

The parameters are explained as follows:

name

An optional symbol, starting in column 1, that is the name on the IEFDDSRV macro invocation. The name must conform to the rules for an ordinary assembler language symbol.

RETRIEVE

EXTRACT

MODIFY

An optional input parameter.

RETRIEVE

Retrieve DD related information.

EXTRACT

Extract DD related information.

MODIFY

Modify an existing allocation or feature.

,DEVENTRY

A required input parameter when RETRIEVE is specified.

,DEVENTRY

Obtain the UCB address for the devices allocated to the request.

To code: Specify a value.

,DDNAME=*ddname*

,DSABPTR=*dsabptr*

,DCBPTR=*dcbptr*

,ACBPTR=*acbptr*

A required input parameter when RETRIEVE and DEVENTRY are specified.

,DDNAME=ddname

One of a set of mutually exclusive keys. It is the name of an 8 character input that is left justified and padded with blanks. A DDNAME of all blanks is invalid. The DSAB/TIOT chain selected is the one associated with the current TCB, unless overridden by the TCBPTR parameter.

To code: Specify the RS-type address of an 8-character field.

,DSABPTR=dsabptr

One of a set of mutually exclusive keys. It is the name of a pointer input that contains the address of the DSAB associated with a DD name.

To code: Specify the RS-type address of a pointer field.

,DCBPTR=dcbptr

One of a set of mutually exclusive keys. It is the name of a pointer input that contains the address of the DCB associated with a DD name. When DCBPTR defines an open DCB, specifying TCBPTR has no effect and the current TCB is used. When DCBPTR defines a closed DCB, the DSAB chain selected is determined by the desired TCB, which is either the current TCB (if TCBPTR is zero) or the TCB pointed to by TCBPTR. Do not use the DCBPTR option for a DCB in a DCB OPEN or ABEND exit routine call for that DCB.

To code: Specify the RS-type address of a pointer field.

,ACBPTR=acbptr

One of a set of mutually exclusive keys. It is the name of a pointer input that contains the address of the ACB associated with a DD name. If this ACB is OPEN, the DSAB pointer is retrieved from the DEB extension associated with it. If this ACB is not OPEN, the DD name is taken from the DCBDDNAM field in the DCB, and the DSAB address corresponding to this DD name is retrieved. When ACBPTR defines a DCB associated with an OPEN DD, ACBPTR is mutually exclusive with TCBPTR. The specified TCBPTR is ignored and the current TCB is used. When ACBPTR defines a ACB associated with a CLOSED DD, the DSAB chain selected is determined by the desired TCB, which is either the current TCB (if TCBPTR is zero) or the TCB pointed to by TCBPTR.

To code: Specify the RS-type address of a pointer field.

,SUBPOOL=subpool**,SUBPOOL=0**

When RETRIEVE and DEVENTRY are specified, an optional input parameter that indicates which subpool to obtain the device area storage in. If this parameter is not specified, subpool 0 is used. The default value is 0.

To code: Specify the RS-type address, or address in register (2)-(12), of a one-byte field.

,DEVAREA=devarea

The name of a required pointer output that contains the address of the device output area. This area is obtained in the user's key and the subpool specified by the user (or subpool 0, if not specified). If the DD name is specified or obtained from a closed DCB, all the devices allocated to the requested DD and its concatenated groups are returned. If the DSAB pointer is specified or obtained from an opened DCB, only devices allocated to the requested DSAB are returned. The device area format is as follows:

- An 8 byte header containing
 - A 1-byte field indicating the subpool in which the storage resides.
 - A 3-byte field containing the size of the device area (including the header).
 - A 4-byte field containing the number of device entry lists returned (a device entry list is returned for each DD in the concatenated group).
 - An array of the device list addresses.
- An array of the device entry lists. Each list has the following format:
 - A 4-byte field containing the number of device entries in the list.
 - An array of 4-byte entries containing the UCB addresses.

The device area is mapped by mapping macro IEFDISMP.

If IEFDDSRV returns with return code 0 and reason code 0, the system has obtained a storage area of the appropriate size in the requested key and subpool, and placed its address in devarea. You are responsible for releasing this storage. If the return code and reason codes are not 0, the system has not obtained the storage area; do not attempt to release the storage.

To code: Specify the RS-type address, or address in register (2)-(12), of a pointer field.

,LOC=BELOW

,LOC=ANY

When RETRIEVE and DEVENTRY are specified, an optional parameter that indicates whether the DD Service should search all the DSABs or only those residing below the 16-megabyte line. This parameter is ignored for requests other than RETRIEVE DEVENTRY. The default is LOC=BELOW.

,LOC=BELOW

Requests that the DD Service search only those DSABs residing below the 16-megabyte line.

,LOC=ANY

Requests that the DD Service search all the DSABs.

,TYPE=DEVIOENTRY

An optional parameter when EXTRACT is specified. The default is TYPE=DEVIOENTRY.

,TYPE=DEVIOENTRY

Obtain the UCB address and selected I/O information for the devices allocated to the request.

Note: EXTRACT,TYPE=DEVIOENTRY is used to return I/O information, as opposed to RETRIEVE,DEVENTRY, which is used to retrieve information about devices allocated to a request. Although the two functions both return UCB information, due to the nature of the information they are meant to return, the two functions may return different device information. For example, a DD that was dynamically allocated with DD-level accounting suppressed via the S99DASUP flag in macro IEFZB4D0 will not have any device information returned with EXTRACT,TYPE=DEVIOENTRY, but will have device information returned with RETRIEVE,DEVENTRY.

,DDNAME=ddname

,DSABPTR=dsabptr

,DCBPTR=dcbptr

,ACBPTR=acbptr

A required input parameter when EXTRACT and TYPE=DEVIOENTRY are specified.

,DDNAME=ddname

One of a set of mutually exclusive keys. It is the name of an 8 character input that is left justified and padded with blanks. A DDNAME of all blanks is invalid. The DSAB/TIOT chain selected is the one associated with the current TCB, unless overridden by the TCBPTR parameter.

To code: Specify the RS-type address of an 8-character field.

,DSABPTR=dsabptr

One of a set of mutually exclusive keys. It is the name of a pointer input that contains the address of the DSAB associated with a DD name.

To code: Specify the RS-type address of a pointer field.

,DCBPTR=dcbptr

One of a set of mutually exclusive keys. It is the name of a pointer input that contains the address of the DCB associated with a DD name. If this DCB is OPEN, the DSAB pointer is retrieved from the DEB extension associated with it. If this DCB is not OPEN, the DD name is taken from the DCBDDNAM field in the DCB, and the DSAB address corresponding to this DD name is retrieved. When DCBPTR defines a DCB associated with an OPEN DD, DCBPTR is mutually exclusive with TCBPTR. The specified TCBPTR is ignored and the current TCB is used. When DCBPTR defines a DCB associated with a CLOSED DD, the DSAB chain selected is determined by the desired TCB, which is either the current TCB (if TCBPTR is zero) or the TCB pointed to by TCBPTR.

To code: Specify the RS-type address of a pointer field.

,ACBPTR=acbptr

One of a set of mutually exclusive keys. It is the name of a pointer input that contains the address of the ACB associated with a DD name. If this ACB is OPEN, the DSAB pointer is retrieved from the DEB extension associated with it. If this ACB is not OPEN, the DD name is taken from the DCBDDNAM field in the DCB, and the DSAB address corresponding to this DD name is retrieved. When ACBPTR defines a DCB associated with an OPEN DD, ACBPTR is mutually exclusive with TCBPTR. The specified TCBPTR is ignored and the current TCB is used. When ACBPTR defines a ACB associated with a CLOSED DD, the DSAB chain selected is determined by the desired TCB, which is either the current TCB (if TCBPTR is zero) or the TCB pointed to by TCBPTR.

To code: Specify the RS-type address of a pointer field.

,SUBPOOL=subpool**,SUBPOOL=0**

When EXTRACT and TYPE=DEVIOENTRY are specified, an optional input parameter that indicates which subpool to obtain the device I/O area storage in. If this parameter is not specified, subpool 0 is used. The default is 0.

To code: Specify the RS-type address, or address in register (2)-(12), of a one-byte field.

,DEVIOAREA=devioarea

When EXTRACT and TYPE=DEVIOENTRY are specified, a required output parameter that is to contain the address of the device output area. This area is obtained in the user's key and the subpool specified by the user (or subpool 0, if not specified). If the DD name is specified or obtained from a closed DCB, all the devices allocated to the requested DD and its concatenated groups are returned. If the DSAB pointer is specified or obtained from an opened DCB, only devices allocated to the requested DSAB are returned. The device area format is as follows:

- An 8 byte header containing
 - A 1-byte field indicating the subpool in which the storage resides.
 - A 3-byte field containing the size of the device area (including the header).
 - A 4-byte field containing the number of device entry lists returned (a device entry list is returned for each DD in the concatenated group).
 - An array of the device I/O list addresses.
- An array of the device I/O entry lists. Each list has the following format:
 - A 4-byte field containing the number of device I/O entries in the list.
 - An array of 20-byte entries containing the UCB addresses (4 bytes), the TCTTIOT block size (8 bytes), the number of EXCPs against this device (4 bytes), and the device connect time (4 bytes).

The device I/O area is mapped by macro IEFDISMP.

Note: The invoker is responsible for releasing the storage for the returned device I/O area.

To code: Specify the RS-type address, or address in register (2)-(12), of a pointer field.

,TYPE=ALLOCATION**,TYPE=FEATURE**

When MODIFY is specified, an optional parameter to modify an existing allocation or feature. The default is TYPE=ALLOCATION.

,TYPE=ALLOCATION

Update a DD allocation using the information provided.

,TYPE=FEATURE

Update the allocation settings of the job as requested.

,DDNAME=ddname**,DSABPTR=dsabptr**

A required input parameter when MODIFY and TYPE=ALLOCATION are specified.

,DDNAME=ddname

One of a set of mutually exclusive keys. It is the name of an 8 character input that is left justified and padded with blanks. A DDNAME of all blanks is invalid. The DSAB/TIOT chain selected is the one associated with the current TCB, unless overridden by the TCBPTR parameter.

Note: Multiple DDs with the same name are allowed, and all references to that DDNAME use the first DD found.

To code: Specify the RS-type address of an 8-character field.

,DSABPTR=dsabptr

One of a set of mutually exclusive keys. It is the name of a pointer input that contains the address of the DSAB associated with a DD name.

To code: Specify the RS-type address of a pointer field.

,NEWDDNAME=newddname

When MODIFY and TYPE=ALLOCATION are specified, a required input parameter, which is left justified and padded with blanks.

The following DD names are not allowed:

- JOBLIB
- STEPLIB (unless the program invoking IEFDDSRV is authorized)
- A DD name of all blanks
- Any DD name that is already in use
- Any DD name that does not conform to the rules documented in the JCL reference.

In addition, the DD to be modified cannot be concatenated to a named DD and cannot be modified while the DD is OPEN.

To code: Specify the RS-type address, or address in register (2)-(12), of an 8-character field.

,DSENQMGMT=NO_CHANGE**,DSENQMGMT=MEMORY**

When MODIFY and TYPE=FEATURE are specified, a required parameter that indicates how Allocation should manage ENQs on the data set name.

,DSENQMGMT=NO_CHANGE

Requests that no change be made to the data set ENQs management.

,DSENQMGMT=MEMORY

Requests that data set ENQs be managed in memory. Specifying this option causes the job to be non-restartable through the check-point/restart function from this point on. The SYSTEM MEMDSENQMGMT keyword in ALLOCxx must be set to ENABLE to allow the job or subsystem to use the memory-based data set ENQ management. Memory-based data set ENQ management is not available for ASID 1.

,TCBPTR=tcbptr

An optional input parameter that contains the address of the TCB associated with the task for which DSAB/TIOT information is requested or modified. When DCBPTR or ACBPTR defines a DCB or ACB associated with an OPEN DD, DCBPTR is mutually exclusive with TCBPTR. The specified TCBPTR is ignored, and the current TCB is used.

When specified for a MODIFY TYPE=ALLOCATION request by an unauthorized caller, only the following subset of tasks within the address space are accepted:

- The cross-memory resource owner (CMRO) TCB
- Tasks that are subtasks of the CMRO TCB
- Tasks that use the same DSAB/TIOT structure as the CMRO TCB

Any task that does not meet these requirements is considered not valid, resulting in return code X'0C' with reason code X'14'.

When specified for a MODIFY TYPE=FEATURE request, only the current TCB is accepted. Any other task is considered not valid, resulting in return code X'0C' with reason code X'14'.

To code: Specify the RS-type address, or address in register (2)-(12), of a pointer field.

,RETCODE=retcode

An optional output parameter into which the return code is to be copied from GPR 15. If you specify 15, GPR15, REG15, or R15 (within or without parentheses), the value is left in GPR 15.

To code: Specify the RS-type address of a fullword field, or register (2)-(12) or (15), (GPR15), (REG15), or (R15).

,RSNCODE=rsncode

An optional output parameter into which the reason code is to be copied from GPR 0. If you specify 0, 00, GPR0, GPR00, REG0, REG00, or R0 (within or without parentheses), the value is left in GPR 0.

To code: Specify the RS-type address of a fullword field, or register (0) or (2)-(12), (00), (GPR0), (GPR00), (REG0), (REG00), or (R0).

,PLISTVER=IMPLIED_VERSION

,PLISTVER=MAX

,PLISTVER=0

,PLISTVER=1

An optional input parameter that specifies the version of the macro. PLISTVER determines which parameter list the system generates. PLISTVER is an optional input parameter on all forms of the macro, including the list form. When using PLISTVER, specify it on all macro forms used for a request and with the same value on all of the macro forms. The values are:

- **IMPLIED_VERSION**, which is the lowest version that allows all parameters specified on the request to be processed. If you omit the PLISTVER parameter, IMPLIED_VERSION is the default.
- **MAX**, if you want the parameter list to be the largest size currently possible. This size might grow from release to release and affect the amount of storage that your program needs.

If you can tolerate the size change, IBM recommends that you always specify PLISTVER=MAX on the list form of the macro. Specifying MAX ensures that the list-form parameter list is always long enough to hold all the parameters you might specify on the execute form, when both are assembled with the same level of the system. In this way, MAX ensures that the parameter list does not overwrite nearby storage.

- **0**, which supports all parameters except those specifically referenced in higher versions.
- **1**, which supports both the following parameters and those from version 0:
 - ALLOCATION
 - DEVIOAREA
 - DSENQMGMT
 - EXTRACT
 - FEATURE
 - MODIFY
 - NEWDDNAME
 - TYPE

To code: Specify one of the following:

- IMPLIED_VERSION
- MAX
- A decimal value of 0, or 1

,MF=S
,MF=(L,list addr)
,MF=(L,list addr,attr)
,MF=(L,list addr,OD)
,MF=(E,list addr)
,MF=(E,list addr,COMPLETE)
,MF=(E,list addr,NOCHECK)

An optional input parameter that specifies the macro form.

Use MF=S to specify the standard form of the macro, which builds an inline parameter list and generates the macro invocation to transfer control to the service. MF=S is the default.

Use MF=L to specify the list form of the macro. Use the list form together with the execute form of the macro for applications that require reentrant code. The list form defines an area of storage that the execute form uses to store the parameters. Only the PLISTVER parameter may be coded with the list form of the macro.

Use MF=E to specify the execute form of the macro. Use the execute form together with the list form of the macro for applications that require reentrant code. The execute form of the macro stores the parameters into the storage area defined by the list form, and generates the macro invocation to transfer control to the service.

,list addr

The name of a storage area to contain the parameters. For MF=S and MF=E, the name can be an RS-type address or an address in register (1)-(12).

,attr

An optional 1- to 60-character input string that you use to force boundary alignment of the parameter list. Use a value of OF to force the parameter list to a word boundary, or OD to force the parameter list to a doubleword boundary. If you do not code *attr*, the system provides a value of OD.

,COMPLETE

Specifies that the system is to check for required parameters and supply defaults for omitted optional parameters.

,NOCHECK

Specifies that the system is not to check for required parameters and is not to supply defaults for omitted optional parameters.

ABEND codes

None.

Return and reason codes

When the IEFDDSRV macro returns control to your program, GPR 15 (and *retcode* if you code RETCODE) contains the return code. If the value in GPR 15 is not 0, GPR0 (and *rsncode* if you code RSNCODE) contains the reason code.

The return and reason codes are mapped in macro IEFDISRC. The hexadecimal return and reason codes from the IEFDDSRV macro are as follows:

Return code	Reason code	Meaning and action
X'00'	X'00'	Meaning: The requested function successfully completed.
X'04'	–	Meaning: The requested function completed with warnings.
X'04'	X'04'	Meaning: AREALEN is insufficient to contain the output. The necessary length is in the DVAR_LENGTH field of the output area.

<i>Table 25. Return and reason codes for the IEFDDSRV macro (continued)</i>		
Return code	Reason code	Meaning and action
X'08'	–	Meaning: Input parameter is not valid.
X'08'	X'04'	Meaning: The specified or obtained DD name is blank.
X'08'	X'08'	Meaning: The specified or obtained DSAB pointer is zero.
X'08'	X'0C'	Meaning: The specified DCB pointer is zero.
X'08'	X'10'	Meaning: An invalid subpool was specified.
X'08'	X'14'	Meaning: The specified ACB pointer is zero.
X'08'	X'18'	Meaning: The specified DSAB pointer is a 31-bit address, but LOC=ANY was not specified.
X'08'	X'20'	Meaning: The parameter list version and the parameter list length are not consistent.
X'08'	X'24'	Meaning: The parameter list version does not support the IEFDDSRV function requested.
X'08'	X'28'	Meaning: The parameter list version is higher than what is supported by IEFDDSRV.
X'08'	X'2C'	Meaning: The function in the parameter list is not supported by IEFDDSRV.
X'08'	X'34'	Meaning: Invalid environment for the specified function.
X'0C'	–	Meaning: The input parameter is not valid.
X'0C'	X'04'	Meaning: The specified or obtained DD name is not valid.
X'0C'	X'08'	Meaning: The specified or obtained DSAB pointer is not valid.
X'0C'	X'0C'	Meaning: Failed to obtain the TIOT resource.
X'0C'	X'10'	Meaning: Failed to obtain the lock.
X'0C'	X'14'	<p>Meaning: The specified TCB pointer is not valid for this request. This may indicate one of the following errors:</p> <ul style="list-style-type: none"> • The specified pointer does not point to a valid TCB. • The specified pointer does point to a valid TCB, but that TCB is not a valid target for the request. <p>For more information, see the description of the TCBPTR parameter.</p>
X'0C'	X'1C'	Meaning: The DSAB pointer obtained from the OPEN input DCB/ACB is a 31-bit address, but LOC=ANY was not specified.
X'0C'	X'20'	Meaning: The TCTTIOT offset obtained from the DSAB is zero.
X'0C'	X'100'	Meaning: The DD name cannot be modified while the DD is open.
X'0C'	X'104'	Meaning: The requested feature has not been enabled by the installation.
X'0C'	X'108'	Meaning: The requested new DD name does not follow the documented rules for a DDNAME.

Table 25. Return and reason codes for the IEFDDSRV macro (continued)

Return code	Reason code	Meaning and action
X'0C'	X'10C'	Meaning: The DD to be modified is concatenated to a named DD.
X'0C'	X'128'	Meaning: The DD to be modified is in an inconsistent state and cannot be modified.
X'0C'	X'12C'	Meaning: The requested feature is already set.
X'0C'	X'130'	Meaning: The requested new DD name is already in use.
X'0C'	X'134'	Meaning: The requested function is not allowed from ASID 1.
X'0C'	X'138'	Meaning: The DD to be modified is an insulated DD. You may not modify an insulated DD.
X'10'	–	Meaning: System error: Recovery entered. Action: Check the dump produced by the abend and supply it to the appropriate IBM support personnel.

Chapter 53. IEFOPZQ – Query the IEFOPZ configuration

Description

The IEFOPZQ macro provides the interface to obtain various pieces of information about the IEFOPZ configuration (via IEFOPZxx parmlib members) that is currently in effect.

Environment

The requirements for the caller are:

Environmental Factor	Requirement
Minimum authorization:	Problem state. PSW key 8-15
Dispatchable unit mode:	Task
Cross memory mode:	PASN=HASN=SASN
AMODE:	31- or 64-bit If in AMODE 64, specify SYSSTATE AMODE64=YES before invoking this macro.
ASC mode:	Primary or access register (AR) If in Access Register ASC mode, specify SYSSTATE ASCENV=AR before invoking this macro. Do not use ALET value 1 ("secondary") for addressing parameters.
Interrupt status:	Enabled for I/O and external interrupts
Locks:	No locks may be held.
Control parameters:	Control parameters must be in the primary address space or, for AR-mode callers, must be in an address/data space that is addressable through a public entry on the caller's dispatchable unit access list (DU-AL). Control parameters above 2GB are allowed for AMODE 64 callers only.

Programming requirements

Include the IEFOPZAA macro to get a mapping for the answer area and to get equate symbols for related constants as well as return and reason codes.

Restrictions

The caller must not have a functional recovery routine (FRR) established.

Input register information

Before issuing the IEFOPZQ macro, the caller does not have to place any information into any register unless using it in register notation for a particular parameter, or using it as a base register.

Before issuing the IEFOPZQ macro, the caller does not have to place any information into any access register (AR) unless using it in register notation for a particular parameter, or using it as a base register.

Output register information

When control returns to the caller, the GPRs contain:

Register	Contents
----------	----------

0	Reason code, when register 15 is not 0.
----------	---

0-1	Used as work registers by the system.
------------	---------------------------------------

2-13	Unchanged.
-------------	------------

14	Used as work registers by the system.
-----------	---------------------------------------

15	Return code.
-----------	--------------

When control returns to the caller, the ARs contain:

Register	Contents
----------	----------

0-1	Used as work registers by the system.
------------	---------------------------------------

2-13	Unchanged.
-------------	------------

14-15	Used as work registers by the system.
--------------	---------------------------------------

Some callers depend on register contents remaining the same before and after issuing a service. If the system changes the contents of registers on which the caller depends, the caller must save them before issuing the service, and restore them after the system returns control.

Performance implications

None.

Syntax

main diagram

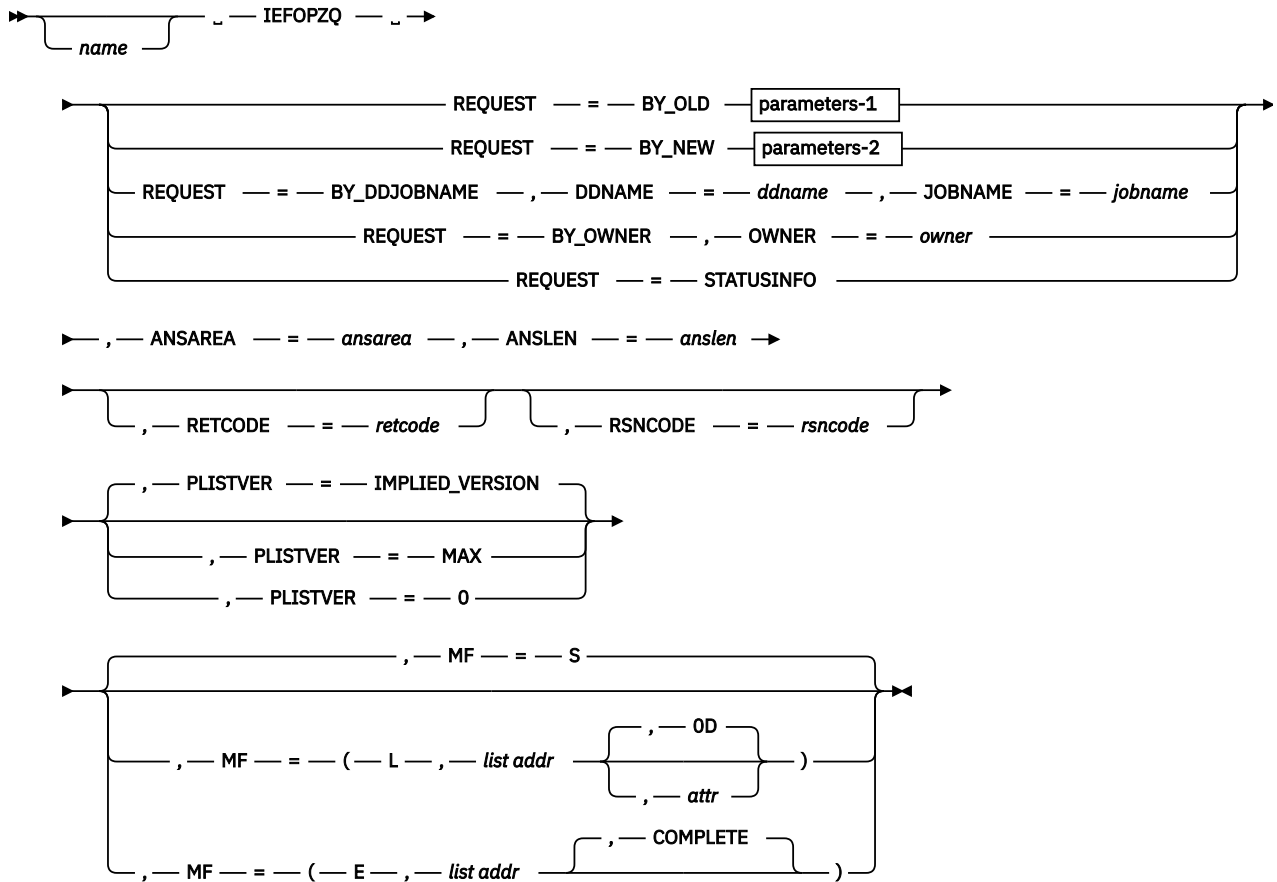

parameters-1

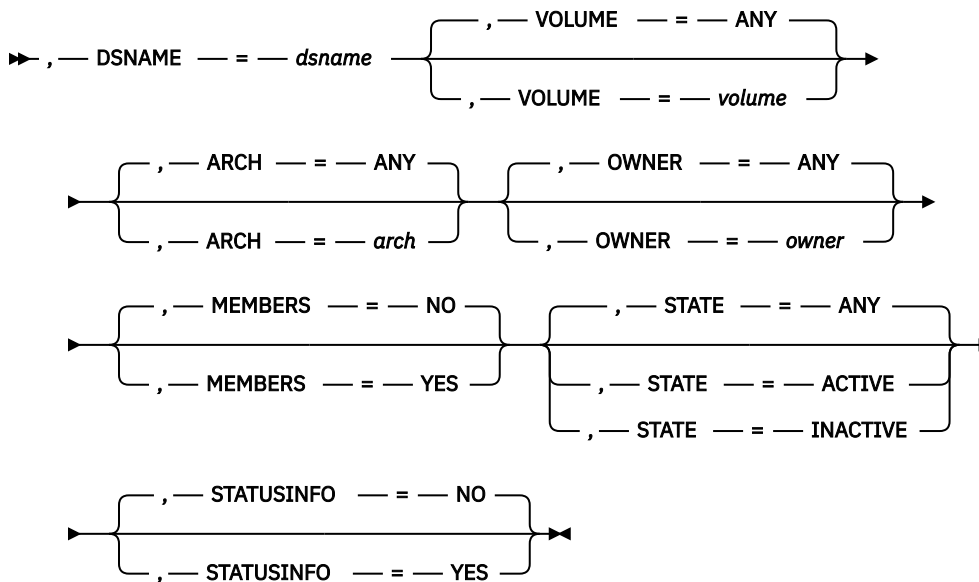

parameters-2

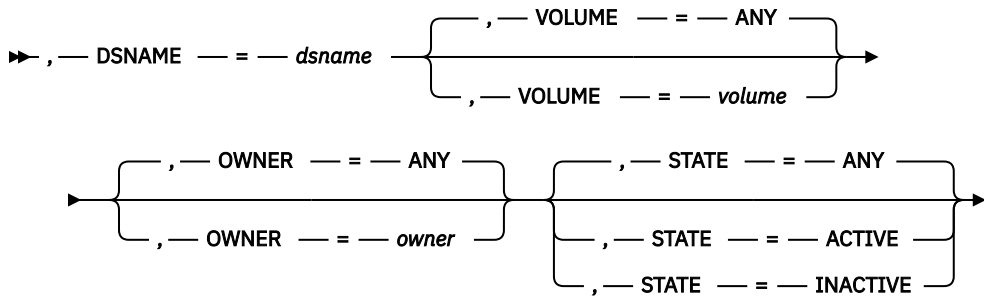

Parameters

The parameters are explained as follows:

name

An optional symbol, starting in column 1, that is the name on the IEFOPZQ macro invocation. The name must conform to the rules for an ordinary assembler language symbol.

,ANSAREA=ansarea

A required output parameter, which is to contain the returned information. The length of ANSAREA is given via ANSLLEN. The answer area is mapped by macro IEFOPZAA. It should start on a doubleword boundary.

To code: Specify the RS-type address, or address in register (2) - (12), of a character field.

,ANSLLEN=anslen

A required input parameter, which contains the length of the provided answer area in bytes. The length must be at least of value IEFOPZQ_Min_Anslen. If you get return code IEFOPZQRC_Warn with reason code IEFOPZQRsn_NotAllDataReturned, allocate a larger area based upon the value returned in field OpzaaHTLen and request the function again.

To code: Specify the RS-type address, or address in register (2) - (12), of a fullword field, or specify a literal decimal value.

,ARCH=arch**,ARCH=ANY**

When REQUEST=BY_OLD is specified, an optional input parameter, which contains the ARCH level. A value of 0 is treated as ANY. A value of X'FFFF' is treated as "same as MAXARCH". When ARCH=ANY is not in effect, the system locates the particular NEW data set that would be used if MAXARCH were set to the specified ARCH value, if such a data set is in the configuration. The default is ANY.

To code: Specify the RS-type address, or address in register (2) - (12), of a halfword field, or specify a literal decimal value.

,DDNAME=ddname

When REQUEST=BY_DDJOBNAME is specified, a required input parameter, which identifies the DDNAME for which data is to be returned. You may use wildcard characters within the DDNAME. A value of zeros indicates that all DDNAMEs are to match. The IEFOPZQ service translates the DDNAME to uppercase before use.

To code: Specify the RS-type address, or address in register (2) - (12), of an 8-character field.

,DSNAME=dsname

When REQUEST=BY_OLD or REQUEST=BY_NEW is specified, a required input parameter, which contains the data set name. You may use wildcard characters within the data set name. The IEFOPZQ service translates the data set name to uppercase before use.

To code: Specify the RS-type address, or address in register (2) - (12), of a 44-character field.

,JOBNAME=jobname

When REQUEST=BY_DDJOBNAME is specified, a required input parameter, which identifies the jobname for which data is to be returned. You may use wildcard characters within the jobname. A value of zeros indicates that all JOBNAMEs are to match. The IEFOPZQ service translates the jobname to uppercase before use.

To code: Specify the RS-type address, or address in register (2) - (12), of an 8-character field.

,MEMBERS=NO**,MEMBERS=YES**

When REQUEST=BY_OLD is specified, an optional parameter that indicates whether to return member information or not. The default is MEMBERS=NO.

,MEMBERS=NO

Indicates not to return member information.

,MEMBERS=YES

Indicates to return member information.

,MF=S**,MF=(L,list addr)****,MF=(L,list addr,attr)****,MF=(L,list addr,OD)****,MF=(E,list addr)****,MF=(E,list addr,COMPLETE)**

An optional input parameter that specifies the macro form.

Use MF=S to specify the standard form of the macro, which builds an inline parameter list and generates the macro invocation to transfer control to the service. MF=S is the default.

Use MF=L to specify the list form of the macro. Use the list form together with the execute form of the macro for applications that require reentrant code. The list form defines an area of storage that the execute form uses to store the parameters. Only the PLISTVER parameter may be coded with the list form of the macro.

Use MF=E to specify the execute form of the macro. Use the execute form together with the list form of the macro for applications that require reentrant code. The execute form of the macro stores the parameters into the storage area defined by the list form, and generates the macro invocation to transfer control to the service.

,list addr

The name of a storage area to contain the parameters. For MF=S and MF=E, this can be an RS-type address or an address in register (1) - (12).

,attr

An optional 1- to 60-character input string that you use to force boundary alignment of the parameter list. Use a value of 0F to force the parameter list to a word boundary, or 0D to force the parameter list to a doubleword boundary. If you do not code *attr*, the system provides a value of 0D.

,COMPLETE

Specifies that the system is to check for required parameters and supply defaults for omitted optional parameters.

,OWNER=owner**,OWNER=ANY**

When REQUEST=BY_OLD or REQUEST=BY_NEW is specified, an optional input parameter, which identifies the owner for which information is to be retrieved. This correlates to the OWNER parameter of the IEFOPZxx parmlib member. You may use wildcard characters within the owner name. The IEFOPZQ service translates the owner to uppercase before use. The default is ANY.

When REQUEST=BY_OWNER is specified, a required input parameter, which identifies the OWNER for which data is to be returned. You may use wildcard characters within the OWNER. A value of zeros indicates that all OWNERS are to match. The IEFOPZQ service translates the owner to uppercase before use.

To code: Specify the RS-type address, or address in register (2) - (12), of a 16-character field.

,PLISTVER=IMPLIED_VERSION

,PLISTVER=MAX

,PLISTVER=0

An optional input parameter that specifies the version of the macro. PLISTVER determines which parameter list the system generates. PLISTVER is an optional input parameter on all forms of the macro, including the list form. When using PLISTVER, specify it on all macro forms used for a request and with the same value on all of the macro forms. The values are:

- **IMPLIED_VERSION**, which is the lowest version that allows all parameters specified on the request to be processed. If you omit the PLISTVER parameter, IMPLIED_VERSION is the default.
- **MAX**, if you want the parameter list to be the largest size currently possible. This size might grow from release to release and affect the amount of storage that your program needs.

If you can tolerate the size change, IBM recommends that you always specify PLISTVER=MAX on the list form of the macro. Specifying MAX ensures that the list-form parameter list is always long enough to hold all the parameters you might specify on the execute form, when both are assembled with the same level of the system. In this way, MAX ensures that the parameter list does not overwrite nearby storage.

- **0**, if you use the currently available parameters.

To code: Specify one of the following:

- IMPLIED_VERSION
- MAX
- A decimal value of 0

REQUEST=BY_OLD

REQUEST=BY_NEW

REQUEST=BY_DDJOBNAME

REQUEST=BY_OWNER

REQUEST=STATUSINFO

A required parameter, which identifies the type of request.

REQUEST=BY_OLD

Returns entries matching the OLD data set. Upon return, the answer area contains:

- An OPZAAH area.
- Zero or more OPZAAOLD areas. The offset of the first is in the OPZAAH area. The offset of the "next" is in the OPZAAOLD area. Matching items are returned in the order of the OLDNEWs' specification (from first in the first parmlib member to last in the last parmlib member).
- For each OPZAAOLD, zero or more OPZAAOLD areas. The offset of the first is in the OPZAAOLD area. The offset of the "next" is in the OPZAAOLD area. Matching NEW entries are returned in the order of their specification within the OLDNEW.
- Optionally, for each OPZAAOLD, zero or more OPZAAOLD areas for included members and zero or more OPZAAOLD areas for excluded members. The offset of the first is in the OPZAAOLD area. The offset of the "next" is in the OPZAAOLD area. Matching include member list items are returned in the order of their specification within the OLDNEW. Matching exclude member list items are returned in the order of their specification within the OLDNEW.
- Optionally, an OPZAAH area. The offset is in the OPZAAH area.

REQUEST=BY_NEW

Returns entries matching the NEW data set. Upon return, the answer area contains:

- An OPZAAH area.
- Zero or more OPZAAOLD areas. The offset of the first is in the OPZAAH area. The offset of the "next" is in the OPZAAOLD area. Matching items are returned in the order of the OLDNEWs' specification (from first in the first parmlib member to last in the last parmlib member) and the NEW specifications within the OLDNEW.

- For each OPZAANEW, zero or more OPZAAOLD areas. The offset of the first is in the OPZAANEW area. The offset of the "next" is in the OPZAAOLD area. Matching items are returned in the order of the OLDNEWS' specification.

REQUEST=BY_DDJOBNAME

Returns entries matching the DDNAME and/or JOBNAME. Upon return, the answer area contains:

- An OPZAAH area.
- Zero or more OPZAADDJ areas. The offset of the first is in the OPZAAH area. The offset of the "next" is in the OPZAADDJ area. Matching items are returned in the order of the DDNAME/JOBNAME pairs' specification.

If the input DDNAME has wildcard character(s) or the input JOBNAME has wildcard character(s) then the input DDNAME/JOBNAME pair is treated as the pattern for purposes of wildcard matching. Otherwise the IEFOPZ configuration DDNAME/JOBNAME is treated as the pattern. For example,

- When the input DDNAME is DD* (has wildcard characters), it does not matter what the input JOBNAME is. The input DDNAME/JOBNAME is treated as the pattern and the IEFOPZ configuration DDNAME/JOBNAME is treated as the string.
- When the input DDNAME is DD (has no wildcard characters) and the input JOBNAME is zeros (or JOBNAME is not specified), the input DDNAME/JOBNAME is treated as the string and the IEFOPZ configuration DDNAME/JOBNAME is treated as the pattern.
- When the input DDNAME is DD (has no wildcard characters) and the input JOBNAME is J (has no wildcard characters), the input DDNAME/JOBNAME is treated as the string and the IEFOPZ configuration DDNAME/JOBNAME is treated as the pattern.
- When the input DDNAME is DD (has no wildcard characters) and the input JOBNAME is J* (has wildcard characters), the input DDNAME/JOBNAME is treated as the pattern and the IEFOPZ configuration DDNAME/JOBNAME is treated as the string.

REQUEST=BY_OWNER

Returns information provided by the OWNER statement, such as the MINARCH value, for matching owners. Note that this does not provide information about OLDNEW definitions associated with particular owner(s). That information can be gotten via REQUEST=BY_OLD with an appropriate OWNER= specification. Upon return, the answer area contains:

- An OPZAAH area.
- Zero or more OPZAAOWN areas. The offset of the first is in the OPZAAH area. The offset of the "next" is in the OPZAAOWN area. Matching items are returned in the order of the OWNER statements' specification, with the proviso that all matching OWNER values without wildcard characters are presented before any matching OWNER values that have wildcard character(s).

If the input OWNER has wildcard character(s) then it is treated as the pattern for purposes of wildcard matching. Otherwise the IEFOPZ configuration OWNER is treated as the pattern.

REQUEST=STATUSINFO

Returns only status information. Upon return, the answer area contains:

- An OPZAAH area.
- An OPZAAS area. The offset is in the OPZAAH area.

,RETcode=retcode

An optional output parameter into which the return code is to be copied from GPR 15. If you specify 15, GPR15, REG15, or R15 (within or without parentheses), the value will be left in GPR 15.

To code: Specify the RS-type address of a fullword field, or register (2) - (12) or (15), (GPR15), (REG15), or (R15).

,RSNcode=rsncode

An optional output parameter into which the reason code is to be copied from GPR 0. If you specify 0, 00, GPR0, GPR00, REG0, REG00, or R0 (within or without parentheses), the value will be left in GPR 0.

To code: Specify the RS-type address of a fullword field, or register (0) or (2) - (12), (00), (GPR0), (GPR00), REG0), (REG00), or (R0).

,STATE=ANY

,STATE=ACTIVE

,STATE=INACTIVE

When REQUEST=BY_OLD or REQUEST=BY_NEW is specified, an optional parameter that indicates the states for which data should be returned. The default is STATE=ANY.

,STATE=ANY

Indicates to return information when the state is active or inactive.

,STATE=ACTIVE

Indicates to return information only when the state is active.

,STATE=INACTIVE

Indicates to return information only when the state is inactive.

,STATUSINFO=NO

,STATUSINFO=YES

When REQUEST=BY_OLD is specified, an optional parameter that relates to status information. The default is STATUSINFO=NO.

,STATUSINFO=NO

Indicates not to return status information.

,STATUSINFO=YES

Indicates to return status information, mapped by DSECT OPZAAS.

,VOLUME=volume

,VOLUME=ANY

When REQUEST=BY_OLD or REQUEST=BY_NEW is specified, an optional input parameter, which contains the volume (volser). You may use wildcard characters within the volume ID. The default, ANY, indicates that matching does not depend on whether the IEFOPZ specification provided a volume or not. If a volume is provided, it can match either of the following cases:

- The IEFOPZ specification provided a volume.
- When IEFOPZ processing last allocated the data set, it found the volume.

The IEFOPZQ service translates the volume to uppercase before use. The default is ANY.

To code: Specify the RS-type address, or address in register (2) - (12), of a 6-character field.

ABEND codes

None.

Return and reason codes

When the IEFOPZQ macro returns control to your program:

- GPR 15 (and *retcode*, when you code RETCODE) contains a return code.
- When the value in GPR 15 is not zero, GPR 0 (and *rsncode*, when you code RSNCODE) contains a reason code.

Macro IEFOPZAA provides equate symbols for the return and reason codes. It also provides equate IEFOPZQRsnCodeMask. That equate can be used to create a word that should be ANDed with the reason code to isolate the non component-diagnostic portion of of the reason code prior to doing a comparison.

The following table identifies the hexadecimal return and reason codes and the equate symbol associated with each reason code. IBM support personnel may request the entire reason code, including the xxxx value.

<i>Table 26. Return and reason codes for the IEFOPZQ macro</i>		
Return code	Reason code	Equate symbol, meaning and action
0	–	Equate symbol: IEFOPZQRc_OK Meaning: Successfully returned requested information. Action: None required.
4	–	Equate symbol: IEFOPZQRc_Warn Meaning: Warning. Action: Refer to the action under the individual reason code.
4	xxxx0401	Equate symbol: IEFOPZQRsn_NotAllDataReturned Meaning: Not all data was returned because the answer area is not big enough. Answer area field OpzaaHTLen. how much space is currently required. Action: Allocate a larger area and request the function again. Within the returned data from this call, use only the OpzaaHTLen field.
8	–	Equate symbol: IEFOPZQRc_InvParm Meaning: The IEFOPZQ invocation specified parameters that are not valid. Action: Refer to the action under the individual reason code.
8	xxxx0801	Equate symbol: IEFOPZQRsn_BadParmlist Meaning: Error accessing the parameter list. Action: Check for possible storage overlay.
8	xxxx0802	Equate symbol: IEFOPZQRsn_SrbMode Meaning: SRB mode. Action: Avoiding issuing IEFOPZQ in SRB mode.
8	xxxx0803	Equate symbol: IEFOPZQRsn_NotEnabled Meaning: Not Enabled. Action: Avoiding issuing IEFOPZQ while not enabled.
8	xxxx0804	Equate symbol: IEFOPZQRsn_XM Meaning: Cross memory mode. Action: Avoid issuing IEFOPZQ when the home, primary, and secondary address spaces are not all the same.
8	xxxx0805	Equate symbol: IEFOPZQRsn_Locked Meaning: Locked. Action: Avoid issuing IEFOPZQ while holding a system lock.
8	xxxx0806	Equate symbol: IEFOPZQRsn_FRR Meaning: FRR. Action: Avoid issuing IEFOPZQ while an FRR is in effect.

Table 26. Return and reason codes for the IEFOPZQ macro (continued)		
Return code	Reason code	Equate symbol, meaning and action
8	xxxx0810	Equate symbol: IEFOPZQRsn_BadAnslen Meaning: AnsLen is less than the size of the header area. Action: Provide a larger answer area (as indicated by the ANSLEN keyword).
8	xxxx0811	Equate symbol: IEFOPZQRsn_BadAnsarea Meaning: Error accessing answer area. Action: Make sure that the provided answer area is valid.
8	xxxx0812	Equate symbol: IEFOPZQRsn_BadParmlistALET Meaning: Bad parameter list ALET. Action: Make sure that the ALET associated with the parameter list is valid. The access register might not have been set up correctly.
8	xxxx0813	Equate symbol: IEFOPZQRsn_BadAnsAreaALET Meaning: Bad answer area ALET. Action: Make sure that the ALET associated with the answer area is valid.
0C	–	Equate symbol: IEFOPZQRc_Env Meaning: Environmental error. Action: None - no such reason codes currently exist.
10	–	Equate symbol: IEFOPZQRc_CompError Meaning: Unexpected failure. Action: Report the associated reason code to the system programmer to contact IBM Support.
10	xxxx1001	Equate symbol: IEFOPZQRsn_CompError Meaning: Unexpected failure. The state of the request is unpredictable. Action: Contact your system programmer.

Examples

Example 1:

This example finds the NEW information that is used for this IPL for data set MY.DSN (the value for the ARCH parameter is X'FFFF' which indicates MAXARCH). Return information only for an active specification. Do not return member information. Do not return status information.

For this specification, the amount of data to be returned is known to consist of a header area and one OLD entry and one NEW entry.

The code is as follows:

```
* Invoke IEFOPZQ
   IEFOPZQ REQUEST=BY_OLD,
           DSNAME=d,
           MEMBERS=NO, STATE=ACTIVE,
           ARCH=ar,
           STATUSINFO=NO,
           ANSAREA=a, ANSLEN=a1,
           RETCODE=LRETCODE, RSNCODE=LRSNCODE,
           MF=(E, OPTQL)
*
```

```

* Here you would place code to process the return and
* reason codes.
....
d      DC    CL44'MY.DSN'
al     DC    A(L'a)
ar     DC    X'FFFF'
DYNAREA DSECT
a      DS    CL(OPZAAH_LEN+OPZAAOLD_LEN+OPZAA NEW_LEN)
LRETCODE DS  F
LRSNCODE DS  F
        IEFOPZQ MF=(L,OPTQL),PLISTVER=MAX
        IEFOPZAA

```

Example 2:

This example finds the OLD information for this IPL for a given NEW data set that is to be located by the provided volume ID.

The code is as follows:

```

* Code to set up d, v, and al and to acquire an answer area
* and place its address into register n
....
* Invoke IEFOPZQ
        IEFOPZQ REQUEST=BY_NEW,
                DSNAME=d,VOLUME=v,
                ANSAREA=(n),ANSLEN=a1,
                RETCODE=LRETCODE,RSNCODE=LRSNCODE,
                MF=(E,OPTQL)
* Here you would place code to process the return and
* reason codes. If they indicated that not all data was
* returned (reason IEFOPZQRsn_NotAllDataReturned), then
* acquiring a larger answer area, updating the a1 value and
* retrying IEFOPZQ.
....
DYNAREA DSECT
d      DS    CL44
v      DS    CL6
al     DS    F
LRETCODE DS  F
LRSNCODE DS  F
        IEFOPZQ MF=(L,OPTQL),PLISTVER=MAX
        IEFOPZAA

```

Example 3:

This example finds the matching DDName/Jobname pairs.

The code is as follows:

```

* Code to set up dd, j, and al and to acquire an answer area
* and place its address into register n
....
* Invoke IEFOPZQ
        IEFOPZQ REQUEST=BY_DDJOBNAME,
                DDNAME=dd,JOBNAME=j,
                ANSAREA=(n),ANSLEN=a1,
                RETCODE=LRETCODE,RSNCODE=LRSNCODE,
                MF=(E,OPTQL)
* Here you would place code to process the return and
* reason codes. If they indicated that not all data was
* returned (reason IEFOPZQRsn_NotAllDataReturned), then
* acquiring a larger answer area, updating the a1 value and
* retrying IEFOPZQ.
....
DYNAREA DSECT
dd     DS    D
j      DS    D
al     DS    F
LRETCODE DS  F
LRSNCODE DS  F
        IEFOPZQ MF=(L,OPTQL)
        IEFOPZQ MF=(L,OPTQL),PLISTVER=MAX
        IEFOPZAA

```

Chapter 54. IEFPRMLB – Logical parmlib support

Description

The Logical Parmlib Concatenation is a set of up to 10 partitioned data sets defined by PARMLIB statements in the LOADxx member of either SYSn.IPLPARM or SYS1.PARMLIB which contains many initialization parameters in a pre-specified form in a single logical data set, thus minimizing the need for the operator to enter parameters. SYS1.PARMLIB makes the 11th or last data set in the concatenation and is the default logical parmlib if no PARMLIB statements exist in LOADxx.

The objective of this support is to allow installations to partition access to parmlib and isolate members customized by an installation from IBM maintenance and product level upgrades. The logical parmlib is established during IPL and is used by Master Scheduler Initialization and IEFPRMLB. There is a new SETLOAD command that allows you to switch from one logical parmlib to another without an IPL. The IEFPRMLB macro allows you to access the logical parmlib.

Use the IEFPRMLB macro to:

- Allocate the logical parmlib data set concatenation
- Unallocate the logical parmlib data set concatenation
- Read a logical parmlib data set
- Retrieve information about which data sets make up the logical parmlib

The four functions for the macro are:

- IEFPRMLB REQUEST=ALLOCATE allocates the logical parmlib via DDname.
- IEFPRMLB REQUEST=FREE unallocates the logical parmlib via DDname.
- IEFPRMLB REQUEST=LIST retrieves information about the logical parmlib data set concatenation.
- IEFPRMLB REQUEST=READMEMBER reads a specified member of an already allocated logical parmlib and returns its contents in an input buffer.

Environment

The requirements for the caller are:

Environmental factor	Requirement
Minimum authorization:	Problem state and PSW key 8-15
Dispatchable unit mode:	Task
Cross memory mode:	PASN=HASN=SASN
AMODE:	24- or 31-bit
ASC mode:	Primary or access register (AR)
Interrupt status:	Enabled for I/O and external interrupts.
Locks:	No locks may be held.
Control parameters:	Control parameters must be in the primary address space.

Programming requirements

The caller should include the IEFZPRC mapping macro to get return and reason code equates for all the functions.

If you are going to use the read, message or list buffers, then you should include the IEFZPMAP mapping macro to get their mappings.

Restrictions

The caller may not have an EUT FRR established.

Input register information

Before issuing the IEFPRMLB macro, the caller does not have to place any information into any register unless using it in register notation for a particular parameter, or using it as a base register.

Output register information

When control returns to the caller, the GPRs contain:

Register

Contents

0

Reason code when GPR15 is not 0

1

Used as a work register by the system

2-13

Unchanged

14

Used as a work register by the system

15

Return code

When control returns to the caller, the ARs contain:

Register

Contents

0-1

Used as work registers by the system

2-13

Unchanged

14-15

Used as work registers by the system

Some callers depend on register contents remaining the same before and after issuing a service. If the system changes the contents of registers on which the caller depends, the caller must save them before issuing the service, and restore them after the system returns control.

Performance implications

None.

REQUEST=ALLOCATE option of IEFPRMLB

Syntax

The IEFPRMLB macro is written as follows:

Syntax	Description
<i>name</i>	<i>name</i> : Symbol. Begin <i>name</i> in column 1.
␣	One or more blanks must precede IEFPRMLB.
IEFPRMLB	
␣	One or more blanks must follow IEFPRMLB.
REQUEST=ALLOCATE	
,S99RB=NO	Default: S99RB=NO
,S99RB=YES	
,WAITDSN=NO	Default: WAITDSN=NO
,WAITDSN=YES	
,MOUNT=YES	Default: MOUNT=YES
,MOUNT=NO	
,RETMMSG=NO	Default: RETMMSG=NO
,RETMMSG=YES	
,CONSOLID= <i>consolid</i>	<i>consolid</i> : RS-type address or register (2) - (12).
,CONSOLID=NOCONSID	Default: CONSOLID=NOCONSID
,CART= <i>cart</i>	<i>cart</i> : RS-type address or register (2) - (12).
,CART=NO CART	Default: CART=NO CART
,MSGBUF= <i>msgbuf</i>	<i>msgbuf</i> : RS-type address or register (2) - (12).
,MSGBUF=NOMSGBUF	Default: MSGBUF=NOMSGBUF
,S99RBPTR= <i>s99rbptr</i>	<i>s99rbptr</i> : RS-type address or register (2) - (12).
,ALLOCDNAME= <i>allocddname</i>	<i>allocddname</i> : RS-type address or register (2) - (12).

Syntax	Description
,READ=NO	Default: READ=NO
,READ=YES	
,MEMNAME= <i>memname</i>	<i>memname</i> : RS-type address or register (2) - (12).
,READBUF= <i>readbuf</i>	<i>readbuf</i> : RS-type address or register (2) - (12).
,BLANK72=YES	Default: BLANK72=YES
,BLANK72=NO	
,STARCOMMENT=NO	Default: STARCOMMENT=NO
,STARCOMMENT=YES	
,SYMBOLSUB=YES	Default: SYMBOLSUB=YES
,SYMBOLSUB=NO	
,REMOVECOM=NO	Default: REMOVECOM=NO
,REMOVECOM=YES	
,RDSNINFO= <i>rdsninfo</i>	<i>rdsninfo</i> : RS-type address or address in register (2)-(12).
,MEMNOTFOUND=MSGOK	Default: MEMNOTFOUND=MSGOK
,MEMNOTFOUND=NOMSG	
,FREECLOSE=NO	Default: FREECLOSE=NO
,FREECLOSE=YES	
,CALLERNAME= <i>callername</i>	<i>callername</i> : RS-type address or register (2) - (12).
,RETCODE= <i>retcode</i>	<i>retcode</i> : RS-type address or register (2) - (12).
,RSNCODE= <i>rsncode</i>	<i>rsncode</i> : RS-type address or register (2) - (12).
,PLISTVER= <u>IMPLIED_VERSION</u>	

Syntax	Description
	Default: PLISTVER=IMPLIED_VERSION
,PLISTVER=MAX	
,PLISTVER= <i>plistver</i>	
,MF=S	Default: MF=S
,MF=(L, <i>list addr</i>)	<i>list addr</i> : RS-type address or register (1) - (12).
,MF=(L, <i>list addr,attr</i>)	
,MF=(L, <i>list addr,DD</i>)	
,MF=(E, <i>list addr</i>)	
,MF=(E, <i>list addr,COMPLETE</i>)	

Parameters

The parameters are explained as follows:

REQUEST=ALLOCATE

A required parameter. REQUEST=ALLOCATE allocates the logical parmlib data set concatenation. The allocation uses the data set name(s) and volume serial number(s) provided on the PARMLIB statements in the LOADxx member of SYSn.IPLPARM or SYS1.PARMLIB that is used during IPL processing or as specified by a SETLOAD command. If a volume serial number(s) isn't specified, IEFPRMLB searches the catalog for it. The allocation uses DISP=SHR and UNIT=SYSALLDA. If no PARMLIB statements are provided in the LOADxx member, the allocation uses only SYS1.PARMLIB.

,S99RB=NO

,S99RB=YES

An optional parameter, that specifies whether or not an SVC99 request block is input. The default is S99RB=NO.

,S99RB=NO

specifies that no S99RB is input.

,S99RB=YES

specifies that an SVC99RB (and optionally an SVC99RBX) is input. The SVC99 request block is only required when the caller requires S99FLAG1/S99FLAG2 options not automatically provided by the ALLOCATE function. If the caller requires that the allocation wait for data sets to become available or allow mounting of volumes, the caller must set the appropriate bits in the S99FLAG1/S99FLAG2 fields to request those options. The address of the list of text unit pointers (S99TXTPP) must be zero. If an SVC99 request block is passed and the caller wishes messages issued or returned, the caller must also provide an SVC99 request block extension. The SVC99 request block and SVC99 request block extension are mapped by mapping macro IEFZB4D0.

,WAITDSN=NO

,WAITDSN=YES

An optional parameter when S99RB=YES is not specified, that indicates whether waiting should be allowed for one or more of the data sets in the logical parmlib data set concatenation if they are not readily available (for example, enqueued exclusive by another job). The default is WAITDSN=NO.

,WAITDSN=NO

If one or more of the data sets in the logical parmlib data set concatenation is not readily available (e.g., enqueued exclusive by another job), waiting should not be allowed. In this case upon return from the IEFPRMLB service the logical parmlib data set concatenation will not have been allocated.

,WAITDSN=YES

If one or more of the data sets in the logical parmlib data set concatenation is not readily available (for example, enqueued exclusive by another job), waiting should be allowed. In this case the service will wait for the data set(s) to become available before proceeding with the allocation. Upon return from the IEFPRMLB service the logical parmlib data set concatenation will have been allocated barring other errors.

,MOUNT=YES**,MOUNT=NO**

An optional parameter when S99RB=YES is not specified, that indicates whether the service should allow mounting of volumes or consideration of offline or pending offline devices for one or more of the data sets in the logical parmlib data set concatenation. The default is MOUNT=YES.

,MOUNT=YES

If one or more of the volumes on which one or more of the data sets in the logical parmlib reside is not currently mounted, mounting of that volume(s) should be allowed. If one or more of the devices on which one or more of the data sets in the logical parmlib reside is not currently online or is pending offline, consideration of the offline or pending offline device should be allowed. Upon return from the IEFPRMLB service the logical parmlib data set concatenation will have been allocated barring other errors.

,MOUNT=NO

If one or more of the volumes on which one or more of the data sets in the logical parmlib reside is not currently mounted, mounting of that volume(s) should not be allowed. If one or more of the devices on which one or more of the data sets in the logical parmlib reside is not currently online, consideration of the offline device should not be allowed. Upon return from the IEFPRMLB service the logical parmlib data set concatenation will not have been allocated.

,RETMSG=NO**,RETMSG=YES**

An optional parameter when S99RB=YES is not specified, that specifies whether or not messages are to be returned to the caller in an input message buffer. The default is RETMSG=NO.

,RETMSG=NO

specifies that messages generated during IEFPRMLB processing should not be returned to the caller in the input message buffer (MSGBUF). Messages generated during IEFPRMLB processing will be issued to the console specified by the input console id or will be issued with Route Code 11 (Programmer Information) and descriptor code 4 (System Status) if no console id is input.

,RETMSG=YES

specifies that messages generated during IEFPRMLB processing should be returned to the caller in the input message buffer (MSGBUF). Note that the only messages capable of being returned are those issued by MVS Allocation and SMS. Also, only error messages (severity level 8 and higher) are returned with RETMSG=YES. If warning messages (severity level 4) or informational messages (severity level 0) are desired, then an S99RB and an S99RBX with the desired message severity level (S99EMGSV) must be built and passed by specifying, S99RB=YES, MSGBUF=msgbuf, and S99RBPTR=s99rbptr.

,CONSOLID=consolid**,CONSOLID=NOCONSOLID**

An optional input parameter when RETMSG=YES and S99RB=YES are not specified. It contains the id of the console that originated this request and may be provided if messages are to be issued. The default is NOCONSOLID.

To code: Specify the RS-type address, or address in register (2)-(12), of a 4-character field.

,CART=cart**,CART=NOCART**

An optional input parameter when RETMSG=YES and S99RB=YES are not specified, that contains the command and response token. The default is NOCART.

To code: Specify the RS-type address, or address in register (2)-(12), of an 8-character field.

,MSGBUF=msgbuf**,MSGBUF=NOMSGBUF**

A required input parameter when RETMSG=YES is specified and S99RB=YES is not specified, that is the area into which all messages generated during IEFPRMLB processing are to be placed. The format of each message returned in the buffer is mapped by IEFZPMAP and is compatible with WTO format requirements for the TEXT keyword. There may be more than one message in the buffer. A 4K buffer is recommended. Messages are placed contiguously into the buffer in 256-byte message elements. If the input buffer is not large enough to contain all the generated messages, those messages that will fit are returned in the buffer in the order they are generated. If the message buffer is filled, an indicator (PRM_Msg_Buffer_Full) will be returned to indicate the buffer is full and, therefore, may not contain all messages. PRM_Message_Count will contain the number of messages in the buffer. See DSECT PRM_Message_Buffer in IEFZPMAP for a complete mapping of the message buffer.

The caller must fill in the following fields in the message buffer (DSECT PRM_Message_Buffer):

- PRM_Msg_Buffer_Size set to the size of the buffer (including the header)
- All other fields set to zero

The default is NOMSGBUF.

To code: Specify the RS-type address, or address in register (2)-(12), of a character field.

,S99RBPTR=s99rbptr

A required input parameter when S99RB=YES is specified that contains the address of the SVC99 request block to be used to process the allocation request.

To code: Specify the RS-type address, or address in register (2)-(12), of a pointer field.

,ALLODDNAME=allocddname

A required input output parameter, that is the DDname associated with the logical parmlib. If a non-blank/non-zero DDname is input, the service will examine the active task's TIOT to determine if the DDname is currently allocated. If it is currently allocated, the service will return to its caller without further processing. The service will set return code x'04' (PRMLB_WARNING) and reason code x'01' (PRMLB_DD_ALREADY_ALLOC) to indicate the DDname is currently allocated. If the DDname is not currently allocated, the service will allocate the logical parmlib data set concatenation using the input DDname.

If a blank or zero DDname is input, the service will allocate the logical parmlib data set concatenation and return the system-generated DDname to the caller.

To code: Specify the RS-type address, or address in register (2)-(12), of an 8-character field.

,READ=NO**,READ=YES**

An optional parameter, that specifies whether or not a specified member is to be read from the logical parmlib. The default is READ=NO.

,READ=NO

indicates that no read is to be performed.

,READ=YES

indicates that the specified member of the logical parmlib data set concatenation is to be read and placed into the input buffer. If READ is requested, the member to be read (specified by MEMNAME) and the buffer in which to place the member contents (specified by READBUF) must be provided.

,MEMNAME=memname

A required input parameter when READ=YES is specified, that is the name of the member which is to be read from the logical parmlib data set concatenation. The entire contents of the specified member will be read from the logical parmlib data set concatenation and returned in the input buffer specified on the READBUF keyword.

To code: Specify the RS-type address, or address in register (2)-(12), of an 8-character field.

,READBUF=readbuf

A required input output parameter when READ=YES is specified, that is the area into which the contents of the member of the logical parmlib data set concatenation (specified by MEMNAME) are to be placed. The format of the buffer is mapped by IEFZPMAP. If the member is too large to fit into the buffer, records will be read into the buffer until the buffer is full. The service will terminate with return code x'0C' (PRMLB_Request_Failed) and reason code x'0A' (PRMLB_Read_Buffer_Full) and upon return, the buffer header will contain the buffer size needed to contain the entire member contents. The caller may obtain a larger buffer and invoke IEFPRMLB to read the member again from the beginning. The read buffer header will also contain the number of records that were successfully read the placed into the input buffer and the total number of records contained in the specified member.

For each record read, columns 73 - 80 will be blanked. Unless requested by the Blank72 parameter, column 72 will also be blanked. Symbolic substitution will be performed unless SYMBOLSUB=NO is specified.

The caller must fill in the following fields in the READ buffer (DSECT PRM_Read_Buffer):

- PRM_Read_Buff_Size - set to the size of the buffer
- All other fields set to zero

To code: Specify the RS-type address, or address in register (2)-(12), of a character field.

,BLANK72=YES**,BLANK72=NO**

An optional parameter when READ=YES is specified, that indicates whether or not to blank out column 72. Most parmlib processing is defined to ignore column 72. The default is BLANK72=YES.

,BLANK72=YES

Do blank out column 72.

,BLANK72=NO

Do not blank out column 72.

,STARCOMMENT=NO**,STARCOMMENT=YES**

An optional parameter when READ=YES is specified, that indicates whether a line within the parmlib member that has an asterisk in column 1 should be considered to be a comment that is not even returned to the caller. The default is STARCOMMENT=NO.

,STARCOMMENT=NO

A line with an asterisk in column 1 is not to be considered a comment. It will be included within the data returned.

,STARCOMMENT=YES

A line with an asterisk in column 1 is to be considered a comment. It will not be included within the data returned. Due to this, the nth line of output will be the nth non-star comment line rather than the nth overall line of the member. If you use the line number, make it clear in your explanation that the line number is not the overall line number.

,SYMBOLSUB=YES**,SYMBOLSUB=NO**

When READ=YES is specified, an optional parameter that indicates whether symbol substitution is to be performed. The default is SYMBOLSUB=YES.

,SYMBOLSUB=YES

Symbol substitution is to be performed.

,SYMBOLSUB=NO

Symbol substitution is not to be performed.

,REMOVECOM=NO**,REMOVECOM=YES**

When READ=YES is specified, an optional parameter that indicates whether comments delimited by slash/asterisk and asterisk/slash are to be removed (blanked out) within the returned data.

Comments may be nested within comments. The processing applies to the complete comment. The default is REMOVECOM=NO.

,REMOVECOM=NO

Comments are not to be removed.

,REMOVECOM=YES

Comments are to be removed.

,RDSNINFO=rdsninfo

When READ=YES is specified, an optional output parameter that identifies an area that is to hold the 6-character volume followed by the 44-character name of the data set in which the parmlib member was found. The contents are not defined if the member was not found.

To code: Specify the RS-type address, or address in register (2)-(12), of a 50-character field.

,MEMNOTFOUND=MSGOK

,MEMNOTFOUND=NOMSG

An optional keyword input that indicates whether or not to write a message when the member is not found. The default is MEMNOTFOUND=MSGOK.

,MEMNOTFOUND=MSGOK

Specifies to write a message.

,MEMNOTFOUND=NOMSG

Specifies not to write a message..

,FREECLOSE=NO

,FREECLOSE=YES

An optional keyword input that indicates whether the “logical parmlib” dataset concatenation should be automatically unallocated when the DD is closed. The default is FREECLOSE=NO.

,FREECLOSE=NO

The “logical parmlib” dataset concatenation will not be automatically unallocated when the DD is closed. When the caller's use of the “logical parmlib” dataset concatenation has been complete, the caller must reinvoke the IEFPRMLB service with REQUEST=FREE to unallocated the “logical parmlib” dataset concatenation. Additionally, the caller must ensure the “logical parmlib” has been closed prior to reinvoking the IEFPRMLB service with REQUEST=FREE.

,FREECLOSE=YES

The “logical parmlib” dataset concatenation will be automatically unallocated when the DD is closed. The caller does not need to reinvoke the IEFPRMLB service with REQUEST=FREE. However, the caller should be aware that the “logical parmlib” dataset concatenation will be automatically unallocated as soon as it is closed and would therefore no longer be allocated for use by the caller.

Note: If the caller requests READ(YES) and FREECLOSE(YES), the caller does not need to close the data set nor reinvoke the IEFPRMLB service to free the “logical parmlib” dataset concatenation. The close and free will be done by the Logical Parmlib Service.

,CALLERNAME=callername

A required input parameter, that is the EBCDIC caller's name which is to be used in messages, symptom records and other diagnostic areas as necessary during IEFPRMLB processing. Initial characters A-I and SYS are reserved for IBM use.

The suggested callername definition is 'ProgramName || ServiceLevel'

Example:

```
IEF761I jjobname [procstep] stepname ddname callername
      DD IS ALREADY ALLOCATED AND WILL BE USED BY
      THIS TASK
```

To code: Specify the RS-type address, or address in register (2)-(12), of a 16-character field.

,RETCODE=retcode

An optional output parameter into which the return code is to be copied from GPR 15.

To code: Specify the RS-type address of a fullword field, or register (2)-(12).

,RSNCODE=rsncode

An optional output parameter into which the reason code is to be copied from GPR 0.

To code: Specify the RS-type address of a fullword field, or register (2)-(12).

,PLISTVER=IMPLIED_VERSION**,PLISTVER=MAX****,PLISTVER=plistver**

An optional input parameter that specifies the version of the macro. PLISTVER determines which parameter list the system generates. PLISTVER is an optional input parameter on all forms of the macro, including the list form. When using PLISTVER, specify it on all macro forms used for a request and with the same value on all of the macro forms. The values are:

- **IMPLIED_VERSION**, which is the lowest version that allows all parameters specified on the request to be processed. If you omit the PLISTVER parameter, IMPLIED_VERSION is the default.
- **MAX**, if you want the parameter list to be the largest size currently possible. This size might grow from release to release and affect the amount of storage that your program needs.

If you can tolerate the size change, IBM recommends that you always specify PLISTVER=MAX on the list form of the macro. Specifying MAX ensures that the list-form parameter list is always long enough to hold all the parameters you might specify on the execute form; in this way, MAX ensures that the parameter list does not overwrite nearby storage.

- **0**, if you use the currently available parameters.

To code: Specify one of the following:

- IMPLIED_VERSION
- MAX
- A decimal value of 0

,MF=S**,MF=(L,list addr)****,MF=(L,list addr,attr)****,MF=(L,list addr,0D)****,MF=(E,list addr)****,MF=(E,list addr,COMPLETE)**

An optional input parameter that specifies the macro form.

Use MF=S to specify the standard form of the macro, which builds an inline parameter list and generates the macro invocation to transfer control to the service. MF=S is the default.

Use MF=L to specify the list form of the macro. Use the list form together with the execute form of the macro for applications that require reentrant code. The list form defines an area of storage that the execute form uses to store the parameters. Only the PLISTVER parameter may be coded with the list form of the macro.

Use MF=E to specify the execute form of the macro. Use the execute form together with the list form of the macro for applications that require reentrant code. The execute form of the macro stores the parameters into the storage area defined by the list form, and generates the macro invocation to transfer control to the service.

,list addr

The name of a storage area to contain the parameters. For MF=S, MF=E, and MF=M, this can be an RS-type address or an address in register (1)-(12).

,attr

An optional 1- to 60-character input string, which can contain any value that is valid on an assembler DS pseudo-op. You can use this parameter to force boundary alignment of the

parameter list. If you do not code *attr*, the system provides a value of 0D, which forces the parameter list to a doubleword boundary.

,COMPLETE

Specifies that the system is to check for required parameters and supply defaults for omitted optional parameters.

ABEND codes

None.

Return and reason codes

When the IEFPRMLB macro returns control to your program:

- GPR 15 (and *retcode*, if you coded RETCODE) contains a return code.
- When the value in GPR 15 is not zero, GPR 0 (and *rsncode*, if you coded RSNCODE) contains reason code.

Return and reason code constants are defined in macro IEFZPRC.

The following table identifies the hexadecimal return and reason codes and the equate symbol associated with each reason code.

Return Code	Reason Code	Equate Symbol Meaning and Action
X'00'	—	Equate Symbol: PRMLB_Success Meaning: Return Code - function completed successfully Action: None required.
X'04'	—	Equate Symbol: PRMLB_Warning Meaning: Return Code - Warning
X'04'	X'01'	Equate Symbol: PRMLB_DD_Already_ALLOC Meaning: The specified DDname is already allocated to this task. Action: None required.
X'08'	—	Equate Symbol: PRMLB_Locks_Held Meaning: Return Code - the caller of IEFPRMLB holds a lock. Action: Change the caller's code to release locks prior to invoking IEFPRMLB.
X'0C'	—	Equate Symbol: PRMLB_Request_Failed Meaning: Return Code - request failed.
X'0C'	X'01'	Equate Symbol: PRMLB_Member_Not_Found Meaning: The specified member name was not found. Action: Ensure the specified member name exists. If so, contact the system programmer.

<i>Table 27. Return and Reason Codes for the IEFPRMLB Macro (continued)</i>		
Return Code	Reason Code	Equate Symbol Meaning and Action
X'0C'	X'02'	Equate Symbol: PRMLB_Read_IO_Error Meaning: An I/O error was encountered while attempting to read the specified member. Action: Contact the system programmer.
X'0C'	X'03'	Equate Symbol: PRMLB_Open_Error Meaning: An error was encountered while attempting to open the logical parmlib. Action: Contact the system programmer.
X'0C'	X'04'	Equate Symbol: PRMLB_ALLOC_Failed Meaning: Allocation of one of the logical parmlib data sets failed Action: Contact the system programmer.
X'0C'	X'05'	Equate Symbol: PRMLB_CONCAT_Failed Meaning: Concatenation of the logical parmlib data sets failed Action: Contact the system programmer.
X'0C'	X'06'	Equate Symbol: PRMLB_Reader_Load_Failed Meaning: Load of the parmlib read routine failed. Action: Contact the system programmer.
X'0C'	X'07'	Equate Symbol: PRMLB_Unable_To_Access_DS Meaning: The parmlib read routine was unable to access the logical parmlib Action: Contact the system programmer.
X'0C'	X'08'	Equate Symbol: PRMLB_Parmlib_Still_Open Meaning: REQUEST=FREE was requested but the logical parmlib is still open. Action: Close the data set prior to issuing the REQUEST=FREE.
X'0C'	X'09'	Equate Symbol: PRMLB_UNALLOC_Failed Meaning: Unallocation of the logical parmlib data sets failed. Action: Contact the system programmer.

<i>Table 27. Return and Reason Codes for the IEFPRMLB Macro (continued)</i>		
Return Code	Reason Code	Equate Symbol Meaning and Action
X'0C'	X'0A'	<p>Equate Symbol: PRMLB_Read_Buffer_Full</p> <p>Meaning: The input READ buffer is full and READ processing could not continue</p> <p>Action: The caller may obtain a buffer large enough to contain the entire member contents (PRM_Buff_Size_Needed in DSECT PRM_Read_Buffer which is mapped by IEFZPMAP contains the required size) and re-invoke IEFPRMLB to begin reading the specified member again.</p>
X'0C'	X'0B'	<p>Equate Symbol: PRMLB_Putline_Error</p> <p>Meaning: Putline processing abended. This could be due to an error in the user-provided CPPL (pointed to by S99ECPL when the user provides an S99RB).</p> <p>Action: Verify that the CPPL is valid.</p>
X'10'	—	<p>Equate Symbol: PRMLB_Internal_Error</p> <p>Meaning: Return Code - an internal error occurred.</p>
X'10'	X'01'	<p>Equate Symbol: PRMLB_Bad_Parameter</p> <p>Meaning: A bad parameter list was passed to the parmlib read routine.</p> <p>Action: Contact the system programmer.</p>
X'10'	X'02'	<p>Equate Symbol: PRMLB_Unknown_Reason</p> <p>Meaning: Return Code - Reason for failure is unknown.</p> <p>Action: Contact the system programmer.</p>
X'14'	—	<p>Equate Symbol: PRMLB_Not_Task_Mode</p> <p>Meaning: Return Code - the caller is not in Task mode.</p> <p>Action: Contact the system programmer.</p>
X'1C'	—	<p>Equate Symbol: PRMLB_Invalid_Parameter_List</p> <p>Meaning: Return Code - the input parameter list is invalid.</p>
X'1C'	X'01'	<p>Equate Symbol: PRMLB_Plist_Unaccessible</p> <p>Meaning: The IEFPRMLB service was unable to access the input parameter list.</p> <p>Action: Ensure the parameter list resides in storage belonging to the caller. If so, contact the system programmer.</p>
X'1C'	X'02'	<p>Equate Symbol: PRMLB_ListBuff_Unaccessible</p> <p>Meaning: The IEFPRMLB service was unable to access the input LIST buffer.</p> <p>Action: Ensure the list buffer resides in storage belonging to the caller. If so, contact the system programmer.</p>

<i>Table 27. Return and Reason Codes for the IEFPRMLB Macro (continued)</i>		
Return Code	Reason Code	Equate Symbol Meaning and Action
X'1C'	X'03'	<p>Equate Symbol: PRMLB_MsgBuff_Unaccessible</p> <p>Meaning: The IEFPRMLB service was unable to access the input message buffer.</p> <p>Action: Ensure the message buffer resides in storage belonging to the caller. If so, contact the system programmer.</p>
X'1C'	X'04'	<p>Equate Symbol: PRMLB_ReadBuff_Unaccessible</p> <p>Meaning: The IEFPRMLB service was unable to access the input read buffer.</p> <p>Action: Ensure the read buffer resides in storage belonging to the caller. If so, contact the system programmer.</p>
X'1C'	X'05'	<p>Equate Symbol: PRMLB_Plist_S99TXTPP_NOT0</p> <p>Meaning: The S99RB provided to the IEFPRMLB service contains a non-zero S99TXTPP field.</p> <p>Action: Change the caller's code to zero the S99TXTPP prior to the call to IEFPRMLB.</p>
X'1C'	X'06'	<p>Equate Symbol: PRMLB_MsgBuff_Format_Error</p> <p>Meaning: The format of the message buffer provided to the IEFPRMLB service is invalid.</p> <p>Action: Correct the message buffer format.</p>
X'1C'	X'07'	<p>Equate Symbol: PRMLB_ReadBuff_Format_Error</p> <p>Meaning: The format of the read buffer provided to the IEFPRMLB service is invalid.</p> <p>Action: Correct the read buffer format.</p>
X'1C'	X'08'	<p>Equate Symbol: PRMLB_ListBuff_Format_Error</p> <p>Meaning: The format of the list buffer provided to the IEFPRMLB service is invalid.</p> <p>Action: Correct the list buffer format.</p>
X'1C'	X'09'	<p>Equate Symbol: PRMLB_S99RB_Unaccessible</p> <p>Meaning: The IEFPRMLB service was unable to access the input read buffer.</p> <p>Action: Ensure the S99RB resides in storage belonging to the caller. If so, contact the system programmer.</p>
X'20'	—	<p>Equate Symbol: PRMLB_Cross_Memory</p> <p>Meaning: Return Code - the caller is in cross memory mode.</p> <p>Action: Change the caller's code so it is not in cross memory mode when invoking IEFPRMLB.</p>

Table 27. Return and Reason Codes for the IEFPRMLB Macro (continued)

Return Code	Reason Code	Equate Symbol Meaning and Action
X'24'	—	<p>Equate Symbol: PRMLB_ESTAE_Setup_Failed</p> <p>Meaning: Return Code - a failure occurred when IEFPRMLB processing attempted to set up an ESTAE environment.</p> <p>Action: Contact the system programmer.</p>
X'28'	—	<p>Equate Symbol: PRMLB_Notauth_To_Subpool</p> <p>Meaning: Return Code - an unauthorized caller requested messages in an authorized subpool.</p> <p>Action: Only specify subpools to which the program is authorized.</p>

REQUEST=FREE option of IEFPRMLB

Syntax

The IEFPRMLB macro is written as follows:

Syntax	Description
<i>name</i>	<i>name</i> : Symbol. Begin <i>name</i> in column 1.
␣	One or more blanks must precede IEFPRMLB.
IEFPRMLB	
␣	One or more blanks must follow IEFPRMLB.
REQUEST=FREE	
,RETMMSG=NO	Default: RETMMSG=NO
,RETMMSG=YES	
,CONSOLID= <i>consolid</i>	<i>consolid</i> : RS-type address or register (2) - (12).
,CONSOLID=NOCONSOLID	Default: CONSOLID=NOCONSOLID
,CART= <i>cart</i>	<i>cart</i> : RS-type address or register (2) - (12).
,CART=NO CART	Default: CART=NO CART
,MSGBUF= <i>msgbuf</i>	<i>msgbuf</i> : RS-type address or register (2) - (12).

Syntax	Description
,MSGBUF= <u>NOMSGBUF</u>	Default: MSGBUF=NOMSGBUF
,DDNAME= <i>ddname</i>	<i>ddname</i> : RS-type address or register (2) - (12).
,CALLERNAME= <i>callername</i>	<i>callername</i> : RS-type address or register (2) - (12),
,RETCODE= <i>retcode</i>	<i>retcode</i> : RS-type address or register (2) - (12).
,RSNCODE= <i>rsncode</i>	<i>rsncode</i> : RS-type address or register (2) - (12).
,PLISTVER= <u>IMPLIED_VERSION</u>	
	Default: PLISTVER=IMPLIED_VERSION
,PLISTVER=MAX	
,PLISTVER= <i>plistver</i>	
,MF= <u>S</u>	Default: MF=S
,MF=(L, <i>list addr</i>)	<i>list addr</i> : RS-type address or register (1) - (12).
,MF=(L, <i>list addr,attr</i>)	
,MF=(L, <i>list addr,DD</i>)	
,MF=(E, <i>list addr</i>)	
,MF=(E, <i>list addr,COMPLETE</i>)	

Parameters

The parameters are explained as follows:

REQUEST=FREE

A required parameter. REQUEST=FREE unallocates the logical parmlib data set concatenation.

,RETMSG=NO

,RETMSG=YES

An optional parameter, that indicates whether or not messages are to be returned to the caller in an input message buffer. The default is RETMSG=NO.

,RETMSG=NO

specifies that messages generated during IEFPRMLB processing should not be returned to the caller in the input message buffer (MSGBUF). Messages generated during IEFPRMLB processing will be issued to the console specified by the input console id or will be issued with Route Code 11 (Programmer Information) and descriptor code 4 (System Status) if no console id is input.

,RETMSG=YES

specifies that messages generated during IEFPRMLB processing should be returned to the caller in the input message buffer (MSGBUF). Note that the only messages capable of being returned are those issued by MVS Allocation and SMS. Also, only error messages (severity level 8 and higher) are returned with RETMSG=YES.

,CONSOLID=consolid**,CONSOLID=NOCONSID**

An optional input parameter when RETMSG=YES is not specified, that contains the id of the console which originated this request and may be provided if messages are to be issued. The default is NOCONSID.

To code: Specify the RS-type address, or address in register (2)-(12), of a 4-character field.

,CART=cart**,CART=NO CART**

An optional input parameter when RETMSG=YES is not specified, that contains the Command And Response Token. The default is NOCART.

To code: Specify the RS-type address, or address in register (2)-(12), of an 8-character field.

,MSGBUF=msgbuf**,MSGBUF=NOMSGBUF**

A required input parameter when RETMSG=YES is specified, that is the area into which all messages generated during IEFPRMLB processing are to be placed. The format of each message returned in the buffer is mapped by IEFZPMAP and is compatible with WTO format requirements for the TEXT keyword. There may be more than one message in the buffer. A 4K buffer is recommended. Messages are placed contiguously into the buffer in 256-byte message elements. If the input buffer is not large enough to contain all the generated messages, those messages that will fit are returned in the buffer in the order they are generated. If the message buffer is filled, an indicator (PRM_Msg_Buffer_Full) will be returned to indicate the buffer is full and, therefore, may not contain all messages. PRM_Message_Count will contain the number of messages in the buffer. See DSECT PRM_Message_Buffer in IEFZPMAP for a complete mapping of the message buffer.

The caller must fill in the following fields in the message buffer (DSECT PRM_Message_Buffer):

- PRM_Msg_Buffer_Size set to the size of the buffer (including the header)
- All other fields set to zero

The default is NOMSGBUF.

To code: Specify the RS-type address, or address in register (2)-(12), of a character field.

,DDNAME=ddname

A required input parameter, that is the DDname associated with the logical parmlib. The logical parmlib data set concatenation will be unallocated. The DDname originally input to or returned by the invocation of IEFPRMLB REQUEST=ALLOCATE should be input. If the logical parmlib is open when IEFPRMLB is invoked with REQUEST=FREE, the unallocation will fail.

To code: Specify the RS-type address, or address in register (2)-(12), of an 8-character field.

,CALLERNAME=callername

A required input parameter, that is the EBCDIC caller's name which is to be used in messages, symptom records and other diagnostic areas as necessary during IEFPRMLB processing. Initial characters A-I and SYS are reserved for IBM use.

The suggested callername definition is 'ProgramName || ServiceLevel'

Example:

```
IEF761I jjobname [procstep] stepname ddname callername
      DD IS ALREADY ALLOCATED AND WILL BE USED BY
      THIS TASK
```

To code: Specify the RS-type address, or address in register (2)-(12), of a 16-character field.

,RETCODE=retcode

An optional output parameter into which the return code is to be copied from GPR 15.

To code: Specify the RS-type address of a fullword field, or register (2)-(12).

,RSNCODE=rsncode

An optional output parameter into which the reason code is to be copied from GPR 0.

To code: Specify the RS-type address of a fullword field, or register (2)-(12).

,PLISTVER=IMPLIED_VERSION**,PLISTVER=MAX****,PLISTVER=plistver**

An optional input parameter that specifies the version of the macro. PLISTVER determines which parameter list the system generates. PLISTVER is an optional input parameter on all forms of the macro, including the list form. When using PLISTVER, specify it on all macro forms used for a request and with the same value on all of the macro forms. The values are:

- **IMPLIED_VERSION**, which is the lowest version that allows all parameters specified on the request to be processed. If you omit the PLISTVER parameter, IMPLIED_VERSION is the default.
- **MAX**, if you want the parameter list to be the largest size currently possible. This size might grow from release to release and affect the amount of storage that your program needs.

If you can tolerate the size change, IBM recommends that you always specify PLISTVER=MAX on the list form of the macro. Specifying MAX ensures that the list-form parameter list is always long enough to hold all the parameters you might specify on the execute form; in this way, MAX ensures that the parameter list does not overwrite nearby storage.

- **0**, if you use the currently available parameters.

To code: Specify one of the following:

- IMPLIED_VERSION
- MAX
- A decimal value of 0

,MF=S**,MF=(L,list addr)****,MF=(L,list addr,attr)****,MF=(L,list addr,0D)****,MF=(E,list addr)****,MF=(E,list addr,COMPLETE)**

An optional input parameter that specifies the macro form.

Use MF=S to specify the standard form of the macro, which builds an inline parameter list and generates the macro invocation to transfer control to the service. MF=S is the default.

Use MF=L to specify the list form of the macro. Use the list form together with the execute form of the macro for applications that require reentrant code. The list form defines an area of storage that the execute form uses to store the parameters. Only the PLISTVER parameter may be coded with the list form of the macro.

Use MF=E to specify the execute form of the macro. Use the execute form together with the list form of the macro for applications that require reentrant code. The execute form of the macro stores the parameters into the storage area defined by the list form, and generates the macro invocation to transfer control to the service.

,list addr

The name of a storage area to contain the parameters. For MF=S, MF=E, and MF=M, this can be an RS-type address or an address in register (1)-(12).

,attr

An optional 1- to 60-character input string, which can contain any value that is valid on an assembler DS pseudo-op. You can use this parameter to force boundary alignment of the parameter list. If you do not code *attr*, the system provides a value of 0D, which forces the parameter list to a doubleword boundary.

,COMPLETE

Specifies that the system is to check for required parameters and supply defaults for omitted optional parameters.

ABEND codes

None.

Return and reason codes

When the IEFPRMLB macro returns control to your program:

- GPR 15 (and *retcode*, if you coded RETCODE) contains a return code.
- When the value in GPR 15 is not zero, GPR 0 (and *rsncode*, if you coded RSNCODE) contains reason code.

See the return codes in under REQUEST=ALLOCATE option of IEFPRMLB.

Examples

None.

REQUEST=LIST option of IEFPRMLB**Syntax**

The IEFPRMLB macro is written as follows:

Syntax	Description
<i>name</i>	<i>name</i> : Symbol. Begin <i>name</i> in column 1.
␣	One or more blanks must precede IEFPRMLB.
IEFPRMLB	
␣	One or more blanks must follow IEFPRMLB.
REQUEST=LIST	
,BUFFER= <i>buffer</i>	<i>buffer</i> : RS-type address or register (2) - (12).
,CALLERNAME= <i>callername</i>	<i>callername</i> : RS-type address or register (2) - (12).
,RETCODE= <i>retcode</i>	<i>retcode</i> : RS-type address or register (2) - (12).

Syntax	Description
,RSNCODE= <i>rsncode</i>	<i>rsncode</i> : RS-type address or register (2) - (12).
,PLISTVER= <u>IMPLIED_VERSION</u>	
	Default: PLISTVER=IMPLIED_VERSION
,PLISTVER=MAX	
,PLISTVER= <i>plistver</i>	
,MF= <u>S</u>	Default: MF=S
,MF=(L, <i>list addr</i>)	<i>list addr</i> : RS-type address or register (1) - (12),
,MF=(L, <i>list addr,attr</i>)	
,MF=(L, <i>list addr,OD</i>)	
,MF=(E, <i>list addr</i>)	
,MF=(E, <i>list addr,COMPLETE</i>)	

Parameters

The parameters are explained as follows:

REQUEST=LIST

A required parameter. REQUEST=LIST requests information about the logical parmlib data set concatenation. For each data set included in the logical parmlib, for which there is room in the provided buffer, the following information is returned:

- Data set name (either specified on a PARMLIB statement in LOADxx or SYS1.PARMLIB (if no PARMLIB statements are provided in LOADxx)).
- Volume serial number where the data set resides (if a volume serial number is provided on the PARMLIB statement).

The number of data sets which make up the logical parmlib data set concatenation is also returned. If this number is larger than the number of 60-byte entries for which room was provided, then the system did not return all of the available information. In that case, you should allocate a larger buffer based on the returned number and call the service again, in order to retrieve all of the information.

NOTE: The LIST function only returns information on those data sets which are currently being used by the system. If a data set was found unusable during LOADxx processing, that data set is not being used as part of the logical parmlib concatenation and its information will not be returned by the LIST function. Exclusion of unusable data sets is only possible when no SETLOAD command was issued after IPL since an unusable data set encountered during SETLOAD processing causes SETLOAD to fail.

,BUFFER=*buffer*

A required input parameter, that is the area where the information about the logical parmlib data set concatenation is to be placed. The buffer is mapped by IEFZPMAP. The caller must fill in the following fields in the list buffer (DSECT PRM_List_Buffer):

- PRM_List_Version
 - Set this using either equate symbol PRM_List_VER1 or PRM_List_Current_Version.
- PRM_List_Buff_Size

- Set this to the size of the provided area. It must be at least the size of PRM_List_Header. It should contain room for at least 11 60-byte entries as well.
- All other fields set to zero

To code: Specify the RS-type address, or address in register (2)-(12), of a character field.

,CALLERNAME=callername

A required input parameter, that is the EBCDIC caller's name which is to be used in messages, symptom records and other diagnostic areas as necessary during IEFPRMLB processing. Initial characters A-I and SYS are reserved for IBM use.

The suggested callername definition is 'ProgramName || ServiceLevel'

Example:

```
IEF761I jjobname [procstep] stepname ddname callername
        DD IS ALREADY ALLOCATED AND WILL BE USED BY
        THIS TASK
```

To code: Specify the RS-type address, or address in register (2)-(12), of a 16-character field.

,RETCODE=retcode

An optional output parameter into which the return code is to be copied from GPR 15.

To code: Specify the RS-type address of a fullword field, or register (2)-(12).

,RSNCODE=rsncode

An optional output parameter into which the reason code is to be copied from GPR 0.

To code: Specify the RS-type address of a fullword field, or register (2)-(12).

,PLISTVER=IMPLIED_VERSION

,PLISTVER=MAX

,PLISTVER=plistver

An optional input parameter that specifies the version of the macro. PLISTVER determines which parameter list the system generates. PLISTVER is an optional input parameter on all forms of the macro, including the list form. When using PLISTVER, specify it on all macro forms used for a request and with the same value on all of the macro forms. The values are:

- **IMPLIED_VERSION**, which is the lowest version that allows all parameters specified on the request to be processed. If you omit the PLISTVER parameter, IMPLIED_VERSION is the default.
- **MAX**, if you want the parameter list to be the largest size currently possible. This size might grow from release to release and affect the amount of storage that your program needs.

If you can tolerate the size change, IBM recommends that you always specify PLISTVER=MAX on the list form of the macro. Specifying MAX ensures that the list-form parameter list is always long enough to hold all the parameters you might specify on the execute form; in this way, MAX ensures that the parameter list does not overwrite nearby storage.

- **0**, if you use the currently available parameters.

To code: Specify one of the following:

- IMPLIED_VERSION
- MAX
- A decimal value of 0

,MF=S

,MF=(L,list addr)

,MF=(L,list addr,attr)

,MF=(L,list addr,0D)

,MF=(E,list addr)

,MF=(E,list addr,COMPLETE)

An optional input parameter that specifies the macro form.

IEFPRMLB macro

Use MF=S to specify the standard form of the macro, which builds an inline parameter list and generates the macro invocation to transfer control to the service. MF=S is the default.

Use MF=L to specify the list form of the macro. Use the list form together with the execute form of the macro for applications that require reentrant code. The list form defines an area of storage that the execute form uses to store the parameters. Only the PLISTVER parameter may be coded with the list form of the macro.

Use MF=E to specify the execute form of the macro. Use the execute form together with the list form of the macro for applications that require reentrant code. The execute form of the macro stores the parameters into the storage area defined by the list form, and generates the macro invocation to transfer control to the service.

,list addr

The name of a storage area to contain the parameters. For MF=S, MF=E, and MF=M, this can be an RS-type address or an address in register (1)-(12).

,attr

An optional 1- to 60-character input string, which can contain any value that is valid on an assembler DS pseudo-op. You can use this parameter to force boundary alignment of the parameter list. If you do not code *attr*, the system provides a value of 0D, which forces the parameter list to a doubleword boundary.

,COMPLETE

Specifies that the system is to check for required parameters and supply defaults for omitted optional parameters.

ABEND codes

None.

Return and reason codes

When the IEFPRMLB macro returns control to your program:

- GPR 15 (and *retcode*, if you coded RETCODE) contains a return code.
- When the value in GPR 15 is not zero, GPR 0 (and *rsncode*, if you coded RSNCODE) contains reason code.

See return codes under REQUEST=ALLOCATE option of IEFPRMLB.

Examples

None.

REQUEST=READMEMBER option of IEFPRMLB

Syntax

The IEFPRMLB macro is written as follows:

Syntax	Description
<i>name</i>	<i>name</i> : Symbol. Begin <i>name</i> in column 1.
␣	One or more blanks must precede IEFPRMLB.

Syntax	Description
IEFPRMLB	
└	One or more blanks must follow IEFPRMLB.
REQUEST=READMEMBER	
,DDNAME= <i>ddname</i>	<i>ddname</i> : RS-type address or register (2) - (12).
,MEMNAME= <i>memname</i>	<i>memname</i> : RS-type address or register (2) - (12).
,READBUF= <i>readbuf</i>	<i>readbuf</i> : RS-type address or register (2) - (12).
,BLANK72=YES	Default: BLANK72=YES
,BLANK72=NO	
,STARCOMMENT=NO	Default: STARCOMMENT=NO
,STARCOMMENT=YES	
█ ,SYMBOLSUB=YES	Default: SYMBOLSUB=YES
█ ,SYMBOLSUB=NO	
█ ,REMOVECOM=NO	Default: REMOVECOM=NO
█ ,REMOVECOM=YES	
█ ,RDSNINFO= <i>rdsninfo</i>	<i>rdsninfo</i> : RS-type address or address in register (2)-(12).
,MSG=YES	Default: MSG=YES
,MSG=NO	
,RETMSG=NO	Default: RETMSG=NO
,RETMSG=YES	
,CONSOLID= <i>consolid</i>	<i>consolid</i> : RS-type address or register (2) - (12).
,CONSOLID=NOCONSID	Default: CONSOLID=NOCONSID

Syntax	Description
,CART= <i>cart</i>	<i>cart</i> : RS-type address or register (2) - (12).
,CART= <u>NOCART</u>	Default: CART=NOCART
,MSGBUF= <i>msgbuf</i>	<i>msgbuf</i> : RS-type address or register (2) - (12).
,MSGBUF= <u>NOMSGBUF</u>	Default: MSGBUF=NOMSGBUF
,CALLERNAME= <i>callername</i>	<i>callername</i> : RS-type address or register (2) - (12).
,RETCODE= <i>retcode</i>	<i>retcode</i> : RS-type address or register (2) - (12).
,RSNCODE= <i>rsncode</i>	<i>rsncode</i> : RS-type address or register (2) - (12).
,PLISTVER= <u>IMPLIED_VERSION</u>	
	Default: PLISTVER=IMPLIED_VERSION
,PLISTVER=MAX	
,PLISTVER= <i>plistver</i>	
,MF= <u>S</u>	Default: MF=S
,MF=(L, <i>list addr</i>)	<i>list addr</i> : RS-type address or register (1) - (12).
,MF=(L, <i>list addr,attr</i>)	
,MF=(L, <i>list addr,0D</i>)	
,MF=(E, <i>list addr</i>)	
,MF=(E, <i>list addr,COMPLETE</i>)	

Parameters

The parameters are explained as follows:

REQUEST=READMEMBER

A required parameter. REQUEST=READMEMBER indicates to read the specified member of the logical parmlib data set concatenation and place the contents into the input buffer.

,DDNAME=*ddname*

A required input parameter, that is the DDname associated with the allocated logical parmlib.

To code: Specify the RS-type address, or address in register (2)-(12), of an 8-character field.

,MEMNAME=*memname*

A required input parameter, that is the name of the member which is to be read from the logical parmlib data set concatenation. The entire contents of the specified member will be read from the logical parmlib data set concatenation and returned in the input buffer specified on the READBUF keyword.

To code: Specify the RS-type address, or address in register (2)-(12), of an 8-character field.

,READBUF=readbuf

A required input output parameter, that is the area into which the contents of the member of the logical parmlib data set concatenation (specified by MEMNAME) are to be placed. The format of the buffer is mapped by IEFZPMAP. If the member is too large to fit into the buffer, records will be read into the buffer until the buffer is full. The service will terminate with return code x'0C' (PRMLB_Request_Failed), reason code x'0A' (PRMLB_Read_Buffer_Full) and upon return, the buffer header will contain the buffer size needed to contain the entire member contents. The caller may obtain a larger buffer and invoke IEFPRMLB to read the member again from the beginning. The read buffer header will also contain the number of records that were successfully read the placed into the input buffer and the total number of records contained in the specified member.

For each record read, columns 73 - 80 will be blanked. Unless requested by the Blank72 parameter, column 72 will also be blanked. Symbolic substitution will be performed unless SYMBOLSUB=NO is specified.

The caller must fill in the following fields in the READ buffer (DSECT PRM_Read_Buffer):

- PRM_Read_Buff_Size - set to the size of the buffer
- All other fields set to zero

To code: Specify the RS-type address, or address in register (2)-(12), of a character field.

,BLANK72=YES**,BLANK72=NO**

An optional parameter, that indicates whether or not to blank out column 72. Most parmlib processing is defined to ignore column 72. The default is BLANK72=YES.

,BLANK72=YES

Do blank out column 72.

,BLANK72=NO

Do not blank out column 72.

,STARCOMMENT=NO**,STARCOMMENT=YES**

An optional parameter that indicates whether a line within the parmlib member that has an asterisk in column 1 should be considered to be a comment that is not even returned to the caller. The default is STARCOMMENT=NO.

,STARCOMMENT=NO

A line with an asterisk in column 1 is not to be considered a comment. It will be included within the data returned.

,STARCOMMENT=YES

A line with an asterisk in column 1 is to be considered a comment. It will not be included within the data returned. Due to this, the nth line of output will be the nth non-star comment line rather than the nth overall line of the member. If you use the line number, make it clear in your explanation that the line number is not the overall line number.

,SYMBOLSUB=YES**,SYMBOLSUB=NO**

When READ=YES is specified, an optional parameter that indicates whether symbol substitution is to be performed. The default is SYMBOLSUB=YES.

,SYMBOLSUB=YES

Symbol substitution is to be performed.

,SYMBOLSUB=NO

Symbol substitution is not to be performed.

,REMOVECOM=NO**,REMOVECOM=YES**

When READ=YES is specified, an optional parameter that indicates whether comments delimited by slash/asterisk and asterisk/slash are to be removed (blanked out) within the returned data.

Comments may be nested within comments. The processing applies to the complete comment. The default is REMOVECOM=NO.

,REMOVECOM=NO

Comments are not to be removed.

,REMOVECOM=YES

Comments are to be removed.

,RDSNINFO=*rdsninfo*

An optional output parameter that identifies an area that is to hold the 6-character volume followed by the 44-character name of the data set in which the parmlib member was found. The contents are not defined if the member was not found.

To code: Specify the RS-type address, or address in register (2)-(12), of a 50-character field.

,MSG=YES

,MSG=NO

An optional parameter, that indicates whether or not allocation/SMS message processing is to be performed. The default is MSG=YES.

,MSG=YES

Specifies that allocation/SMS message processing is to be performed.

,MSG=NO

Specifies that no message processing is to be performed. If MSG=NO is coded, no messages generated by the logical parmlib service will be issued to the console or hardcopy log and no messages will be returned to the caller.

,RETMSG=NO

,RETMSG=YES

An optional parameter when MSG=YES is specified, that indicates whether or not messages are to be returned to the caller in an input message buffer. The default is RETMSG=NO.

,RETMSG=NO

specifies that messages generated during IEFPRMLB processing should not be returned to the caller in the input message buffer (MSGBUF). Messages generated during IEFPRMLB processing will be issued to the console specified by the input console id or will be issued with Route Code 11 (Programmer Information) and descriptor code 4 (System Status) if no console id is input.

,RETMSG=YES

specifies that messages generated during IEFPRMLB processing should be returned to the caller in the input message buffer (MSGBUF). Note that the only messages capable of being returned are those issued by MVS Allocation and SMS. Also, only error messages (severity level 8 and higher) are returned with RETMSG=YES.

,CONSOLID=*consolid*

,CONSOLID=NOCONSID

An optional input parameter when RETMSG=YES is not specified and MSG=YES is specified, that contains the id of the console which originated this request and may be provided if messages are to be issued. The default is NOCONSID.

To code: Specify the RS-type address, or address in register (2)-(12), of a 4-character field.

,CART=*cart*

,CART=NO CART

An optional input parameter when RETMSG=YES is not specified and MSG=YES is specified, that contains the Command And Response Token. The default is NOCART.

To code: Specify the RS-type address, or address in register (2)-(12), of an 8-character field.

,MSGBUF=*msgbuf*

,MSGBUF=NO MSGBUF

A required input parameter when RETMSG=YES and MSG=YES are specified, that is the area into which all messages generated during IEFPRMLB processing are to be placed. The format of each

message returned in the buffer is mapped by IEFZPMAP and is compatible with WTO format requirements for the TEXT keyword. There may be more than one message in the buffer. A 4K buffer is recommended. Messages are placed contiguously into the buffer in 256-byte message elements. If the input buffer is not large enough to contain all the generated messages, those messages that will fit are returned in the buffer in the order they are generated. If the message buffer is filled, an indicator (PRM_Msg_Buffer_Full) will be returned to indicate the buffer is full and, therefore, may not contain all messages. PRM_Message_Count will contain the number of messages in the buffer. See DSECT PRM_Message_Buffer in IEFZPMAP for a complete mapping of the message buffer.

The caller must fill in the following fields in the message buffer (DSECT PRM_Message_Buffer):

- PRM_Msg_Buffer_Size set to the size of the buffer (including the header)
- All other fields set to zero

The default is NOMSGBUF.

To code: Specify the RS-type address, or address in register (2)-(12), of a character field.

,CALLERNAME=callername

A required input parameter, that is the EBCDIC caller's name which is to be used in messages, symptom records and other diagnostic areas as necessary during IEFPRMLB processing. Initial characters A-I and SYS are reserved for IBM use.

The suggested callername definition is 'ProgramName || ServiceLevel'

Example:

```
IEF761I jjobname [procstep] stepname ddname callername
        DD IS ALREADY ALLOCATED AND WILL BE USED BY
        THIS TASK
```

To code: Specify the RS-type address, or address in register (2)-(12), of a 16-character field.

,RETCODE=retcode

An optional output parameter into which the return code is to be copied from GPR 15.

To code: Specify the RS-type address of a fullword field, or register (2)-(12).

,RSNCODE=rsncode

An optional output parameter into which the reason code is to be copied from GPR 0.

To code: Specify the RS-type address of a fullword field, or register (2)-(12).

,PLISTVER=IMPLIED_VERSION

,PLISTVER=MAX

,PLISTVER=plistver

An optional input parameter that specifies the version of the macro. PLISTVER determines which parameter list the system generates. PLISTVER is an optional input parameter on all forms of the macro, including the list form. When using PLISTVER, specify it on all macro forms used for a request and with the same value on all of the macro forms. The values are:

- **IMPLIED_VERSION**, which is the lowest version that allows all parameters specified on the request to be processed. If you omit the PLISTVER parameter, IMPLIED_VERSION is the default.
- **MAX**, if you want the parameter list to be the largest size currently possible. This size might grow from release to release and affect the amount of storage that your program needs.

If you can tolerate the size change, IBM recommends that you always specify PLISTVER=MAX on the list form of the macro. Specifying MAX ensures that the list-form parameter list is always long enough to hold all the parameters you might specify on the execute form; in this way, MAX ensures that the parameter list does not overwrite nearby storage.

- **0**, if you use the currently available parameters.

To code: Specify one of the following:

- IMPLIED_VERSION

IEFPRMLB macro

- MAX
- A decimal value of 0

,MF=S

,MF=(L,*list addr*)

,MF=(L,*list addr*,*attr*)

,MF=(L,*list addr*,0D)

,MF=(E,*list addr*)

,MF=(E,*list addr*,COMPLETE**)**

An optional input parameter that specifies the macro form.

Use MF=S to specify the standard form of the macro, which builds an inline parameter list and generates the macro invocation to transfer control to the service. MF=S is the default.

Use MF=L to specify the list form of the macro. Use the list form together with the execute form of the macro for applications that require reentrant code. The list form defines an area of storage that the execute form uses to store the parameters. Only the PLISTVER parameter may be coded with the list form of the macro.

Use MF=E to specify the execute form of the macro. Use the execute form together with the list form of the macro for applications that require reentrant code. The execute form of the macro stores the parameters into the storage area defined by the list form, and generates the macro invocation to transfer control to the service.

,*list addr*

The name of a storage area to contain the parameters. For MF=S, MF=E, and MF=M, this can be an RS-type address or an address in register (1)-(12).

,*attr*

An optional 1- to 60-character input string, which can contain any value that is valid on an assembler DS pseudo-op. You can use this parameter to force boundary alignment of the parameter list. If you do not code *attr*, the system provides a value of 0D, which forces the parameter list to a doubleword boundary.

,COMPLETE****

Specifies that the system is to check for required parameters and supply defaults for omitted optional parameters.

ABEND codes

None.

Return and reason codes

When the IEFPRMLB macro returns control to your program:

- GPR 15 (and *retcode*, if you coded RETCODE) contains a return code.
- When the value in GPR 15 is not zero, GPR 0 (and *rsncode*, if you coded RSNCODE) contains reason code.

See return codes under REQUEST=ALLOCATE option of IEFPRMLB.

Examples

None.

Chapter 55. IEFSSI – Dynamically query a subsystem

Description

Use the IEFSSI macro to dynamically query a subsystem. The REQUEST=QUERY parameter allows an application to query the following information for all subsystems defined to the SSI:

- The subsystem name
- If the subsystem is dynamic or not dynamic
- If the subsystem is the primary subsystem
- If the subsystem is active or inactive
- If the subsystem is dynamic, whether it accepts or rejects the SETSSI command
- If the subsystem is active, which function codes it supports.
- The number of vector tables associated with the subsystem, with a maximum of two vector tables.
- The following information for each associated vector table:
 - If the vector table is managed by the SSI. A vector table managed by the SSI is a vector table created with the IEFSSVT REQUEST=CREATE macro.
 - A locator. This locator is a token if the vector table is managed by the SSI and is an address if the vector table is not managed by the SSI.
 - If the vector table is active
 - The function codes supported by the vector table

This information represents a snapshot of the subsystems defined to the SSI when you process the query request.

To obtain information about the primary subsystem without knowing its name, use the query request and specify a subsystem name of '!PRI'.

Environment

The requirements for the caller are:

Environmental factor	Requirement
Minimum authorization:	For the QUERY request, problem state with any PSW key.
Dispatchable unit mode:	Task
Cross memory mode:	PASN=HASN=SASN
AMODE:	24-bit or 31-bit
ASC mode:	Primary or Access register (AR)
Interrupt status:	Enabled for I/O and external interrupts
Locks:	No locks held
Control parameters:	Control parameters must be in the primary address space.

Programming requirements

- Include the CVT and IEFJESCT mapping macros in your program.
- Include the IEFJSRC mapping macro in your program. This macro defines the dynamic SSI return and reason codes.

IEFSSI macro

- Include the IEFJSQRY macro to map the REQUEST=QUERY output.

Restrictions

The caller must not have established an EUT FRR.

Input register information

Before issuing the IEFSSI macro, the caller does not have to place any information into any register unless using it in register notation for a particular parameter, or using it as a base register.

Output register information

When control returns to the caller, the GPRs contain:

Register

Contents

0

Reason code

1

Used as a work register by the system

2-13

Unchanged

14

Used as a work register by the system

15

Return code

When control returns to the caller, the ARs contain:

Register

Contents

0-1

Used as a work register by the system

2-13

Unchanged

14-15

Used as a work register by the system

Some callers depend on register contents remaining the same before and after issuing a service. If the system changes the contents of registers on which the caller depends, the caller must save them before issuing the service, and restore them after the system returns control.

Performance implications

None.

REQUEST=QUERY parameter of IEFSSI

The IEFSSI macro with the QUERY parameter requests information about subsystems defined to the system.

Syntax for REQUEST=QUERY

The syntax of the IEFSSI REQUEST=QUERY macro is written as follows:

Syntax	Description
<i>name</i>	<i>name</i> : symbol. Begin <i>name</i> in column 1.
␣	One or more blanks must precede IEFSSI.
IEFSSI	
␣	One or more blanks must follow IEFSSI.
SUBNAME= <i>subname</i>	<i>subname</i> : RS-type address or register (2) - (12).
,REQUEST=QUERY	
,WORKAREA= <i>workarea</i>	<i>workarea</i> : RS-type address or register (2) - (12) of an output area.
,WORKASP= <i>workasp</i>	<i>workasp</i> : RS-type address or register (2) - (12) of an input area.
,PLISTVER=IMPLIED_VERSION	
,PLISTVER=MAX	Default: IMPLIED_VERSION
,PLISTVER= <i>plistver</i>	<i>plistver</i> : 1
,RETCODE= <i>retcode</i>	<i>retcode</i> : RS-type address or register (2) - (12). of fullword output variable
,RSNCODE= <i>rsncode</i>	<i>rsncode</i> : RS-type address or register (2) - (12). of fullword output variable
,COM= <i>com</i>	<i>com</i> : comment string
,COM=NULL	Default: COM=NULL
,MF=S	Default: MF=S
,MF=(L, <i>list addr</i>)	
,MF=(L, <i>list addr,attr</i>)	
,MF=(L, <i>list addr,OD</i>)	
,MF=(E, <i>list addr</i>)	
,MF=(E, <i>list addr,COMPLETE</i>)	

Syntax	Description

Parameters for REQUEST=QUERY

The parameters are explained as follows:

SUBNAME=*subname*

A required parameter that specifies the field (or an address in a register) containing the 4-character subsystem name. It must be the name of a subsystem that has been previously defined to the system using SSI services.

This field must be padded to the right with blanks or nulls if it is less than 4 characters long.

For the REQUEST=QUERY parameter, the subsystem name may contain the wildcard characters '*' and '?' to request information about multiple subsystems. The meanings for the wildcard characters are:

Matches 0 or more characters.

Use a SUBNAME parameter value of '*' to indicate that information is to be returned for all subsystems.

?

Matches exactly 1 character

Use a SUBNAME parameter value of '!PRI' to indicate that information is to be returned for the primary subsystem.

,REQUEST=QUERY

A parameter that specifies the request to obtain information about a currently defined subsystem named in the SUBNAME parameter.

The output from IEFSSI REQUEST=QUERY is mapped by the IEFJSQRY macro. Subsystems are listed in broadcast order, that is, the order in which they receive broadcast SSI requests.

,WORKAREA=*workarea*

A required parameter that specifies a name (or register containing the address) of a pointer output field that contains the address of the subsystem information returned by the QUERY request.

The output area is mapped by the IEFJSQRY macro. The JQRYLEN field contains the length of the output area.

,WORKASP=*workasp*

An optional parameter that specifies a name (or register containing the address) of a one-byte input field that specifies the subpool that the SSI uses to obtain a work area for the returned subsystem information. The caller is responsible for freeing this work area.

IBM recommends that you use a job-related or task-related subpool. This allows the system to free the associated storage when the job or task ends, if the caller does not free the returned area.

If WORKASP is not specified, the caller's subpool zero is used. Storage for the query information is obtained above 16 megabytes. AMODE 24 callers must switch into AMODE 31 to address this storage. Unauthorized callers may request storage only in the following unauthorized subpools:

- 0-127
- 131
- 132

,PLISTVER=IMPLIED_VERSION**,PLISTVER=MAX****,PLISTVER=*plistver***

Specifies the version of the macro. PLISTVER determines which parameter list the system generates. PLISTVER is an optional input parameter on all forms of the macro, including the list form. When using PLISTVER, specify it on all macro forms used for a request and with the same value on all of the macro forms. The values are:

IMPLIED_VERSION

The lowest version that allows all parameters specified on the request to be processed. If you omit the PLISTVER parameter, IMPLIED_VERSION is the default.

MAX

The largest size parameter list currently possible. This size might grow from release to release and affect the amount of storage that your program needs.

If you can tolerate the size change, IBM recommends that you always specify PLISTVER=MAX on the list form of the macro. Specifying MAX ensures that the list-form parameter list is always long enough to hold all the parameters you might specify on the execute form; in this way, MAX ensures that the parameter list does not overwrite nearby storage.

1

The currently available parameters.

To code, specify in this input parameter one of the following:

- IMPLIED_VERSION
- MAX
- A decimal value of 1

,RETCODE=*retcode*

An optional 4-byte parameter that specifies the name of an output field (or a register) where the system places the return code. The return code is copied from general purpose register 15.

,RSNCODE=*rsncode*

An optional 4-byte parameter that specifies the name of an output field (or a register) where the system places the reason code. The reason code is copied from general purpose register 0.

,COM=*com***,COM=NULL**

An optional parameter that specifies the character input that appears in the block comment before the macro invocation. Use it to make comments about the macro invocation. The comment must be enclosed in quotation marks if it contains any lower case characters. The default is NULL.

,MF=S**,MF=(L,*list addr*)****,MF=(L,*list addr*,*attr*)****,MF=(L,*list addr*,OD)****,MF=(E,*list addr*)****,MF=(E,*list addr*,COMPLETE)**

Use MF=S to specify the standard form of the IEFSSI macro, which builds an in-line parameter list and generates the macro invocation to transfer control to the service.

Use MF=L to specify the list form of the IEFSSI macro. Use the list form together with the execute form of the macro for applications that require reentrant code. The list form defines an area of storage that the execute form uses to store the parameters. No other parameters may be coded with the list form of the macro.

Use MF=E together with the list form of the macro for applications that require reentrant code. The execute form of the IEFSSI macro stores the parameters into the storage area defined by the list form and generates the macro invocation to transfer control to the service.

,*list addr*

A required parameter that specifies the name of a storage area for the parameter list.

IEFSSI macro

,attr

An optional 1- to 60-character input string that contains any value that is valid on an assembler DS pseudo-op. You can use this parameter to force boundary alignment of the parameter list. If you do not code *attr*, the system provides a value of 0D, which forces the parameter list to a doubleword boundary.

,COMPLETE

An optional parameter that specifies that the system checks for required parameters and supply defaults for omitted optional parameters. This is the default parameter.

ABEND codes

An invocation of the IEFSSI macro may result in an abend code X'8C5'. See [z/OS MVS System Codes](#) for an explanation of this abend code.

Return and reason codes

When the IEFSSI macro returns control to your program, GPR 15 (and *retcode*, if you coded RETCODE) contains a return code. When the value in GPR 15 is not 0, GPR 0 (and *rsncode* if you coded RSNCODE) contains the reason code.

The IEFJSRC mapping macro provides equate symbols for the return and reason codes. The equate symbols associated with each Return Code are:

Decimal (Hex)

Equate Symbols

00 (00)

IEFSSI_SUCCESS

04 (04)

IEFSSI_WARNING

08 (08)

IEFSSI_INVALID_PARAMETERS

12 (0C)

IEFSSI_REQUEST_FAIL

20 (14)

IEFSSI_SYSTEM_ERROR

24 (18)

IEFSSI_UNAVAILABLE

The following table contains return and reason codes, the equate symbols associated with each reason code and the meaning and suggested action for each return and reason code.

Return Code decimal (hex)	Reason Code decimal (hex)	Meaning and Action
00 (00)	00 (00)	Equate Symbol: IEFSSI_FUNCTIONS_COMPLETE Meaning: The request completed successfully. The result depends on the request: <ul style="list-style-type: none">• QUERY — Information for all subsystems defined to the SSI has been queried Action: None.

Table 28. Return and Reason Codes for the IEFSSI Macro (continued)		
Return Code decimal (hex)	Reason Code decimal (hex)	Meaning and Action
04 (04)	900 (384)	<p>Equate Symbol: IEFSSI_QUERY_INCOMPLETE</p> <p>Meaning: The data returned by the QUERY request may be incomplete. This is a QUERY request error.</p> <p>Action: Check the JQRY_INCOMPLETE flag for each subsystem that was queried.</p>
08 (08)	00 (000)	<p>Equate Symbol: IEFSSI_SUBSYSTEM_UNKNOWN</p> <p>Meaning: The subsystem is not defined to the SSI.</p> <p>Action: Correct the subsystem name or define a subsystem with either the IEFSSI macro or the SETSSI command.</p>
08 (08)	12 (00C)	<p>Equate Symbol: IEFSSI_INVALID_NAME</p> <p>Meaning: The subsystem name or the routine name contains characters that are not valid.</p> <p>Action: Correct the subsystem name by removing the characters that are not valid.</p>
12 (0C)	900 (384)	<p>Equate Symbol: IEFSSI_QUERY_STORAGE</p> <p>Meaning: Unable to obtain storage for an output of the QUERY request.</p> <p>Action: Check the current use of the system storage to determine why storage was not available. Retry the request later in case storage has become available. See <i>z/OS MVS Programming: Authorized Assembler Services Reference EDT-IXG</i> for more information on the IEFSSI macro.</p>
20 (14)	—	<p>Equate Symbol: IEFSSI_SYSTEM_ERROR</p> <p>Meaning: System error</p> <p>Action: Investigate the following possible causes:</p> <ul style="list-style-type: none"> • Inability to obtain a system resource • Abnormal task termination <p>Obtain the system dump, if any, and contact the IBM support center.</p>
24 (18)	—	<p>Equate Symbol: IEFSSI_UNAVAILABLE</p> <p>Meaning: The IEFSSI macro has been invoked too early during system initialization.</p> <p>Action: Delay the invocation of the IEFSSI macro to a later point in the IPL.</p>

Example

Obtain subsystem information for any subsystem whose name begins with 'JES' and free the storage returned by the system.

```
IEFSSI REQUEST=QUERY, SUBNAME=SNAME,           X
      WORKAREA=WAREA,                          X
      RETCODE=RETURN_CODE, RSNCODE=REASON_CODE
```

IEFSSI macro

```
:
L      R5, WAREA
USING  JQRY_HEADER, R5
L      R0, JQRYLEN
STORAGE RELEASE, LENGTH=(0), ADDR=(R5)
:
SNAME  DC      CL4 'JES*'
WAREA  DS      A
       IEFJSQRY
```

Chapter 56. IOCINFO – Obtain MVS I/O configuration information

Description

Use the IOCINFO macro to obtain the following I/O configuration information:

- I/O configuration token
- Default channel subsystem identifier for the logical partition
- The maximum device measurement block index that is currently assigned
- The I/O facilities that are supported and enabled by the hardware and software.

Environment

The requirements for the caller are:

Environmental factor	Requirement
Minimum authorization:	Problem state, with any PSW key.
Dispatchable unit mode:	Task or SRB
Cross memory mode:	Any PASN, any HASN, any SASN
AMODE:	24- or 31- bit
ASC mode:	Primary or access register (AR)
Interrupt Status:	Enabled or disabled for I/O and external interrupts
Locks:	The caller may hold locks, but is not required to hold any
Control parameters:	Must be in the primary address space or be in an address/data space that is addressable through a public entry on the caller's dispatchable unit access list (DU-AL).

Programming requirements

If in AR mode, specify `SYSSTATE ASCENV=AR` before invoking the macro.

Restrictions

None.

Input register information

Before issuing the IOCINFO macro, the caller does not have to place any information into any register unless using it in register notation for a particular parameter, or using it as a base register.

Output register information

When control returns to the caller, the general purpose registers (GPRs) contain:

Register	Contents
-----------------	-----------------

IOCINFO macro

0

Reason code if GPR 15 contains a return code of 08; otherwise, used as a work register by the system

1

Used as a work register by the system

2-13

Unchanged

14

Used as a work register by the system

15

Return code

When control returns to the caller, the access registers (ARs) contain:

Register

Contents

0-1

Used as work registers by the system

2-13

Unchanged

14-15

Used as work registers by the system

Performance implications

None.

Syntax

The standard form of the IOCINFO macro is written as follows:

Syntax	Description
<i>name</i>	<i>name</i> : symbol. Begin <i>name</i> in column 1.
␣	One or more blanks must precede IOCINFO.
IOCINFO	
␣	One or more blanks must follow IOCINFO.
IOCTOKEN= <i>ioctoken addr</i>	<i>ioctoken addr</i> : RX-type address or register (2) - (12).
,DCMINFO= <i>xdcminfo</i>	<i>xdcminfo</i> : RS-type address or register (2) - (12).
,CSSID= <i>cssid addr</i>	<i>cssid addr</i> : RX-type address or register (2) - (12).
,MAXMBI= <i>maxmbi addr</i>	<i>maxmbi addr</i> : RS-type address or register (2) - (12).

Syntax	Description
,IOFACILITIES= <i>iofc addr</i>	<i>iofc addr</i> : RX-type address or register (2) - (12).
,IODFINFO= <i>xiodfinfo</i>	<i>xiodfinfo</i> : RS-type address or register (2) - (12).
,RETCODE= <i>retcode addr</i>	<i>retcode addr</i> : RX-type address or register (2) - (12).
,RSNCODE= <i>rsncode addr</i>	<i>rsncode addr</i> : RX-type address or register (2) - (12).
,PLISTVER= <i>xplistver</i>	
,PLISTVER=IMPLIED_VERSION	Default: IMPLIED_VERSION

Parameters

The parameters are explained as follows:

IOCTOKEN=*ioctoken addr*

Specifies the address of a 48-character area where the system returns the current MVS I/O configuration token.

,DCMINFO=*xdcminfo*

Specifies the address of an optional 32 character output area into which IOCINFO is to return Dynamic Channel Path Management (DCM) information which can be mapped by IOSDDCMI.

,CSSID=*cssid addr*

Specifies the address of a one byte output area where the system returns the default channel subsystem ID for the logical partition.

- A return code of X'00', reason code of X'00' indicates that the program is running on a processor that supports multiple channel subsystems.
- A return code of X'00', reason code X'01' indicates that the program is running on a processor that does not support multiple channel subsystems, and the CSS ID assigned is a zero.

,MAXMBI=*maxmbi addr*

Specifies the address of a halfword field where the system returns the maximum device measurement block index that is currently assigned.

,IOFACILITIES=*iofc addr*

Specifies the address of a required 256-byte output area into which the IOCINFO service returns the I/O facility information. This area is mapped by mapping macro IOSDIOFC.

,IODFINFO=*xiodfinfo*

Specifies the address of an optional 128 character output area into which IOCINFO is to return IODF information which is mapped by IOSDIODI.

,RETCODE=*retcode addr*

Specifies the fullword location where the system is to store the return code. The return code is also in GPR 15.

,RSNCODE=*rsncode addr*

Specifies the fullword location where the system is to store the reason code. The reason code is also in GPR 0.

,PLISTVER=*xplistver*

,PLISTVER=IMPLIED_VERSION

An optional byte input decimal value (with a value of 1) that specifies the macro version. PLISTVER is the only key allowed on the list form of MF and determines which parameter list is generated. Note that MAX may be specified instead of a number, and the parameter list will be of the largest size currently supported. This size may grow from release to release (thus possibly affecting the amount of

storage needed by your program). If your program can tolerate this, IBM recommends that you always specify MAX when creating the list form parameter list as that will ensure that the list form parameter list is always long enough to hold whatever parameters might be specified on the execute form.

The default is IMPLIED_VERSION. When PLISTVER is omitted, the default is the lowest version which allows all of the parameters specified on the invocation to be processed.

ABEND codes

None.

Return and reason codes

When the system returns control to the caller, GPR 15 (and *retcode addr*, if you coded RETCODE) contains the return code. For return code X'08', the reason code is in GPR 0 (and *rsncode addr*, if you coded RSNCODE).

Hexadecimal Return Code	Hexadecimal Reason Code	Meaning and Action
00		Meaning: Successful completion. Action: None.
00	00	Meaning: Successful completion from a CSSID parameter request. The program is running on a processor that supports multiple channel subsystems. Action: None.
00	01	Meaning: Successful completion from a CSSID parameter request. The program is running on a processor that does not support multiple channel subsystems and the CSS ID assigned is a zero. Action: None.
08	01	Meaning: Program error. An ALET in the parameter list is not valid. The caller might have inadvertently written over an area in the parameter list. Action: Check to see if your program inadvertently overlaid the parameter list generated by the macro.
08	02	Meaning: Program error. The system could not access the caller's parameter list. Action: Check to see if your program inadvertently overlaid the parameter list generated by the macro.
08	05	Meaning: Program error. An error occurred when the system referenced the user-supplied area specified in the IOCTOKEN parameter. Action: Check to see if your program correctly specified the IOCTOKEN area.
08	09	Meaning: System error. This reason code is for IBM diagnostic purposes only. Action: Record the reason code and supply it to the appropriate IBM support personnel.

Hexadecimal Return Code	Hexadecimal Reason Code	Meaning and Action
08	0F	<p>Meaning: An error occurred referencing the user-supplied area that is specified in the IOFACILITIES parameter.</p> <p>Action: Check to see if your program correctly specified the IOFACILITIES area.</p>
20		<p>Meaning: System error. This return code is for IBM diagnostic purposes only.</p> <p>Action: Record the return code and supply it to the appropriate IBM support personnel.</p>
24	07	<p>Meaning: Program error. The system does not support the specified parameter.</p> <p>Action: Check the parameters on the IOCINFO macro to make sure they are valid on your release of the system.</p>

IOCINFO—List form

Use the list form of the IOCINFO macro together with the execute form of the macro for applications that require reentrant code. The list form of the macro defines an area of storage, which the execute form of the macro uses to contain the parameters.

Syntax

The list form of the IOCINFO macro is written as follows:

Syntax	Description
<i>name</i>	<i>name</i> : symbol. Begin <i>name</i> in column 1.
IOCINFO	
MF=(L, <i>list addr</i>)	<i>list addr</i> : Symbol.
MF=(L, <i>list addr</i> , <i>attr</i>)	<i>attr</i> : 1- to 60- character input string
MF=(L, <i>list addr</i> ,0D)	Default: 0D

Parameters

The parameters are explained under the standard form of the IOCINFO macro with the following exception:

IOCINFO macro

MF=(L,*list addr*)

MF=(L,*list addr*,*attr*)

MF=(L,*list addr*,0D)

Specifies the list form of the IOCINFO macro.

list addr is the name of a storage area to contain the parameters.

attr is an optional 1- to 60-character input string, which can contain any value that is valid on an assembler DS pseudo-op. You can use this parameter to force boundary alignment of the parameter list. If you do not code *attr*, the system provides a value of 0D, which forces the parameter list to a doubleword boundary.

IOCINFO - Execute form

Use the execute form of the IOCINFO macro together with the list form of the macro for applications that require reentrant code. The execute form of the macro stores the parameters into the storage area defined by the list form.

Syntax

The execute form of the IOCINFO macro is written as follows:

Syntax	Description
<i>name</i>	<i>name</i> : symbol. Begin <i>name</i> in column 1.
␣	One or more blanks must precede IOCINFO.
IOCINFO	
␣	One or more blanks must follow IOCINFO.
IOCTOKEN= <i>ioctoken addr</i>	<i>ioctoken addr</i> : RX-type address or register (2) - (12).
,CSSID= <i>cssid addr</i>	<i>cssid addr</i> : RS-type address or register (2) - (12).
,MAXMBI= <i>maxmbi addr</i>	<i>maxmbi addr</i> : RS-type address or register (2) - (12).
,IOFACILITIES= <i>iofc addr</i>	<i>iofc addr</i> : RS-type address or register (2) - (12).
,RETCODE= <i>retcode addr</i>	<i>retcode addr</i> : RX-type address or register (2) - (12).
,RSNCODE= <i>rsncode addr</i>	<i>rsncode addr</i> : RX-type address or register (2) - (12).
,MF=(E, <i>list addr</i>)	<i>list addr</i> : RX-type address or register (2) - (12).
,MF=(E, <i>list addr</i> ,COMPLETE)	Default: COMPLETE

Syntax	Description

Parameters

The parameters are explained under the standard form of the IOCINFO macro with the following exceptions:

,MF=(E,*list addr*)

,MF=(E,*list addr*,COMPLETE)

Specifies the execute form of the IOCINFO macro.

list addr specifies the area that the system uses to contain the parameters.

COMPLETE, which is the default, specifies that the system is to check for required parameters and supply defaults for omitted optional parameters.

Chapter 57. IOSCHPD – IOS CHPID description service

Description

The IOSCHPD macro returns the acronym, description, attributes, and/or the Worldwide Port Name (WWPN) of a channel path (CHP) or channel path type.

Environment

The requirements for the caller are:

Environmental factor	Requirement
Minimum authorization:	Problem or Supervisor state and any PSW key
Dispatchable unit mode:	Task or SRB
Cross memory mode:	Any PASN, any HASN, any SASN
AMODE:	24- or 31-bit
ASC mode:	Primary or access register (AR).
Interrupt status:	Enabled or disabled for I/O and external interrupts.
Locks:	No locks may be held.
Control parameters:	Must be in the primary address space or be in an address/data space that is addressable through a public entry on the callers dispatchable unit access list (DU-AL).

Programming requirements

None.

Restrictions

The parameter list must be in the caller's primary address space or be addressable via the dispatchable unit access list.

The LINKAGE=BRANCH option is limited to callers which meet the following criteria:

- Supervisor state and key 0
- 31-bit addressing mode
- Primary ASC mode
- Parameter list resides in fixed or DREF storage

Input register information

Before issuing the IOSCHPD macro, the caller does not have to place any information into any register unless using it in register notation for a particular parameter, or using it as a base register.

Output register information

The contents of registers 14 through 1 are altered during processing.

When control returns to the caller, the GPRs contain:

IOSCHPD macro

Register Contents

- 0**
Reason code
- 1**
Unpredictable (Used as a work register by the system)
- 2-13**
Unchanged
- 14**
Unpredictable (Used as a work register by the system)
- 15**
Return code

When control returns to the caller, the ARs contain:

Register Contents

- 0-1**
Unpredictable (Used as work registers by the system)
- 2-13**
Unchanged
- 14-15**
Unpredictable (Used as work registers by the system)

Performance implications

None.

Syntax

The IOSCHPD macro is written as follows:

Syntax	Description
<i>name</i>	<i>name</i> : Symbol. Begin <i>name</i> in column 1.
␣	One or more blanks must precede IOSCHPD.
IOSCHPD	
␣	One or more blanks must follow IOSCHPD.
CHPID= <i>chpid</i>	<i>chpid</i> : RS-type address or register (2) - (12).
,CHP_TYPE= <i>chp_type</i>	<i>chp_type</i> : RS-type address or register (2) - (12).
,CHP_PARM= <i>chp_parm</i>	<i>chp_type</i> : RS-type address or register (2) - (12).
,CHP_PARM= <u>0</u>	Default: 0

Syntax	Description
,ACRONYM= <i>acronym</i>	<i>acronym</i> : RS-type address or register (2) - (12).
,DESC= <i>desc</i>	<i>desc</i> : RS-type address or register (2) - (12).
,ATTR= <i>attr</i>	<i>attr</i> : RS-type address or register (2) - (12).
,WWPN= <i>wwpn</i>	<i>wwpn</i> : RS-type address or register (2) - (12).
,ND= <i>xnd</i>	<i>xnd</i> : Optional 32-character output.
,LINKAGE=SYSTEM	Default: LINKAGE=SYSTEM
,LINKAGE=BRANCH	
,RETCODE= <i>retcode</i>	<i>retcode</i> : RS-type address or register (2) - (12).
,RSNCODE= <i>rsncode</i>	<i>rsncode</i> : RS-type address or register (2) - (12).
,PLISTVER= <u>IMPLIED_VERSION</u>	Default: PLISTVER=IMPLIED_VERSION
,PLISTVER=MAX	
,PLISTVER=1	
,PLISTVER=2	
,MF= <u>S</u>	Default: MF=S
,MF=(L, <i>list addr</i>)	<i>list addr</i> : RS-type address or register (1) - (12).
,MF=(L, <i>list addr,attr</i>)	
,MF=(L, <i>list addr,0D</i>)	
,MF=(E, <i>list addr</i>)	
,MF=(E, <i>list addr,COMPLETE</i>)	

Note: To use the IOSCHPD macro, you need to specify the following parameters:

- Either CHPID or CHP_TYPE
- One or more parameters among ACRONYM, DESC, ATTR, and WWPN

Parameters

The parameters are explained as follows:

name

An optional symbol, starting in column 1, that is the name on the IOSCHPD macro invocation. The name must conform to the rules for an ordinary assembler language symbol.

CHPID=*chpid*

An input parameter which specifies the CHPID number for which to retrieve the attributes, acronym, description, and/or WWPN. This parameter is mutually exclusive with the CHP_TYPE parameter.

If the CHPID is defined as a managed channel path, the description and acronym returned will indicate that the channel path is managed. Otherwise, a non-managed description and acronym will be returned.

To code: Specify the RS-type address, or address in register (2)-(12), of a halfword field that contains a binary value in the range X'0000' to X'00FF'.

CHP_TYPE=*chp_type*

An input parameter which specifies the channel path type for which to retrieve the attributes, acronym, description, and/or WWPN. The channel path type can be obtained by invoking the UCINFO PATHINFO macro and mapping the results with the IOSDPATH mapping macro. (The interface type is in the field called PathIntType). This parameter is mutually exclusive with the CHPID parameter.

To code: Specify the RS-type address, or address in register (2)-(12), of a one-byte field.

CHP_PARM=*chp_parm***CHP_PARM=0**

An optional input parameter, used only with CHP_TYPE=*chp_type* parameter, that specifies the channel path parameter. A value of 1 is the managed option and 0 (the default) is the non-managed option. If 1 is specified, and if the CHP type is managed, the description and acronym returned will indicate that the CHP type is managed.

To code: Specify the RS-type address, or address in register (2)-(12), of a one-byte field.

ATTR=*attr*

An optional parameter, used only with the CHPID parameter, that designates the output area that is to receive the CHPID attributes. The attributes are mapped by mapping macro IOSDCHPD.

To code: Specify the RS-type address, or address in register (2)-(12), of a one-byte field.

,ACRONYM=*acronym*

An optional parameter that designates the output area that is to receive the acronym.

To code: Specify the RS-type address, or address in register (2)-(12), of a 5-character field.

,DESC=*desc*

An optional parameter that designates the output area that is to receive the description.

To code: Specify the RS-type address, or address in register (2)-(12), of a 32-character field.

,WWPN=*wwpn*

An optional parameter, used only with the CHPID parameter, that designates the output area that is to receive the Worldwide Port Name (WWPN). (If the WWPN is not available, zeros will be returned.)

To code: Specify the RS-type address, or address in register (2)-(12), of an 8-character field.

,ND=*xnd*

An optional parameter that designates the output area that is to receive the node descriptor for the channel.

,LINKAGE=SYSTEM**,LINKAGE=BRANCH**

An optional parameter that indicates whether a branch-entry linkage should be generated or a Program Call should be issued for the routine invocation. The default is LINKAGE=SYSTEM.

,LINKAGE=SYSTEM

requests Program Call invocation.

,LINKAGE=BRANCH

requests branch-entry invocation. The LINKAGE=BRANCH option is intended for performance-sensitive invokers or programs that require this function during NIP before a PC can be issued. See RESTRICTIONS for the restrictions on branch-entry invocation.

,RETCODE=retcode

An optional output parameter into which the return code is to be copied from GPR 15.

To code: Specify the RS-type address of a fullword field, or register (2)-(12).

,RSNCODE=rsncode

An optional output parameter into which the reason code is to be copied from GPR 0.

To code: Specify the RS-type address of a fullword field, or register (2)-(12).

,PLISTVER=IMPLIED_VERSION**,PLISTVER=MAX****,PLISTVER=1****,PLISTVER=2**

An optional input parameter that specifies the version of the macro. PLISTVER determines which parameter list the system generates. PLISTVER is an optional input parameter on all forms of the macro, including the list form. When using PLISTVER, specify it on all macro forms used for a request and with the same value on all of the macro forms. The values are:

- **IMPLIED_VERSION**, which is the lowest version that allows all parameters specified on the request to be processed. If you omit the PLISTVER parameter, IMPLIED_VERSION is the default.
- **MAX**, if you want the parameter list to be the largest size currently possible. This size might grow from release to release and affect the amount of storage that your program needs.

If you can tolerate the size change, IBM recommends that you always specify PLISTVER=MAX on the list form of the macro. Specifying MAX ensures that the list-form parameter list is always long enough to hold all the parameters you might specify on the execute form, when both are assembled with the same level of the system. In this way, MAX ensures that the parameter list does not overwrite nearby storage.

- **1**, which supports all parameters except those specifically referenced in higher versions.
- **2**, which supports ATTR and WWPB, in addition to those from version 1.

To code: Specify one of the following:

- IMPLIED_VERSION
- MAX
- A decimal value of 1 or 2

,MF=S**,MF=(L,list addr)****,MF=(L,list addr,attr)****,MF=(L,list addr,OD)****,MF=(E,list addr)****,MF=(E,list addr,COMPLETE)**

An optional input parameter that specifies the macro form.

Use MF=S to specify the standard form of the macro, which builds an inline parameter list and generates the macro invocation to transfer control to the service. MF=S is the default.

Use MF=L to specify the list form of the macro. Use the list form together with the execute form of the macro for applications that require reentrant code. The list form defines an area of storage that the execute form uses to store the parameters. Only the PLISTVER parameter may be coded with the list form of the macro.

Use MF=E to specify the execute form of the macro. Use the execute form together with the list form of the macro for applications that require reentrant code. The execute form of the macro stores the

IOSCHPD macro

parameters into the storage area defined by the list form, and generates the macro invocation to transfer control to the service.

,list addr

The name of a storage area to contain the parameters. For MF=S and MF=E, this can be an RS-type address or an address in register (1)-(12).

,attr

An optional 1- to 60-character input string that you use to force boundary alignment of the parameter list. Use a value of 0F to force the parameter list to a word boundary, or 0D to force the parameter list to a doubleword boundary. If you do not code *attr*, the system provides a value of 0D.

,COMPLETE

Specifies that the system is to check for required parameters and supply defaults for omitted optional parameters.

ABEND codes

None.

Return and reason codes

When the IOSCHPD macro returns control to your program:

- GPR 15 (and *retcode*, when you code RETCODE) contains a return code.
- When the value in GPR 15 is not zero, GPR 0 (and *rsncode*, when you code RSNCODE) reason code.

The following table identifies the hexadecimal return and reason codes:

Hexadecimal return code	Reason codes, meaning, and action
00	The requested information has been returned.

Table 29. Return and reason codes for the IOSCHPD macro (continued)

Hexadecimal return code	Reason codes, meaning, and action
04	<p>The requested information has not been returned. Unless indicated differently in the following list of reason codes, all of the output areas for the information to be returned have been set to zeros.</p> <p>Reason code Meaning</p> <p>00 The system could not determine the CHP type from the input CHPID.</p> <p>01 The input CHPID is not configured.</p> <p>02 The CHP type obtained from the input CHPID is not valid.</p> <p>03 The input CHP type is invalid.</p> <p>04 The input CHP_PARM is invalid.</p> <p>05 The managed option (1) was specified for the CHP_PARM, but the CHP type is one that does not support dynamic channel path management. The default acronym and/or description is returned.</p> <p>07 The input CHPID value is invalid. The value must be in the range X'0000' to X'00FF'.</p>
06	<p>The system was unable to obtain the requested information from the channel subsystem for this CHPID or the processor does not support returning the requested information.</p>
08	<p>Error in caller's parameters.</p> <p>Reason code Meaning</p> <p>01 The caller specified an invalid ALET.</p> <p>02 An error occurred in accessing the caller's parameter list.</p> <p>03 A keyword that is not allowed to be specified with CHP_TYPE was specified; the keyword is only allowed when CHPID is specified. For instance, ATTR may only be specified when CHPID is specified.</p>
0C	<p>Recovery was entered.</p>
20	<p>Recovery was entered.</p>

Chapter 58. IOSCUMOD – IOS control unit entry build service

Description

IOSCUMOD is a prototype module, to be used by manufacturers for creating an IOSTnnn load module and for building the control unit model table.

Programming requirements

On the first invocation of the IOSCUMOD macro, it includes the parameters listed below in the manufacturer's module.

Restrictions

None.

Performance implications

None.

Syntax

The IOSCUMOD macro is written as follows:

Syntax	Description
<i>name</i>	<i>name</i> : Symbol. Begin <i>name</i> in column 1.
␣	One or more blanks must precede IOSCUMOD.
IOSCUMOD	
␣	One or more blanks must follow IOSCUMOD.
MANF= <i>chpid</i>	<i>manf</i> : Symbol up to 3 characters long.
,DEVT= <i>devt</i>	<i>devt</i> : Symbol up to 6 characters long.
,MODN= <i>devt</i>	<i>modn</i> : Symbol up to 3 characters long.
,MASK1= <i>mask1</i>	<i>mask1</i> : 2-byte hex symbol.

Syntax	Description
,MASK2= <i>mask2</i>	<i>mask2</i> : 2-byte hex symbol.
,MASK3= <i>mask3</i>	<i>mask3</i> : 2-byte hex symbol.
,MASK4= <i>mask4</i>	<i>mask4</i> : 2-byte hex symbol.
,DCM_SUPPORTED= <u>YES</u>	Default: YES
,DCM_SUPPORTED=NO	

Parameters

The parameters are explained as follows:

name

An optional symbol, starting in column 1, that is the name on the IOSCUMOD macro invocation. The name must conform to the rules for an ordinary assembler language symbol.

MANF=*manf*

Manufacturer ID that was provided with the node descriptor.

,DEVT=*devt*

Device type ID that was provided with the node descriptor. If a 4-character device type is entered, the two leading fields will be set to blanks.

,MODN=*modn*

Model number ID that was provided with the node descriptor. If NULL, then the model field will be set to all blanks. Otherwise, leading zeroes must be coded.

,MASK1=*mask1*

,MASK2=*mask2*

,MASK3=*mask3*

,MASK4=*mask4*

Hex equivalent of the masks defined. 4 hex digits must be provided.

The tag field of the node descriptor uniquely identifies the power/service boundaries of most control units. Although this is true in most cases, it is not architected that way, and different control units represent this information in different ways.

In order to be able to interpret a control units tag, each control unit will provide four 2-byte masks.

Each 2 byte mask will be ANDed against the tag field of the control unit's Node Descriptor to extract a unique indicator of the different service boundary in the control unit. The first (high order) mask will indicate the most significant single point of failure to avoid (For example, Cluster), the second mask will indicate the most significant single failure to avoid (e.g. I/O bay), and so on until the fourth mask.

There is no requirement for the masks to represent specific components of the control (e.g. Cluster vs. I/O Bay vs. Port card). The only requirement is that the masks are ordered from the most significant point of failure to least. If not all four masks are significant, they should be set to binary zeros and must be the last mask(s) of the four.

,DCM_SUPPORTED=YES

,DCM_SUPPORTED=NO

Indicates that the control unit does or does not support dynamic channel path management. Control units which support ESCON interfaces and are completely non-synchronous should be capable of being supported by DCM. Control units which transfer data synchronously from the media, or remain connected to the channel while waiting for data to transfer between the media and the cache (or channel), are not supported. The default is YES.

ABEND codes

None.

Return and reason codes

None.

System macros require High Level Assembler. For more information about assembler language programming, see [High Level Assembler and Toolkit Feature in IBM Documentation \(www.ibm.com/docs/en/hla-and-tf/1.6\)](http://www.ibm.com/docs/en/hla-and-tf/1.6).

Using this information also requires you to be familiar with the operating system and the services that programs running under it can invoke.

Chapter 59. IOSSCM – Storage class memory information

Description

The IOSSCM macro retrieves storage class memory (SCM) related information, such as the number of SCM resources and performance statistics.

Environment

The requirements for the caller are:

Environmental factor	Requirement
Minimum authorization:	For LINKAGE=SYSTEM, problem state and any PSW key.
Dispatchable unit mode:	Task or SRB mode
Cross memory mode:	Any PASN, any HASN, any SASN
AMODE:	31-bit or 64-bit If in AMODE 64, specify SYSSTATE AMODE64=YES before invoking this macro.
ASC mode:	Primary
Interrupt status:	Enabled for I/O and external interrupts
Locks:	None
Control parameters:	Control parameters must be in the primary address space. For LINKAGE=BRANCH, the parameter list (including any data areas pointed to by the parameter list) must reside in fixed or DREF storage.

Programming requirements

None.

Restrictions

None.

Input register information

Before issuing the IOSSCM macro, the caller does not have to place any information into any general purpose register (GPR) or access register (AR) unless using it in register notation for a particular parameter, or using it as a base register.

Output register information

When control returns to the caller, the GPRs contain:

Register
Contents

0
Reason code if GPR15 is not 0

IOSSCM macro

1

Used as a work register by the system

2-13

Unchanged

14

Used as a work register by the system

15

Return code

When control returns to the caller, the ARs contain:

Register

Contents

0-1

Used as work registers by the system

2-13

Unchanged

14-15

Used as work registers by the system

Some callers depend on register contents remaining the same before and after issuing a service. If the system changes the contents of registers on which the caller depends, the caller must save them before issuing the service, and restore them after the system returns control.

Performance implications

None.

Syntax

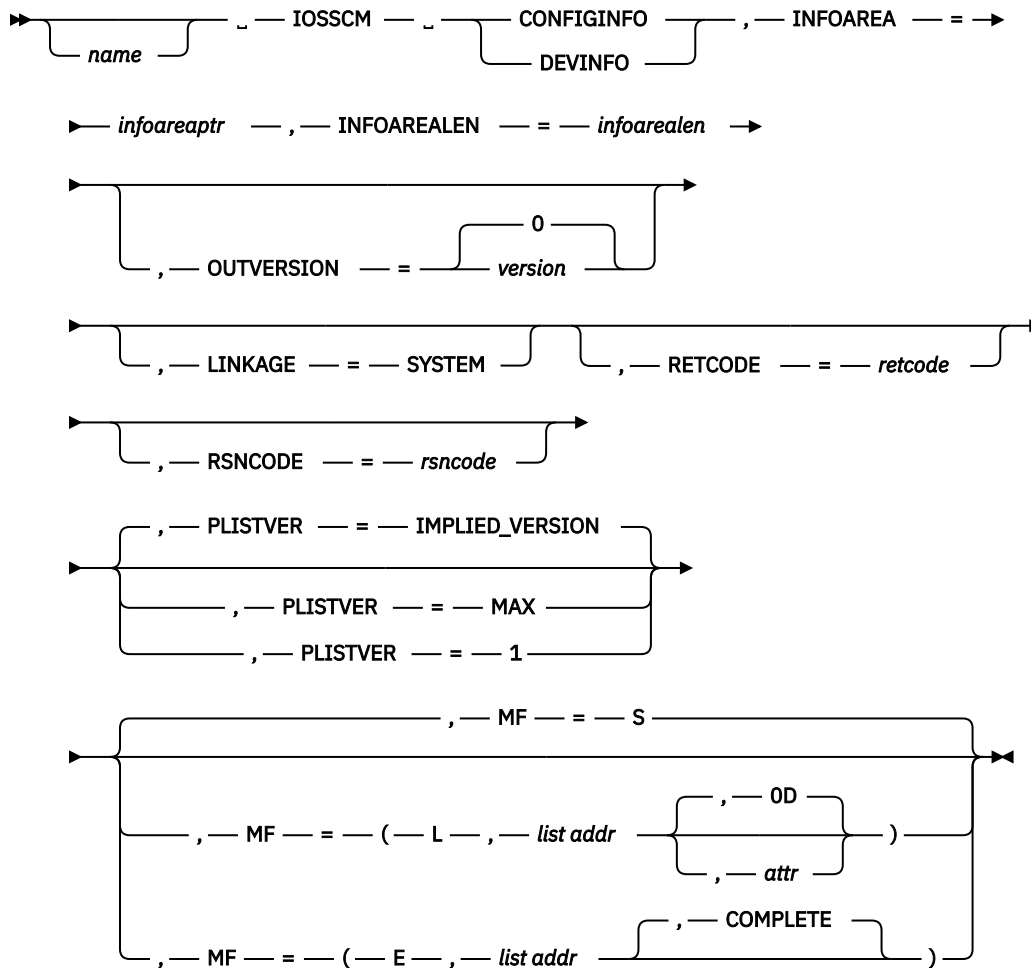

Parameters

The parameters are explained as follows:

name

An optional symbol, starting in column 1, that is the name on the IOSSCM macro invocation. The name must conform to the rules for an ordinary assembler language symbol.

CONFIGINFO

DEVINFO

Specifies the type of SCM information to be returned.

CONFIGINFO

Requests that SCM configuration information be returned. SCM configuration information includes the number of SCM resource parts and the size of an SCM measurement block.

DEVINFO

Requests that SCM device (subchannel) information be returned. SCM device information includes I/O statistics for requests that were issued to each SCM device. Note that the SCM device or subchannel is not associated with a specific Flash Express feature pair; any SCM device can be used to perform I/O to any Flash Express feature pair.

,INFOAREA=infoareaptr

On a **CONFIGINFO** request, *infoareaptr* specifies the name (RS-type), or address in register (2) - (12), of a required 8-byte input that contains the address of an area which is to receive the configuration

information. The area must be addressable in the primary address space. The returned **INFOAREA** data is mapped by the IOSDSCCI macro.

On a **DEVINFO** request, *infoareaptr* specifies the name (RS-type), or address in register (2) - (12), of a required 8-byte input that contains the address of an area which is to receive the device information. The area must be addressable in the primary address space. The returned **INFOAREA** data is mapped by the IOSDSCDI macro.

,INFOAREALEN=*infoarealen*

On a **CONFIGINFO** request, *infoarealen* specifies the name (RS-type), or address in register (2) - (12), of a required 4-byte input/output area that contains the length of the configuration information area. If the information area is not large enough to contain all of the data for the requested output version, IOSSCM returns a program error and this field will be updated with the required length.

On a **DEVINFO** request, *infoarealen* specifies the name (RS-type), or address in register (2) - (12), of a required 4-byte input/output area that contains the length of the device information area. The area must be large enough to contain the returned information for each SCM device or subchannel. You can issue a IOSSCM CONFIGINFO request to obtain the number of SCM devices or subchannels. If the information area is not large enough to contain all of the data for the requested output version, IOSSCM returns a program error and this field will be updated with the required length.

,LINKAGE=SYSTEM

Optional keyword input that indicates how the service is to be invoked.

SYSTEM

Indicates that a program call (PC) is to be issued.

,OUTVERSION=0

,OUTVERSION=*version*

The name (RS-type), or address in register (2) - (12), of an optional 1-byte input that specifies the output version of the output information to be returned. The output version controls the size and format of the returned information. If you specify an output version that is higher than the highest supported version, the highest supported version is used. The INFOAREA output (mapped by the IOSDSCCI or IOSDSCDI macro) contains the version of the returned information.

Note: Currently, version 0 is the only supported value.

Default: 0

,RETCODE=*retcode*

An optional output parameter into which the return code is to be copied from GPR 15.

To code: Specify the RS-type address of a fullword field, or register (2) - (12).

,RSNCODE=*rsncode*

An optional output parameter into which the reason code is to be copied from GPR 0.

To code: Specify the RS-type address of a fullword field, or register (0) or (2) - (12).

,PLISTVER=IMPLIED_VERSION

,PLISTVER=MAX

,PLISTVER=1

An optional input parameter that specifies the version of the macro. **PLISTVER** determines which parameter list the system generates. **PLISTVER** is an optional input parameter on all forms of the macro, including the list form. When using **PLISTVER**, specify it on all macro forms used for a request and with the same value on all of the macro forms. The values are:

IMPLIED_VERSION

The lowest version that allows all parameters specified on the request to be processed. If you omit the **PLISTVER** parameter, **IMPLIED_VERSION** is the default.

MAX

Specifies that you want the parameter list to be the largest size currently possible. This size might grow from release to release and affect the amount of storage that your program needs.

If your program can tolerate the size change, IBM recommends that you always specify `PLISTVER=MAX` on the list form of the macro. Specifying `MAX` ensures that the list-form parameter list is always long enough to hold all the parameters you might specify on the execute form, when both are assembled with the same level of the system. In this way, `MAX` ensures that the parameter list does not overwrite nearby storage.

1

Supports all parameters except those specifically referenced in higher versions.

To code: Specify one of the following:

- `IMPLIED_VERSION`
- `MAX`
- A decimal value of 1

,MF=S

,MF=(L,list addr)

,MF=(L,list addr,attr)

,MF=(L,list addr,0D)

,MF=(E,list addr)

,MF=(E,list addr,COMPLETE)

An optional input parameter that specifies the macro form.

Use `MF=S` to specify the standard form of the macro, which builds an inline parameter list and generates the macro invocation to transfer control to the service. `MF=S` is the default.

Use `MF=L` to specify the list form of the macro. Use the list form together with the execute form of the macro for applications that require reentrant code. The list form defines an area of storage that the execute form uses to store the parameters. Only the **PLISTVER** parameter may be coded with the list form of the macro.

Use `MF=E` to specify the execute form of the macro. Use the execute form together with the list form of the macro for applications that require reentrant code. The execute form of the macro stores the parameters into the storage area defined by the list form, and generates the macro invocation to transfer control to the service.

,list addr

The name of a storage area to contain the parameters. For `MF=S` and `MF=E`, this can be an RS-type address or an address in register (1) - (12).

,attr

An optional 1- to 60-character input string that you use to force boundary alignment of the parameter list. Use a value of `0F` to force the parameter list to a word boundary, or `0D` to force the parameter list to a doubleword boundary. If you do not code *attr*, the system provides a value of `0D`.

,COMPLETE

Specifies that the system is to check for required parameters and supply defaults for omitted optional parameters.

ABEND codes

None.

Return and reason codes

When the IOSSCM macro returns control to your program:

- GPR 15 (and *retcode*, when you code **RETCODE**) contains a return code.
- When the value in GPR 15 is not zero, GPR 0 (and *rsncode*, when you code **RSNCODE**) contains a reason code.

Table 30 on page 448 identifies the hexadecimal return and reason codes.

<i>Table 30. Return and reason codes for the IOSSCM macro</i>		
Return code	Reason code	Meaning and action
00	–	Meaning: The IOSSCM macro completed successfully. Action: None.
04	01	Meaning: Warning. The requested output version (OUTVERSION) is not supported. The information area was updated based on the highest supported output version. Action: Examine the output version field in the information area to determine the format of the data that was returned.
08	01	Meaning: Program error. An error occurred when the system attempted to reference the area specified by the INFOAREA parameter. Action: Correct the address specified on the INFOAREA parameter and reissue the macro.
08	02	Meaning: Program error. The system could not access the caller's parameter list. Action: Check to see if your program inadvertently overlaid the parameter list generated by the macro.
08	03	Meaning: Program error. The output area specified by the INFOAREA parameter is not large enough to hold the requested information. The INFOAREALEN field has been updated with the required storage length. Action: Obtain storage for the output information area based on the returned INFOAREALEN value and reissue the macro.
0C	01	Meaning: Environmental error. Storage class memory is not supported on this CPC. Action: None.
0C	02	Meaning: Environmental error. The IOSSCM service is not available. Action: None.
0C	03	Meaning: Environmental error. IOSSCM detected that the caller is not in Primary ASC mode. Action: None.
0C	04	Meaning: Environmental error. IOSSCM detected that the caller is not enabled for I/O interrupts. Action: None.
20	–	Meaning: System error. An unexpected error occurred. Action: Contact IBM Support.

Chapter 60. ISGENQ – Global resource serialization ENQ service

Description

Interface for Global Resource Serialization ENQ OBTAIN and RELEASE requests.

The GRS ENQ service routine is given control from the ISGENQ macro to:

- Obtain a single or multiple ENQs with or without associated device reserves.
- Change a single or multiple existing ENQs.
- Release a single or multiple ENQs.
- Test an obtain request.

This service is intended to replace ENQ, DEQ, and RESERVE.

Environment

The requirements for the caller are:

Environmental factor

Minimum authorization:

Requirement

Problem state. Any PSW key

To use OWNINGTTOKEN, ENQMAX, or when the specified QNAME is one of the authorized QNAMEs, authorization must be one of the following: Supervisor state, PSW key 0-7, or APF authorized.

Note: When an authorized caller issues an OBTAIN request with an unauthorized QNAME, if COND=YES, the request is granted, but a warning return code and the reason ISGENQRsn_UnprotectedQName are given. This is to warn that an unauthorized caller may block the ENQ, or even release the ENQ if running under the owning task. If COND=NO, authorized callers cannot obtain an ENQ on an unprotected resource.

The authorized QNAMEs are:

ADDRFRAG
 ADDRDSN
 ARCENQG
 BWODSN
 SYSCTLG
 SYSDSN
 SYSIEA01
 SYSIEECT
 SYSIEFSD
 SYSIGGV1
 SYSIGGV2
 SYSPSWRD
 SYSVSAM
 SYSVTOC
 SYSZ*

Dispatchable unit mode:

Task

Environmental factor	Requirement
Cross memory mode:	Any PASN, any HASN, any SASN Note: The resulting ENQ is associated with the owning task in the home address space.
AMODE:	31- or 64-bit If in AMODE 64, specify SYSSTATE AMODE64=YES before invoking this macro.
ASC mode:	Primary or access register (AR) If in access register ASC mode, specify SYSSTATE ASCENV=AR before invoking this macro.
Interrupt status:	Enabled for I/O and external interrupts
Locks:	The caller must not be locked.
Control parameters:	Control parameters must be in the primary address space or, for AR-mode callers, must be in an address/data space that is addressable through a public entry on the caller's dispatchable unit access list (DU-AL). The control parameters must be in the same key as the caller. The ECB specified must be in the caller's home address space or in common. The TCB of the owning task (the current task or specified by OWNINGTOKEN) must be in the caller's home address space. If a captured UCB address is specified, the captured UCB must be in the caller's home address space.

Programming requirements

The caller must include the ISGYCON macro to get the return and reason codes.

The caller must include the ISGYENQ macro to get the mappings for the ISGYENQAA, ISGYENQRES, ISGYENQTOKEN, and ISGYENQRETURN tables.

See "Avoiding Interlock" in *z/OS MVS Programming: Assembler Services Guide* to ensure that you are following the required protocols to prevent the interlock.

Restrictions

The caller must not have functional recovery routines (FRRs).

This macro supports multiple versions. Some keywords are unique to certain versions. See the [“,PLISTVER=IMPLIED_VERSION” on page 459](#) parameter description.

Input register information

Before issuing the ISGENQ macro, the caller does not have to place any information into any general purpose register (GPR) or access register (AR) unless using it in register notation for a particular parameter, or using it as a base register.

Output register information

When control returns to the caller, the GPRs contain:

**Register
Contents**

- 0**
Reason code if GPR15 is not 0
- 1**
Used as a work register by the system
- 2-13**
Unchanged
- 14**
Used as a work register by the system
- 15**
Return code

When control returns to the caller, the ARs contain:

**Register
Contents**

- 0-1**
Used as work registers by the system
- 2-13**
Unchanged
- 14-15**
Used as work registers by the system

Some callers depend on register contents remaining the same before and after issuing a service. If the system changes the contents of registers on which the caller depends, the caller must save them before issuing the service, and restore them after the system returns control.

Performance implications

None.

Syntax

ISGENQ syntax

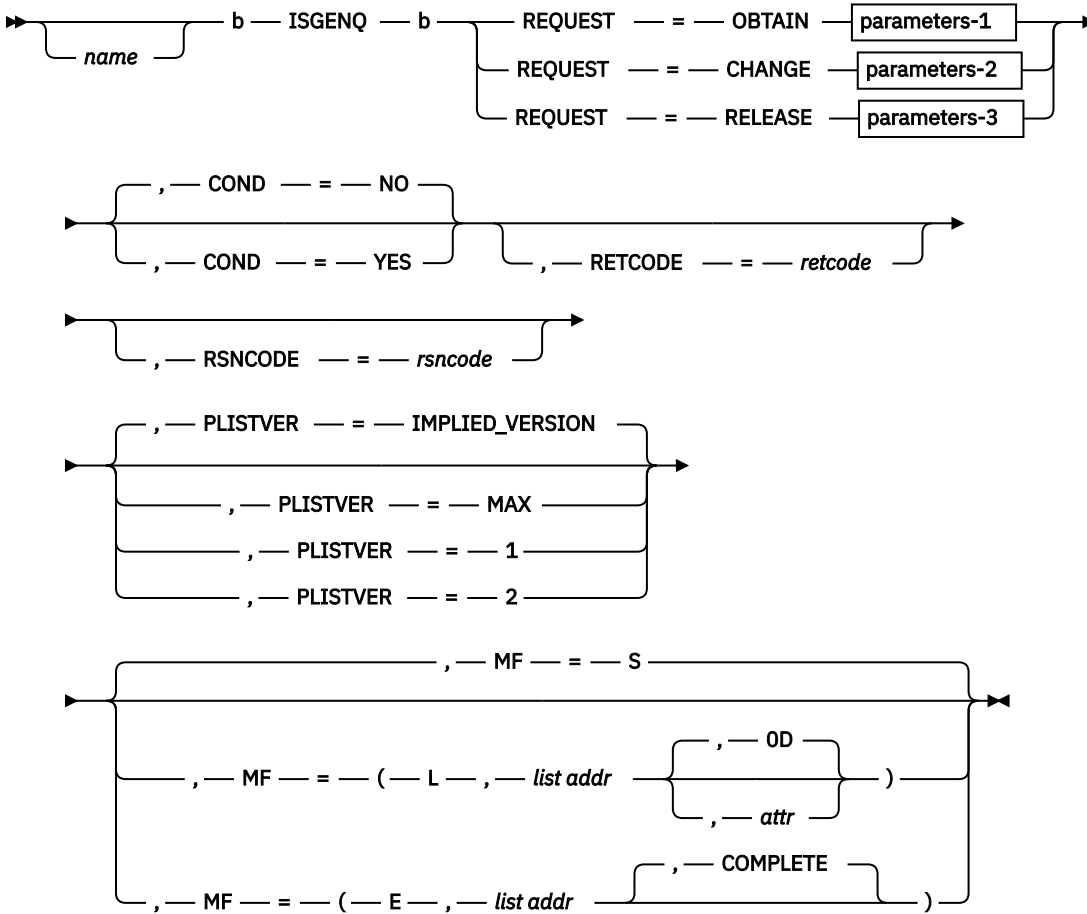

parameters-1

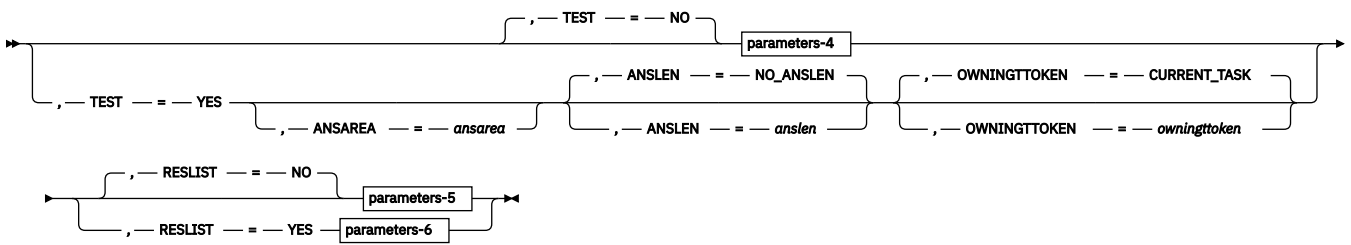

parameters-2

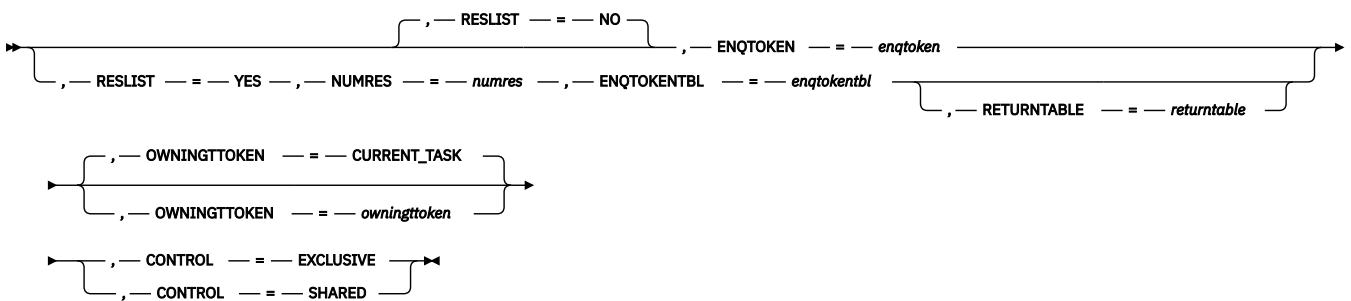

parameters-3

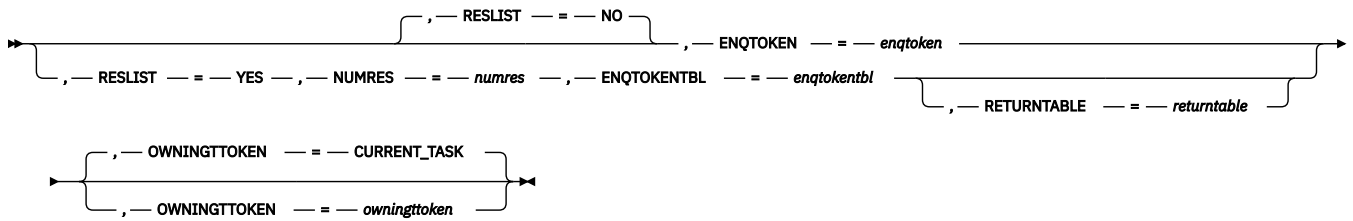

parameters-4

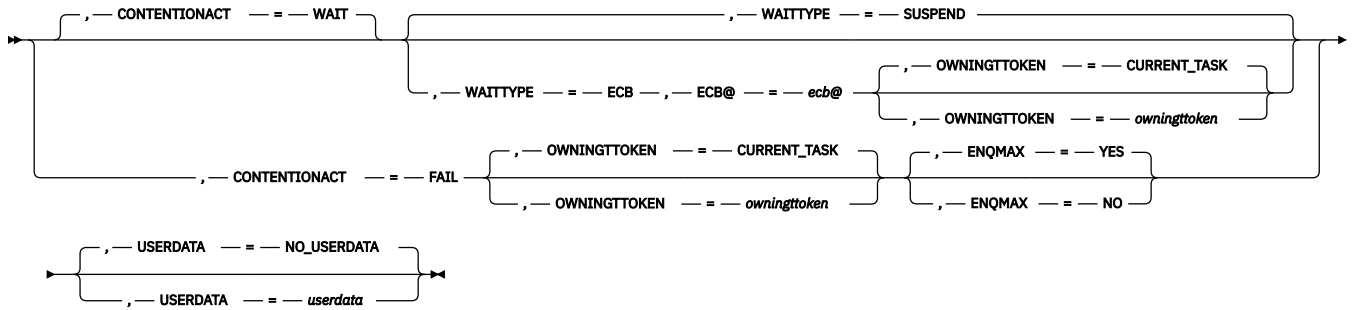

parameters-5

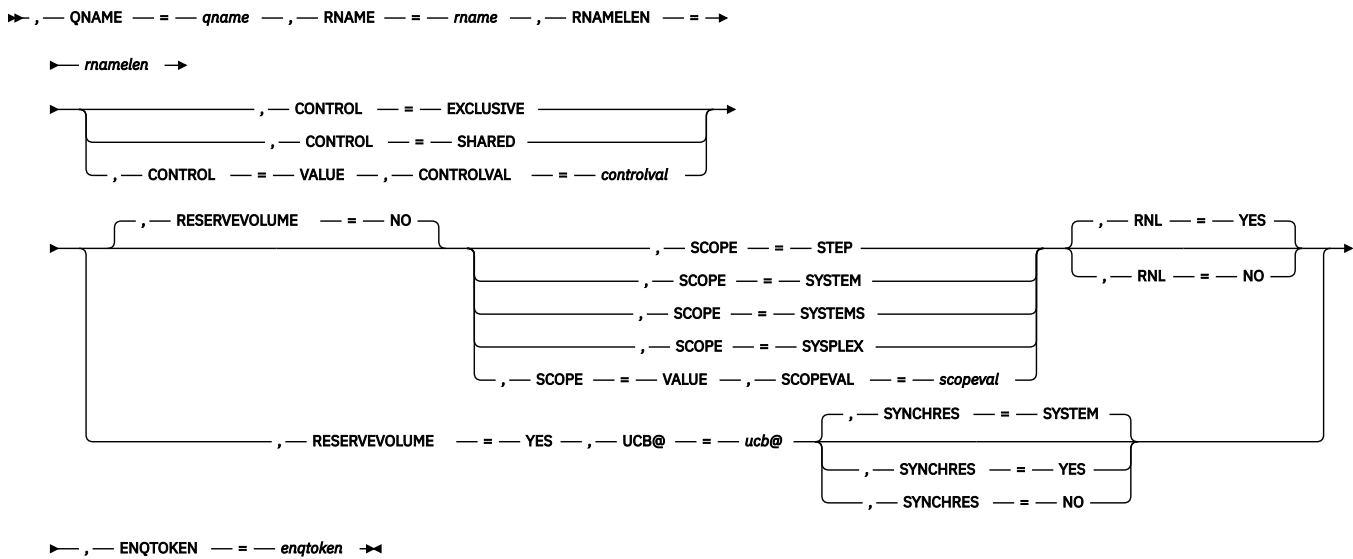

parameters-6

ISGENQ macro

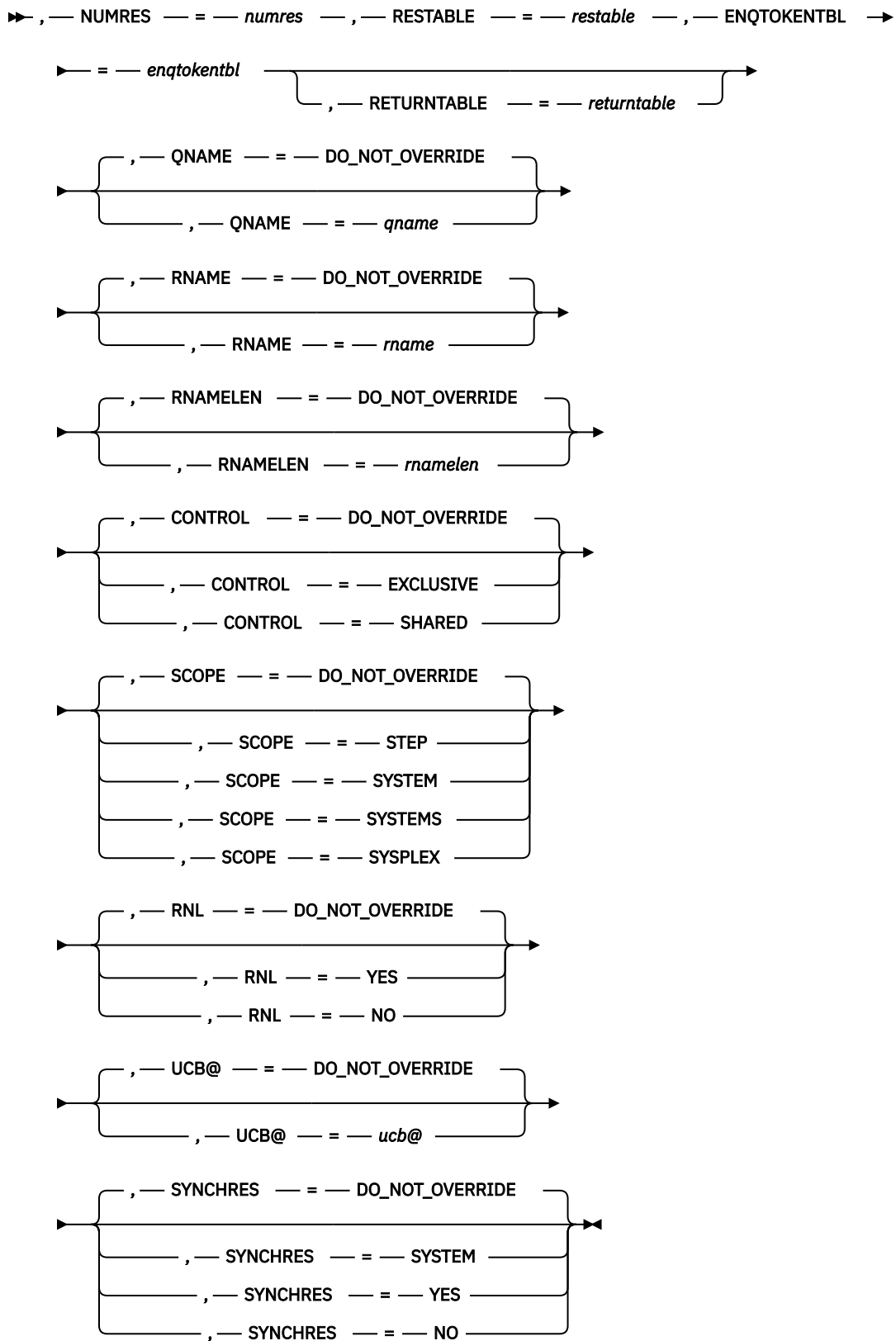

Parameters

The parameters are explained as follows:

name

An optional symbol, starting in column 1, that is the name on the ISGENQ macro invocation. The name must conform to the rules for an ordinary assembler language symbol.

,ANSAREA=ansarea

When TEST=YES and REQUEST=OBTAIN are specified, an optional output parameter, which contains the returned information. The area is a list of records that are mapped by ISGYENQAA in the ISGYENQ macro. For RESLIST=YES, the records are in the same order as the requests in the RESTABLE. ANSLEN is required if ANSAREA is specified.

Note: The answer area is returned only when RC=0 or RC=4.

To code: Specify the RS-type address, or address in register (2)-(12), of a character field.

,ENQMAX=YES**,ENQMAX=NO**

When TEST=NO and REQUEST=OBTAIN are specified, an optional parameter that indicates whether ENQMAX checking should be done. This keyword tells global resource serialization whether a check is to be made to see if the limit for the number of concurrent resource requests has been exceeded. The default is ENQMAX=YES.

,ENQMAX=YES

Indicates ENQMAX checking should be done. IBM suggests that you use the default, ENQMAX=YES, to allow global resource serialization to perform this processing.

,ENQMAX=NO

Indicates that ENQMAX checking should not be used. Use ENQMAX=NO when you have a system-critical ENQ request that should be honored regardless of the concurrent number of resource requests made from the home address space.

Note: ENQMAX=NO can only be specified by an authorized requester and therefore can only override the maximum for authorized requesters.

See [z/OS MVS Planning: Global Resource Serialization](#) for more information.

,ANSLEN=anslen**,ANSLEN=NO ANSLEN**

When TEST=YES and REQUEST=OBTAIN are specified, an optional input parameter that is the length of the answer area provided. The answer area should be large enough to hold an ISGYENQAA record and an RNAME for each request (specified by NUMRES, or one if RESLIST=NO). The maximum size area needed to contain one RNAME is 256 bytes. ANSAREA is required if ANSLEN is specified. The default is NO_ANSLEN.

To code: Specify the RS-type address, or address in register (2)-(12), of a fullword field, or specify a literal decimal value.

,COND=NO**,COND=YES**

An optional parameter that indicates how the request is handled for unsuccessful processing. The default is COND=NO.

,COND=NO

Indicates that if the request is not successful, then ISGENQ should ABEND the caller. COND=NO is mutually exclusive with RETCODE, RSNCODE, RETURNABLE, WAITTYPE=ECB, and with TEST=YES.

,COND=YES

Indicates that ISGENQ should always return to the caller and indicate via return and reason codes whether the request was successful. If COND=YES is specified, RETCODE and RSNCODE (and RETURNABLE, if RESLIST=YES) are required keywords.

Note: When COND=YES, ISGENQ tries to provide return and reason codes for the errors occurred during the process, though in some cases abends might be issued.

,CONTENTIONACT=WAIT**,CONTENTIONACT=FAIL**

When TEST=NO and REQUEST=OBTAIN are specified, an optional parameter that indicates the action that should be taken if there is contention for the requested resource.

Note that a reserve request (where UCB@ is specified) that is not converted to only a global ENQ (Systems) will consist of an ENQ resource and a hardware reserve. For more information on reserve processing, see the description of the “,SYNCHRES=SYSTEM” on page 464 keyword for more information on reserve processing. The default is CONTENTIONACT=WAIT.

,CONTENTIONACT=WAIT

Indicates that the caller waits until the ENQ resource is available and, if applicable, the synchronous reserve I/O (see SYNCHRES) is complete.

,CONTENTIONACT=FAIL

Indicates that if contention for the ENQ resource exists to cancel the ENQ obtain request and return to the caller.

Notes:

- See CONTENTIONACT=WAIT with ECB@ as a means of timing the overall request.
- For a reserve request (where UCB@ is specified), the ENQ resource is always obtained first. As such, CONTENTIONACT=FAIL indicates to cancel the entire request when there is contention on the ENQ resource. However, it does not apply to contention on the hardware reserve. See CONTENTIONACT=WAIT with WAITTYPE=ECB for information on how to manage or time hardware reserve contention.
- When SYNCRES is enabled, the request is subject to a delay for the reserve even if RET=USE or CONTENTIONACT=Fail is specified.

,CONTROL=EXCLUSIVE**,CONTROL=SHARED****,CONTROL=VALUE**

When RESLIST=NO and REQUEST=OBTAIN are specified, a required parameter that is the control type of the ENQ to be obtained. If the resource is modified while under control of the task, the request must be for exclusive control. If the resource is not modified, the request should be for shared control.

,CONTROL=EXCLUSIVE

Indicates that the request is for exclusive control of the resource.

,CONTROL=SHARED

Indicates that the request is for shared control of the resource.

,CONTROL=VALUE

the user provides a value, through the CONTROLVAL keyword, indicating the requested control.

,CONTROL=DO_NOT_OVERRIDE**,CONTROL=EXCLUSIVE****,CONTROL=SHARED**

When RESLIST=YES and REQUEST=OBTAIN are specified, an optional parameter that is the type of control to be used for all resources specified in the resource table. This overrides any control specified in the resource table. If the resource is modified while under control of the task, the request must be for exclusive control. If the resource is not modified, the request should be for shared control. The default is CONTROL=DO_NOT_OVERRIDE.

,CONTROL=DO_NOT_OVERRIDE

Indicates that the control specified in the resource table should be used.

,CONTROL=EXCLUSIVE

Indicates that all requests are for exclusive control of the resources.

,CONTROL=SHARED

Indicates that all requests are for shared control of the resources.

,CONTROL=EXCLUSIVE**,CONTROL=SHARED**

When RESLIST=NO and REQUEST=CHANGE are specified, control is an optional keyword input that is the control type to which the ENQ is to be changed. If the resource is modified under control of the task the request must be for exclusive control. If the resource is not modified, the request should be for shared control. When RESLIST=YES is specified, all resources in the list will be changed to the specified scope. The default is CONTROL=EXCLUSIVE.

,CONTROL=EXCLUSIVE

Indicates that the request is to change to exclusive control of the resource.

,CONTROL=SHARED

Indicates that the request is to change to shared control of the resource.

,CONTROLVAL=controlval

When CONTROL=VALUE, RESLIST=NO and REQUEST=OBTAIN are specified, a required input parameter that contains a value indicating the desired control. The value provided must be equivalent to the constants provided in the ISGYENQ macro indicating the control. (See the ISGYENQ_kControl constants in the ISGYENQ macro for more information.)

To code: Specify the RS-type address, or address in register (2)-(12), of a one-byte field.

,ECB@=*ecb*@

When WAITTYPE=ECB, CONTENTIONACT=WAIT, TEST=NO and REQUEST=OBTAIN are specified, a required input parameter that contains the address of the ECB to be posted when the requested resource(s) is/are obtained.

The ECB must be in one of the following locations:

- the home address space of the caller.
- common space.
- for unauthorized requesters, in the same storage key as the requester.

When the ISGENQ service returns to the caller, the return and reason codes specify for each resource whether the task has been given control of the resource or needs to wait for the ECB to be posted.

When the ECB is posted, it contains a return/reason code pair. Bits 8-23 contain the low-order halfword of the reason code and bits 24-31 contain the low-order byte of the return code. For a RESLIST=NO request, the ECB contains the return and reason code for the request. For a RESLIST=YES request, the ECB contains an overall return code.

To code: Specify the RS-type address, or address in register (2)-(12), of a pointer field.

,ENQTOKEN=*enqtoken*

When RESLIST=NO and REQUEST=OBTAIN are specified, a required output parameter that is a token that uniquely identifies the ENQ. The ENQTOKEN is used on subsequent REQUEST=RELEASE or CHANGE invocations to release or change the ENQ request.

To code: Specify the RS-type address, or address in register (2)-(12), of a 32-character field.

,ENQTOKEN=*enqtoken*

When RESLIST=NO and REQUEST=CHANGE are specified, a required input parameter that is an ENQ Token of the ENQ to be changed.

To code: Specify the RS-type address, or address in register (2)-(12), of a 32-character field.

,ENQTOKEN=*enqtoken*

When RESLIST=NO and REQUEST=RELEASE are specified, a required input parameter that is an ENQ Token of the ENQ to be released.

To code: Specify the RS-type address, or address in register (2)-(12), of a 32-character field.

,ENQTOKENBL=*enqtokentbl*

When RESLIST=YES and REQUEST=OBTAIN are specified, a required output parameter that is a table of ENQ tokens. Mapped by ISGYENQToken in the ISGYENQ macro. To easily release any ENQs obtained by a REQUEST=OBTAIN use the same ENQToken table as input to a REQUEST=RELEASE.

To code: Specify the RS-type address, or address in register (2)-(12), of a character field.

,ENQTOKENBL=*enqtokenbl*

When RESLIST=YES and REQUEST=CHANGE are specified, a required input parameter that is a table of ENQ Tokens. Mapped by ISGYENQToken in the ISGYENQ macro.

To code: Specify the RS-type address, or address in register (2)-(12), of a character field.

,ENQTOKENBL=*enqtokenbl*

When RESLIST=YES and REQUEST=RELEASE are specified, a required input parameter that is a table of ENQ Tokens. Mapped by ISGYENQToken in the ISGYENQ macro.

To code: Specify the RS-type address, or address in register (2)-(12), of a character field.

,MF=S

,MF=(L,*list addr*)

,MF=(L,*list addr*,*attr*)

,MF=(L,*list addr*,*OD*)

,MF=(E,*list addr*)

,MF=(E,*list addr*,COMPLETE**)**

An optional input parameter that specifies the macro form.

Use MF=S to specify the standard form of the macro, which builds an inline parameter list and generates the macro invocation to transfer control to the service. MF=S is the default.

Use MF=L to specify the list form of the macro. Use the list form together with the execute form of the macro for applications that require reentrant code. The list form defines an area of storage that the execute form uses to store the parameters. Only the PLISTVER parameter may be coded with the list form of the macro.

Use MF=E to specify the execute form of the macro. Use the execute form together with the list form of the macro for applications that require reentrant code. The execute form of the macro stores the parameters into the storage area defined by the list form, and generates the macro invocation to transfer control to the service.

,*list addr*

The name of a storage area to contain the parameters. For MF=S and MF=E, this can be an RS-type address or an address in register (1)-(12).

,*attr*

An optional 1- to 60-character input string that you use to force boundary alignment of the parameter list. Use a value of OF to force the parameter list to a word boundary, or OD to force the parameter list to a doubleword boundary. If you do not code *attr*, the system provides a value of OD.

,COMPLETE****

Specifies that the system is to check for required parameters and supply defaults for omitted optional parameters.

,NUMRES=*numres*

When RESLIST=YES and REQUEST=OBTAIN are specified, a required input parameter that is the number of resource entries in the resource table. The specified value can be in the range of 1 to 2?6-1 (65535).

To code: Specify the RS-type address, or address in register (2)-(12), of a halfword field, or specify a literal decimal value.

,NUMRES=*numres*

When RESLIST=YES and REQUEST=CHANGE are specified, a required input parameter that is the number of ENQ tokens in the ENQ token table. The specified value can be in the range of 1 to 2?6-1 (65535).

To code: Specify the RS-type address, or address in register (2)-(12), of a halfword field, or specify a literal decimal value.

,NUMRES=numres

When RESLIST=YES and REQUEST=RELEASE are specified, a required input parameter that is the number of ENQ tokens in the ENQ Token Table. The specified value can be in the range of 1 to 2²⁶-1 (65535).

To code: Specify the RS-type address, or address in register (2)-(12), of a halfword field, or specify a literal decimal value.

,OWNINGTTOKEN=owningtoken**,OWNINGTTOKEN=CURRENT_TASK**

When WAITTYPE=ECB, CONTENTIONACT=WAIT, TEST=NO and REQUEST=OBTAIN are specified, an optional input parameter that is the task token (TToken) of the task on whose behalf the ENQ is to be obtained. The TToken must specify a task in the caller's home address space.

Note: Mutually exclusive with RESERVEVOLUME=YES. The default is CURRENT_TASK.

To code: Specify the RS-type address, or address in register (2)-(12), of a 16-character field.

,OWNINGTTOKEN=owningtoken**,OWNINGTTOKEN=CURRENT_TASK**

When CONTENTIONACT=FAIL, TEST=NO and REQUEST=OBTAIN are specified, an optional input parameter that is the task token (TToken) of the task on whose behalf the ENQ is to be obtained. The TToken must specify a task in the caller's home address space.

Note: Mutually exclusive with RESERVEVOLUME=YES. The default is CURRENT_TASK.

To code: Specify the RS-type address, or address in register (2)-(12), of a 16-character field.

,OWNINGTTOKEN=owningtoken**,OWNINGTTOKEN=CURRENT_TASK**

When TEST=YES and REQUEST=OBTAIN are specified, an optional input parameter that is the task token (TToken) of the task on whose behalf the test request is to be performed. The TToken must specify a task in the caller's home address space.

Note: Mutually exclusive with RESERVEVOLUME=YES. The default is CURRENT_TASK.

To code: Specify the RS-type address, or address in register (2)-(12), of a 16-character field.

,OWNINGTTOKEN=owningtoken**,OWNINGTTOKEN=CURRENT_TASK**

When REQUEST=CHANGE is specified, an optional input parameter that is the task token (TToken) of the task that owns the ENQ that is to be changed. The TToken must specify a task in the caller's home address space. The default is CURRENT_TASK.

To code: Specify the RS-type address, or address in register (2)-(12), of a 16-character field.

,OWNINGTTOKEN=owningtoken**,OWNINGTTOKEN=CURRENT_TASK**

When REQUEST=RELEASE is specified, an optional input parameter that is the task token (TToken) of the task that owns the ENQs that are to be released. The TToken must specify a task in the caller's home address space. The default is CURRENT_TASK.

To code: Specify the RS-type address, or address in register (2)-(12), of a 16-character field.

,PLISTVER=IMPLIED_VERSION**,PLISTVER=MAX****,PLISTVER=1****,PLISTVER=2**

An optional input parameter that specifies the version of the macro. PLISTVER determines which parameter list the system generates. PLISTVER is an optional input parameter on all forms of the macro, including the list form. When using PLISTVER, specify it on all macro forms used for a request and with the same value on all of the macro forms. The values are:

- **IMPLIED_VERSION**, which is the lowest version that allows all parameters specified on the request to be processed. If you omit the PLISTVER parameter, IMPLIED_VERSION is the default.

- **MAX**, if you want the parameter list to be the largest size currently possible. This size might grow from release to release and affect the amount of storage that your program needs.

If you can tolerate the size change, IBM recommends that you always specify `PLISTVER=MAX` on the list form of the macro. Specifying `MAX` ensures that the list-form parameter list is always long enough to hold all the parameters you might specify on the execute form, when both are assembled with the same level of the system. In this way, `MAX` ensures that the parameter list does not overwrite nearby storage.

- **1**, which supports all parameters except those specifically referenced in higher versions.
- **2**, which supports both the following parameters and those from version 1: `USERDATA`

To code: Specify one of the following:

- `IMPLIED_VERSION`
- `MAX`
- A decimal value of 1, or 2

,QNAME=qname

When `RESLIST=NO` and `REQUEST=OBTAIN` are specified, a required input parameter that is the `QNAME` of the resource. The `QNAME` can contain any character from `X'00'` to `X'FF'`. However, a unique readable value that identifies the functional area or a high level of what is being serialized is preferred. Every program issuing a request for a serially reusable resource must use the same `QNAME`, `RNAME`, and `Scope` to represent the resource. Some names, such as those beginning with certain letter combinations (`SYSZ` for example), are used to protect system resources by requiring that the issuing program be in supervisor state, or system key, or APF-authorized. Authorized programs must use a restricted `QNAME` (as described under Minimum authorization in the Environment section for this service) to prevent interference from unauthorized programs.

For a list of `QNAME` (also known as major name) and `RNAME` (also known as minor name) `ENQ` or `DEQ` names and the resources that issue the `ENQ` or `DEQ`, see [z/OS MVS Diagnosis: Reference](#).

To code: Specify the RS-type address, or address in register (2)-(12), of an 8-character field.

,QNAME=qname

,QNAME=DO_NOT_OVERRIDE

When `RESLIST=YES` and `REQUEST=OBTAIN` are specified, an optional input parameter that is a common `QNAME` to be used for all resources in the resource table. This overrides any `QNAMEs` specified in the resource table. The `QNAME` can contain any character from `X'00'` to `X'FF'`. However, a unique readable value that identifies the functional area or a high level of what is being serialized is preferred. Every program issuing a request for a serially reusable resource must use the same `QNAME`, `RNAME`, and `Scope` to represent the resource. Some names, such as those beginning with certain letter combinations (`SYSZ` for example), are used to protect system resources by requiring that the issuing program be in supervisor state, or system key, or APF-authorized. Authorized programs must use a restricted `QNAME` (as described under Minimum authorization in the Environment section for this service) to prevent interference from unauthorized programs.

For a list of `QNAME` (also known as major name) and `RNAME` (also known as minor name) `ENQ` or `DEQ` names and the resources that issue the `ENQ` or `DEQ`, see [z/OS MVS Diagnosis: Reference](#).

The default is `DO_NOT_OVERRIDE`.

To code: Specify the RS-type address, or address in register (2)-(12), of an 8-character field.

REQUEST=OBTAIN

REQUEST=CHANGE

REQUEST=RELEASE

A required parameter that indicates the type of `ISGENQ` request.

REQUEST=OBTAIN

Indicates a request to obtain an `ENQ` for a resource.

REQUEST=CHANGE

Indicates a request to change the status an `ENQ` from shared to exclusive control.

REQUEST=RELEASE

Indicates a request to release (dequeue) the ENQ for a resource.

,RESERVEVOLUME=NO**,RESERVEVOLUME=YES**

When RESLIST=NO and REQUEST=OBTAIN are specified, an optional parameter. The default is RESERVEVOLUME=NO.

,RESERVEVOLUME=NO

Indicates to issue a normal ENQ obtain and not a reserve.

,RESERVEVOLUME=YES

Indicates that after the ENQ resource is obtained that a reserve for the given device (shared DASD) is to be issued.

Note: RESERVEVOLUME=YES is mutually exclusive with OWNINGTOKEN.

,RESLIST=NO**,RESLIST=YES**

When REQUEST=OBTAIN is specified, an optional parameter, The default is RESLIST=NO.

,RESLIST=NO

Indicates to obtain an ENQ for a single resource.

,RESLIST=YES

Indicates to obtain ENQs for multiple resources specified in a resource table. Specifying multiple requests in a list ensures that they are processed atomically with respect to other ISGENQ requests. However, the order in which the requests are processed is unpredictable. Each request is treated as a separate request, and if COND=YES is specified, then the return code for each request should be checked.

Note: An easy way to release a list of ENQs is to use the output ENQTOKEN table from the OBTAIN request as input to a RELEASE request.

,RESLIST=NO**,RESLIST=YES**

When REQUEST=CHANGE is specified, an optional parameter, The default is RESLIST=NO.

,RESLIST=NO

Indicates to change the control of a single ENQ.

,RESLIST=YES

Indicates to change the control for multiple ENQs.

,RESLIST=NO**,RESLIST=YES**

When REQUEST=RELEASE is specified, an optional parameter, The default is RESLIST=NO.

,RESLIST=NO

Indicates to single ENQ RELEASE request.

,RESLIST=YES

Indicates to change the disposition for multiple ENQs.

Note: A easy way to release a list of ENQs is to use the output ENQTOKEN table from the OBTAIN request as input to a RELEASE request.

,RESTABLE=restable

When RESLIST=YES and REQUEST=OBTAIN are specified, a required input parameter that is a table specifying multiple ENQ requests. The resource table is mapped by ISGYENQRes in the ISGYENQ macro.

To code: Specify the RS-type address, or address in register (2)-(12), of a character field.

,RETCODE=retcode

An optional output parameter into which the return code is to be copied from GPR 15. If you specify 15, GPR15, REG15, or R15 (within or without parentheses), the value will be left in GPR 15.

To code: Specify the RS-type address of a fullword field, or register (2)-(12) or (15), (GPR15), (REG15), or (R15).

,RETURNTABLE=returntable

When RESLIST=YES and REQUEST=OBTAIN are specified, an optional output parameter that is a table that contains the return and reason codes. Mapped by ISGYENQReturn in the ISGYENQ macro. The return table is only valid when ISGENQRsn_NonZeroReturnCodes is returned in the RSNCODE. Mutually exclusive with COND=NO.

To code: Specify the RS-type address, or address in register (2)-(12), of a character field.

,RETURNTABLE=returntable

When RESLIST=YES and REQUEST=CHANGE are specified, an optional output parameter that is a table that contains the return and reason codes. Mapped by ISGYENQReturn in the ISGYENQ macro. The return table is only valid when ISGENQRsn_NonZeroReturnCodes is returned in the RSNCODE. Mutually exclusive with COND=NO.

To code: Specify the RS-type address, or address in register (2)-(12), of a character field.

,RETURNTABLE=returntable

When RESLIST=YES and REQUEST=RELEASE are specified, an optional output parameter that is a table that contains the return and reason codes. Mapped by ISGYENQReturn in the ISGYENQ macro. The return table is only valid when ISGENQRsn_NonZeroReturnCodes is returned in the RSNCODE. Mutually exclusive with COND=NO.

To code: Specify the RS-type address, or address in register (2)-(12), of a character field.

,RNAME=rname

When RESLIST=NO and REQUEST=OBTAIN are specified, a required input parameter that is the RNAME for the resource. The RNAME must be from 1 to 255 bytes long, and can contain any hexadecimal character from X'00' to X'FF'.

To code: Specify the RS-type address, or address in register (2)-(12), of a character field.

,RNAME=rname**,RNAME=DO NOT OVERRIDE**

When RESLIST=YES and REQUEST=OBTAIN are specified, an optional input parameter that is the common RNAME to be used for all resources in the resource table. This overrides any RNAMEs specified in the resource table. The RNAME must be from 1 to 255 bytes long, and can contain any hexadecimal character from X'00' to X'FF'. The default is DO_NOT_OVERRIDE.

To code: Specify the RS-type address, or address in register (2)-(12), of a character field.

,RNAMELEN=rnamelen

When RESLIST=NO and REQUEST=OBTAIN are specified, a required input parameter that is the length of the given RNAME. The specified length can be in the range of 1 to 255.

To code: Specify the RS-type address, or address in register (2)-(12), of an one-byte field.

,RNAMELEN=rnamelen**,RNAMELEN=DO NOT OVERRIDE**

When RESLIST=YES and REQUEST=OBTAIN are specified, an optional input parameter that is a common length to be used for all RNAMEs in the resource table, or if a common RNAME is specified, it is the length of the common RNAME. The specified length can be in the range of 1 to 255. This overrides any RNAMEs lengths specified in the resource table. The default is DO_NOT_OVERRIDE.

To code: Specify the RS-type address, or address in register (2)-(12), of an one-byte field.

,RNL=YES**,RNL=NO**

When RESERVEVOLUME=NO, RESLIST=NO and REQUEST=OBTAIN are specified, an optional parameter that indicates whether the scope can be changed by global resource serialization resource name list (RNL) processing, installation exits, or alternate serialization products. The default is RNL=YES.

,RNL=YES

Indicates that global resource serialization RNL processing should be used, which can cause the scope of a resource to change. In general, IBM recommends that you use the default, RNL=YES, to allow global resource serialization to perform RNL processing and allow installation exits and alternate serialization products to alter, extend, or restrict the scope and other attributes, as needed.

,RNL=NO

Indicates that global resource serialization RNL processing should not be used. The scope of the resource is not changed by the RNLs, any installation exits, or alternate serialization product. Use RNL=NO when you are sure that you want the request to be processed only by GRS using only the specified scope or when an alternate serialization product or installation exit should be prevented from altering the scope or other attributes, extending the scope beyond the GRS serialization complex, or restricting the scope to systems other than all of those in the GRS complex.

,RNL=DO_NOT_OVERRIDE**,RNL=YES****,RNL=NO**

When RESLIST=YES and REQUEST=OBTAIN are specified, an optional parameter that indicates whether the scope can be changed by global resource serialization resource name list (RNL) processing or the dynamic exits. This overrides any RNL processing specified in the resource table. The default is RNL=DO_NOT_OVERRIDE.

,RNL=DO_NOT_OVERRIDE

Indicates that the RNL specifications in the resource table should be used.

,RNL=YES

Indicates that global resource serialization RNL processing should be used, which can cause the scope of a resource to change. IBM suggests that you use the default, RNL=YES, to allow global resource serialization to perform RNL processing.

,RNL=NO

Indicates that global resource serialization RNL processing should not be used. The scope of the resource cannot be changed by the RNLs or any dynamic exits. Use RNL=NO when you are sure that you want the request to be processed only by global resource serialization using only the specified scope. When RNL=NO is specified, the ENQ request is ignored by alternative serialization products.

,RSNCODE=*rsncode*

An optional output parameter into which the reason code is to be copied from GPR 0. If you specify 0, 00, GPR0, GPR00, REG0, REG00, or R0 (within or without parentheses), the value will be left in GPR 0.

To code: Specify the RS-type address of a fullword field, or register (0) or (2)-(12), (00), (GPR0), (GPR00), (REG0), (REG00), or (R0).

,SCOPE=STEP**,SCOPE=SYSTEM****,SCOPE=SYSTEMS****,SCOPE=SYSPLEX****,SCOPE=VALUE**

When RESERVEVOLUME=NO, RESLIST=NO and REQUEST=OBTAIN are specified, a required parameter that is the scope of the resource.

,SCOPE=STEP

Indicates that the resource is serialized only within an address space. If STEP is specified, a request for the same QNAME and RNAME from a program in another address space denotes a different resource.

,SCOPE=SYSTEM

Indicates that the resource is serialized across all address spaces in a system.

,SCOPE=SYSTEMS

Indicates that the resource is serialized across all systems in a GRS Star or GRS Ring complex.

,SCOPE=SYSPLEX

Indicates that the resource is serialized across all systems in a GRS Star sysplex or GRS ring. (Same as scope SYSTEMS.)

,SCOPE=VALUE

the user provides a value, through the SCOPEVAL keyword, indicating the requested scope.

,SCOPE=DO_NOT_OVERRIDE**,SCOPE=STEP****,SCOPE=SYSTEM****,SCOPE=SYSTEMS****,SCOPE=SYSPLEX**

When RESLIST=YES and REQUEST=OBTAIN are specified, an optional parameter that is the scope to be used for all resources in the resource table. This overrides any scopes specified in the resource table. The default is SCOPE=DO_NOT_OVERRIDE.

,SCOPE=DO_NOT_OVERRIDE

Indicates that the scope specified in the resource table should be used.

,SCOPE=STEP

Indicates that the resource is serialized only within an address space. If STEP is specified, a request for the same QNAME and RNAME from a program in another address space denotes a different resource.

,SCOPE=SYSTEM

Indicates that the resource is serialized across all address spaces in a system.

,SCOPE=SYSTEMS

Indicates that the resource is serialized across all systems in a GRS Star or GRS Ring complex.

,SCOPE=SYSPLEX

Indicates that the resource is serialized across all systems in a GRS Star sysplex or GRS ring. (Same as scope SYSTEMS.)

,SCOPEVAL=scopeval

When SCOPE=VALUE, RESERVEVOLUME=NO, RESLIST=NO and REQUEST=OBTAIN are specified, a required input parameter that contains a value indicating the desired scope. The value provided must be equivalent to the constants provided in the ISGYENQ macro indicating the scope. (See the ISGYENQ_ constants in the ISGYENQ macro for more information.)

To code: Specify the RS-type address, or address in register (2)-(12), of an one-byte field.

,SYNCHRES=SYSTEM**,SYNCHRES=YES****,SYNCHRES=NO**

When RESERVEVOLUME=YES, RESLIST=NO and REQUEST=OBTAIN are specified, an optional parameter that specifies whether the request should issue a synchronous reserve. A synchronous reserve immediately reserves the volume instead of waiting for the first use.

Note that an RC=4 (ISGENQRc_Warn), RSC=0403 (ISGENQRsn_ECBWillBePosted) is presented for CONTENTIONACT=WAIT, WAITTYPE=ECB, reserve requests (where UCB@ is specified) when there is contention on the ENQ resource or there was no contention on the resource, and the reserve I/O was done synchronously. The default is SYNCHRES=SYSTEM.

,SYNCHRES=SYSTEM

Indicates that the installation system default SYNCHRES setting should be used.

,SYNCHRES=YES

Indicates to issue a synchronous reserve. In cases where the hardware reserve is performed (it was not converted to a Global/Systems ENQ), the caller is ensured that the reserve I/O is complete when the ISGENQ request has successfully completed.

,SYNCHRES=NO

Indicates that a synchronous reserve should be avoided when possible. Some devices require that the reserve must be done synchronously regardless of this setting. If the reserve I/O is not done

synchronously, the reserve is done when the first I/O is done to the device after the reserve request is issued. For more information, see [z/OS MVS Planning: Global Resource Serialization](#).

,SYNCHRES=DO NOT OVERRIDE

,SYNCHRES=SYSTEM

,SYNCHRES=YES

,SYNCHRES=NO

When RESLIST=YES and REQUEST=OBTAIN are specified, an optional parameter that specifies whether all requests specified in the resource table should issue a synchronous reserve. This overrides any SYNCHRES specified in the resource table. A synchronous reserve immediately reserves the volume instead of waiting for the first use. The default is SYNCHRES=DO_NOT_OVERRIDE.

,SYNCHRES=DO NOT OVERRIDE

Indicates that the SYNCHRES specified in the resource table should be used.

,SYNCHRES=SYSTEM

Indicates that the system default setting should be used.

,SYNCHRES=YES

Indicates to issue a synchronous reserve. In cases where the hardware reserve is performed (it was not converted to a Global/Systems ENQ), the caller is ensured that the reserve I/O is complete when the request has successfully completed.

,SYNCHRES=NO

Indicates that a synchronous reserve should be avoided when possible. Some devices require that the reserve must be done synchronously regardless of this setting. If the reserve I/O is not done synchronously, the reserve is done when the first I/O is done to the device after the reserve request is issued. See [z/OS MVS Planning: Global Resource Serialization](#) for more information.

,TEST=NO

,TEST=YES

When REQUEST=OBTAIN is specified, an optional parameter. The default is TEST=NO.

,TEST=NO

Indicates that this is not a test request. The ENQ must be obtained.

,TEST=YES

Indicates that this is a test request. The ENQ must not be obtained. This parameter setting can be used to obtain information about how the given obtain request is processed and how a resource is currently held by the current task or a task specified by OWNINGTTOKEN.

Mutually exclusive with COND=NO.

For existing requests from the same task, which match the specified resource, the ENQToken of that request is returned.

See ISGQUERY SEARCH=BY_ENQTOKEN for information about outstanding ENQ requests.

The following return and reason codes can be used to determine if the resource is available and how it might be held by the OWNINGTTOKEN task:

- ISGENQRc_ok
- ISGENQRsn_NotImmediatelyAvailable
- ISGENQRsn_TaskOwnsExclusive
- ISGENQRsn_TaskOwnsShared
- ISGENQRsn_TaskWaiting

,UCB@=uch@

When RESERVEVOLUME=YES, RESLIST=NO and REQUEST=OBTAIN are specified, a required input parameter that contains the address of the UCB for the device to be reserved. For unauthorized callers, the UCB must be allocated to the job step before ISGENQ RESERVEVOLUME=YES is issued.

Note: Authorized callers do not need to allocate the UCB to the job step before invoking ISGENQ, but the caller must serialize the UCB against dynamic I/O reconfiguration requests. The caller can accomplish this serialization by allocating or pinning the UCB. Such serialization ensures that a

dynamic I/O reconfiguration request does not delete or reuse the UCB before the ISGENQ macro uses the address.

To code: Specify the RS-type address, or address in register (2)-(12), of a pointer field.

,UCB@=*ucb@*

,UCB@=DO NOT OVERRIDE

When RESLIST=YES and REQUEST=OBTAIN are specified, an optional input parameter that contains the address of the UCB@ for the device to be reserved for all resources in the resource table. This overrides any UCB addresses specified in the resource table. The default is DO_NOT_OVERRIDE.

To code: Specify the RS-type address, or address in register (2)-(12), of a pointer field.

,USERDATA=*userdata*

,USERDATA=NO USERDATA

When TEST=NO and REQUEST=OBTAIN are specified, an optional input parameter that contains the userdata to be associated with this request. For information about using USERDATA as a filter, or making ISGQUERY return USERDATA for requests, see [Chapter 61, “ISGQUERY — Global resource serialization query service,” on page 481](#).

Note that GRS has no interests in the contents of the USERDATA. Unlike the QNAME, RNAME, and SCOPE parameters, USERDATA has no meaning in the definition of the logically serialized resource identity. For example, exclusive requests with different user data and the same QNAME, RNAME, and SCOPE contend with each other.

This request requires a version 2 parameter list. The default is NO_USERDATA.

To code: Specify the RS-type address, or address in register (2)-(12), of a 32-character field.

,WAITTYPE=SUSPEND

,WAITTYPE=ECB

When CONTENTIONACT=WAIT, TEST=NO and REQUEST=OBTAIN are specified, an optional parameter that indicates the method by which the caller waits. The default is WAITTYPE=SUSPEND.

,WAITTYPE=SUSPEND

Indicates that the current task is suspended until the entire request is completed.

,WAITTYPE=ECB

Indicates that if contention for the ENQ resource exists or the device reserve is done synchronously (see [“,SYNCHRES=SYSTEM” on page 464](#)), return to the caller, and post the ECB when the request is complete.

Mutually exclusive with COND=NO.

WAITTYPE=ECB in combination with setting a timer with ECB can be used to control the amount of time that you are willing to wait for either ENQ contention or a synchronous reserve to complete. If the request does not complete before the time expires you can do the following actions.

- You can use the ISGECA and ISGQUERY services to interrogate the overall state of the request and associated resource.
- You can back out of the request using an ISGENQ REQUEST=RELEASE request."

ABEND codes

For REQUEST=OBTAIN and REQUEST=CHANGE requests the caller might encounter abend codes X'138', X'238', X'338', X'438', X'538', X'738', X'838', X'938'.

For REQUEST=RELEASE requests the caller might encounter abend codes X'130', X'230', X'330', X'430', X'530', X'730', X'830', X'930'.

For explanations and responses for these codes, see [z/OS MVS System Codes](#).

Note that the ABEND reason codes correspond to the same reason codes listed in [Table 31 on page 467](#).

Return and reason codes

When the ISGENQ macro returns control to your program:

- GPR 15 (and *retcode*, when you code RETCODE) contains a return code.
- When the value in GPR 15 is not zero, GPR 0 (and *rsncode*, when you code RSNCODE) contains a reason code.

Macro ISGYCON provides equate symbols for the return and reason codes.

The following table identifies the hexadecimal return and reason codes and the equate symbol associated with each reason code. IBM support the xxxx value, where xxxx represent 4 hex digits. Note that when the xxxx value is 'E0F2' hexadecimal, it indicates a reason-code set by the ISGNQXITBATCH or ISGNQXITBATCHCND exits.

<i>Table 31. Return and Reason Codes for the ISGENQ Macro</i>		
Return Code	Reason Code	Equate Symbol Meaning and Action
00	—	<p>Equate Symbol: ISGENQRc_OK</p> <p>Meaning: ISGENQ request successful. Depending on the type of request, the ENQ is successfully obtained, changed to exclusive, or released. If RESLIST=YES is specified, all ENQ obtain, change, and release requests are successful. For REQUEST=OBTAIN, TEST=YES, the resource is immediately available.</p> <p>Action: None required.</p>
04	—	<p>Equate Symbol: ISGENQRc_Warn</p> <p>Meaning: Warning</p> <p>Action: Refer to action under the individual reason code.</p>
04	xxxx0401	<p>Equate Symbol: ISGENQRsn_NonZeroReturnCodes</p> <p>Meaning: A non-zero return code was issued for one or more entries in a RESLIST=YES request. The return table has the return and reason codes for each of the requests in the list.</p> <p>Action: See the return and reason codes returned in the RETURNABLE.</p>
04	xxxx0402	<p>Equate Symbol: ISGENQRsn_RequestNotProcessed</p> <p>Meaning: For RESLIST=YES requests. One of the other requests in the RESTABLE failed such that this request was prevented from being processed. Note that requests in a RESTABLE are not necessarily processed in the order they appear in the RESTABLE. Note: This reason code returned only in the RETURNABLE, not through the RSNCODE keyword.</p> <p>Action: Check the return and reason codes for all other requests in the RETURNABLE to identify the problem.</p>

<i>Table 31. Return and Reason Codes for the ISGENQ Macro (continued)</i>		
Return Code	Reason Code	Equate Symbol Meaning and Action
04	xxxx0403	<p>Equate Symbol: ISGENQRsn_ECBWillBePosted</p> <p>Meaning: For REQUEST=OBTAIN CONTENTIONACT=WAIT WAITTYPE=ECB, the OBTAIN request was successful, but the ENQ resource was not immediately available or the reserve I/O needed to be done synchronously (SYNCHRES). The ECB is posted when all requested resources are owned by the specified task, or when an error has occurred. The ENQToken for the request has been returned.</p> <p>Action: Wait on the ECB and check the return code in the ECB before using the requested resources.</p>
04	xxxx0404	<p>Equate Symbol: ISGENQRsn_NotImmediatelyAvailable</p> <p>Meaning: The ENQ of the resource was not immediately available. For REQUEST=OBTAIN CONTENTIONACT=FAIL, the requested resource is not obtained. For REQUEST=OBTAIN TEST=YES, the holder is a task other than OWNINGTTOKEN.</p> <p>Action: No action required.</p>
04	xxxx0405	<p>Equate Symbol: ISGENQRsn_TaskOwnsExclusive</p> <p>Meaning: For REQUEST=OBTAIN, including TEST=YES, the given task specified by OWNINGTTOKEN already owns the specified resource exclusively. The ENQToken for the owning request has been returned.</p> <p>Action: No action required.</p>
04	xxxx0406	<p>Equate Symbol: ISGENQRsn_TaskOwnsShared</p> <p>Meaning: For a REQUEST=OBTAIN, including TEST=YES, the given task specified by OWNINGTTOKEN already owns the specified resource shared. The ENQToken for the owning request has been returned.</p> <p>Action: No action required.</p>
04	xxxx0407	<p>Equate Symbol: ISGENQRsn_TaskWaiting</p> <p>Meaning: For a REQUEST=OBTAIN, including TEST=YES, the given task specified by OWNINGTTOKEN is already waiting for control of the specified resource. The ENQToken for the waiting request has been returned.</p> <p>Action: No action required.</p>
04	xxxx0409	<p>Equate Symbol: ISGENQRsn_OtherSharedOwners</p> <p>Meaning: For REQUEST=CHANGE. The control cannot be changed to exclusive. There are other shared owners of the resource.</p> <p>Action: No action required.</p>

<i>Table 31. Return and Reason Codes for the ISGENQ Macro (continued)</i>		
Return Code	Reason Code	Equate Symbol Meaning and Action
04	xxxx040A	<p>Equate Symbol: ISGENQRsn_TaskDoesNotOwn</p> <p>Meaning: For REQUEST=CHANGE. The control cannot be changed to exclusive. The task does not yet own the resource.</p> <p>Action: No action required.</p>
04	xxxx040B	<p>Equate Symbol: ISGENQRsn_TaskSuspendedForResource</p> <p>Meaning: For REQUEST=RELEASE. The task that requested the ENQ obtain has not yet been assigned control of the resource. The task continues waiting and the resource is not released. (This reason code might result in an exit routine, which received control because of an interruption, issued a RELEASE request on behalf of the task.)</p> <p>Action: Correct the program so that the ISGENQ RELEASE request is issued only after the ISGENQ OBTAIN request has returned to the task. If possible, avoid issuing the RELEASE request in the exit routine.</p>
04	xxxx040D	<p>Equate Symbol: ISGENQRsn_UnprotectedQName</p> <p>Meaning: For REQUEST=OBTAIN. An authorized caller requested an ENQ with an unauthorized QNAME.</p> <p>For TEST=NO,COND=YES, the OBTAIN request completed successfully, an unauthorized caller under the same owning task might release the ENQ. The ENQToken has been returned.</p> <p>For TEST=NO, COND=NO, the requester was abended with a X'438' abend. The request might not have completed successfully</p> <p>For TEST=YES requests, the resource is currently available.</p> <p>Action: No action required. If the ENQ needs to be protected from unauthorized RELEASE requests or from unauthorized callers obtaining an ENQ to block this request, specify one of the authorized QNAMEs for the resource.</p>
04	xxxx040E	<p>Equate Symbol: ISGENQRsn_UnprotectedExitQNAME</p> <p>Meaning: For REQUEST=OBTAIN. An authorized caller requested an ENQ with a QNAME that a dynamic exit changed to an unauthorized QNAME. For TEST=NO, the OBTAIN request completed successfully, an unauthorized caller under the same owning task might release the ENQ. The ENQToken has been returned. For TEST=YES requests, the resource is currently available but the QNAME was changed by a dynamic exit to an unprotected QNAME.</p> <p>Action: No action required. Contact the system programmer, if the ENQ needs to be protected from unauthorized RELEASE requests or from unauthorized callers obtaining an ENQ to block this request. The system programmer should check the ISGNQXIT installation exits to ensure that they are not coded to specify an unauthorized QNAME for authorized requests.</p>

<i>Table 31. Return and Reason Codes for the ISGENQ Macro (continued)</i>		
Return Code	Reason Code	Equate Symbol Meaning and Action
04	xxxx040F	<p>Equate Symbol: ISGENQRsn_ECBatleastOneRequestFailed</p> <p>Meaning: For REQUEST=OBTAIN RESLIST=Yes with ECB@, at least one request failed to be processed. Some requests might have been processed unsuccessfully. The system might not backout any successfully processed requests.</p> <p>Note: This reason code is returned in a posted ECB, not through the RSNCODE or RETURNABLE keywords.</p> <p>Action: The user should issue an ISGQUERY on the ENQTOKENs to see if they were obtained and take appropriate action. Alternately, the user can release all the ENQs with a ISGENQ REQUEST=RELEASE with ENQTOKENTBL and reissue the ISGENQ OBTAIN request.</p>
08	—	<p>Equate Symbol: ISGENQRc_ParmError</p> <p>Meaning: ISGENQ request specified parameters in error.</p> <p>Action: Refer to action under the individual reason code.</p>
08	xxxx0801	<p>Equate Symbol: ISGENQRsn_BadPlistAddress</p> <p>Meaning: Unable to access parameter list.</p> <p>Action: Check that the entire parameter list is addressable. If in AR-mode, check that the ALET of the parameter list is correct. Note that if this macro is issued in AR-mode, SYSSTATE ASCENV=AR must be issued before this macro. Ensure that the storage is in the same key as the caller.</p>
08	xxxx0802	<p>Equate Symbol: ISGENQRsn_BadPlistALET</p> <p>Meaning: Bad parameter list ALET. The ALET is neither zero nor is it associated with a valid public entry on the caller's Dispatchable Unit Access List (DU-AL), nor a valid entry for a common area data space.</p> <p>Action: Ensure that the ALET of the parameter list is valid. Its access register may not have been set up properly.</p>
08	xxxx0803	<p>Equate Symbol: ISGENQRsn_BadPlistVersion</p> <p>Meaning: Bad parameter list version number. The service level of GRS on which the caller is running does not support this version of the ISGENQ service, or the ISGENQ parameter list version is lower than the minimum required for parameters that were specified.</p> <p>Action: Check for possible storage overlay of the parameter list. Retry the request with the correct version number. Verify that your program was assembled with the correct macro library for the release of MVS on which your program is running.</p>
08	xxxx0804	<p>Equate Symbol: ISGENQRsn_ReservedFieldNotNull</p> <p>Meaning: A reserved field in the parameter list is non-zero.</p> <p>Action: Check for possible storage overlay of the parameter list.</p>

<i>Table 31. Return and Reason Codes for the ISGENQ Macro (continued)</i>		
Return Code	Reason Code	Equate Symbol Meaning and Action
08	xxxx0805	<p>Equate Symbol: ISGENQRsn_MutuallyExclusive</p> <p>Meaning: Mutually exclusive keywords were specified.</p> <p>Action: Check for a possible storage overlay of the parameter list.</p>
08	xxxx0806	<p>Equate Symbol: ISGENQRsn_BadRequest</p> <p>Meaning: Bad REQUEST parameter.</p> <p>Action: IBM suggests that the ISGENQ macro is used when invoking the ISGENQ service.</p>
08	xxxx0807	<p>Equate Symbol: ISGENQRsn_BadContentionAct</p> <p>Meaning: Bad CONTENTIONACT parameter.</p> <p>Action: Check for possible storage overlay of the parameter list.</p>
08	xxxx0808	<p>Equate Symbol: ISGENQRsn_BadOwningTToken</p> <p>Meaning: The specified TToken does not represent a valid task.</p> <p>Action: Ensure that the task token (TToken) represents a valid task.</p>
08	xxxx0809	<p>Equate Symbol: ISGENQRsn_BadAnsAreaAddress</p> <p>Meaning: Unable to access the answer area.</p> <p>Action: Ensure that the entire answer area is addressable. If in AR-mode, this field is accessed via its address and ALET, check that both these values are correct. Check that the specified answer area length is correct. Ensure that the storage is in the same key as the caller.</p>
08	xxxx080A	<p>Equate Symbol: ISGENQRsn_BadAnsAreaALET</p> <p>Meaning: Bad answer area ALET. The ALET is neither zero nor is it associated with a valid public entry on the caller's Dispatchable Unit Access List (DU-AL), nor a valid entry for a common area data space.</p> <p>Action: Ensure that the ALET of the answer area is valid. Its access register may not have been set up properly.</p>
08	xxxx080B	<p>Equate Symbol: ISGENQRsn_AnsLenTooSmall</p> <p>Meaning: The specified answer area length was too small to return the requested information.</p> <p>Action: Invoke ISGENQ again with a larger answer area. The answer area length needed is dependent on the number of resource requests specified in NUMRES.</p>

<i>Table 31. Return and Reason Codes for the ISGENQ Macro (continued)</i>		
Return Code	Reason Code	Equate Symbol Meaning and Action
08	xxxx080C	<p>Equate Symbol: ISGENQRsn_BadRNameAddress</p> <p>Meaning: Unable to access the RNAME.</p> <p>Action: Ensure that the entire RNAME is addressable. If in AR-mode, this field is accessed via its address and ALET, check that both these values are correct. Check that the specified RNAME length is correct. Ensure that the storage is in the same key as the caller.</p>
08	xxxx080D	<p>Equate Symbol: ISGENQRsn_BadRnameALET</p> <p>Meaning: Bad RNAME ALET. The ALET is neither zero nor is it associated with a valid public entry on the caller's Dispatchable Unit Access List (DU-AL), nor a valid entry for a common area data space.</p> <p>Action: Ensure that the ALET of the RNAME is valid. Its access register may not have been set up properly.</p>
08	xxxx080E	<p>Equate Symbol: ISGENQRsn_BadRNameLen</p> <p>Meaning: The RNAME length specified is not valid.</p> <p>Action: Ensure the RNAME length field contains a number in the range of 1-255.</p>
08	xxxx080F	<p>Equate Symbol: ISGENQRsn_BadScope</p> <p>Meaning: Bad SCOPE keyword parameter.</p> <p>Action: Check for possible storage overlay of the parameter list.</p>
08	xxxx0810	<p>Equate Symbol: ISGENQRsn_BadUCB@</p> <p>Meaning: The storage specified by the UCB@ keyword does not map to a valid UCB.</p> <p>Action: Ensure that the UCB@ points to a valid UCB.</p>
08	xxxx0811	<p>Equate Symbol: ISGENQRsn_BadCond</p> <p>Meaning: Bad COND keyword parameter.</p> <p>Action: IBM suggests that the ISGENQ macro is used when invoking the ISGENQ service.</p>
08	xxxx0812	<p>Equate Symbol: ISGENQRsn_BadSynchRes</p> <p>Meaning: Bad SYNCHRES keyword parameter.</p> <p>Action: Check for possible storage overlay of the parameter list.</p>
08	xxxx0813	<p>Equate Symbol: ISGENQRsn_BadENQTokenAddress</p> <p>Meaning: Unable to access the ENQToken.</p> <p>Action: Ensure that the entire ENQToken is addressable. If in AR-mode, this field is accessed via its address and ALET, check that both these values are correct. Ensure that the storage is in the same key as the caller. Note: The ISGENQ request might not have completed.</p>

<i>Table 31. Return and Reason Codes for the ISGENQ Macro (continued)</i>		
Return Code	Reason Code	Equate Symbol Meaning and Action
08	xxxx0814	<p>Equate Symbol: ISGENQRsn_BadENQTokenALET</p> <p>Meaning: Bad ENQToken ALET. The ALET is neither zero nor is it associated with a valid public entry on the caller's Dispatchable Unit Access List (DU-AL), nor a valid entry for a common area data space.</p> <p>Action: Ensure that the ALET of the ENQToken is valid. Its access register may not have been set up properly. Note: The ISGENQ request might not have completed.</p>
08	xxxx0815	<p>Equate Symbol: ISGENQRsn_BadENQToken</p> <p>Meaning: For REQUEST=RELEASE or REQUEST=CHANGE, the specified ENQToken does not represent an ENQ for the given task (current task or specified by OWNINGTTOKEN).</p> <p>Action: Ensure that the specified ENQToken is from a previous request for the given task, that has not been subsequently released.</p>
08	xxxx0816	<p>Equate Symbol: ISGENQRsn_BadNumRes</p> <p>Meaning: The NUMRES specified is not valid.</p> <p>Action: Ensure the NUMRES field contains a number in the range of 1-65535 (2¹⁶-1)</p>
08	xxxx0817	<p>Equate Symbol: ISGENQRsn_BadResTableAddress</p> <p>Meaning: Unable to access the resource table.</p> <p>Action: Ensure that the entire resource table is addressable. If in AR-mode, this field is accessed via its address and ALET, check that both these values are correct. Check that the resource table length is correct. Ensure that the storage is in the same key as the caller.</p>
08	xxxx0818	<p>Equate Symbol: ISGENQRsn_BadResTableALET</p> <p>Meaning: Bad resource table ALET. The ALET is neither zero nor is it associated with a valid public entry on the caller's Dispatchable Unit Access List (DU-AL), nor a valid entry for a common area data space.</p> <p>Action: Ensure that the ALET of the resource table is valid. Its access register may not have been set up properly.</p>
08	xxxx0819	<p>Equate Symbol: ISGENQRsn_BadResTable</p> <p>Meaning: The RESTABLE specified is not valid.</p> <p>Action: Ensure that the resource table does not specify mutually exclusive parameters.</p>

<i>Table 31. Return and Reason Codes for the ISGENQ Macro (continued)</i>		
Return Code	Reason Code	Equate Symbol Meaning and Action
08	xxxx081A	<p>Equate Symbol: ISGENQRsn_BadENQTokenTblAddress</p> <p>Meaning: Unable to access the ENQToken table.</p> <p>Action: Ensure that the entire ENQToken table is addressable. If in AR-mode, this field is accessed via its address and ALET, check that both these values are correct. Check that the ENQToken table length is correct. Ensure that the storage is in the same key as the caller. Note: The ISGENQ request might not have completed.</p>
08	xxxx081B	<p>Equate Symbol: ISGENQRsn_BadENQTokenTblALET</p> <p>Meaning: Bad ENQToken table ALET. The ALET is neither zero nor is it associated with a valid public entry on the caller's Dispatchable Unit Access List (DU-AL), nor a valid entry for a common area data space.</p> <p>Action: Ensure that the ALET of the ENQToken table is valid. Its access register may not have been set up properly. Note: The ISGENQ request might not have completed.</p>
08	xxxx081C	<p>Equate Symbol: ISGENQRsn_BadReturnTableAddress</p> <p>Meaning: Unable to access the return table.</p> <p>Action: Ensure that the entire return table is addressable. If in AR-mode, this field is accessed via its address and ALET, check that both these values are correct. Check that the return table length is correct. Ensure that the storage is in the same key as the caller. Note: The ISGENQ request might not have completed.</p>
08	xxxx081D	<p>Equate Symbol: ISGENQRsn_BadReturnTableALET</p> <p>Meaning: Bad return table ALET. The ALET is neither zero nor is it associated with a valid public entry on the caller's Dispatchable Unit Access List (DU-AL), nor a valid entry for a common area data space.</p> <p>Action: Ensure that the ALET of the return table is valid. Its access register may not have been set up properly. Note: The ISGENQ request might not have completed.</p>
08	xxxx081E	<p>Equate Symbol: ISGENQRsn_NotAuthorizedForQName</p> <p>Meaning: For REQUEST=OBTAIN. An unauthorized caller specified an authorized QNAME.</p> <p>Action: Unauthorized callers must avoid specifying the authorized QNAMEs listed in the ISGENQ macro prologue.</p>
08	xxxx081F	<p>Equate Symbol: ISGENQRsn_NotAuthorizedForExitQname</p> <p>Meaning: For REQUEST=OBTAIN. An ISGNQXIT exit specified an authorized QNAME for an unauthorized OBTAIN request.</p> <p>Action: Contact your system programmer. The system programmer should check the ISGNQXIT installation exits to ensure they are not coded to specify an authorized QNAME for unauthorized requests.</p>

<i>Table 31. Return and Reason Codes for the ISGENQ Macro (continued)</i>		
Return Code	Reason Code	Equate Symbol Meaning and Action
08	xxxx0821	<p>Equate Symbol: ISGENQRsn_NotAuthorizedForOWNINGTTOKEN</p> <p>Meaning: An unauthorized caller specified OWNINGTTOKEN.</p> <p>Action: Unauthorized callers should avoid specifying OWNINGTTOKEN.</p>
08	xxxx0822	<p>Equate Symbol: ISGENQRsn_BadUserDataAddress</p> <p>Meaning: Unable to access the USERDATA.</p> <p>Action: Ensure that the entire USERDATA is addressable. If in AR-mode, this field is accessed via its address and ALET, check that both these values are correct. Ensure that the storage is in the same key as the caller.</p>
08	xxxx0823	<p>Equate Symbol: ISGENQRsn_BadUserDataAlet</p> <p>Meaning: Bad UserData ALET. The ALET is neither zero nor is it associated with a valid public entry on the caller's Dispatchable Unit Access List (DU-AL), nor a valid entry for a common area data space.</p> <p>Action: Ensure that the ALET of the userdata is valid. Its access register may not have been set up properly.</p>
08	xxxx0824	<p>Equate Symbol: ISGENQRsn_DeviceNotAllocated</p> <p>Meaning: For REQUEST=OBTAIN with RESERVEVOLUME=YES. An unauthorized caller specified a device that is not allocated to the requesting task.</p> <p>Action: Unauthorized callers should allocate the UCB to the job step before ISGENQ RESERVEVOLUME(YES) is issued.</p>
08	xxxx0825	<p>Equate Symbol: ISGENQRsn_ExitDeviceNotAllocated</p> <p>Meaning: For REQUEST=OBTAIN. An ISGNQXIT exit specified a UCB for a device that is not allocated to the requesting, unauthorized task.</p> <p>Action: Contact your system programmer. The system programmer should ensure that the installation exits do not modify the UCB to specify one that is not allocated to an unauthorized requests.</p>
08	xxxx0826	<p>Equate Symbol: ISGENQRsn_BadControl</p> <p>Meaning: Bad CONTROL keyword parameter.</p> <p>Action: Check for possible storage overlay of the parameter list.</p>
08	xxxx0827	<p>Equate Symbol: ISGENQRsn_BadExitUCB@</p> <p>Meaning: The storage pointed to by the UCB address changed by a dynamic exit does not map to a valid UCB.</p> <p>Action: Contact your system programmer. The system programmer should ensure that the installation exits do not specify a bad UCB address.</p>

<i>Table 31. Return and Reason Codes for the ISGENQ Macro (continued)</i>		
Return Code	Reason Code	Equate Symbol Meaning and Action
08	xxxx0828	<p>Equate Symbol: ISGENQRsn_NotAuthorizedForENQMAX</p> <p>Meaning: For REQUEST=OBTAIN, an unauthorized caller specified ENQMAX=NO.</p> <p>Action: Unauthorized callers should avoid specifying ENQMAX=NO.</p>
0C	—	<p>Equate Symbol: ISGENQRc_EnvError</p> <p>Meaning: ISGENQ request has an environment error.</p> <p>Action: Refer to action under the individual reason code.</p>
0C	xxxx0C01	<p>Equate Symbol: ISGENQRsn_RequestLimitExceeded</p> <p>Meaning: For REQUEST=OBTAIN, the limit for the number of concurrent resource requests has been reached. The task does not have control of the resource unless some previous ENQ or RESERVE request caused the task to obtain control of the resource.</p> <p>Action: Retry the request one or more times. If the problem persists, consult your system programmer. For more information on concurrent count limits and how the system can be tuned when necessary, see z/OS MVS Planning: Global Resource Serialization.</p>
0C	xxxx0C05	<p>Equate Symbol: ISGENQRsn_AbendInExit</p> <p>Meaning: One of the GRS dynamic exits abended.</p> <p>Action: Retry the request one or more times. Contact your system programmer.</p>
0C	xxxx0C0A	<p>Equate Symbol: ISGENQRsn_TaskEnding</p> <p>Meaning: The task represented by the specified TToken was ending. The point was reached in task termination after which no ENQs can be obtained.</p> <p>Action: Determine why the task identified by the TToken was ending. Correct that error and retry the request.</p>
0C	xxxx0C0B	<p>Equate Symbol: ISGENQRsn_FRRHeld</p> <p>Meaning: The caller issued ISGENQ when an FRR was established.</p> <p>Action: Avoid issuing ISGENQ when using functional recovery routines.</p>
0C	xxxx0C0C	<p>Equate Symbol: ISGENQRsn_LockHeld</p> <p>Meaning: A lock was held upon entry. No locks can be held when calling ISGENQ.</p> <p>Action: Avoid using ISGENQ when locks are held.</p>

<i>Table 31. Return and Reason Codes for the ISGENQ Macro (continued)</i>		
Return Code	Reason Code	Equate Symbol Meaning and Action
0C	xxxx0C0D	Equate Symbol: ISGENQRsn_SrbMode Meaning: ISGENQ was issued while in SRB mode. Action: Avoid using ISGENQ in SRB mode.
0C	xxxx0C0E	Equate Symbol: ISGENQRsn_NotEnabled Meaning: ISGENQ was issued while not enabled. Action: Avoid using ISGENQ when not enabled.
0C	xxxx0C0F	Equate Symbol: ISGENQRsn_MasidTarget Meaning: The requester to be released is still the target of an ENQ with the MASID and MTCB options specified. The release does complete and the resource might be damaged. Action: The task that issued the ENQ macro instruction with MASID and MTCB should issue the DEQ before this requester does so.
0C	xxxx0C10	Equate Symbol: ISGENQRsn_UnsupportedMode. Meaning: The current GRS mode does not support this specific request. Action: Defer the usage of this particular type of request.
0C	xxxx0C11	Equate Symbol: ISGENQRsn_MasidNotSupported. Meaning: The resource that was the target of this REQUEST=CHANGE,CONTROL=SHARED request currently or at one time contained MASID users. REQUEST=CHANGE,CONTROL=SHARED is not supported for resources that involve MASID requestors. Action: Do not use REQUEST=CHANGE,CONTROL=SHARED on resources that involve MASID requestors.
10	—	Equate Symbol: ISGENQRc_CompError Meaning: Component Error. Action: Contact the IBM Support Center. Reason code that are not defined below contain internal diagnostic information.
10	xxxx1002	Equate Symbol: ISGENQRsn_CannotObtainHomeStorage Meaning: ISGENQ processing could not obtain storage in the home address space.
10	xxxx1003	Equate Symbol: ISGENQRsn_CannotObtainCommonStorage Meaning: ISGENQ processing could not obtain storage in the common area.
10	xxxx1004	Equate Symbol: ISGENQRsn_CannotObtainPrimaryAlet Meaning: ISGENQ processing could not obtain the ALET of the caller's primary address space.

Table 31. Return and Reason Codes for the ISGENQ Macro (continued)		
Return Code	Reason Code	Equate Symbol Meaning and Action
10	xxxx1006	Equate Symbol: ISGENQRsn_SynchResFlushFailed Meaning: For REQUEST=OBTAIN, a synchronous reserve failed device state transition flushing.
10	xxxx1007	Equate Symbol: ISGENQRsn_ReserveStartFailed Meaning: For REQUEST=OBTAIN, reserve start processing failed.
10	xxxx1008	Equate Symbol: ISGENQRsn_ReserveCountOverflow Meaning: For REQUEST=OBTAIN, reserve processing detected an overflow when updating the reserve count.
10	xxxx1009	Equate Symbol: ISGENQRsn_CannotObtainDSQE Meaning: ISGENQ processing could not obtain a DSQE to suspend a request during an RNL change.
10	xxxx100A	Equate Symbol: ISGENQRsn_ReserveDoneFailed Meaning: For REQUEST=OBTAIN, synchronous reserve back-end processing has failed; therefore, the reserve was never completed.
10	xxxx100B	Equate Symbol: ISGENQRsn_CannotObtainPrimaryStorage Meaning: ENQ/DEQ processing could not obtain storage in the primary address space.

Examples

Use these examples as a guide.

```

* *****
* Request exclusive control of a single resource
* *****

        ISGENQ REQUEST=OBTAIN,QNAME=QAM1,RNAME=RNAM1,RNAMELEN=RLEN1, X
          SCOPE=SYSTEMS,CONTROL=EXCLUSIVE,ENQTOKEN=ENQT1

* *****
* Release control of a single resource
* *****

        ISGENQ REQUEST=RELEASE,ENQTOKEN=ENQT1,COND=YES,          X
          RETCODE=(3),RSNCODE=(2)

* *****
* Conditionally request shared control of 3 resources
* *****

        ISGENQ REQUEST=OBTAIN,RESLIST=YES,NUMRES=3,RESTABLE=RSTBL, X
          ENQTOKENBL=ETTBL,RETURNTABLE=RTTBL,COND=YES,          X
          RETCODE=(3),RSNCODE=(2),PLISTVER=1

QAM1    DC    CL8'QNAME1'
RNAM1   DC    CL10'RNAME1'
RLEN1   DC    AL1(L'RNAM1)
RNAM2   DC    CL12'RNAME2'
RNAM3   DC    CL14'RNAME3'
        DS    0D
RSTBL   DS    0CL(3*ISGYENQRES_LEN)
ENTRY1  DC    CL8'QNAME1'          QNAME
        DC    F'0'                FIRST WORD OF RNAME ADDR
        DC    A(RNAM1)            RNAME ADDR31

```

```

DC      F'0'          RNAME ALET
DC      A(0)         UCB@
DC      AL1(L'RNAM1) RNAME LENGTH
DC      AL1(ISGYENQ_kSTEP)
DC      AL1(ISGYENQ_kCONTROLSHARED)
DC      XL1'00'      FLAGS
DC      XL4'00'      RESERVED
ENTRY2  DC      CL8'QNAME2' QNAME
DC      F'0'          FIRST WORD OF RNAME ADDR
DC      A(RNAM2)     RNAME ADDR31
DC      F'0'          RNAME ALET
DC      A(0)         UCB@
DC      AL1(L'RNAM2) RNAME LENGTH
DC      AL1(ISGYENQ_kSYSTEM)
DC      AL1(ISGYENQ_kCONTROLSHARED)
DC      XL1'00'      FLAGS
DC      XL4'00'      RESERVED
ENTRY3  DC      CL8'QNAME3' QNAME
DC      F'0'          FIRST WORD OF RNAME ADDR
DC      A(RNAM3)     RNAME ADDR31
DC      F'0'          RNAME ALET
DC      A(0)         UCB@
DC      AL1(L'RNAM3) RNAME LENGTH
DC      AL1(ISGYENQ_kSYSTEMS)
DC      AL1(ISGYENQ_kCONTROLSHARED)
DC      XL1'00'      FLAGS
DC      XL4'00'      RESERVED

DYNAREA DSECT
ENQT1   DS      CL(ISGYENQTOKEN_LEN)
ETTBL   DS      CL(3*ISGYENQTOKEN_LEN)
RTTBL   DS      CL(3*ISGYENQRETURN_LEN)
* *****
* Request exclusive control of a single resource with userdata
* *****
      ISGENQ REQUEST=OBTAIN,QNAME=QNAME1,RNAME=RNAME1,RNAMELEN=RLEN1, X
      SCOPE=SYSTEMS,CONTROL=EXCLUSIVE,ENQTOKEN=ENQT1, X
      USERDATA=UDATA1

UDATA1  DC      CL32'MY USERDATA'

```

For more information on global resource serialization, see [z/OS MVS Planning: Global Resource Serialization](#).

Chapter 61. ISGQUERY – Global resource serialization query service

Description

The GRS query service routine is given control from the ISGQUERY macro to:

- Search a resource name list (RNL) for a QNAME/RNAME pair.
- Obtain information on resources and requesters of outstanding ENQ requests.

Environment

The requirements for the caller are:

Environmental factor	Requirement
Minimum authorization:	Problem state. Any PSW key
Dispatchable unit mode:	Task
Cross memory mode:	Any PASN, any HASN, any SASN
AMODE:	31- or 64-bit If in AMODE 64, specify SYSSTATE AMODE64=YES before invoking this macro.
ASC mode:	Primary or access register (AR) If in Access Register ASC mode, specify SYSSTATE ASCENV=AR before invoking this macro.
Interrupt status:	Enabled for I/O and external interrupts
Locks:	For REQINFO=RNLSEARCH, the caller can be unlocked or hold both a local lock (LOCAL or CML) and the CMSEQDQ lock. For REQINFO=QSCAN, the caller must not hold any locks.
Control parameters:	Control parameters must be in the primary address space or for AR-mode callers, must be in an address/data space that is addressable through a public entry on the caller's dispatchable unit access list (DU-AL). The control parameters must be in the same key as the caller. For an AMODE 64 caller, the control parameters can reside in virtual storage above the 2G bar. The user-provided answer area that uses the ANSAREA parameter has the same requirements and restrictions as the control parameters.

Programming requirements

The caller must include the ISGYQUAC macro to get a mapping for the answer area.

Note: The ISGYQUAC macro is stabilized as of z/OS R12.

The caller must include the ISGYCON macro to get the values for the return and reason codes.

The caller must include the ISGRNLE macro to get a mapping for the RNLE.

Restrictions

Do not issue ISGQUERY before the GRS address space has been initialized.

There is a restriction on the number of concurrent resource requests in an address space. These include unauthorized ISGENQ, ENQ, RESERVE, and incomplete QSCAN and ISGQUERY requests. Reason code ISGQUERYRsn_MaxConcurrentRequests is issued if ISGQUERY would cause this limit to be exceeded.

When multilevel security support is active on the system, unauthorized callers of ISGQUERY who specify REQINFO=QSCAN must have at least READ authorization to the ISG.QSCANSERVICES.AUTHORIZATION resource in the FACILITY class. When multilevel security support is active on the system, unauthorized callers of ISGQUERY who specify REQINFO=LATCHECA must have at least READ authorization to the ISG.LATCHECASERVICES.AUTHORIZATION resource in the FACILITY class. You can activate the multilevel security support through the SETROPTS MLACTIVE option in RACF. For general information about defining profiles in the FACILITY class, see [z/OS Security Server RACF Command Language Reference](#) and [z/OS Security Server RACF Security Administrator's Guide](#). For information about multilevel security, see [z/OS Planning for Multilevel Security and the Common Criteria](#).

Callers who specify REQINFO=LATCHECA must not hold any FRRs.

This macro supports multiple versions. Some keywords are unique to certain versions. For more information, see the description of the [“,PLISTVER=IMPLIED_VERSION”](#) on page 490 parameter and the common criteria.

Input register information

Before issuing the ISGQUERY macro, the caller does not have to place any information into any general-purpose register (GPR) or access register (AR) unless using it in register notation for a particular parameter, or using it as a base register.

Output register information

When control returns to the caller, the GPRs contain:

Register

Contents

0

Reason code if GPR15 is not 0.

1

Used as a work register by the system.

2-13

Unchanged

14

Used as a work register by the system.

15

Return code.

When control returns to the caller, the ARs contain:

Register

Contents

0-1

Used as work registers by the system.

2-13

Unchanged

14-15

Used as work registers by the system.

Some callers depend on register contents remaining the same before and after issuing a service. If the system changes the contents of registers on which the caller depends, the caller must save them before issuing the service, and restore them after the system returns control.

Performance implications

In general, the narrower the search parameters (particularly QNAME and RNAME), the less time the query takes. Using both a specific QNAME and a specific RNAME gives better performance than using patterns.

The use of GATHERFROM=SYSPLEX might greatly degrade the performance of the query request.

Polling for ENQ contention through QSCAN or ISGQUERY is not recommended. See the *z/OS MVS Planning: Global Resource Serialization* and *z/OS MVS Programming: Authorized Assembler Services Guide* for more information about monitoring contention through ENF 51.

Syntax

ISGQUERY syntax

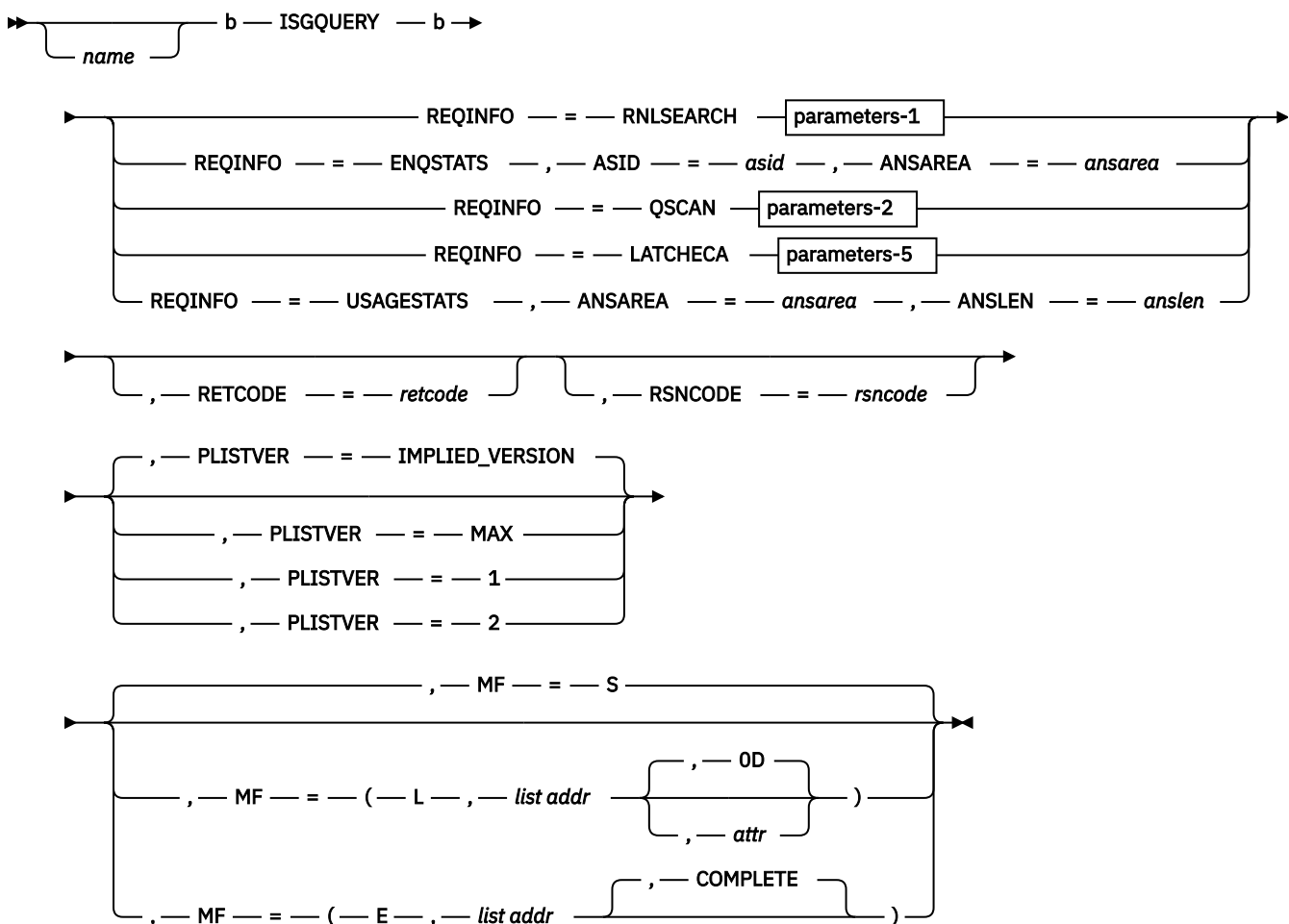

parameters-1

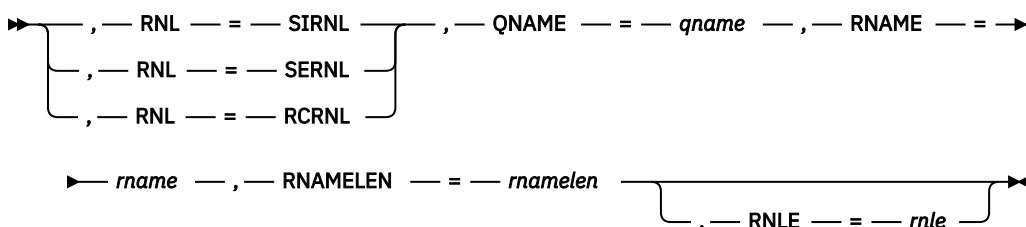

parameters-2

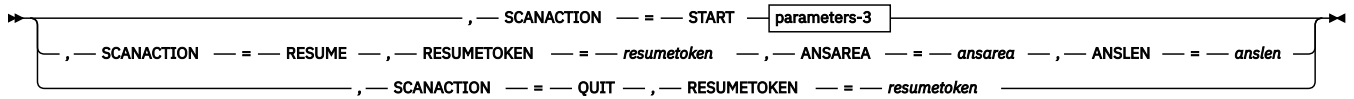

parameters-3

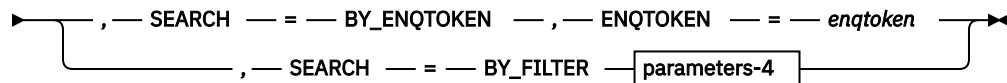
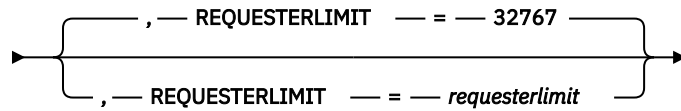
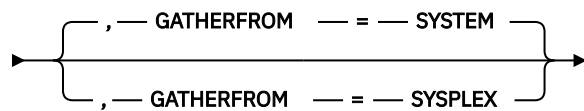
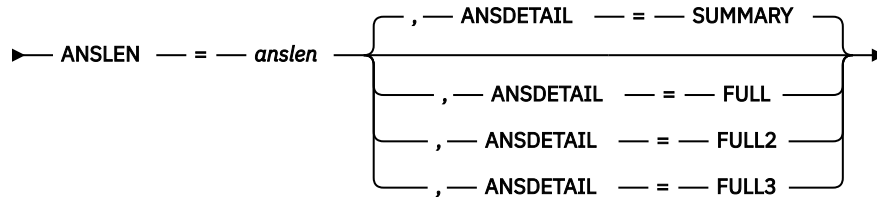
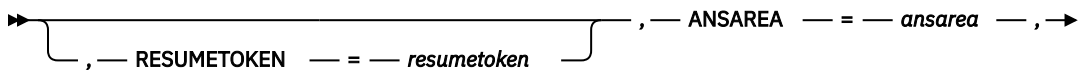

parameters-4

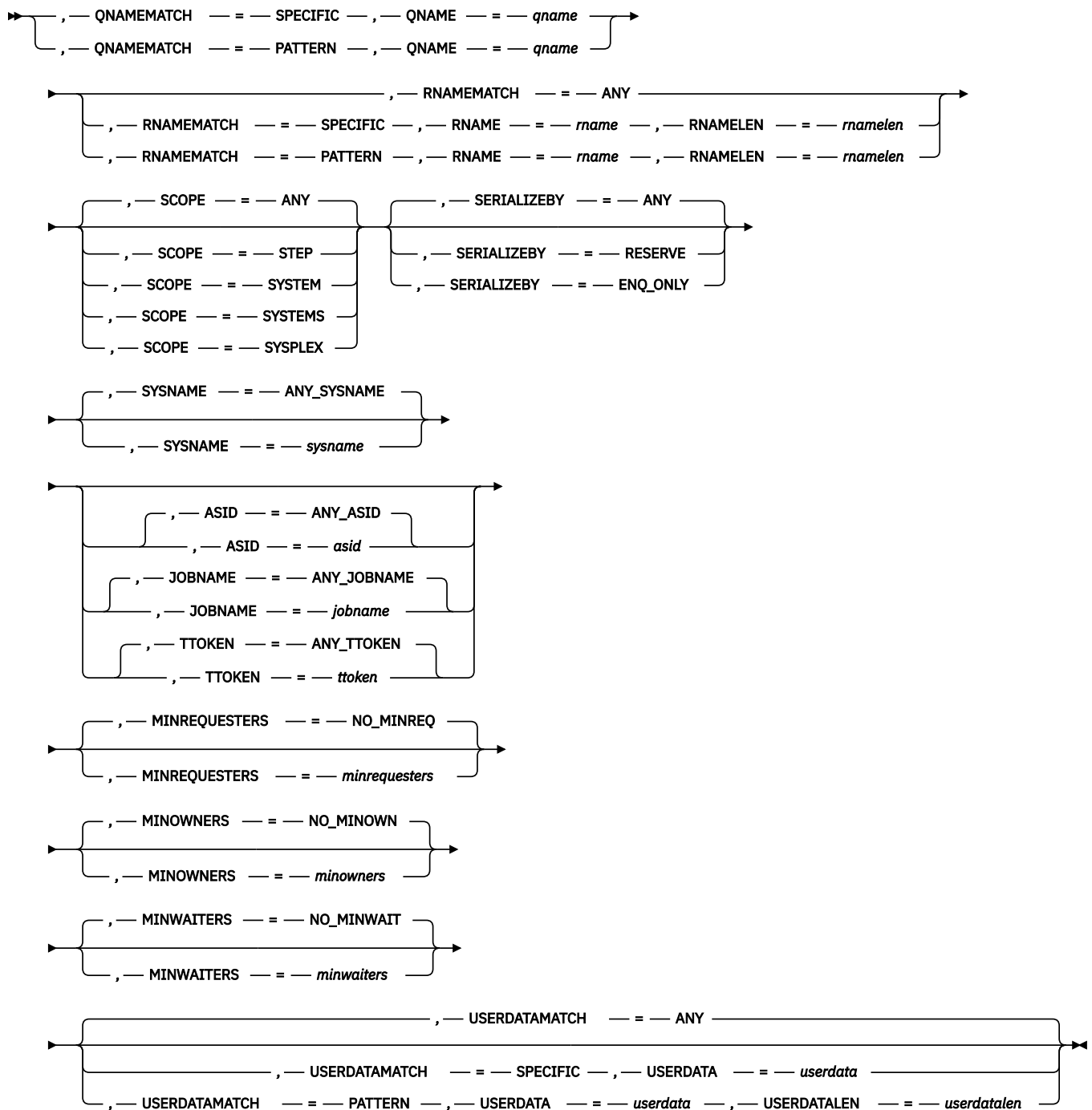

parameters-5

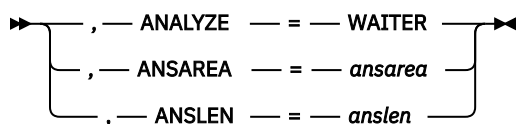

Parameters

The parameters are explained as follows:

name

An optional symbol, starting in column 1 that is the name on the ISGQUERY macro invocation. The name must conform to the rules for an ordinary assembler language symbol.

,ANALYZE=WAITER

When REQINFO=LATCHECA is specified, a required output parameter, which queries LATCHECA waiter data to determine if any long-term latch contention exists that might be cause for concern. ISGQUERY returns only LATCHECA data for waiters.

,ANSAREA=ansarea

When REQINFO=ENQSTATS is specified, a required output parameter, which is to contain the returned information. The area is mapped by macro ISGYQUAC. A header area, which is mapped by DSECT ISGYQUAAHdr, is returned followed by additional data, two entries mapped by ISGYQUAASys and two entries mapped by ISGYQUAASp.

To code: Specify the RS-type address, or address in register (2)-(12), of a character field.

,ANSAREA=ansarea

When REQINFO=LATCHECA is specified, a required output parameter, which is to contain the returned information. The area is mapped by macro ISGYQUAC. A header area, which is mapped by DSECT ISGYQUAAHdr, is returned followed by additional data mapped by ISGYQUAALd and ISGYQUAALrd.

To code: Specify the RS-type address, or address in register (2)-(12), of a character field.

,ANSAREA=ansarea

When REQINFO=USAGESTATS is specified, a required output parameter, which is to contain the returned information. The area is mapped by macro ISGYQUAC. A header area, which is mapped by DSECT ISGYQUAAHdrUs, is returned followed by additional data mapped by ISGYQUAAUs.

To code: Specify the RS-type address, or address in register (2)-(12), of a character field.

,ANSAREA=ansarea

When REQINFO=QSCAN is specified, this required output parameter contains the returned information. The area is mapped by macro ISGYQUAC. A header area, which is mapped by DSECT ISGYQUAAHdr, is returned followed by additional data mapped by ISGYQUAARs, ISGYQUAARsx, ISGYQUAARq, and ISGYQUAARqx.

Note: The ANSDetail specified determines which data is returned.

To code: Specify the RS-type address, or address in register (2)-(12), of a character field.

,ANSDetail=SUMMARY**,ANSDetail=FULL****,ANSDetail=FULL2****,ANSDetail=FULL3**

When SCANACTION=START and REQINFO=QSCAN are specified, an optional parameter that indicates the detail level of the information that should be returned in the answer area. The default is ANSDetail=SUMMARY.

,ANSDetail=SUMMARY

Indicates to return only ISGYQUAAHdr, ISGYQUAARs, and ISGYQUAARq answer area data records. See ISGYQUAC mapping macro to know what data is returned in each type of record.

,ANSDetail=FULL

Indicates to return ISGYQUAAHdr, ISGYQUAARs, ISGYQUAARq, and ISGYQUAARqx answer area data records. See ISGYQUAC mapping macro to know what data is returned in each type of record.

,ANSDetail=FULL2

Indicates that in addition to the records returned by ANSDetail=FULL, the ISGYQUAARsx, and the larger FULL2 version of the ISGYQUAARqx is returned. See ISGYQUAC mapping macro to know what data is returned in each type of record.

,ANSDetail=FULL3

Indicates that in addition to the records returned by ANSDetail=FULL2, USERDATA is returned for any records that specified USERDATA on ISGENQ.

Note: When GATHERFROM=SYSPLEX is specified and GRS is operating in STAR mode, USERDATA is not returned for any global requests. See ISGYQUAC mapping macro to know what data is returned in each type of record.

,ANSLEN=anslen

When SCANACTION=START and REQINFO=QSCAN are specified, a required input parameter that is the length of the answer area provided. The minimum size is the amount needed to describe a single resource with a single requester. Use an answer area length of at least 4 KB.

- For ANSDetail=SUMMARY, the minimum is defined by constant ISGYQUAA_kQSCANMinSummaryAnslen.
- For ANSDetail=FULL, the minimum is defined by constant ISGYQUAA_kQSCANMinFullAnslen.
- For ANSDetail=FULL2, the minimum is defined by constant ISGYQUAA_kQSCANMinFull2Anslen.
- For ANSDetail=FULL3, the minimum is defined by constant ISGYQUAA_kQSCANMinFull3Anslen.

The length of the answer area is at least 4k.

To code: Specify the RS-type address, or address in register (2)-(12), of a fullword field, or specify a literal decimal value.

,ANSLEN=anslen

When SCANACTION=RESUME and REQINFO=QSCAN are specified, a required input parameter that is the length of the answer area provided. The minimum size is the amount needed to describe a single resource with a single requester. Use an answer area length of at least 4 KB. For ANSDetail=SUMMARY, the minimum is defined by constant ISGYQUAA_kQSCANMinSummaryAnslen. For ANSDetail=FULL, the minimum is defined by constant ISGYQUAA_kQSCANMinFullAnslen. For ANSDetail=FULL2, the minimum is defined by constant ISGYQUAA_kQSCANMinFull2Anslen. For ANSDetail=FULL3, the minimum is defined by constant ISGYQUAA_kQSCANMinFull3Anslen. use an answer area length of at least 4 KB.

To code: Specify the RS-type address, or address in register (2)-(12), of a fullword field, or specify a literal decimal value.

,ANSLEN=anslen

When REQINFO=LATCHECA is specified, a required input parameter that is the length of the answer area provided. The minimum size is the amount needed to describe a single resource with a single requester. Use an answer area length of at least 4 K.

To code: Specify the RS-type address, or address in register (2)-(12), of a fullword field, or specify a literal decimal value.

,ANSLEN=anslen

When REQINFO=USAGESTATS is specified, a required input parameter that is the length of the answer area provided. The minimum size is the amount needed to describe the ENQ, QScan, and latch usage of a single address space and the usage information for terminated address spaces. The minimum is defined by constant ISGYQUAA_kUSAGESTATSMInAnslen. Use an answer area length of at least 4 KB.

To code: Specify the RS-type address, or address in register (2)-(12), of a fullword field, or specify a literal decimal value.

,ASID=asid

When REQINFO=ENQSTATS is specified, a required input parameter that is the ASID of the address space-specific information to be returned.

Note: ASIDs are reusable. Once an address space has terminated another can be created with the same ASID.

To code: Specify the RS-type address, or address in register (2)-(12), of a halfword field, or specify a literal decimal value.

,ASID=asid**,ASID=ANY_ASID**

When SEARCH=BY_FILTER, SCANACTION=START and REQINFO=QSCAN are specified, an optional input parameter that is the ASID of the requesting tasks for which resource information is to be returned. Only information on requester with that ASID is returned.

Note: ASID is reusable. Once an address space has terminated another can be created with the same ASID.

The default is ANY_ASID.

To code: Specify the RS-type address, or address in register (2)-(12), of a halfword field, or specify a literal decimal value.

,ENQTOKEN=*enqtoken*

When SEARCH=BY_ENQTOKEN, SCANACTION=START and REQINFO=QSCAN are specified, a required input parameter that is the ENQToken of the request that is to be queried. Note: ENQTokens are only valid on the system where the ENQ request was made.

To code: Specify the RS-type address, or address in register (2)-(12), of a 32-character field.

,GATHERFROM=SYSTEM

,GATHERFROM=SYSPLEX

When SCANACTION=START and REQINFO=QSCAN are specified, an optional parameter that designates the extent to which the search is taken. Information about other systems is always available locally in a global resource serialization ring complex, so this keyword is ignored and forced to GATHERFROM=SYSTEM.

Use the SYSNAME keyword to obtain only information about one particular system.

Note: Only SYSTEMS scope information is obtained from other systems in the global resource serialization complex.

The default is GATHERFROM=SYSTEM.

,GATHERFROM=SYSTEM

Indicates to search only the caller's system. The answer area data contains information about requester on other systems in the complex only if that information is already available on the caller's system. The returned information might be incomplete regarding requester on other systems, including counts of the number of requester for a resource. If performance is an issue, use GATHERFROM=SYSTEM. This request is always handled without placing the caller's dispatchable unit into a wait.

,GATHERFROM=SYSPLEX

Indicates to search the caller's sysplex. The answer area data contains information about requesters in the entire sysplex. If complete information regarding requesters in the sysplex is required use GATHERFROM=SYSPLEX. There are significant performance implications for this search and the caller might be suspended while the information is being gathered. Do not specify GATHERFROM=SYSPLEX if this condition cannot be tolerated.

GATHERFROM=SYSPLEX is mutually exclusive with the USERDATAMATCH=SPECIFIC and USERDATAMATCH=PATTERN filter options.

When global resource serialization is in STAR mode, GATHERFROM=SYSPLEX with ANSDetail=FULL3 results in no user data being returned for global requests.

,JOBNAME=*jobname*

,JOBNAME=ANY_JOBNAME

When SEARCH=BY_FILTER, SCANACTION=START and REQINFO=QSCAN are specified, an optional input parameter that is the job name of the requesting tasks for which resource information is to be returned. Only information on requesters with that job name is returned. The default is ANY_JOBNAME.

To code: Specify the RS-type address, or address in register (2)-(12), of an 8-character field.

,MF=S

,MF=(L,*list addr*)

,MF=(L,*list addr,attr*)

,MF=(L,*list addr,OD*)

,MF=(E,*list addr*)

,MF=(E,*list addr,COMPLETE*)

An optional input parameter that specifies the macro form.

Use MF=S to specify the standard form of the macro, which builds an inline parameter list and generates the macro invocation to transfer control to the service. MF=S is the default.

Use MF=L to specify the list form of the macro. Use the list form together with the execute form of the macro for applications that require reentrant code. The list form defines an area of storage that the execute form uses to store the parameters. Only the PLISTVER parameter can be coded with the list form of the macro.

Use MF=E to specify the execute form of the macro. Use the execute form together with the list form of the macro for applications that require reentrant code. The execute form of the macro stores the parameters into the storage area defined by the list form, and generates the macro invocation to transfer control to the service.

,list addr

The name of a storage area to contain the parameters. For MF=S and MF=E, this can be an RS-type address or an address in register (1)-(12).

,attr

An optional 1- to 60-character input string that you use to force boundary alignment of the parameter list. Use a value of OF to force the parameter list to a word boundary, or OD to force the parameter list to a doubleword boundary. If you do not code *attr*, the system provides a value of OD.

,COMPLETE

Specifies that the system is to check for required parameters and supply defaults for omitted optional parameters.

,MINOWNERS=*minowners*

,MINOWNERS=NO_MINOWN

When SEARCH=BY_FILTER, SCANACTION=START and REQINFO=QSCAN are specified, an optional input parameter that is the minimum number of owners of a resource required for that resource to be returned. If any of the conditions specified by MINREQUESTERS, MINOWNERS, or MINWAITERS is met, even if the other two are not met, information for that resource and its requester is returned. The default is NO_MINOWN.

To code: Specify the RS-type address, or address in register (2)-(12), of a fullword field, or specify a literal decimal value.

,MINREQUESTERS=*minrequesters*

,MINREQUESTERS=NO_MINREQ

When SEARCH=BY_FILTER, SCANACTION=START and REQINFO=QSCAN are specified, an optional input parameter that is the minimum number of owners plus waiters for a resource required for that resource to be returned. If any of the conditions specified by MINREQUESTERS, MINOWNERS, or MINWAITERS is met, even if the other two are not met, information for that resource and its requesters is returned. The default is NO_MINREQ.

To code: Specify the RS-type address, or address in register (2)-(12), of a fullword field, or specify a literal decimal value.

,MINWAITERS=*minwaiters*

,MINWAITERS=NO_MINWAIT

When SEARCH=BY_FILTER, SCANACTION=START and REQINFO=QSCAN are specified, an optional input parameter that is the minimum number of waiters for a resource required for that resource to be returned. If any of the conditions specified by MINREQUESTERS, MINOWNERS, or MINWAITERS is met, even if the other two are not met, information for that resource and its requester is returned. The default is NO_MINWAIT.

To code: Specify the RS-type address, or address in register (2)-(12), of a fullword field, or specify a literal decimal value.

,PLISTVER=IMPLIED_VERSION**,PLISTVER=MAX****,PLISTVER=1****,PLISTVER=2**

An optional input parameter in the 1-2 range that specifies the version of the macro. PLISTVER determines which parameter list the system generates. PLISTVER is an optional input parameter on all forms of the macro, including the list form. When using PLISTVER, specify it on all macro forms used for a request and with the same value on all of the macro forms. The values are:

- **IMPLIED_VERSION**, which is the lowest version that allows all parameters specified on the request to be processed. If you omit the PLISTVER parameter, IMPLIED_VERSION is the default.
- **MAX**, if you want the parameter list to be the largest size currently possible. This size might grow from release to release and affect the amount of storage that your program needs.

If you can tolerate the size change, IBM recommends that you always specify PLISTVER=MAX on the list form of the macro. Specifying MAX ensures that the list-form parameter list is always long enough to hold all the parameters you might specify on the execute form, when both are assembled with the same level of the system. In this way, MAX ensures that the parameter list does not overwrite nearby storage.

- **1**, if you use the currently available parameters:
 - ANSAREA
 - ANSDetail
 - ANSLen
 - ASID
 - ENQToken
 - GATHERFROM
 - JOBNAME
 - MINOWNERS
 - MINREQUESTERS
 - MINWAITERS
 - QNAME
 - QNAMEMATCH
 - REQINFO
 - REQUESTERLIMIT
 - RESUMETOKEN
 - RNAME
 - RNAMELEN
 - RNAMEMATCH
 - RNL
 - RNLE
 - SCANACTION
 - SCOPE
 - SEARCH
 - SERIALIZEBY
 - SYSNAME
 - TToken
- **2**, which supports both the following parameters and those from version 1:
 - USERDATA

- USERDATALEN
- USERDATAMATCH

To code: Specify one of the following:

- IMPLIED_VERSION
- MAX
- A decimal value of 1, or 2

,QNAME=qname

When REQINFO=RNLSEARCH is specified, a required input parameter that is the Qname of the resource for which the RNLs are to be searched.

To code: Specify the RS-type address, or address in register (2)-(12), of an 8-character field.

,QNAME=qname

When QNAMEMATCH=SPECIFIC, SEARCH=BY_FILTER, SCANACTION=START and REQINFO=QSCAN are specified, a required input parameter that is the specific Qname of the resources to be returned.

To code: Specify the RS-type address, or address in register (2)-(12), of an 8-character field.

,QNAME=qname

When QNAMEMATCH=PATTERN, SEARCH=BY_FILTER, SCANACTION=START and REQINFO=QSCAN are specified, a required input parameter that is a pattern Qname to match the resources to be returned.

The Qname pattern is 8 characters where "?" matches any single character, and "*" matches any string of zero or more characters.

Note: All trailing blanks are ignored when matching Qnames to Qname patterns.

To code: Specify the RS-type address, or address in register (2)-(12), of an 8-character field.

,QNAMEMATCH=SPECIFIC

,QNAMEMATCH=PATTERN

When SEARCH=BY_FILTER, SCANACTION=START and REQINFO=QSCAN are specified, a required parameter.

,QNAMEMATCH=SPECIFIC

Indicates to only return information on resources that exactly match the specified specific Qname.

,QNAMEMATCH=PATTERN

Indicates to only return information on resources that match the specified Qname pattern.

REQINFO=RNLSEARCH

REQINFO=ENQSTATS

REQINFO=QSCAN

REQINFO=LATCHECA

REQINFO=USAGESTATS

A required parameter that designates the data to be returned.

REQINFO=RNLSEARCH

Indicates to search a specific RNL for a resource name.

Therefore, the CMSEQDQ lock serializes the use of the RNLs, so holding this lock ensures that the RNL does not change and the returned RNLE is valid on the current RNLs.

During an RNL change, the currently active RNLs are searched.

For more information about how a resource can be changed by the system, see the TEST=YES function in [Chapter 60, "ISGENQ – Global resource serialization ENQ service," on page 449.](#)

REQINFO=ENQSTATS

Indicates to return information related to ENQ counts.

REQINFO=QSCAN

Indicates to search the global resource serialization queues for resource and requester information.

REQINFO=LATCHECA

Indicates to search the global resource serialization queues for query latch enhanced contention analysis (ECA) data for waiters that might indicate contention issues.

Note: The LATCHECA search does not return data for blockers or dependency data.

REQINFO=USAGESTATS

Indicates to search the global resource serialization queues for address space level contention information related to ENQs (all scopes) and latches (all latch sets). Global resource serialization gathers latch statistics in requester and latch set owner address space categories. The statistics are provided for all address spaces as follows:

- ENQ by scope: this includes contention counts, total delay times, and the sum of the squared delay (SUMSQ) times. The SUMSQ times can be used to compute the standard deviation.
- Latch: For both requester and latch set owners, this includes contention counts, total delay times, and the sum of the squared delay (SUMSQ) times
- ENQ usage counts.

Note: Latch counts are kept in “fast counts” in latch sets and not on an address space basis.

,REQUESTERLIMIT=requesterlimit**,REQUESTERLIMIT=32767**

When SCANACTION=START and REQINFO=QSCAN are specified, an optional input parameter that is the maximum number of requesters (owners and waiters) to be returned for each individual resource. Only resource-related information is returned if 0 is specified. The value range of REQUESTERLIMIT is 0 to 2¹⁵-1 (32767). The default is 32767.

To code: Specify the RS-type address, or address in register (2)-(12), of a halfword field, or specify a literal decimal value.

,RESUMETOKEN=resumetoken

When SCANACTION=START and REQINFO=QSCAN are specified, an optional output parameter that is the resume token for this search. When RESUMETOKEN is specified, a reason code of ISGQUERYRsn_AnswerAreaFull indicates that the token can be used to resume the scan on a subsequent call. Subsequently, if the return code indicates that the search can be resumed, a SCANACTION=RESUME or SCANACTION=QUIT with the returned resume token must be issued.

To code: Specify the RS-type address, or address in register (2)-(12), of a 16-character field.

,RESUMETOKEN=resumetoken

When SCANACTION=RESUME and REQINFO=QSCAN are specified, a required input/output parameter that is the resume token from a previously started search. If the search does not complete the resume token can be used to resume the search on a subsequent call. Check the return code to determine if the resume token can be used to resume the scan. Subsequently, if the return code indicates that the search can be resumed, a SCANACTION=RESUME or SCANACTION=QUIT with the returned resume token must be issued.

To code: Specify the RS-type address, or address in register (2)-(12), of a 16-character field.

,RESUMETOKEN=resumetoken

When SCANACTION=QUIT and REQINFO=QSCAN are specified, a required input/output parameter that is the resume token from a previously started search. Any global resource serialization storage associated with the search is freed, and the resume token is cleared to binary zeros.

To code: Specify the RS-type address, or address in register (2)-(12), of a 16-character field.

,RETCODE=retcode

An optional output parameter into which the return code is to be copied from GPR 15. If you specify 15, GPR15, REG15, or R15 (within or without parentheses), the value will be left in GPR 15.

To code: Specify the RS-type address of a fullword field, or register (2)-(12) or (15), (GPR15), (REG15), or (R15).

,RNAME=rname

When REQINFO=RNLSEARCH is specified, a required input parameter that is the RName of the resource for which the RNLs are to be searched.

The RName pattern is a string of characters where "?" matches any single character, and "*" matches any string of zero or more characters.

To code: Specify the RS-type address, or address in register (2)-(12), of a character field.

,RNAME=rname

When RNAMEMATCH=SPECIFIC, SEARCH=BY_FILTER, SCANACTION=START and REQINFO=QSCAN are specified, a required input parameter that is the specific RName of the resources to be returned.

To code: Specify the RS-type address, or address in register (2)-(12), of a character field.

,RNAME=rname

When RNAMEMATCH=PATTERN, SEARCH=BY_FILTER, SCANACTION=START and REQINFO=QSCAN are specified, a required input parameter that is a pattern RName to match the resources to be returned. The RName pattern is a string of characters where '?' matches any single character, and '*' matches any string of zero or more characters.

To code: Specify the RS-type address, or address in register (2)-(12), of a character field.

,RNAMELEN=rnamelen

When REQINFO=RNLSEARCH is specified, a required input parameter that is the length of the RName. The specified length can be 1 - 255.

To code: Specify the RS-type address, or address in register (2)-(12), of a one-byte field.

,RNAMELEN=rnamelen

When RNAMEMATCH=SPECIFIC, SEARCH=BY_FILTER, SCANACTION=START and REQINFO=QSCAN are specified, a required input parameter that is the length of the RName. The specified length can be 1 - 255.

To code: Specify the RS-type address, or address in register (2)-(12), of a 1-byte field.

,RNAMELEN=rnamelen

When RNAMEMATCH=PATTERN, SEARCH=BY_FILTER, SCANACTION=START and REQINFO=QSCAN are specified, a required input parameter that is the length of the RName pattern. The specified length can be 1 - 255.

To code: Specify the RS-type address, or address in register (2)-(12), of a 1-byte field.

,RNAMEMATCH=ANY

,RNAMEMATCH=SPECIFIC

,RNAMEMATCH=PATTERN

When SEARCH=BY_FILTER, SCANACTION=START and REQINFO=QSCAN are specified, a required parameter.

,RNAMEMATCH=ANY

Indicates to return information on resources with any RName.

,RNAMEMATCH=SPECIFIC

Indicates to return information on resources that exactly match the specified specific RName.

,RNAMEMATCH=PATTERN

Indicates to return information on resources that match the specified RName pattern.

,RNL=SIRNL

,RNL=SERNL

,RNL=RCRNL

When REQINFO=RNLSEARCH is specified, a required parameter that indicates which resource name list (RNL) is to be searched.

,RNL=SIRNL

Indicates to search the system inclusion RNL.

,RNL=SERNL

Indicates to search the systems exclusion RNL.

,RNL=RCRNL

Indicates to search the reserve conversion RNL.

,RNLE=rnle

When REQINFO=RNLSEARCH is specified, an optional output parameter that is a copy of the matching RNLE. The caller must include the ISGRNLE macro to get a mapping for the RNLE.

Note: The RNLE returned depends on the version of the parameter list. If a new version of the RNLE should be introduced, it might require a larger character field. Explicitly state the PLISTVER to ensure that the size of the RNLE returned does not change.

To code: Specify the RS-type address, or address in register (2)-(12), of a character field.

,RSNCODE=rsncode

An optional output parameter into which the reason code is to be copied from GPR 0. If you specify 0, 00, GPR0, GPR00, REG0, REG00, or R0 (within or without parentheses), the value is left in GPR 0.

To code: Specify the RS-type address of a fullword field, or register (0) or (2)-(12), (00), (GPR0), (GPR00), (REG0), (REG00), or (R0).

,SCANACTION=START**,SCANACTION=RESUME****,SCANACTION=QUIT**

When REQINFO=QSCAN is specified, a required parameter that designates whether to start, resume, or quit a QScan.

,SCANACTION=START

Indicates to start a search of the global resource serialization queues.

,SCANACTION=RESUME

Indicates to resume a previously started search.

,SCANACTION=QUIT

Indicates to quit a previously started search. If a started search has not completed, it must be either resumed until it completes or ended with SCANACTION=QUIT.

,SCOPE=ANY**,SCOPE=STEP****,SCOPE=SYSTEM****,SCOPE=SYSTEMS****,SCOPE=SYSPLEX**

When SEARCH=BY_FILTER, SCANACTION=START and REQINFO=QSCAN are specified, an optional parameter that is the scope of the resources to be returned.

Note: Only information on resources with scope of SYSTEMS is returned from systems other than the caller's system.

The default is SCOPE=ANY.

,SCOPE=ANY

Indicates to return information on resources with any scope.

,SCOPE=STEP

Indicates to return information on resources with a scope of STEP.

,SCOPE=SYSTEM

Indicates to return information on resources with a scope of SYSTEM.

,SCOPE=SYSTEMS

Indicates to return information on resources with a scope of SYSTEMS or SYSPLEX.

,SCOPE=SYSPLEX

Indicates to return information on resources with a scope of SYSTEMS or SYSPLEX. (SYSPLEX is an alias for SYSTEMS.)

,SEARCH=BY_ENQTOKEN**,SEARCH=BY_FILTER**

When SCANACTION=START and REQINFO=QSCAN are specified, a required parameter that designates the method to search for resources.

,SEARCH=BY_ENQTOKEN

Indicates to search using a specific ENQToken. Information is returned about the requester of the ENQ and the resource for which the ENQ was requested.

,SEARCH=BY_FILTER

Indicates to search on resource and requester characteristics using filters. Information is returned about the resources and requesters that match the search criteria.

,SERIALIZEBY=ANY**,SERIALIZEBY=RESERVE****,SERIALIZEBY=ENQ_ONLY**

When SEARCH=BY_FILTER, SCANACTION=START and REQINFO=QSCAN are specified, an optional parameter that indicates if information should be returned depending on whether the requests are serialized by device reserves. The default is SERIALIZEBY=ANY.

,SERIALIZEBY=ANY

Indicates to return information on requests of any type.

,SERIALIZEBY=RESERVE

Indicates to return information on reserve requests that were not converted.

,SERIALIZEBY=ENQ_ONLY

Indicates to return information on requests that do not result in a device reserve. This includes reserve requests that were converted to global ENQs. Answer area bit ISGYQUAARqReserveConverted is set for reserve requests that were converted.

,SYSNAME=sysname**,SYSNAME=ANY_SYSNAME**

When SEARCH=BY_FILTER, SCANACTION=START and REQINFO=QSCAN are specified, an optional input parameter that is the system name of the requesting tasks for which resource information is to be returned. Only information on requester in that system is returned. If GATHERFROM=SYSTEM is specified (or is the default), SYSNAME might only be the name of the caller's system or the default of ANY_SYSNAME.

Note: Only information on resources with scope of SYSTEMS is returned from systems other than the caller's system.

The default is ANY_SYSNAME.

To code: Specify the RS-type address, or address in register (2)-(12), of an 8-character field.

,TTOKEN=ttoken**,TTOKEN=ANY_TTOKEN**

When SEARCH=BY_FILTER, SCANACTION=START and REQINFO=QSCAN are specified, an optional input parameter that is the task token of the requesting task for which resource information is to be returned. Only information on that requester is returned. The TToken specified is valid only on the current system.

Note: The TToken of requesters is unavailable for ENQs obtained before the global resource serialization address space was created. The TToken filter will not match those ENQ requesters.

The default is ANY_TTOKEN.

To code: Specify the RS-type address, or address in register (2)-(12), of a 16-character field.

,USERDATA=userdata

When USERDATAMATCH=SPECIFIC, SEARCH=BY_FILTER, SCANACTION=START and REQINFO=QSCAN are specified, a required input parameter that is the specific UserData of the requests to be returned.

To code: Specify the RS-type address, or address in register (2)-(12), of a 32-character field.

,USERDATA=userdata

When USERDATAMATCH=PATTERN, SEARCH=BY_FILTER, SCANACTION=START and REQINFO=QSCAN are specified, a required input parameter that is a pattern UserData to match the requests to be returned. The UserData pattern is a string of characters where '?' matches any single character, and '*' matches any string of zero or more characters.

To code: Specify the RS-type address, or address in register (2)-(12), of a 32-character field.

,USERDATALEN=userdatalen

When USERDATAMATCH=PATTERN, SEARCH=BY_FILTER, SCANACTION=START and REQINFO=QSCAN are specified, a required input parameter that is the length of the given UserData pattern. The specified length can be 1 - 32.

To code: Specify the RS-type address, or address in register (2)-(12), of a halfword field, or specify a literal decimal value.

,USERDATAMATCH=ANY**,USERDATAMATCH=SPECIFIC****,USERDATAMATCH=PATTERN**

When SEARCH=BY_FILTER, SCANACTION=START and REQINFO=QSCAN are specified, an optional parameter that indicates which requests to return. The default is USERDATAMATCH=ANY.

,USERDATAMATCH=ANY

Indicates to return information on request with any USERDATA, including those with no USERDATA.

,USERDATAMATCH=SPECIFIC

Indicates to only return requests that have USERDATA that exactly matches the specified USERDATA. For information about specifying USERDATA on an ISGENQ request, see [Chapter 60, "ISGENQ — Global resource serialization ENQ service," on page 449](#). Note that USERDATA can only be attached to a request through the ISGENQ interface.

This request requires a version 2 parameter list.

GATHERFROM=SYSPLEX is mutually exclusive with the USERDATAMATCH=SPECIFIC option.

,USERDATAMATCH=PATTERN

Indicates to only return information on requests that match the specified UserData pattern. For information about specifying USERDATA on an ISGENQ request, see [Chapter 60, "ISGENQ — Global resource serialization ENQ service," on page 449](#).

All trailing blanks are not ignored when matching USERDATA to USERDATA patterns. For example, if the USERDATA is ABC123, and the pattern used to search is A*3, it does not match. A pattern such as A*3* does match.

Note: Userdata can only be attached to a request through the ISGENQ interface.

This request requires a version 2 parameter list.

GATHERFROM=SYSPLEX is mutually exclusive with the USERDATAMATCH=PATTERN option.

ABEND codes

None.

Return and reason codes

When the ISGQUERY macro returns control to your program:

- GPR 15 (and *retcode*, when you code RETCODE) contains a return code.
- When the value in GPR 15 is not zero, GPR 0 (and *rsncode*, when you code RSNCODE) contains a reason code.

Macro ISGYCON provides equate symbols for the return and reason codes.

The following table identifies the hexadecimal return and reason codes and the equate symbol associated with each reason code. IBM support personnel can request the entire reason code, including the **xxxx** value.

Table 32. Return and Reason Codes for the ISGQUERY Macro		
Return Code	Reason Code	Equate Symbol Meaning and Action
00	—	<p>Equate Symbol: ISGQUERYRc_OK</p> <p>Meaning: ISGQUERY request successful.</p> <p>For REQINFO=RNLSEARCH, a matching RNLE was found for the given resource name. For REQINFO=QSCAN, processing complete and data has been copied into the answer area. There are no more data to return.</p> <p>Action: None required.</p>
04	—	<p>Equate Symbol: ISGQUERYRc_Warn</p> <p>Meaning: Warning. ISGQUERY completed successfully, however a warning has been issued.</p> <p>Action: Refer to action under the individual reason code.</p>
04	xxxx0401	<p>Equate Symbol: ISGQUERYRsn_NoMatchingRNLE</p> <p>Meaning: For a REQINFO=RNLSEARCH request. No matching RNLE was found for the given resource name.</p> <p>Action: No action required.</p>
04	xxxx0402	<p>Equate Symbol: ISGQUERYRsn_RNLChangeInProgress</p> <p>Meaning: For a REQINFO=RNLSEARCH request. A matching RNLE was found for the given resource name, but an RNL change is in progress in the system.</p> <p>Action: No action required.</p>
04	xxxx0403	<p>Equate Symbol: ISGQUERYRsn_GRSRNLExclude</p> <p>Meaning: For a REQINFO=RNLSEARCH request. GRSRNL=EXCLUDE is in effect. When GRSRNL=EXCLUDE the RNLs are not used and all SYSTEMS scope requests are forced to SYSTEM. An alternative serialization product can be in use. No RNLE is returned.</p> <p>Action: No action required.</p>
04	xxxx0404	<p>Equate Symbol: ISGQUERYRsn_NoMatchingResources</p> <p>Meaning: For REQINFO=QSCAN and REQINFO=LatchECA requests. While scanning the queues, no resources were found that match the caller's request.</p> <p>Action: No action required.</p>

<i>Table 32. Return and Reason Codes for the ISGQUERY Macro (continued)</i>		
Return Code	Reason Code	Equate Symbol Meaning and Action
04	xxxx0405	<p>Equate Symbol: ISGQUERYRsn_AnswerAreaFull</p> <p>Meaning: For a REQINFO=QSCAN request. ISGQUERY has provided some data, however the answer area is too small to contain all the requested data.</p> <p>Action: The user should process the data in the answer area.</p> <p>If RESUMETOKEN was not specified on the request and more information is needed, re-issue the request with a larger answer area or specify a resume token.</p> <p>If RESUMETOKEN was specified, either issue a REQINFO=QSCAN SCANACTION=RESUME request with the returned resume token to continue the scan, or issue REQINFO=QSCAN SCANACTION=QUIT to end the search.</p>
04	xxxx0406	<p>Equate Symbol: ISGQUERYRsn_GRSNone</p> <p>Meaning: For a REQINFO=RNLSEARCH request. GRS=NONE is in effect. When GRS=NONE the RNLs are not used and all requests are serialized only within the current system. Note that though both scope SYSTEM and SYSTEMS requests are local to the current system, they still represent separate resources and are NOT serialized with each other.</p>
08	—	<p>Equate Symbol: ISGQUERYRc_ParmError</p> <p>Meaning: ISGQUERY request specified parameters in error.</p> <p>Action: Refer to action under the individual reason code.</p>
08	xxxx0801	<p>Equate Symbol: ISGQUERYRsn_BadPlistAddress</p> <p>Meaning: Unable to access parameter list.</p> <p>Action: Check that the entire parameter list is addressable. If in AR-mode, check that the ALET of the parameter list is correct. Note that if this macro is issued in AR-mode, SYSSTATE ASCENV=AR must be issued before this macro. Ensure that the storage is in the same key as the caller.</p>
08	xxxx0802	<p>Equate Symbol: ISGQUERYRsn_BadPlistALET</p> <p>Meaning: Bad parameter list ALET. The ALET is neither zero nor is it associated with a valid public entry on the caller's dispatchable unit access list (DU-AL), nor a valid entry for a common area data space.</p> <p>Action: Ensure that the ALET of the parameter list is valid. Its access register might have been set up properly.</p>

<i>Table 32. Return and Reason Codes for the ISGQUERY Macro (continued)</i>		
Return Code	Reason Code	Equate Symbol Meaning and Action
08	xxxx0803	<p>Equate Symbol: ISGQUERYRsn_BadPlistVersion</p> <p>Meaning: Bad parameter list version number. The service level of GRS on which the caller is running does not support this version of the ISGQUERY service, or the ISGQUERY parameter list version is lower than the minimum required for parameters that were specified.</p> <p>Action: Check that the request has the correct version number. Check for possible storage overlay of the parameter list.</p>
08	xxxx0804	<p>Equate Symbol: ISGQUERYRsn_ReservedFieldNotNull</p> <p>Meaning: A reserved field in the parameter list is non-zero.</p> <p>Action: Check for possible storage overlay of the parameter list.</p>
08	xxxx0805	<p>Equate Symbol: ISGQUERYRsn_BadReqInfo</p> <p>Meaning: Bad REQINFO parameter.</p> <p>Action: Check for possible storage overlay of the parameter list.</p>
08	xxxx0806	<p>Equate Symbol: ISGQUERYRsn_BadRNL</p> <p>Meaning: Bad RNL parameter.</p> <p>Action: Check for possible storage overlay of the parameter list.</p>
08	xxxx0807	<p>Equate Symbol: ISGQUERYRsn_BadRNameAddress</p> <p>Meaning: Unable to access the RName.</p> <p>Action: Ensure that the entire RName field is addressable. If in AR-mode, this field is accessed through its address and ALET, check that both these values are correct. Check that specified RName length is correct. Ensure that the storage is in the same key as the caller.</p>
08	xxxx0808	<p>Equate Symbol: ISGQUERYRsn_BadRNameALET</p> <p>Meaning: Bad RName ALET. The ALET is neither zero nor is it associated with a valid public entry on the caller's dispatchable unit access list (DU-AL), nor a valid entry for a common area data space.</p> <p>Action: Ensure that the ALET of the RName is valid. Its access register might have been set up properly.</p>
08	xxxx0809	<p>Equate Symbol: ISGQUERYRsn_BadRNameLen</p> <p>Meaning: The RName length specified is not valid.</p> <p>Action: Ensure the RName length field contains a number from 1-255.</p>

<i>Table 32. Return and Reason Codes for the ISGQUERY Macro (continued)</i>		
Return Code	Reason Code	Equate Symbol Meaning and Action
08	xxxx080A	<p>Equate Symbol: ISGQUERYRsn_BadRNLEAddress</p> <p>Meaning: Unable to access RNLE output field.</p> <p>Action: Ensure that the entire RNLE field is addressable. If in AR-mode, this field is accessed through its address and ALET, check that both these values are correct. Check that RNLE length is correct. Ensure that the storage is in the same key as the caller.</p>
08	xxxx080B	<p>Equate Symbol: ISGQUERYRsn_BadRNLEALET</p> <p>Meaning: Bad RNLE ALET. The ALET is neither zero nor is it associated with a valid public entry on the caller's dispatchable unit access list (DU-AL), nor a valid entry for a common area data space.</p> <p>Action: Ensure that the ALET of the RNLE is valid. Its access register might have been set up properly.</p>
08	xxxx080C	<p>Equate Symbol: ISGQUERYRsn_MutuallyExclusive</p> <p>Meaning: Mutually exclusive keywords were specified.</p> <p>Action: Check for a possible storage overlay of the parameter list.</p>
08	xxxx080D	<p>Equate Symbol: ISGQUERYRsn_BadAnsAreaAddress</p> <p>Meaning: Unable to access the answer area.</p> <p>Action: Ensure that the entire answer area is addressable. If in AR-mode, this field is accessed through its address and ALET, check that both these values are correct. Check that the specified answer area length is correct. Ensure that the storage is in the same key as the caller.</p>
08	xxxx080E	<p>Equate Symbol: ISGQUERYRsn_BadAnsAreaALET</p> <p>Meaning: Bad answer area ALET. The ALET is neither zero nor is it associated with a valid public entry on the caller's Dispatchable Unit Access List (DU-AL), nor a valid entry for a common area data space.</p> <p>Action: Ensure that the ALET of the answer area is valid. Its access register might have been set up properly.</p>
08	xxxx080F	<p>Equate Symbol: ISGQUERYRsn_BadScanAction</p> <p>Meaning: Bad SCANACTION parameter.</p> <p>Action: Check for possible storage overlay of the parameter list.</p>
08	xxxx0810	<p>Equate Symbol: ISGQUERYRsn_BadResumeTokenAddress</p> <p>Meaning: Unable to access the ResumeToken.</p> <p>Action: Ensure that the entire ResumeToken is addressable. If in AR-mode, this field is accessed through its address and ALET, check that both these values are correct. Ensure that the storage is in the same key as the caller.</p>

<i>Table 32. Return and Reason Codes for the ISGQUERY Macro (continued)</i>		
Return Code	Reason Code	Equate Symbol Meaning and Action
08	xxxx0811	<p>Equate Symbol: ISGQUERYRsn_BadResumeTokenALET</p> <p>Meaning: Bad ResumeToken ALET. The ALET is neither zero nor is it associated with a valid public entry on the caller's dispatchable unit access list (DU-AL), nor a valid entry for a common area data space.</p> <p>Action: Ensure that the ALET of the ResumeToken is valid. Its access register might not have been set up properly.</p>
08	xxxx0812	<p>Equate Symbol: ISGQUERYRsn_BadGatherFrom</p> <p>Meaning: Bad GATHERFROM parameter.</p> <p>Action: Check for possible storage overlay of the parameter list.</p>
08	xxxx0813	<p>Equate Symbol: ISGQUERYRsn_BadSearch</p> <p>Meaning: Bad SEARCH keyword parameter.</p> <p>Action: Check for possible storage overlay of the parameter list.</p>
08	xxxx0814	<p>Equate Symbol: ISGQUERYRsn_BadENQTokenAddress</p> <p>Meaning: Unable to access the ENQToken.</p> <p>Action: Ensure that the entire ENQToken is addressable. If in AR-mode, this field is accessed via its address and ALET, check that both these values are correct. Ensure that the storage is in the same key as the caller.</p>
08	xxxx0815	<p>Equate Symbol: ISGQUERYRsn_BadENQTokenALET</p> <p>Meaning: Bad ENQToken ALET. The ALET is neither zero nor is it associated with a valid public entry on the caller's dispatchable unit access list (DU-AL), nor a valid entry for a common area data space.</p> <p>Action: Ensure that the ALET of the ENQToken is valid. Its access register might have been set up properly.</p>
08	xxxx0816	<p>Equate Symbol: ISGQUERYRsn_BadQNameMatch</p> <p>Meaning: Bad QNAMEMATCH keyword parameter.</p> <p>Action: Check for possible storage overlay of the parameter list.</p>
08	xxxx0817	<p>Equate Symbol: ISGQUERYRsn_BadRNameMatch</p> <p>Meaning: Bad RNAMEMATCH keyword parameter.</p> <p>Action: Check for possible storage overlay of the parameter list.</p>
08	xxxx0818	<p>Equate Symbol: ISGQUERYRsn_BadScope</p> <p>Meaning: Bad SCOPE keyword parameter.</p> <p>Action: Check for possible storage overlay of the parameter list.</p>
08	xxxx0819	<p>Equate Symbol: ISGQUERYRsn_BadSerializeBy</p> <p>Meaning: Bad SERIALIZEBY keyword parameter.</p> <p>Action: Check for possible storage overlay of the parameter list.</p>

<i>Table 32. Return and Reason Codes for the ISGQUERY Macro (continued)</i>		
Return Code	Reason Code	Equate Symbol Meaning and Action
08	xxxx081A	<p>Equate Symbol: ISGQUERYRsn_AnsLenTooSmall</p> <p>Meaning: The size of the answer area is not large enough to contain the minimal amount of information.</p> <p>Action: Increase the answer area size to at least the minimum required for the specified request. See the provided constants. However, the answer area length should be at least 4k.</p>
08	xxxx081B	<p>Equate Symbol: ISGQUERYRsn_ResumeTokenNotValid</p> <p>Meaning: The specified resume token is not a valid resume token.</p> <p>Action: Ensure the resume token is from a previously started search on the current system.</p>
08	xxxx081C	<p>Equate Symbol: ISGQUERYRsn_ResumeTokenTooOld</p> <p>Meaning: The specified resume token is from an old search request that has expired.</p> <p>Action: Restart the search if more information is needed.</p>
08	xxxx081D	<p>Equate Symbol: ISGQUERYRsn_ENQTokenNotValid</p> <p>Meaning: The ENQToken specified is not a valid ENQToken.</p> <p>Action: Ensure the ENQToken is from a previous ISGENQ request on the current system.</p>
08	xxxx081E	<p>Equate Symbol: ISGQUERYRsn_BadRequesterLimit</p> <p>Meaning: The REQUESTERLIMIT value specified is not valid. RequesterLimit must be 0 - 2²⁵-1 (32767).</p> <p>Action: Ensure that the requester limit is in the correct range.</p>
08	xxxx081F	<p>Equate Symbol: ISGQUERYRsn_NoPossibleMatch</p> <p>Meaning: For a REQINFO=QSCAN request. Conflicting parameters were specified such that no resources could possibly match the request. A SYSNAME other than the current system was specified along with SCOPE=STEP, SCOPE=SYSTEM, TTOKEN, or GATHERFROM=SYSTEM. Or SERIALIZEBY=RESERVE was specified with SCOPE=STEP.</p> <p>Action: Avoid specifying conflicting parameters.</p>
08	xxxx0820	<p>Equate Symbol: ISGQUERYRsn_BadAnsDetail</p> <p>Meaning: Bad ANSDetail keyword parameter.</p> <p>Action: Check for possible storage overlay of the parameter list.</p>

<i>Table 32. Return and Reason Codes for the ISGQUERY Macro (continued)</i>		
Return Code	Reason Code	Equate Symbol Meaning and Action
08	xxxx0821	<p>Equate Symbol: ISGQUERYRsn_NotAuthToQscan</p> <p>Meaning: SETROPTS MLACTIVE is in effect, and the program is not authorized to issue ISGQUERY REQINFO=QSCAN.</p> <p>Action: Ensure that the program is running authorized, or is associated with a user id with at least READ access to the best fit FACILITY class resource profile of the form ISG.QSCANSERVICES.AUTHORIZATION and that the FACILITY class is SETROPTS RACLISTed.</p>
08	xxxx0822	<p>Equate Symbol: ISGQUERYRsn_BadASID</p> <p>Meaning: Bad ASID keyword parameter.</p> <p>Action: Ensure that the ASID is valid.</p>
08	xxxx0823	<p>Equate Symbol: ISGQUERYRsn_BadUserDataAddress</p> <p>Meaning: Unable to access the user data.</p> <p>Action: Ensure that the entire USERDATA is addressable. If in AR-mode, this field is accessed by its address and ALET, check that both these values are correct. If this is a USERDATA pattern request, check that specified USERDATA length is correct. Ensure that the storage is in the same key as the caller.</p>
08	xxxx0824	<p>Equate Symbol: ISGQUERYRsn_BadUserDataAlet</p> <p>Meaning: Bad USERDATA ALET. The ALET is not zero or is it associated with a valid public entry on the caller's Dispatchable Unit Access List (DU-AL), or a valid entry for a common area data space.</p> <p>Action: Ensure that the ALET of the USERDATA is valid. Its access register might have been set up properly.</p>
08	xxxx0825	<p>Equate Symbol: ISGQUERYRsn_BadUserDataLen</p> <p>Meaning: The USERDATA length specified is not valid.</p> <p>Action: Ensure the USERDATA length field contains a number in the range 1-32.</p>
08	xxxx0826	<p>Equate Symbol: ISGQUERYRsn_BadUserDataMatch</p> <p>Meaning: Bad USERDATAMATCH keyword parameter.</p> <p>Action: Check for possible storage overlay of the parameter list.</p>
08	xxxx0827	<p>Equate Symbol: ISGQUERYRsn_BadAnalyze</p> <p>Meaning: The ANALYZE keyword parameter is not valid.</p> <p>Action: Check for possible storage overlay of the parameter list.</p>

<i>Table 32. Return and Reason Codes for the ISGQUERY Macro (continued)</i>		
Return Code	Reason Code	Equate Symbol Meaning and Action
08	xxxx0828	<p>Equate Symbol: ISGQUERYRsn_NotAuthToLatchECA</p> <p>Meaning: SETROPTS MLACTIVE is in effect and the program is not authorized to issue ISGQUERY REQINFO=LATCHECA.</p> <p>Action: Ensure the program is running authorized or is associated with a userid with at least READ access to the best fit FACILITY class resource profile of the form ISG.LATCHECASERVICES.AUTHORIZATION and that the FACILITY class is SETROPTS RACLISTed.</p>
0C	—	<p>Equate Symbol: ISGQUERYRc_EnvError</p> <p>Meaning: ISGQUERY request has an environment error.</p> <p>Action: Refer to action under the individual reason code.</p>
0C	xxxx0C01	<p>Equate Symbol: ISGQUERYRsn_SrbMode</p> <p>Meaning: ISGQUERY can not be used in SRB mode.</p> <p>Action: Avoid using ISGQUERY in SRB mode.</p>
0C	xxxx0C02	<p>Equate Symbol: ISGQUERYRsn_NotEnabled</p> <p>Meaning: ISGQUERY can not be used disabled.</p> <p>Action: Avoid using ISGQUERY when not enabled.</p>
0C	xxxx0C03	<p>Equate Symbol: ISGQUERYRsn_ComplexMigrating</p> <p>Meaning: For a REQINFO=QSCAN request. The ISGQUERY service failed because the GRS complex was migrating from a ring to a star configuration.</p> <p>Action: Retry the request on or more times.</p>
0C	xxxx0C04	<p>Equate Symbol: ISGQUERYRsn_CannotObtainLocks</p> <p>Meaning: For REQINFO=RNLSEARCH, the local and CMSEQDQ locks could not be obtained.</p> <p>Action: Only use ISGQUERY REQINFO=RNLSEARCH when either no locks are held, or both a local lock and the CMSEQDQ lock are held with no other locks.</p>
0C	xxxx0C05	<p>Equate Symbol: ISGQUERYRsn_LockHeld</p> <p>Meaning: An incorrect lock was held upon entry. For REQINFO=QSCAN, no locks can be held. For REQINFO=RNLSEARCH, either no locks or both a local lock (LOCAL or CML) and the CMDEQDQ lock must be held.</p> <p>Action: Avoid using ISGQUERY REQINFO=QSCAN when locks are held. Avoid using ISGQUERY REQINFO=RNLSEARCH when locks other than both a local lock and the CMSEQDQ lock are held.</p>

Table 32. Return and Reason Codes for the ISGQUERY Macro (continued)		
Return Code	Reason Code	Equate Symbol Meaning and Action
0C	xxxx0C06	<p>Equate Symbol: ISGQUERYRsn_MaxConcurrentRequests</p> <p>Meaning: For a REQINFO=QSCAN request. The answer area was filled before queue scan processing completed, and reason code ISGQUERYRsn_AnswerAreaFull would have been issued. However, RESUMETOKEN was specified, but the limit for the number of concurrent resource requests (ISGENQ, ENQ, RESERVE, GQSCAN, and ISGQUERY) has been reached. The data in the answer area is valid, but incomplete. The scan cannot be resumed.</p> <p>Action: Retry the request one or more times. If the problem persists, consult your system programmer. For more information on concurrent count limits and how the system can be tuned when necessary, see <i>z/OS MVS Planning: Global Resource Serialization</i>.</p>
0C	xxxx0C07	<p>Equate Symbol: ISGQUERYRsn_RingResumeInStar</p> <p>Meaning: For a REQINFO=QSCAN request. The caller attempted to resume a scan that was started when the global resource serialization complex, which is now in star mode, was in ring mode.</p> <p>Action: Reissue the original request.</p>
0C	xxxx0C08	<p>Equate Symbol: ISGQUERYRsn_InsufficientStorage</p> <p>Meaning: For a REQINFO=QSCAN request. The ISGQUERY service could not obtain storage to satisfy the request.</p> <p>Action: Retry the request one or more times.</p>
0C	xxxx0C09	<p>Equate Symbol: ISGQUERYRsn_FRRHeld,</p> <p>Meaning: For a REQINFO=LATCHECA request. The caller issued ISGQUERY with a functional recover routine (FRR) established.</p> <p>Action: Avoid issuing ISGQUERY REQINFO=LATCHECA when using functional recovery routines.</p>
10	—	<p>Equate Symbol: ISGQUERYRc_CompError</p> <p>Meaning: Component Error</p> <p>Action: Contact the IBM Support Center.</p> <p>The reason code contains internal diagnostic information.</p>

Examples

Use these examples as a guide.

```

* *****
* Search the Systems Inclusion RNL for a resource name
* *****
      ISGQUERY REQINFO=RNLSEARCH,RNL=SIRNL,           X
      QNAME=MYQNAME,RNAME=MYRNAME,RNAMELEN=MYRNAMELEN, X
      RETCODE=MYRC,RSNCODE=MYRSN

* *****
* Query information on a request specified by ENQToken

```

ISGQUERY macro

```

* *****
ISGQUERY REQINFO=QSCAN,SCANACTION=START,           X
      ANSAREA=MYAREA,ANSLLEN=MYAREALEN,           X
      SEARCH=BY_ENQTOKEN,ENQTOKEN=MYENQTOKEN,     X
      RETCODE=MYRC,RSNCODE=MYRSN
* *****
* Start a resumable query for resources of a specific job that
* matches a specific QNAME and pattern RNAME
* *****

ISGQUERY REQINFO=QSCAN,SCANACTION=START,           X
      ANSAREA=MYAREA,ANSLLEN=MYAREALEN,           X
      SEARCH=BY_FILTER,QNAMEMATCH=SPECIFIC,QNAME=MYQNAME, X
      RNAMEMATCH=PATTERN,RNAME==CL7'ABC?23*',RNAMELEN=7, X
      USERDATAMATCH=SPECIFIC,USERDATA=MYUDATA,     X
      JOBNAME=MYJOBNAME,RESUMETOKEN=MYRESTOKEN,RETCODE=MYRC, X
      RSNCODE=MYRSN
* *****
* Start a resumable query for resources of a specific job that
* matches a specific QNAME and pattern RNAME
* *****

ISGQUERY REQINFO=QSCAN,SCANACTION=START,           X
      ANSAREA=MYAREA,ANSLLEN=MYAREALEN,           X
      SEARCH=BY_FILTER,QNAMEMATCH=SPECIFIC,QNAME=MYQNAME, X
      RNAMEMATCH=PATTERN,RNAME==CL7'ABC?23*',RNAMELEN=7, X
      USERDATAMATCH=PATTERN,USERDATA=MYUDATAP,USERDATALEN=7, X
      JOBNAME=MYJOBNAME,RESUMETOKEN=MYRESTOKEN,RETCODE=MYRC, X
      RSNCODE=MYRSN

MYUDATA DC CL32'MY USERDATA'
MYUDATAP DC CL7'M??USE*'

* *****
* Resume a query that was started but not completed
* *****

ISGQUERY REQINFO=QSCAN,SCANACTION=RESUME,           X
      RESUMETOKEN=MYRESTOKEN,                       X
      ANSAREA=MYAREA,ANSLLEN=MYAREALEN,           X
      RETCODE=MYRC,RSNCODE=MYRSN
* *****
* Quit a query that was started but not completed
* *****

ISGQUERY REQINFO=QSCAN,SCANACTION=QUIT,           X
      RESUMETOKEN=MYRESTOKEN,                       X
      RETCODE=MYRC,RSNCODE=MYRSN
* *****

* *****
* Gather ENQ statistics for a particular address space
* *****

ISGQUERY REQINFO=ENQSTATS,                           X
      ANSAREA=MYAREA,ASID=MYASID,                   X
      RETCODE=MYRC,RSNCODE=MYRSN
* *****

* *****
* Gather query latch enhanced contention analysis (LATCHECA) data from the
* global resource serialization queues for waiters delayed because of
* contention
* *****

ISGQUERY REQINFO=LATCHECA,ANALYZE=WAITER,ANSAREA=MYAREA, X
      ANSLLEN=MYAREALEN,RETCODE=MYRC,RSNCODE=MYRSN X
* *****
* Gather address space level contention information related to ENQs
* (all scopes) and latches (all latch sets) from the
* global resource serialization queues
* *****

```

```
ISGQUERY REQINFO=USAGESTATS,ANSAREA=MYAREA,ANSLEN=MYAREALEN, X  
          RETCODE=MYRC,RSNCODE=MYRSN X
```

For more information on global resource serialization, see [z/OS MVS Planning: Global Resource Serialization](#).

Chapter 62. ITTUINIT – Activate external CTRACE recording

Description

Note: ITTUINIT is a linkable system service.

ITTUINIT is one of a set of services that an unauthorized program can use to write CTRACE output. The other services in the set are ITTUWRIT and ITTUTERM. The services must be invoked under the same task in problem state.

Use the ITTUINIT service to activate external CTRACE recording. Once ITTUINIT has been invoked, multiple calls to the ITTUWRIT service can be made to write the CTRACE entries. The ITTUTERM service is invoked to end external CTRACE recording.

The caller of ITTUINIT provides a data structure containing parameters for the service. At the conclusion of its processing, ITTUINIT returns information for the user in the same data structure.

Environment

The requirements for the caller are:

Environmental factor	Requirement
Minimum authorization:	Problem state with PSW key 8-15
Dispatchable unit mode:	Task
Cross memory mode:	PASN=HASN=SASN
AMODE:	24- or 31-bit
ASC mode:	Primary
Interrupt status:	Enabled for I/O and external interrupts
Locks:	No locks held
Control parameters:	Must be in the primary address space.

Programming requirements

- To build the parameter area required by ITTUINIT, you must include the ITTUIPRM mapping macro (see *z/OS MVS Data Areas* in the *z/OS Internet library* (www.ibm.com/servers/resourcelink/svc00100.nsf/pages/zosInternetLibrary)).
- Before calling ITTUINIT, the caller must provide the following in the fully-initialized ITTUIPRM mapping macro:
 - The component name
 - The name of the format table for the component
 - The ddname to which CTRACE output is to be written
 - The maximum length of an ITTCTE that will be accepted by ITTUWRIT.
 - The number of bytes of virtual storage that the unauthorized CTRACE writer is authorized to use for trace buffers.
 - An option bit that requests NOWRAP processing. WRAP processing is requested when this bit is zero. DSECT=NO may be specified for initial values.

3. The caller determines whether ITTUINIT processing was successful by examining the return code.
4. Successful ITTUINIT processing results in the following updated field in ITTUIPRM:
 - A token whose value must be passed to the ITTUWRIT and ITTUTERM services.

Restrictions

The caller cannot have any enabled, unlocked task (EUT) FRRs established.

Input register information

Before linking to ITTUINIT, the caller must ensure that the following general purpose registers (GPRs) contain the specified information:

Register

Contents

1

Address of the parameter list

13

Address of a standard 72-byte save area in the primary address space

Before linking to ITTUINIT, the caller does not have to place any information into any access register (AR).

Output register information

When control returns to the caller, the GPRs contain:

Register

Contents

0-1

Used as work registers by the system

2-13

Unchanged

14

Used as work register by the system

15

Return code

When control returns to the caller, the ARs contain:

Register

Contents

0-1

Used as work registers by the system

2-13

Unchanged

14-15

Used as work registers by the system

Some callers depend on register contents remaining the same before and after issuing a service. If the system changes the contents of registers on which the caller depends, the caller must save them before issuing the service, and restore them after the system returns control.

Performance implications

None.

Syntax

Use the following form of the LINK macro to invoke the ITTUINIT service:

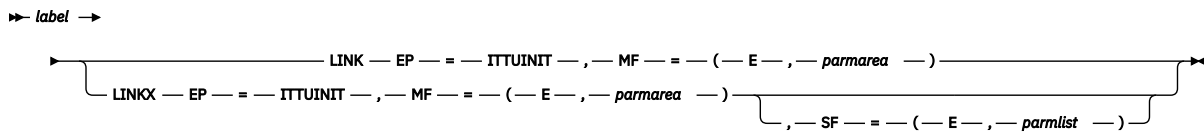

Note: As an alternative to using LINK or LINKX, callers in 31-bit AMODE can also:

1. Issue the MVS LOAD macro to load the ITTUINIT service and obtain its entry point address.
2. Issue the CALL macro to call the service. Specify MF=(E,*your_parmlist*) on the call.

Parameters

The parameters are explained as follows:

label

The name on the macro invocation.

LINK

LINKX

Names the system service that is to be used for linkage.

EP=ITTUINIT

Specifies the entry point name for the ITTUINIT service.

,MF=(E,*parmarea*)

Specifies the address of the parameter list to be passed to ITTUINIT. The parameter list consists of the following address:

- The address of the fully-initialized ITTUIPRM.

,SF=(E,*parmlist*)

For use with LINKX when your program is reentrant. Before you call LINKX with this parameter, define *parmlist* using the LIST form of LINKX.

Return and reason codes

When the ITTUINIT service returns control to your program, Register 15 contains a return code.

Decimal Return Code	Meaning and Action
00	Meaning: The ITTUINIT request completed successfully. Action: None required.
16	Meaning: Warning. The ITTUINIT request did not complete successfully. Action: Reissue ITTUINIT.

Chapter 63. ITTUTERM – End external CTRACE recording

Description

Note: ITTUTERM is a linkable system service.

Use the ITTUTERM service to close the trace data set and unallocate resources that were allocated by the ITTUINIT service. uffer.

Environment

The requirements for the caller are:

Environmental factor	Requirement
Minimum authorization:	Problem state with PSW key 8-15
Dispatchable unit mode:	Task
Cross memory mode:	PASN=HASN=SASN
AMODE:	24- or 31-bit
ASC mode:	Primary
Interrupt status:	Enabled for I/O and external interrupts
Locks:	No locks held
Control parameters:	Must be in the primary address space.

Programming requirements

The caller determines whether ITTUTERM processing was successful by examining the return code.

Restrictions

The caller cannot have any enabled, unlocked task (EUT) FRRs established.

Input register information

Before linking to ITTUTERM, the caller must ensure that the following general purpose registers (GPRs) contain the specified information:

Register

Contents

1

Address of parameter list

13

Address of a standard 72-byte save area in the primary address space

Before linking to ITTUTERM, the caller does not have to place any information into any access register (AR).

Output register information

When control returns to the caller, the GPRs contain:

Register Contents

- 0-1**
Used as work registers by the system
- 2-13**
Unchanged
- 14**
Used as work register by the system
- 15**
Return code

When control returns to the caller, the ARs contain:

Register Contents

- 0-1**
Used as work registers by the system
- 2-13**
Unchanged
- 14-15**
Used as work registers by the system

Some callers depend on register contents remaining the same before and after issuing a service. If the system changes the contents of registers on which the caller depends, the caller must save them before issuing the service, and restore them after the system returns control.

Performance implications

None.

Syntax

Use the following form of the LINK macro to invoke the ITTUTERM service:

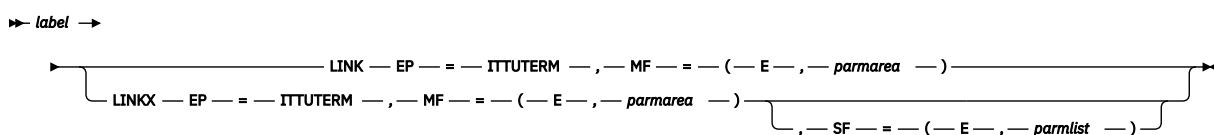

Note: As an alternative to using LINK or LINKX, callers in 31-bit AMODE can also:

1. Issue the MVS LOAD macro to load the ITTUTERM service and obtain its entry point address.
2. Issue the CALL macro to call the service. Specify MF=(E,*your_parmlist*) on the call.

Parameters

The parameters are explained as follows:

label

The name on the macro invocation.

LINK

LINKX

Names the system service that is to be used for linkage.

EP=ITTUTERM

Specifies the entry point name for the ITTUTERM service.

,MF=(E,*parmarea*)

Specifies the address of the parameter list to be passed to ITTUTERM. The parameter list consists of the following address:

- The address of the token passed from ITTUINIT.

,SF=(E,*parmlist*)

For use with LINKX when your program is reentrant. Before you call LINKX with this parameter, define *parmlist* using the LIST form of LINKX.

Return and reason codes

When the ITTUTERM service returns control to your program, Register 15 contains a return code.

Decimal Return Code	Meaning and Action
00	<p>Meaning: The ITTUTERM request completed successfully.</p> <p>Action: None required.</p>
non-zero	<p>Meaning: Warning. The ITTUTERM request did not complete successfully.</p> <p>Action: Reissue ITTUTERM.</p>

Chapter 64. ITTUWRIT – Queue a group of CTRACE entries

Description

Note: ITTUWRIT is a linkable system service.

ITTUWRIT is one of a set of services that an unauthorized program can use to write CTRACE output. The other services in the set are ITTUINIT and ITTUTERM. The services must be invoked under the same task in problem state.

Use the ITTUWRIT service to queue a group of CTRACE entries. Whenever new CTRACE entries overflow a buffer, recording of the entries occurs.

The caller of ITTUWRIT provides the token returned by the ITTUINIT service and the address of the storage area containing the ITTCTE entries.

Multiple calls to the ITTUWRIT service can be made to write the CTRACE entries. When ITTUWRIT is in control, the system writes the ITTCTE entries from the storage area passed to ITTUWRIT into the CTRACE output buffers immediately. If necessary, the system may need to discard trace entries because of timing considerations or error conditions such as I/O errors or storage overlays. ITTUWRIT adds control information to the trace data set whenever data losses occur, if possible.

Environment

The requirements for the caller are:

Environmental factor	Requirement
Minimum authorization:	Problem state with PSW key 8-15
Dispatchable unit mode:	Task
Cross memory mode:	PASN=HASN=SASN
AMODE:	24- or 31-bit
ASC mode:	Primary
Interrupt status:	Enabled for I/O and external interrupts
Locks:	No locks held
Control parameters:	Must be in the primary address space.

Programming requirements

1. To reference the parameter area required by ITTUWRIT, you must include the ITTUIPRM mapping macro (see *z/OS MVS Data Areas* in the *z/OS Internet library* (www.ibm.com/servers/resourcelink/svc00100.nsf/pages/zosInternetLibrary)).
2. The caller determines whether ITTUWRIT processing was successful by examining the return code.

Restrictions

The caller cannot have any enabled, unlocked task (EUT) FRRs established.

Input register information

Before linking to ITTUWRIT, the caller must ensure that the following general purpose registers (GPRs) contain the specified information:

Register Contents

1

Address of parameter list

13

Address of a standard 72-byte save area in the primary address space

Before linking to ITTUWRIT, the caller does not have to place any information into any access register (AR).

Output register information

When control returns to the caller, the GPRs contain:

Register Contents

0-1

Used as work registers by the system

2-13

Unchanged

14

Used as work register by the system

15

Return code

When control returns to the caller, the ARs contain:

Register Contents

0-1

Used as work registers by the system

2-13

Unchanged

14-15

Used as work registers by the system

Some callers depend on register contents remaining the same before and after issuing a service. If the system changes the contents of registers on which the caller depends, the caller must save them before issuing the service, and restore them after the system returns control.

Performance implications

None.

Syntax

Use the following form of the LINK macro to invoke the ITTUWRIT service:

►► *label* →

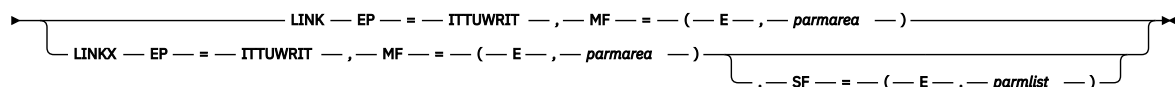

Note: As an alternative to using LINK or LINKX, callers in 31-bit AMODE can also:

1. Issue the MVS LOAD macro to load the ITTUWRIT service and obtain its entry point address.
2. Issue the CALL macro to call the service. Specify MF=(E,*your_parmlist*) on the call.

Parameters

The parameters are explained as follows:

label

The name on the macro invocation.

LINK

LINKX

Names the system service that is to be used for linkage.

EP=ITTUWRIT

Specifies the entry point name for the ITTUWRIT service.

,MF=(E,*parmarea*)

Specifies the address of the parameter list to be passed to ITTUWRIT. The parameter list consists of the following three addresses:

- The address of the token passed from ITTUINIT.
- The address of a fullword containing the size of the block of CTE entries.
- The address of the area containing the CTE entries.

,SF=(E,*parmlist*)

For use with LINKX when your program is reentrant. Before you call LINKX with this parameter, define *parmlist* using the LIST form of LINKX.

Return and reason codes

When the ITTUWRIT service returns control to your program, Register 15 contains a return code.

Decimal Return Code	Meaning and Action
00	Meaning: The ITTUWRIT request completed successfully. Action: None required.
16	Meaning: Warning. The ITTUWRIT request did not complete successfully. Action: Reissue ITTUWRIT.

Chapter 65. ITZEVENT – Transaction trace EVENT record

Description

The ITZEVENT macro is used to build and record a transaction trace record. It optionally performs the query function to determine if the work unit should be traced.

Environment

The requirements for the caller are:

Environmental factor	Requirement
Minimum authorization:	Problem state. PSW key 8 - 15
Dispatchable unit mode:	Task or SRB
Cross memory mode:	Any PASN, any HASN, any SASN
AMODE:	31-bit
ASC mode:	Primary
Interrupt status:	Enabled for I/O and external interrupts
Locks:	No locks may be held
Control parameters:	Control parameters must be in the primary address space. The data pointed to by DATAADDR must reside in the caller's primary address space.

Programming requirements

Any module that invokes this macro must include the macros CVT and IHAECVT.

To get the equate symbols for the return and reason codes, the caller should include the ITZYRETC macro.

Restrictions

None.

Input register information

Before issuing the ITZEVENT macro, the caller must ensure that the following general purpose registers (GPRs) contain the specified information:

Register Contents

13

The address of a 72-byte standard save area in the primary address space

Before issuing the ITZEVENT macro, the caller does not have to place any information into any access register (AR).

Output register information

When control returns to the caller, the GPRs contain:

ITZEVENT macro

Register Contents

- 0**
Contains the reason code when GPR15 is not 0
- 1**
Unpredictable (Used as a work register by the system)
- 2-13**
Unchanged
- 14**
Unpredictable (Used as a work register by the system)
- 15**
Contains the return code

When control returns to the caller, the ARs contain:

Register Contents

- 0-1**
Unpredictable (Used as a work register by the system)
- 2-13**
Unchanged
- 14-15**
Unpredictable (Used as a work register by the system)

Some callers depend on register contents remaining the same before and after issuing a macro. If the macro changes the contents of registers on which the caller depends, the caller must save them before issuing the macro and restore them after the macro returns control.

Performance implications

None.

Syntax

The ITZEVENT macro is written as follows:

Syntax	Description
<i>name</i>	<i>name</i> : symbol. Begin <i>name</i> in column 1.
␣	One or more blanks must precede ITZEVENT.
ITZEVENT	
␣	One or more blanks must follow ITZEVENT.
COMPONENT= <i>component</i>	<i>component</i> : RS-type address or address in register (2) - (12)
,EVENTDESC= <i>eventdesc</i>	<i>eventdesc</i> : RS-type address or address in register (2) - (12)

Syntax	Description
,DATAFORMAT= TT	Default: DATAFORMAT=TT
,DATAFORMAT=GTF	
,DATAADDR= <i>dataaddr</i>	<i>dataaddr</i> : RS-type address or address in register (2) - (12)
,DATALEN= <i>datalen</i>	<i>datalen</i> : RS-type address or address in register (2) - (12)
,DATAADDR= <i>dataaddr</i>	<i>dataaddr</i> : RS-type address or address in register (2) - (12)
,DATALEN= <i>datalen</i>	<i>datalen</i> : RS-type address or address in register (2) - (12)
,GTFID= <i>gtfid</i>	<i>gtfid</i> : RS-type address or address in register (2) - (12)
,GTFFID= <i>gtffid</i>	<i>gtffid</i> : RS-type address or address in register (2) - (12)
,FMCTYPE= HEX	Default: FMCTYPE=HEX
,FMCTYPE=MODEL	
,FMCTYPE=ROUTINE	
,FORMATRTN= <i>formatrtn</i>	<i>formatrtn</i> : RS-type address or address in register (2) - (12)
,FORMATRTN= <i>formatrtn</i>	<i>formatrtn</i> : RS-type address or address in register (2) - (12)
,FUNCTIONNAME=	<i>functionname</i>
	<i>functionname</i> : RS-type address or address in register (2) - (12)
,QUERY=YES	Default: QUERY=YES
,QUERY=NO	
,MONTKN= <i>montkn</i>	<i>montkn</i> : RS-type address or address in register (2) - (12)
,MONTKN64= <i>montkn</i>	
,TRACETKN= <i>tracetkn</i>	<i>tracetkn</i> : RS-type address or address in register (2) - (12)
,PLISTVER=	

Syntax	Description
IMPLIED_VERSION	Default: PLISTVER=IMPLIED_VERSION
,PLISTVER=MAX	
,PLISTVER=0	
,MF= S	Default: MF=S
,MF=(L, <i>list addr</i>)	<i>list addr</i> : RS-type address or register (1) - (12)
,MF=(L, <i>list addr</i> , <i>attr</i>)	
,MF=(L, <i>list addr</i> , OD)	
	,MF=(E, <i>list addr</i>)
	,MF=(E, <i>list addr</i> , COMPLETE)
	,MF=(E, <i>list addr</i> ,NOCHECK)
	,MF=(M, <i>list addr</i>)
	,MF=(M, <i>list addr</i> , COMPLETE)
,MF=(M, <i>list addr</i> ,NOCHECK)	

Parameters

The parameters are explained as follows:

name

This is an optional symbol, starting in column 1, that is the name on the ITZEVENT macro invocation. The name must conform to the rules for an ordinary assembler language symbol.

COMPONENT=component

This is a required input parameter that specifies the user component name used in formatting the standard transaction trace header.

To code: Specify the RS-type address, or address in register (2)-(12), of an 8-character field.

,EVENTDESC=eventdesc

This is a required input parameter that specifies the event-related field used in formatting the standard transaction trace header.

Some examples might be START xxxxxxxx, END xxxxxxxx, ENTRYPTxxx, COMMIT, and ROLLBACK.

To code: Specify the RS-type address, or address in register (2)-(12), of an 16-character field.

,DATAFORMAT=TT

,DATAFORMAT=GTF

This is an optional parameter that specifies the kind of data that follows the transaction trace header in the trace record. The default is DATAFORMAT=TT.

,DATAFORMAT=TT

The data recorded will contain transaction trace-related data.

,DATAFORMAT=GTF

This indicates that a GTF data record follows the standard transaction trace header. A pointer to the GTF record is passed along with the length.

,DATAADDR=*dataaddr*

When DATAFORMAT=TT is specified, this is an optional input parameter that can be used to specify the address and length of the data to be appended at the end of the transaction trace header. This is event-specific data set up by the user of this macro.

To code: Specify the RS-type address, or address in register (2)-(12), of a pointer field.

,DATALEN=*datalen*

When DATAADDR=*dataaddr* and DATAFORMAT=TT are specified, this is a required input parameter that specifies the length of the data to be appended at the end of the transaction trace header. This is event-specific data, set up by the user of this macro.

The maximum length of data may not exceed 1K. If a length greater than 1K is specified, data will be truncated to record 1K of data.

To code: Specify the RS-type address, or address in register (2)-(12), of a fullword field.

,DATAADDR=*dataaddr*

When DATAFORMAT=GTF is specified, this is a required input parameter that specifies the address and length of the GTF record to be appended at the end of the transaction trace header.

To code: Specify the RS-type address, or address in register (2)-(12), of a pointer field.

,DATALEN=*datalen*

When DATAFORMAT=GTF is specified, this is a required input parameter that specifies the length of the data to be appended at the end of the transaction trace header.

The maximum length of data may not exceed 1K. If a length greater than 1K is specified, data will be truncated to record 1K of data.

To code: Specify the RS-type address, or address in register (2)-(12), of a fullword field.

,GTFID=*gtfid*

When DATAFORMAT=GTF is specified, this is a required input parameter that specifies the event ID that is to be recorded with the data bytes. Decimal event IDs 0 through 1023 (X'3FF') are available for user events.

To code: Specify the RS-type address, or address in register (2)-(12), of a 2-character field.

,GTFFID=*gtffid*

When DATAFORMAT=GTF is specified, this is an optional input parameter that specifies the format appendage (fidname) that controls the formatting of the record. Formatting occurs when the trace output is processed by GTF trace. The format appendage name is formed by appending the 2-digit GTFFID value to the names AMDUSER, HMDUSR, and IMDUSR. Assign GTFFID values as follows:

- X'00' - The record is to be dumped in hex.
- X'01' to X'50' - The record contains user format identifiers.

Note: If you omit the GTFFID parameter, the system supplies a default fidname of zero.

To code: Specify the RS-type address, or address in register (2)-(12), of a 1-character field.

,FMSTYPE=HEX**,FMSTYPE=MODEL****,FMSTYPE=ROUTINE**

This is an optional parameter that specifies the IPCS format routine type for the user data. Refer to [*z/OS MVS IPCS Customization*](#) for details about the IPCS format.

The formatting can be in Hex, Model format, or from a Format routine. If a FORMATRTN is specified, FMSTYPE must be set to Routine or Model. The default is FMSTYPE=HEX.

,FMSTYPE=HEX

The data is displayed in Hex format.

,FMSTYPE=MODEL

The data is displayed in a format provided in a model format routine.

,FMTTYPE=ROUTINE

The data is displayed in a format provided in a user format routine.

,FORMATRTN=*formatrtn*

When FMTTYPE=MODEL is specified, this is a required parameter that specifies the name of the routine to be used for formatting the user data.

To code: Specify the RS-type address, or address in register (2)-(12), of an 8-character field.

,FORMATRTN=*formatrn*

When FMTTYPE=ROUTINE is specified, this is a required parameter that specifies the name of the routine to be used for formatting the user data..

To code: Specify the RS-type address, or address in register (2)-(12), of an 8-character field.

,FUNCTIONNAME=*functionname*

this is an optional input parameter that specifies the function (module|routine|label) that is making the trace entry. This value is displayed on the trace record formatted by IPCS.

To code: Specify the RS-type address, or address in register (2)-(12), of a 32-character field.

,QUERY=YES**,QUERY=NO**

This is an optional parameter that specifies whether query should be performed to determine if this work unit is to be traced.

Specifying QUERY=YES causes the same function to be performed as the ITZQUERY macro. If transaction trace is active for this work unit, a trace record is built and recorded. The default is QUERY=YES.

,QUERY=YES

Specifies that Query needs to be performed.

,QUERY=NO

Specifies that Query does not need to be performed.

The transaction trace token (TRACETKN) is a required input parameter. The TRACETKN is obtained by issuing a ITZQUERY macro just prior to issuing the ITZEVENT.

,MONTKN=*montkn***,MONTKN64=*montkn***

When QUERY=YES is specified, MONTKN and MONTKN64 are available as a mutually exclusive set of keys. MONTKN is an optional 32 bit and MONTKN64 is an optional 64 bit input used as a token to locate the current monitoring environment.

IBM recommends that MONTKN or MONTKN64 be specified for a monitoring environment to keep the query pathlength short and fast.

To code: Specify the RS-type address, or address in register (2)-(12), of a 31-bit or 64-bit field.

,TRACETKN=*tracetkn*

When QUERY=NO is specified, this is a required input parameter that specifies the transaction trace token returned from the previously performed query.

To code: Specify the RS-type address, or address in register (2)-(12), of a 32-character field.

Note: Some existing components and products may have difficulty finding space in their data areas to hold a 32-byte transaction trace token. Apply APAR OW50696 to shorten the significant portion of the token to 8 bytes. With service for OW50696 applied, only the first 8 bytes of the 32-byte token will contain values other than binary zeros. Components that might not be able to exploit component trace due to the size of the 32-byte token may save just the first 8 bytes between uses, expanding it for use with transaction trace APIs by padding with binary zeros.

,PLISTVER=IMPLIED_VERSION**,PLISTVER=MAX****,PLISTVER=0**

This is an optional input parameter that specifies the version of the macro. PLISTVER determines which parameter list the system generates. PLISTVER is an optional input parameter on all forms of the macro, including the list form. When using PLISTVER, specify it on all macro forms used for a request and with the same value on all of the macro forms. The values are:

IMPLIED_VERSION

This is the lowest version that allows all parameters specified on the request to be processed. If you omit the PLISTVER parameter, IMPLIED_VERSION is the default.

MAX

Specify MAX if you want the parameter list to be the largest size currently possible. This size might grow from release to release and affect the amount of storage your program needs.

If you can tolerate the size change, IBM recommends that you always specify PLISTVER=MAX on the list form of the macro. Specifying MAX ensures that the list form parameter list is always long enough to hold all the parameters you might specify on the execute form of the macro when both are assembled with the same level of the system. In this way, MAX ensures that the parameter list does not overwrite nearby storage.

0

Specify 0 if you use the currently available parameters.

To code: Specify one of the following:

- IMPLIED_VERSION
- MAX
- A decimal value of 0

,MF=S**,MF=(L,list addr)****,MF=(L,list addr,attr)****,MF=(L,list addr,OD)****,MF=(E,list addr)****,MF=(E,list addr,COMPLETE)****,MF=(E,list addr,NOCHECK)****,MF=(M,list addr)****,MF=(M,list addr,COMPLETE)****,MF=(M,list addr,NOCHECK)**

This is an optional input parameter that specifies the macro form.

Use MF=S to specify the standard form of the macro, which builds an inline parameter list and generates the macro invocation to transfer control to the service. MF=S is the default.

Use MF=L to specify the list form of the macro. Use the list form together with the execute form of the macro for applications that require reentrant code. The list form defines an area of storage that the execute form uses to store the parameters. Only the PLISTVER parameter may be coded with the list form of the macro.

Use MF=E to specify the execute form of the macro. Use the execute form together with the list form of the macro for applications that require reentrant code. The execute form of the macro stores the parameters into the storage area defined by the list form, and generates the macro invocation to transfer control to the service.

Use MF=M with the list and execute forms of the macro for service routines that need to provide different options according to user-provided input. Use the list form to define a storage area, use the modify form to set the appropriate options, and use the execute form to call the service.

IBM recommends that you use and execute forms of ITZEVENT in the following order:

- Use ITZEVENT ...MF=(M,list-addr,COMPLETE) specifying appropriate parameters, including all required ones.

ITZEVENT macro

- Use ITZEVENT ...MF=(M,list-addr,NOCHECK) specifying the parameters that you want to change.
- Use ITZEVENT ...MF=(E,list-addr,NOCHECK) to execute the macro.

,list addr

This is the name of a storage area to contain the parameters. For MF=S, MF=E, and MF=M, this can be an RS-type address or an address in register (1)-(12).

,attr

This is an optional 1- to 60-character input string that you use to force boundary alignment of the parameter list. Use a value of 0F to force the parameter list to a word boundary, or 0D to force the parameter list to a doubleword boundary. If you do not code *attr*, the system provides a value of 0D.

,COMPLETE

This specifies that the system is to check for required parameters and supply defaults for omitted optional parameters.

,NOCHECK

This specifies that the system is not to check for required parameters and is not to supply defaults for omitted optional parameters.

ABEND codes

None.

Return and reason codes

When the ITZEVENT macro returns control to your program:

- GPR 15 contains a return code.
- When the value in GPR 15 is not zero, GPR 0 contains a reason code.

The following table identifies the hexadecimal return and reason codes and the equate symbol associated with each reason code. IBM support personnel may request the entire reason code, including the xxxx value.

Return Code	Reason Code	Equate Symbol Meaning and Action
0	—	Equate Symbol: ITZGOOD Meaning: Success - this work unit was traced. Action: None.
4	—	Equate Symbol: ITZNOTR Meaning: Work unit was not traced. Action: None. Reason code set to indicate the reason for not tracing.
4	xxxx0401	Equate Symbol: ITZNOTKN Meaning: Trace token was zero. Action: None.
4	xxxx0402	Equate Symbol: ITZNOACT Meaning: Transaction trace is not active. Action: None.
4	xxxx0403	Equate Symbol: ITZLATNT Meaning: Transaction trace is LATENT with LATENT=N set. Action: None.

Examples

```
ITZEVENT COMPONENT=COMP,  
          EVENTDESC=DESC,  
          DATAADDR=TTDATA,  
          DATALEN=TTLEN
```

```
COMP  DC  CL8'COMP1 '  
DESC  DC  CL16'START TRAN '  
TTDATA DC CL64  
TTLEN DC  F'64'
```

Chapter 66. ITZQUERY – Transaction trace query

Description

The ITZQUERY macro is used to query whether a transaction or work unit should be traced.

Environment

The requirements for the caller are:

Environmental factor	Requirement
Minimum authorization:	Problem state. PSW key 8 - 15
Dispatchable unit mode:	Task or SRB
Cross memory mode:	Any PASN, any HASN, any SASN
AMODE:	31-bit
ASC mode:	Primary
Interrupt status:	Enabled for I/O and external interrupts
Locks:	No locks may be held
Control parameters:	Control parameters must be in the primary address space.

Programming requirements

Any module that invokes this macro must include the CVT and IHAECVT macros.

Restrictions

None.

Input register information

Before issuing the ITZQUERY macro, the caller must insure that the following general purpose registers (GPRs) contain the specified information:

Register Contents

13

The address of a 72-byte standard save area in the primary address space

Before issuing the ITZQUERY macro, the caller does not have to place any information into any access register (AR).

Output register information

When control returns to the caller, the GPRs contain:

Register Contents

0

Reason code

1

Unpredictable (Used as a work register by the system)

ITZQUERY macro

2-13

Unchanged

14

Unpredictable (Used as a work register by the system)

15

Return code

When control returns to the caller, the ARs contain:

Register

Contents

0-1

Unpredictable (Used as a work register by the system)

2-13

Unchanged

14-15

Unpredictable (Used as a work register by the system)

Some callers depend on register contents remaining the same before and after issuing a macro. If the macro changes the contents of registers on which the caller depends, the caller must save them before issuing the macro and restore them after the macro returns control.

Performance implications

Specifying the MONTKN in a monitoring environment results in a faster query.

Syntax

The ITZQUERY macro is written as follows:

Syntax	Description
<i>name</i>	<i>name</i> : symbol. Begin <i>name</i> in column 1.
␣	One or more blanks must precede ITZQUERY.
ITZQUERY	
␣	One or more blanks must follow ITZQUERY.
,MONTKN= <i>montkn</i>	<i>montkn</i> : RS-type address or address in register (2) - (12)
,MONTKN64= <i>montkn</i>	
,MONTKN=0	Default: MONTKN=0
,TRACETKN= <i>tracetkn</i>	<i>tracetkn</i> : RS-type address
,TRACELVL= <i>tracelvl</i>	<i>tracelvl</i> : RS-type address

Syntax	Description
,PLISTVER=	
IMPLIED VERSION	Default: PLISTVER=IMPLIED_VERSION
,PLISTVER=MAX	
,PLISTVER=0	
,MF= S	Default: MF=S
,MF=(L, <i>list addr</i>)	<i>list addr</i> : RS-type address or register (1) - (12)
,MF=(L, <i>list addr</i> , <i>attr</i>)	
,MF=(L, <i>list addr</i> , OD)	
,MF=(E, <i>list addr</i>)	
,MF=(E, <i>list addr</i> , COMPLETE)	
,MF=(E, <i>list addr</i> ,NOCHECK)	
,MF=(M, <i>list addr</i>)	
,MF=(M, <i>list addr</i> , COMPLETE)	
,MF=(M, <i>list addr</i> ,NOCHECK)	

Parameters

The parameters are explained as follows:

name

This is an optional symbol, starting in column 1, that is the name on the ITZQUERY macro invocation. The name must conform to the rules for an ordinary assembler language symbol.

,MONTKN=*montkn*

,MONTKN64=*montkn*

MONTKN=0

MONTKN is an optional 32 bit and MONTKN64 is an optional 64 bit input used as a token to locate the current monitoring environment. MONTKN and MONTKN64 are mutually exclusive.

IBM recommends that MONTKN or MONTKN64 be specified for a monitoring environment to keep the query pathlength short and fast.

An optional input parameter that is the token used to locate the current monitoring environment.

It is recommended that MONTKN be specified for a monitoring environment to keep the query pathlength short and fast. The default is 0.

To code: Specify the RS-type address or address in register (2) - (12) of a 31-bit or 54-bit field.

,MONTKN=*montkn*

,MONTKN64=*montkn*

When QUERY=YES is specified, MONTKN and MONTKN64 are available as a mutually exclusive set of keys. MONTKN is an optional 32 bit and MONTKN64 is an optional 64 bit input used as a token to locate the current monitoring environment.

IBM recommends that MONTKN or MONTKN64 be specified for a monitoring environment to keep the query pathlength short and fast.

To code: Specify the RS-type address, or address in register (2)-(12), of a 31-bit or 64-bit field.

,TRACETKN=tracetkn

This is a required output parameter that specifies the transaction trace token returned from query.

To code: Specify the RS-type address of a 32-character field.

Note: Some existing components and products may have difficulty finding space in their data areas to hold a 32-byte transaction trace token. Apply APAR OW50696 to shorten the significant portion of the token to 8 bytes. With service for OW50696 applied, only the first 8 bytes of the 32-byte token will contain values other than binary zeros. Components that might not be able to exploit component trace due to the size of the 32-byte token may save just the first 8 bytes between uses, expanding it for use with transaction trace APIs by padding with binary zeros.

,TRACELVL=tracelvl

This is an optional output parameter that specifies the transaction trace indicator returned from query. A non-zero value implies that this work unit is eligible for tracing. A value of zero implies that this work unit is not eligible for tracing. In that case, the trace token is also set to zero.

To code: Specify the RS-type address of a one-byte field.

,PLISTVER=IMPLIED_VERSION**,PLISTVER=MAX****,PLISTVER=0**

This is an optional input parameter that specifies the version of the macro. PLISTVER determines which parameter list the system generates. PLISTVER is an optional input parameter on all forms of the macro, including the list form. When using PLISTVER, specify it on all macro forms used for a request and with the same value on all of the macro forms. The values are:

IMPLIED_VERSION

This is the lowest version that allows all parameters specified on the request to be processed. If you omit the PLISTVER parameter, IMPLIED_VERSION is the default.

MAX

Specify MAX if you want the parameter list to be the largest size currently possible. This size might grow from release to release and affect the amount of storage your program needs.

If you can tolerate the size change, IBM recommends that you always specify PLISTVER=MAX on the list form of the macro. Specifying MAX ensures that the list form parameter list is always long enough to hold all the parameters you might specify on the execute form of the macro when both are assembled with the same level of the system. In this way, MAX ensures that the parameter list does not overwrite nearby storage.

0

Specify 0 if you use the currently available parameters.

To code: Specify one of the following:

- IMPLIED_VERSION
- MAX
- A decimal value of 0

,MF=S**,MF=(L,list addr)****,MF=(L,list addr,attr)****,MF=(L,list addr,OD)****,MF=(E,list addr)****,MF=(E,list addr,COMPLETE)****,MF=(E,list addr,NOCHECK)****,MF=(M,list addr)****,MF=(M,list addr,COMPLETE)****,MF=(M,list addr,NOCHECK)**

This is an optional input parameter that specifies the macro form.

Use MF=S to specify the standard form of the macro, which builds an inline parameter list and generates the macro invocation to transfer control to the service. MF=S is the default.

Use MF=L to specify the list form of the macro. Use the list form together with the execute form of the macro for applications that require reentrant code. The list form defines an area of storage that the execute form uses to store the parameters. Only the PLISTVER parameter may be coded with the list form of the macro.

Use MF=E to specify the execute form of the macro. Use the execute form together with the list form of the macro for applications that require reentrant code. The execute form of the macro stores the parameters into the storage area defined by the list form, and generates the macro invocation to transfer control to the service.

Use MF=M together with the list and execute forms of the macro for service routines that need to provide different options according to user-provided input. Use the list form to define a storage area; use the modify form to set the appropriate options; then use the execute form to call the service.

- Use ITZQUERY ...MF=(M,list-addr,COMPLETE) specifying appropriate parameters, including all required ones.
- Use ITZQUERY ...MF=(M,list-addr,NOCHECK), specifying the parameters that you want to change.
- Use ITZQUERY ...MF=(E,list-addr,NOCHECK), to execute the macro.

,list addr

The name of a storage area to contain the parameters. For MF=S, MF=E, and MF=M, this can be an RS-type address or an address in register (1)-(12).

,attr

An optional 1- to 60-character input string that you use to force boundary alignment of the parameter list. Use a value of 0F to force the parameter list to a word boundary, or 0D to force the parameter list to a doubleword boundary. If you do not code *attr*, the system provides a value of 0D.

,COMPLETE

Specifies that the system is to check for required parameters and supply defaults for omitted optional parameters.

,NOCHECK

Specifies that the system is not to check for required parameters and is not to supply defaults for omitted optional parameters.

ABEND codes

None.

Return and reason codes

When the ITZQUERY macro returns control to your program, GPR 15 contains a return code.

The following table identifies the hexadecimal return and reason codes and the equate symbol associated with each reason code.

Equate Symbol	Meaning and Action	
0	—	<p>Equate Symbol: ITZGOOD</p> <p>Meaning: Success.</p> <p>Action: Trace this work unit. Trace token is non-zero.</p>
4	—	<p>Equate Symbol: ITZNOTR</p> <p>Meaning: Work unit not to be traced.</p> <p>Action: Do not trace this work unit.</p>

Chapter 67. IXGBRWSE – Browse/read a log stream

Description

Use the IXGBRWSE macro to read and browse a log stream for log block information. Using IXGBRWSE, a program can read consecutive log blocks in a log stream or search for and read a specific log block in a log stream. IXGBRWSE returns the specified log block in the calling program's output buffer.

The requests for IXGBRWSE are:

- REQUEST=START, which starts a browse session. A browse session is identified by a browse token which is created by the browse start request. The browse session remains active until it is ended as a result of a REQUEST=END request or the log stream has been disconnected. See [“REQUEST=START option of IXGBRWSE” on page 540](#) for the syntax of this request.
- REQUEST=READCURSOR, which reads the next consecutive log block (or blocks) in the log stream. Use this request multiple times or use the MULTIBLOCK keyword to read consecutive blocks in a log stream. See [“REQUEST=READCURSOR option of IXGBRWSE” on page 545](#) for the syntax of this request.
- REQUEST=READBLOCK, which reads a selected log block in a log stream. See [“REQUEST=READBLOCK option of IXGBRWSE” on page 551](#) for the syntax of this request.
- REQUEST=RESET, which resets the browse cursor to either the beginning or the end of the log stream. See [“REQUEST=RESET option of IXGBRWSE” on page 557](#) for the syntax of this request.
- REQUEST=END, which ends a browse session. See [“REQUEST=END option of IXGBRWSE” on page 561](#) for the syntax of this request.

For information about using the system logger services and the IXGBRWSE request, see *z/OS MVS Programming: Assembler Services Guide*, which also includes information about related macros IXGCONN, IXGINVNT, IXGWRITE, IXGDELET, and IXGQUERY.

Environment

The requirements for the caller are:

Environmental factor	Requirement
Minimum authorization:	Problem or Supervisor state with any PSW key. The caller must be in supervisor state with any system (0-7) PSW key to either invoke this service in SRB mode or to use the MODE=SYNCEXIT keyword.
Dispatchable unit mode:	Task or SRB
Cross memory mode:	Any PASN, HASN or SASN
AMODE:	31-bit or 64-bit
ASC mode:	Primary or access register (AR)
Interrupt status:	Enabled for I/O and external interrupts.
Locks:	No locks held.

Environmental factor**Requirement****Control parameters:**

All control parameters must be in the primary address space with the following exceptions:

- The ECB should be addressable from the home address space.
- Any parameter area that is explicitly ALET-qualified as allowed by the input parameter (for example, the area referenced by the BUFFER parameter when the BUFFALET parameter is specified) must be in an address or data space that is addressable through a public entry on the caller's dispatchable unit access list (DU-AL).

All storage areas specified must be in the same storage key as the caller with the following exception:

- Any parameter area is explicitly storage key qualified as allowed by the input parameters (example: the area referenced by the BUFFER parameter when the BUFFKEY parameter is also specified).

Programming requirements

- The current primary address space must be the same primary address space used at the time your program issued the IXGCONN request.
- The calling program must be connected to the log stream through the IXGCONN service with either read or write authority.
- The parameter list for this service must be addressable in the caller's primary address space.
- Include the IXGCON mapping macro in your program. This macro provides a list of equate symbols for the system logger services.
- Include macro IXGANSAA in your program. This macro maps the format of the answer area output returned for each system logger service in the ANSAREA parameter.
- For a READCURSOR browse request with the MULTIBLOCK=YES option, include the IXGBRMLT mapping macro in your program. This macro provides a mapping of the area returned by the system logger for each block that is returned in the caller's buffer. Additionally, the area pointed to by the BUFFER or BUFFER64 parameter must be on a word boundary for multiple log block READCURSOR requests.
- Although the data pointed to by the BUFFER64 keyword may be above the bar (2-gigabyte), the length of the name or address of the input field specified in the BUFFLEN keyword is still limited to 4 bytes.
- When coding the MODE=SYNCECB and ECB parameters, you must ensure that:
 - The virtual storage area specified for the ECB resides on a fullword boundary.
 - You initialize the ECB field to zero.
 - The ECB resides in either common or home address space storage at the time the IXGBRWSE request is issued.
 - The storage used for output parameters, such as ANSAREA, BROWSETOKEN, BUFFER, BUFFER64, ANSAREA, BLKSIZE, TIMESTAMP, and RETBLOCKID, are accessible by both the IXGBRWSE invoker and the ECB waiter.

Restrictions

There is more than one version of this macro available. The parameters you can use depend on the version you specify on the PLISTVER parameter. See the description of the PLISTVER parameter for more information.

You can call any of the system logger services in either AMODE 31 or 64, but the parameter list and all other data addresses, with the exception of BUFFER64 must reside in 31-bit storage.

Input register information

Before issuing the IXGBRWSE macro, the caller does not have to place any information into any register unless using it in register notation for a particular parameter, or using it as a base register.

Output register information

When control returns to the caller, the GPRs contain:

Register

Contents

0

Reason code, if register 15 contains a non-zero return code

1

Used as a work register by the system

2-13

Unchanged

14

Used as a work register by the system

15

Return code

When control returns to the caller, the ARs contain:

Register

Contents

0-1

Used as a work register by the system

2-13

Unchanged

14-15

Used as a work register by the system

When control returns to a caller running in AMODE 64, the 64-bit registers contain:

Register

Contents

0-1

Used as a work register by the system, if the caller specified BUFFER64. Otherwise, unchanged.

2-13

Unchanged

14

Unchanged

15

Used as a work register by the system.

Some callers depend on register contents remaining the same before and after issuing a service. If the system changes the contents of registers on which the caller depends, the caller must save them before issuing the service, and restore them after the system returns control.

Performance implications

None.

REQUEST=START option of IXGBRWSE

The IXGBRWSE macro with the REQUEST=START parameter starts a browse session and sets the starting position of the browse cursor.

Syntax for REQUEST=START

The IXGBRWSE REQUEST=START macro is written as follows:

Syntax	Description
<i>name</i>	<i>name</i> : symbol. Begin <i>name</i> in column 1.
␣	One or more blanks must precede IXGBRWSE.
IXGBRWSE	
␣	One or more blanks must follow IXGBRWSE.
REQUEST=START	
,STREAMTOKEN= <i>streamtoken</i>	<i>streamtoken</i> : RS-type address or register (2) - (12).
,BROWSETOKEN= <i>browsetoken</i>	<i>browsetoken</i> : RS-type address or register (2) - (12).
,ANSAREA= <i>ansarea</i>	<i>ansarea</i> : RS-type address or register (2) - (12).
,ANSLEN= <i>anslen</i>	<i>anslen</i> : RS-type address or register (2) - (12).
,OLDEST	Default: OLDEST
,YOUNGEST	
,STARTBLOCKID= <i>startblockid</i>	<i>startblockid</i> : RS-type address or register (2) - (12).
,SEARCH= <i>search</i>	<i>search</i> : RS-type address or register (2) - (12).
GMT=YES	

Syntax	Description
GMT=NO	
VIEW=ACTIVE	Default: VIEW=ACTIVE
VIEW=ALL	
VIEW=NO_VIEW	
MODE=SYNC	Default: MODE=SYNC
MODE=SYNCECB	
,ECB= <i>ecb</i>	<i>ecb</i> : RS-type address or register (2) - (12).
,DIAG=NO_DIAG	Default: DIAG=NO_DIAG
,DIAG=NO	
,DIAG=YES	
,PLISTVER=IMPLIED_VERSION	
,PLISTVER=MAX	Default: IMPLIED_VERSION
,PLISTVER= <i>plistver</i>	
,RETCODE= <i>retcode</i>	<i>retcode</i> : RS-type address or register (2) - (12).
,RSNCODE= <i>rsncode</i>	<i>rsncode</i> : RS-type address or register (2) - (12).
,MF=S	Default: MF=S
,MF=(L, <i>list addr</i>)	
,MF=(L, <i>list addr,attr</i>)	
,MF=(L, <i>list addr,OD</i>)	
,MF=(E, <i>list addr</i>)	
,MF=(E, <i>list addr,COMPLETE</i>)	
,MF=(E, <i>list addr,NOCHECK</i>)	
,MF=(M, <i>list addr</i>)	
,MF=(M, <i>list addr,COMPLETE</i>)	
,MF=(M, <i>list addr,NOCHECK</i>)	

Parameters for REQUEST=START

The parameters are explained as follows:

REQUEST=START

Requests that a browse session be started.

,STREAMTOKEN=streamtoken

Specifies the name or address (using a register) of a required 16-byte input field containing the token for the log stream that you want to browse and read. The stream token is returned by the IXGCONN service at connection to the log stream.

,BROWSETOKEN=browsetoken

Specifies the name or address (using a register) of a required 4-byte output area where a token uniquely identifying the browse session is returned by the IXGBRWSE REQUEST=START request. This browse token is then used as an input to subsequent IXGBRWSE requests to identify the browse session.

,ANSAREA=ansarea

Specifies the name (or address in a register) of an answer area containing information about this request. The answer area must be at least 40 bytes. To map this information, use the IXGANSAA macro.

,ANSLEN=anslen

Specifies the name (or address in a register) of the 4-byte field containing the answer area length. The length of the answer area must be at least 40 bytes and must be the same length as the field specified in ANSAREA.

To ascertain the optimal answer area length, look at the ANSAA_PREFERRED_SIZE field of the IXGANSAA macro.

,OLDEST

,YOUNGEST

,STARTBLOCKID=startblockid

,SEARCH=search

Specifies where the cursor should be set for the start of the browse session.

- **OLDEST:** Specifies that the block cursor be positioned at the oldest log block in the log stream.

When VIEW=ACTIVE is specified for this browse session, the cursor is positioned at the oldest active log block in the log stream. If there is no active data in the log stream, the request will fail.

When VIEW=ALL is specified, the cursor is positioned at the oldest log block in the log stream of the active and inactive data. If there is neither active nor inactive data in the log stream, the request will fail.

- **YOUNGEST:** Specifies that the block cursor be positioned at the youngest log block in the log stream.

When VIEW=ACTIVE is specified for this browse session, the cursor is positioned at the youngest active log block in the log stream.

When VIEW=ALL is specified, the cursor is positioned at the youngest log block in the log stream, even if the youngest block is eligible for deletion.

- **STARTBLOCKID=startblockid:** Specifies the name (or register) of a 8-byte input field containing the block identifier for the log block you want to use as the starting cursor position.

When VIEW=ALL is specified, you must specify a starting block that is active.

- **SEARCH=search:** Specifies the name (or register) of a 64-bit input field containing the time stamp you want to use in searching for a particular log block as the starting cursor position for this browse session. For information on how the SEARCH keyword works, see [z/OS MVS Programming: Assembler Services Guide](#).

The time stamp must be Coordinated universal time (UTC) or local time, in time of day (TOD) clock format. The GMT parameter is required with the SEARCH parameter.

,GMT=YES**,GMT=NO**

Specifies whether the time stamp specified on the SEARCH parameter is UTC or local time.

- GMT=YES: The time stamp specified on the SEARCH parameter is in UTC format.
- GMT=NO: The time stamp specified on the SEARCH parameter is local time.

VIEW=ACTIVE**VIEW=ALL****VIEW=NO_VIEW**

Specifies whether requests issued during this browse session return active data only, or both active and inactive data. Active data is data that has not been marked for deletion via the IXGDELET service. Inactive data is data that has been deleted via IXGDELET but has not been physically deleted from the log stream because of the retention period specified in the log stream policy definition in the active system logger couple data set.

- VIEW=ACTIVE, which is the default, specifies that in this browse session, system logger will only return active data from the log stream.
- VIEW=ALL specifies that in this browse session, system logger will return both active and inactive data.

When VIEW=ALL is specified and a log block is returned, system logger sets a flag in the answer area, AnsaablkFromInactive, indicating whether the block was active or eligible for deletion.

- VIEW=NO_VIEW specifies that the default VIEW value will be used for the browse session.

,MODE=SYNC**,MODE=SYNCECB**

Specifies that the request should be processed in one of the following ways:

- MODE=SYNC: Specifies that the request process synchronously. Control is not returned to the caller until request processing is complete. If necessary, the calling program will be suspended until the request completes.
- MODE=SYNCECB: Specifies that the request process synchronously if possible. If the request processes asynchronously, control returns to the caller before the request completes and the event control block (ECB) specified on the ECB parameter is posted when the request completes. The ECB parameter is required with MODE=SYNCECB.

,ECB=*ecb*

Specifies the name or address (using a register) of a 4-byte input field containing an event control block (ECB) to be posted when the request completes.

Before coding ECB, you must ensure that:

- You initialize the ECB to zero.
- The ECB must reside in either common storage or the home address space at the time the IXGBRWSE request is issued.
- The virtual storage area specified for the ECB must reside on a fullword boundary.

,DIAG=NO_DIAG**,DIAG=NO****,DIAG=YES**

Specifies whether or not the DIAG option on the IXGCONN for this logstream will be in effect for this browse session. Refer to the DIAG keyword on the IXGINVNT, IXGCONN, and IXGDELET macro services.

If you specify DIAG=NO_DIAG, which is the default, then the DIAG option on the IXGCONN for this logstream will be in effect for this browse session.

If you specify DIAG=NO, then Logger will not take additional diagnostic action as defined in the logstream definition DIAG parameter.

If you specify DIAG=YES, then Logger will take additional diagnostic action as defined on the logstream definition DIAG parameter providing the IXGCONN connect DIAG specification allows it.

,PLISTVER=IMPLIED_VERSION

,PLISTVER=MAX

,PLISTVER=plistver

An optional input parameter that specifies the version of the macro. PLISTVER determines which parameter list the system generates.

The values are:

- **IMPLIED_VERSION**, which is the lowest version that allows all parameters specified on the request to be processed. If you omit the PLISTVER parameter, IMPLIED_VERSION is the default. Note that on the list form, the default will cause the smallest parameter list to be created.
- **MAX**, if you want the parameter list to be the largest size currently possible. This size might grow from release to release and affect the amount of storage that your program needs.

If you can tolerate the size change, IBM recommends that you always specify PLISTVER=MAX on the list form of the macro. Specifying MAX ensures that the list-form parameter list is always long enough to hold all the parameters you might specify on the execute form when both forms are assembled using the same level of the system. In this way, MAX ensures that the parameter list does not overwrite nearby storage.

- **0**, supports all parameters except those specifically referenced in higher versions.
- **1**, supports both the following parameters and parameters from version 0:
 - DIAG
 - REQDATA
- **2**, supports both the following parameters and parameters from version 0 and 1:
 - MAXNUMLOGBLOCKS
 - MULTIBLOCK
 - RETBLOCKINFO

To code: Specify in this input parameter one of the following:

- IMPLIED_VERSION
- MAX
- A decimal value of 0, 1 or 2

,RETCODE=retcode

Specifies a name or address (using a register) of a 4-byte output field where the system will place the return code. The return code is also in general purpose register (GPR) 15.

,RSNCODE=rsncode

Specifies a name or address (using a register) of a 4-byte output field where the system will place the reason code. The reason code is also in general purpose register (GPR) 0, if you received a non-zero return code.

,MF=S

,MF=(L,list addr)

,MF=(L,list addr,attr)

,MF=(L,list addr,OD)

,MF=(E,list addr)

,MF=(E,list addr,COMPLETE)

,MF=(E,list addr,NOCHECK)

,MF=(M,list addr)

,MF=(M,list addr,COMPLETE)

,MF=(M,list addr,NOCHECK)

Use MF=S to specify the standard form of the macro, which builds an inline parameter list and generates the macro invocation to transfer control to the service. MF=S is the default.

Use MF=L to specify the list form of the macro. Use the list form together with the execute form of the macro for applications that require reentrant code. The list form defines an area of storage that the execute form uses to store the parameters. Only the PLISTVER parameter can be specified on the list form of the macro. IBM recommends that you always specify PLISTVER=MAX on the list form of the macro.

Use MF=E to specify the execute form of the macro. Use the execute form together with the list form of the macro for applications that require reentrant code. The execute form of the macro stores the parameters into the storage area defined by the list form, and generates the macro invocation to transfer control to the service.

Use MF=M together with the list and execute forms of the macro for service routines that need to provide different options according to user-provided input. Use the list form to define a storage area; use the modify form to set the appropriate options; then use the execute form to call the service.

You should use the modify and execute forms in the following order:

- Use MF=(M,*list_addr*,COMPLETE), specifying appropriate parameters, including all required ones.
- Use MF=(M,*list_addr*,NOCHECK), specifying the parameters you want to change.
- Use MF=(E,*list_addr*,NOCHECK), to execute the macro.

,*list_addr*

The name of a storage area to contain the parameters.

,*attr*

An optional 1- to 60-character input string, which can contain any value that is valid on an assembler DS pseudo-op. You can use this parameter to force boundary alignment of the parameter list. If you do not code *attr*, the system provides a value of 0D, which forces the parameter list to a doubleword boundary.

,COMPLETE

Specifies that the system is to check for required parameters and supply defaults for omitted optional parameters.

,NOCHECK

Specifies that the system is not to check for required parameters and is not to supply defaults for omitted optional parameters.

REQUEST=READCURSOR option of IXGBRWSE

The IXGBRWSE macro with the REQUEST=READCURSOR option allows a program to read the next consecutive log block in a log stream. Subsequent READCURSOR requests will start reading at the next consecutive block. Use this request multiple times or use the MULTIBLOCK keyword to read a series of consecutive log blocks. The direction of the browse is controlled by the program and can be changed dynamically.

READCURSOR requests are limited to reading log blocks within the range of data defined by the browse session's view. The view is controlled by the VIEW keyword on either the browse START request or the browse RESET request.

Note: REQUEST=READCURSOR reads the next consecutive log block in the log stream, but the blocks may not be in exact local time sequence. This can happen, for example, because of daylight savings time, one or more records with the same local time stamp, or multiple applications writing to the same log stream.

Syntax for REQUEST=READCURSOR

The IXGBRWSE REQUEST=READCURSOR macro is written as follows:

Syntax	Description
<i>name</i>	<i>name</i> : symbol. Begin <i>name</i> in column 1.

Syntax	Description
␣	One or more blanks must precede IXGBRWSE.
IXGBRWSE	
␣	One or more blanks must follow IXGBRWSE.
REQUEST=READCURSOR	
,STREAMTOKEN= <i>streamtoken</i>	<i>streamtoken</i> : RS-type address or register (2) - (12).
,BROWSETOKEN= <i>browsetoken</i>	<i>browsetoken</i> : RS-type address or register (2) - (12).
,BUFFER= <i>buffer</i>	<i>buffer</i> : RS-type address or register (2) - (12).
,BUFFER64= <i>buffer64</i>	<i>buffer64</i> : RS-type address or register (2) - (12).
,BUFFLEN= <i>bufflen</i>	<i>bufflen</i> : RS-type address or register (2) - (12).
,DIRECTION=OLDTOYOUNG	
,DIRECTION=YOUNGTOOLD	
,ANSAREA= <i>ansarea</i>	<i>ansarea</i> : RS-type address or register (2) - (12).
,ANSLLEN= <i>anslen</i>	<i>anslen</i> : RS-type address or register (2) - (12).
,BUFFALET= <i>buffalet</i>	<i>buffalet</i> : RS-type address or register (2) - (12).
	Default: BUFFALET=0
,BLKSIZE= <i>blksize</i>	<i>blksize</i> : RS-type address or register (2) - (12). Default: BLKSIZE=0
,MULTIBLOCK=YES	
,MULTIBLOCK=NO	Default: MULTIBLOCK=NO

Syntax	Description
,RETBLOCKID= <i>retblockid</i>	<i>retblockid</i> : RS-type address or register (2) - (12). Default: NO_BLKID Note: RETBLOCKID is valid with MULTIBLOCK=NO only.
,TIMESTAMP= <i>timestamp</i>	<i>timestamp</i> : RS-type address or register (2) - (12). Default: NO_TIMESTAMP Note: TIMESTAMP is valid with MULTIBLOCK=NO only.
,RETBLOCKINFO=YES	
,RETBLOCKINFO=NO	Default: NO Note: RETBLOCKINFO is valid with MULTIBLOCK=YES only.
,MAXNUMLOGBLOCKS= <i>maxnumlogblocks</i>	
	<i>maxnumlogblocks</i> : RS-type address or register (2) - (12). Default: MAXNUMLOGBLOCKS=0 Note: MAXNUMLOGBLOCKS is valid with MULTIBLOCK=YES only.
MODE=SYNC	Default: MODE=SYNC
MODE=SYNCECB	
,ECB= <i>ecb</i>	<i>ecb</i> : RS-type address or register (2) - (12).
,PLISTVER=IMPLIED_VERSION	
,PLISTVER=MAX	Default: IMPLIED_VERSION
,PLISTVER= <i>plistver</i>	
,RETCODE= <i>retcode</i>	<i>retcode</i> : RS-type address or register (2) - (12).
,RSNCODE= <i>rsncode</i>	<i>rsncode</i> : RS-type address or register (2) - (12).
,MF=S	Default: MF=S
,MF=(L, <i>list addr</i>)	
,MF=(L, <i>list addr,attr</i>)	
,MF=(L, <i>list addr,OD</i>)	
,MF=(E, <i>list addr</i>)	
,MF=(E, <i>list addr,COMPLETE</i>)	
,MF=(E, <i>list addr,NOCHECK</i>)	

Syntax	Description
,MF=(M, <i>list addr</i>)	
,MF=(M, <i>list addr</i> ,COMPLETE)	
,MF=(M, <i>list addr</i> ,NOCHECK)	

Parameters for REQUEST=READCURSOR

The parameters are explained as follows:

REQUEST=READCURSOR

Requests that a program read the next consecutive log block in the log stream, in the direction specified on the DIRECTION parameter.

,STREAMTOKEN=streamtoken

Specifies the name or address (using a register) of a required 16-byte input field containing the token for the log stream that you want to browse and read. The stream token is returned by the IXGCONN service at connection to the log stream.

,BROWSETOKEN=browsetoken

Specifies the name or address (using a register) of a required 4-byte input field containing the identifier for the browse session which was returned on the IXGBRWSE REQUEST=START request.

,BUFFER=buffer

,BUFFER64=buffer64

Specifies the name or address (using a register) of a required output field that contains the buffer into which the log block is read.

- **BUFFER=buffer** specifies that the location of the buffer is in 31-bit storage.
- **BUFFER64=buffer64** specifies that the location of the buffer is in 64-bit storage.

the BUFFER and BUFFER64 parameters are mutually exclusive.

,BUFFLEN=bufflen

Specifies the name or address (using a register) of a required 4-byte input field that contains the length of the buffer specified on the BUFFER or BUFFER64 parameter.

IXGBRWSE will return the length of the block in the BLKSIZE parameter, if specified. If you specify MULTIBLOCK=NO, you can issue IXGBRWSE with BLKSIZE specified to obtain the length of the block and then re-issue IXGBRWSE using the returned BLKSIZE value in the BUFFLEN parameter.

,DIRECTION=OLDTOYOUNG

,DIRECTION=YOUNGTOOLD

Specifies the direction that you want the cursor to move to read the next consecutive log block. Specify OLDTOYOUNG to get the next youngest block or YOUNGTOOLD to get the next oldest block.

,ANSAREA=ansarea

Specifies the name (or address in a register) of an answer area containing information about this request. The answer area must be at least 40 bytes. To map this information, use the IXGANSAA macro.

,ANSLEN=anslen

Specifies the name (or address in a register) of the 4-byte field containing the answer area length. The length of the answer area must be at least 40 bytes and must be the same length as the field specified in ANSAREA.

To ascertain the optimal answer area length, look at the ANSAA_PREFERRED_SIZE field of the IXGANSAA macro.

,BUFFALET=buffalet

Specifies the name (or address in a register) of a 4-byte input field specifying the access list entry table (ALET) to be used to access the buffer specified on the BUFFER or BUFFER64 keyword. If the

buffer is ALET-qualified, the ALET must index a valid entry on the task's dispatchable unit access list (DUAL) or specify a SCOPE=COMMON data space. An ALET that indexes the system logger PASN-AL list will not work.

The default is 0, which means that the buffer is in the calling program's primary address space.

,BLKSIZE=blksize

Specifies the name or address (using a register) of a 4-byte output field where the space used or needed in the BUFFER or BUFFER64 area is returned. When MULTIBLOCK=NO is specified and there is enough space in the buffer to return the requested log block data, the actual size of the log block is returned. When MULTIBLOCK=YES is specified and there is enough space in the buffer to return the requested log blocks, the amount of space used in the BUFFER or BUFFER64 area is returned. If the BUFFLEN value is not large enough to allow any log block data to be returned, then the BLKSIZE value will indicate the minimum amount of space necessary to return the next log block.

,MULTIBLOCK=YES

,MULTIBLOCK=NO

Specifies whether one or more than one log stream log block will be returned by the read cursor request.

- MULTIBLOCK=NO indicates that only one log stream log block is to be returned.
- MULTIBLOCK=YES indicates that the system logger will retrieve as many log blocks as meet the browse parameter criteria and fit into the caller's buffer.

,RETBLOCKID=retblockid

Specifies the name or address (using a register) of an 8-byte output field where the identifier or the requested log block is returned

,TIMESTAMP=timestamp

Specifies the name or address (using a register) of a 16-byte output field where the Coordinated universal time stamp and the local time stamp associated with the requested log block are returned. The UTC time stamp is first, then the local time stamp. Both time stamps are in TOD-clock format.

,RETBLOCKINFO=YES

,RETBLOCKINFO=NO

Specifies whether or not system logger should return the log blocksize, blockid, timestamps and other identification information in the caller's buffer as part of the output. Specify RETBLOCKINFO=YES to receive each log block's identification information. Specify RETBLOCKINFO=NO to only receive the information necessary to navigate the caller's buffer.

If you omit the RETBLOCKINFO parameter, RETBLOCKINFO=NO is the default.

,MAXNUMLOGBLOCKS=xmaxnumlogblocks

Specifies the name (or address in a register) of an optional fullword input that indicates the maximum number of log blocks to be returned in the buffer. When a non-zero value is specified, system logger will not return more than this requested number of log blocks, even if there are more log blocks that meet the other browse parameter criteria.

- If enough room is provided in the BUFFLEN value and there are sufficient log blocks that meet the browse criteria, system logger will return the requested maximum number of log blocks.
- If enough room is not provided in the BUFFLEN value, system logger will return as many log blocks as fit into the caller's buffer.
- If there are fewer log blocks remaining than the requested maximum number, system logger will return as many of the remaining log blocks as fit into the caller's buffer.

If you omit the MAXNUMLOGBLOCKS, the default is 0.

,MODE=SYNC

,MODE=SYNCECB

Specifies that the request should be processed in one of the following ways:

- MODE=SYNC: Specifies that the request process synchronously. Control is not returned to the caller until request processing is complete. If necessary, the calling program will be suspended until the request completes.

- **MODE=SYNCECB**: Specifies that the request process synchronously if possible. If the request processes asynchronously, control returns to the caller before the request completes and the event control block (ECB) specified on the ECB parameter is posted when the request completes. The ECB parameter is required with **MODE=SYNCECB**.

ECB=ecb

Specifies the name or address (using a register) of a 4-byte input field that contains an event control block (ECB) to be posted when the request completes.

Before coding ECB, you must ensure that:

- You initialize the ECB to zero.
- The ECB must reside in either common storage or the home address space at the time the IXGBRWSE request is issued.
- The virtual storage area specified for the ECB must reside on a fullword boundary.

,PLISTVER=IMPLIED_VERSION**,PLISTVER=MAX****,PLISTVER=plistver**

An optional input parameter that specifies the version of the macro. PLISTVER determines which parameter list the system generates.

The values are:

- **IMPLIED_VERSION**, which is the lowest version that allows all parameters specified on the request to be processed. If you omit the PLISTVER parameter, IMPLIED_VERSION is the default. Note that on the list form, the default will cause the smallest parameter list to be created.
- **MAX**, if you want the parameter list to be the largest size currently possible. This size might grow from release to release and affect the amount of storage that your program needs.

If you can tolerate the size change, IBM recommends that you always specify **PLISTVER=MAX** on the list form of the macro. Specifying **MAX** ensures that the list-form parameter list is always long enough to hold all the parameters you might specify on the execute form when both forms are assembled using the same level of the system. In this way, **MAX** ensures that the parameter list does not overwrite nearby storage.

- **0**, supports all parameters except those specifically referenced in higher versions.
- **1**, supports both the following parameters and parameters from version 0:
 - **DIAG**
 - **REQDATA**
- **2**, supports both the following parameters and parameters from version 0 and 1:
 - **MAXNUMLOGBLOCKS**
 - **MULTIBLOCK**
 - **RETBLOCKINFO**

To code: Specify in this input parameter one of the following:

- **IMPLIED_VERSION**
- **MAX**
- A decimal value of 0, 1 or 2

,RETCODE=retcode

Specifies a name or address (using a register) of a 4-byte output field where the system will place the return code. The return code is also in general purpose register (GPR) 15.

,RSNCODE=rsncode

Specifies a name or address (using a register) of a 4-byte output field where the system will place the reason code. The reason code is also in general purpose register (GPR) 0, if you received a non-zero return code.

,MF=S
,MF=(L,list addr)
,MF=(L,list addr,attr)
,MF=(L,list addr,OD)
,MF=(E,list addr)
,MF=(E,list addr,COMPLETE)
,MF=(E,list addr,NOCHECK)
,MF=(M,list addr)
,MF=(M,list addr,COMPLETE)
,MF=(M,list addr,NOCHECK)

Use MF=S to specify the standard form of the macro, which builds an inline parameter list and generates the macro invocation to transfer control to the service. MF=S is the default.

Use MF=L to specify the list form of the macro. Use the list form together with the execute form of the macro for applications that require reentrant code. The list form defines an area of storage that the execute form uses to store the parameters. Only the PLISTVER parameter can be specified on the list form of the macro. IBM recommends that you always specify PLISTVER=MAX on the list form of the macro.

Use MF=E to specify the execute form of the macro. Use the execute form together with the list form of the macro for applications that require reentrant code. The execute form of the macro stores the parameters into the storage area defined by the list form, and generates the macro invocation to transfer control to the service.

Use MF=M together with the list and execute forms of the macro for service routines that need to provide different options according to user-provided input. Use the list form to define a storage area; use the modify form to set the appropriate options; then use the execute form to call the service.

IBM recommends that you use the modify and execute forms in the following order:

- Use MF=(M,*list_addr*,COMPLETE), specifying appropriate parameters, including all required ones.
- Use MF=(M,*list_addr*,NOCHECK), specifying the parameters you want to change.
- Use MF=(E,*list_addr*,NOCHECK), to execute the macro.

,list addr

The name of a storage area to contain the parameters.

,attr

An optional 1- to 60-character input string, which can contain any value that is valid on an assembler DS pseudo-op. You can use this parameter to force boundary alignment of the parameter list. If you do not code *attr*, the system provides a value of OD, which forces the parameter list to a doubleword boundary.

,COMPLETE

Specifies that the system is to check for required parameters and supply defaults for omitted optional parameters.

,NOCHECK

Specifies that the system is not to check for required parameters and is not to supply defaults for omitted optional parameters.

REQUEST=READBLOCK option of IXGBRWSE

The IXGBRWSE macro with the REQUEST=READBLOCK parameter allows a program to search for and read a specific log block from the log stream. The target can be defined either by the log block identifier or by a time stamp.

Syntax for REQUEST=READBLOCK

The IXGBRWSE REQUEST=READBLOCK macro is written as follows:

IXGBRWSE macro

Syntax	Description
<i>name</i>	<i>name</i> : symbol. Begin <i>name</i> in column 1.
␣	One or more blanks must precede IXGBRWSE.
IXGBRWSE	
␣	One or more blanks must follow IXGBRWSE.
REQUEST=READBLOCK	
,STREAMTOKEN= <i>streamtoken</i>	<i>streamtoken</i> : RS-type address or register (2) - (12).
,BROWSETOKEN= <i>browsetoken</i>	<i>browsetoken</i> : RS-type address or register (2) - (12).
,BLOCKID= <i>blockid</i>	<i>blockid</i> : RS-type address or register (2) - (12).
,SEARCH= <i>search</i>	<i>search</i> : RS-type address or register (2) - (12).
,BUFFER= <i>buffer</i>	<i>buffer</i> : RS-type address or register (2) - (12).
,BUFFER64= <i>buffer64</i>	<i>buffer64</i> : RS-type address or register (2) - (12).
,BUFFLEN= <i>bufflen</i>	<i>bufflen</i> : RS-type address or register (2) - (12).
,ANSAREA= <i>ansarea</i>	<i>ansarea</i> : RS-type address or register (2) - (12).
,ANSLEN= <i>anslen</i>	<i>anslen</i> : RS-type address or register (2) - (12).
GMT=YES	
GMT=NO	
,BUFFALET= <i>buffalet</i>	<i>buffalet</i> : RS-type address or register (2) - (12).
	Default: BUFFALET=0
,BLKSIZE= <i>blksize</i>	<i>blksize</i> : RS-type address or register (2) - (12).
	Default: BLKSIZE=0

Syntax	Description
,RETBLOCKID= <i>retblockid</i>	<i>retblockid</i> : RS-type address or register (2) - (12).
	Default: NO_BLKID
,TIMESTAMP= <i>timestamp</i>	<i>timestamp</i> : RS-type address or register (2) - (12).
	Default: NO_TIMESTAMP
MODE=SYNC	Default: MODE=SYNC
MODE=SYNCECB	
,ECB= <i>ecb</i>	<i>ecb</i> : RS-type address or register (2) - (12).
,PLISTVER=IMPLIED_VERSION	
,PLISTVER=MAX	Default: IMPLIED_VERSION
,PLISTVER= <i>plistver</i>	
,RETCODE= <i>retcode</i>	<i>retcode</i> : RS-type address or register (2) - (12).
,RSNCODE= <i>rsncode</i>	<i>rsncode</i> : RS-type address or register (2) - (12).
,MF=S	Default: MF=S
,MF=(L, <i>list addr</i>)	
,MF=(L, <i>list addr,attr</i>)	
,MF=(L, <i>list addr,0D</i>)	
,MF=(E, <i>list addr</i>)	
,MF=(E, <i>list addr,COMPLETE</i>)	
,MF=(E, <i>list addr,NOCHECK</i>)	
,MF=(M, <i>list addr</i>)	
,MF=(M, <i>list addr,COMPLETE</i>)	
,MF=(M, <i>list addr,NOCHECK</i>)	

Parameters for REQUEST=READBLOCK

The parameters are explained as follows:

REQUEST=READBLOCK

Requests that a program read a specific block from the log stream. The target can be defined either by the log block identifier or by a time stamp.

,STREAMTOKEN=streamtoken

Specifies the name or address (using a register) of a required 16-byte input field containing the token for the log stream that you want to search. The stream token is returned by the IXGCONN service at connection to the log stream.

,BROWSETOKEN=browsetoken

Specifies the name or address (using a register) of a required 4-byte input field containing the identifier for the browse session which was returned from the IXGBRWSE REQUEST=START request.

,BLOCKID=blockid

Specifies the name or address (using a register) of an 8-byte input field that contains the block identifier of the log block you wish to read. The block identifier was returned from the IXGWRITE request.

,SEARCH=search

Specifies the name or address (using a register) of a 64-bit input field containing the time stamp for the log block you wish to search for and read. The time stamp must be Greenwich mean time or local time,

When you use a time stamp as a search criteria, IXGBRWSE searches in the oldest-to-youngest direction, searching for a log block with an exactly matching time stamp. If no exact match is found, IXGBRWSE reads the next latest (youngest) time stamp. For information on how the SEARCH keyword works, see *z/OS MVS Programming: Assembler Services Guide*.

The GMT parameter is required with the SEARCH parameter.

,BUFFER=buffer**,BUFFER64=buffer64**

Specifies the name or address (using a register) of a required output field that contains the buffer into which the log block is read.

- BUFFER=buffer specifies that the location of the buffer is in 31-bit storage.
- BUFFER64=buffer64 specifies that the location of the buffer is in 64-bit storage.

the BUFFER and BUFFER64 parameters are mutually exclusive.

,BUFFLEN=bufflen

Specifies the name or address (using a register) of a required 4-byte input field that contains the length of the buffer specified on the BUFFER or BUFFER64 parameter.

IXGBRWSE will return the length of the block in the BLKSIZE parameter, if specified. You can issue IXGBRWSE with BLKSIZE specified to obtain the length of the block and then re-issue IXGBRWSE using the returned BLKSIZE value in the BUFFLEN parameter.

,ANSAREA=ansarea

Specifies the name (or address in a register) of an answer area containing information about this request. The answer area must be at least 40 bytes. To map this information, use the IXGANSAA macro.

,ANSLEN=anslen

Specifies the name (or address in a register) of the 4-byte field containing the answer area length. The length of the answer area must be at least 40 bytes and must be the same length as the field specified in ANSAREA.

To ascertain the optimal answer area length, look at the ANSAA_PREFERRED_SIZE field of the IXGANSAA macro.

,ANSLEN=anslen

Specifies the name (or register) of the 4-byte field containing the answer area length. The length of the answer area must be at least 32 bytes and must be the same length as the field specified in ANSAREA.

To ascertain the optimal answer area size, look at the ANSAA_PREFERRED_SIZE field of the IXGANSAA macro.

,GMT=YES

,GMT=NO

Specifies whether the time stamp specified on the SEARCH parameter is in Coordinated universal time (UTC) or local time.

- GMT=YES: The time stamp specified on the SEARCH parameter is in Greenwich mean time.
- GMT=NO: The time stamp specified on the SEARCH parameter is local time.

,BUFFALET=*buffalet*

Specifies the name (or address in a register) of a 4-byte input field specifying the access list entry table (ALET) to be used to access the buffer specified on the BUFFER or BUFFER64 keyword. If the buffer is ALET-qualified, the ALET must index a valid entry on the task's dispatchable unit access list (DUAL) or specify a SCOPE=COMMON data space. An ALET that indexes the system logger PASN-AL list will not work.

The default is 0, which means that the buffer is in the calling program's primary address space.

,BLKSIZE=*blksize*

Specifies the name or address (using a register) of a 4-byte output field where the actual size of the requested log block is returned.

,RETBLOCKID=*retblockid*

Specifies the name or address (using a register) of a 8-byte output field where the identifier of the requested log block is returned.

,TIMESTAMP=*timestamp*

Specifies the name or address (using a register) of a 16-byte output field where the Coordinated universal time and local time stamps associated with the requested log block is returned. The UTC time stamp is first, then the local time stamp. Both time stamps will be in TOD-clock format.

,MODE=SYNC

,MODE=SYNCECB

Specifies that the request should be processed in one of the following ways:

- MODE=SYNC: Specifies that the request process synchronously. Control is not returned to the caller until request processing is complete. If necessary, the calling program will be suspended until the request completes.
- MODE=SYNCECB: Specifies that the request process synchronously if possible. If the request processes asynchronously, control returns to the caller before the request completes and the event control block (ECB) specified on the ECB parameter is posted when the request completes. The ECB parameter is required with MODE=SYNCECB.

ECB=*ecb*

Specifies the name or address (using a register) of a 4-byte input field that contains an event control block (ECB) to be posted when the request completes.

Before coding ECB, you must ensure that:

- You initialize the ECB to zero.
- The ECB must reside in either common storage or the home address space at the time the IXGBRWSE request is issued.
- The virtual storage area specified for the ECB must reside on a fullword boundary.

,PLISTVER=IMPLIED_VERSION

,PLISTVER=MAX

,PLISTVER=*plistver*

An optional input parameter that specifies the version of the macro. PLISTVER determines which parameter list the system generates.

The values are:

- **IMPLIED_VERSION**, which is the lowest version that allows all parameters specified on the request to be processed. If you omit the PLISTVER parameter, IMPLIED_VERSION is the default. Note that on the list form, the default will cause the smallest parameter list to be created.
- **MAX**, if you want the parameter list to be the largest size currently possible. This size might grow from release to release and affect the amount of storage that your program needs.

If you can tolerate the size change, IBM recommends that you always specify PLISTVER=MAX on the list form of the macro. Specifying MAX ensures that the list-form parameter list is always long enough to hold all the parameters you might specify on the execute form when both forms are assembled using the same level of the system. In this way, MAX ensures that the parameter list does not overwrite nearby storage.

- **0**, supports all parameters except those specifically referenced in higher versions.
- **1**, supports both the following parameters and parameters from version 0:
 - DIAG
 - REQDATA
- **2**, supports both the following parameters and parameters from version 0 and 1:
 - MAXNUMLOGBLOCKS
 - MULTIBLOCK
 - RETBLOCKINFO

To code: Specify in this input parameter one of the following:

- IMPLIED_VERSION
- MAX
- A decimal value of 0, 1 or 2

,RETCODE=retcode

Specifies a name or address (using a register) of a 4-byte output field where the system will place the return code. The return code is also in general purpose register (GPR) 15.

,RSNCODE=rsncode

Specifies a name or address (using a register) of a 4-byte output field where the system will place the reason code. The reason code is also in general purpose register (GPR) 0, if you received a non-zero return code.

,MF=S

,MF=(L,list addr)

,MF=(L,list addr,attr)

,MF=(L,list addr,OD)

,MF=(E,list addr)

,MF=(E,list addr,COMPLETE)

,MF=(E,list addr,NOCHECK)

,MF=(M,list addr)

,MF=(M,list addr,COMPLETE)

,MF=(M,list addr,NOCHECK)

Use MF=S to specify the standard form of the macro, which builds an inline parameter list and generates the macro invocation to transfer control to the service. MF=S is the default.

Use MF=L to specify the list form of the macro. Use the list form together with the execute form of the macro for applications that require reentrant code. The list form defines an area of storage that the execute form uses to store the parameters. Only the PLISTVER parameter can be specified on the list form of the macro. IBM recommends that you always specify PLISTVER=MAX on the list form of the macro.

Use MF=E to specify the execute form of the macro. Use the execute form together with the list form of the macro for applications that require reentrant code. The execute form of the macro stores the parameters into the storage area defined by the list form, and generates the macro invocation to transfer control to the service.

Use MF=M together with the list and execute forms of the macro for service routines that need to provide different options according to user-provided input. Use the list form to define a storage area; use the modify form to set the appropriate options; then use the execute form to call the service.

IBM recommends that you use the modify and execute forms in the following order:

- Use MF=(M,*list_addr*,COMPLETE), specifying appropriate parameters, including all required ones.
- Use MF=(M,*list_addr*,NOCHECK), specifying the parameters you want to change.
- Use MF=(E,*list_addr*,NOCHECK), to execute the macro.

,list_addr

The name of a storage area to contain the parameters.

,attr

An optional 1- to 60-character input string, which can contain any value that is valid on an assembler DS pseudo-op. You can use this parameter to force boundary alignment of the parameter list. If you do not code *attr*, the system provides a value of 0D, which forces the parameter list to a doubleword boundary.

,COMPLETE

Specifies that the system is to check for required parameters and supply defaults for omitted optional parameters.

,NOCHECK

Specifies that the system is not to check for required parameters and is not to supply defaults for omitted optional parameters.

REQUEST=RESET option of IXGBRWSE

The IXGBRWSE macro with the REQUEST=RESET parameter allows a program to re-position the browse cursor to either the youngest or oldest block in the log stream.

Syntax for REQUEST=RESET

The IXGBRWSE REQUEST=RESET macro is written as follows:

Syntax	Description
<i>name</i>	<i>name</i> : symbol. Begin <i>name</i> in column 1.
␣	One or more blanks must precede IXGBRWSE.
IXGBRWSE	
␣	One or more blanks must follow IXGBRWSE.
REQUEST=RESET	
,STREAMTOKEN= <i>streamtoken</i>	<i>streamtoken</i> : RS-type address or register (2) - (12).
,BROWSETOKEN= <i>browsetoken</i>	<i>browsetoken</i> : RS-type address or register (2) - (12).

Syntax	Description
,POSITION=YOUNGEST	
,POSITION=OLDEST	
,ANSAREA= <i>ansarea</i>	<i>ansarea</i> : RS-type address or register (2) - (12).
,ANSLEN= <i>anslen</i>	<i>anslen</i> : RS-type address or register (2) - (12).
VIEW=ACTIVE	
VIEW=ALL	
MODE=SYNC	Default: MODE=SYNC
MODE=SYNCECB	
,ECB= <i>ecb</i>	<i>ecb</i> : RS-type address or register (2) - (12).
,PLISTVER=IMPLIED_VERSION	
,PLISTVER=MAX	Default: IMPLIED_VERSION
,PLISTVER= <i>plistver</i>	
,RETCODE= <i>retcode</i>	<i>retcode</i> : RS-type address or register (2) - (12).
,RSNCODE= <i>rsncode</i>	<i>rsncode</i> : RS-type address or register (2) - (12).
,MF=S	Default: MF=S
,MF=(L, <i>list addr</i>)	
,MF=(L, <i>list addr,attr</i>)	
,MF=(L, <i>list addr,OD</i>)	
,MF=(E, <i>list addr</i>)	
,MF=(E, <i>list addr,COMPLETE</i>)	
,MF=(E, <i>list addr,NOCHECK</i>)	
,MF=(M, <i>list addr</i>)	
,MF=(M, <i>list addr,COMPLETE</i>)	
,MF=(M, <i>list addr,NOCHECK</i>)	

Parameters for REQUEST=RESET

The parameters are explained as follows:

REQUEST=RESET

Requests that the browse cursor be repositioned at either the oldest or youngest block in the log stream.

,STREAMTOKEN=*streamtoken*

Specifies the name or address (using a register) of a required 16-byte input field containing the token for the log stream that you want to search. The stream token is returned by the IXGCONN service at connection to the log stream.

,BROWSETOKEN=*browsetoken*

Specifies the name or address (using a register) of a required 4-byte input field containing the identifier for the browse session which was returned from the IXGBRWSE REQUEST=START request.

,POSITION=YOUNGEST

,POSITION=OLDEST

Specifies the cursor position desired, at either the youngest or the oldest log block in the log stream.

,ANSAREA=*ansarea*

Specifies the name (or address in a register) of an answer area containing information about this request. The answer area must be at least 40 bytes. To map this information, use the IXGANSAA macro.

,ANSLEN=*anslen*

Specifies the name (or address in a register) of the 4-byte field containing the answer area length. The length of the answer area must be at least 40 bytes and must be the same length as the field specified in ANSAREA.

To ascertain the optimal answer area length, look at the ANSAA_PREFERRED_SIZE field of the IXGANSAA macro.

,ANSLEN=*anslen*

Specifies the name (or register) of the 4-byte field containing the answer area length. The length of the answer area must be at least 32 bytes and must be the same length as the field specified in ANSAREA.

To ascertain the optimal answer area size, look at the ANSAA_PREFERRED_SIZE field of the IXGANSAA macro.

VIEW=ACTIVE

VIEW=ALL

Specifies whether requests issued during this browse session return active data only, or both active and inactive data. Active data is data that has not been marked for deletion via the IXGDELET service. Inactive data is data that has been deleted via IXGDELET but has not been physically deleted from the log stream because of the retention period specified in the log stream policy definition in the active system logger couple data set.

- VIEW=ACTIVE, which is the default, specifies that in this browse session, system logger will only return active data from the log stream.
- VIEW=ALL specifies that in this browse session, system logger will return both active and inactive data.

When VIEW=ALL is specified and a log block is returned, system logger sets a flag in the answer area, AnsaBlkFromInactive, indicating whether the block was active or eligible for deletion.

,MODE=SYNC

,MODE=SYNCECB

Specifies that the request should be processed in one of the following ways:

- MODE=SYNC: Specifies that the request process synchronously. Control is not returned to the caller until request processing is complete. If necessary, the calling program will be suspended until the request completes.

- **MODE=SYNCECB**: Specifies that the request process synchronously if possible. If the request processes asynchronously, control returns to the caller before the request completes and the event control block (ECB) specified on the ECB parameter is posted when the request completes. The ECB parameter is required with **MODE=SYNCECB**.

ECB=ecb

Specifies the name or address (using a register) of a 4-byte input field that contains an event control block (ECB) to be posted when the request completes.

Before coding ECB, you must ensure that:

- You initialize the ECB to zero.
- The ECB must reside in either common storage or the home address space at the time the IXGBRWSE request is issued.
- The virtual storage area specified for the ECB must reside on a fullword boundary.

,PLISTVER=IMPLIED_VERSION**,PLISTVER=MAX****,PLISTVER=plistver**

An optional input parameter that specifies the version of the macro. PLISTVER determines which parameter list the system generates.

The values are:

- **IMPLIED_VERSION**, which is the lowest version that allows all parameters specified on the request to be processed. If you omit the PLISTVER parameter, IMPLIED_VERSION is the default. Note that on the list form, the default will cause the smallest parameter list to be created.
- **MAX**, if you want the parameter list to be the largest size currently possible. This size might grow from release to release and affect the amount of storage that your program needs.

If you can tolerate the size change, IBM recommends that you always specify **PLISTVER=MAX** on the list form of the macro. Specifying **MAX** ensures that the list-form parameter list is always long enough to hold all the parameters you might specify on the execute form when both forms are assembled using the same level of the system. In this way, **MAX** ensures that the parameter list does not overwrite nearby storage.

- **0**, supports all parameters except those specifically referenced in higher versions.
- **1**, supports both the following parameters and parameters from version 0:
 - **DIAG**
 - **REQDATA**
- **2**, supports both the following parameters and parameters from version 0 and 1:
 - **MAXNUMLOGBLOCKS**
 - **MULTIBLOCK**
 - **RETBLOCKINFO**

To code: Specify in this input parameter one of the following:

- **IMPLIED_VERSION**
- **MAX**
- A decimal value of 0, 1 or 2

,RETCODE=retcode

Specifies a name or address (using a register) of a 4-byte output field where the system will place the return code. The return code is also in general purpose register (GPR) 15.

,RSNCODE=rsncode

Specifies a name or address (using a register) of a 4-byte output field where the system will place the reason code. The reason code is also in general purpose register (GPR) 0, if you received a non-zero return code.

,MF=S
,MF=(L,list addr)
,MF=(L,list addr,attr)
,MF=(L,list addr,OD)
,MF=(E,list addr)
,MF=(E,list addr,COMPLETE)
,MF=(E,list addr,NOCHECK)
,MF=(M,list addr)
,MF=(M,list addr,COMPLETE)
,MF=(M,list addr,NOCHECK)

Use MF=S to specify the standard form of the macro, which builds an inline parameter list and generates the macro invocation to transfer control to the service. MF=S is the default.

Use MF=L to specify the list form of the macro. Use the list form together with the execute form of the macro for applications that require reentrant code. The list form defines an area of storage that the execute form uses to store the parameters. Only the PLISTVER parameter can be specified on the list form of the macro. IBM recommends that you always specify PLISTVER=MAX on the list form of the macro.

Use MF=E to specify the execute form of the macro. Use the execute form together with the list form of the macro for applications that require reentrant code. The execute form of the macro stores the parameters into the storage area defined by the list form, and generates the macro invocation to transfer control to the service.

Use MF=M together with the list and execute forms of the macro for service routines that need to provide different options according to user-provided input. Use the list form to define a storage area; use the modify form to set the appropriate options; then use the execute form to call the service.

IBM recommends that you use the modify and execute forms in the following order:

- Use MF=(M,*list_addr*,COMPLETE), specifying appropriate parameters, including all required ones.
- Use MF=(M,*list_addr*,NOCHECK), specifying the parameters you want to change.
- Use MF=(E,*list_addr*,NOCHECK), to execute the macro.

,list addr

The name of a storage area to contain the parameters.

,attr

An optional 1- to 60-character input string, which can contain any value that is valid on an assembler DS pseudo-op. You can use this parameter to force boundary alignment of the parameter list. If you do not code *attr*, the system provides a value of OD, which forces the parameter list to a doubleword boundary.

,COMPLETE

Specifies that the system is to check for required parameters and supply defaults for omitted optional parameters.

,NOCHECK

Specifies that the system is not to check for required parameters and is not to supply defaults for omitted optional parameters.

REQUEST=END option of IXGBRWSE

The IXGBRWSE macro with the REQUEST=END parameter ends the browse session begun with the REQUEST=START parameter.

Syntax for REQUEST=END

The IXGBRWSE REQUEST=END macro is written as follows:

Syntax	Description

IXGBRWSE macro

Syntax	Description
<i>name</i>	<i>name</i> : symbol. Begin <i>name</i> in column 1.
␣	One or more blanks must precede IXGBRWSE.
IXGBRWSE	
␣	One or more blanks must follow IXGBRWSE.
REQUEST=END	
,STREAMTOKEN= <i>streamtoken</i>	<i>streamtoken</i> : RS-type address or register (2) - (12).
,BROWSETOKEN= <i>browsetoken</i>	<i>browsetoken</i> : RS-type address or register (2) - (12).
,ANSAREA= <i>ansarea</i>	<i>ansarea</i> : RS-type address or register (2) - (12).
,ANSLEN= <i>anslen</i>	<i>anslen</i> : RS-type address or register (2) - (12).
MODE=SYNC	Default: MODE=SYNC
MODE=SYNCECB	
,ECB= <i>ecb</i>	<i>ecb</i> : RS-type address or register (2) - (12).
,PLISTVER=IMPLIED_VERSION	
,PLISTVER=MAX	Default: IMPLIED_VERSION
,PLISTVER= <i>plistver</i>	
,RETCODE= <i>retcode</i>	<i>retcode</i> : RS-type address or register (2) - (12).
,RSNCODE= <i>rsncode</i>	<i>rsncode</i> : RS-type address or register (2) - (12).
,MF=S	Default: MF=S
,MF=(L, <i>list addr</i>)	
,MF=(L, <i>list addr,attr</i>)	

Syntax	Description
,MF=(L, <i>list addr</i> ,OD)	
,MF=(E, <i>list addr</i>)	
,MF=(E, <i>list addr</i> ,COMPLETE)	
,MF=(E, <i>list addr</i> ,NOCHECK)	
,MF=(M, <i>list addr</i>)	
,MF=(M, <i>list addr</i> ,COMPLETE)	
,MF=(M, <i>list addr</i> ,NOCHECK)	

Parameters for REQUEST=END

The parameters are explained as follows:

REQUEST=END

Requests that the browse session be ended.

,STREAMTOKEN=*streamtoken*

Specifies the name or address (using a register) of a required 16-byte input field containing the token for the log stream that you want to search. The stream token is returned by the IXGCONN service at connection to the log stream.

,BROWSETOKEN=*browsetoken*

Specifies the name or address (using a register) of a required 4-byte input field containing the identifier for the browse session which was returned from the IXGBRWSE REQUEST=START request.

,ANSAREA=*ansarea*

Specifies the name (or address in a register) of an answer area containing information about this request. The answer area must be at least 40 bytes. To map this information, use the IXGANSAA macro.

,ANSLEN=*anslen*

Specifies the name (or address in a register) of the 4-byte field containing the answer area length. The length of the answer area must be at least 40 bytes and must be the same length as the field specified in ANSAREA.

To ascertain the optimal answer area length, look at the ANSAA_PREFERRED_SIZE field of the IXGANSAA macro.

,MODE=SYNC

,MODE=SYNCECB

Specifies that the request should be processed in one of the following ways:

- **MODE=SYNC:** Specifies that the request process synchronously. Control is not returned to the caller until request processing is complete. If necessary, the calling program will be suspended until the request completes.
- **MODE=SYNCECB:** Specifies that the request process synchronously if possible. If the request processes asynchronously, control returns to the caller before the request completes and the event control block (ECB) specified on the ECB parameter is posted when the request completes. The ECB parameter is required with MODE=SYNCECB.

ECB=*ecb*

Specifies the name or address (using a register) of a 4-byte input field that contains an event control block (ECB) to be posted when the request completes.

Before coding ECB, you must ensure that:

- You initialize the ECB to zero.

- The ECB must reside in either common storage or the home address space at the time the IXGBRWSE request is issued.
- The virtual storage area specified for the ECB must reside on a fullword boundary.

,PLISTVER=IMPLIED_VERSION**,PLISTVER=MAX****,PLISTVER=plistver**

An optional input parameter that specifies the version of the macro. PLISTVER determines which parameter list the system generates.

The values are:

- **IMPLIED_VERSION**, which is the lowest version that allows all parameters specified on the request to be processed. If you omit the PLISTVER parameter, IMPLIED_VERSION is the default. Note that on the list form, the default will cause the smallest parameter list to be created.
- **MAX**, if you want the parameter list to be the largest size currently possible. This size might grow from release to release and affect the amount of storage that your program needs.

If you can tolerate the size change, IBM recommends that you always specify PLISTVER=MAX on the list form of the macro. Specifying MAX ensures that the list-form parameter list is always long enough to hold all the parameters you might specify on the execute form when both forms are assembled using the same level of the system. In this way, MAX ensures that the parameter list does not overwrite nearby storage.

- **0**, supports all parameters except those specifically referenced in higher versions.
- **1**, supports both the following parameters and parameters from version 0:
 - DIAG
 - REQDATA
- **2**, supports both the following parameters and parameters from version 0 and 1:
 - MAXNUMLOGBLOCKS
 - MULTIBLOCK
 - RETBLOCKINFO

To code: Specify in this input parameter one of the following:

- IMPLIED_VERSION
- MAX
- A decimal value of 0, 1 or 2

,RETCODE=retcode

Specifies a name or address (using a register) of a 4-byte output field where the system will place the return code. The return code is also in general purpose register (GPR) 15.

,RSNCODE=rsncode

Specifies a name or address (using a register) of a 4-byte output field where the system will place the reason code. The reason code is also in general purpose register (GPR) 0, if you received a non-zero return code.

,MF=S
,MF=(L,list addr)
,MF=(L,list addr,attr)
,MF=(L,list addr,OD)
,MF=(E,list addr)
,MF=(E,list addr,COMPLETE)
,MF=(E,list addr,NOCHECK)
,MF=(M,list addr)
,MF=(M,list addr,COMPLETE)
,MF=(M,list addr,NOCHECK)

Use MF=S to specify the standard form of the macro, which builds an inline parameter list and generates the macro invocation to transfer control to the service. MF=S is the default.

Use MF=L to specify the list form of the macro. Use the list form together with the execute form of the macro for applications that require reentrant code. The list form defines an area of storage that the execute form uses to store the parameters. Only the PLISTVER parameter can be specified on the list form of the macro. IBM recommends that you always specify PLISTVER=MAX on the list form of the macro.

Use MF=E to specify the execute form of the macro. Use the execute form together with the list form of the macro for applications that require reentrant code. The execute form of the macro stores the parameters into the storage area defined by the list form, and generates the macro invocation to transfer control to the service.

Use MF=M together with the list and execute forms of the macro for service routines that need to provide different options according to user-provided input. Use the list form to define a storage area; use the modify form to set the appropriate options; then use the execute form to call the service.

IBM recommends that you use the modify and execute forms in the following order:

- Use MF=(M,*list_addr*,COMPLETE), specifying appropriate parameters, including all required ones.
- Use MF=(M,*list_addr*,NOCHECK), specifying the parameters you want to change.
- Use MF=(E,*list_addr*,NOCHECK), to execute the macro.

,list addr

The name of a storage area to contain the parameters.

,attr

An optional 1- to 60-character input string, which can contain any value that is valid on an assembler DS pseudo-op. You can use this parameter to force boundary alignment of the parameter list. If you do not code *attr*, the system provides a value of OD, which forces the parameter list to a doubleword boundary.

,COMPLETE

Specifies that the system is to check for required parameters and supply defaults for omitted optional parameters.

,NOCHECK

Specifies that the system is not to check for required parameters and is not to supply defaults for omitted optional parameters.

ABEND codes

The IXGBRWSE service may issue abend X'1C5' with reason codes X'804', X'85F' or X'30006'. See [z/OS MVS System Codes](#) for more information on this abend.

Return and reason codes

When IXGBRWSE macro returns control to your program, GPR 15 contains a return code and GPR 0 contains a reason code.

Note: A program invoking the IXGBRWSE service may indicate via the MODE parameter that requests which can not be completed synchronously should have control returned to the caller prior to completion

of the request. When the request does complete, the invoker will be notified and the return and reason codes are in the answer area mapped by IXGANSAA.

The IXGCON mapping macro provides equate symbols for the return and reason codes. The equate symbols associated with each hexadecimal return code are as follows:

00

IXGRSNCODEOK - Service completes successfully.

04

IXGRSNCODEWARNING - Service completes with a warning.

08

IXGRETCODEERROR - Service does not complete.

0C

IXGRETCODECOMPERROR - Service does not complete.

The following table contains hexadecimal return and reason codes, the equate symbols associated with each reason code, and the meaning and suggested action for each return and reason code.

Return Code	Reason Code	Meaning and Action
00	xxxx0000	Equate Symbol: IxgRsnCodeOk Explanation: Request processed successfully.
04	xxxx0401	Equate Symbol: IxgRsnCodeProcessedAsynch Explanation: Program error. The program specified MODE=SYNCECB and the request must be processed asynchronously. Action: Wait for the ECB specified on the ECB parameter to be posted, indicating that the request is complete. Check the ANSAA_ASYNC_RETCODE and ANSAA_ASYNC_RSNCODE fields, mapped by IXGANSAA, to determine whether the request completed successfully.
04	xxxx0402	Equate Symbol: IxgRsnCodeWarningDel Explanation: Environment error. The request completed successfully, but the data requested was deleted from the log stream. The next available data in the log stream in the direction specified is returned. Action: Determine whether this is an acceptable condition for your application. If so, ignore this condition. If not, provide serialization or some other installation protocol to prevent deletes from being performed by other applications on the log stream during a browse session.

Table 35. Return and Reason Codes for the IXGBRWSE Macro (continued)

Return Code	Reason Code	Meaning and Action
04	xxxx0403	<p>Equate Symbol: IxgRsnCodeWarningGap</p> <p>Explanation: Environment error. The request completed successfully, but the data requested was unreadable. The next readable data in the log stream in the specified direction is returned. This condition could be caused by either an I/O error while attempting to read a log data set or a log data set deleted without using the logger interfaces.</p> <p>Action: The action necessary is completely up to the application, depending on how critical your data is. You can do one of the following:</p> <ul style="list-style-type: none"> • Accept this condition and continue reading. • Stop processing the log all together. • Attempt to get the problem rectified, if possible, and then attempt to re-read the log data.
04	xxxx0405	<p>Equate Symbol: IxgRsnCodeWarningLossOfData</p> <p>Explanation: Environment error. Returned for READCURSOR, START OLDEST and RESET OLDEST requests. This condition occurs when a system and coupling facility fail and not all of the log data in the log stream could be recovered.</p> <ul style="list-style-type: none"> • For READCURSOR: A log block has been returned, but there may be log blocks permanently missing between this log block and the one previously returned. • For START OLDEST and RESET OLDEST: The oldest log blocks in the log stream may be permanently missing, the browse cursor is set at the oldest available log block. <p>Action: If your application cannot tolerate any data loss, stop issuing system logger services to this log stream, disconnect from the log stream, and reconnect to a new, undamaged log stream. You can continue using the log stream if your applications can tolerate data loss.</p>

<i>Table 35. Return and Reason Codes for the IXGBRWSE Macro (continued)</i>		
Return Code	Reason Code	Meaning and Action
04	xxxx0416	<p>Equate Symbol: IxgRsnCodeWarningMultiblock</p> <p>Explanation: Environment error. Returned for READCURSOR requests with MULTIBLOCK=YES specified only. The request completed successfully, which means that some log block data was returned, but at least one of the log blocks returned in the buffer area encountered a warning return code condition. To determine which log block or blocks encountered the warning condition, check the fields, Ixgbrmlt_RetCode and Ixgbrmlt_RsnCode, as the log blocks are processed by your program.</p> <p>Action: The action necessary is completely up to the application, depending on how critical your data is. You can do one of the following:</p> <ul style="list-style-type: none"> • Accept this condition and continue reading. • Stop processing the log all together. • Attempt to get the problem rectified, if possible, and then attempt to re-read the log data.
04	xxxx0417	<p>Equate Symbol: IxgRsnCodeMultiblockErrorWarning</p> <p>Explanation: Environment error. Returned for READCURSOR requests with MULTIBLOCK=YES specified only. A log block has been returned, but an error condition was encountered while attempting to read more data. This may be issued when some log block data is returned and an end of the log stream (eof) is reached.</p> <p>Action: The action necessary is completely up to the application, depending on how critical your data is. You can do one of the following:</p> <ul style="list-style-type: none"> • Accept this condition and continue reading. • Stop processing the log all together. • Attempt to get the problem rectified, if possible, and then attempt to re-read the log data.
08	xxxx0801	<p>Equate Symbol: IxgRsnCodeBadParmlist</p> <p>Explanation: Program error. The parameter list could not be accessed.</p> <p>Action: Ensure that the storage area for the parameter list is accessible to the system logger for the duration of the request. The parameter list storage must be addressable in the caller's primary address space and in the same key as the caller.</p>
08	xxxx0802	<p>Equate Symbol: IxgRsnCodeXESError</p> <p>Explanation: System error. A severe cross-system extended services (XES) error has occurred.</p> <p>Action: See ANSAA_DIAG1 for the XES return code and ANSAA_DIAG2 for the XES reason code.</p>

Table 35. Return and Reason Codes for the IXGBRWSE Macro (continued)

Return Code	Reason Code	Meaning and Action
08	xxxx0803	<p>Equate Symbol: IxgRsnCodeBadBuffer</p> <p>Explanation: Program error. The virtual storage area specified on the BUFFER or BUFFER64 parameter is not addressable. On IXGBRWSE READCURSOR MULTIBLOCK requests, the buffer address must be on a word boundary.</p> <p>Action: Ensure that the storage area specified on the BUFFER or BUFFER64 parameter is accessible to system logger for the duration of the request. If the BUFFKEY parameter is specified, make sure it contains a valid key associated with the storage area. If BUFFKEY is not used, ensure that the storage is in the same key as the program at the time the logger service was requested. The storage must be addressable in the caller's primary address space. For IXGBRWSE READCURSOR MULTIBLOCK requests, put the buffer address on a word boundary.</p>
08	xxxx0804	<p>Equate Symbol: IxgRsnCodeNoBlock</p> <p>Explanation: Program error. The block identifier or time stamp does not exist in the requested view of the log stream. If the SEARCH parameter was specified on a START request, the time stamp is greater than any block in the log stream. Either the value provided was never a valid location within the log stream, or a prior IXGDELET request deleted the portion of the log stream it referred to.</p> <p>Action: Ensure that the value provided references an existing portion of the log stream.</p>
08	xxxx0806	<p>Equate Symbol: IxgRsnCodeBadStmToken</p> <p>Explanation: Program error. One of the following occurred:</p> <ul style="list-style-type: none"> • The stream token was not valid. • The specified request was issued from an address space other than the connector's address space. <p>Action: Do one of the following:</p> <ul style="list-style-type: none"> • Make sure that the stream token specified is valid. • Ensure that the request was issued from the connector's address space.
08	xxxx0807	<p>Equate Symbol: IxgRsnCodeBadBrwToken</p> <p>Explanation: Program error. The browse token specified is not valid.</p> <p>Action: Ensure that the browse token being passed to the IXGBRWSE service is the same one returned from the IXGBRWSE REQUEST=START function.</p>

<i>Table 35. Return and Reason Codes for the IXGBRWSE Macro (continued)</i>		
Return Code	Reason Code	Meaning and Action
08	xxxx080A	<p>Equate Symbol: IxgRsnCodeRequestLocked</p> <p>Explanation: Program error. The program issuing the request is holding a lock.</p> <p>Action: Ensure that the program issuing the request is not holding a lock.</p>
08	xxxx080F	<p>Equate Symbol: IxgRsnCodeBadBufsize</p> <p>Explanation: Program error. The buffer specified on the BUFFER or BUFFER64 parameter is not large enough to contain the next log block. No data is returned.</p> <p>Action: Obtain a buffer of at least the length returned in the BLKSIZE parameter and then re-issue the request.</p>
08	xxxx0814	<p>Equate Symbol: IxgRsnCodeNotAvailForIPL</p> <p>Explanation: Environment error. The system logger address space is not available for the remainder of this IPL. The system issues messages about this error during system logger initialization.</p> <p>Action: See the explanation for system messages issued during system logger initialization.</p>
08	xxxx0815	<p>Equate Symbol: IxgRsnCodeNotEnabled</p> <p>Explanation: Program error. The program issuing the request is not enabled for I/O and external interrupts, so the request fails.</p> <p>Action: Make sure the program issuing the request is enabled for I/O and external interrupts.</p>
08	xxxx0816	<p>Equate Symbol: IxgRsnCodeBadAnslen</p> <p>Explanation: Program error. The answer area length (ANSLEN parameter) is not large enough. The system logger returned the required size in the Ansaas_Preferred_Size field of the answer area, mapped by IXGANSAA macro.</p> <p>Action: Re-issue the request, specifying an answer area of the required size.</p>
08	xxxx0817	<p>Equate Symbol: IxgRsnCodeBadAnsarea</p> <p>Explanation: Program error. The storage area specified on the ANSAREA parameter cannot be accessed. This may occur after the system logger address space has terminated.</p> <p>Action: Specify storage that is in the caller's primary address space and in the same key as the calling program at the time the system logger service was issued. This storage must be accessible until the request completes.</p>

Table 35. Return and Reason Codes for the IXGBRWSE Macro (continued)

Return Code	Reason Code	Meaning and Action
08	xxxx0818	<p>Equate Symbol: IxgRsnCodeBadBlockidStor</p> <p>Explanation: Program error. The storage area specified by BLOCKID cannot be accessed.</p> <p>Action: Ensure that the storage area is accessible to system logger for the duration of the request. The storage must be addressable in the caller's primary address space and in the same key as the caller.</p>
08	xxxx081C	<p>Equate Symbol: IxgRsnCodeNotAuthFunc</p> <p>Explanation: Program error. The browse function (IXGBRWSE) is not authorized for the log stream connection token. The program connected to the log stream with the AUTH=WRITE parameter and was granted limited access (for example, write only log data and disconnect) as per the defined security access profiles, and then tried to perform a log stream access service other than IXGWRITE or IXGCONN (to disconnect).</p> <p>Action: A connection to the log stream with the appropriate access authority must be established before using the log stream browse (IXGBRWSE) service. If AUTH=WRITE was already in use when the error was encountered, then check with your installation's security administrator on obtaining the appropriate access to the log stream.</p>
08	xxxx082D	<p>Equate Symbol: IxgRsnCodeExpiredStmToken</p> <p>Explanation: Environment error. The stream token is no longer valid because the connector has been disconnected.</p> <p>Action: Connect to the log stream again before issuing any functional requests.</p>
08	xxxx0836	<p>Equate Symbol: IxgRsnCodeBadGap</p> <p>Explanation: Environment error. The request failed because the requested log data was unreadable. This condition could be caused by either an I/O error while attempting to read a log data set or a log data set deleted without using logger interfaces.</p> <p>Action: For an IXGBRWSE request, choose on of the following:</p> <ul style="list-style-type: none"> • Continue processing. • Stop processing the log stream all together. • Attempt to get the problem rectified if possible, then attempt to re-read the log data. <p>For an IXGDELET request, the block identifier of the first accessible block toward the youngest data in the log stream is returned in the ANSAA_GAPS_NEXT_BLKID field in the answer area mapped by the IXGANSAA macro. If appropriate, re-issue the IXGDELET request using this block identifier.</p>

<i>Table 35. Return and Reason Codes for the IXGBRWSE Macro (continued)</i>		
Return Code	Reason Code	Meaning and Action
08	xxxx0837	<p>Equate Symbol: IxgRsnCodeBadTimestamp</p> <p>Explanation: Program error. The storage area specified by <code>TIMESTAMP</code> cannot be accessed.</p> <p>Action: Ensure that the storage area is accessible to the system logger service for the duration of the request. The storage must be addressable in the caller's primary address space and in the same key as the caller.</p>
08	xxxx083B	<p>Equate Symbol: IxgRsnCodeBadBTokenStor</p> <p>Explanation: Program error. The storage area specified by <code>BROWSETOKEN</code> cannot be accessed.</p> <p>Action: Ensure that the storage area is accessible to the system logger for the duration of the request. The storage must be addressable in the caller's primary address space and in the same key as the caller.</p>
08	xxxx083D	<p>Equate Symbol: IxgRsnCodeBadECBStor</p> <p>Explanation: Program error. The ECB storage area was not accessible to the system logger.</p> <p>Action: Ensure that the storage area is accessible to the system logger for the duration of the request. The storage must be addressable in the caller's home address space and in the same key as the caller.</p>
08	xxxx083F	<p>Equate Symbol: IxgRsnCodeTeststartError</p> <p>Explanation: System error. An unexpected error was encountered while attempting to validate the buffer <code>ALET</code>.</p> <p>Action: See <code>ANSAA_DIAG1</code> in the answer area mapped by the <code>IXGANSAA</code> macro for the return code from the <code>TESTSTART</code> system service.</p>
08	xxxx0841	<p>Equate Symbol: IxgRsnCodeBadBufferAlet</p> <p>Explanation: Program error. The buffer <code>ALET</code> specified is not zero and does not represent a valid entry on the caller's dispatchable unit access list (<code>DUAL</code>). See the <code>ANSAA_DIAG1</code> field of the answer area, mapped by the <code>IXGANSAA</code> macro, for the return code from the <code>TESTSTART</code> system service.</p> <p>Action: Ensure that the correct <code>ALET</code> was specified. If not, provide the correct <code>ALET</code>. Otherwise, add the correct <code>ALET</code> to dispatchable unit access list (<code>DUAL</code>).</p>

Table 35. Return and Reason Codes for the IXGBRWSE Macro (continued)

Return Code	Reason Code	Meaning and Action
08	xxxx0845	<p>Equate Symbol: IxgRsnCodeInvalidFunc</p> <p>Explanation: System error. One of 2 problems was detected.</p> <ol style="list-style-type: none"> The parameter list for this service contains an unrecognizable function code. The parameter list storage may have been overlaid. The IXGBRWSE START is rejected because either: <ul style="list-style-type: none"> A: An unauthorized caller attempted to start a session when 100 or more browse sessions already exist for this connection. Or, B: An unauthorized caller attempted to start a session when 20 or more browse sessions already exist that show no recent activity. (An unauthorized caller is a caller whose PSW Key is ≥ 8 and that is not in supervisor state). <p>For Case 2: DIAG1 in the Answer Area will contain 1 if 'A' is the case, and 2 if 'B' is the case.</p> <p>DIAG2 will contain the number of browse sessions that was exceeded.</p> <p>Action: Fix the problem and then re-issue the request. It may be necessary to terminate some Browse sessions that are not being used.</p>
08	xxxx0846	<p>Equate Symbol: IxgRsnCodeEmptyStream</p> <p>Explanation: Environment error. The log stream is empty.</p> <p>Action: Wait for data to be written to the log stream before browsing for data.</p>
08	xxxx0847	<p>Equate Symbol: IxgRsnCodeEOFDelete</p> <p>Explanation: Environment error. The request prematurely reached the beginning or the end of the log stream. The portion of the log stream from the requested log data to either the beginning or the end of the log stream (depending on the direction of the read) was deleted from the log stream.</p> <p>Action: Determine whether this is an acceptable condition for your application. If so, ignore this condition. If not, provide serialization on the log stream or some other installation protocol to prevent deletes from being performed by other applications during a browse session.</p>

<i>Table 35. Return and Reason Codes for the IXGBRWSE Macro (continued)</i>		
Return Code	Reason Code	Meaning and Action
08	xxxx0848	<p>Equate Symbol: IxgRsnCodeEndReached</p> <p>Explanation: Environment error. The request failed and no log data is returned. For a READCURSOR request, the end of the log stream has been reached in the direction of the read. If the SEARCH parameter was specified on a READBLOCK request, the time stamp is greater than any block in the log stream.</p> <p>Action: For the READCURSOR case, no more data exists in the log stream in the direction of the read. You can choose to stop reading, wait for more data to be written, or change the direction of the read. In the case where the SEARCH parameter was provided, ensure that the time stamp is less than or equal to the highest time stamp of a log block in the log stream.</p>
08	xxxx0849	<p>Equate Symbol: IxgRsnCodeBadBuffkey</p> <p>Explanation: Program error. The buffer key specified on the BUFFKEY parameter specifies an invalid key. Either the key is greater than 15 or the program is running in problem state and the specified key is not the same key as the PSW key at the time the system logger service was issued.</p> <p>Action: For problem state programs, either do not specify the BUFFKEY parameter or else specify the same key as the PSW key at the time the system logger service was issued. For supervisor state programs, specify a valid storage key (0 <= key <= 15).</p>
08	xxxx084A	<p>Equate Symbol: IxgRsnCodeEOFGap</p> <p>Explanation: Environment error. The request prematurely reached the beginning or the end of the log stream. The portion of the log stream from the requested log data to either the beginning or the end of the log stream (depending on the direction of the read) was unreadable. This condition may be caused by either an I/O error while trying to read a log data set, or a log data set deleted without using logger interfaces.</p> <p>Action: The action necessary is completely up to the application depending on how critical your data is. You can do one of the following:</p> <ul style="list-style-type: none"> • Accept this condition and continue reading. • Stop processing the log all together. • Attempt to get the problem rectified, if possible, and then attempt to re-issue the request.

Table 35. Return and Reason Codes for the IXGBRWSE Macro (continued)

Return Code	Reason Code	Meaning and Action
08	xxxx084B	<p>Equate Symbol: IxgRsnCodeLossOfDataGap</p> <p>Explanation: Environment error. The requested log data referenced a section of the log stream where log data is permanently missing. This condition occurs when a system or coupling facility is in recovery due to a failure, but not all of the log data in the log stream could be recovered.</p> <p>Action: If your application cannot tolerate any data loss, stop issuing system logger services to this log stream, disconnect from the log stream, and reconnect to a new, undamaged log stream. You can continue using the log stream if your applications can tolerate data loss.</p>
08	xxxx084D	<p>Equate Symbol: IxgRsnCodeLossOfDataEOF</p> <p>Explanation: Environment error. The request prematurely reached the beginning or the end of the log stream. The portion of the log stream from the requested log data to either the beginning or the end of the log stream (depending on direction of the read) was permanently lost. This condition occurs when a system or coupling facility is in recovery due to a failure, but not all of the log data in the log stream could be recovered.</p> <p>Action: If your application cannot tolerate any data loss, stop issuing system logger services to this log stream, disconnect from the log stream, and reconnect to a new, undamaged log stream. You can continue using the log stream if your applications can tolerate data loss.</p>
08	xxxx0852	<p>Equate Symbol: IxgRsnCodeBadBlkSizeStor</p> <p>Explanation: Program error. The storage area specified on the BLKSIZE parameter cannot be accessed.</p> <p>Action: Ensure that the storage area is accessible to system logger for the duration of the request.</p>
08	xxxx085F	<p>Equate Symbol: IxgRsnPercToRequestor</p> <p>Explanation: Environment error. Percolation to the service requestor's task occurred because of an abend during system logger processing. Retry was not allowed.</p> <p>Action: Issue the request again. If the problem persists, contact the IBM Support Center.</p>

<i>Table 35. Return and Reason Codes for the IXGBRWSE Macro (continued)</i>		
Return Code	Reason Code	Meaning and Action
08	xxxx0861	<p>Equate Symbol: IxgRsnCodeRebuildInProgress</p> <p>Explanation: Environment error. No requests can be processed for this log stream because a coupling facility structure re-build is in progress for the structure associated with this log stream.</p> <p>Action: Listen for ENF signal 48 that will indicate one of the following:</p> <ul style="list-style-type: none"> • The log stream is available because the re-build completed successfully. Re-issue the request. • The re-build failed and the log stream is not available.
08	xxxx0862	<p>Equate Symbol: IxgRsnCodeXESPurge</p> <p>Explanation: Environment error. An cross-system extended services (XES) request has been purged due to re-build processing.</p> <p>Action: Listen for ENF signal 48 that will indicate one of the following:</p> <ul style="list-style-type: none"> • The log stream is available because the re-build completed successfully. Re-issue the request. • The re-build failed and the log stream is not available.
08	xxxx0863	<p>Equate Symbol: IxgRsnCodeStructureFailed</p> <p>Explanation: Environment error. Either the coupling facility structure associated with the log stream has failed or the coupling facility itself has failed.</p> <p>Action: Listen for ENF signal 48 that will indicate one of the following:</p> <ul style="list-style-type: none"> • The log stream is available because the re-build completed successfully. Re-issue the request. • The re-build failed and the log stream is not available.

Table 35. Return and Reason Codes for the IXGBRWSE Macro (continued)

Return Code	Reason Code	Meaning and Action
08	xxxx0864	<p>Equate Symbol: IxgRsnCodeNoConnectivity</p> <p>Explanation: Environment error. No connectivity exists to the coupling facility associated with the log stream. The system logger will either attempt to re-build the log stream in another coupling facility or the log stream will be disconnected.</p> <p>Action: Listen for ENF signal 48 that will indicate one of the following:</p> <ul style="list-style-type: none"> • The log stream is available because the re-build completed successfully. Re-issue the request. • The re-build failed and the log stream is not available. • The log stream has been disconnected from this system. <p>If a re-build initiated because of a loss of connectivity previously failed, an ENF corresponding to this reason code might not be issued. Further action by the installation might be necessary to cause the change of the log stream status again. Check the log for messages IXG101I, IXG107I and related rebuild messages for information on resolving any outstanding issues.</p>
08	xxxx0890	<p>Equate Symbol: IxgRsnCodeAddrSpaceNotAvail</p> <p>Explanation: System error. The system logger address space failed and is not available.</p> <p>Action: Do not issue system logger requests.</p>
08	xxxx0891	<p>Equate Symbol: IxgRsnCodeAddrSpaceInitializing</p> <p>Explanation: System error. The system logger address space is not available because it is IPLing.</p> <p>Action: Listen for ENF signal 48, which will indicate when the system logger address space is available. Re-connect to the log stream, then re-issue this request. You can also listen for ENF signal 48, which will indicate if the system logger address space will not be available for the life of the IPL. In that case, do not issue system logger services.</p>
08	xxxx08D0	<p>Equate Symbol: IxgRsnCodeProblemState</p> <p>Explanation: Environment error. The request was rejected because of one of the following:</p> <ul style="list-style-type: none"> • The request was issued in SRB mode while the requestor was in problem program state. • The SYNCEXIT parameter was specified while the requestor's PSW key was in problem program key. <p>Action: Change the invoking environment to supervisor state.</p>

Table 35. Return and Reason Codes for the IXGBRWSE Macro (continued)		
Return Code	Reason Code	Meaning and Action
08	xxxx08D1	<p>Equate Symbol: IxgRsnCodeProgramKey</p> <p>Explanation: Environment error. The request was rejected because of one of the following:</p> <ul style="list-style-type: none"> The request was issued in SRB mode while the requestor was in problem program key (key 8-F). The SYNCEXIT parameter was specified while the requestor's PSW key was in problem program key. <p>Action: Change the invoking environment to a system key (key 0-7).</p>
08	xxxx08D2	<p>Equate Symbol: IxgRsnCodeNoCompleteExit</p> <p>Explanation: Program error. MODE=SYNCEXIT was specified, but the connection request did not identify a complete exit.</p> <p>Action: Either change this request to a different MODE option, or reconnect to the log stream with a complete exit on the COMPLETEXIT parameter.</p>
08	xxxx08D3	<p>Equate Symbol: IxgRsnCodeFuncNotSupported</p> <p>Explanation: Environment error. The options specified on the IXGBRWSE request are not supported on this system/ maintenance level of system logger.</p> <p>Action: Either install the level of system logger that provides the support for the requested function, or do not specify options that are not supported at this level.</p>
0C	xxxx0000	<p>Equate Symbol: IxgRetCodeCompError</p> <p>Explanation: User or System error. One of the following occurred:</p> <ul style="list-style-type: none"> You issued the FORCE IXGLOGR,ARM command to terminate the system logger address space. System logger component error occurred. <p>Action: If this reason code is not the result of forcing the system logger address space, search problem reporting data bases for a fix for the problem. If no fix exists, contact the IBM Support Center. Provide the diagnostic data in the answer area (IXGANSAA) and any dumps or LOGREC entries from system logger.</p>

Examples

Example 1

Issue IXGBRWSE REQUEST=START to start a browse session, starting the browse cursor at the log block with the specified local time.

```
IXGBRWSE REQUEST=START,           X
      STREAMTOKEN=TOKEN,          X
      SEARCH=SRCHTIME,           X
      GMT=NO,                     X
```

```

        BROWSETOKEN=BRSTOKEN,           X
        MODE=SYNC,                     X
        ANSAREA=ANSAREA,               X
        ANSLLEN=ANSLLEN,               X
        RSNCODE=RSNCODE,               X
        MF=S,                           X
        RETCODE=RETCODE
ANSLEN  DC  A(L'ANSAREA)                length of logger's answer area
TOKEN   DS  CL16                        stream token from connect
SRCHTIME DS  2F                          local search time in stck format
BRSTOKEN DS  CL4                          returned browse token
ANSAREA DS  CL(ANSAA_LEN)                answer area for log requests
RETCODE DS  F                             return code
RSNCODE DS  F                             reason code
DATAREA DSECT
        IXGANSAA LIST=YES                answer area

```

Example 2

Issue IXGBRWSE REQUEST=READCURSOR to read the next consecutive log block in the specified direction. In this example, the default of MULTIBLOCK=NO has been taken.

```

        IXGBRWSE REQUEST=READCURSOR,    X
        STREAMTOKEN=TOKEN,             X
        BUFFER=BUFF,                  X
        BUFFLEN=BUFFLEN,              X
        BUFFALET=ALET,                 X
        BLKSIZE=BLKSIZE,               X
        DIRECTION=OLDTOYOUNG,          X
        RETBLOCKID=RETBK,              X
        TIMESTAMP=TIMESTMP,            X
        BROWSETOKEN=BRSTOKEN,          X
        MODE=SYNC,                     X
        ANSAREA=ANSAREA,               X
        ANSLLEN=ANSLLEN,               X
        RSNCODE=RSNCODE,               X
        MF=S,                           X
        RETCODE=RETCODE
ANSLEN  DC  A(L'ANSAREA)                length of logger's answer area
BUFFLEN DC  F'200'                      buffer length
TOKEN   DS  CL16                        stream token from connect
BRSTOKEN DS  CL4                          returned browse token
BUFF    DS  CL200                        buffer where data will be put
ALET    DC  F'1'                          buffer alet in secondary
BLKSIZE DS  F                             block size of buffer
RETBK   DS  CL8                          return block id
TIMESTMP DS  CL16                        returned time stamp stck format
ANSAREA DS  CL(ANSAA_LEN)                answer area for log requests
RETCODE DS  F                             return code
RSNCODE DS  F                             reason code
DATAREA DSECT
        IXGANSAA LIST=YES                answer area

```

Example 3

Issue IXGBRWSE REQUEST=READBLOCK to read a log block selected by block identifier.

```

        IXGBRWSE REQUEST=READBLOCK,    X
        STREAMTOKEN=TOKEN,             X
        BLOCKID=BLKID,                 X
        BUFFER=BUFF,                  X
        BUFFLEN=BUFFLEN,              X
        BUFFALET=ALET,                 X
        BLKSIZE=BLKSIZE,               X
        RETBLOCKID=RETBK,              X
        TIMESTAMP=TIMESTMP,            X
        BROWSETOKEN=BRSTOKEN,          X
        MODE=SYNC,                     X
        ANSAREA=ANSAREA,               X
        ANSLLEN=ANSLLEN,               X
        RSNCODE=RSNCODE,               X
        MF=S,                           X
        RETCODE=RETCODE
ANSLEN  DC  A(L'ANSAREA)                length of logger's answer area
BUFFLEN DC  F'200'                      buffer length

```

IXGBRWSE macro

TOKEN	DS	CL16	stream token from connect
BRSTOKEN	DS	CL4	returned browse token
BUFF	DS	CL200	buffer where data will be put
ALET	DS	F'1'	buffer alet in secondary
BLKSIZE	DS	F	block size of buffer
RETBK	DS	CL8	return block id
BLKID	DS	CL8	specific block id to browse
TIMESTMP	DS	CL16	returned time stamp stck format
ANSAREA	DS	CL(ANSAA_LEN)	answer area for log requests
RETCODE	DS	F	return code
RSNCODE	DS	F	reason code
DATAREA	DSECT		
		IXGANSAA LIST=YES	answer area

Example 4

Issue IXGBRWSE REQUEST=RESET to reset the cursor at the youngest block in the log stream.

		IXGBRWSE REQUEST=RESET,	X
		STREAMTOKEN=TOKEN,	X
		POSITION=YOUNGEST,	X
		BROWSETOKEN=BRSTOKEN,	X
		MODE=SYNC,	X
		ANSAREA=ANSAREA,	X
		ANSLEN=ANSLEN,	X
		RSNCODE=RSNCODE,	X
		MF=S,	X
		RETCODE=RETCODE	
ANSLEN	DC	A(L'ANSAREA)	length of logger's answer area
TOKEN	DS	CL16	stream token from connect
BRSTOKEN	DS	CL4	returned browse token
ANSAREA	DS	CL(ANSAA_LEN)	answer area for log requests
RETCODE	DS	F	return code
RSNCODE	DS	F	reason code
DATAREA	DSECT		
		IXGANSAA LIST=YES	answer area

Example 5

Issue IXGBRWSE REQUEST=END to end a browse session.

		IXGBRWSE REQUEST=END,	X
		STREAMTOKEN=TOKEN,	X
		BROWSETOKEN=BRSTOKEN,	X
		MODE=SYNC,	X
		ANSAREA=ANSAREA,	X
		ANSLEN=ANSLEN,	X
		RSNCODE=RSNCODE,	X
		MF=S,	X
		RETCODE=RETCODE	
ANSLEN	DC	A(L'ANSAREA)	length of logger's answer area
TOKEN	DS	CL16	stream token from connect
BRSTOKEN	DS	CL4	browse token from browse start
ANSAREA	DS	CL(ANSAA_LEN)	answer area for log requests
RETCODE	DS	F	return code
RSNCODE	DS	F	reason code
DATAREA	DSECT		
		IXGANSAA LIST=YES	answer area

Example 6

Issue IXGBRWSE REQUEST=END to end a browse session asynchronously, if synchronous processing is not possible.

		IXGBRWSE REQUEST=END,	X
		STREAMTOKEN=TOKEN,	X
		BROWSETOKEN=BRSTOKEN,	X
		MODE=SYNCECB,	X
		ECB=ANECEB,	X
		ANSAREA=ANSAREA,	X
		ANSLEN=ANSLEN,	X
		RSNCODE=RSNCODE,	X
		MF=S,	X

```

                RETCODE=RETCODE
*****
*           if rsncode = '00000401'X then wait on
*           the ecb ANECB.
*****
ANSLEN  DC      A(L'ANSAREA)          length of logger's answer area
TOKEN   DS      CL16                  stream token from connect
BRSTOKEN DS    CL4                    browse token from browse start
ANSAREA DS      CL(ANSAA_LEN)         answer area for log requests
ANECB   DS      F                    ecb on which to wait
RETCODE DS      F                    return code
RSNCODE DS      F                    reason code
DATAREA DSECT
IXGANSAA LIST=YES                    answer area

```

Example 7

Issue IXGBRWSE REQUEST=END using registers.

```

                LA    R6,TOKEN          place stream token in reg 6
IXGBRWSE REQUEST=END,                X
                STREAMTOKEN=(6),      X
                BROWSETOKEN=BRSTOKEN, X
                MODE=SYNC,             X
                ANSAREA=ANSAREA,       X
                ANSLEN=ANSLEN,         X
                RSNCODE=RSNCODE,       X
                MF=S,                  X
                RETCODE=RETCODE
ANSLEN  DC      A(L'ANSAREA)          length of logger's answer area
TOKEN   DS      CL16                  stream token from connect
BRSTOKEN DS    CL4                    browse token from browse start
ANSAREA DS      CL(ANSAA_LEN)         answer area for log requests
RETCODE DS      F                    return code
RSNCODE DS      F                    reason code
DATAREA DSECT
IXGANSAA LIST=YES                    answer area
R6      EQU    6

```

Chapter 68. IXGCONN – Connect/disconnect to log stream

Description

Use the IXGCONN macro to connect a program to a specific log stream or disconnect a program from a specific log stream.

IXGCONN returns a unique connection identifier called a stream token on completion of the IXGCONN REQUEST=CONNECT request. Subsequent logger services use the stream token to identify the connection. If multiple applications connect to the same log stream, the log blocks written from the different applications are merged.

The IXGCONN connect service can be used in the following ways:

- Once a program has connected to a log stream, any application running in the same address space shares the connect status and may share the same stream token to issue other logger services. Any program in the address space can disconnect the entire address space from the log stream by issuing the IXGCONN REQUEST=DISCONNECT service.
- Multiple programs in a single address space can issue IXGCONN REQUEST=CONNECT individually to connect to the same log stream and receive separate stream tokens. Each program must disconnect from the log stream individually.
- Multiple address spaces on one or more MVS systems may connect to a single log stream, but each one must issue IXGCONN individually to connect and then disconnect from the log stream. Each one receives a unique stream token; address spaces cannot share a stream token.

Note that a DASD-only log stream is single-system in scope. This means that only one system may connect to a DASD-only log stream, although there can be multiple connections from that one system.

For information about using the system logger services and the IXGCONN request, see *z/OS MVS Programming: Assembler Services Guide* which includes information about related macros IXGBRWSE, IXGDELETE, IXGWRITE, IXGINVNT, and IXGQUERY.

Environment

The requirements for the caller are:

Environmental factor	Requirement
Minimum authorization:	Problem state with any PSW key.
Dispatchable unit mode:	Task
Cross memory mode:	PASN=HASN, any SASN
AMODE:	31-bit or 64-bit
ASC mode:	Primary or access register (AR)
Interrupt status:	Enabled for I/O and external interrupts.
Locks:	No locks may be held.
Control parameters:	None.

Programming requirements

- The parameter list for this service must be addressable in the caller's primary address space.

- Include the IXGCON mapping macro in your program. This macro provides a list of equate symbols for the system logger services.
- Include mapping macro IXGANSAA in your program. This macro shows the format of the answer area output returned for each system logger service in the ANSAREA parameter.
- If you use IXGCONN REQUEST=CONNECT,...,MF=(E,parmlist,NOCHECK) with either the STREAMTOKEN=xxxx or the USERDATA=yyyy keyword, the following procedure must be followed. When the processing is complete, move the STREAMTOKEN or USERDATA values from the parameter list specified on MF= to your own storage.
- Each task that issues IXGCONN REQUEST=CONNECT to connect to a log stream must later issue IXGCONN REQUEST=DISCONNECT to disconnect from the log stream. When a task disconnects from the log stream, the log stream token that identified the connection expires. Any requests that use the log stream token after the disconnect are rejected with reason code X'82D'.
- If a task that issued the IXGCONN REQUEST=CONNECT request ends before issuing a disconnect request, system logger automatically disconnects the task from the log stream. This means that the unique log stream connection identifier, or the STREAMTOKEN, is no longer valid. The application receives an expired log stream token error response with reason code X'82D', if this application continues to use the same STREAMTOKEN after the task has been disconnected on subsequent logger service requests.
- Any job step task (JST) terminates within the address space that has a connection to the log stream. System logger treats any job step task termination in a manner similar to an address space termination. That is, all log stream connections are disconnected and logger associations are terminated with the address space.

If this condition occurs and there remains an expected use of a log stream, then a new log stream connection will be required.

Restrictions

- All storage areas specified in this service must be in the same storage key as the caller's storage key and must exist in the caller's primary address space.
- The caller cannot have an EUT FRR established.
- If the System Authorization Facility (SAF) is available, the system performs SAF authorization checks on all IXGCONN REQUEST=CONNECT requests in order to protect the integrity of data in a log stream.

To connect successfully to a log stream, the caller must have SAF authorization that matches the authorization required for the log stream:

- To connect to a log stream with an authorization level of READ, the caller must have read (or higher level) access to RESOURCE(*log_stream_name*) in SAF class CLASS(LOGSTRM).
- To connect to a log stream with an authorization level of WRITE, profiles covering two separate resources are used to determine if access is allowed and whether full access to log stream services can be used or just limited log stream access (only IXGWRITE and disconnect requests) can be used for the connection. Refer to each log stream exploiter's planning and/or guidance documentation on their log stream access requirements. Grant permission to SAF profile covering the (WRITE_ONLY_*log-stream-name*) resource only when deemed appropriate for the log exploiter.
 - For full service WRITE log stream access, the caller must have update (or higher level) access to RESOURCE(*log_stream_name*) in SAF class CLASS(LOGSTRM). When this level of access is granted, all log stream access services can be used with the log stream token established on this log stream connection.
 - For limited service WRITE log stream access, the caller must have (at least) update access to RESOURCE(WRITE_ONLY_*log-stream-name*) in SAF CLASS(LOGSTRM). When this level of access is granted, only IXGWRITE and IXGCONN (to disconnect) requests can be used with the log stream token established on this log stream connection.

- When there are no profiles defined covering resources (*log-stream-name*) or (*WRITE_ONLY_log-stream-name*) in SAF CLASS(LOGSTRM), then the AUTH=WRITE connection is permitted as full service access to the log stream.
- When just the profile covering resource (*log-stream-name*) is defined, meaning no profile covering (*WRITE_ONLY_log-stream-name*), then the connection is permitted according to the (*log-stream-name*) profile access. Access to the log stream will either be full service access or connection is not allowed (denied).
- When just the profile covering resource (*WRITE_ONLY_log-stream-name*) is defined, meaning no profile covering (*log-stream-name*), then the connection is permitted based on the (*WRITE_ONLY_log-stream-name*) profile access. Access to the log stream will either be limited service log stream access (can only write log data and disconnect) or the connection is not allowed (denied).
- When profiles covering both resources (*WRITE_ONLY_log-stream-name*) and (*log-stream-name*) are defined, then connection is permitted based on the following combinations:
 - when access is permitted via both profiles, then access to the log stream will be full service access.
 - when access is permitted via (*log-stream-name*) profile, but is denied via (*WRITE_ONLY_log-stream-name*) profile, then access to the log stream will be full service access.
 - when access is permitted via (*WRITE_ONLY_log-stream-name*) profile, but is denied via (*log-stream-name*) profile, then access to the log stream will be limited service (can only write log data and disconnect).
 - when access is not permitted (denied) via both profiles, then the connection to the log stream will not be allowed (denied).

When permission is not allowed for the profiles covering the resources noted above, system logger will provide an error return, with return code 8, reason code X'080D' (IxgRsnCodeNoSAFAuth) on the log stream connection attempt.

If SAF is not available or if CLASS(LOGSTRM) is not defined to SAF, no security checking is performed. In that case, the caller is connected to the log stream with the requested or default AUTH parameter value.

- There is more than one version of this macro available. The parameters you can use depend on the version you specify on the PLISTVER parameter. See the description of the PLISTVER parameter for more information.

Input register information

Before issuing the IXGCONN macro, the caller does not have to place any information into any register unless using it in register notation for a particular parameter, or using it as a base register.

Output register information

When control returns to the caller, the GPRs contain:

Register

Contents

0

Reason code, if register 15 contains a non-zero return code

2-13

Unchanged

14

Used as a work register by the system

15

Return code

When control returns to the caller, the ARs contain:

Register Contents

0-1

Used as a work register by the system

2-13

Unchanged

14-15

Used as a work register by the system

Some callers depend on register contents remaining the same before and after issuing a service. If the system changes the contents of registers on which the caller depends, the caller must save them before issuing the service, and restore them after the system returns control.

Performance implications

Some messages and WTORs can be issued to delay or fail the IXGCONN Request. These messages and WTORs are issued when Logger is waiting for other system services. The following messages may need to be replied to, or other action taken:

- IXG054A - *cdstype* CDS not yet made available for Logger's use.
- IXG254I - SMS is not yet active
- IXG115A - Log stream recovery not making progress trying to move recovered log data to secondary (offload) data sets.

See the topic on IXG Messages in [z/OS MVS System Messages, Vol 10 \(IXC-IZP\)](#) for more information about IXG messages.

Syntax

The standard form of the IXGCONN macro is written as follows:

Syntax	Description
<i>name</i>	<i>name</i> : symbol. Begin <i>name</i> in column 1.
␣	One or more blanks must precede IXGCONN.
IXGCONN	
␣	One or more blanks must follow IXGCONN.
	Valid parameters (Required parameters are underlined.)
REQUEST=CONNECT	All parameters are valid.
REQUEST=DISCONNECT	<u>STREAMTOKEN</u> , <u>ANSAREA</u> , <u>ANSLEN</u> , <u>USERDATA</u> , <u>RETCODE</u> , <u>RSNCODE</u> , MF
,STREAMNAME= <i>streamname</i>	<i>streamname</i> : RS-type address or register (2) - (12).

Syntax	Description
,STREAMTOKEN= <i>streamtoken</i>	<i>streamtoken</i> : RS-type address or register (2) - (12).
,ANSAREA= <i>ansarea</i>	<i>ansarea</i> : RS-type address or register (2) - (12).
,ANSLEN= <i>anslen</i>	<i>anslen</i> : RS-type address or register (2) - (12).
,AUTH=READ	Default: AUTH=READ
,AUTH=WRITE	
,STRUCTNAME= <i>structname</i>	<i>structname</i> : RS-type address or register (2) - (12).
,AVGBUFSIZE= <i>avgbuFSIZE</i>	<i>avgbuFSIZE</i> : RS-type address or register (2) - (12).
,MAXBUFSIZE= <i>maxbuFSIZE</i>	<i>maxbuFSIZE</i> : RS-type address or register (2) - (12).
,ELEMENTSIZE= <i>elementsizE</i>	<i>elementsizE</i> : RS-type address or register (2) - (12).
,LSVERSION= <i>lsversion</i>	<i>lsversion</i> : RS-type address or register (2) - (12).
,USERDATA= <i>userdata</i>	<i>userdata</i> : RS-type address or register (2) - (12).
,IMPORTCONNECT=NO	Default: IMPORTCONNECT=NO
,IMPORTCONNECT=YES	
,DIAG=NO_DIAG	Default: DIAG=NO_DIAG
,DIAG=NO	
,DIAG=YES	
,PLISTVER=IMPLIED_VERSION	
,PLISTVER=MAX	Default: IMPLIED_VERSION

Syntax	Description
,PLISTVER=1	
,PLISTVER=2	
,RETCODE= <i>retcode</i>	<i>retcode</i> : RS-type address or register (2) - (12).
,RSNCODE= <i>rsncode</i>	<i>rsncode</i> : RS-type address or register (2) - (12).
,MF=S	Default: MF=S
,MF=(L, <i>list addr</i>)	
,MF=(L, <i>list addr,attr</i>)	
,MF=(L, <i>list addr,OD</i>)	
,MF=(E, <i>list addr</i>)	
,MF=(E, <i>list addr,COMPLETE</i>)	
,MF=(E, <i>list addr,NOCHECK</i>)	
,MF=(M, <i>list addr</i>)	
,MF=(M, <i>list addr,COMPLETE</i>)	
,MF=(M, <i>list addr,NOCHECK</i>)	

Parameters

The parameters are explained as follows:

REQUEST=CONNECT

REQUEST=DISCONNECT

Input parameter specifying whether the program is connecting to or disconnecting from the specified log stream.

When you specify CONNECT, all parameters are valid. Keywords required with connect are: STREAMNAME, STREAMTOKEN, ANSAREA, and ANSLEN.

When you specify DISCONNECT, the following parameters are valid (required parameters are underlined): STREAMTOKEN, ANSAREA, ANSLEN, USERDATA, RETCODE, RSNCODE, and MF.

,STREAMNAME=*streamname*

Specifies the 26-byte field (or register) containing the name of the log stream to which a program is connecting. You must use the name you defined for the log stream in the LOGR, LOGRY or LOGRZ couple data set policy that is active on the system where the log stream is being connected. See the IXGINVNT macro for information on the syntax of log stream names in the active system logger policy.

,STREAMTOKEN=*streamtoken*

Specifies the 16-byte token uniquely identifying the program's connection to the log stream.

When specified with REQUEST=CONNECT, STREAMTOKEN is an output parameter where IXGCONN places the log stream token when the macro completes successfully.

When specified with REQUEST=DISCONNECT or other logger services, STREAMTOKEN is an input parameter where you specify the log stream token returned at connection.

,ANSAREA=ansarea

Specifies the name (or address in a register) of an answer area containing information about this request. The answer area must be at least 40 bytes. To map this information, use the IXGANSAA macro.

,ANSLEN=anslen

Specifies the name (or address in a register) of the 4-byte field containing the answer area length. The length of the answer area must be at least 40 bytes and must be the same length as the field specified in ANSAREA.

To ascertain the optimal answer area length, look at the ANSAA_PREFERRED_SIZE field of the IXGANSAA macro.

,AUTH=READ**,AUTH=WRITE**

Specifies whether the caller has write or read access to the specified log stream.

If you specify AUTH=READ when connecting to a log stream, the program must also have read access authority to SAF resource(*logstream_name*) in CLASS(LOGSTRM) for the specified log stream. You can then issue only the IXGBRWSE and IXGQUERY requests against the log stream.

If you specify AUTH=WRITE when connecting to a log stream, the program must also have write access authority to SAF resource(*logstream_name*) in CLASS(LOGSTRM) for the specified log stream. You can then issue any system logger request against the log stream.

AUTH=WRITE specifies that, based on the defined security profiles and allowed access, either all log stream access services (such as IXGBRWSE, IXGDELETE, IXGWRITE and others) or just limited log stream access requests (just writing log data and disconnecting from the log stream) can be issued for the log stream.

When the request results in a log stream connection (rc=0 or rc=4 conditions), then the output answer area flag field *Ansaas_WriteConnectLimitedAccess* (see mapping macro *IxgAnsaas*) indicates whether full log stream access services are allowed or whether only limited log stream service access is allowed.

When the indicator *Ansaas_WriteConnectLimitedAccess* is set off '0' b then full log stream access services area is allowed. This means that all the log stream access services using the log stream connection token returned in the STREAMTOKEN parameter and that are given the context of the other connection parameters, can be issued.

When the indicator *Ansaas_WriteConnectLimitedAccess* is set on '1' b along with indicator *Ansaas_WriteOnlyAccess* being set on '1' b, then the log stream access services area limited to writing log data and disconnecting from the log stream (IXGWRITE and IXGCONN requests). No other log stream access services are allowed for this limited access connection type

,STRUCTNAME=structname

Specifies the name or address (using a register) of a 16-byte output field where IXGCONN REQUEST=CONNECT will return the name of the coupling facility structure that the log stream is connected to. The name comes from the LOGR policy.

If you are connecting to a DASD-only log stream, this field will contain binary zeros. In addition, flag *Ansaas_DasdOnlyLogStream* in macro IXGANSAA will be set on for a DASD-only log stream.

,MAXBUFSIZE=maxbufsize

Specifies the name or address (using a register) of a 4-byte output field where IXGCONN returns the size, in bytes, of the largest log block that can be written to this log stream.

MAXBUFSIZE is defined in the active system logger couple data set policy.

,AVGBUFSIZE=avgbufsize

Specifies the name or address (using a register) of a 4-byte output field where IXGCONN returns the average size, in bytes, of individual log blocks that can be written to the coupling facility structure associated with this log stream.

AVGBUFSIZE is defined in the active system logger couple data set policy.

- If you are using an active system logger couple data set for a coupling facility log stream, this value shows the initial setting used to determine the element-to-entry ratio. System logger monitors structure usage and adjusts the average buffer size dynamically, but the AVGBUFSIZE value returned by IXGCONN will always reflect the original setting rather than the actual value in use by system logger at any given time.
- If you are connecting to a DASD-only log stream, this field will contain binary zeros. In addition, flag `Ansaa_DasdOnlyLogStream` in macro `IXGANSAA` will be set on for a DASD-only log stream.

,ELEMENTSIZE=*elementsiz*

Specifies the name or address (using a register) of a 4-byte output field where IXGCONN returns the size of the elements that system logger will break the log blocks into to write them to the coupling facility associated with this log stream.

If you are connecting to a DASD-only log stream, this field will contain binary zeros. In addition, flag `Ansaa_DasdOnlyLogStream` in macro `IXGANSAA` will be set on for a DASD-only log stream.

,LSVERSION=*lsversion*

Specifies the name or address (using a register) of a 64-bit output field where IXGCONN returns the version of the log stream the program is connecting to.

The log stream version is a UTC timestamp that uniquely identifies the instance of the log stream definition. A program can use the log stream version to see if a log stream definition has been deleted and redefined since the last connect to a log stream.

For example, assume you connect to log stream `LS1` and IXGCONN returns a log stream version of `X'AA00000000000000'`, which the program saves. On a subsequent connection to log stream `LS1`, IXGCONN returns a different log stream version, which indicates that the definition for log stream `LS1` in the active system logger couple data set policy has been deleted and redefined since the last connection.

,USERDATA=*userdata*

Specifies a 64-byte input/output field containing a user data area.

When specified with `REQUEST=CONNECT`, `USERDATA` is an output parameter where IXGCONN returns the user data specified for this log stream.

When specified with `REQUEST=DISCONNECT`, `USERDATA` is an input parameter where you can specify or update the user data for the specified log stream. You can only specify or change the user data for a log stream on a disconnect request.

,IMPORTCONNECT=NO

,IMPORTCONNECT=YES

Specifies whether the connection is for writing or importing log data to a log stream. You must specify `AUTH=WRITE` to use the `IMPORTCONNECT` parameter.

If you specify `IMPORTCONNECT=YES`, this connection will be used for importing data to a log stream. Importing log data means using the `IXGIMPRT` service to copy data from one log stream to another, maintaining the same log block identifier and UTC time stamp. `IXGWRITE` requests are not valid with `IMPORTCONNECT=YES`. You can have only one `IMPORTCONNECT=YES` connection active for a log stream in the sysplex.

If you specify `IMPORTCONNECT=NO`, which is the default, the connect request is a write connection. In a write connection, only `IXGWRITE` requests can be issued against the log stream, `IXGIMPRT` requests will be rejected.

You can have multiple write connects to a log stream, provided there are no import connections. If you have a write connect established against a log stream, a subsequent import connection will be rejected. You cannot, in other words, issue both `IXGIMPRT` and `IXGWRITE` requests against a single log stream.

This option is not allowed when the `AUTH=WRITE` connection would have otherwise been established as a limited log stream access, given the SAF profiles defined for the log stream access. The request will fail with a return code 8, reason code `X'08D6'` (`IxgRsnCodeConnTypeNotAllowed`). The answer

area indicators Ansa_WriteConnectLimitedAccess and Ansa_WriteOnlyAccess will be set on ('1'b) for this error condition.

,DIAG=NO_DIAG

,DIAG=NO

,DIAG=YES

Specifies whether Logger should provide additional diagnostics as specified on the logstream definition DIAG parameter. This indication is used over the span of this connectoin. Refer to the DIAG keyword on the IXGINVNT, IXGBRWSE, and IXGDELET macro services.

If you specify DIAG=NO_DIAG, which is the default, then Logger will not provide the additional diagnostics as specified on the logstream definition DIAG parameter, unless another Logger service, for example, IXGBRWSE, specifically requests the additional diagnostics.

If you specify DIAG=NO, the Logger will not provide the additional diagnostics as specified on the logstream definition DIAG parameter, regardless of other Logger service specifications.

If you specify DIAG=YES, then Logger will provide additional diagnostics as specified on the logstream definition DIAG parameter, unless another Logger service, for example, IXGDELET, specifically requests not to provide the additional diagnostics.

,PLISTVER=IMPLIED_VERSION

,PLISTVER=MAX

,PLISTVER=1

,PLISTVER=2

An optional input parameter that specifies the version of the macro. PLISTVER determines which parameter list the system generates.

The values are:

- **IMPLIED_VERSION**, which is the lowest version that allows all parameters specified on the request to be processed. If you omit the PLISTVER parameter, IMPLIED_VERSION is the default. Note that on the list form, the default will cause the smallest parameter list to be created.
- **MAX**, if you want the parameter list to be the largest size currently possible. This size might grow from release to release and affect the amount of storage that your program needs.

If you can tolerate the size change, IBM recommends that you always specify PLISTVER=MAX on the list form of the macro. Specifying MAX ensures that the list-form parameter list is always long enough to hold all the parameters you might specify on the execute form when both forms are assembled using the same level of the system. In this way, MAX ensures that the parameter list does not overwrite nearby storage.

- **1**, which supports all parameters except those specifically referenced in higher versions.
- **2**, which supports both the following parameters and parameters from version 1:
 - IMPORTCONNECT
 - LSVERSION

To code: specify in this input parameter one of the following:

- IMPLIED_VERSION
- MAX
- A decimal value of 1 or 2

,RETCODE=retcode

Specifies a name or address (using a register) of a 4-byte output field where the system will place the return code. The return code is also in general purpose register (GPR) 15.

,RSNCODE=rsncode

Specifies a name (or address in a register) of a 4-byte output field where the system will place the reason code. The reason code is also in general purpose register (GPR) 0, if you received a non-zero return code.

,MF=S
,MF=(L,list addr)
,MF=(L,list addr,attr)
,MF=(L,list addr,OD)
,MF=(E,list addr)
,MF=(E,list addr,COMPLETE)
,MF=(E,list addr,NOCHECK)
,MF=(M,list addr)
,MF=(M,list addr,COMPLETE)
,MF=(M,list addr,NOCHECK)

Use MF=S to specify the standard form of the macro, which builds an inline parameter list and generates the macro invocation to transfer control to the service. MF=S is the default.

Use MF=L to specify the list form of the macro. Use the list form together with the execute form of the macro for applications that require reentrant code. The list form defines an area of storage that the execute form uses to store the parameters. Only the PLISTVER parameter can be specified on the list form of the macro. IBM recommends that you always specify PLISTVER=MAX on the list form of the macro.

Use MF=E to specify the execute form of the macro. Use the execute form together with the list form of the macro for applications that require reentrant code. The execute form of the macro stores the parameters into the storage area defined by the list form, and generates the macro invocation to transfer control to the service.

Use MF=M together with the list and execute forms of the macro for service routines that need to provide different options according to user-provided input. Use the list form to define a storage area; use the modify form to set the appropriate options; then use the execute form to call the service.

IBM recommends that you use the modify and execute forms in the following order:

- Use MF=(M,*list_addr*,COMPLETE), specifying appropriate parameters, including all required ones.
- Use MF=(M,*list_addr*,NOCHECK), specifying the parameters you want to change.
- Use MF=(E,*list_addr*,NOCHECK), to execute the macro.

,list addr

The name of a storage area to contain the parameters.

,attr

An optional 1- to 60-character input string, which can contain any value that is valid on an assembler DS pseudo-op. You can use this parameter to force boundary alignment of the parameter list. If you do not code *attr*, the system provides a value of OD, which forces the parameter list to a doubleword boundary.

,COMPLETE

Specifies that the system is to check for required parameters and supply defaults for omitted optional parameters.

,NOCHECK

Specifies that the system is not to check for required parameters and is not to supply defaults for omitted optional parameters.

ABEND codes

None.

Return and reason codes

When IXGCONN macro returns control to your program, GPR 15 contains a return code and GPR 0 contains a reason code.

The IXGCON mapping macro provides equate symbols for the return and reason codes. The equate symbols associated with each hexadecimal return code are as follows:

00

IXGRETCODEOK - Service completes successfully.

04

IXGRETCODEWARNING - Service completes with a warning.

08

IXGRETCODEERROR - Service does not complete.

0C

IXGRETCODECOMPERROR - Service does not complete.

The following table contains hexadecimal return and reason codes, the equate symbols associated with each reason code, and the meaning and suggested action for each return and reason code.

Return code	Reason code	Meaning and zction
00	xxxx0000	Equate symbol: IxgRsnCodeOk Explanation: Request processed successfully.
04	xxxx0404	Equate symbol: IxgRsnCodeDisconnectInProgress Explanation: Environment error. The disconnect request is being completed asynchronously. The application has been disconnected from the log stream and the stream token is no longer valid. Action: The log stream cannot be deleted until the asynchronous portion of the disconnect processing completes.
04	xxxx0406	Equate symbol: IxgRsnCodeConnectRebuild Explanation: Environment error. The connect request was successful, but the log stream is temporarily unavailable because a coupling facility structure rebuild is in progress. Action: Listen to the ENF signal 48, which will indicate either that the log stream is available because the rebuild completed successfully or that the log stream is not available because the rebuild failed. In the meantime, do not attempt to issue system logger services against the log stream.
04	xxxx0407	Equate symbol: IxgRsnCodeConnPossibleLossOfData Explanation: Environment error. The request was successful, but there may be log blocks permanently missing between this log block and the one previously returned. This condition occurs when a system or coupling facility fails and not all of the data in the log stream could be recovered. Action: If your application cannot tolerate any data loss, stop issuing system logger services to this log stream, disconnect from the log stream, and reconnect to a new, undamaged log stream. You can continue using the log stream if your applications can tolerate data loss.

<i>Table 36. Return and reason codes for the IXGCONN macro (continued)</i>		
Return code	Reason code	Meaning and zction
04	xxxx0408	<p>Equate symbol: IxgRsnCodeDsDirectoryFullWarning</p> <p>Explanation: Environment error. The request was successful, but the DASD data set directory for the log stream is now full. system logger cannot offload any further data to DASD. system logger will continue to process IXGWRITE requests only until the coupling facility structure space for this log stream is full.</p> <p>Action: Either delete data from the log stream to free up space in the data set directory or disconnect from the log stream.</p>
04	xxxx0409	<p>Equate symbol: IxgRsnCodeWowWarning</p> <p>Explanation: Environment error. The request was successful, but an error condition was detected during a previous offload of data. system logger might not be able to offload further data. system logger will continue to process IXGWRITE requests only until the interim storage for the log stream is filled. (Interim storage is the coupling facility for a coupling facility log stream and local storage buffers for a DASD-only log stream.)</p> <p>Action: Do not issue any further requests for this log stream and disconnect. Connect to another log stream. Check the system log for message IXG301I to determine the cause of the error. If you cannot fix the error, search problem reporting data bases for a fix for the problem. If no fix exists, contact the IBM Support Center.</p>
08	xxxx0801	<p>Equate symbol: IxgRsnCodeBadParmlist</p> <p>Explanation: Program error. The parameter list could not be accessed.</p> <p>Action: Ensure that the storage area for the parameter list is accessible to the system logger for the duration of the request. The parameter list storage must be addressable in the caller's primary address space and in the same key as the caller.</p>
08	xxxx0802	<p>Equate symbol: IxgRsnCodeXESError</p> <p>Explanation: System error. A severe cross-system extended services (XES) error has occurred.</p> <p>Action: See ANSAA_DIAG1 for the XES return code and ANSAA_DIAG2 for the XES reason code.</p>
08	xxxx0806	<p>Equate symbol: IxgRsnCodeBadStmToken</p> <p>Explanation: Program error. The stream token was not valid.</p> <p>Action: Make sure that the stream token specified is valid.</p>

Table 36. Return and reason codes for the IXGCONN macro (continued)

Return code	Reason code	Meaning and action
08	xxxx0808	<p>Equate symbol: IxgRsnCodeEIOError</p> <p>Explanation: System error. A severe log data set I/O error has occurred.</p> <p>Action: Contact the IBM Support Center. Provide the return and reason code.</p>
08	xxxx080A	<p>Equate symbol: IxgRsnCodeRequestLocked</p> <p>Explanation: Program error. The program issuing the request is holding a lock.</p> <p>Action: Ensure that the program issuing the request is not holding a lock.</p>
08	xxxx080B	<p>Equate symbol: IxgRsnCodeNoStream</p> <p>Explanation: Program error. The log stream name specified has not been defined in the active system logger couple data set policy.</p> <p>Action: Ensure that the required log stream name has been defined in the active system logger couple data set policy. If the definition appears to be correct, ensure that the application is passing the correct log stream name to the service.</p>
08	xxxx080C	<p>Equate symbol: IxgRsnCodeStagingAllocError</p> <p>Explanation: Environment error. The system encountered a severe dynamic allocation error with the staging data set. ANSAA_DIAG2 of the answer area contains either the dynamic allocation error code, SMS reason code, or media manager reason code. For more information about the error, check for either message IXG251I, which is issued for data set allocation errors, or check for messages issued by the access method.</p> <p>Action: If the problem persists, search problem reporting data bases for a fix for the problem. If no fix exists, contact the IBM Support Center.</p>

Table 36. Return and reason codes for the IXGCONN macro (continued)		
Return code	Reason code	Meaning and zction
08	xxxx080D	<p>Equate symbol: IxgRsnCodeNoSAFAuth</p> <p>Explanation: Environment error. The user does not have correct SAF authorization for the request. The caller is not authorized to connect to the log stream or the caller specified AUTH=WRITE when connecting to a log stream with only READ authority.</p> <p>Action: IXGCONN returns information about the error in the answer area that is mapped by IXGANSAA. Investigate the meaning of ANSAA_Diag1, ANSAA_Diag2 and ANSAA_Diag4.</p> <ul style="list-style-type: none"> • ANSAA_Diag1 contains the RACF or installation exit return code from the RACROUTE REQUEST=AUTH macro. • ANSAA_Diag2 contains the RACF or installation exit reason code from the RACROUTE REQUEST=AUTH macro. • ANSAA_Diag4 contains the SAF return code from the RACROUTE REQUEST=AUTH macro. <p>See z/OS Security Server RACROUTE Macro Reference for information about the RACROUTE macro.</p> <p>Define the required SAF authorization to allow the requestor to connect to the log stream. If authorization has already been defined, either change the authorization to allow UPDATE access to the log stream or change the application to AUTH=READ.</p>
08	xxxx0811	<p>Equate symbol: IxgRsnCodeBadStrname</p> <p>Explanation: Environment error. The structure name specified on the STRUCTNAME parameter is not defined in the CFRM policy.</p> <p>Action: Make sure that the structure you want to specify is defined in the CFRM policy.</p>
08	xxxx0812	<p>Equate symbol: IxgRsnCodeLogStreamRecoveryFailed</p> <p>Explanation: Environment error. The log stream could not be recovered so the connection attempt failed. The system issues message IXG210E and/or IXG211E along with message IXG231I providing further information about the error.</p> <p>Action: If the problem persists, search problem reporting data bases for a fix for the problem. If no fix exists, contact the IBM Support Center.</p>
08	xxxx0813	<p>Equate symbol: IxgRsnCodeLogStreamDeleted</p> <p>Explanation: Environment error. The request to connect to the specified log stream failed because the log stream is being deleted.</p> <p>Action: Redefine the log stream in the active system logger couple data set policy and then reissue the connect request.</p>

Table 36. Return and reason codes for the IXGCONN macro (continued)

Return code	Reason code	Meaning and zction
08	xxxx0814	<p>Equate symbol: IxgRsnCodeNotAvailForIPL</p> <p>Explanation: Environment error. The system logger address space is not available for the remainder of this IPL. The system issues messages about this error during system logger initialization.</p> <p>Action: See the explanation for system messages issued during system logger initialization.</p>
08	xxxx0815	<p>Equate symbol: IxgRsnCodeNotEnabled</p> <p>Explanation: Program error. The program issuing the request is not enabled for I/O and external interrupts, so the request fails.</p> <p>Action: Make sure the program issuing the request is enabled for I/O and external interrupts.</p>
08	xxxx0816	<p>Equate symbol: IxgRsnCodeBadAnslen</p> <p>Explanation: Program error. The answer area length (ANSLEN parameter) is not large enough. The system logger returned the required size in the Ansaas_Prefered_Size field of the answer area, mapped by IXGANSAA macro.</p> <p>Action: Reissue the request, specifying an answer area of the required size.</p>
08	xxxx0819	<p>Equate symbol: IxgRsnCodeSRBMode</p> <p>Explanation: Program error. The calling program is in SRB mode, but task mode is the required dispatchable unit mode for this system logger service.</p> <p>Action: Make sure the calling program is in task mode.</p>

<i>Table 36. Return and reason codes for the IXGCONN macro (continued)</i>		
Return code	Reason code	Meaning and zction
08	xxxx081A	<p>Equate symbol: IxgRsnCodeMaxStreamConn & IXGINVNT requests</p> <p>Explanation: Environment error. This system has reached the limit for the maximum number of log streams that can be concurrently active. One of the following is true:</p> <ul style="list-style-type: none"> • The limit of 16,384 concurrently active DASDONLY log streams per system has been reached. For this case, the Answer Area field DIAG1 will contain 16,384. • Either the PRODUCTION or TEST GROUP cannot connect to any more log streams. Message IXG075E or IXG076I is issued. In this case, the Answer Area field DIAG1 will contain the number of structures that are in use for this GROUP. • The TEST GROUP has previously failed and a request has been made to define a logstream with GROUP(TEST). Message IXG074I has been previously issued. In this case, the Answer Area field DIAG1 will contain 0. • A Log stream delete cannot be processed because logger needs to perform an internal connect to the Log stream to complete the delete but no more connections are allowed. <p>Action: Your workload need to be planned to either consolidate log streams or balance system activity such that fewer log streams are needed during this time frame.</p>
08	xxxx081B	<p>Equate symbol: IxgRsnCodePrimaryNotHome</p> <p>Explanation: Program error. The primary address space does not equal the home address space.</p> <p>Action: Make sure that the primary address space equals the home address space when issuing this system logger service.</p>
08	xxxx081D	<p>Equate symbol: IxgRsnCodeRMNameBadState</p> <p>Explanation: Program error. The calling program cannot issue IXGCONN with the RMNAME parameter unless it is in supervisor state and system key.</p> <p>Action: Make sure the calling program is in supervisor state.</p>
08	xxxx081E	<p>Equate symbol: IxgRsnCodeXESStrNotAuth</p> <p>Explanation: Environment Error. The system logger address space does not have access authority to the coupling facility structure associated with the log stream specified.</p> <p>Action: Make sure the system logger address space has SAF access to the structure.</p>

Table 36. Return and reason codes for the IXGCONN macro (continued)		
Return code	Reason code	Meaning and zction
08	xxxx081F	<p>Equate symbol: IxgRsnCodeXcdeError</p> <p>Explanation: System error. System logger encountered an internal problem while processing the active system logger couple data set.</p> <p>Action: Contact the IBM Support Center. Provide the return and reason code and the contents of the answer area (ANSAREA field).</p>
08	xxxx0820	<p>Equate symbol: IxgRsnCodeBadModelConn</p> <p>Explanation: Program error. The program issued an IXGCONN request to connect to a log stream that was defined as a model in the active system logger couple data set policy. You cannot connect to a model log stream.</p> <p>Action: Either change the definition of the specified structure so that it is not a model, or else request connection to a different log stream that is not a model.</p>
08	xxxx082D	<p>Equate symbol: IxgRsnCodeExpiredStmToken</p> <p>Explanation: Environment error. The stream token is no longer valid because the connector has been disconnected.</p> <p>Action: Connect to the log stream again before issuing any functional requests.</p>
08	xxxx082E	<p>Equate symbol: IxgRsnCodeNoLogrCDSAvail</p> <p>Explanation: Environment error. The request failed because no active primary system logger couple data set (CDS) of the expected type is available to this system. The operator was prompted to either make a couple data set available or to indicate that the current request should be rejected. The operator specified that the current request should be rejected.</p> <p>Action: System logger services are unavailable until an active system logger couple data set of the expected type (LOGR, LOGRY, LOGRZ) is made available to this system.</p> <p>For more information about using system logger couple data sets, see "Format the LOGR couple data set and make it available to the sysplex" and "Using LOGRZ or LOGRY couple data sets for a single-system scope within a sysplex" in <i>z/OS MVS Setting Up a Sysplex</i>.</p> <p>Once the system logger is available using the couple data set, take the necessary steps to cause the function that issued the logger service to reattempt the request.</p>
08	xxxx0831	<p>Equate symbol: IxgRsnCodeBadStreamName</p> <p>Explanation: Program error. The log stream name specified on the STREAMNAME parameter is not valid.</p> <p>Action: Issue the request again with a valid log stream name on the STREAMNAME parameter.</p>

<i>Table 36. Return and reason codes for the IXGCONN macro (continued)</i>		
Return code	Reason code	Meaning and zction
08	xxxx083A	<p>Equate symbol: IxgRsnCodeRMNameNotAllowed</p> <p>Explanation: Program error. The request specified the RMNAME parameter, but the log stream is not defined as having an associated resource manager.</p> <p>Action: Either remove the RMNAME keyword from the connection request or update the log stream definition in the system logger inventory.</p>
08	xxxx0843	<p>Equate symbol: IxgRsnCodeXcdsReformat</p> <p>Explanation: Program error. A couple data set record is not valid.</p> <p>Action: Format the system logger couple data set again.</p>
08	xxxx084C	<p>Equate symbol: IxgRsnCodeRMAAlreadyConnected</p> <p>Explanation: Program error. The resource manager is trying to connect to a log stream that it is already connected to. Only one connection specifying RMNAME can be active for a log stream.</p> <p>Action: Correct the program so that it does not try to reconnect to the log stream.</p>
08	xxxx084E	<p>Equate symbol: IXGRSNCODESTRSACETOOSMALL</p> <p>Explanation: Environment error. Structure resources are not available to satisfy the request. All structure resources are allocated as system logger control resources. This condition occurs when the structure resources are consumed by the logstreams connections.</p> <p>Action: Increase the size of the structure in the CFRM policy or use the SETXCF ALTER command to dynamically increase the size of the structure.</p>
08	xxxx084F	<p>Equate symbol: IxgRsnCodeInvalidRMNameSpecified</p> <p>Explanation: Program error. The Resource Manager name specified on the IXGCONN request does not match the RMNAME specified for the log stream in the system logger inventory.</p> <p>Action: Either change the IXGCONN request or update the log stream's definition in the system logger inventory.</p>
08	xxxx0850	<p>Equate symbol: IXGRSNCODEBADVECTORLEN</p> <p>Explanation: Environment error. The connect request was rejected. system logger was unable to locate a vector table in the hardware system area (HSA) that is large enough for the number of log streams associated with it.</p> <p>Action: Add storage to the vector storage table and/or retry the connect request later, when storage might be available.</p>

Table 36. Return and reason codes for the IXGCONN macro (continued)

Return code	Reason code	Meaning and zction
08	xxxx0851	<p>Equate symbol: IXGRSNCODEBADCFLEVEL</p> <p>Explanation: Environment error. The connect request was rejected. The operational level of the coupling facility is not sufficient to support logger functions.</p> <p>Action: Ensure that the coupling facility operational level for logger structures is at the required level. See <i>z/OS MVS Setting Up a Sysplex</i>.</p>
08	xxxx0853	<p>Equate symbol: IxgRsnCodeNoCF</p> <p>Explanation: Environment error. The connect request was rejected. system logger could not allocate coupling facility structure space because no suitable coupling facility was available.</p> <p>Action: Check accompanying message IXG206I for a list of the coupling facilities where space allocation was attempted and the reason why each attempt failed.</p>
08	xxxx0861	<p>Equate symbol: IxgRsnCodeRebuildInProgress</p> <p>Explanation: Environment error. No requests can be processed for this log stream because a coupling facility structure rebuild is in progress for the structure associated with this log stream.</p> <p>Action: Listen for ENF signal 48 that will indicate one of the following:</p> <ul style="list-style-type: none"> • The log stream is available because the rebuild completed successfully. Reissue the request. • The rebuild failed and the log stream is not available.
08	xxxx0862	<p>Equate symbol: IxgRsnCodeXESPurge</p> <p>Explanation: Environment error. An cross-system extended services (XES) request has been purged due to rebuild processing.</p> <p>Action: Listen for ENF signal 48 that will indicate one of the following:</p> <ul style="list-style-type: none"> • The log stream is available because the rebuild completed successfully. Reissue the request. • The rebuild failed and the log stream is not available.
08	xxxx0863	<p>Equate symbol: IXGRSNCODESTRUCTUREFAILED</p> <p>Explanation: Environment error. Either the coupling facility structure associated with the log stream has failed or the coupling facility itself has failed.</p> <p>Action: Listen for ENF signal 48 that will indicate one of the following:</p> <ul style="list-style-type: none"> • The log stream is available because the rebuild completed successfully. Reissue the request. • The rebuild failed and the log stream is not available.

<i>Table 36. Return and reason codes for the IXGCONN macro (continued)</i>		
Return code	Reason code	Meaning and zction
08	xxxx0864	<p>Equate symbol: IXGRSNCODENOCONECTIVITY</p> <p>Explanation: Environment error. No connectivity exists to the coupling facility associated with the log stream. The system logger will either attempt to rebuild the log stream in another coupling facility or the log stream will be disconnected.</p> <p>Action: Listen for ENF signal 48 that will indicate one of the following:</p> <ul style="list-style-type: none"> • The log stream is available because the rebuild completed successfully. Reissue the request. • The rebuild failed and the log stream is not available. • The log stream has been disconnected from this system. <p>If a rebuild initiated because of a loss of connectivity previously failed, an ENF corresponding to this reason code might not be issued. Further action by the installation might be necessary to cause the change of the log stream status again. Check the log for messages IXG101I, IXG107I and related rebuild messages for information on resolving any outstanding issues.</p>
08	xxxx0866	<p>Equate symbol: IXGRSNCODESTRUCTUREFULL</p> <p>Explanation: Environment error. The coupling facility structure space is full.</p> <p>Action: Listen to the ENF signal 48 which will indicate that space is available for the structure after data has been offloaded to DASD.</p>
08	xxxx0890	<p>Equate symbol: IXGRSNCODEADDRSPACENOTAVAIL</p> <p>Explanation: System error. The system logger address space failed and is not available.</p> <p>Action: Do not issue system logger requests.</p>
08	xxxx0891	<p>Equate symbol: IXGRSNCODEADDRSPACEINITIALIZING</p> <p>Explanation: System error. The system logger address space is not available because it is IPLing.</p> <p>Action: Listen for ENF signal 48, which will indicate when the system logger address space is available. Reissue this request. You can also listen for ENF signal 48, which will indicate if the system logger address space will not be available for the life of the IPL. In that case, do not issue system logger services.</p>

Table 36. Return and reason codes for the IXGCONN macro (continued)

Return code	Reason code	Meaning and zction
08	xxxx08B0	<p>Equate symbol: IXGRSNCODESTRUCTURENOTAVAIL</p> <p>Explanation: Environment error. The connect request failed. The structure associated with the log stream is temporarily unavailable because either a rebuild is in progress, a structure dump is in progress, or connections to the structure are being prevented.</p> <p>Action: Listen for ENF signal 48, which indicates that a coupling facility is available, and then retry the connect.</p>
08	xxxx08D3	<p>Equate symbol: IXGRsnCodeFuncNotSupported</p> <p>Explanation: Environment error. An IXGCONN request specified the RMNAME or ImportConnect keyword. However, the logger inventory CDS is downlevel.</p> <p>Action: Format the highest level system logger couple data set supported by the systems in the sysplex and make it the active primary system logger CDS.</p>
08	xxxx08D6	<p>Equate symbol: IXGRsnCodeConnTypeNotAllowed</p> <p>Explanation: Environment error. One of the following occurred:</p> <ul style="list-style-type: none"> • The connect request specified IMPORTCONNECT=YES, but there is already an active write connection (AUTH=WRITE IMPORTCONNECT=NO) in the sysplex. You cannot have an import connection and a write connection to the same log stream. • The connect request specified AUTH=WRITE IMPORTCONNECT=NO, but there is already an active import connection (IMPORTCONNECT=YES) for the log stream. You cannot have an import connection and a write connection to the same log stream. <p>You can only have one import connection to a log stream. You may have multiple write connections, as long as there is no import connection against a log stream.</p> <p>Action: Correct your program and retry the request.</p>
08	xxxx08E2	<p>Equate symbol: IxgRsncodeDasdOnlyConnected</p> <p>Explanation: Environment error. An attempt to connect to a DASD-only log stream, defined in the active primary sysplex-scope system logger CDS, was rejected on this system because the log stream is already connected on another system in the sysplex.</p> <p>Action: Determine which system you want to have a connection to the log stream. If you need this connection, disconnect the first system connection to the log stream and retry this connect request.</p>

Table 36. Return and reason codes for the IXGCONN macro (continued)

Return code	Reason code	Meaning and zction
08	000008E3	<p>Equate symbol: IxgRsnCodeLogstreamNotSupported</p> <p>Explanation: Environment error. An attempt to connect for the log stream is rejected on this system because the system release level does not support this type of log stream. For example, this system does not support DASD-only log streams, or a log stream attribute such as EHLQ or DUPLEXMODE(DRXRC) cannot be processed on this system release level.</p> <p>Action: If you must connect to a DASD-only log stream, make sure you do one of the following:</p> <ul style="list-style-type: none"> • Update the log stream definition in the LOGR policy to a coupling facility one by specifying a structure name on the definition. • To issue a request for a log stream that has the EHLQ attribute, you must be on a system that is at z/OS Version 1 Release 3 or higher. <p>If you must connect to a log stream with the EHLQ attribute specified, make sure you connect from a system that is at z/OS Version 1 Release3 or higher.</p> <p>If you must connect to a log stream with the DUPLEXMODE(DRXRC) attribute specified, make sure you connect from a system that is at z/OS Version 1 Release 7 or higher.</p>
0C	xxxx0000	<p>Equate symbol: IxgRetCodeCompError</p> <p>Explanation: User or System error. One of the following occurred:</p> <ul style="list-style-type: none"> • You issued the FORCE IXGLOGR,ARM command to terminate the system logger address space. • system logger component error occurred. <p>Action: If this reason code is not the result of forcing the system logger address space, search problem reporting data bases for a fix for the problem. If no fix exists, contact the IBM Support Center. Provide the diagnostic data in the answer area (IXGANSAA) and any dumps or LOGREC entries from system logger.</p>

Example 1

Issue IXGCONN REQUEST=CONNECT to connect to a log stream with write authority.

```

IXGCONN REQUEST=CONNECT,
          STREAMNAME=STRMNAME,
          STREAMTOKEN=TOKEN,
          AUTH=WRITE,
          ANSAREA=ANSAREA,
          ANSLEN=ANSLEN,
          RSNCODE=RSNCODE,
          MF=S,
          RETCODE=RETCODE
STRMNAME DC CL26'LOG.STREAM.NAME' stream name
ANSLEN   DC A(L'ANSAREA) length of logger's answer area
TOKEN    DS CL16 returned stream token

```

ANSAREA	DS	CL(ANSAA_LEN)	answer area for log requests
RETCODE	DS	F	return code from logger
RSNCODE	DS	F	reason code from logger
DATAAREA	DSECT		
	IXGANSAA	LIST=YES	answer area

Example 2

Issue IXGCONN REQUEST=CONNECT using registers.

LA	R6,STRMNAME	load stream name into reg 6	
IXGCONN	REQUEST=CONNECT,		X
	STREAMNAME=(6),		X
	STREAMTOKEN=TOKEN,		X
	AUTH=WRITE,		X
	ANSAREA=ANSAREA,		X
	ANSLEN=ANSLEN,		X
	RSNCODE=RSNCODE,		X
	MF=S,		X
	RETCODE=RETCODE		
STRMNAME	DC	CL26'LOG.STREAM.NAME'	stream name
ANSLEN	DC	A(L'ANSAREA)	length of logger's answer area
TOKEN	DS	CL16	returned stream token
ANSAREA	DS	CL(ANSAA_LEN)	answer area for log requests
RETCODE	DS	F	return code from logger
RSNCODE	DS	F	reason code from logger
DATAAREA	DSECT		
	IXGANSAA	LIST=YES	answer area
R6	EQU	6	set up register 6

Example 3

Issue IXGCONN REQUEST=CONNECT as an import connect. This means the connection may issue IXGIMPRT to import data to a log stream.

IXGCONN	REQUEST=CONNECT,		X
	STREAMNAME=ONAME,		X
	STREAMTOKEN=OTOKEN,		X
	AUTH=WRITE,		X
	IMPORTCONNECT=YES,		X
	ANSAREA=XANSAREA,		X
	ANSLEN=XANSLEN,		X
	RSNCODE=RSCODE		
*			
ONAME	DS	CL26	Output Stream name
STOKEN	DS	CL16	Input Stream token
XANSAREA	DS	CL(ANSAA_LEN)	Logger answer area
XANSLEN	DC	A(ANSAA_LEN)	Answer area length
RSCODE	DS	F	Reason code
	DSECT		
	IXGANSAA	,	The answer area macro

Example 4

Issue IXGCONN REQUEST=DISCONNECT to disconnect from a log stream and associate some user data with the log stream.

IXGCONN	REQUEST=DISCONNECT,		X
	STREAMTOKEN=TOKEN,		X
	USERDATA=USERDATA,		X
	ANSAREA=ANSAREA,		X
	ANSLEN=ANSLEN,		X
	RSNCODE=RSNCODE,		X
	MF=S,		X
	RETCODE=RETCODE		
USERDATA	DC	CL64'SOME USER DATA'	user data to log with DISCONNECT
ANSLEN	DC	A(L'ANSAREA)	length of logger's answer area
TOKEN	DS	CL16	token returned from CONNECT
ANSAREA	DS	CL(ANSAA_LEN)	answer area for log requests
RETCODE	DS	F	return code from logger
RSNCODE	DS	F	reason code from logger

IXGCONN macro

```
DATAREA DSECT  
IXGANSAA LIST=YES          answer area
```

Chapter 69. IXGDELETE – Deleting log data from a log stream

Description

Use the IXGDELETE macro to delete log blocks from a log stream.

For information about using the system logger services and the system logger inventory, see *z/OS MVS Programming: Assembler Services Guide*, which includes information about related macros IXGCONN, IXGBRWSE, IXGWRITE, IXGINVNT, and IXGQUERY.

Environment

The requirements for the caller are:

Environmental factor	Requirement
Minimum authorization:	Problem state with any PSW key. The caller must be supervisor state with any system (0-7) PSW key to either invoke the service in SRB mode or use the MODE=SYNCEXIT keyword.
Dispatchable unit mode:	Task
Cross memory mode:	PASN=HASN, any SASN
AMODE:	31-bit or 64-bit
ASC mode:	Primary or access register (AR)
Interrupt status:	Enabled for I/O and external interrupts.
Locks:	No locks held.
Control parameter:	All control parameters must be in the primary address space with the following exceptions: <ul style="list-style-type: none"> • The ECB should be addressable from the home address space. • All storage areas specified must be in the same storage key as the caller.

Programming requirements

- The current primary address space must be the same primary address space used at the time your program issued the IXGCONN request.
- The parameter list for this service must be addressable in the caller's primary address space.
- The calling program must be connected to the log stream with write authority through the IXGCONN service.
- Include the IXGCON mapping macro in your program. This macro provides a list of equate symbols for the system logger services.
- Include mapping macro IXGANSAA in your program. This macro shows the format of the answer area output returned for each system logger service in the ANSAREA parameter.
- If there are multiple connections to a log stream, each connected application must serialize delete requests so that a delete of log blocks does not occur, for example, in the middle of another application's browse session.
- When coding the MODE=SYNCECB and ECB parameters, you must ensure that:

IXGDELET macro

- The virtual storage area specified for the ECB resides on a full word boundary.
- You initialize the ECB field to zero.
- The ECB resides in either the common or home address space storage at the time the IXGDELET request is issued.
- The storage used for output parameters, such as ANSAREA and OBLOCKID, are accessible by both the IXGDELET invoker and the ECB waiter.

Restrictions

- All storage areas specified in this service must be in the same storage key as the caller's storage key and must exist in the caller's primary address space.
- There is more than one version of this macro available. The parameters you can use depend on the version you specify on the PLISTVER parameter. See the description of the PLISTVER parameter for more information.

Input register information

Before issuing the IXGDELET macro, the caller does not have to place any information into any register unless using it in register notation for a particular parameter, or using it as a base register.

Output register information

When control returns to the caller, the GPRs contain:

Register

Contents

0

Reason code, if register 15 contains a non-zero return code

1

Used as a work register by the system

2-13

Unchanged

14

Used as a work register by the system

15

Return code

When control returns to the caller, the ARs contain:

Register

Contents

0-1

Used as a work register by the system

2-13

Unchanged

14-15

Used as a work register by the system

Some callers depend on register contents remaining the same before and after issuing a service. If the system changes the contents of registers on which the caller depends, the caller must save them before issuing the service, and restore them after the system returns control.

Performance implications

None.

Syntax

The standard form of the IXGDELET macro is written as follows:

Syntax	Description
<i>name</i>	<i>name</i> : symbol. Begin <i>name</i> in column 1.
␣	One or more blanks must precede IXGDELET.
IXGDELET	
␣	One or more blanks must follow IXGDELET.
,STREAMTOKEN= <i>streamtoken</i>	<i>streamtoken</i> : RS-type address or register (2) - (12).
,BLOCKS=ALL	
,BLOCKS=RANGE	
,BLOCKID= <i>blockid</i>	<i>blockid</i> : RS-type address or register (2) - (12).
,ANSAREA= <i>ansarea</i>	<i>ansarea</i> : RS-type address or register (2) - (12).
,ANSLEN= <i>anslen</i>	<i>anslen</i> : RS-type address or register (2) - (12).
,FORCE=NO	Default: FORCE=NO
,FORCE=YES	
,FORCEINFO=NO	Default: FORCEINFO=NO
,OBLOCKID= <i>oblockid</i>	<i>oblockid</i> : RS-type address or register (2) - (12).
MODE=SYNC	Default: MODE=SYNC
MODE=ASYNCSNORESPONSE	

Syntax	Description
MODE=SYNCECB	
,ECB= <i>ecb</i>	<i>ecb</i> : RS-type address or register (2) - (12).
,DIAG=NO_DIAG	Default: DIAG=NO_DIAG
,DIAG=NO	
,DIAG=YES	
,PLISTVER=IMPLIED_VERSION	
,PLISTVER=MAX	Default: IMPLIED_VERSION
,PLISTVER=0	
,PLISTVER=1	
,RETCODE= <i>retcode</i>	<i>retcode</i> : RS-type address or register (2) - (12).
,RSNCODE= <i>rsncode</i>	<i>rsncode</i> : RS-type address or register (2) - (12).
,MF=S	Default: MF=S
,MF=(L, <i>list addr</i>)	
,MF=(L, <i>list addr,attr</i>)	
,MF=(L, <i>list addr,OD</i>)	
,MF=(E, <i>list addr</i>)	
,MF=(E, <i>list addr,COMPLETE</i>)	
,MF=(E, <i>list addr,NOCHECK</i>)	
,MF=(M, <i>list addr</i>)	
,MF=(M, <i>list addr,COMPLETE</i>)	
,MF=(M, <i>list addr,NOCHECK</i>)	

Parameters

The parameters are explained as follows:

,STREAMTOKEN=*streamtoken*

Specifies the name or address (using a register) of a required 16-byte input field containing the token for the log stream that you want to search. The stream token is returned by the IXGCONN service at connection to the log stream.

,BLOCKS=ALL**,BLOCKS=RANGE**

Specifies whether all or just a subset of log blocks in a log stream be deleted.

- BLOCKS=ALL: Specifies that all the log blocks in the specified log stream be deleted.
- BLOCKS=RANGE: Specifies that the range of log blocks, older than the block specified on the BLOCKID parameter, be deleted. The BLOCKID parameter is required with BLOCKS=RANGE, See *z/OS MVS Programming: Assembler Services Guide* for more information on deleting a range of log blocks.

,BLOCKID=blockid

Specifies the name or address (using a register) of a 8-byte input field which contains a log block identifier. BLOCKID is required with the BLOCKS=RANGE parameter. All blocks in the log stream **older** than the block specified on BLOCKID will be deleted. Note that the block specified in BLOCKID is not deleted.

Block identifiers are returned in the RETBLOCKID field of the IXGWRITE service.

,ANSAREA=ansarea

Specifies the name (or address in a register) of an answer area containing information about this request. The answer area must be at least 40 bytes. To map this information, use the IXGANSAA macro.

,ANSLEN=anslen

Specifies the name (or address in a register) of the 4-byte field containing the answer area length. The length of the answer area must be at least 40 bytes and must be the same length as the field specified in ANSAREA.

To ascertain the optimal answer area length, look at the ANSAA_PREFERRED_SIZE field of the IXGANSAA macro.

,FORCE=NO**,FORCE=YES**

Specifies whether this delete request can be overridden by a resource manager exit.

If you specify FORCE=NO, which is the default, the delete request **can** be overridden by the resource manager exit.

If you specify FORCE=YES, the delete request cannot be overridden by a delete exit.

,OBLOCKID=oblockid

Specifies the name or address (using a register) of an 8 character output field where the resource manager places the override block identifier.

,MODE=SYNC**,MODE=ASYNCRESPONSE****,MODE=SYNCECB**

Specifies that the request should be processed in one of the following ways:

- MODE=SYNC: Specifies that the request process synchronously. Control is not returned to the caller until request processing is complete. If necessary, the calling program will be suspended until the request completes.
- MODE=ASYNCRESPONSE: Specifies that the request process asynchronously. The caller is not notified when the request completes and the answer area (ANSAREA) fields will not contain valid information.
- MODE=SYNCECB: Specifies that the request process synchronously if possible. If the request processes asynchronously, control returns to the caller before the request completes and the event control block (ECB) specified on the ECB parameter is posted when the request completes. The ECB parameter is required with MODE=SYNCECB.

ECB=ecb

Specifies the name or address (using a register) of a 4-byte input field that contains an event control block (ECB) to be posted when the request completes.

IXGDELET macro

Before coding ECB, you must ensure that:

- You initialize the ECB.
- The ECB must reside in either common storage or the home address space where the IXGDELET request was issued.
- The virtual storage area specified for the ECB must reside on a fullword boundary.

,DIAG=NO_DIAG

,DIAG=NO

,DIAG=YES

Specifies whether or not the DIAG option on the IXGCONN for this logstream will be in effect for this delete log data request. Refer to the DIAG keyword on the IXGINVNT, IXGCONN and IXGBRWSE macro services.

If you specify DIAG=NO_DIAG, which is the default, then the DIAG option on the IXGCONN for this logstream will be in effect for this delete log data request.

If you specify DIAG=NO, then Logger will not take additional diagnostic action as defined on the logstream definition DIAG parameter.

If you specify DIAG=YES, then Logger will take additional diagnostic action as defined on the logstream definition DIAG parameter providing the IXGCONN connect DIAG specification allows it.

,PLISTVER=IMPLIED_VERSION

,PLISTVER=MAX

,PLISTVER=0

,PLISTVER=1

An optional input parameter that specifies the version of the macro. PLISTVER determines which parameter list the system generates.

The values are:

- **IMPLIED_VERSION**, which is the lowest version that allows all parameters specified on the request to be processed. If you omit the PLISTVER parameter, IMPLIED_VERSION is the default. Note that on the list form, the default will cause the smallest parameter list to be created.
- **MAX**, if you want the parameter list to be the largest size currently possible. This size might grow from release to release and affect the amount of storage that your program needs.

If you can tolerate the size change, IBM recommends that you always specify PLISTVER=MAX on the list form of the macro. Specifying MAX ensures that the list-form parameter list is always long enough to hold all the parameters you might specify on the execute form when both forms are assembled using the same level of the system. In this way, MAX ensures that the parameter list does not overwrite nearby storage.

- **0**, supports all parameters except those specifically referenced in higher versions.
- **2**, supports both the following parameters and parameters from version 0:
 - FORCE
 - OBLOCKID

To code: specify in this input parameter one of the following:

- IMPLIED_VERSION
- MAX
- A decimal value of 0 or 1

,RETCODE=retcode

Specifies a name or address (using a register) of a 4-byte output field where the system will place the return code. The return code is also in general purpose register (GPR) 15.

,RSNCODE=*rsncode*

Specifies a name (or address in a register) of a 4-byte output field where the system will place the reason code. The reason code is also in general purpose register (GPR) 0, if you received a non-zero return code.

,MF=S**,MF=(L,*list addr*)****,MF=(L,*list addr*,*attr*)****,MF=(L,*list addr*,OD)****,MF=(E,*list addr*)****,MF=(E,*list addr*,COMPLETE)****,MF=(E,*list addr*,NOCHECK)****,MF=(M,*list addr*)****,MF=(M,*list addr*,COMPLETE)****,MF=(M,*list addr*,NOCHECK)**

Use MF=S to specify the standard form of the macro, which builds an inline parameter list and generates the macro invocation to transfer control to the service. MF=S is the default.

Use MF=L to specify the list form of the macro. Use the list form together with the execute form of the macro for applications that require reentrant code. The list form defines an area of storage that the execute form uses to store the parameters. Only the PLISTVER parameter can be specified on the list form of the macro. IBM recommends that you always specify PLISTVER=MAX on the list form of the macro.

Use MF=E to specify the execute form of the macro. Use the execute form together with the list form of the macro for applications that require reentrant code. The execute form of the macro stores the parameters into the storage area defined by the list form, and generates the macro invocation to transfer control to the service.

Use MF=M together with the list and execute forms of the macro for service routines that need to provide different options according to user-provided input. Use the list form to define a storage area; use the modify form to set the appropriate options; then use the execute form to call the service.

IBM recommends that you use the modify and execute forms in the following order:

- Use MF=(M,*list_addr*,COMPLETE), specifying appropriate parameters, including all required ones.
- Use MF=(M,*list_addr*,NOCHECK), specifying the parameters you want to change.
- Use MF=(E,*list_addr*,NOCHECK), to execute the macro.

,*list addr*

The name of a storage area to contain the parameters.

,*attr*

An optional 1- to 60-character input string, which can contain any value that is valid on an assembler DS pseudo-op. You can use this parameter to force boundary alignment of the parameter list. If you do not code *attr*, the system provides a value of OD, which forces the parameter list to a doubleword boundary.

,COMPLETE

Specifies that the system is to check for required parameters and supply defaults for omitted optional parameters.

,NOCHECK

Specifies that the system is not to check for required parameters and is not to supply defaults for omitted optional parameters.

ABEND codes

None.

Return and reason codes

When IXGDELETE macro returns control to your program, GPR 15 contains a return code and GPR 0 contains a reason code.

Note: A program invoking the IXGDELETE service may indicate through the MODE parameter that requests which can not be completed synchronously should have control returned to the caller prior to the completion of the request. When the request does complete, the invoker will be notified and the return and reason codes are in the answer area mapped by IXGANSAA.

The IXGCON macro provides equate symbols for the return and reason codes. The equate symbols associated with each hexadecimal return code are as follows:

00

IXGRETCODEOK - Service completes successfully.

04

IXGRETCODEWARNING - Service completes with a warning.

08

IXGRETCODEERROR - Service does not complete.

0C

IXGRETCODECOMPERROR - Service does not complete.

The following table contains hexadecimal return and reason codes, the equate symbols associated with each reason code, and the meaning and suggested action for each return and reason code.

Return Code	Reason Code	Meaning and Action
00	xxxx0000	Equate Symbol: IxgRsnCodeOk Explanation: Request processed successfully.
04	xxxx0401	Equate Symbol: IxgRsnCodeProcessedAsynch Explanation: The program specified MODE=SYNCECB or MODE=ASYNCSYNRESPONSE and the request must be processed asynchronously. Action: For MODE=SYNCECB, wait for the ECB specified on the ECB parameter to be posted, indicating that the request is complete. Check the ANSAA_ASYNC_RETCODE and ANSAA_ASYNC_RSNCODE fields, mapped by IXGANSAA, to determine whether the request completed successfully.
04	xxxx040B	Equate Symbol: IxgRsnCodeRMNotConnected Explanation: Program or environment error. The log stream is identified as being managed by a resource manager (RMNAME is specified in the active system logger couple data set policy). However, at the time of the delete request, the resource manager was not connected to the log stream and FORCE=NO was specified on the request. Delete requests can only be honored on this system if the resource manager is also connected when delete requests are being monitored. Action: Either: <ul style="list-style-type: none"> Start the resource manager so that it can connect to the log stream. Issue the IXGDELETE request specifying FORCE=YES to delete the log block even though the resource manager is not connected to the source log stream.
04	xxxx040C	Equate Symbol: IxgRsnCodeRMOverrideOK Explanation: The caller's delete request was overridden by the associated resource manager. The override information was successfully processed.

Table 37. Return and Reason Codes for the IXGDELETE Macro (continued)

Return Code	Reason Code	Meaning and Action
04	xxxx040D	<p>Equate Symbol: IxgRsnCodeRMNoBlock</p> <p>Explanation: Program error. The log block identifier on the IXGDELETE request does not exist in the log stream. Either the block id never existed or was deleted in a previous IXGDELETE request. This warning is issued only if a resource manager overrides the caller-specified block id.</p> <p>Action: Make sure that the block id specified on the IXGDELETE request is correct.</p>
04	xxxx040E	<p>Equate Symbol: IxgRsnCodeRMBadGap</p> <p>Explanation: Environment error. The IXGDELETE request failed because the requested log data was unreadable. This problem is caused by either an I/O error while attempting to read a DASD log data set or a log data set was deleted using an interface other than IXGDELETE. This reason code is issued only when a resource manager exit overrides the block identifier specified on the IXGDELETE request.</p> <p>Action: System logger returns the block identifier of the first readable log block (in the direction of youngest data) in the ANSAA_GAPS_NEXT_BLKID field of the answer area mapped by IXGANSAA. If appropriate, reissue the IXGDELETE request using this block identifier.</p>
04	xxxx040F	<p>Equate Symbol: IxgRsnCodeRMEOFGap</p> <p>Explanation: Environment error. While processing the IXGDELETE request, system logger prematurely reached the end or beginning of the log stream. The portion of the log stream from the requested log data to either the beginning or end of the log stream was unreadable. This problem is caused by either an I/O error while attempting to read a DASD log data set or a log data set was deleted using an interface other than IXGDELETE. This reason code is issued only when a resource manager exit overrides the block identifier specified on the IXGDELETE request.</p> <p>Action: The action you take depends on whether your application can tolerate any loss of data. You can either:</p> <ul style="list-style-type: none"> • Accept the loss of data and continue processing this log stream. • Stop using this log stream. • Correct the problem and re-issue the request.
04	xxxx0410	<p>Equate Symbol: IxgRsnCodeRMLossOfDataGap</p> <p>Explanation: Environment error. The log data you tried to delete is in a section of the log stream where data is permanently missing. This condition occurs when a system or coupling facility is in recovery from a failure and not all the log data could be recovered. This reason code is issued only when a resource manager exit overrides the block identifier specified on the IXGDELETE request.</p> <p>Action: If your application cannot tolerate any data loss, stop issuing system logger services to this log stream, disconnect from the log stream, and reconnect to a new, undamaged log stream. If your application can tolerate data loss, you can continue using the log stream.</p>
04	xxxx0411	<p>Equate Symbol: IxgRsnCodeRMAbended</p> <p>Explanation: Program error. The resource manager abended and percolated to the system logger recovery environment. The IXGDELETE request was not processed.</p> <p>Action: Look for and correct the problem in your resource manager program or reissue the delete request, specifying FORCE=YES.</p>

Table 37. Return and Reason Codes for the IXGDELET Macro (continued)		
Return Code	Reason Code	Meaning and Action
04	xxxx0412	<p>Equate Symbol: IxgRsnCodeRMDisabled</p> <p>Explanation: Environment error. The log stream is identified as being managed by a resource manager (RMNAME is specified in the active system logger couple data set policy). The resource manager is connected to the log stream, but is disabled due to an abend from which it did not recover successfully (by percolating to the system logger recovery environment).</p> <p>Action: Either:</p> <ul style="list-style-type: none"> Cancel the resource manager exit and then restart the resource manager address space. Reissue the request, specifying FORCE=YES.
04	xxxx0414	<p>Equate Symbol: IxgRsnCodeRMStoppedDelete</p> <p>Explanation: The resource manager does not allow this IXGDELET request to delete any log blocks.</p> <p>Action: Determine why the resource manager is prohibiting deletes. Specify FORCE=YES to stop the resource manager exit from stopping the delete request.</p>
08	xxxx0801	<p>Equate Symbol: IxgRsnCodeBadParmlist</p> <p>Explanation: Program error. The parameter list could not be accessed.</p> <p>Action: Ensure that the storage area for the parameter list is accessible to the system logger for the duration of the request. The parameter list storage must be addressable in the caller's primary address space and in the same key as the caller.</p>
08	xxxx0802	<p>Equate Symbol: IxgRsnCodeXESError</p> <p>Explanation: System error. A severe cross-system extended services (XES) error has occurred.</p> <p>Action: See ANSAA_DIAG1 for the XES return code and ANSAA_DIAG2 for the XES reason code.</p>
08	xxxx0804	<p>Equate Symbol: IxgRsnCodeNoBlock</p> <p>Explanation: Program error. The block identifier or time stamp does not exist in the log stream. Either the value provided was never a valid location within the log stream or a prior IXGDELET request deleted the portion of the log stream it referenced.</p> <p>Action: Ensure that the value provided references an existing portion of the log stream and issue the request again. Use the LIST LOGSTREAM DETAIL(YES) request on the IXCMIPU utility to display the range of valid block identifiers for the log stream.</p>
08	xxxx0806	<p>Equate Symbol: IxgRsnCodeBadStmToken</p> <p>Explanation: Program error. One of the following occurred:</p> <ul style="list-style-type: none"> The stream token was not valid. The specified request was issued from an address space other than the connector's address space. <p>Action: Do one of the following:</p> <ul style="list-style-type: none"> Make sure that the stream token specified is valid. Ensure the request was issued from the connector's address space.
08	xxxx080A	<p>Equate Symbol: IxgRsnCodeRequestLocked</p> <p>Explanation: Program error. The program issuing the request is holding a lock.</p> <p>Action: Ensure that the program issuing the request is not holding a lock.</p>

Table 37. Return and Reason Codes for the IXGDELET Macro (continued)

Return Code	Reason Code	Meaning and Action
08	xxxx0814	<p>Equate Symbol: IxgRsnCodeNotAvailForIPL</p> <p>Explanation: Environment error. The system logger address space is not available for the remainder of this IPL. The system issues messages about this error during system logger initialization.</p> <p>Action: See the explanation for system messages issued during system logger initialization.</p>
08	xxxx0815	<p>Equate Symbol: IxgRsnCodeNotEnabled</p> <p>Explanation: Program error. The program issuing the request is not enabled for I/O and external interrupts, so the request fails.</p> <p>Action: Make sure the program issuing the request is enabled for I/O and external interrupts.</p>
08	xxxx0816	<p>Equate Symbol: IxgRsnCodeBadAnslen</p> <p>Explanation: Program error. The answer area length (ANSLEN parameter) is not large enough. The system logger returned the required size in the Ansaas_Preferred_Size field of the answer area, mapped by IXGANSAA macro.</p> <p>Action: Re-issue the request, specifying an answer area of the required size.</p>
08	xxxx0817	<p>Equate Symbol: IxgRsnCodeBadAnsarea</p> <p>Explanation: Program error. The storage area specified on the ANSAREA parameter cannot be accessed. This may occur after the system logger address space has terminated.</p> <p>Action: Specify storage that is in the caller's primary address space and in the same key as the calling program at the time the system logger service was issued. This storage must be accessible until the request completes.</p>
08	xxxx081C	<p>Equate Symbol: IxgRsnCodeNotAuthFunc</p> <p>Explanation: Program error. One of the following occurred:</p> <ul style="list-style-type: none"> • The program connected to the log stream with the AUTH=READ parameter and then tried to delete or write data. You cannot write or delete data when connected with read authority. • The program connected to the log stream with the AUTH=WRITE parameter and was granted limited access (for example, write only log data and disconnect) as per the defined security access profiles, and then tried to perform a log stream access service other than IXGWRITE or IXGCONN (to disconnect). <p>Action: A connection to the log stream with the appropriate access authority must be established before using the log stream delete (IXGDELET) service. If AUTH=WRITE was already in use when the error was encountered, then check with your installation's security administrator on obtaining the appropriate access to the log stream.</p>
08	xxxx081F	<p>Equate Symbol: IxgRsnCodeXcdsError</p> <p>Explanation: System error. System logger encountered an internal problem while processing the active system logger couple data set.</p> <p>Action: Contact the IBM Support Center. Provide the return and reason code and the contents of the answer area (ANSAREA field).</p>
08	xxxx082D	<p>Equate Symbol: IxgRsnCodeExpiredStmToken</p> <p>Explanation: Environment error. The stream token is no longer valid because the connector has been disconnected.</p> <p>Action: Connect to the log stream again before issuing any functional requests.</p>

Table 37. Return and Reason Codes for the IXGDELET Macro (continued)		
Return Code	Reason Code	Meaning and Action
08	xxxx0836	<p>Equate Symbol: IxgRsnCodeBadGap</p> <p>Explanation: Environment error. The request failed because the requested log data was unreadable. This condition could be caused by either an I/O error while attempting to read a log data set or a log data set deleted without using the IXGDELET interface.</p> <p>Action: The block identifier of the first accessible block toward the youngest data in the log stream is returned in the ANSAA_GAPS_NEXT_BLKID field in the answer area mapped by the IXGANSAA macro. If appropriate, re-issue the IXGDELET request using this block identifier.</p>
08	xxxx083D	<p>Equate Symbol: IxgRsnCodeBadECBStor</p> <p>Explanation: Program error. The ECB storage area was not accessible to the system logger.</p> <p>Action: Ensure that the storage area is accessible to the system logger for the duration of the request. The storage must be addressable in the caller's home address space and in the same key as the caller.</p>
08	xxxx084A	<p>Equate Symbol: IxgRsnCodeEOFGap</p> <p>Explanation: Environment error. The request prematurely reached the beginning or the end of the log stream. The portion of the log stream from the requested log data to either the beginning or the end of the log stream (depending on the direction of the read) was unreadable. This condition may be caused by either an I/O error while trying to read a log data set, or a log data set deleted without using the IXGDELET interface.</p> <p>Action: The action necessary is completely up to the application depending on how critical your data is. You can do one of the following:</p> <ul style="list-style-type: none"> • Accept this condition and continue reading. • Stop processing the log all together. • Attempt to get the problem rectified, if possible, and then try to re-issue the request.
08	xxxx084B	<p>Equate Symbol: IxgRsnCodeLossOfDataGap</p> <p>Explanation: Environment error. The requested log data referenced a section of the log stream where log data is permanently missing. This condition occurs when a system or coupling facility is in recovery due to a failure, but not all of the log data in the log stream could be recovered.</p> <p>Action: If your application cannot tolerate any data loss, stop issuing system logger services to this log stream, disconnect from the log stream, and reconnect to a new, undamaged log stream. You can continue using the log stream if your applications can tolerate data loss.</p>
08	xxxx0861	<p>Equate Symbol: IxgRsnCodeRebuildInProgress</p> <p>Explanation: Environment error. No requests can be processed for this log stream because a coupling facility structure re-build is in progress for the structure associated with this log stream.</p> <p>Action: Listen for ENF signal 48 that will indicate one of the following:</p> <ul style="list-style-type: none"> • The log stream is available because the re-build completed successfully. Re-issue the request. • The re-build failed and the log stream is not available.
08	xxxx0862	<p>Equate Symbol: IxgRsnCodeXESPurge</p> <p>Explanation: Environment error. An cross-system extended services (XES) request has been purged due to re-build processing.</p> <p>Action: Listen for ENF signal 48 that will indicate one of the following:</p> <ul style="list-style-type: none"> • The log stream is available because the re-build completed successfully. Re-issue the request. • The re-build failed and the log stream is not available.

Table 37. Return and Reason Codes for the IXGDELET Macro (continued)

Return Code	Reason Code	Meaning and Action
08	xxxx0863	<p>Equate Symbol: IxgRsnCodeStructureFailed</p> <p>Explanation: Environment error. Either the coupling facility structure associated with the log stream has failed or the coupling facility itself has failed.</p> <p>Action: Listen for ENF signal 48 that will indicate one of the following:</p> <ul style="list-style-type: none"> • The log stream is available because the re-build completed successfully. Re-issue the request. • The re-build failed and the log stream is not available.
08	xxxx0864	<p>Equate Symbol: IxgRsnCodeNoConnectivity</p> <p>Explanation: Environment error. No connectivity exists to the coupling facility associated with the log stream. The system logger will either attempt to re-build the log stream in another coupling facility or the log stream will be disconnected.</p> <p>Action: Listen for ENF signal 48 that will indicate one of the following:</p> <ul style="list-style-type: none"> • The log stream is available because the re-build completed successfully. Re-issue the request. • The re-build failed and the log stream is not available. • The log stream has been disconnected from this system. <p>If a re-build initiated because of a loss of connectivity previously failed, an ENF corresponding to this reason code might not be issued. Further action by the installation might be necessary to cause the change of the log stream status again. Check the log for messages IXG101I, IXG107I and related rebuild messages for information on resolving any outstanding issues.</p>
08	xxxx0890	<p>Equate Symbol: IxgRsnCodeAddrSpaceNotAvail</p> <p>Explanation: System error. The system logger address space failed and is not available.</p> <p>Action: Do not issue system logger requests.</p>
08	xxxx0891	<p>Equate Symbol: IxgRsnCodeAddrSpaceInitializing</p> <p>Explanation: System error. The system logger address space is not available because it is IPLing.</p> <p>Action: Listen for ENF signal 48, which will indicate when the system logger address space is available. Re-connect to the log stream, then re-issue this request. You can also listen for ENF signal 48, which will indicate if the system logger address space will not be available for the life of the IPL. In that case, do not issue system logger services.</p>
08	xxxx08D0	<p>Equate Symbol: IxgRsnCodeProblemState</p> <p>Explanation: Environment error. The request was rejected because of one of the following:</p> <ul style="list-style-type: none"> • The request was issued in SRB mode while the requestor was in problem program state. • The SYNCEXIT parameter was specified while the requestor's PSW key was in problem program key. <p>Action: Change the invoking environment to supervisor state.</p>
08	xxxx08D1	<p>Equate Symbol: IxgRsnCodeProgramKey</p> <p>Explanation: Environment error. The request was rejected because of one of the following:</p> <ul style="list-style-type: none"> • The request was issued in SRB mode while the requestor was in problem program key (key 8-F). • The SYNCEXIT parameter was specified while the requestor's PSW key was in problem program key. <p>Action: Change the invoking environment to a system key (key 0-7).</p>

Table 37. Return and Reason Codes for the IXGDELET Macro (continued)

Return Code	Reason Code	Meaning and Action
08	xxxx08D2	<p>Equate Symbol: IxgRsnCodeNoCompleteExit</p> <p>Explanation: Program error. MODE=SYNCEXIT was specified, but the connection request did not identify a complete exit.</p> <p>Action: Either change this request to a different MODE option, or reconnect to the log stream with a complete exit specified on the COMPLETEXIT parameter.</p>
08	xxxx085F	<p>Equate Symbol: IxgRsnPercToRequestor</p> <p>Explanation: Environment error. Percolation to the service requestor's task occurred because of an abend during system logger processing. Retry was not allowed.</p> <p>Action: Issue the request again. If the problem persists, contact the IBM Support Center.</p>
0C	xxxx0000	<p>Equate Symbol: IxgRetCodeCompError</p> <p>Explanation: User or System error. One of the following occurred:</p> <ul style="list-style-type: none"> You issued the FORCE IXGLOGR,ARM command to terminate the system logger address space. System logger component error occurred. <p>Action: If this reason code is not the result of forcing the system logger address space, search problem reporting data bases for a fix for the problem. If no fix exists, contact the IBM Support Center. Provide the diagnostic data in the answer area (IXGANSAA) and any dumps or LOGREC entries from system logger.</p>

Examples

Example 1

Delete all data from the log stream.

```

IXGDELET STREAMTOKEN=TOKEN,
          BLOCKS=ALL,
          MODE=SYNC,
          ANSAREA=ANSAREA,
          ANSLEN=ANSLEN,
          RSNCODE=RSNCODE,
          MF=S,
          RETCODE=RETCODE
ANSLEN   DC   A(L'ANSAREA)      length of logger's answer area
TOKEN    DS   CL16              stream token from connect
ANSAREA  DS   CL(ANSAA_LEN)     answer area for log requests
RETCODE  DS   F                 return code
RSNCODE  DS   F                 reason code
DATAREA  DSECT
IXGANSAA LIST=YES              answer area
    
```

Example 2

Delete a range of data from the log stream asynchronously, if synchronous processing is not possible.

```

IXGDELET STREAMTOKEN=TOKEN,
          BLOCKS=RANGE,
          BLOCKID=BLOCKID,
          MODE=SYNCECB,
          ECB=ANECEB,
          ANSAREA=ANSAREA,
          ANSLEN=ANSLEN,
          RSNCODE=RSNCODE,
          MF=S,
          RETCODE=RETCODE
*****
*           If rsncode = '00000401'X then wait on
    
```



```

*          the ecb ANECB.
*****
ANSLEN   DC    A(L'ANSAREA)          length of logger's answer area
BLOCKID  DS    CL8                   block id from which to delete
TOKEN    DS    CL16                  stream token from connect
ANSAREA  DS    CL(ANSAA_LEN)         answer area for log requests
ANECB    DS    F                     ecb on which to wait
RETCODE  DS    F                     return code
RSNCODE  DS    F                     reason code
DATAREA  DSECT
          IXGANSAA LIST=YES          answer area

```

Example 3

Delete all data from the log stream using registers with the macro.

```

          LA    R6,TOKEN              load stream token into register 6
          IXGDELETE STREAMTOKEN=(6), X
          BLOCKS=ALL,                 X
          MODE=SYNC,                  X
          ANSAREA=ANSAREA,            X
          ANSLEN=ANSLEN,              X
          RSNCODE=RSNCODE,            X
          MF=S,                        X
          RETCODE=RETCODE
ANSLEN   DC    A(L'ANSAREA)          length of logger's answer area
TOKEN    DS    CL16                  stream token from connect
ANSAREA  DS    CL(ANSAA_LEN)         answer area for log requests
RETCODE  DS    F                     return code
RSNCODE  DS    F                     reason code
DATAREA  DSECT
          IXGANSAA LIST=YES          answer area
R6       EQU   6

```

Chapter 70. IXGIMPRT – Import log blocks

Description

The IXGIMPRT macro allows a program to import a copy of a log block from one log stream to another, specifying a log block identifier and time stamp to be assigned to the log block.

Environment

The requirements for the caller are:

Environmental factor	Requirement
Minimum authorization:	Problem state. Any PSW key
Dispatchable unit mode:	Task
Cross memory mode:	PASN=HASN, any SASN
AMODE:	31-bit 64-bit
ASC mode:	Primary or access register (AR)
Interrupt status:	Enabled for I/O and external interrupts
Locks:	No locks may be held.
Control parameters:	None.

Programming requirements

- Before issuing this request, the caller must have a valid connection to the log stream. The connection must be issued with AUTH=WRITE and IMPORTCONNECT=YES parameters specified.
- The parameter list for this service must be addressable in the caller's primary address space.
- Include the IXGCON mapping macro in your program. This macro provides a list of equate symbols for the system logger services.
- Include mapping macro IXGANSAA in your program. This macro shows the format of the answer area output returned for each system logger service in the ANSAREA parameter.
- Although the data pointed to by the BUFFER64 keyword may be above the bar (2-gigabyte), the length of the name or address of the input field specified in the BUFFLEN keyword is still limited to 4 bytes.

Restrictions

All storage areas specified must be in the same storage key as the caller. Storage areas that are not ALET qualified must exist in the caller's primary address space.

You can call any of the system logger services in AMODE 64, but the parameter list and all other data addresses, with the exception of BUFFER64 must reside in 31-bit storage.

Input register information

Before issuing the IXGIMPRT macro, the caller does not have to place any information into any register unless using it in register notation for a particular parameter, or using it as a base register.

Output register information

When control returns to the caller, the GPRs contain:

Register Contents

- 0** Reason code, if register 15 contains a non-zero return code
- 1** Used as a work register by the system
- 2-13** Unchanged
- 14** Used as a work register by the system
- 15** Return code

When control returns to the caller, the ARs contain:

Register Contents

- 0-1** Used as a work register by the system
- 2-13** Unchanged
- 14-15** Used as a work register by the system

When control returns to a caller running in AMODE 64, the 64-bit registers contain:

Register Contents

- 0-1** Used as a work register by the system, if the caller specified BUFFER64. Otherwise, unchanged.
- 2-13** Unchanged
- 14** Unchanged
- 15** Used as a work register by the system.

Some callers depend on register contents remaining the same before and after issuing a service. If the system changes the contents of registers on which the caller depends, the caller must save them before issuing the service, and restore them after the system returns control.

Performance implications

None.

Syntax

The IXGIMPRT macro is written as follows:

Syntax	Description
<i>name</i>	<i>name</i> : symbol. Begin <i>name</i> in column 1.
␣	One or more blanks must precede IXGIMPRT.

Syntax	Description
IXGIMPRT	
b	One or more blanks must follow IXGIMPRT.
STREAMTOKEN= <i>streamtoken</i>	<i>streamtoken</i> : RS-type address or address in register (2) - (12).
,BUFFER= <i>buffer</i>	<i>buffer</i> : RS-type address or address in register (2) - (12).
BUFFER64= <i>buffer64</i>	<i>buffer64</i> : RS-type address or register (2) - (12).
,BLOCKLEN= <i>blocklen</i>	<i>blocklen</i> : RS-type address or address in register (2) - (12).
,BLOCKID= <i>blockid</i>	<i>blockid</i> : RS-type address or address in register (2) - (12).
,GMT_TIMESTAMP= <i>gmt_timestamp</i>	<i>gmt_timestamp</i> : RS-type address or address in register (2) - (12).
,LOCALTIME= <i>localtime</i>	<i>localtime</i> : RS-type address or address in register (2) - (12).
,ANSAREA= <i>ansarea</i>	<i>ansarea</i> : RS-type address or address in register (2) - (12).
,ANSLEN= <i>anslen</i>	<i>anslen</i> : RS-type address or address in register (2) - (12).
,BUFFALET= <i>buffalet</i>	<i>buffalet</i> : RS-type address or address in register (2) - (12).
,BUFFALET= <u>0</u>	Default: BUFFALET=0,
,RETCODE= <i>retcode</i>	<i>retcode</i> : RS-type address or register (2) - (12).
,RSNCODE= <i>rsncode</i>	<i>rsncode</i> : RS-type address or register (2) - (12).
,PLISTVER= <u>IMPLIED_VERSION</u>	Default: PLISTVER=IMPLIED_VERSION
,PLISTVER=MAX	
,PLISTVER=0	
,MF= <u>S</u>	Default: MF=S
,MF=(L, <i>list addr</i>)	<i>list addr</i> : RS-type address or register (1) - (12).

Syntax	Description
,MF=(L, <i>list addr</i> , <i>attr</i>)	
,MF=(L, <i>list addr</i> , <u>OD</u>)	
,MF=(E, <i>list addr</i>)	
,MF=(E, <i>list addr</i> , <u>COMPLETE</u>)	
,MF=(E, <i>list addr</i> , <u>NOCHECK</u>)	
,MF=(M, <i>list addr</i>)	
,MF=(M, <i>list addr</i> , <u>COMPLETE</u>)	
,MF=(M, <i>list addr</i> , <u>NOCHECK</u>)	

Parameters

The parameters are explained as follows:

name

An optional symbol, starting in column 1, that is the name on the IXGIMPRT macro invocation. The name must conform to the rules for an ordinary assembler language symbol.

STREAMTOKEN=*streamtoken*

A required input parameter that specifies the log stream token that was returned by the IXGCONN service.

To code: Specify the RS-type address, or address in register (2)-(12), of a 16-character field.

,BUFFER=*buffer*

,BUFFER64=*buffer64*

Required input parameter that specifies the buffer from which the log stream block is to be written.

- BUFFER=*buffer* specifies that the location of the buffer is in 31-bit storage.
- BUFFER64=*buffer64* specifies that the location of the buffer is in 64-bit storage.

The BUFFER and BUFFER64 parameters are mutually exclusive.

The buffer can be ALET qualified. If a buffer is ALET qualified, the ALET must index a valid entry on the task's dispatchable unit access list (DUAL).

To code: Specify the RS-type address, or address in register (2)-(12), of a character field.

,BLOCKLEN=*blocklen*

A required input parameter that specifies the length of the log block to be written. The maximum block length is 65,536.

To code: Specify the RS-type address, or address in register (2)-(12), of a fullword field.

,BLOCKID=*blockid*

A required input parameter that specifies the block id to be assigned to the log block being written. The block identifier specified must be greater than any previous block identifier in the log stream.

To code: Specify the RS-type address, or address in register (2)-(12), of an 8-character field.

,GMT_TIMESTAMP=*gmt_timestamp*

A required input parameter that specifies the 8-byte UTC time stamp to be associated with the log block being written. The timestamp specified must be greater than any previous timestamp in the log stream. The timestamp must be in STCK format.

To code: Specify the RS-type address, or address in register (2)-(12), of an 8-character field.

,LOCALTIME=localtime

A required input parameter that specifies the 8-byte local time stamp to be associated with the log block being imported. The timestamp must be in STCK format.

To code: Specify the RS-type address, or address in register (2)-(12), of an 8-character field.

,ANSAREA=ansarea

A required output parameter of a virtual storage area, called the answer area, in which service response information will be placed. The format of the answer area is described by the IXGANSAA mapping macro.

To code: Specify the RS-type address, or address in register (2)-(12), of a field.

,ANSLEN=anslen

A required input parameter that specifies the answer area length. The length of the answer area must be at least as large as the length of IXGANSAA.

To code: Specify the RS-type address, or address in register (2)-(12), of a fullword field.

,BUFFALET=buffalet**,BUFFALET=0**

An optional input parameter that specifies the ALET to be used to access the storage specified by the BUFFER or BUFFER64 keyword. The default is 0, which means that the buffer resides in the caller's primary address space.

To code: Specify the RS-type address, or address in register (2)-(12), of a fullword field.

,RETCODE=retcode

An optional output parameter into which the return code is to be copied from GPR 15.

To code: Specify the RS-type address of a fullword field, or register (2)-(12).

,RSNCODE=rsncode

An optional output parameter into which the reason code is to be copied from GPR 0.

To code: Specify the RS-type address of a fullword field, or register (2)-(12).

,PLISTVER=IMPLIED_VERSION**,PLISTVER=MAX****,PLISTVER=0**

An optional input parameter that specifies the version of the macro. PLISTVER determines which parameter list the system generates.

The values are:

- **IMPLIED_VERSION**, which is the lowest version that allows all parameters specified on the request to be processed. If you omit the PLISTVER parameter, IMPLIED_VERSION is the default. Note that on the list form, the default will cause the smallest parameter list to be created.
- **MAX**, if you want the parameter list to be the largest size currently possible. This size might grow from release to release and affect the amount of storage that your program needs.

If you can tolerate the size change, IBM recommends that you always specify PLISTVER=MAX on the list form of the macro. Specifying MAX ensures that the list-form parameter list is always long enough to hold all the parameters you might specify on the execute form when both forms are assembled using the same level of the system. In this way, MAX ensures that the parameter list does not overwrite nearby storage.

- **0**, supports all parameters except those specifically referenced in higher versions.

To code: Specify one of the following:

- IMPLIED_VERSION
- MAX
- A decimal value of 0

,MF=S
,MF=(L,list addr)
,MF=(L,list addr,attr)
,MF=(L,list addr,OD)
,MF=(E,list addr)
,MF=(E,list addr,COMPLETE)
,MF=(E,list addr,NOCHECK)
,MF=(M,list addr)
,MF=(M,list addr,COMPLETE)
,MF=(M,list addr,NOCHECK)

Use MF=S to specify the standard form of the macro, which builds an inline parameter list and generates the macro invocation to transfer control to the service. MF=S is the default.

Use MF=L to specify the list form of the macro. Use the list form together with the execute form of the macro for applications that require reentrant code. The list form defines an area of storage that the execute form uses to store the parameters. Only the PLISTVER parameter can be specified on the list form of the macro. IBM recommends that you always specify PLISTVER=MAX on the list form of the macro.

Use MF=E to specify the execute form of the macro. Use the execute form together with the list form of the macro for applications that require reentrant code. The execute form of the macro stores the parameters into the storage area defined by the list form, and generates the macro invocation to transfer control to the service.

Use MF=M together with the list and execute forms of the macro for service routines that need to provide different options according to user-provided input. Use the list form to define a storage area; use the modify form to set the appropriate options; then use the execute form to call the service.

IBM recommends that you use the modify and execute forms in the following order:

- Use MF=(M,*list_addr*,COMPLETE), specifying appropriate parameters, including all required ones.
- Use MF=(M,*list_addr*,NOCHECK), specifying the parameters you want to change.
- Use MF=(E,*list_addr*,NOCHECK), to execute the macro.

,list addr

The name of a storage area to contain the parameters.

,attr

An optional 1- to 60-character input string, which can contain any value that is valid on an assembler DS pseudo-op. You can use this parameter to force boundary alignment of the parameter list. If you do not code *attr*, the system provides a value of OD, which forces the parameter list to a doubleword boundary.

,COMPLETE

Specifies that the system is to check for required parameters and supply defaults for omitted optional parameters.

,NOCHECK

Specifies that the system is not to check for required parameters and is not to supply defaults for omitted optional parameters.

ABEND codes

Abend 1C5 **Ixg_Abend_Code** - See [z/OS MVS System Codes](#) for more information on this abend.

Return and reason codes

When the IXGIMPRT macro returns control to your program:

- GPR 15 (and *retcode*, if you coded RETCODE) contains a return code.
- When the value in GPR 15 is not zero, GPR 0 (and *rsncode*, if you coded RSNCODE) contains reason code.

The IXGCON mapping macro provides equate symbols for the return and reason codes. The equate symbols associated with each hexadecimal return code are as follows:

00

IXGRETCODEOK - Service completes successfully.

04

IXGRETCODEWARNING - Service completes with a warning.

08

IXGRETCODEERROR - Service does not complete.

0C

IXGRETCODECOMPERROR - Service does not complete. A system logger component error has been encountered.

The following table contains hexadecimal return and reason codes, the equate symbols associated with each reason code, and the meaning and suggested action for each return and reason code.

Return Code	Reason Code	Meaning and Action
00	xxxx0000	IxgRsnCodeOk - Explanation: Request processed successfully.
04	xxxx0405	IxgRsnCodeWarningLossOfData - Explanation: Environment error. Returned for READCURSOR, START OLDEST and RESET OLDEST requests. This condition occurs when a system and coupling facility fail and not all of the log data in the log stream could be recovered. <ul style="list-style-type: none">• For READCURSOR: A log block has been returned, but there may be log blocks permanently missing between this log block and the one previously returned.• For START OLDEST and RESET OLDEST: The oldest log blocks in the log stream may be permanently missing, the browse cursor is set at the oldest available log block. Action: If your application cannot tolerate any data loss, stop issuing system logger services to this log stream, disconnect from the log stream, and reconnect to a new, undamaged log stream. You can continue using the log stream if your applications can tolerate data loss.
04	xxxx0407	IxgRsnCodeConnPossibleLossOfData - Explanation: Environment error. The request was successful, but there may be log blocks permanently in the log stream. This condition occurs when a system or coupling facility fails and not all of the data in the log stream could be recovered. Action: If your application cannot tolerate any data loss, stop issuing system logger services to this log stream, disconnect from the log stream, and reconnect to a new, undamaged log stream. You can continue using the log stream if your applications can tolerate data loss.
04	xxxx0408	IxgRsnCodeDsDirectoryFullWarning - Explanation: Environment error. The request was successful, but the log stream's DASD data set directory is full. System logger cannot offload any further data from the coupling facility structure to DASD. The system logger will continue to process IXGIMPRT requests until this log streams portion of the coupling facility structure becomes full. Action: Either delete enough data from the log stream to free up space in the log streams data set directory so that offloading can occur or disconnect from the log stream.

Table 38. Return and Reason Codes for the IXGIMPRT Macro (continued)

Return Code	Reason Code	Meaning and Action
04	xxxx0409	<p>Equate Symbol: IxgRsnCodeWowWarning</p> <p>Explanation: Environment error. The request was successful, but an error condition was detected during a previous offload of data. System logger might not be able to offload further data. System logger will continue to process IXGWRITE requests only until the interim storage for the log stream is filled. (Interim storage is the coupling facility for a coupling facility log stream and local storage buffers for a DASD-only log stream.)</p> <p>Action: Do not issue any further requests for this log stream and disconnect. Connect to another log stream. Check the system log for message IXG301I to determine the cause of the error. If you cannot fix the error, search problem reporting data bases for a fix for the problem. If no fix exists, contact the IBM Support Center.</p>
04	000040A	<p>IxgRsnCodeDuplexFailureWarning -</p> <p>Explanation: Environment error. The request was successful, but the system logger was unable to duplex log data to staging data sets, even though the log stream definition requested unconditional duplexing to staging data sets by specifying the log stream attributes: STG_DUPLEX=YES, DUPLEXMODE=UNCOND, or STG_DUPLEX=YES,DUPLEXMODE=DRXRC. When DUPLEXMODE=UNCOND is specified, but Logger was unable to obtain a staging data set to duplex the log data. Therefore, the Logger duplexing is being done in local buffers (data space).</p> <p>When DUPLEXMODE=DRXRC is specified for a logstream and being used for (non-local) disaster recovery duplexing, if the internal buffers used for asynchronous buffering of the log blocks become full. Meaning the internal buffers became full before at least one of the full buffers could be written to the staging data set.</p> <p>Action: For DUPLEXMODE=UNCOND, if duplexing to staging data sets is required, disconnect from this log stream and connect to a log stream that can be duplexed to staging data sets.</p> <p>For DUPLEXMODE=DRXRC, if duplexing to a DRXRC-type staging data sets is required, then cause the log data to be offload to the log stream secondary storage (offload data sets) and then continue writing to the log stream.</p>
08	xxxx0801	<p>IxgRsnCodeBadParmlist -</p> <p>Explanation: Program error. The parameter list is invalid. Either the parameter list storage is inaccessible, or an invalid version of the macro was used.</p> <p>Action: Ensure that the storage area for the parameter list is accessible to the system logger for the duration of the request, and that the macro version is correct. The parameter list storage must be addressable in the caller's primary address space and in the same key as the caller.</p>
08	xxxx0802	<p>IxgRsnCodeXESError -</p> <p>Explanation: System error. A severe cross-system extended services (XES) error has occurred.</p> <p>Action: See ANSAA_DIAG1 for the XES return code and ANSAA_DIAG2 for the XES reason code.</p>
08	xxxx0803	<p>IxgRsnCodeBadBuffer -</p> <p>Explanation: Program error. The virtual storage area specified on the BUFFER parameter is not addressable.</p> <p>Action: Ensure that the storage area specified on the BUFFER parameter is accessible to system logger for the duration of the request. If the BUFFKEY parameter is specified, make sure it contains a valid key associated with the storage area. If BUFFKEY is not used, ensure that the storage is in the same key as the program at the time the logger service was requested. The storage must be addressable in the caller's primary address space.</p>

Table 38. Return and Reason Codes for the IXGIMPRT Macro (continued)

Return Code	Reason Code	Meaning and Action
08	xxxx0806	<p>IxgRsnCodeBadStmToken -</p> <p>Explanation: Program error. One of the following occurred:</p> <ul style="list-style-type: none"> The stream token was not valid. The specified request was issued from an address space other than the connectors address space. <p>Action: Do one of the following:</p> <ul style="list-style-type: none"> Make sure that the stream token specified is valid. Ensure that IXGIMPRT requests were issued from the connectors address space.
08	xxxx0809	<p>IxgRsnCodeBadWriteSize -</p> <p>Explanation: Program error. The size of the log block specified in the BLOCKLEN parameter is not valid. The value for BLOCKLEN must be greater than zero and less than or equal to the maximum buffer size (MAXBUFSIZE) defined in the active system logger couple data set policy for the log stream or for the structure associated with this log stream.</p> <p>Action: Ensure that the value specified on the BLOCKLEN parameter is greater than 0 and less than or equal to the MAXBUFSIZE which is returned on the log stream connect request.</p>
08	xxxx080A	<p>IxgRsnCodeRequestLocked -</p> <p>Explanation: Program error. The program issuing the request is holding a lock.</p> <p>Action: Ensure that the program issuing the request is not holding a lock.</p>
08	xxxx0814	<p>IxgRsnCodeNotAvailForIPL -</p> <p>Explanation: Environment error. The system logger address space is not available for the remainder of this IPL. The system issues messages about this error during system logger initialization.</p> <p>Action: See the explanation for system messages issued during system logger initialization.</p>
08	xxxx0815	<p>IxgRsnCodeNotEnabled -</p> <p>Explanation: Program error. The program issuing the request is not enabled for I/O and external interrupts, so the request fails.</p> <p>Action: Make sure the program issuing the request is enabled for I/O and external interrupts.</p>
08	xxxx0816	<p>IxgRsnCodeBadAnslen -</p> <p>Explanation: Program error. The answer area length (ANSLEN parameter) is not large enough. The system logger returned the required size in the Ansaas_Preferred_Size field of the answer area, mapped by IXGANSAA macro.</p> <p>Action: Reissue the request, specifying an answer area of the required size.</p>
08	xxxx0817	<p>IxgRsnCodeBadAnsarea -</p> <p>Explanation: Program error. The storage area specified on the ANSAREA parameter cannot be accessed. This may occur after the system logger address space has terminated.</p> <p>Action: Specify storage that is in the caller's primary address space and in the same key as the calling program at the time the system logger service was issued. This storage must be accessible until the request completes.</p>
08	xxxx0819	<p>IxgRsnCodeSRBMode -</p> <p>Explanation: Program error. The calling program is in SRB mode, but task mode is required for this system logger service.</p> <p>Action: Make sure your program is in task mode.</p>

Table 38. Return and Reason Codes for the IXGIMPRT Macro (continued)		
Return Code	Reason Code	Meaning and Action
08	xxxx082D	<p>IxgRsnCodeExpiredStmToken -</p> <p>Explanation: Environment error. The stream token is no longer valid because the connector has been disconnected.</p> <p>Action: Re-connect to the logstream before issuing any functional requests.</p>
08	xxxx083F	<p>IxgRsnCodeTestartError -</p> <p>Explanation: System error. An unexpected error was encountered while attempting to validate the buffer ALET.</p> <p>Action: See ANSAA_DIAG1 in the answer area mapped by the IXGANSAA macro for the return code from the</p>
08	xxxx0840	<p>IxgRsnCodeBadVersion -</p> <p>Explanation: Environment error. The parameter list passed to the service routine has an incorrect version indicator.</p> <p>Action: Make sure that the level of MVS executing the request and the macro library used to compile the invoking routine are compatible.</p>
08	xxxx0841	<p>IxgRsnCodeBadBufferAlet -</p> <p>Explanation: Program error. The buffer ALET specified is not zero and does not represent a valid entry on the callers dispatchable unit access list (DUAL). See the ANSAA_DIAG1 field of the answer area, mapped by the IXGANSAA macro, for the return code from the TESTART system service.</p> <p>Action: Ensure that the correct ALET was specified. If not, provide the correct ALET. Otherwise, add the correct ALET to dispatchable unit access list (DUAL).</p>
08	xxxx0849	<p>IxgRsnCodeBadBuffkey -</p> <p>Explanation: Program error. The buffer key specified on the BUFFKEY parameter specifies an invalid key. Either the key is greater than 15 or the program is running in problem state and the specified key is not the same key as the PSW key at the time the system logger service was issued.</p> <p>Action: For problem state programs, either do not specify the BUFFKEY parameter or else specify the same key as the PSW key at the time the system logger service was issued. For supervisor state programs, specify a valid storage key (0 <= key <= 15).</p>
08	xxxx085C	<p>Equate Symbol: IxgRsnCodeDsDirectoryFull</p> <p>Explanation: Environment error. The interim storage (for example: the coupling facility structure space allocated or the staging data set space) for the log stream is full. System logger's attempts to offload the interim storage log data to DASD has failed because the log stream's data set directory is full. If this reason code is issued by the IXGIMPRT request, no further import write requests can be processed until additional directory space is available for the log stream.</p> <p>System logger will periodically re-drive its offload attempts for this condition, which is applicable to both coupling facility structure and DASD-only type log streams. If system logger is able to offload log data, then an ENF event will be issued informing the connectors that the log stream should be available for writing more log data. However, the time that passes before you can write to the log stream is unpredictable.</p> <p>The system issues related messages IXG257I, IXG261E, IXG262A and IXG301I.</p> <p>Action: The system programmer must make more log stream data set directory space available.</p> <p>For information about how an authorized application program might respond to this reason code, see Setting up the system logger configuration in the <i>z/OS MVS Programming: Authorized Assembler Services Guide</i>.</p> <p>For information about how an unauthorized application program might respond to this reason code, see IXGIMPRT: Import log blocks in the <i>z/OS MVS Programming: Assembler Services Guide</i>.</p>

Table 38. Return and Reason Codes for the IXGIMPRT Macro (continued)

Return Code	Reason Code	Meaning and Action
08	xxxx085D	<p>Equate Symbol: IxgRsnCodeWowError</p> <p>Explanation: Environment error. The interim storage (for example: the coupling facility structure space allocated or the staging data set space) for the log stream is full. System logger's attempts to offload the interim storage log data to DASD have failed because of severe errors. No further write requests can be processed until the offload error condition is cleared.</p> <p>System logger will periodically re-drive its offload attempts for this condition, which is applicable to both coupling facility structure and DASD-only type log streams. If system logger is able to offload log data, then an ENF event will be issued informing the connectors that the log stream should be available for writing more log data. However, the time that passes before you can write to the log stream is unpredictable.</p> <p>The system issues related message IXG301I.</p> <p>Action: The system programmer must correct the severe error condition inhibiting the log stream offload. If you are unable to correct the error, search problem reporting data bases for a fix for the problem. If no fix exists, contact the IBM Support Center.</p> <p>You can retry your write request periodically or wait for the ENF signal that the log stream is available, or disconnect from this log stream and connect to another log stream.</p> <p>For information on how an authorized application program might respond to this reason code, see Setting up the system logger configuration in the <i>z/OS MVS Programming: Authorized Assembler Services Guide</i>.</p> <p>For information on how an authorized application program might respond to this reason code, see IXGIMPRT: Import log blocks in the <i>z/OS MVS Programming: Assembler Services Guide</i>.</p>
08	xxxx0860	<p>IxgRsnCodeCFLogStreamStorFull -</p> <p>Explanation: Environment error. The coupling facility structure space allocated for this log stream is full. No further requests can be processed until the log data in the coupling facility structure is offloaded to DASD log data sets.</p> <p>Action: Listen to the ENF signal 48 which will indicate that the log stream is available after the data has been offloaded to DASD and then reissue the request.</p>
08	xxxx0861	<p>IxgRsnCodeRebuildInProgress -</p> <p>Explanation: Environment error. No requests can be processed for this log stream because a coupling facility structure re-build is in progress for the structure associated with this log stream.</p> <p>Action: Listen for ENF signal 48 that will indicate one of the following:</p> <ul style="list-style-type: none"> • The log stream is available because the re-build completed successfully. Reissue the request. • The re-build failed and the log stream is not available.
08	xxxx0862	<p>IxgRsnCodeXESPurge -</p> <p>Explanation: Environment error. An cross-system extended services (XES) request has been purged due to re-build processing.</p> <p>Action: Listen for ENF signal 48 that will indicate one of the following:</p> <ul style="list-style-type: none"> • The log stream is available because the re-build completed successfully. Reissue the request. • The re-build failed and the log stream is not available.

Table 38. Return and Reason Codes for the IXGIMPRT Macro (continued)		
Return Code	Reason Code	Meaning and Action
08	xxxx0863	<p>IxgRsnCodeStructureFailed -</p> <p>Explanation: Environment error. Either the coupling facility structure associated with the log stream has failed or the coupling facility itself has failed.</p> <p>Action: Listen for ENF signal 48 that will indicate one of the following:</p> <ul style="list-style-type: none"> • The log stream is available because the re-build completed successfully. Reissue the request. • The re-build failed and the log stream is not available.
08	xxxx0864	<p>IxgRsnCodeNoConnectivity -</p> <p>Explanation: Environment error. No connectivity exists to the coupling facility associated with the log stream. The system logger will either attempt to re-build the log stream in another coupling facility or the log stream will be disconnected.</p> <p>Action: Listen for ENF signal 48 that will indicate one of the following:</p> <ul style="list-style-type: none"> • The log stream is available because the re-build completed successfully. Reissue the request. • The re-build failed and the log stream is not available. # The log stream has been disconnected from this system. <p>If a re-build initiated because of a loss of connectivity previously failed, an ENF corresponding to this reason code might not be issued. Further action by the installation might be necessary to cause the change of the log stream status again. Check the log for messages IXG101I, IXG107I and related rebuild messages for information on resolving any outstanding issues.</p>
08	xxxx0865	<p>Equate Symbol: IxgRsnCodeStagingDSFull</p> <p>Explanation: Environment error. The staging data set allocated for this log stream on this system is full. No further requests can be processed until enough log data in the coupling facility structure is offloaded to DASD log data sets to relieve the staging data set's full condition.</p> <p>Action: Listen to the ENF signal 48 which will indicate that the log stream is available after room becomes available in the staging data set. Then, reissue the request.</p>
08	xxxx0867	<p>Equate Symbol: IxgRsnCodeLocalBufferFull</p> <p>Explanation: Environment error. The available local buffer space for the system logger address space is full. No further requests can be processed until the log data in the local storage buffer is offloaded to DASD log data sets. Note that this reason code applies only to a IXGWRITE or IXGIMPRT request issued against a DASD-only log stream.</p> <p>Action: Listen for the ENF signal 48 indicating that the DASD-only log stream is available again after the data has been offloaded to DASD log data sets. Then reissue the request.</p>
08	xxxx0868	<p>Equate Symbol: IxgRsnCodeStagingDSFormat</p> <p>Explanation: Environment error. The staging data set allocated for this log stream on this system has not finished being formatted for use by System Logger. No further IXGWRITE requests can be processed until the formatting completes.</p> <p>Action: Listen to the ENG signal 48 which will indicate that the log stream is available after formatting process is finished. Then, reissue the request.</p>
08	xxxx0890	<p>IxgRsnCodeAddrSpaceNotAvail -</p> <p>Explanation: System error. The system logger address space failed and is not available.</p> <p>Action: Do not issue system logger requests.</p>

Table 38. Return and Reason Codes for the IXGIMPRT Macro (continued)

Return Code	Reason Code	Meaning and Action
08	xxxx0891	<p>IxgRsnCodeAddrSpaceInitializing -</p> <p>Explanation: System error. The system logger address space is not available because it is IPLing.</p> <p>Action: Listen for ENF signal 48, which will indicate when the system logger address space is available. Once it's available, re-connect to the log stream, then reissue this request. You can also listen for ENF signal 48, which will indicate if the system logger address space will not be available for the life of the IPL. In that case, do not issue system logger services.</p>
08	xxxx08D7	<p>IxgRsnCodeRequestNotAllowed -</p> <p>Explanation: Program error. The caller attempted to issue an import request while a write connection (IXGCONN AUTH=WRITE,IMPORTCONNECT=NO) was active.</p> <p>Action: Issue the correct type of request based on the import status of your connection.</p>
08	xxxx08D9	<p>IxgRsnCodeBadImportBlockId -</p> <p>Explanation: Program error. The blockid specified on the import request was either less than the blockid expected or less than the size the control information system logger adds to each log block. You can use IXGQUERY service to ascertain the size of control information for a log block. IXGQUERY returns the control information size for a log stream in the QBUF_Control_Info_Size field in the query buffer. IXGQUERY also returns the block identifier of the last successfully written log block.</p> <p>Action: Specify a valid value for the block id and reissue the import request.</p>
08	xxxx08DA	<p>IxgRsnCodeBadImportTimeStamp -</p> <p>Explanation: Program error. The UTC timestamp specified on the import request was not greater than or equal to the UTC time stamp assigned to the last log block successfully imported.</p> <p>Action: Specify a valid value for GMT_TimeStamp and reissue the request. You can obtain the UTC timestamp of the last successfully written log block using the IXGQUERY service.</p>
08	xxxx08DB	<p>IxgRsnCodeImportNoSrbMode -</p> <p>Explanation: Program error. IXGIMPRT requests can only be issued in task mode.</p> <p>Action: Issue the IXGIMPRT request while executing in task mode.</p>
08	xxxx08DC	<p>IxgRsnCodeImportInProgress -</p> <p>Explanation: Program error. Only one import operation for a given log stream can be in progress at any instance in time. The problem may be due to a task initiating an import request before a previously initiated import to the log stream has completed.</p> <p>Action: Wait for the currently executing import operation to complete before initiating a subsequent import operation.</p>
0C	xxxx0000	<p>IxgRetCodeCompError -</p> <p>Explanation: User or System error. One of the following occurred:</p> <ul style="list-style-type: none"> You issued the FORCE IXGLOGR,ARM command to terminate the system logger address space. System logger component error occurred. <p>Action: If this reason code is not the result of forcing the system logger address space, search problem reporting data bases for a fix for the problem. If no fix exists, contact the IBM Support Center. Provide the diagnostic data in the answer area (IXGANSAA) and any dumps or LOGREC entries from system logger.</p>

Example

Issue IXGIMPRT to import a log block to a back up log stream.

```

* R6      Read buffer address
          IXGIMPRT                                X
          STREAMTOKEN=OTOKEN,                    X
          BUFFER=(R6),                            X
          BLOCKLEN=DATALEN,                       X
          BLOCKID=RBLKID,                        X
          GMT_TIMESTAMP=GMTTIME,                  X
          LOCTIME=LOCTIME,                       X
          ANSAREA=XANSAREA,                      X
          ANSLEN=XANSLEN,                        X
          RSNCODE=RSCODE
R6        EQU      6
OTOKEN    DS      CL16      Output Stream token
DATALEN   DS      F        Returned data length
RBLKID    DS      CL8      Returned block identifier
GMTTIME   DS      CL8      GMT
LOCTIME   DS      CL8      Local Time
XANSAREA  DS      CL(ANSAA_LEN)  Logger answer area
XANSLEN   DC      A(ANSAA_LEN)  Answer area length
RSCODE    DS      F        Reason code
          DSECT    ,
          IXGANSAA ,      The answer area macro

```

Chapter 71. IXGINVNT – Managing the LOGR, LOGRY and LOGRZ inventory active system logger couple data set

IXGINVNT description

The active system logger couple data set tracks all data associated with log streams, such as log stream characteristics, coupling facility structures associated with log streams, and the systems connected to each log stream. System logger supports three distinct policy couple data set types:

LOGR

is the system logger sysplex scope couple data set type.

LOGRY

is a system logger single-system scope couple data set type.

LOGRZ

is a system logger single-system scope couple data set type.

Use the IXGINVNT macro to manage the active system logger couple data set by:

- Defining, updating or deleting entries for log streams in the active system logger couple data set policy.
- Defining or deleting entries for coupling facility structures in the LOGR policy.
- Checking on whether a particular log stream or structure is already defined in the active system logger couple data set policy.

The four requests for the macro are:

- IXGINVNT REQUEST=DEFINE, which defines an entry in the active system logger couple data set policy that is in use on the system where the request is executed. There are two types of DEFINE requests:
 - TYPE=LOGSTREAM defines an entry for a log stream. See [“REQUEST=DEFINE TYPE=LOGSTREAM option of IXGINVNT” on page 640](#) for the syntax of this request.
 - TYPE=STRUCTURE defines an entry for a system logger coupling facility structure. See [“REQUEST=DEFINE TYPE=STRUCTURE option of IXGINVNT” on page 659](#) for the syntax of this request.
- IXGINVNT REQUEST=UPDATE, which updates a log stream entry in the active system logger couple data set policy. See [“REQUEST=UPDATE option of IXGINVNT” on page 663](#) for the syntax of this request.
- IXGINVNT REQUEST=CHECKDEF, which indicates whether a particular log stream or structure entry is currently defined in the active system logger couple data set policy that is in use on the system where the request is executed. See [“REQUEST=CHECKDEF option of IXGINVNT” on page 681](#) for the syntax of this request.
- IXGINVNT REQUEST=DELETE, which deletes a log stream or structure entry from the active system logger couple data set policy. See [“REQUEST=DELETE option of IXGINVNT” on page 705](#) for the syntax of this request.

For information about using the system logger services and the active system logger couple data set policy, see [z/OS MVS Programming: Assembler Services Guide](#).

Environment

The requirements for the caller are:

Environmental factor	Requirement
Minimum authorization:	Problem state with any PSW key.
Dispatchable unit mode:	Task
Cross memory mode:	PASN=HASN, any SASN
AMODE:	31-bit or 64-bit
ASC mode:	Primary or access register (AR)
Interrupt status:	Enabled for I/O and external interrupts.
Locks:	No locks held.
Control parameters:	Control parameters must be in the primary address space.

Programming requirements

- The parameter list for this service must be addressable in the caller's primary address space.
- Include the IXGCON mapping macro in your program. This macro provides a list of equate symbols for the system logger services.
- Include mapping macro IXGANSAA in your program. This macro shows the format of the answer area output returned for each system logger service in the ANSAREA parameter.
- A minimum active system logger couple data set (CDS) format level is required to specify some parameters. Refer to each parameter description for details. Also see "Updating a log stream's attributes" in *z/OS MVS Programming: Assembler Services Guide* and topics "LOGR parameters for format utility (sysplex scope)" and "LOGRY or LOGRZ single-system scope parameters for format utility" in *z/OS MVS Setting Up a Sysplex* for more information.

Restrictions

- All storage areas specified in this service must be in the same storage key as the caller's storage key and must exist in the caller's primary address space.
 - The caller cannot have an EUT FRR established.
 - You can only use the IXGINVNT REQUEST=DELETE TYPE=LOGSTREAM request to delete a log stream entry from the active system logger couple data set policy if there are no active connections to the log stream.
 - For a few parameters on the IXGINVNT REQUEST=UPDATE request, there must be no connections (active or failed) to the log stream being updated. Refer to each parameter description to determine whether an update is allowed and when it takes effect when there are log stream connections.
 - Restrictions for DASD-only log stream definitions:
 - A DASD-only log stream is single-system in scope. This means that only one system at a time can connect to a DASD-only log stream. You **can** have multiple connections from one system or multiple systems connecting in sequence.
 - A DASD-only log stream is not associated with a coupling facility structure.
 - If the requested function is to update the attributes of a DASD-only log stream, the following parameters are not allowed:
 - STG_DUPLEX
 - DUPLEXMODE
 - LOGGERDUPLEX
- Use of staging data sets is automatic rather than optional for a DASD-only log stream.
- A DASD-only log stream can be upgraded to a coupling facility log stream by specifying STRUCTNAME on the IXGINVNT REQUEST=UPDATE TYPE=LOGSTREAM request. Conversely, a coupling facility log stream cannot be changed to DASD-only.

- The system performs SAF authorization checks on all IXGINVNT requests in order to protect the integrity of the resources in the system logger inventory, that is, in the active system logger couple data set policy used by a system.

For log stream entries, you must have the following authorization:

- To define, delete, or update a log stream entry, the caller must have alter access to RESOURCE(*log_stream_name*) in SAF class CLASS(LOGSTREAM)
- If you specify the STRUCTNAME parameter on a DEFINE request for a log stream entry, the caller must also have update access authority to the coupling facility structure, RESOURCE(*IXLSTR.structure_name*) in SAF class CLASS(FACILITY)
- If you use the LIKE parameter to model your definition after another log stream on a DEFINE request for a log stream entry that will be mapped to a structure named in the *like_log_stream_name* structure name, i.e. *like_structure_name*, then you must also have update access to the RESOURCE(*IXLSTR.like_structure_name*) in class CLASS(FACILITY).
- To check if a log stream is defined in the active system logger couple data set policy, the caller must have read access authority for a different resource based on the CDS data type in SAF class CLASS(FACILITY):
 - RESOURCE(MVSADMIN.LOGR) when the sysplex scope LOGR CDS is the active system logger policy for a system.
 - RESOURCE(MVSADMIN.LOGRY) when the single-system scope LOGRY CDS is the active on the system.
 - RESOURCE(MVSADMIN.LOGRZ) when the single-system scope LOGRZ CDS is the active on the system.

For logger structure entries, you must have the following authorization:

- To define or delete a structure entry in the LOGR policy, the caller must have alter access to RESOURCE(MVSADMIN.LOGR) in SAF class CLASS(FACILITY).
- To check a logger structure entry definition in the LOGR policy, the caller must have read access to RESOURCE(MVSADMIN.LOGR) in SAF class CLASS(FACILITY).

If the SAF authorization check indicates that a security product is not available or if a profile covering the LOGSTRM class or FACILITY class for each respective resource identified above is not defined, then the access will be allowed.

- There is more than one version of this macro available. The parameters you can use depend on the version you specify on the PLISTVER parameter. See the description of the PLISTVER parameter for more information.

Input register information

Before issuing the IXGINVNT macro, the caller does not have to place any information into any register unless using it in register notation for a particular parameter, or using it as a base register.

Output register information

When control returns to the caller, the GPRs contain:

Register

Contents

0

Reason code, if register 15 contains a non-zero return code

2-13

Unchanged

14

Used as a work register by the system

IXGINVNT macro

15

Return code

When control returns to the caller, the ARs contain:

Register

Contents

0-1

Used as a work register by the system

2-13

Unchanged

14-15

Used as a work register by the system

Some callers depend on register contents remaining the same before and after issuing a service. If the system changes the contents of registers on which the caller depends, the caller must save them before issuing the service, and restore them after the system returns control.

Performance implications

None.

REQUEST=DEFINE TYPE=LOGSTREAM option of IXGINVNT

The IXGINVNT macro with the DEFINE TYPE=LOGSTREAM parameters defines a log stream or coupling facility structure entry in the LOGR policy.

Syntax for REQUEST=DEFINE TYPE=LOGSTREAM

The standard form of the IXGINVNT REQUEST=DEFINE TYPE=LOGSTREAM macro is written as follows:

Syntax	Description
<i>name</i>	<i>name</i> : symbol. Begin <i>name</i> in column 1.
␣	One or more blanks must precede IXGINVNT.
IXGINVNT	
␣	One or more blanks must follow IXGINVNT.
REQUEST=DEFINE	
,TYPE=LOGSTREAM	
,ANSAREA= <i>ansarea</i>	<i>ansarea</i> : RS-type address or register (2) - (12).
,ANSLEN= <i>anslen</i>	<i>anslen</i> : RS-type address or register (2) - (12).

Syntax	Description
,STREAMNAME= <i>streamname</i>	<i>streamname</i> : RS-type address or register (2) - (12).
,GROUP=PRODUCTION	Default: GROUP=PRODUCTION
,GROUP=TEST	
,STRUCTNAME= <i>structname</i>	<i>structname</i> : RS-type address or register (2) - (12).
	Default: NO_STRUCTNAME
,DASDONLY=NO	Default: DASDONLY=NO
,DASDONLY=YES	
,MAXBUFSIZE= <i>maxbufsize</i>	<i>maxbufsize</i> : RS-type address or register (2) - (12).
,RMNAME= <i>rmname</i>	<i>rmname</i> : RS-type address or register (2) - (12).
,DESCRIPTION= <i>description</i>	<i>description</i> : RS-type address or register (2) - (12).
	Default: NO_DESCRIPTION
,LOGGERDUPLEX=UNCOND	Default: LOGGERDUPLEX=UNCOND
,LOGGERDUPLEX= COND	
,STG_DUPLEX=NO	Default: STG_DUPLEX=NO for DASDONLY=NO
,STG_DUPLEX=YES	Default: STG_DUPLEX=YES for DASDONLY=YES
,DUPLEXMODE=COND	Default: DUPLEXMODE=COND for DASDONLY=NO
,DUPLEXMODE=UNCOND	Default: DUPLEXMODE=UNCOND for DASDONLY=YES
,DUPLEXMODE=DRXRC	
,STG_MGMTCLAS= <i>stg_mgmtclas</i>	<i>stg_mgmtclas</i> : RS-type address or register (2) - (12).
	Default: NO_STG_MGMTCLAS
,STG_DATACLAS= <i>stg_dataclas</i>	<i>stg_dataclas</i> : RS-type address or register (2) - (12).
	Default: NO_STG_DATACLAS
,STG_STORCLAS= <i>stg_storclas</i>	<i>stg_storclas</i> : RS-type address or register (2) - (12).

Syntax	Description
	Default: NO_STG_STORCLAS
,STG_SIZE= <i>stg_size</i>	<i>stg_size</i> : RS-type address or register (2) - (12).
	Default: Size defined in SMS data class or by dynamic allocation
,LS_ALLOCAHEAD={ <i>xls_allocahead</i> *}	<i>xls_allocahead</i> : RS-type address or register (2) - (12).
	Default: * 0
,LS_MGMTCLAS= <i>ls_mgmtclas</i>	<i>ls_mgmtclas</i> : RS-type address or register (2) - (12).
	Default: NO_LS_MGMTCLAS
,LS_DATACLAS= <i>ls_dataclas</i>	<i>ls_dataclas</i> : RS-type address or register (2) - (12).
	Default: NO_LS_DATACLAS
,LS_STORCLAS= <i>ls_storclas</i>	<i>ls_storclas</i> : RS-type address or register (2) - (12).
	Default: NO_LS_STORCLAS
,LS_SIZE= <i>ls_size</i>	<i>ls_size</i> : RS-type address or register (2) - (12).
	Default: Size defined in SMS data class or by dynamic allocation
,RETPD= <i>retpd</i>	<i>retpd</i> : RS-type address or register (2) - (12).
	Default: NO_RETPD
,AUTODELETE=NO	Default: AUTODELETE=NO
,AUTODELETE=YES	
,AUTODELETE=NO_AUTODELETE	
,HLQ= <i>hlq</i>	<i>hlq</i> : RS-type address or register (2) - (12).
	Default: NO_HLQ
,EHLQ= <i>ehlq</i>	<i>ehlq</i> : RS-type address or register (2) - (12).
	Default: NO_EHLQ

Syntax	Description
,LOWOFFLOAD= <i>lowoffload</i>	<i>lowoffload</i> : RS-type address or register (2) - (12).
	Default: LOWOFFLOAD=0
,HIGHOFFLOAD= <i>highoffload</i>	<i>highoffload</i> : RS-type address or register (2) - (12).
	Default: HIGHOFFLOAD=80
WARNPRIMARY	RS-type address or register (2) - (12)
,WARNPRIMARY= <u>NO_WARNPRIMARY</u>	Default: NO_WARNPRIMARY
,WARNPRIMARY=NO	
,WARNPRIMARY=YES	
,OFFLOADRECALL=YES	Default: OFFLOADRECALL=YES
,OFFLOADRECALL=NO	
,OFFLOADRECALL=NO_OFFLOADRECALL	
,LIKE= <i>like_streamname</i>	<i>like_streamname</i> : RS-type address or register (2) - (12).
	Default: NO_LIKE
,MODEL=NO	Default: MODEL=NO
,MODEL=YES	
,DIAG=NO	Default: DIAG=NO
,DIAG=YES	
,DIAG=NO_DIAG	
,ZAI=NO	Default: ZAI=NO
,ZAI=YES	
,ZAI=NO_ZAI	
,ZAIDATA=NO_ZAIDATA	Default: ZAIDATA=NO_ZAIDATA
,ZAIDATA=Xzaidata	
,PLISTVER=IMPLIED_VERSION	
,PLISTVER=MAX	Default: IMPLIED_VERSION
,PLISTVER=0	

Syntax	Description
,PLISTVER=1	
,PLISTVER=2	
,PLISTVER=3	
,RETCODE= <i>retcode</i>	<i>retcode</i> : RS-type address or register (2) - (12).
,RSNCODE= <i>rsncode</i>	<i>rsncode</i> : RS-type address or register (2) - (12).
,MF=S	Default: MF=S
,MF=(L, <i>list addr</i>)	
,MF=(L, <i>list addr,attr</i>)	
,MF=(L, <i>list addr,0D</i>)	
,MF=(E, <i>list addr</i>)	
,MF=(E, <i>list addr,COMPLETE</i>)	
,MF=(E, <i>list addr,NOCHECK</i>)	
,MF=(M, <i>list addr</i>)	
,MF=(M, <i>list addr,COMPLETE</i>)	
,MF=(M, <i>list addr,NOCHECK</i>)	

Parameters for REQUEST=DEFINE,TYPE=LOGSTREAM

The parameters are explained as follows:

REQUEST=DEFINE

Requests that an entry for a log stream or coupling facility structure be defined in the LOGR policy.

,TYPE=LOGSTREAM

Indicates that the entry to be defined in the active system logger couple data set policy is a log stream entry.

,ANSAREA=*ansarea*

Specifies the name (or address in a register) of an answer area containing information about this request. The answer area must be at least 40 bytes. To map this information, use the IXGANSAA macro.

,ANSLEN=*anslen*

Specifies the name (or address in a register) of the 4-byte field containing the answer area length. The length of the answer area must be at least 40 bytes and must be the same length as the field specified in ANSAREA.

To ascertain the optimal answer area length, look at the ANSAA_PREFERRED_SIZE field of the IXGANSAA macro.

,STREAMNAME=*streamname*

Specifies the name (or address in a register) of the 26-byte input field containing the name of the log stream that you want to define in the active system logger couple data set policy.

The stream name must be 26 characters, padded on the right with blanks if necessary. The name can be made up of one or more segments separated by periods, up to the maximum length of 26 characters. The following rules apply:

- Each segment may contain up to eight numeric, alphabetic, or national (\$, #, or @) characters.
- The first character of each segment must be an alphabetic or national character.
- Each segment must be separated by periods, which you must count as characters.

STREAMNAME is required with the TYPE=LOGSTREAM parameter.

[GROUP=(PRODUCTION|TEST)]

An optional keyword input that specifies whether the log stream is in the test group or the production group. This keyword allows you to keep processing and resources for log streams in the two groups separate on a single system, including requests such as data set allocation and data set recalls. If the TEST group fails, the failure does not normally affect the PRODUCTION group. You can only specify the GROUP parameter in the LOGR couple data set because the sysplex is formatted at the HBB7705 level or higher.

If you specify GROUP(PRODUCTION), which is the default, system logger places this log stream in the PRODUCTION group. A PRODUCTION log stream can use at least 75% of the system logger couple data set DSEXTENT records and connection slots.

If you specify GROUP(TEST), system logger places this log stream in the TEST group. TEST log streams are limited to at most 25% of the system logger couple data set DSEXTENT records and connection slots.

Because system logger does not allow you to define a mixture of TEST and PRODUCTION log streams to a single structure, The GROUP value must match the group of the structure the log stream is being defined to. When you define the first log stream to a structure, the structure becomes either a TEST or PRODUCTION structure. After that, the GROUP value for subsequent log streams defined to a structure must match the GROUP value of the initial log stream. For example, if you specify or default to GROUP(PRODUCTION) for the first log stream defined to a structure, you will only be able to define PRODUCTION log streams to that structure subsequently. See [“Example 10” on page 731](#).

,STRUCTNAME=structname

With TYPE=LOGSTREAM, specifies the name (or address in a register) of a 16-byte input field that contains the name of the coupling facility structure associated with the coupling facility log stream being defined. The structure specified is a list structure defined in the CFRM policy. All of this log stream's log blocks will be written to this structure before being written to DASD.

For a coupling facility log stream, you must define STRUCTNAME in the log stream definition in the LOGR policy via this parameter or the STRUCTNAME defined for the log stream referenced by the LIKE parameter before you can connect to the log stream.

The following rules apply for the structname:

- It can contain numeric, alphabetic, or national (\$, #, or @) characters, or an underscore(_), padded on the right with blanks if necessary.
- The first character must be an alphabetic character.

For a DASD-only log stream (which includes any case where the active primary system logger CDS is a single-system scope LOGRY or LOGRZ CDS), omit the STRUCTNAME parameter, since there is no coupling facility associated with the log stream. Also omit the STRUCTNAME parameter when the active primary system logger CDS, where the IXGINVNT request is being processed, is for a single-system scope LOGRY or LOGRZ CDS.

If NO_STRUCTNAME is specified for STRUCTNAME, the macro will be invoked as if STRUCTNAME was not specified.

,DASDONLY=NO

,DASDONLY=YES

Specifies whether the log stream being defined is a coupling facility or a DASD-only log stream.

If you specify DASDONLY=NO, which is the default, the log stream is defined as a coupling facility log stream. With DASDONLY=NO, you can also specify STG_DUPLEX, DUPLEXMODE, and LOGGERDUPLEX keywords to select a method of duplexing for a coupling facility log stream.

If you specify DASDONLY=YES the log stream is defined as a DASD-only log stream and does not use the coupling facility for log data.

Since a staging data set is required when using a DASD-only log stream, check the usage of the STG_SIZE parameter, the STG_DATACLAS parameter, or the defaults used for sizing the staging data set.

DASD only log streams are unconditionally duplexed to staging data sets. This means that DASD only log streams are created as if STG_DUPLEX=YES, DUPLEXMODE=UNCOND, and LOGGERDUPLEX=UNCOND were specified when the log stream was defined. You cannot change these duplexing parameters. However, you can optionally specify STG_DUPLEX=YES, DUPLEXMODE=UNCOND, and LOGGERDUPLEX=UNCOND. If you specify any other parameters for these keywords when you define a DASD only log stream, the define request will fail.

,MAXBUFSIZE=*maxbufsize*

Specifies the name (or address in a register) of a 4-byte input field that contains the size, in bytes, of the largest log block that can be written to the DASD-only log stream being defined in this request.

The value for MAXBUFSIZE must be between 1 and 65,532 bytes. The default is 65,532 bytes.

This parameter is valid only with DASDONLY=YES.

,RMNAME=*rmname*

Specifies the name (or address in a register) of the 8-byte input field containing the name of the recovery resource manager program associated with the log stream. RNAME must be 8 alphanumeric or national (\$,#,or @) characters, padded on the right with blanks if necessary.

You must define RMNAME in the LOGR policy before the resource manager can connect to the log stream.

If you specify RMNAME to associate a resource manager with a log stream in the LOGR policy, the resource manager specified must subsequently connect to the log stream. If the resource manager does not connect to that log stream, system logger will not process any IXGDELET requests to delete log data. This is so that the resource manager will not miss any delete requests issued against the log stream.

,DESCRIPTION=NO DESCRIPTION

DESCRIPTION=*description*

Specifies the name (or address in a register) of the 16 character input field containing user defined data describing the log stream.

DESCRIPTION must be 16 alphanumeric or national (\$,#,@) characters, underscore (_) or period (.), padded on the right with blanks if necessary.

If you specify DESCRIPTION=NO_DESCRIPTION, which is the default, or a field of zeros, the macro is invoked as if the DESCRIPTION parameter was not specified.

,LOGGERDUPLEX=UNCOND

,LOGGERDUPLEX=COND

An optional input parameter that specifies whether logger continues to provide its own log data duplexing, or, conditionally, not provide its own duplexing based on an alternative duplexing configuration that provides an equivalent or better recoverability of the log data.

For both coupling facility and DASD only log streams, the default parameter is LOGGERDUPLEX=UNCOND.

The active primary TYPE=LOGR couple data set in the sysplex must be formatted at HBB7705 or higher to specify this keyword. Otherwise, the request fails with a return code 8, reason code 0839.

For coupling facility log streams:

LOGGERDUPLEX=UNCOND, indicates that system logger should provide its own duplexing of the log data regardless of any other duplexing (such as structure system-managed duplexing rebuild) that occur.

LOGGERDUPLEX=COND indicates that system logger should provide its own duplexing of the log data unless the log stream is in an alternative duplexing configuration that provides an equivalent or better recoverability of the log data. For example, system logger does not provide its own duplexing of the log data in the following configuration:

- when the log stream is in a non-volatile CF list structure that is handled by system-managed duplexing rebuild (duplex-mode)
- there is a failure-independent relationship between the two structure instances
- there is a failure-independent connection between connecting system and composite structure view.

Refer to [Logger and coupling facility duplexing combinations](#) and [System logger recovery in z/OS MVS Setting Up a Sysplex](#) for additional considerations on using the LOGGERDUPLEX keyword.

Refer to Case 5 in [Logger and coupling facility duplexing combinations](#) in the *z/OS MVS Setting Up a Sysplex* for additional details about the LOGGERDUPLEX keyword and a coupling facility log stream.

For DASD only log streams:

Log data will be unconditionally duplexed to staging data sets. You can omit this keyword or specify LOGGERDUPLEX=UNCOND. In either case, log data will be unconditionally duplexed to staging data sets. Specifying any other parameter for the LOGGERDUPLEX keyword will result in error for DASD only log streams.

,STG_DUPLEX=NO

,STG_DUPLEX=YES

Specifies whether the log stream data for a coupling facility log stream should be duplexed in DASD staging data sets.

For coupling facility log streams:

The default is STG_DUPLEX=NO. If you specify or default STG_DUPLEX=NO, the log data for a coupling facility log stream will be duplexed in local buffers, which might be vulnerable to system failure if your configuration contains a single point of failure.

If you specify STG_DUPLEX=YES, the log data for a coupling facility log stream will be duplexed in staging data sets if the conditions defined by the DUPLEXMODE keyword are met. This method will safeguard data on DASD staging data sets.

You can use the DUPLEXMODE keyword with STG_DUPLEX and with LOGGERDUPLEX to specify the type of duplexing desired and whether you want conditional or unconditional duplexing by logger.

For DASD only log streams:

You can either omit this keyword or specify STG_DUPLEX=YES. In either case, log data will be unconditionally duplexed to staging data sets. Specifying any other parameter for the STG_DUPLEX keyword will result in an error for DASD only log streams.

Refer to the LOGGERDUPLEX keyword for additional duplexing options.

,DUPLEXMODE=COND

DUPLEXMODE=UNCOND

Specifies the conditions under which the log data for a log stream should be duplexed in DASD staging data sets.

For coupling facility log streams:

The default is DUPLEXMODE=COND. If you specify or default to DUPLEXMODE=COND, the coupling facility log data will be duplexed in staging data sets only if a system's connection to the coupling facility log stream contains a single point of failure and is therefore vulnerable to permanent log data loss:

- A connection to a log stream contains a single point of failure if the coupling facility is volatile and/or resides on the same CPC as the MVS system connecting to it. The coupling facility log data for the system connection containing the single point of failure is duplexed to staging data sets.
- A connection to a log stream is failure-independent when the coupling facility for the log stream is non-volatile and resides on a different central processor complex (CPC) than the MVS system connecting to it. The coupling facility log data for that system connection will not be duplexed to staging data sets.

If you specify DUPLEXMODE=UNCOND, the log data for the coupling facility log stream will be duplexed in staging data sets, unconditionally, even if the connection is failure independent.

Note: If DUPLEXMODE(DRXRC) is specified, the log data is duplexed same as if the COND option is specified. This means that in staging data sets, if a system's connection to the coupling facility log stream contains a single point of failure, it is therefore vulnerable to permanent log data loss. For more information, see the CONF DUPLEXMODE option.

You can use the DUPLEXMODE keyword with STG_DUPLEX and with LOGGERDUPLEX to specify the type of duplexing desired and whether you want conditional or unconditional duplexing by logger. See "Selecting a Method of Duplexing Coupling Facility Log Data and System logger Recovery" in [z/OS MVS Setting Up a Sysplex](#) for complete information about using staging data sets to duplex log data.coupling facility

Note: The staging data set related keywords, STG_SIZE, STG_DATACLAS, STG_MGMTCLAS, and STG_STORCLAS will remain set for the log stream and be used for any dynamic staging data set allocation during local recovery even after the conversion to STG_DUPLEX=NO.

For DASD only log streams:

You can either omit this keyword or specify DUPLEXMODE=UNCOND. In either case, log data will be unconditionally duplexed to staging data sets. Specifying any other parameter for the DUPLEXMODE keyword will result in an error for DASD only log streams.

,STG_DATACLAS=NO_STG_DATACLAS

,STG_DATACLAS=stg_dataclas

Specifies the name (or address in a register) of an 8-byte input field containing the name of the SMS data class that will be used for allocation of the DASD staging data set for this log stream.

The data class must be 8 alphanumeric or national (\$,#, or @) characters, padded on the right with blanks if necessary. The first character must be an alphabetic or national character.

If you specify NO_STG_DATACLAS, which is the default, or a field of zeros, the class is assigned by standard SMS processing. See [z/OS DFSMS Using Data Sets](#) for more information about SMS.

An SMS value specified on the STG_DATACLAS parameter, including NO_STG_DATACLAS, **always** overrides one specified on a model log stream used on the LIKE parameter.

STG_DATACLAS is only valid with STG_DUPLEX=YES or DASDONLY=YES.

,STG_MGMTCLAS=NO_STG_MGMTCLAS

,STG_MGMTCLAS=stg_mgmtclas

Specifies the name (or address in a register) of an 8-byte input field containing the name of the SMS management class that will be used for allocation of the DASD staging data set for this log stream.

The management class must be 8 alphanumeric or national (\$,#, or @) characters, padded on the right with blanks if necessary. The first character must be an alphabetic or national character.

If you specify NO_STG_MGMTCLAS, which is the default, or a field of zeros, the class is assigned by standard SMS processing. See [z/OS DFSMS Using Data Sets](#) for more information about SMS.

An SMS value specified on the STG_MGMTCLAS parameter, including NO_STG_MGMTCLAS, **always** overrides one specified on a model log stream used on the LIKE parameter.

STG_MGMTCLAS is only valid with STG_DUPLEX=YES or DASDONLY=YES.

,STG_STORCLAS=NO STG_STORCLAS**,STG_STORCLAS=stg_storclas**

Specifies the name (or address in a register) of an 8-byte input field containing the name of the SMS storage class that will be used for allocation of the DASD staging data set for this log stream.

The storage class must be 8 alphanumeric or national (\$, #, or @) characters, padded on the right with blanks if necessary. The first character must be an alphabetic or national character.

If you specify NO_STG_STORCLAS, which is the default, or a field of zeros, the class is assigned by standard SMS processing. See *z/OS DFSMS Using Data Sets* for more information about SMS.

An SMS value specified on the STG_STORCLAS parameter, including NO_STG_STORCLAS, **always** overrides one specified on a model log stream used on the LIKE parameter.

STG_STORCLAS is only valid with STG_DUPLEX=YES or DASDONLY=YES.

,STG_SIZE=stg_size

Specifies the size, in 4K blocks, of the DASD staging data set for the log stream being defined.

The actual size of your data set depends on many factors including track size, CI SIZE, and volume type, and may be smaller or larger than your parameter inputs expect. Because of this reason, see "Testing log data set parameter modifications" in *z/OS MVS Setting Up a Sysplex* for important notes on choosing a data set size.

Specifying STG_SIZE overrides the space allocation attribute on the STG_DATACLAS parameter if specified.

If you omit STG_SIZE, for a **coupling facility log stream**, system logger does one of the following, in the order listed, to allocate space for staging data sets:

- Uses the STG_SIZE of the log stream specified on the LIKE parameter, if specified.
- Uses the maximum coupling facility structure size for the structure to which the log stream is defined. This value is obtained from the value defined on the SIZE parameter for the structure in the CFRM policy.

If you omit STG_SIZE for a **DASD-only log stream**, system logger does one of the following, in the order listed, to allocate space for staging data sets:

- Uses the STG_SIZE of the log stream specified on the LIKE parameter, if specified.
- Uses the size defined in the SMS data class for the staging data sets.
- Uses dynamic allocation rules for allocating data sets, if SMS is not available.

As of z/OS Version 2 Release 3, system logger supports staging data set sizes greater than 4GB. Use the STG_DATACLAS log stream specification and define the corresponding DFSMS data class with space allocation attributes and include in the data class definition the following attributes:

- Data Set Name Type "EXT" (extended format)
- Extended Addressability "Y"

Extended format is a means of storing data on a logical DASD volume. Extended addressability is a means to allow VSAM Data Sets greater addressability beyond the 4GB address constraint.

For more information about planning and sizing for staging data sets, see *Plan space for staging data sets* and *Set up the SMS environment for DASD data sets* in *z/OS MVS Setting Up a Sysplex*.

LS_ALLOCAHEAD(xls_allocahead | *)

Specifies whether offload data sets should be proactively allocated and opened in advance on systems connected to the log stream. It is the name (or address in a register) of an optional full-word input. The xls_allocahead value can be from 0 to 3.

The active primary TYPE=LOGR couple data set must be formatted at an HBB7705 or higher format level to specify this keyword. Otherwise, the request fails with return code 8 and reason code X'0839'. See "LOGR parameters for format utility" in *z/OS MVS Setting Up a Sysplex* for more information.

When the value is 0 (default), logger does not proactively allocate and open advanced-current log stream offload data sets on any systems that are connected to the log stream.

When the value is between 1 and 3 (inclusively), all systems that are connected to and performing offloads for the log stream should be proactive in newly allocating up to the intended number (xls_allocahead) of advanced-current offload data sets. It also indicates these systems are proactive in opening the current offload data set as well as the first advanced-current offload data set. The logger processing is potentially affected on a system with the ALLOCAHEAD(NO) IXGCNFxx parmlib policy specification. See the IXGCNFxx parmlib member in *z/OS MVS Initialization and Tuning Reference* for more information about the MANAGE OFFLOAD ALLOCAHEAD specification. Also see "Offloading log data from interim storage by freeing and/or moving it to DASD" in *z/OS MVS Setting Up a Sysplex* for more information about the logger behavior based on the ALLOCAHEAD and LS_ALLOCAHEAD parameters.

The default is * 0. Omitting the parameter LS_ALLOCAHEAD results in the log stream being defined with an advanced-current allocate ahead value of zero (0) unless the LIKE parameter is also specified. If the LIKE parameter is specified, the LS_ALLOCAHEAD value is copied from the referenced LIKE log stream entry.

,LS_DATACLAS=NO LS_DATACLAS

,LS_DATACLAS=ls_dataclas

Specifies the name (or address in a register) of an 8-byte input field containing the name of the SMS data class that will be used for allocation of the DASD log data set for this log stream.

The data class must be 8 alphanumeric or national (\$, #, or @) characters, padded on the right with blanks if necessary. The first character must be an alphabetic or national character.

If you specify NO_LS_DATACLAS, which is the default, or a field of zeros, the class is assigned by standard SMS processing. See *z/OS DFSMS Using Data Sets* for more information about SMS.

An SMS value specified on the LS_DATACLAS parameter, including NO_LS_DATACLAS, **always** overrides one specified on a model log stream used on the LIKE parameter.

,LS_MGMTCLAS=NO LS_MGMTCLAS

,LS_MGMTCLAS=ls_mgmtclas

Specifies the name (or address in a register) of an 8-byte input field containing the name of the SMS management class that will be used for allocation of the DASD log data set for this log stream.

The management class must be 8 alphanumeric or national (\$, #, or @) characters, padded on the right with blanks if necessary. The first character must be an alphabetic or national character.

If you specify NO_LS_MGMTCLAS, which is the default, or a field of zeros, the class is assigned by standard SMS processing. See *z/OS DFSMS Using Data Sets* for more information about SMS.

An SMS value specified on the LS_MGMTCLAS parameter, including NO_LS_MGMTCLAS, **always** overrides one specified on a model log stream used on the LIKE parameter.

,LS_STORCLAS=NO LS_STORCLAS

,LS_STORCLAS=ls_storclas

Specifies the name (or address in a register) of an 8-byte input field containing the name of the SMS storage class that will be used for allocation of the DASD log data set for this log stream.

The storage class must be 8 alphanumeric or national (\$, #, or @) characters, padded on the right with blanks if necessary. The first character must be an alphabetic or national character.

If you specify NO_LS_MGMTCLAS, which is the default, or a field of zeros, the class is assigned by standard SMS processing. See *z/OS DFSMS Using Data Sets* for more information about SMS.

An SMS value specified on the LS_MGMTCLAS parameter, including NO_LS_MGMTCLAS, **always** overrides one specified on a model log stream used on the LIKE parameter.

,LS_SIZE=ls_size

Specifies the size, in 4K blocks, of the log stream offload DASD data sets for the log stream being defined.

The actual size of your data set depends on many factors including track size, CI SIZE, and volume type, and may be smaller or larger than your parameter inputs expect. Because of this reason, see

"Testing log data set parameter modifications" in *z/OS MVS Setting Up a Sysplex* for important notes on choosing a data set size.

Specifying LS_SIZE overrides the space allocation attribute on the LS_DATACLAS parameter if specified.

If you omit LS_SIZE, system logger does one of the following to allocate offload data sets:

- Uses the LS_SIZE of the log stream specified on the LIKE parameter, if specified.
- Uses the size defined in the SMS data class for the offload data sets.
- Uses dynamic allocation rules for allocating data sets, if SMS is not available.

,AUTODELETE=NO

,AUTODELETE=YES

,AUTODELETE=NO_AUTODELETE

Specifies when system logger physically deletes log data.

If you specify AUTODELETE=NO, which is the default, system logger physically deletes an entire log data set only when **both** of the following are true:

- Data is marked for deletion by a system logger application using the IXGDELET service.
- The retention period for all the data in the log data set expires.

You must specify the RETPD parameter with AUTODELETE=NO.

If you specify AUTODELETE=YES, system logger automatically physically deletes log data whenever data is either marked for deletion (using the IXGDELET service or an archiving procedure) or the retention period for all the log data in a data set has expired.

Be careful when using AUTODELETE=YES if the system logger application manages log data deletion using the IXGDELET service. With AUTODELETE=YES, system logger can delete data that the application expects to be accessible.

If you specify AUTODELETE=NO_AUTODELETE, system logger uses the default AUTODELETE value, unless the LIKE parameter is specified. If the LIKE parameter is specified, the AUTODELETE value is copied from the referenced like log stream entry.

RETPD=0

RETPD=retpd

Specifies the name (or address in a register) of a 4-byte input field containing the number of days of the retention period for log data in the log stream. The retention period begins when data is written to the log stream. Once the retention period for an entire log data set has expired, the data set is eligible for physical deletion. The point at which system logger physically deletes the data depends on what you have specified on the AUTODELETE parameter. System logger will not process a retention period or delete data on behalf of log streams that are not connected to or being written to by an application.

The value specified for RETPD must be between 0 and 65,536.

,HLQ=NO_HLQ

,HLQ=hlq

Specifies the name (or address in a register) of an 8-byte input field containing the high-level qualifier for both the log stream data set name and the staging data set name.

The high-level qualifier must be 8 alphanumeric or national (\$, #, or @) characters, padded on the right with blanks if necessary. The first character must be an alphabetic or national character.

If you specify an explicit value for HLQ, this value overrides a high-level qualifier for the log stream specified on the LIKE parameter.

If you do not specify a high-level qualifier, or if you specify HLQ=NO_HLQ, the log stream being defined will have a high-level qualifier of IXGLOGR. If you also specified the LIKE parameter, it will have the high-level qualifier of the log stream specified on the LIKE parameter.

HLQ and EHLQ are mutually exclusive and cannot be specified for the same log stream definition.

If the name specified for the HLQ parameter refers to a field that contains X'00', the macro will be invoked as if NO_HLQ had been specified. However, specifying HLQ=NO_HLQ and EHLQ=*ehlq* on the same request results in an error. When HLQ=NO_HLQ is specified, the resulting high-level qualifier will be determined by the EHLQ value from the LIKE log stream or using a default value.

When the HLQ parameter is not explicitly specified on the request, the resulting high-level qualifier to be used for the log stream data sets will be based on whether the EHLQ or LIKE parameters are specified. If the EHLQ parameter is specified, that value will be used for the log stream data sets. When no high-level qualifier is explicitly specified on the DEFINE LOGSTREAM request, but the LIKE parameter is specified, then the high-level qualifier value being used in the referenced log stream will be used for the newly defined log stream. If the HLQ, EHLQ, and LIKE parameters are not specified, the default value depends upon the scope of the active primary system logger CDS where the IXGINVNT request is being processed.

- For the sysplex scope LOGR CDS, the default value “IXGLOGR” will be used.
- For the single-system scope LOGRY CDS, the default value “IXGLOGRY” will be used.
- For the single-system scope LOGRZ CDS, the default value “IXGLOGRZ” will be used.

If the log stream entry referenced by the LIKE parameter was defined with an HLQ value, then it will be copied unless the NO_HLQ is specified for the HLQ parameter.

,EHLQ=NO_EHLQ

,EHLQ=*ehlq*

Specifies the name (or address in a register) of a 33-byte input field containing the extended high-level qualifier for both the log stream data set name and the staging data set name.

Syntax requirements for the extended high-level qualifier are as follows:

- The extended high-level qualifier must be 33 alphanumeric or national (\$, #, or @) characters, padded on the right with blanks if necessary.
- The value can be made up of one or more qualifiers (each 1 to 8 characters) separated by periods, up to the maximum length of 33 characters.
- Each qualifier must contain up to eight alphabetic, national, or numeric characters. Lowercase alphabetic characters will be folded to uppercase.
- The first character of each qualifier must be an alphabetic or national character.
- Each qualifier must be separated by a period, which you must count as a character.
- The resulting length of concatenating the significant characters from the EHLQ value with the STREAMNAME value (including the period delimiter) cannot exceed 35 characters.

EHLQ and HLQ are mutually exclusive and cannot be specified for the same log stream definition.

When the EHLQ parameter is not explicitly specified on the request, the resulting high-level qualifier to be used for the log stream data sets will be based on whether the HLQ or LIKE parameters are specified. If the HLQ parameter is specified, that value will be used for the log stream data sets. When no high-level qualifier is explicitly specified on the DEFINE LOGSTREAM request, but the LIKE parameter is specified, then the high-level qualifier value being used in the referenced log stream will be used for the newly defined log stream. If the EHLQ, HLQ, and LIKE parameters are not specified, the default value depends upon the scope of the active primary system logger CDS where the IXGINVNT request is being processed.

- For the sysplex scope LOGR CDS, the default value “IXGLOGR” will be used.
- For the single-system scope LOGRY CDS, the default value “IXGLOGRY” will be used.
- For the single-system scope LOGRZ CDS, the default value “IXGLOGRZ” will be used.

If the name specified for the EHLQ parameter refers to a field that contains X'00', the macro will be invoked as if NO_EHLQ had been specified. However, specifying EHLQ=NO_EHLQ and HLQ=*hlq* on the same request results in an error. When EHLQ=NO_EHLQ is specified, the resulting high-level qualifier will be determined by the HLQ value from the LIKE log stream or using a default value.

The active primary TYPE=LOGR couple data set must be formatted at a HBB7705 or higher level in order to specify the EHLQ keyword. Otherwise, the request will fail with return code 8, reason code X'0839'.

,LOWOFFLOAD=0

,LOWOFFLOAD=lowoffload

Specifies the name (or address in a register) of an 4-byte input field containing the percent value you want to use as the low offload threshold for the coupling facility structure associated with this log stream. The low offload threshold is the target percent where you want offloading to stop, leaving approximately the specified LOWOFFLOAD percentage of log data in the coupling facility structure.

If you specify LOWOFFLOAD=0, which is the default, or omit the LOWOFFLOAD parameter, system logger uses the 0% usage mark as the low offload threshold where offloading stops, leaving 0% of the data in the coupling facility.

The value specified for LOWOFFLOAD must be less than the HIGHOFFLOAD value.

,HIGHOFFLOAD=80

,HIGHOFFLOAD=highoffload

Specifies the name (or address in a register) of an 4-byte input field containing the percent value you want to use as the high offload threshold for the coupling facility structure associated with this log stream. When the coupling facility is filled to the high offload threshold percentage or beyond, system logger begins offloading data from the coupling facility to the DASD log stream data sets.

If you specify HIGHOFFLOAD=80, which is the default, HIGHOFFLOAD=0, or omit the HIGHOFFLOAD parameter, system logger uses the 80% usage mark as the high offload threshold where offloading starts.

IBM recommends that you do not define your HIGHOFFLOAD value to greater than the default of 80%. Defining a higher high offload threshold can leave you vulnerable to filling your coupling facility space for the log stream, which means that system logger will reject all write requests until the coupling facility log data can be offloaded to DASD log data sets.

The value specified for HIGHOFFLOAD must be higher than the LOWOFFLOAD value.

,WARNPRIMARY=NO WARNPRIMARY

,WARNPRIMARY=NO

,WARNPRIMARY=YES

is an optional keyword input that specifies whether monitoring warning messages should be issued based on the log stream primary (interim) storage consumption above the HIGHOFFLOAD value.

The active primary TYPE=LOGR couple data set must be formatted at an HBB7705 (or higher) format level in order to specify WARNPRIMARY=YES. Otherwise, the request will fail with return code 8, reason code X'0839'. See 'LOGR parameters for format utility' in *z/OS MVS Setting Up a Sysplex* for more details.

If you omit the WARNPRIMARY parameter, the result will be the same as if you coded the NO_WARNPRIMARY option.

DEFAULT: NO_WARNPRIMARY

NO_WARNPRIMARY

Indicates that the WARNPRIMARY(NO) attribute should be used for the log stream unless the LIKE parameter is specified. If the LIKE parameter is specified, the WARNPRIMARY value will be copied from the referenced LIKE log stream entry.

NO

Indicates that the primary storage consumption monitoring warning messages will not be issued for the log stream.

YES

Indicates that log stream monitoring warning messages should be issued for the following conditions:

- When the log stream primary (interim) storage consumption is 2/3 between the HIGHOFFLOAD value and 100% full (rounded down to the nearest whole number). This is called the log stream imminent alert threshold.

For example, assume the default value is used for the HIGHOFFLOAD percentage. That would mean a HIGHOFFLOAD value of 80 would be used, so the warning messages would be triggered for this case at $(2(100 - 80)/3 + 80) = 93\%$.

- For a CF based log stream, when a 90% entry full condition is encountered.
- When an interim (primary) storage full condition is encountered.

For more details on the messages and monitoring primary storage consumption, see [z/OS MVS Setting Up a Sysplex](#).

Note: The value can be overridden on the system level by logger parameter options for IXGCNF keyword CONSUMPTIONALERT(SUPPRESS).

,OFFLOADRECALL=YES

,OFFLOADRECALL=NO

,OFFLOADRECALL=NO_OFFLOADRECALL

Specifies whether or not offload processing is to skip recalling the current offload data set.

This keyword can be updated even when the log stream is actively connected. The change will immediately be reflected in the log stream definition. It will take effect on the subsequent first connection to the log stream in the sysplex. For a structure-based log stream, the change will also take effect during the next structure rebuild.

Specifying OFFLOADRECALL=YES indicates that offload processing should recall a migrated current offload data set.

Specifying OFFLOADRECALL=NO indicates that offload processing should not recall the current offload data set and allocate a new one. Also with this setting, Logger will not wait on any ENQ serialization contention to be resolved and will receive a class 2 type error (unavailable system resource) as described in [z/OS MVS Programming: Authorized Assembler Services Guide](#) in topic [Interpreting error reason codes from DYNALLOC](#).

Note that this option can cause any or all of the current offload data set to be wasted space on DASD once it is recalled. Care should be taken when using this option to size the data sets appropriately.

If you specify OFFLOADRECALL=NO_OFFLOADRECALL, system logger uses the default OFFLOADRECALL value, unless the LIKE parameter is specified. If the LIKE parameter is specified, the OFFLOADRECALL value is copied from the referenced like log stream entry.

,LIKE=NO_LIKE

,LIKE=like_streamname

Specifies the name (or address in a register) of a 26-byte input field containing the name of a log stream that has already been defined in the LOGR policy. The characteristics of the already-defined log stream, such as storage class, management class, high level qualifier, and data class will be copied for the log stream you are currently defining. However, the parameters explicitly coded on this request override the characteristics of the log stream specified on the LIKE parameter.

The stream name must be 26 characters, padded on the right with blanks if necessary. The name can be made up of one or more segments separated by periods, up to the maximum length of 26 characters. The following rules apply:

- Each segment contains up to eight numeric, alphabetic, or national (\$, #, or @) characters.
- The first character of each segment must be an alphabetic or national character.
- Each segment must be separated by periods, which you must count as characters.

,MODEL=NO

,MODEL=YES

Specifies whether the log stream being defined in the active system logger couple data set policy is a model, exclusively for use with the LIKE parameter to set up general characteristics for other log stream definitions.

If you specify MODEL=NO, which is the default, the log stream being defined is not a model log stream. Systems can connect to and use this log stream. It can also be specified on the LIKE parameter, but is not exclusively for use as a model.

If you specify MODEL=YES, the log stream being defined is only a model log stream. It can only be specified as a model for other log stream definitions on the LIKE parameter in other IXGINVNT requests.

- Programs **cannot** connect to a log stream name that is defined as a model (MODEL=YES) using an IXGCONN request.
- No log stream data sets are allocated on behalf of a model log stream.
- The attributes of a model log stream are syntax checked at the time of the request, but not verified until a another log stream references the model log stream on the LIKE parameter.

,DIAG=NO

,DIAG=YES

,DIAG=NO_DIAG

Specifies whether or not dumping or additional diagnostics should be provided by Logger for certain conditions. See the DIAG keyword on the IXGCONN, IXGBRWSE and IXGDELET macro services.

If you specify DIAG=NO, which is the default, no special Logger diagnostic activity is requested for this logstream regardless of the DIAG specifications on the IXGCONN, IXGDELET and IXGBRWSE requests.

Specifying DIAG=YES indicates that special logger diagnostic activity is allowed for this log stream:

- Informational LOGREC software symptom records (denoted by RETCODE VALU/H00000004) as well as other external alerts highlighting suboptimal conditions. For additional details, see [z/OS MVS Diagnosis: Reference](#), "Enabling additional log stream diagnostics".
- When the appropriate specifications are provided on IXGCONN, IXGDELET or IXGBRWSE requests by the exploiting application, further additional diagnostics may be captured. See [z/OS MVS Programming: Assembler Services Guide](#), "Dumping on data loss (804-type) conditions" for more details.

If you specify DIAG=NO_DIAG, system logger uses the default DIAG value, unless the LIKE parameter is specified. If the LIKE parameter is specified, the DIAG value is copied from the referenced like log stream entry.

,ZAI=NO

,ZAI=YES

,ZAI=NO_ZAI

Optional keyword that specifies whether the log stream data should be included in the z/OS IBM zAware log stream client data sent to the IBM zAware server.

The active primary TYPE=LOGR couple data set must be formatted at the HBB7705 format level or higher in order to specify ZAI=YES. Otherwise, the request will fail with return code 8, reason code X'0839'. See 'LOGR parameters for format utility' in [z/OS MVS Setting Up a Sysplex](#).

If you omit this parameter, the result will be the same as if you coded to NO_ZAI option.

If you specify NO, it indicates that the log stream data will not be included in data sent from the z/OS IBM zAware log stream client to the IBM zAware server. No is the default.

If you specify YES, it indicates that the log stream data will be included in the data sent to the IBM zAware server provided that the z/OS IBM zAware log stream client is established. Refer to [Preparing for z/OS IBM zAware log stream client usage in z/OS MVS Setting Up a Sysplex](#).

If you specify NO_ZAI, it indicates that the default ZAI=NO attribute should be used for the log stream unless the LIKE parameter is specified. If the LIKE parameter is specified, the ZAI value will be copied from the referenced LIKE log stream entry. Care needs to be taken to ensure any newly defined log streams do not have the ZAI=YES designation unless that is the absolute intention.

,ZAIDATA=NO_ZAIDATA**,ZAIDATA=Xzaidata**

Is the name (RS-type), or address in register (2)-(12), of an optional 48 character input that specifies a value, if any, to be passed to the IBM zAware server when the z/OS IBM zAware log stream client is established (refer to ZAI=YES) keyword specification).

The value you specify is defined by and must match the intended log data type and capabilities of the IBM zAware server. See [Preparing for z/OS IBM zAware log stream client usage in z/OS MVS Setting Up a Sysplex](#) for more details on establishing and using z/OS IBM zAware log stream clients.

The active primary TYPE=LOGR couple data set must be formatted at the HBB7705 format level or higher in order to specify the ZAIDATA keyword option. Otherwise the request will fail with return code 8, reason code X'0839'. See 'LOGR parameters for format utility' in [z/OS MVS Setting Up a Sysplex](#) for more details.

Specifying NO_ZAIDATA indicates that a null value will be used for the log stream ZAIDATA attribute.

Specifying Xzaidata indicates the name of the input variable containing the value. The value must be 48 characters long and padded on the right with blanks if necessary.

Valid characters are alphanumeric or national (\$, #, @) characters, and any of the special (graphical) characters listed below. Lower case alphabetic characters will be folded to upper case. Any other characters will be converted into an EBCDIC blank X'40', Valid special (graphical) characters:

<i>Table 39. Valid special (graphical) characters:</i>		
Character Name	Symbol	Hexidecimal (EBCDIC)
EBCDIC blank	<blank>	X'40'
Cent sign	¢	X'4A'
Period	.	X'4B'
Less than sign	<	X'4C'
Left parenthesis	(X'4D'
Plus sign	+	X'4E'
Or sign		X'4F'
Ampersand	&	X'50'
Exclamation point	!	X'5A'
Asterisk	*	X'5C'
Right parenthesis)	X'5D'
Semicolon	;	X'5E'
Not sign	¬	X'5F'
Minus sign (hyphen)	-	X'60'
Slash	/	X'61'
Comma	,	X'6B'
Percent Sign	%	X'6C'
Underscore	_	X'6D'
Greater than sign	>	X'6E'
Question mark	?	X'6F'
Emphasis mark	¨	X'79'

<i>Table 39. Valid special (graphical) characters: (continued)</i>		
Character Name	Symbol	Hexidecimal (EBCDIC)
Colon	:	X'7A'
Apostrophe	'	X'7D'
Equal sign	=	X'7E'
Quote	"	X'7F'
Tilde	~	X'A1'
Left brace	{	X'CO'
Right brace	}	X'DO'
Backslash	\	X'E0'

If the resulting Xzaidata parameter value contains all X'40' (blanks), the ZAIDATA keyword will be treated as if NO_ZAIDATA had been specified. The NO_ZAIDATA is the default.

If you omit the ZAIDATA parameter, the default will be used unless the LIKE parameter is specified. If the LIKE parameter is specified, the ZAIDATA value will be copied from the referenced LIKE log stream entry.

If you specify the ZAIDATA parameter, the value will always override one specified on a model log stream used on the LIKE parameter.

,PLISTVER=IMPLIED VERSION

,PLISTVER=MAX

,PLISTVER=0

,PLISTVER=1

,PLISTVER=2

An optional input parameter that specifies the version of the macro. PLISTVER determines which parameter list the system generates.

The values are:

- **IMPLIED_VERSION**, which is the lowest version that allows all parameters specified on the request to be processed. If you omit the PLISTVER parameter, IMPLIED_VERSION is the default. Note that on the list form, the default will cause the smallest parameter list to be created.
- **MAX**, if you want the parameter list to be the largest size currently possible. This size might grow from release to release and affect the amount of storage that your program needs.

If you can tolerate the size change, IBM recommends that you always specify PLISTVER=MAX on the list form of the macro. Specifying MAX ensures that the list-form parameter list is always long enough to hold all the parameters you might specify on the execute form when both forms are assembled using the same level of the system. In this way, MAX ensures that the parameter list does not overwrite nearby storage.

- **0**, which supports all parameters except those specifically referenced in higher versions.
- **1**, which supports both the following parameters and parameters from version 0:
 - DESCRIPTION
 - RMNAME
 - RETPD
 - AUTODELETE
- **2**, which supports both the following parameters and parameters from version 0 and 1:
 - DASDONLY
 - LOGGERDUPLEX

- **3**, which supports the following parameter and parameters from version 0, 1, and 2:

- EHLQ

To code: Specify in this input parameter one of the following:

- IMPLIED_VERSION
- MAX
- A decimal value of 0, 1, 2, or 3

,RETCODE=retcode

Specifies a name (or address in a register) of a 4-byte output field where the system will place the return code. The return code is also in general purpose register (GPR) 15.

,RSNCODE=rsncode

Specifies a name (or address in a register) of a 4-byte output field where the system will place the reason code. The reason code is also in general purpose register (GPR) 0, if you received a non-zero return code.

,MF=S

,MF=(L,list addr)

,MF=(L,list addr,attr)

,MF=(L,list addr,OD)

,MF=(E,list addr)

,MF=(E,list addr,COMPLETE)

,MF=(E,list addr,NOCHECK)

,MF=(M,list addr)

,MF=(M,list addr,COMPLETE)

,MF=(M,list addr,NOCHECK)

Use MF=S to specify the standard form of the macro, which builds an inline parameter list and generates the macro invocation to transfer control to the service. MF=S is the default.

Use MF=L to specify the list form of the macro. Use the list form together with the execute form of the macro for applications that require reentrant code. The list form defines an area of storage that the execute form uses to store the parameters. Only the PLISTVER parameter can be specified on the list form of the macro. IBM recommends that you always specify PLISTVER=MAX on the list form of the macro.

Use MF=E to specify the execute form of the macro. Use the execute form together with the list form of the macro for applications that require reentrant code. The execute form of the macro stores the parameters into the storage area defined by the list form, and generates the macro invocation to transfer control to the service.

Use MF=M together with the list and execute forms of the macro for service routines that need to provide different options according to user-provided input. Use the list form to define a storage area; use the modify form to set the appropriate options; then use the execute form to call the service.

IBM recommends that you use the modify and execute forms in the following order:

- Use MF=(M,list_addr,COMPLETE), specifying appropriate parameters, including all required ones.
- Use MF=(M,list_addr,NOCHECK), specifying the parameters you want to change.
- Use MF=(E,list_addr,NOCHECK), to execute the macro.

,list addr

The name of a storage area to contain the parameters.

,attr

An optional 1- to 60-character input string, which can contain any value that is valid on an assembler DS pseudo-op. You can use this parameter to force boundary alignment of the parameter list. If you do not code *attr*, the system provides a value of OD, which forces the parameter list to a doubleword boundary.

,COMPLETE

Specifies that the system is to check for required parameters and supply defaults for omitted optional parameters.

,NOCHECK

Specifies that the system is not to check for required parameters and is not to supply defaults for omitted optional parameters.

REQUEST=DEFINE TYPE=STRUCTURE option of IXGINVNT

The IXGINVNT macro with the DEFINE TYPE=STRUCTURE parameters defines a coupling facility structure entry in the LOGR policy for a coupling facility log stream.

Syntax for REQUEST=DEFINE TYPE=STRUCTURE

The standard form of the IXGINVNT REQUEST=DEFINE TYPE=STRUCTURE macro is written as follows:

Syntax	Description
<i>name</i>	<i>name</i> : symbol. Begin <i>name</i> in column 1.
␣	One or more blanks must precede IXGINVNT.
IXGINVNT	
␣	One or more blanks must follow IXGINVNT.
REQUEST=DEFINE	
,TYPE=STRUCTURE	
,ANSAREA= <i>ansarea</i>	<i>ansarea</i> : RS-type address or register (2) - (12).
,ANSLEN= <i>anslen</i>	<i>anslen</i> : RS-type address or register (2) - (12).
,STRUCTNAME= <i>structname</i>	<i>structname</i> : RS-type address or register (2) - (12). Default: NO_STRUCTURE
,LOGSNUM= <i>logsnum</i>	<i>logsnum</i> : RS-type address or register (2) - (12).
,MAXBUFSIZE= <i>maxbufsize</i>	<i>maxbufsize</i> : RS-type address or register (2) - (12). Default: 65532
,AVGBUFSIZE= <i>avgbufsize</i>	<i>avgbufsize</i> : RS-type address or register (2) - (12).

Syntax	Description
	Default: 1/2 of <i>maxbufsize</i>
,PLISTVER=IMPLIED_VERSION	
,PLISTVER=MAX	Default: IMPLIED_VERSION
,PLISTVER=0	
,PLISTVER=1	
,PLISTVER=2	
,PLISTVER=3	
,RETCODE= <i>retcode</i>	<i>retcode</i> : RS-type address or register (2) - (12).
,RSNCODE= <i>rsncode</i>	<i>rsncode</i> : RS-type address or register (2) - (12).
,MF=S	Default: MF=S
,MF=(L, <i>list addr</i>)	
,MF=(L, <i>list addr,attr</i>)	
,MF=(L, <i>list addr,0D</i>)	
,MF=(E, <i>list addr</i>)	
,MF=(E, <i>list addr,COMPLETE</i>)	
,MF=(E, <i>list addr,NOCHECK</i>)	
,MF=(M, <i>list addr</i>)	
,MF=(M, <i>list addr,COMPLETE</i>)	
,MF=(M, <i>list addr,NOCHECK</i>)	

Parameters for REQUEST=DEFINE,TYPE=STRUCTURE

The parameters are explained as follows:

REQUEST=DEFINE

Requests that an entry for a log stream or coupling facility structure be defined in the LOGR policy.

,TYPE=STRUCTURE

Indicates that the entry to be defined in the LOGR policy is a coupling facility entry being defined for a coupling facility log stream.

,ANSAREA=*ansarea*

Specifies the name (or address in a register) of an answer area containing information about this request. The answer area must be at least 40 bytes. To map this information, use the IXGANSAA macro.

,ANSLEN=*anslen*

Specifies the name (or address in a register) of the 4-byte field containing the answer area length. The length of the answer area must be at least 40 bytes and must be the same length as the field specified in ANSAREA.

To ascertain the optimal answer area length, look at the ANSAA_PREFERRED_SIZE field of the IXGANSAA macro.

,STRUCTNAME=structname

When specified with TYPE=STRUCTURE, specifies the name (or address in a register) of a 16-byte input field that contains the name of the coupling facility structure you are defining to the LOGR policy.

STRUCTNAME is required for TYPE=STRUCTURE.

The following rules apply for the structname:

- It can contain numeric, alphabetic, or national (\$, #, or @) characters, or an underscore(_), padded on the right with blanks if necessary.
- The first character must be an alphabetic character.

,LOGSNUM=lognum

Specifies the name (or address in a register) of a 4-byte input field that contains the number of log streams that can be allocated to the coupling facility structure being defined in the LOGR policy. *lognum* must be a value between 1 and 512.

IBM recommends that you keep the value for LOGSNUM as small as possible, particularly if your coupling facility structure is small. The more log streams that map to a coupling facility, the less coupling facility space for each log stream and the more chance you stand of running out of space for log streams. See *z/OS MVS Programming: Assembler Services Guide* for more information.

LOGSNUM is required for TYPE=STRUCTURE.

,MAXBUFSIZE=maxbufsize

Specifies the name (or address in a register) of a 4-byte input field that contains the size, in bytes, of the largest log block that can be written to log streams allocated to the coupling facility specified in this request.

The value for MAXBUFSIZE must be between 1 and 65,532 bytes. The default is 65,532 bytes.

,AVGBUFSIZE=avgbufsize

Specifies the name (or address in a register) of a 4-byte input field of the average size, in bytes, of log blocks written to all the log streams using this coupling facility structure.

System logger uses the average buffer size to control the entry-to-element ratio for this coupling facility structure.

The system logger uses the AVGBUFSIZE specified simply to make an initial determination of the entry-to-element ratio for the structure. After that, system logger monitors structure usage and dynamically manages the entry-to-element ratio accordingly. System logger uses the last entry-to-element ratio in effect for a structure for subsequent structure reallocation requests.

avgbufsize must be between 1 and the value for MAXBUFSIZE. The default value is 1/2 of the MAXBUFSIZE value.

,PLISTVER=IMPLIED_VERSION

,PLISTVER=MAX

,PLISTVER=0

,PLISTVER=1

,PLISTVER=2

,PLISTVER=3

An optional input parameter that specifies the version of the macro. PLISTVER determines which parameter list the system generates.

The values are:

- **IMPLIED_VERSION**, which is the lowest version that allows all parameters specified on the request to be processed. If you omit the PLISTVER parameter, IMPLIED_VERSION is the default. Note that on the list form, the default will cause the smallest parameter list to be created.
- **MAX**, if you want the parameter list to be the largest size currently possible. This size might grow from release to release and affect the amount of storage that your program needs.

If you can tolerate the size change, IBM recommends that you always specify `PLISTVER=MAX` on the list form of the macro. Specifying `MAX` ensures that the list-form parameter list is always long enough to hold all the parameters you might specify on the execute form when both forms are assembled using the same level of the system. In this way, `MAX` ensures that the parameter list does not overwrite nearby storage.

- `0`, which supports all parameters except those specifically referenced in higher versions.

To code: Specify in this input parameter one of the following:

- `IMPLIED_VERSION`
- `MAX`
- A decimal value of 0, 1, 2, or 3

,RETCODE=retcode

Specifies a name (or address in a register) of a 4-byte output field where the system will place the return code. The return code is also in general purpose register (GPR) 15.

,RSNCODE=rsncode

Specifies a name (or address in a register) of a 4-byte output field where the system will place the reason code. The reason code is also in general purpose register (GPR) 0, if you received a non-zero return code.

,MF=S

,MF=(L,list addr)

,MF=(L,list addr,attr)

,MF=(L,list addr,OD)

,MF=(E,list addr)

,MF=(E,list addr,COMPLETE)

,MF=(E,list addr,NOCHECK)

,MF=(M,list addr)

,MF=(M,list addr,COMPLETE)

,MF=(M,list addr,NOCHECK)

Use `MF=S` to specify the standard form of the macro, which builds an inline parameter list and generates the macro invocation to transfer control to the service. `MF=S` is the default.

Use `MF=L` to specify the list form of the macro. Use the list form together with the execute form of the macro for applications that require reentrant code. The list form defines an area of storage that the execute form uses to store the parameters. Only the `PLISTVER` parameter can be specified on the list form of the macro. IBM recommends that you always specify `PLISTVER=MAX` on the list form of the macro.

Use `MF=E` to specify the execute form of the macro. Use the execute form together with the list form of the macro for applications that require reentrant code. The execute form of the macro stores the parameters into the storage area defined by the list form, and generates the macro invocation to transfer control to the service.

Use `MF=M` together with the list and execute forms of the macro for service routines that need to provide different options according to user-provided input. Use the list form to define a storage area; use the modify form to set the appropriate options; then use the execute form to call the service.

IBM recommends that you use the modify and execute forms in the following order:

- Use `MF=(M,list_addr,COMPLETE)`, specifying appropriate parameters, including all required ones.
- Use `MF=(M,list_addr,NOCHECK)`, specifying the parameters you want to change.
- Use `MF=(E,list_addr,NOCHECK)`, to execute the macro.

,list addr

The name of a storage area to contain the parameters.

,attr

An optional 1- to 60-character input string, which can contain any value that is valid on an assembler `DS` pseudo-op. You can use this parameter to force boundary alignment of the

parameter list. If you do not code *attr*, the system provides a value of 0D, which forces the parameter list to a doubleword boundary.

,COMPLETE

Specifies that the system is to check for required parameters and supply defaults for omitted optional parameters.

,NOCHECK

Specifies that the system is not to check for required parameters and is not to supply defaults for omitted optional parameters.

REQUEST=UPDATE option of IXGINVNT

The IXGINVNT macro with the UPDATE parameter allows a program to update a log stream entry in the active system logger couple data set policy for a coupling facility or DASD-only log stream. For a few parameters on the IXGINVNT REQUEST=UPDATE request, there must be not be any connections (active or failed) to the log stream being updated. Refer to each parameter description to determine whether an update is allowed and when it takes effect when there are log stream connections. For more details, see "Updating a log stream's attribute" in [z/OS MVS Programming: Assembler Services Guide](#).

Syntax for REQUEST=UPDATE

The standard form of the IXGINVNT REQUEST=UPDATE macro is written as follows:

Syntax	Description
<i>name</i>	<i>name</i> : symbol. Begin <i>name</i> in column 1.
	One or more blanks must precede IXGINVNT.
IXGINVNT	
	One or more blanks must follow IXGINVNT.
REQUEST=UPDATE	
,TYPE=LOGSTREAM	
,ANSAREA= <i>ansarea</i>	<i>ansarea</i> : RS-type address or register (2) - (12).
,ANSLEN= <i>anslen</i>	<i>anslen</i> : RS-type address or register (2) - (12).
,STREAMNAME= <i>streamname</i>	<i>streamname</i> : RS-type address or register (2) - (12).
,NEWSTREAMNAME= <i>newstreamname</i>	<i>newstreamname</i> : RS-type address or register (2) - (12).

Syntax	Description
,GROUP=PRODUCTION	Default: GROUP=PRODUCTION
,GROUP=TEST	
,STRUCTNAME= <i>structname</i>	<i>structname</i> : RS-type address or register (2) - (12).
,RMNAME= <i>rmname</i>	<i>rmname</i> : RS-type address or register (2) - (12).
,DESCRIPTION= <i>description</i>	<i>description</i> : RS-type address or register (2) - (12).
,MAXBUFSIZE= <i>maxbufsize</i>	<i>maxbufsize</i> : RS-type address or register (2) - (12).
,LOGGERDUPLEX=UNCOND	Default: LOGGERDUPLEX=UNCOND
,LOGGERDUPLEX= COND	
,STG_DUPLEX=NO	
,STG_DUPLEX=YES	
,DUPLEXMODE=COND	Default: DUPLEXMODE=COND
,DUPLEXMODE=UNCOND	
,DUPLEXMODE=DRXRC	
,STG_MGMTCLAS= <i>stg_mgmtclas</i>	
	<i>stg_mgmtclas</i> : RS-type address or register (2) - (12).
,STG_DATACLAS= <i>stg_dataclas</i>	<i>stg_dataclas</i> : RS-type address or register (2) - (12).
,STG_STORCLAS= <i>stg_storclas</i>	<i>stg_storclas</i> : RS-type address or register (2) - (12).
,STG_SIZE= <i>stg_size</i>	<i>stg_size</i> : RS-type address or register (2) - (12).
,LS_ALLOCAHEAD={ <i>xls_allocahead</i> *}	<i>xls_allocahead</i> : RS-type address or register (2) - (12).
	Default: *
,LS_MGMTCLAS= <i>ls_mgmtclas</i>	<i>ls_mgmtclas</i> : RS-type address or register (2) - (12).

Syntax	Description
,LS_DATACLAS= <i>ls_dataclas</i>	<i>ls_dataclas</i> : RS-type address or register (2) - (12).
,LS_STORCLAS= <i>ls_storclas</i>	<i>ls_storclas</i> : RS-type address or register (2) - (12).
,LS_SIZE= <i>ls_size</i>	<i>ls_size</i> : RS-type address or register (2) - (12).
,RETPD= <i>retpd</i>	<i>retpd</i> : RS-type address or register (2) - (12).
	Default: NO_RETPD
,AUTODELETE=NO	Default: AUTODELETE=NO
,AUTODELETE=YES	
,LOWOFFLOAD= <i>lowoffload</i>	<i>lowoffload</i> : RS-type address or register (2) - (12).
,HIGHOFFLOAD= <i>highoffload</i>	<i>highoffload</i> : RS-type address or register (2) - (12).
,WARNPRIMARY=NO <u>WARNPRIMARY</u>	Default: WARNPRIMARY=NO_WARNPRIMARY
,WARNPRIMARY=YES	
,WARNPRIMARY=NO	
,OFFLOADRECALL=NO	Default: OFFLOADRECALL=NO_OFFLOADRECALL
,OFFLOADRECALL=YES	
,DIAG=NO_DIAG	Default: DIAG=NO_DIAG
,DIAG=NO	
,DIAG=YES	
,ZAI=NO	Default: ZAI=NO
,ZAI=YES	
,ZAI=NO_ZAI	
,ZAIDATA=NO_ZAIDATA	Default: ZAIDATA=NO_ZAIDATA
,ZAIDATA=Xzaidata	
,PLISTVER=IMPLIED_VERSION	

Syntax	Description
,PLISTVER=MAX	Default: IMPLIED_VERSION
,PLISTVER=0	
,PLISTVER=1	
,PLISTVER=2	
,PLISTVER=3	
,RETCODE= <i>retcode</i>	<i>retcode</i> : RS-type address or register (2) - (12).
,RSNCODE= <i>rsncode</i>	<i>rsncode</i> : RS-type address or register (2) - (12).
,MF=S	Default: MF=S
,MF=(L, <i>list addr</i>)	
,MF=(L, <i>list addr,attr</i>)	
,MF=(L, <i>list addr,OD</i>)	
,MF=(E, <i>list addr</i>)	
,MF=(E, <i>list addr,COMPLETE</i>)	
,MF=(E, <i>list addr,NOCHECK</i>)	
,MF=(M, <i>list addr</i>)	
,MF=(M, <i>list addr,COMPLETE</i>)	
,MF=(M, <i>list addr,NOCHECK</i>)	

Parameters for REQUEST=UPDATE

The parameters are explained as follows:

REQUEST=UPDATE

Requests that an entry for a log stream be updated in the active system logger couple data set policy.

,TYPE=LOGSTREAM

Requests that the entry to be updated in the active system logger couple data set policy is a log stream entry.

,ANSAREA=*ansarea*

Specifies the name (or address in a register) of an answer area containing information about this request. The answer area must be at least 40 bytes. To map this information, use the IXGANSAA macro.

,ANSLEN=*anslen*

Specifies the name (or address in a register) of the 4-byte field containing the answer area length. The length of the answer area must be at least 40 bytes and must be the same length as the field specified in ANSAREA.

To ascertain the optimal answer area length, look at the ANSAA_PREFERRED_SIZE field of the IXGANSAA macro.

,STREAMNAME=streamname

Specifies the name (or address in a register) of the 26-byte input field containing the name of the log stream that you want to update in the active system logger couple data set policy.

The stream name must be 26 characters, padded on the right with blanks if necessary. The name can be made up of one or more segments separated by periods, up to the maximum length of 26 characters. The following rules apply:

- Each segment can contain up to eight numeric, alphabetic, or national (\$, #, or @) characters.
- The first character of each segment must be an alphabetic or national character.
- Each segment must be separated by periods, which you must count as characters.

STREAMNAME is required with the TYPE=LOGSTREAM parameter.

NEWSTREAMNAME={newstreamname|NO_NEWSTREAMNAME}

Specifies a new name for the log stream identified in the STREAMNAME parameter. With this keyword, you can maintain the current data in a log stream under a new name and get new work going after timely defining a new instance of the log stream with the original name. This keyword is the name (RS-type), or address in register (2)-(12), of an optional 26 character input that specifies the new name that should be assigned to the log stream being updated as identified on the STREAMNAME parameter.

The new log stream name must be 26 characters long, padded on the right with blanks if necessary. Lowercase alphabetic characters will be folded to uppercase. The name is made up of one or more segments, up to the maximum length of 26 characters. Each segment can validly contain 1-8 numeric characters, alphabetic characters, or national (\$, #, @) characters. Segments are joined by periods. The first character of each segment must be an alphabetic or national (\$, #, @) character.

For detailed description about this keyword, see [Renaming a log stream dynamically in z/OS MVS Setting Up a Sysplex](#).

Omitting the NEWSTREAMNAME parameter will not affect the current name of the log stream. If NO_NEWSTREAMNAME is specified for NEWSTREAMNAME, the macro will be invoked as if the NEWSTREAMNAME parameter was not specified.

The default is NO_NEWSTREAMNAME.

GROUP=(PRODUCTION | TEST)

An optional keyword input that lets you specify whether the log stream is in the test group or the production group. This keyword allows you to keep processing and resources for log streams in the two groups separate on a single system, including requests such as data set allocation and data set recalls. If the TEST group fails, the failure does not normally affect the PRODUCTION group. You can only specify the GROUP parameter on an UPDATE request when:

- The LOGR couple data set for the sysplex is formatted at the HBB7705 level or higher.
- The structure has no log streams, failed or active, connected. (The request will fail with return code 8, reason code X'0810' if there are connectors to the structure.)

If you specify GROUP(PRODUCTION), System logger places this log stream in the PRODUCTION group. A PRODUCTION log stream can use at least 75% of the system logger couple data set DSEXTENT records and connection slots.

If you specify GROUP(TEST), system logger places this log stream in the TEST group. TEST log streams are limited to at most 25% of the system logger couple data set DS EXTENT records and connection slots.

The GROUP value you specify must match the group setting for the structure that the log stream is being defined for, because system logger does not allow you to define a mixture of TEST and PRODUCTION log streams to a single structure. When you define the first log stream to a structure, the structure becomes either a TEST or PRODUCTION structure. After that, the GROUP value for subsequent log streams defined to a structure must match the GROUP value of the initial log stream. For example, if you specify or default to GROUP(PRODUCTION) for the first log stream defined to a

structure, you will only be able to define PRODUCTION log streams to that structure subsequently. See “[Example 11](#)” on page 732.

If you update a log stream from PRODUCTION to TEST, this might affect the DS EXTENT records allocation because the limit changes from 75% to 25% of the system logger couple data set DS EXTENT records and connection slots. The system will issue message IXC270I indicating that there is a shortage of DS EXTENT records for TEST log streams. If you update a log stream from TEST to PRODUCTION, more DS EXTENTS will be available to the log stream and message IXG270I might be DOMed.

To update the log stream GROUP type for an existing structure, you need to take one of the following actions:

- Remove all of the log streams from the structure and define a log stream of the desired type to the structure. The log stream will accept only log streams of that type in the future.
- Issue an update request against the last remaining structure in a group to change it to the desired GROUP.

,STRUCTNAME=structname

With REQUEST=UPDATE, specifies the name (or address in a register) of a 16-byte input field containing the name of the coupling facility list structure where all of this log stream's log blocks will be written before being offloaded to DASD. This keyword is allowed when there are no connections (failed or active) to the log stream in the sysplex; otherwise the UPDATE request will be rejected with return code 8, reason code X'0810'.

This keyword can be specified when the existing log stream to be modified is a DASD only log stream. With specification of this keyword, the DASD only log stream will be upgraded to use a coupling facility structure and become a structure-based log stream.

When the active primary LOGR couple data set in the sysplex is formatted at a HBB7705 level or higher, this keyword can also be specified for a log stream that is currently structure-based in order to update the log stream to use a different coupling facility structure. If the LOGR couple data set is not formatted at the appropriate level, the request will fail with return code 8, reason code X'0839'.

STRUCTNAME must be 16 alphanumeric or national (\$,#,or @) characters, or underscore (_), padded on the right with blanks if necessary. Lowercase alphabetic characters will be folded to uppercase. The first character must be alphabetic.

Note that the MAXBUFSIZE value in the structure definition for this structure must be equal to or greater than the MAXBUFSIZE specified for the log stream before the update. Otherwise, the UPDATE request will be rejected with a return code 8, reason code X'083C'.

,RMNAME=rmname

Specifies the name (or address in a register) of the 8-byte input field containing the name of the resource manager program associated with the log stream. RNAME must be 8 alphanumeric or national (\$,#,or @) characters, padded on the right with blanks if necessary.

You must define RMNAME in the LOGR policy before the recovery resource manager can connect to the log stream.

If you specify RMNAME to associate a resource manager with a log stream in the LOGR policy, the resource manager specified must subsequently connect to the log stream. If the resource manager does not connect to that log stream, system logger will not process any IXGDELET requests to delete log data. This is so that the resource manager will not miss any delete requests issued against the log stream.

,DESCRIPTION=description

Specifies the name (or address in a register) of the 16 character input field containing user defined data describing the log stream.

DESCRIPTION must be 16 alphanumeric or national (\$,#,@) characters, underscore (_) or period (.), padded on the right with blanks if necessary.

,MAXBUFSIZE=*maxbufsize*

Specifies the name (or address in a register) of a fullword input field that contains the size, in bytes, of the largest log block that can be written to this DASD-only log stream.

The value for MAXBUFSIZE must be between 1 and 65,532 bytes and cannot be less than the current MAXBUFSIZE for the DASD-only log stream.

This keyword can be updated even when the log stream is actively connected when the LOGR couple data set is at least at the HBB7705 format level. The change will be immediately reflected in the log stream definition, but will not take effect until the subsequent first connection to the DASD-only log stream in the sysplex.

There is no default for the MAXBUFSIZE parameter on an UPDATE request. If you omit this parameter, there will be no change to the MAXBUFSIZE value for this log stream definition.

,LOGGERDUPLEX=UNCOND**,LOGGERDUPLEX=COND**

An optional input keyword specifies whether system logger continues to provide its own log data duplexing, or, conditionally, not provide its own duplexing based on an alternative duplexing configuration that provides an equivalent or better recoverability of the log data.

The active primary TYPE=LOGR couple data set in the sysplex must be formatted at HBB7705 or higher to specify this keyword. Otherwise, the request fails with a return code 8, reason code X'0839'.

For DASD only log streams:

You are allowed to specify LOGGERDUPLEX(UNCOND), however, it will have no effect on the log stream as DASD only log streams are unconditionally duplexed to staging data sets. If you specify LOGGERDUPLEX(COND), the request will fail unless you are upgrading a DASD only log stream to a coupling facility log stream.

This keyword can be specified even when the log stream is actively connected when the LOGR couple data set is formatted at HBB7705 or higher. If a lower format level LOGR couple data set is being used, the request will fail with a return code 8, reason code X'0810'.

The change will be immediately reflected in the log stream definition. It will take effect on the subsequent first connection to the log stream in the sysplex or following a successful coupling facility user-managed structure rebuild.

Omitting the Update log stream LOGGERDUPLEX parameter will not change how system logger handles the duplexing of the log stream's log data.

See *z/OS MVS Setting Up a Sysplex* sections "logger and Coupling Facility Duplexing Combinations" and "System logger Recovery" for additional considerations on using the LOGGERDUPLEX keyword. Refer to Case 5 in *Logger and coupling facility duplexing combinations in z/OS MVS Setting Up a Sysplex* for additional details about the LOGGERDUPLEX parameter and a coupling facility log stream.

LOGGERDUPLEX=UNCOND, which is the default, indicates that system logger should provide its own specific duplexing of the log data regardless of any other duplexing (such as structure -system-managed duplexing rebuild) that occur.

LOGGERDUPLEX=COND indicates that system logger should provide its own specific duplexing of the log data unless the log stream is in an alternative duplexing configuration that provides an equivalent or better recoverability of the log data. For example, system logger does not provide its own duplexing of the log data in the following configuration:

- when the log stream is in a non-volatile CF list structure that is handled by system-managed duplexing rebuild. (duplex-mode),
- there is a failure-independent relationship between the two structure instances, and
- there is a failure-independent connection between connecting system and composite structure view.

,STG_DUPLEX=NO**,STG_DUPLEX=YES**

Specifies whether the log stream data for a coupling facility log stream should be considered for duplexing in DASD staging data sets.

This keyword can be specified even when the log stream is actively connected when the LOGR couple data set is at least at the HBB7705 format level. If a lower format level LOGR couple data set is being used, the request will fail with return code 8, reason code X'0810'.

The change will be immediately reflected in the log stream definition. It will take effect on the subsequent first connection to the log stream in the sysplex or following a successful coupling facility user-managed structure rebuild.

If you specify STG_DUPLEX=NO, log data for a coupling facility log stream is not duplexed in staging data sets, regardless of the failure independence/dependence coupling facility. The coupling facility resident log data will be duplexed in the local buffers of the z/OS Version 1 Release 7 and higher release levels, with z/OS image that wrote the data. A coupling facility is considered failure independent when it is non-volatile and resides on a different CPC from the MVS image using it. Otherwise, the coupling facility is failure dependent.

If you specify STG_DUPLEX=YES, the log data for a coupling facility log stream will be duplexed in staging data sets if the conditions defined by the DUPLEXMODE keyword are fulfilled.

For DASD only log streams:

You are allowed to specify STG_DUPLEX=YES, however, it will have no effect on the log stream as DASD only log streams are unconditionally duplexed to staging data sets. If you specify STG_DUPLEX=NO, the request will fail unless you are upgrading a DASD only log stream to a coupling facility log stream.

There is no default for the STG_DUPLEX keyword on an UPDATE request. If you omit this keyword, there is no change to the staging duplexing status for the log stream definition.

You can use the DUPLEXMODE keyword with STG_DUPLEX and with LOGGERDUPLEX to specify the type of duplexing desired and whether you want conditional or unconditional duplexing by logger.

,DUPLEXMODE=COND**,DUPLEXMODE=UNCOND**

Specifies the conditions under which the coupling facility log data for a coupling facility log stream should be duplexed in DASD staging data sets.

If you specify DUPLEXMODE=COND, the coupling facility log data will be duplexed in staging data sets only if a system's connection to the coupling facility log stream contains a single point of failure and is therefore vulnerable to permanent log data loss:

- A connection to a log stream contains a single point of failure if the coupling facility is volatile and/or resides on the same CPC as the MVS system connecting to it. The coupling facility log data for the system connection containing the single point of failure will be duplexed to staging data sets..
- A connection to a log stream is failure-independent when the coupling facility for the log stream is non-volatile and resides on a different central processor complex (CPC) than the MVS system connecting to it. The coupling facility log data for that system connection will not be duplexed to staging data sets..

If you specify DUPLEXMODE=UNCOND, the log data for the coupling facility log stream will be duplexed in staging data sets, unconditionally, even if the connection is failure independent.

Note: If DUPLEXMODE(DRXRC) is specified, the log data is duplexed same as if the COND option is specified. This means that in staging data sets, if a system's connection to the coupling facility log stream contains a single point of failure, it is therefore vulnerable to permanent log data loss. For more information, see the CONF DUPLEXMODE option.

Note: The staging data set keywords STG_SIZE, STG_DATACLAS, STG_MGMTCLAS, and STG_STORCLAS will remain set for the log stream and can be used for any dynamic staging data set allocation during local recovery even after the conversion to STG_DUPLEX=NO.

This keyword can be specified even when the log stream is actively connected when the LOGR couple data set is at least at the HBB7705 level. If a lower format level LOGR couple data set is being used, the request will fail with return code 8, reason code X'0810'.

The change will be immediately reflected in the log stream definition. It will take effect on the subsequent first connection to the log stream in the sysplex or following a successful coupling facility user-managed structure rebuild.

There is no default for the DUPLEXMODE keyword on an UPDATE request. If you omit this keyword, there will be no change to the duplexing mode for the coupling facility log stream definition.

You can use the DUPLEXMODE keyword with STG_DUPLEX and with LOGGERDUPLEX to specify the type of duplexing desired and whether you want conditional or unconditional duplexing by logger.

See *z/OS MVS Programming: Assembler Services Guide* for complete information about using staging data sets to duplex coupling facility log data.

DUPLEXMODE is valid only when STG_DUPLEX=YES has been specified for a coupling facility log stream.

For DASD only log streams, you are allowed to specify DUPLEXMODE=UNCOND, however, it will have no effect on the log stream as DASD only log streams are unconditionally duplexed to staging data sets. If you specify DUPLEXMODE=COND, the request will fail unless you are upgrading a DASD only log stream to a coupling facility log stream.

Note: DUPLEXMODE may only be updated for a log stream that uses staging datasets. See STG_DUPLEX keyword.

,STG_DATACLAS=stg_dataclas

Specifies the name (or address in a register) of an 8-byte input field containing the name of the SMS data class that will be used for allocation of the DASD staging data set for this log stream.

The data class must be 8 alphanumeric or national (\$, #, or @) characters, padded on the right with blanks if necessary. The first character must be an alphabetic or national character.

This keyword can be updated even when the log stream is actively connected when the LOGR couple data set is at least at the HBB7705 format level. If a lower format level LOGR couple data set is being used, the request will fail with return code 8, reason code X'0810'. The change will be immediately reflected in the log stream definition. It will take effect on the subsequent first connection to the log stream in the sysplex. For a structure-based log stream, the change will also take effect during the next structure rebuild. The changed STG_DATACLAS attribute will be used when a new staging data set needs to be created for the log stream.

An SMS value specified on the STG_DATACLAS parameter, including NO_STG_DATACLAS, **always** overrides one specified on a model log stream used on the LIKE parameter.

There is no default for the STG_DATACLAS parameter on an UPDATE request. If you omit this parameter, there will be no change to the data class for staging data sets for this log stream definition.

STG_DATACLAS is only valid with STG_DUPLEX=YES or DASDONLY=YES.

,STG_MGMTCLAS=stg_mgmtclas

Specifies the name (or address in a register) of an 8-byte input field containing the name of the SMS management class that will be used for allocation of the DASD staging data set for this log stream.

The management class must be 8 alphanumeric or national (\$, #, or @) characters, padded on the right with blanks if necessary. The first character must be an alphabetic or national character.

This keyword can be updated even when the log stream is actively connected when the LOGR couple data set is at least at the HBB7705 format level. If a lower format level LOGR couple data set is being used, the request will fail with return code 8, reason code X'0810'. The change will be immediately reflected in the log stream definition. It will take effect on the subsequent first connection to the log stream in the sysplex. For a structure-based log stream, the change will also take effect during the next structure rebuild. The changed STG_MGMTCLAS attribute will be used when a new staging data set needs to be created for the log stream.

An SMS value specified on the STG_MGMTCLAS parameter, including NO_STG_MGMTCLAS, **always** overrides one specified on a model log stream used on the LIKE parameter.

There is no default for the STG_MGMTCLAS parameter on an UPDATE request. If you omit this parameter, there will be no change to the management class for staging data sets for this log stream definition.

STG_MGMTCLAS is only valid with STG_DUPLEX=YES or DASDONLY=YES.

,STG_STORCLAS=stg_storclas

Specifies the name (or address in a register) of an 8-byte input field containing the name of the SMS storage class that will be used for allocation of the DASD staging data set for this log stream.

The storage class must be 8 alphanumeric or national (\$, #, or @) characters, padded on the right with blanks if necessary. The first character must be an alphabetic or national character.

This keyword can be updated even when the log stream is actively connected when the LOGR couple data set is at least at the HBB7705 format level. If a lower format level LOGR couple data set is being used, the request will fail with return code 8, reason code X'0810'. The change will be immediately reflected in the log stream definition. It will take effect on the subsequent first connection to the log stream in the sysplex. For a structure-based log stream, the change will also take effect during the next structure rebuild. The changed STG_STORCLAS attribute will be used when a new staging data set needs to be created for the log stream.

An SMS value specified on the STG_STORCLAS parameter, including NO_STG_STORCLAS, **always** overrides one specified on a model log stream used on the LIKE parameter.

There is no default for the STG_STORCLAS parameter on an UPDATE request. If you omit this parameter, there will be no change to the storage class for staging data sets in this log stream definition.

STG_STORCLAS is only valid with STG_DUPLEX=YES or DASDONLY=YES.

,STG_SIZE=stg_size

Specifies the name (or address in a register) of a 4-byte input field containing the size, in 4K blocks, of the DASD staging data set for the log stream being updated.

The actual size of your data set depends on many factors including track size, CI SIZE, and volume type, and may be smaller or larger than your parameter inputs expect. Because of this reason, see "Testing log data set parameter modifications" in *z/OS MVS Setting Up a Sysplex* for important notes on choosing a data set size.

Specifying STG_SIZE=0, will cause logger to make use of the SMS data class space allocation attribute of the new (if STG_DATACLAS is specified on the update) or existing STG_DATACLAS, or dynamic allocation rules if STG_DATACLAS is not specified for DASD-only log streams, or the maximum structure size if STG_DATACLAS is not CF log streams.

Specifying STG_SIZE overrides the space allocation attribute on the STG_DATACLAS parameter if STG_DATACLAS is specified on this update, a previous update, or define.

This keyword can be updated even when the log stream is actively connected when the LOGR couple data set is at least at the HBB7705 format level. If a lower format level LOGR couple data set is used, the request will fail with return code 8, reason code X'0810'. The change will be immediately reflected in the log stream definition as a "pending update". It will take effect on the subsequent first connection to the log stream in the sysplex. For a structure-based log stream, the change will also take effect during the next structure rebuild. The changed STG_SIZE attribute will be used when a new staging data set needs to be created for the log stream.

Omitting this parameter causes the previous specification to remain in effect.

As of z/OS Version 2 Release 3, system logger supports staging data set sizes greater than 4GB. Use the STG_DATACLAS log stream specification and define the corresponding DFSMS data class with space allocation attributes and include in the data class definition the following attributes:

- Data Set Name Type "EXT" (extended format)

- Extended Addressability "Y"

Extended format is a means of storing data on a logical DASD volume. Extended addressability is a means to allow VSAM Data Sets greater addressability beyond the 4GB address constraint.

For more information about planning and sizing for staging data sets, see [Plan space for staging data sets](#) and [Set up the SMS environment for DASD data sets in z/OS MVS Setting Up a Sysplex](#).

LS_ALLOCAHEAD(xls_allocahead | *)

Specifies whether offload data sets should be proactively allocated and opened in advance on systems connected to the log stream. It is the name (or address in a register) of an optional full-word input. The xls_allocahead value can be from 0 to 3.

The active primary TYPE=LOGR couple data set must be formatted at an HBB7705 or higher format level to specify this keyword. Otherwise, the request fails with return code 8 and reason code X'0839'. See "LOGR parameters for format utility" in [z/OS MVS Setting Up a Sysplex](#) for more information.

When the value is 0, logger does not proactively allocate and open advanced-current log stream offload data sets on any systems that are connected to the log stream.

When the value is between 1 and 3 (inclusively), all systems that are connected to and performing offloads for the log stream should be proactive in newly allocating up to the intended number (xls_allocahead) of advanced-current offload data sets. It also indicates these systems are proactive in opening the current offload data set as well as the first advanced-current offload data set. The logger processing is potentially affected on a system with the ALLOCAHEAD(NO) IXGCNFxx parmlib policy specification. See the IXGCNFxx parmlib member in [z/OS MVS Initialization and Tuning Reference](#) for more information about the MANAGE OFFLOAD ALLOCAHEAD specification. Also see "Offloading log data from interim storage by freeing and/or moving it to DASD" in [z/OS MVS Setting Up a Sysplex](#) for more information about the logger behavior based on the ALLOCAHEAD and LS_ALLOCAHEAD parameters.

This keyword can be updated even when the log stream is actively connected. The change is immediately reflected as a pending update in the log stream definition. It takes effect when the next log stream offload data set is allocated (data set switch event) or on the subsequent first connection to the log stream in the sysplex. For a structure-based log stream, the change also takes effect during the next structure rebuild. The new value is used on the subsequent log stream offload activity after the value takes effect.

The default is *. Omitting the parameter LS_ALLOCAHEAD results no change to the value for this log stream definition.

,LS_DATACLAS=ls_dataclas

Specifies the name (or address in a register) of an 8-byte input field containing the name of the SMS data class that will be used for allocation of the DASD log data set for this log stream.

The data class must be 8 alphanumeric or national (\$,#, or @) characters, padded on the right with blanks if necessary. The first character must be an alphabetic or national character.

This keyword can be updated even when the log stream is actively connected when the LOGR couple data set is at least at the HBB7705 format level. If a lower format level LOGR couple data set is being used, the request will fail with return code 8, reason code X'0810'. The change will be immediately reflected in the log stream definition. It will take effect when the next log stream offload data set is allocated (data set switch event) or on the subsequent first connection to the log stream in the sysplex. For a structure-based log stream, the change will also take effect during the next structure rebuild.

An SMS value specified on the LS_DATACLAS parameter, including NO_LS_DATACLAS, **always** overrides one specified on a model log stream used on the LIKE parameter.

There is no default for the LS_DATACLAS parameter on an UPDATE request. If you omit this parameter, there will be no change to the data class for the log stream data sets for this log stream definition.

,LS_MGMTCLAS=ls_mgmtclas

Specifies the name (or address in a register) of an 8-byte input field containing the name of the SMS management class that will be used for allocation of the DASD log data set for this log stream.

The management class must be 8 alphanumeric or national (\$, #, or @) characters, padded on the right with blanks if necessary. The first character must be an alphabetic or national character.

This keyword can be updated even when the log stream is actively connected when the LOGR couple data set is at least at the HBB7705 format level. If a lower format level LOGR couple data set is being used, the request will fail with return code 8, reason code X'0810'. The change will be immediately reflected in the log stream definition. It will take effect when the next log stream offload data set is allocated (data set switch event) or on the subsequent first connection to the log stream in the sysplex. For a structure-based log stream, the change will also take effect during the next structure rebuild.

An SMS value specified on the LS_MGMTCLAS parameter, including NO_LS_MGMTCLAS, **always** overrides one specified on a model log stream used on the LIKE parameter.

There is no default for the LS_MGMTCLAS parameter on an UPDATE request. If you omit this parameter, there will be no change to the management class for the log stream data sets for this log stream definition.

,LS_STORCLAS=ls_storclas

Specifies the name (or address in a register) of an 8-byte input field containing the name of the SMS storage class that will be used for allocation of the DASD log data set for this log stream.

The storage class must be 8 alphanumeric or national (\$, #, or @) characters, padded on the right with blanks if necessary. The first character must be an alphabetic or national character.

This keyword can be updated even when the log stream is actively connected when the LOGR couple data set is at least at the HBB7705 format level. If a lower format level LOGR couple data set is being used, the request will fail with return code 8, reason code X'0810'. The change will be immediately reflected in the log stream definition. It will take effect when the next log stream offload data set is allocated (data set switch event) or on the subsequent first connection to the log stream in the sysplex. For a structure-based log stream, the change will also take effect during the next structure rebuild.

An SMS value specified on the LS_STORCLAS parameter, including NO_LS_STORCLAS, **always** overrides one specified on a model log stream used on the LIKE parameter.

There is no default for the LS_STORCLAS parameter on an UPDATE request. If you omit this parameter, there will be no change to the storage class for the log stream data sets for this log stream definition.

,LS_SIZE=ls_size

Specifies the size, in 4K blocks, of the log stream offload DASD data sets for the log stream being updated.

The actual size of your data set depends on many factors including track size, CI SIZE, and volume type, and may be smaller or larger than your parameter inputs expect. Because of this reason, see "Testing log data set parameter modifications" in *z/OS MVS Setting Up a Sysplex* for important notes on choosing a data set size.

Specifying LS_SIZE=0 will cause logger to make use of the SMS data class space allocation attribute of the new (if LS_DATACLAS is specified on the update) or existing LS_DATACLAS, or dynamic allocation rules if LS_DATACLAS is not specified.

Specifying LS_SIZE overrides the space allocation attribute on the LS_DATACLAS parameter if LS_DATACLAS is specified on this update, a previous update, or define.

This keyword can be updated even when the log stream is actively connected when the LOGR couple data set is at least at the HBB7705 format level. If a lower format level LOGR couple data set is being used, the request will fail with return code 8, reason code X'0810'. The change will be immediately reflected in the log stream definition. It will take effect when the next log stream offload data set is allocated (data set switch event) or on the subsequent first connection to the log stream in the sysplex. For a structure-based log stream, the change will also take effect during the next structure rebuild.

Omitting this parameter causes the previous specification to remain in effect.

,AUTODELETE=NO**,AUTODELETE=YES**

Specifies when system logger physically deletes log data from the log stream.

This keyword can be updated regardless of whether the log stream is actively connected or not. The change will be immediately reflected in the log stream definition. It will take effect upon the next data set switch event or on the subsequent first connection to the log stream in the sysplex.

If you specify AUTODELETE=NO, which is the default, system logger physically deletes an entire log data set only when **both** of the following are true:

- Data is marked for deletion by a system logger application using the IXGDELET service.
- The retention period for all the data in the log data set expires.

If you specify AUTODELETE=YES, system logger automatically physically deletes log data whenever data is either marked for deletion (using the IXGDELET service or an archiving procedure) or the retention period for all the log data in a data set has expired.

Be careful when using AUTODELETE=YES if the system logger application manages log data deletion using the IXGDELET service. With AUTODELETE=YES, system logger can delete data that the application expects to be accessible.

RETPD=0**RETPD=*retpd***

Specifies the name (or address in a register) of a fullword input field containing the number of days of the retention period for log data in the log stream. The retention period begins when data is written to the log stream. Once the retention period for an entire log data set has expired, the data set is eligible for physical deletion. The point at which system logger physically deletes the data depends on what you have specified on the AUTODELETE parameter. System logger will not process a retention period or delete data on behalf of log streams that are not connected to or being written to by an application.

This keyword can be updated regardless of whether the log stream is actively connected or not. The change will be immediately reflected in the log stream definition. It will take effect upon the next data set switch event or on the subsequent first connection to the log stream in the sysplex.

The value specified for RETPD must be between 0 and 65,536.

,LOWOFFLOAD=*lowoffload*

Specifies the name (or address in a register) of a fullword input field containing the percent value you want to use as the low offload threshold for the coupling facility structure associated with this log stream. The low offload threshold is the target percent where you want offloading to stop, leaving approximately the specified LOWOFFLOAD percentage of log data in the coupling facility structure.

The value specified for LOWOFFLOAD must be less than the HIGHOFFLOAD value.

This keyword can be updated even when the log stream is actively connected when the LOGR couple data set is at least at the HBB7705 format level. If a lower format level LOGR couple data set is being used, the request will fail with return code 8, reason code X'0810'. The change will immediately be reflected in the log stream definition. It will take effect on the subsequent first connection to the log stream in the sysplex. For a structure-based log stream, the change will also take effect during the next structure rebuild. For a DASD-only log stream, the change will take effect upon the next offload data set switch event.

There is no default for the LOWOFFLOAD parameter on an UPDATE request. If you omit this parameter, there will be no change to the low offload value for this log stream definition.

,HIGHOFFLOAD=*highoffload*

Specifies the name (or address in a register) of a fullword input field containing the percent value you want to use as the high offload threshold for the coupling facility structure associated with this log stream. When the coupling facility is filled to the high offload threshold point or beyond, system logger begins offloading data from the coupling facility to the DASD log stream data sets.

IBM recommends that you are careful in considering to define your HIGHOFFLOAD value to greater than 80%. Defining a higher high offload threshold can leave you vulnerable to filling your coupling

facility space for the log stream, which means that system logger will reject all write requests until the coupling facility log data can be offloaded to DASD log data sets.

The value specified for HIGHOFFLOAD must be higher than the LOWOFFLOAD value.

This keyword can be updated even when the log stream is actively connected when the LOGR couple data set is at least at the HBB7705 format level. If a lower format level LOGR couple data set is being used, the request will fail with return code 8, reason code X'0810'. The change will immediately be reflected in the log stream definition. It will take effect on the subsequent first connection to the log stream in the sysplex. For a structure-based log stream, the change will also take effect during the next structure rebuild. For a DASD-only log stream, the change will take effect upon the next offload data set switch event.

There is no default for the HIGHOFFLOAD parameter on an UPDATE request. If you omit this parameter, there will be no change to the high offload value for this log stream definition.

,WARNPRIMARY=NO WARNPRIMARY

,WARNPRIMARY=YES

,WARNPRIMARY=NO

is an optional keyword input that specifies whether monitoring warning messages should be issued based on the log stream primary (interim) storage consumption above the HIGHOFFLOAD value.

The active primary TYPE=LOGR couple data set must be formatted at an HBB7705 (or higher) format level in order to specify WARNPRIMARY=YES. Otherwise, the request will fail with return code 8, reason code X'0839'. See 'LOGR parameters for format utility' in *z/OS MVS Setting Up a Sysplex* for more details.

This keyword can be updated even when the log stream is actively connected. The change will be immediately reflected as a pending update in the log stream definition. It will take effect on the subsequent first connection to the log stream in the sysplex. For a structure-based log stream, the change will also take effect during the next (user-managed or system-managed) structure rebuild. For a DASD-only log stream, the change will also take effect upon the next offload data set switch event.

DEFAULT: NO_WARNPRIMARY

NO_WARNPRIMARY

If you omit keyword WARNPRIMARY or specify the NO_WARNPRIMARY (default update) option, there will be no change to the WARNPRIMARY specification for this log stream definition.

NO

Indicates that the primary storage consumption monitoring warning messages will not be issued for the log stream.

YES

Indicates that log stream monitoring warning messages should be issued for the following conditions:

- When the log stream primary (interim) storage consumption is 2/3 between the HIGHOFFLOAD value and 100% full (rounded down to the nearest whole number). This is called the log stream imminent alert threshold.

That is, assume the default value is used for the HIGHOFFLOAD percentage. That would mean a HIGHOFFLOAD value of 80 would be used, so the warning messages would be triggered for this case at $(2(100 - 80)/3 + 80) = 93\%$.

- For a CF based log stream, when a 90% entry full condition is encountered.
- When an interim (primary) storage full condition is encountered.

For more details on the messages and monitoring primary storage consumption, see *z/OS MVS Setting Up a Sysplex*.

Note: The value can be overridden on the system level by logger parameter options for IXGCNF keyword CONSUMPTIONALERT(SUPPRESS).

,OFFLOADRECALL=NO OFFLOADRECALL**,OFFLOADRECALL=YES****,OFFLOADRECALL=NO**

Specifies whether or not offload processing is to skip recalling the current offload data set.

This keyword can be updated even when the log stream is actively connected. The change will immediately be reflected in the log stream definition. It will take effect on the subsequent first connection to the log stream in the sysplex. For a structure-based log stream, the change will also take effect during the next structure rebuild.

Specifying OFFLOADRECALL=NO_OFFLOADRECALL indicates that the OFFLOADRECALL attribute of the log stream should not be updated.

Specifying OFFLOADRECALL=YES indicates that offload processing should recall the current offload data set.

Specifying OFFLOADRECALL=NO indicates that offload processing should not recall the current offload data set and allocate a new one. Also with this setting, logger will not wait on any ENQ serialization contention to be resolved and will receive a class 2 type error (unavailable system resource) as described in *z/OS MVS Programming: Authorized Assembler Services Guide* in topic Interpreting error reason codes from DYNALLOC

Note that this option can cause any or all of the current offload data set to be wasted space on DASD once it is recalled. Care should be taken when using this option to size the data sets appropriately.

,DIAG=NO DIAG**,DIAG=NO****,DIAG=YES**

Specifies whether or not dumping or additional diagnostics should be provided by logger for certain conditions. See the DIAG keyword on the IXGCONN, IXGBRWSE and IXGDELET macro services.

If you specify DIAG=NO, which is the default, no special logger diagnostic activity is requested for this logstream regardless of the DIAG specifications on the IXGCONN, IXGDELET and IXGBRWSE requests.

Specifying DIAG=YES indicates that special logger diagnostic activity is allowed for this log stream:

- Informational LOGREC software symptom records (denoted by RETCODE VALU/H00000004) as well as other external alerts highlighting suboptimal conditions. For additional details, see *z/OS MVS Diagnosis: Reference*, "Enabling additional log stream diagnostics".
- When the appropriate specifications are provided on IXGCONN, IXGDELET or IXGBRWSE requests by the exploiting application, further additional diagnostics may be captured. See *z/OS MVS Programming: Assembler Services Guide*, "Dumping on data loss (804-type) conditions" for more details.

,ZAI=NO ZAI**,ZAI=NO****,ZAI=YES**

Optional keyword that specifies whether the log stream data should be included in the z/OS IBM zAware log stream client data sent to the IBM zAware server.

The active primary TYPE=LOGR couple data set must be formatted at the HBB7705 format level or higher in order to specify ZAI=YES. Otherwise, the request will fail with return code 8, reason code X'0839'. See 'LOGR parameters for format utility' in *z/OS MVS Setting Up a Sysplex* for more details.

This parameter can be updated while there is an outstanding connection to the log stream. In this case, the change will immediately be reflected in the log stream definition. The updated specification will take effect on the following logger events for this log stream:

1. On the subsequent first connection to the log stream on a system.
2. As a result of a SETLOGR FORCE.ZAICONN.LSN= command on the target system, or
3. As a result of a SETLOGR FORCE.ZAICONN.ALL command when there is a connection to this log stream currently using the ZAI=YES setting on the target system.

Note: Because the updated value can be used on a system by system basis, the installation should ensure the proper actions are taken on all the systems with connections to the log stream in order to make use of the current value.

If you specify NO_ZAI, you omit this keyword or specify the NO_ZAI (default) option, there will be no change to the ZAI specification for this log stream definition.

If you specify NO, it indicates that the log stream data will not be included in data sent from this z/OS IBM zAware log stream client to the IBM zAware server.

If you specify YES, it indicates that the log stream data will be included in data sent to the IBM zAware server provided the z/OS IBM zAware log stream client is established. See [Preparing for z/OS IBM zAware log stream client usage in z/OS MVS Setting Up a Sysplex](#) for more details on establish and using z/OS IBM zAware log stream clients. Also refer to the ZAIDATA keyword.

ZAIDATA=NO_ZAIDATA

ZAIDATA=Xzaidata

Is the name (RS-type), or address in register (2)-(12), of an optional 48 character input that specifies a value, if any, to be passed to the IBM zAware server when the z/OS IBM zAware log stream client is established (refer to ZAI=YES keyword specification).

The value you specify is defined by and must match the intended log data type capabilities of the IBM zAware server. See [Preparing for z/OS IBM zAware log stream client usage in z/OS MVS Setting Up a Sysplex](#) for more details on establishing and using z/OS IBM zAware log stream clients.

The active primary TYPE=LOGR couple data set must be formatted at the HBB7705 format level or higher in order to specify the ZAIDATA keyword option. Otherwise, the request will fail with return code 8, reason code X'0839'. See 'LOGR parameters for format utility' in [z/OS MVS Setting Up a Sysplex](#) for more details.

This parameter can be updated while there is an outstanding connection to the log stream. For this case, the change will immediately be reflected in the log stream definition. The updated specification will take effect on the following logger events for this log stream:

1. On the subsequent first connection to the log stream on a system.
2. As a result of a SETLOGR FORCE.ZAICONN.LSN= command on the target system, or
3. As a result of a SETLOGR FORCE,ZAICONN.ALL command when there is a connection to this log stream currently using the ZAI=YES setting on the target system.

Note: Since the updated value can be used on a system by system basis, the installation should ensure the proper actions are taken on all the systems with connections to the log stream in order to make use of the current value.

Specifying NO_ZAIDATA indicates that a null value will be used for the log stream ZAIDATA attribute.

Specifying Xzaidata indicates the name of the input variable containing the value. The value must be 48 characters long and padded on the right with blanks if necessary.

Valid characters are alphanumeric or national (\$, #, @) characters, and any of the special (graphical) characters listed below. Lower case alphabetic characters will be folded to upper case. Any other character will be converted into an EBCDIC blank X'40'. Valid special (graphical) characters:

<i>Table 40. Valid special (graphical) characters:</i>		
Character Name	Symbol	Hexidecimal (EBCDIC)
EBCDIC blank	<blank>	X'40'
Cent sign	¢	X'4A'
Period	.	X'4B'
Less than sign	<	X'4C'
Left parenthesis	(X'4D'

<i>Table 40. Valid special (graphical) characters: (continued)</i>		
Character Name	Symbol	Hexidecimal (EBCDIC)
Plus sign	+	X'4E'
Or sign		X'4F'
Ampersand	&	X'50'
Exclamation point	!	X'5A'
Asterisk	*	X'5C'
Right parenthesis)	X'5D'
Semicolon	;	X'5E'
Not sign	¬	X'5F'
Minus sign (hyphen)	-	X'60'
Slash	/	X'61'
Comma	,	X'6B'
Percent Sign	%	X'6C'
Underscore	_	X'6D'
Greater than sign	>	X'6E'
Question mark	?	X'6F'
Emphasis mark	¨	X'79'
Colon	:	X'7A'
Apostrophe	'	X'7D'
Equal sign	=	X'7E'
Quote	"	X'7F'
Tilde	~	X'A1'
Left brace	{	X'C0'
Right brace	}	X'D0'
Backslash	\	X'E0'

If the resulting Xzaidata parameter value contains all X'40' (blanks), the ZAIDATA keyword will be treated as if NO_ZAIDATA had been specified. The default is NO_ZAIDATA.

If you omit this keyword, there will be no change to the ZAIDATA specification for this log stream definition.

,PLISTVER=IMPLIED_VERSION
,PLISTVER=MAX
,PLISTVER=0
,PLISTVER=1
,PLISTVER=2
,PLISTVER=3

An optional input parameter that specifies the version of the macro. PLISTVER determines which parameter list the system generates.

The values are:

- **IMPLIED_VERSION**, which is the lowest version that allows all parameters specified on the request to be processed. If you omit the PLISTVER parameter, IMPLIED_VERSION is the default. Note that on the list form, the default will cause the smallest parameter list to be created.
- **MAX**, if you want the parameter list to be the largest size currently possible. This size might grow from release to release and affect the amount of storage that your program needs.

If you can tolerate the size change, IBM recommends that you always specify PLISTVER=MAX on the list form of the macro. Specifying MAX ensures that the list-form parameter list is always long enough to hold all the parameters you might specify on the execute form when both forms are assembled using the same level of the system. In this way, MAX ensures that the parameter list does not overwrite nearby storage.

- **0**, which supports all parameters except those specifically referenced in higher versions.
- **1**, which supports both the following parameters and parameters from version 0:
 - DESCRIPTION
 - RMNAME
 - RETPD
 - AUTODELETE
- **2**, which supports both the following parameters and parameters from version 0 and 1:
 - DASDONLY
 - LOGGERDUPLEX
- **3**, which supports the following parameter and parameters from version 0, 1, and 2:
 - EHLQ

To code: Specify in this input parameter one of the following:

- IMPLIED_VERSION
- MAX
- A decimal value of 0, 1, 2, or 3

,RETCODE=retcode

Specifies a name (or address in a register) of a 4-byte output field where the system will place the return code. The return code is also in general purpose register (GPR) 15.

,RSNCODE=rsncode

Specifies a name (or address in a register) of a 4-byte output field where the system will place the reason code. The reason code is also in general purpose register (GPR) 0, if you received a non-zero return code.

,MF=S

,MF=(L,list addr)

,MF=(L,list addr,attr)

,MF=(L,list addr,OD)

,MF=(E,list addr)

,MF=(E,list addr,COMPLETE)

,MF=(E,list addr,NOCHECK)

,MF=(M,list addr)

,MF=(M,list addr,COMPLETE)

,MF=(M,list addr,NOCHECK)

Use MF=S to specify the standard form of the macro, which builds an inline parameter list and generates the macro invocation to transfer control to the service. MF=S is the default.

Use MF=L to specify the list form of the macro. Use the list form together with the execute form of the macro for applications that require reentrant code. The list form defines an area of storage that the execute form uses to store the parameters. Only the PLISTVER parameter can be specified on the list form of the macro. IBM recommends that you always specify PLISTVER=MAX on the list form of the macro.

Use MF=E to specify the execute form of the macro. Use the execute form together with the list form of the macro for applications that require reentrant code. The execute form of the macro stores the parameters into the storage area defined by the list form, and generates the macro invocation to transfer control to the service.

Use MF=M together with the list and execute forms of the macro for service routines that need to provide different options according to user-provided input. Use the list form to define a storage area; use the modify form to set the appropriate options; then use the execute form to call the service.

IBM recommends that you use the modify and execute forms in the following order:

- Use MF=(M,*list_addr*,COMPLETE), specifying appropriate parameters, including all required ones.
- Use MF=(M,*list_addr*,NOCHECK), specifying the parameters you want to change.
- Use MF=(E,*list_addr*,NOCHECK), to execute the macro.

,list addr

The name of a storage area to contain the parameters.

,attr

An optional 1- to 60-character input string, which can contain any value that is valid on an assembler DS pseudo-op. You can use this parameter to force boundary alignment of the parameter list. If you do not code *attr*, the system provides a value of 0D, which forces the parameter list to a doubleword boundary.

,COMPLETE

Specifies that the system is to check for required parameters and supply defaults for omitted optional parameters.

,NOCHECK

Specifies that the system is not to check for required parameters and is not to supply defaults for omitted optional parameters.

REQUEST=CHECKDEF option of IXGINVNT

The IXGINVNT macro with the CHECKDEF parameter allows a program to check whether a particular log stream or logger structure entry name is defined in the LOGR policy (LOGR CDS).

Syntax for REQUEST=CHECKDEF

The IXGINVNT REQUEST=CHECKDEF macro is written as follows:

Syntax	Description
<i>name</i>	<i>name</i> : symbol. Begin <i>name</i> in column 1.
	One or more blanks must precede IXGINVNT.
IXGINVNT	
	One or more blanks must follow IXGINVNT.
REQUEST=CHECKDEF	
,TYPE=LOGSTREAM	

Syntax	Description
,TYPE=STRUCTURE	
,STREAMNAME= <i>streamname</i>	<i>streamname</i> : RS-type address or register (2) - (12).
,STRUCTNAME= <i>structname</i>	<i>structname</i> : RS-type address or register (2) - (12).
,EXTRACT=NO	
,EXTRACT=YES	
,ANSAREA= <i>ansarea</i>	<i>ansarea</i> : RS-type address or register (2) - (12).
,ANSLEN= <i>anslen</i>	<i>anslen</i> : RS-type address or register (2) - (12).
,PLISTVER=IMPLIED_VERSION	
,PLISTVER=MAX	Default: IMPLIED_VERSION
,PLISTVER=0 - 4	
,RETCODE= <i>retcode</i>	<i>retcode</i> : RS-type address or register (2) - (12).
,RSNCODE= <i>rsncode</i>	<i>rsncode</i> : RS-type address or register (2) - (12).
,MF=S	Default: MF=S
,MF=(L, <i>list addr</i>)	
,MF=(L, <i>list addr,attr</i>)	
,MF=(L, <i>list addr,OD</i>)	
,MF=(E, <i>list addr</i>)	
,MF=(E, <i>list addr,COMPLETE</i>)	
,MF=(E, <i>list addr,NOCHECK</i>)	
,MF=(M, <i>list addr</i>)	
,MF=(M, <i>list addr,COMPLETE</i>)	
,MF=(M, <i>list addr,NOCHECK</i>)	

Parameters for REQUEST=CHECKDEF

The parameters are explained as follows:

REQUEST=CHECKDEF

Requests that an entry for a log stream or coupling facility structure be checked in the LOGR policy.

,TYPE=LOGSTREAM

Requests that the entry to be checked in the LOGR policy is a log stream entry.

If you specify TYPE=LOGSTREAM, you must also specify STREAMNAME, ANSAREA, and ANSLEN.

,TYPE=STRUCTURE

Requests that the entry to be checked in the LOGR policy is a logger (coupling facility) structure entry.

If you specify TYPE=STRUCTURE, you must also specify STRUCTNAME, ANSAREA, and ANSLEN.

,STREAMNAME=*streamname*

Specifies the 26-byte field (or address in a register) of the log stream that you want to check in the LOGR policy.

The stream name must be 26 characters, padded on the right with blanks, if necessary. The name can be made up of one or more segments, up to the maximum length of 26 characters. The following rules apply:

- Each segment can contain 1-8 numeric, alphabetic, or national (\$, #, or @) characters.
- Lowercase alphabetic characters will be folded to uppercase.
- The first character of each segment must be an alphabetic or national character.
- Each segment must be separated by periods, which count as characters.

STREAMNAME is required for TYPE=LOGSTREAM.

If the log stream name is defined, the check definition request is considered successful and provides return code 0 and reason code '0000'x.

If the log stream name is not defined, the check definition request fails with return code 8 and reason code '080B'x (IXGRSNCODENOSTREAM).

,STRUCTNAME=*structname*

Specify TYPE=STRUCTURE to specify the name (or address in a register) of a 16-byte input field that contains the name of the logger (coupling facility) structure you are checking in the LOGR policy. The following rules apply:

- It can contain numeric, alphabetic, or national (\$, #, or @) characters, or an underscore(_), padded on the right with blanks if necessary
- Lowercase alphabetic characters will be folded to uppercase.
- The first character must be an alphabetic character.

STRUCTNAME is required for TYPE=STRUCTURE.

If the logger structure name is defined, the check definition request is considered successful and provides return code 0 and reason code '0000'x.

If the logger structure name is not defined, the check definition request would fail with return code 8 and reason code '0827'x (IXGRSNCODENOSTRRECORD).

,EXTRACT=NO

Required keyword input that specifies the request is only to verify the resource name is defined in the LOGR CDS.

,EXTRACT=YES

Option is not yet supported. Use of this specification will fail with return code 8 and reason code '0845'x (IxgRsnCodeInvalidFunc).

,ANSAREA=*ansarea*

Specifies the name (or address in a register) of an answer area containing information about this request. The answer area must be at least 40 bytes. To map this information, use the IXGANSAA macro.

,ANSLEN=anslen

Specifies the name (or address in a register) of the 4-byte field containing the answer area length. The length of the answer area must be at least 40 bytes and must be the same length as the field specified in ANSAREA.

To ascertain the optimal answer area length, look at the ANSAA_PREFERRED_SIZE field of the IXGANSAA macro.

,PLISTVER=IMPLIED_VERSION**,PLISTVER=MAX****,PLISTVER=4**

An optional input parameter that specifies the version of the macro. PLISTVER determines which parameter list the system generates.

The values are:

- **IMPLIED_VERSION**, which is the lowest version that allows all parameters specified on the request to be processed. If you omit the PLISTVER parameter, IMPLIED_VERSION is the default. Note that on the list form, the default will cause the smallest parameter list to be created.
- **MAX**, if you want the parameter list to be the largest size currently possible. This size might grow from release to release and affect the amount of storage that your program needs.

If you can tolerate the size change, IBM recommends that you always specify PLISTVER=MAX on the list form of the macro. Specifying MAX ensures that the list-form parameter list is always long enough to hold all the parameters you might specify on the execute form when both forms are assembled using the same level of the system. In this way, MAX ensures that the parameter list does not overwrite nearby storage.

- **4**, which supports the following parameter and parameters from version 0, 1, 2 and 3: **EXTRACT**

To code: Specify in this input parameter one of the following:

- IMPLIED_VERSION
- MAX
- A decimal value of 4

,RETCODE=retcode

Specifies a name (or address in a register) of a 4-byte output field where the system will place the return code. The return code is also in general purpose register (GPR) 15.

,RSNCODE=rsncode

Specifies a name (or address in a register) of a 4-byte output field where the system will place the reason code. The reason code is also in general purpose register (GPR) 0, if you received a non-zero return code.

,MF=S**,MF=(L,list addr)****,MF=(L,list addr,attr)****,MF=(L,list addr,OD)****,MF=(E,list addr)****,MF=(E,list addr,COMPLETE)****,MF=(E,list addr,NOCHECK)****,MF=(M,list addr)****,MF=(M,list addr,COMPLETE)****,MF=(M,list addr,NOCHECK)**

Use MF=S to specify the standard form of the macro, which builds an inline parameter list and generates the macro invocation to transfer control to the service. MF=S is the default.

Use MF=L to specify the list form of the macro. Use the list form together with the execute form of the macro for applications that require reentrant code. The list form defines an area of storage that the execute form uses to store the parameters. Only the PLISTVER parameter can be specified on the list form of the macro. IBM recommends that you always specify PLISTVER=MAX on the list form of the macro.

Use MF=E to specify the execute form of the macro. Use the execute form together with the list form of the macro for applications that require reentrant code. The execute form of the macro stores the parameters into the storage area defined by the list form, and generates the macro invocation to transfer control to the service.

Use MF=M together with the list and execute forms of the macro for service routines that need to provide different options according to user-provided input. Use the list form to define a storage area; use the modify form to set the appropriate options; then use the execute form to call the service.

IBM recommends that you use the modify and execute forms in the following order:

- Use MF=(M,*list_addr*,COMPLETE), specifying appropriate parameters, including all required ones.
- Use MF=(M,*list_addr*,NOCHECK), specifying the parameters you want to change.
- Use MF=(E,*list_addr*,NOCHECK), to execute the macro.

,list addr

The name of a storage area to contain the parameters.

,attr

An optional 1- to 60-character input string, which can contain any value that is valid on an assembler DS pseudo-op. You can use this parameter to force boundary alignment of the parameter list. If you do not code *attr*, the system provides a value of 0D, which forces the parameter list to a doubleword boundary.

,COMPLETE

Specifies that the system is to check for required parameters and supply defaults for omitted optional parameters.

,NOCHECK

Specifies that the system is not to check for required parameters and is not to supply defaults for omitted optional parameters.

ABEND codes for REQUEST

None.

Return and reason codes for REQUEST

When IXGINVNT macro returns control to your program, GPR 15 contains a return code and GPR 0 contains a reason code.

The IXGCON macro provides equate symbols for the return and reason codes. The equate symbols associated with each hexadecimal return code are as follows:

00

IXGRETCODEOK - Service completes successfully.

04

IXGRETCODEWARNING - Service completes with a warning.

08

IXGRETCODEERROR - Service does not complete.

0C

IXGRETCODECOMPERROR - Service does not complete.

The following table contains hexadecimal return and reason codes, the equate symbols associated with each reason code, and the meaning and suggested action for each return and reason code. If your action requires you to see an IXG message, refer to [IXG Messages in z/OS MVS System Messages, Vol 10 \(IXC-IZP\)](#).

Table 41. Return and Reason Codes for the IXGINVNT Macro		
Return Code	Reason Code	Meaning and Action
00	xxxx0000	<p>Equate Symbol: IxgRsnCodeOk</p> <p>Explanation: Request processed successfully.</p>
04	xxxx0418	<p>Equate Symbol: IxgRsnCodeUpdateNewnameWarning</p> <p>Explanation: Environment error. Request to update the log stream with a new stream name processed successfully. However, at least one log stream staging data set was not renamed because of an IDCAMS ALTER error.</p> <p>Action: Notify the system programmer and check for any IXG251I hard-copy messages and see the system programmer response for the message identifier that is included in message IXG251I. The system also issues logger message IXG277E. See z/OS DFSMS Access Method Services Commands for the IDCAMS return code information and correct the condition that caused the error. If a staging data set is migrated, the IXG251I messages might indicate that the data set is a "NONVSAM" type entry for the cluster. Migrated staging data sets for the log stream must be recalled before submitting the NEWSTREAMNAME update request as logger does not attempt to rename migrated data sets. The system programmer will need to rename the staging data set.</p> <p>After correcting the error condition, the System Programmer must submit the necessary IDCAMS ALTER entryname NEWNAME() job to get the existing log stream staging data set name updated to match the new stream name change. The system programmer needs to do this before defining a new instance of a log stream that uses the same name as the log stream identified in this message.</p> <p>Failure to get the staging data set renamed correctly can result in a "loss of data" condition when a connection occurs for the log stream that was renamed. If unable to identify the problem source or correct the error, contact the IBM Support Center.</p> <p>If you received this reason code from IXCMIAPU, see message IXG445E.</p>
08	xxxx0801	<p>Equate Symbol: IxgRsnCodeBadParmlist</p> <p>Explanation: Program error. The parameter list could not be accessed.</p> <p>Action: Ensure that the storage area for the parameter list is accessible to the system logger for the duration of the request. The parameter list storage must be addressable in the caller's primary address space and in the same key as the caller.</p>
08	xxxx0802	<p>Equate Symbol: IxgRsnCodeXESerror</p> <p>Explanation: System error. A severe cross-system extended services (XES) error has occurred.</p> <p>Action: See ANSAA_DIAG1 for the XES return code and ANSAA_DIAG2 for the XES reason code.</p>

Table 41. Return and Reason Codes for the IXGINVNT Macro (continued)

Return Code	Reason Code	Meaning and Action
08	xxxx0805	<p>Equate Symbol: IxgRsnCodeAllocError</p> <p>Explanation: Environment error. The system encountered a severe dynamic allocation (SVC 99) error while processing data sets related to the log stream.</p> <p>If you have received this reason code while running a job that uses the IXCIAPU utility, then messages IXG002E and IXG003I will appear in your joblog. Investigating the diag fields in IXG003I may be helpful. IXG003I is documented in <i>z/OS MVS System Messages, Vol 10 (IXC-IZP)</i>.</p> <p>If your application has received this reason code from the IXGINVNT macro, follow the action steps below.</p> <p>Action:</p> <p>IXGINVNT returns information about the error in the answer area, mapped by IXGANSAA. Investigate the meaning of ANSAA_Diag1 and ANSAA_Diag2.</p> <p>ANSAA_Diag1 contains either an internal logger return code or the contents of the 4 byte field S99ERSN. More information on internal logger return codes and S99ERSN appears below.</p> <p>ANSAA_Diag2 contains either the contents of the 4 byte field S99ERSN or the contents of the 2 byte field S99ERROR followed by the 2 byte field S99INFO.</p> <p>More information on these fields appears below.</p> <p>S99ERSN, S99ERROR and S99INFO are fields in the IEFZB4D0 control block that logger uses to communicate with dynamic allocation.</p> <p>If you receive any one of the following internal logger return codes in ANSAA_Diag1, contact IBM: X'04', x'10', x'14', x'1C'.</p> <p>S99ERROR is documented in <i>Interpreting error reason codes from DYNALLOC of the z/OS MVS Programming: Authorized Assembler Services Guide</i>.</p> <p>S99ERSN is documented in <i>S99RBX fields of the z/OS MVS Programming: Authorized Assembler Services Guide</i>.</p> <p>S99INFO is documented in <i>Interpreting error reason codes from DYNALLOC in the z/OS MVS Programming: Authorized Assembler Services Guide</i>.</p>

Table 41. Return and Reason Codes for the IXGINVNT Macro (continued)		
Return Code	Reason Code	Meaning and Action
		<p>After you have researched the meaning of S99ERROR, S99ERSN and S99INFO, you may be able to find even more information about the meaning of S99ERSN by looking up a DFSMS message whose ID is IGDxxxx. You compute xxx: It is the value found in S99ERSN, converted to decimal. The information for this IGDxxxx message gives the meaning of the value found in S99ERSN, even if the DFSMS message does not appear in syslog. Not all values of S99ERSN map to an IGCxxxx message. Here are some examples of S99ERSN values and the related message ID: If S99ERSN is x'00042CF', the DFSMS message ID would be IGD17103. Sometimes zeros must be inserted after IGD. For example, if S99ERSN is x'00003F6', the DFSMS message ID would be IGD01014. IGD messages are documented in <i>z/OS MVS System Messages, Vol 8 (IEF-IGD)</i>.</p> <p>Look in syslog for any messages that were issued near the time your application invoked the IXGINVNT macro. Look for messages that begin with IXG. Messages of interest will often have 2 message IDs where the first message ID is IXG251I, and the second begins with IGD, IDC, IKJ, IEF or ICH.</p> <p>If message IXG263E was issued, follow the actions documented for that message.</p> <p>If the problem persists, search problem reporting data bases for a fix for the problem. If no fix exists, contact the IBM Support Center.</p>
08	xxxx0808	<p>Equate Symbol: IxgRsnCodeIOError</p> <p>Explanation: System error. A severe log data set I/O error has occurred.</p> <p>Action: Contact the IBM Support Center. Provide the return and reason code.</p>
08	xxxx080A	<p>Equate Symbol: IxgRsnCodeRequestLocked</p> <p>Explanation: Program error. The program issuing the request is holding a lock.</p> <p>Action: Ensure that the program issuing the request is not holding a lock.</p>
08	xxxx080B	<p>Equate Symbol: IxgRsnCodeNoStream</p> <p>Explanation: Program error. The log stream name specified has not been defined in the active system logger couple data set policy.</p> <p>Action: Ensure that the required log stream name has been defined in the active system logger couple data set policy. If the definition appears to be correct, ensure that the application is passing the correct log stream name to the service.</p> <p>If you received this reason code from IXCMIAPU, see message IXG017E.</p>

Table 41. Return and Reason Codes for the IXGINVNT Macro (continued)

Return Code	Reason Code	Meaning and Action
08	xxxx080D	<p>Equate Symbol: IxgRsnCodeNoSAFAuth</p> <p>Explanation: Environment error. The user does not have correct SAF authorization for the request. The caller is not authorized for one of the following objects:</p> <ul style="list-style-type: none"> • The log stream being updated or defined • The log stream named on the LIKE parameter • The log stream named on the NEWSTREAMNAME parameter • The structure specified • The structure extracted from the log stream named on the LIKE parameter • The log stream name or logger structure name for a definition check (CHECKDEF) request • Requesting ZAI=YES for the log stream <p>Action: IXGINVNT returns information about the error in the answer area that is mapped by IXGANSAA. Investigate the meaning of ANSAA_Diag1, ANSAA_Diag2 and ANSAA_Diag4.</p> <ul style="list-style-type: none"> • ANSAA_Diag1 contains the RACF or installation exit return code from the RACROUTE REQUEST=AUTH macro. • ANSAA_Diag2 contains the RACF or installation exit reason code from the RACROUTE REQUEST=AUTH macro. • ANSAA_Diag4 contains the SAF return code from the RACROUTE REQUEST=AUTH macro. <p>See <i>z/OS Security Server RACROUTE Macro Reference</i> for information about the RACROUTE macro.</p> <p>Define SAF authorization for any log streams and structures specified.</p> <p>If the ZAI keyword is provided, ensure the appropriate access is established for using it. If you received this reason code from IXCMIAPU, see message IXG033E.</p>
08	xxxx080E	<p>Equate Symbol: IxgRsnCodeStreamDefined</p> <p>Explanation: Program error. The log stream name specified on a define request or the new log stream name on an update request had already been defined in the active system logger inventory couple data set.</p> <p>Action: Do one of the following:</p> <ul style="list-style-type: none"> • Use the existing definition for the log stream. • Change the name of the log stream being defined on a define request or the new stream name for an update request. • Delete the existing log stream definition from the inventory and then reissue the IXGINVNT request to redefine it. <p>If you received this reason code from IXCMIAPU, see message IXG012E.</p>

<i>Table 41. Return and Reason Codes for the IXGINVNT Macro (continued)</i>		
Return Code	Reason Code	Meaning and Action
08	xxxx0810	<p>Equate Symbol: IxgRsnCodeStreamInuse</p> <p>Explanation: Environment error. You cannot alter or delete a log stream while an application is connected to it. Some attributes can be updated while there are connections provided the appropriate active primary system logger couple data set and release levels are in effect.</p> <p>Action: Reissue the request when there are no active connections to the log stream or move to the appropriate release and system logger couple data set format level.</p> <p>If you received this reason code from IXCMIAPU, see message IXG014E.</p>
08	xxxx0811	<p>Equate Symbol: IxgRsnCodeBadStrname</p> <p>Explanation: Environment error. The structure name specified on the STRUCTNAME parameter is not defined in the CFRM policy.</p> <p>Action: Make sure that the structure you want to specify is defined in the CFRM policy.</p>
08	xxxx0814	<p>Equate Symbol: IxgRsnCodeNotAvailForIPL</p> <p>Explanation: Environment error. The system logger address space is not available for the remainder of this IPL. The system issues messages about this error during system logger initialization.</p> <p>Action: See the explanation for system messages issued during system logger initialization.</p>
08	xxxx0815	<p>Equate Symbol: IxgRsnCodeNotEnabled</p> <p>Explanation: Program error. The program issuing the request is not enabled for I/O and external interrupts, so the request fails.</p> <p>Action: Make sure the program issuing the request is enabled for I/O and external interrupts.</p>
08	xxxx0816	<p>Equate Symbol: IxgRsnCodeBadAnslen</p> <p>Explanation: Program error. The answer area length (ANSLEN parameter) is not large enough. The system logger returned the required size in the Ansaas_Preferred_Size field of the answer area, mapped by IXGANSAA macro.</p> <p>Action: Reissue the request, specifying an answer area of the required size.</p>
08	xxxx0817	<p>Equate Symbol: IxgRsnCodeBadAnsarea</p> <p>Explanation: Program error. The storage area specified on the ANSAREA parameter cannot be accessed. This might occur after the system logger address space has terminated.</p> <p>Action: Specify storage that is in the caller's primary address space and in the same key as the calling program at the time the system logger service was issued. This storage must be accessible until the request completes.</p>

Table 41. Return and Reason Codes for the IXGINVNT Macro (continued)		
Return Code	Reason Code	Meaning and Action
08	xxxx0819	<p>Equate Symbol: IxgRsnCodeSRBMode</p> <p>Explanation: Program error. The calling program is in SRB mode, but task mode is the required dispatchable unit mode for this system logger service.</p> <p>Action: Make sure the calling program is in task mode.</p>
08	xxxx081A	<p>Equate Symbol: IxgRsnCodeMaxStreamConn & IXGINVNT requests</p> <p>Explanation: Environment error. This system has reached the limit for the maximum number of log streams that can be concurrently active. One of the following is true:</p> <ul style="list-style-type: none"> • The limit of 16,384 concurrently active DASDONLY log streams per system has been reached. For this case, the Answer Area field DIAG1 will contain 16,384. • Either the PRODUCTION or TEST GROUP cannot connect to any more log streams. Message IXG075E or IXG076I is issued. In this case, the Answer Area field DIAG1 will contain the number of structures that are in use for this GROUP. • The TEST GROUP has previously failed and a request has been made to define a logstream with GROUP(TEST). Message IXG074I has been previously issued. In this case, the Answer Area field DIAG1 will contain 0. • A Log stream delete cannot be processed because logger needs to perform an internal connect to the Log stream to complete the delete but no more connections are allowed. <p>Action: Your workload need to be planned to either consolidate log streams or balance system activity such that fewer log streams are needed during this time frame.</p>
08	xxxx081B	<p>Equate Symbol: IxgRsnCodePrimaryNotHome</p> <p>Explanation: Program error. The primary address space does not equal the home address space.</p> <p>Action: Make sure that the primary address space equals the home address space when issuing this system logger service.</p>
08	xxxx081E	<p>Equate Symbol: IxgRsnCodeXESStrNotAuth</p> <p>Explanation: Environment error. The system logger address space does not have access authority to the coupling facility structure associated with the log stream specified.</p> <p>Action: Make sure the system logger address space has SAF access to the structure.</p>
08	xxxx081F	<p>Equate Symbol: IxgRsnCodeXcdsError</p> <p>Explanation: System error. System logger encountered an internal problem while processing the active system logger couple data set.</p> <p>Action: Contact the IBM Support Center. Provide the return and reason code and the contents of the answer area (ANSAREA field).</p>

Table 41. Return and Reason Codes for the IXGINVNT Macro (continued)		
Return Code	Reason Code	Meaning and Action
08	xxxx0821	<p>Equate Symbol: IxgRsnCodeDspCreateFailed</p> <p>Explanation: System error. A data space create failed during logger inventory processing.</p> <p>If you have received this reason code while running a job that uses the IXCMIAPU utility, then messages IXG002E and IXG003I will appear in your joblog. Investigating the diag fields in IXG003I may be helpful. Message IXG003I is documented in <i>z/OS MVS System Messages, Vol 10 (IXC-IZP)</i>.</p> <p>If your application has received this reason code from the IXGINVNT macro, follow the action steps below.</p> <p>Action: IXGINVNT returns information about the error in the answer area, mapped by IXGANSAA. Investigate the maning of ANSAA_Diag1 and ANSAA_Diag2.</p> <p>ANSAA_Diag1 contains the return code from the DSPSERV macro.</p> <p>ANSAA_Diag2 contains the reason code from the DSPSERV macro.</p> <p>The DSPSERV macro's return and reason codes are documented in the <i>z/OS MVS Programming: Assembler Services Reference ABE-HSP</i>.</p>
08	xxxx0822	<p>Equate Symbol: IxgRsnCodeBadHlq</p> <p>Explanation: Program error. The high level qualifier specified on the HLQ parameter was incorrect.</p> <p>Action: Specify a valid high level qualifier and reissue the request.</p>

Table 41. Return and Reason Codes for the IXGINVNT Macro (continued)

Return Code	Reason Code	Meaning and Action
08	xxxx0823	<p>Equate Symbol: IxgRsnCodeNoInvrecSpace</p> <p>Explanation: Environment error. Either the active primary system logger couple data set cannot be updated because the maximum number of entries for the specified type has already been reached or the IXGINVNT request attempted to identify a structure name but a single-system scope policy is active on the system where the IXGINVNT request was processed.</p> <p>Action: Depends upon the scope of the active primary system logger CDS where the IXGINVNT request is being processed.</p> <p>For a single-system scope (LOGRY or LOGRZ) CDS:</p> <ul style="list-style-type: none"> • Ensure the request does not include any structure name. <p>For either the sysplex scope LOGR CDS or single-system scope LOGRY/LOGRZ CDS, when a maximum number of entries has been reached, you can either:</p> <ul style="list-style-type: none"> • Delete unused entries in the current active system logger CDS or • Format a larger one and bring it in as the active CDS. <p>To bring in a new, larger one:</p> <ul style="list-style-type: none"> • Format a new system logger couple data set for the same DATA TYPE using the IXCL1DSU utility specifying a sufficient increase for the constrained entries. Increase the allowed number of entries on the LSR parameter (for log stream entries) or the LSTRR parameter (for coupling facility structure entries when using a LOGR CDS). • PSWITCH the current alternate couple data set to primary. Refer to the SETXCF C,TYPE=datatype,PSWITCH command. • Add the newly formatted couple data set as the new alternate. Refer to the SETXCF C,TYPE=datatype,ACOUPLE(...) command. • PSWITCH this newly formatted couple data set from alternate to primary. • Format and add another alternate couple data set with a sufficient number of entries. <p>If you received this reason code from IXCMIAPU, see message IXG010E.</p>
08	xxxx0824	<p>Equate Symbol: IxgRsnCodeMaxStreamStr</p> <p>Explanation: Program error. A program issued IXGINVNT to associate a structure with a log stream, but the maximum number of log streams allowed (as defined on the LOGSNUM parameter) has been reached for the specified structure.</p> <p>Action: Either specify a structure that has not reached its LOGSNUM limit, or specify a larger LOGSNUM value on the definition for the structure.</p> <p>If you received this reason code from IXCMIAPU, see message IXG011E.</p>

<i>Table 41. Return and Reason Codes for the IXGINVNT Macro (continued)</i>		
Return Code	Reason Code	Meaning and Action
08	xxxx0825	<p>Equate Symbol: IxgRsnCodeStrDefined</p> <p>Explanation: Program error. The structure specified on the IXGINVNT request is already defined in the LOGR inventory couple data set.</p> <p>Action: Either use the existing structure definition, change the name of the structure being defined or delete the existing structure and redefine it.</p> <p>If you received this reason code from IXCMIAPU, see message IXG013E.</p>
08	xxxx0826	<p>Equate Symbol: IxgRsnCodeBadLogsnnum</p> <p>Explanation: Program error. The LOGSNUM value specified for a structure definition was not within the valid range between 1 and 512.</p> <p>Action: Change the LOGSNUM value to be within the valid range.</p> <p>If you received this reason code from IXCMIAPU, see message IXG016E.</p>
08	xxxx0827	<p>Equate Symbol: IxgRsnCodeNoStrRecord</p> <p>Explanation: Program error. The coupling facility structure specified in the definition for a log stream or the name specified to delete a structure definition, or the name specified on a CHECKDEF request is not defined in the active primary system logger inventory couple data set.</p> <p>Action: Depends upon the scope of the active primary system logger CDS where the request is being processed.</p> <p>For the sysplex scope LOGR CDS:</p> <p>Either define the coupling facility structure before referencing it in a log stream definition, or specify an existing structure definition.</p> <p>For a single-system scope (LOGRY or LOGRZ) CDS:</p> <p>Ensure the request does not include any structure name.</p> <p>If you received this reason code from IXCMIAPU, see message IXG018E</p>
08	xxxx0828	<p>Equate Symbol: IxgRsnCodeStrRecordInuse</p> <p>Explanation: Program error. The request to delete a structure definition from the LOGR inventory couple data set cannot be completed because several log stream definitions reference it. You cannot delete a structure definition until all the log streams associated with it have been deleted first.</p> <p>Action: Delete all the log streams associated with the structure you wish to delete, and then reissue the request.</p> <p>If you received this reason code from IXCMIAPU, see message IXG015E.</p>

Table 41. Return and Reason Codes for the IXGINVNT Macro (continued)

Return Code	Reason Code	Meaning and Action
08	xxxx0829	<p>Equate Symbol: IxgRsnCodeBadStgStorClas</p> <p>Explanation: Program error. The name specified on the STG_STORCLAS parameter is incorrect.</p> <p>Action: Change the staging data set storage class specified to meet the STG_STORCLAS syntax requirements.</p>
08	xxxx082A	<p>Equate Symbol: IxgRsnCodeBadLSStorClas</p> <p>Explanation: The name specified on the LS_STORCLAS parameter is incorrect.</p> <p>Action: Change the log stream data set storage class specified to meet the LS_STORCLAS syntax requirements.</p>
08	xxxx082B	<p>Equate Symbol: IxgRsnCodeBadStreamLike</p> <p>Explanation: Program error. The log stream name specified on the LIKE parameter was not valid.</p> <p>Action: Reissue the request with a valid log stream name on the LIKE parameter.</p> <p>If you received this reason code from IXCMIAPU, see message IXG031E.</p>
08	xxxx082C	<p>Equate Symbol: IxgRsnCodeBadStructName</p> <p>Explanation: Program error. The coupling facility structure name specified on the STRUCTNAME parameter is not valid.</p> <p>Action: Reissue the request with a valid structure name on the STRUCTNAME parameter.</p>
08	xxxx082E	<p>Equate Symbol: IxgRsnCodeNoLogrCDSAvail</p> <p>Explanation: Environment error. The request failed because no active primary system logger couple data set (CDS) of the expected type is available to this system. The operator was prompted to either make a couple data set available or to indicate that the current request should be rejected. The operator specified that the current request should be rejected.</p> <p>Action: System logger services are unavailable until an active system logger couple data set of the expected type (LOGR, LOGRY, or LOGRZ) is made available to this system.</p> <p>For more information about using system logger couple data sets, see "Format the LOGR couple data set and make it available to the sysplex" and "Using LOGRZ or LOGRY couple data sets for a single-system scope within a sysplex" in <i>z/OS MVS Setting Up a Sysplex</i>.</p> <p>Once the system logger is available using the couple data set, take the necessary steps to cause the function that issued the logger service to reattempt the request.</p>

<i>Table 41. Return and Reason Codes for the IXGINVNT Macro (continued)</i>		
Return Code	Reason Code	Meaning and Action
08	xxxx082F	<p>Equate Symbol: IxgRsnCodeBadStgDataClas</p> <p>Explanation: Program error. The name specified on the LS_DATACLAS parameter is not valid.</p> <p>Action: Change the data class specified to meet the LS_DATACLAS syntax requirements.</p>
08	xxxx0830	<p>Equate Symbol: IxgRsnCodeBadLSDataClas</p> <p>Explanation: Program error. The name specified on the STG_DATACLAS parameter is not valid.</p> <p>Action: Change the data class specified to meet the STG_DATACLAS syntax requirements.</p>
08	xxxx0831	<p>Equate Symbol: IxgRsnCodeBadStreamName</p> <p>Explanation: Program error. The log stream name specified on the STREAMNAME parameter is not valid.</p> <p>Action: Reissue the request with a valid log stream name on the STREAMNAME parameter.</p> <p>If you received this reason code from IXCMIAPU, see message IXG021E.</p>
08	xxxx0832	<p>Equate Symbol: IxgRsnCodeBadStgMgmtClas</p> <p>Explanation: Program error. The name specified on the STG_MGMTCLAS parameter is not valid.</p> <p>Action: Change the staging data set management class specified to meet the STG_MGMTCLAS syntax requirements.</p>
08	xxxx0833	<p>Equate Symbol: IxgRsnCodeBadLSMgmtClas</p> <p>Explanation: Program error. The name specified on the LS_MGMTCLAS parameter is not valid.</p> <p>Action: Change the log stream data set management class specified to meet the LS_MGMTCLAS syntax requirements.</p>
08	xxxx0834	<p>Equate Symbol: IxgRsnCodeInvalidLSSize</p> <p>Explanation: Program error. A non-zero LS_SIZE is specified, but is not in the range valid for a VSAM linear data set.</p> <p>Action: Either change the LS_SIZE or omit it from the DEFINE request to accept the default value.</p> <p>If you received this reason code from IXCMIAPU, see message IXG040E.</p>

<i>Table 41. Return and Reason Codes for the IXGINVNT Macro (continued)</i>		
Return Code	Reason Code	Meaning and Action
08	xxxx0835	<p>Equate Symbol: IxgRsnCodeInvalidStgSize</p> <p>Explanation: Program error. A non-zero STG_SIZE is specified, but is not in the range valid for a VSAM linear data set.</p> <p>Action: Either change the STG_SIZE or omit it from the DEFINE request to accept the default value.</p> <p>If you received this reason code from IXCMIAPU, see message IXG040E.</p>
08	xxxx0838	<p>Equate Symbol: IxgRsnCodeUnDefSmsClas</p> <p>Explanation: Program error. At least one of the names specified for DATACLAS, MGMTCLAS, or STORCLAS is not defined to SMS.</p> <p>Action: Specify names that are defined to the active SMS configuration.</p> <p>If you received this reason code from IXCMIAPU, see message IXG007E.</p>
08	xxxx0839	<p>Equate Symbol: IxgRsnCodeBadCdsLevel</p> <p>Explanation: The active primary LOGR couple data set is not formatted at the level required for the request. See the explanation of the parameters for the level each requires.</p> <p>Action: Take one of the following actions:</p> <ul style="list-style-type: none"> • Bring a new new active primary LOGR couple data set at the required level into the sysplex and then retry the request. • Remove the keywords requiring an new level of the LOGR couple data set and retry the request.

Table 41. Return and Reason Codes for the IXGINVNT Macro (continued)		
Return Code	Reason Code	Meaning and Action
08	xxxx083C	<p>Equate Symbol: IxgRsnCodeBadMaxBufSize</p> <p>Explanation: Program error. For a DEFINE or UPDATE request, the value specified for MAXBUFSIZE was incorrect. It must be a value between 1 and 65,532.</p> <p>For an UPDATE request, one of the following is causing the error:</p> <ul style="list-style-type: none"> • The value specified is less than the MAXBUFSIZE value currently associated with a DASD-only log stream, or • The current DASD-only MAXBUFSIZE value is greater than the MAXBUFSIZE value associated with the STRUCTNAME specified on the update request, or • The current structure MAXBUFSIZE value is greater than the MAXBUFSIZE value associated with the STRUCTNAME specified on the UPDATE request. <p>Action: Do one of the following, depending on the request:</p> <p>For a DEFINE request, specify a valid value for MAXBUFSIZE and reissue the request.</p> <p>For an UPDATE request, do one of the following:</p> <ul style="list-style-type: none"> • Specify a value within the valid range for MAXBUFSIZE that is greater than or equal to the current DASD-only MAXBUFSIZE value. • Ensure that the structure specified on the STRUCTNAME parameter has a maximum buffer size that is greater than or equal to the current MAXBUFSIZE value associated with the log stream specified on the UPDATE request. <p>If you received this reason code from IXCMIAPU, see message IXG009E.</p>
08	xxxx083E	<p>Equate Symbol: IxgRsnCodeNoAvailSysRec</p> <p>Explanation: System error. There were no available system records.</p> <p>Action: Contact the IBM support center. Provide the return and reason codes and the contents of the system logger trace.</p>
08	xxxx0840	<p>Equate Symbol: IxgRsnCodeBadVersion</p> <p>Explanation: Environment error. The parameter list passed to the service routine had an invalid version indicator.</p> <p>Action: Ensure the level of MVS executing the request and the macro library used to compile the invoking routine are compatible.</p>
08	xxxx0842	<p>Equate Symbol: IxgRsnCodeBadAvgBufSize</p> <p>Explanation: Program error. The value specified for AVGBUFSIZE was specified as incorrect. It must be a value between and 65,536 that is less than MAXBUFSIZE.</p> <p>Action: Reissue the request with a valid AVGBUFSIZE value.</p> <p>If you received this reason code from IXCMIAPU, see message IXG022E.</p>

<i>Table 41. Return and Reason Codes for the IXGINVNT Macro (continued)</i>		
Return Code	Reason Code	Meaning and Action
08	xxxx0843	<p>Equate Symbol: IxgRsnCodeXcdsReformat</p> <p>Explanation: Program error. A couple data set record is not valid.</p> <p>Action: Reformat the system logger couple data set.</p> <p>If you received this reason code from IXCMIAPU, see message IXG030E.</p>
08	xxxx0844	<p>Equate Symbol: IxgRsnCodeNoStreamLike</p> <p>Explanation: Program error. The log stream name specified on the LIKE parameter is not defined in the active primary system logger couple data set.</p> <p>Action: Do one of the following:</p> <ul style="list-style-type: none"> • Define the log stream you wish to reference in the active primary inventory couple data set and reissue the request. • Reissue the request, specifying a different log stream that is already defined in the active primary inventory couple data set. <p>If you received this reason code from IXCMIAPU, see message IXG019E.</p>
08	xxxx0845	<p>Equate Symbol: IxgRsnCodeInvalidFunc</p> <p>Explanation: System error. The parameter list for this service contains an unrecognizable function code. The parameter list storage might have been overlaid.</p> <p>Action: Fix the problem and then reissue the request.</p>
08	xxxx084E	<p>Equate Symbol: IxgRsnCodeStrSpaceTooSmall</p> <p>Explanation: Environment error. Structure resources are not available to satisfy the request. All structure resources are allocated as system logger control resources. This condition occurs when the structure resources are consumed by the log streams connection.</p> <p>Action: Increase the size of the structure in the CFRM policy, or use SETXCF ALTER support to dynamically increase the size of the structure.</p>
08	xxxx0850	<p>Equate Symbol: IxgRsnCodeBadVectorLen</p> <p>Explanation: Environment error. The connect request was rejected. System logger was unable to locate a vector table in the hardware system area (HSA) that is large enough for the number of log streams associated with it.</p> <p>Action: Add storage to the vector storage table or retry the connect request later when storage is available.</p>

<i>Table 41. Return and Reason Codes for the IXGINVNT Macro (continued)</i>		
Return Code	Reason Code	Meaning and Action
08	xxxx0851	<p>Equate Symbol: IxgRsnCodeBadCFLevel</p> <p>Explanation: Environment error. The connect request was rejected. The operational level of the coupling facility is not sufficient to support logger functions.</p> <p>Action: Ensure that the coupling facility operational level for logger structures is at least CFLEVEL=1.</p>
08	xxxx0853	<p>Equate Symbol: IxgRsnCodeNoCF</p> <p>Explanation: The connect request was rejected. System logger could not allocate coupling facility structure space, because no suitable coupling facility was available.</p> <p>Action: Check accompanying message IXG206I for a list of the coupling facilities, where space allocation was attempted and the reason why each attempt failed.</p>
08	xxxx0854	<p>Equate Symbol: IxgRsnCodeBadLowoffload</p> <p>Explanation: Program error. The value specified for LOWOFFLOAD is not valid.</p> <p>Action: Change the value to meet the LOWOFFLOAD syntax requirements.</p> <p>If you received this reason code from IXCMIAPU, see message IXG035E.</p>
08	xxxx0855	<p>Equate Symbol: IxgRsnCodeBadHighoffload</p> <p>Explanation: Program error. The value specified for HIGHOFFLOAD is invalid.</p> <p>Action: Change the value to meet the HIGHOFFLOAD syntax requirements.</p> <p>If you received this reason code from IXCMIAPU, see message IXG036E.</p>
08	xxxx0856	<p>Equate Symbol: IxgRsnCodeBadLowHighOffLoad</p> <p>Explanation: Program error. The value specified or defaulted to for the low offload value is equal to or higher than the high offload value. The low offload value must be lower than the high offload value.</p> <p>Action: Change either the LOWOFFLOAD parameter or the HIGHOFFLOAD parameter so that the low offload value is less than the high offload value.</p> <p>If you received this reason code from IXCMIAPU, see messages IXG442E and either IXG035E or IXG036E.</p>

<i>Table 41. Return and Reason Codes for the IXGINVNT Macro (continued)</i>		
Return Code	Reason Code	Meaning and Action
08	xxxx0857	<p>Equate Symbol: IxgRsnCodeDuplexmodeDuplexNo</p> <p>Explanation: Program error. DUPLEXMODE was specified, but the log stream was defined with STG_DUPLEX=NO. The DUPLEXMODE parameter is only valid with STG_DUPLEX=YES.</p> <p>Action: Either change the log stream definition to specify STG_DUPLEX=YES or else omit DUPLEXMODE from the request.</p> <p>If you received this reason code from IXCMIAPU, see message IXG037E.</p>
08	xxxx0858	<p>Equate Symbol: IxgRsnCodeStgSizeDuplexNo</p> <p>Explanation: This reason code is obsolete and will no longer be returned.</p>
08	xxxx0859	<p>Equate Symbol: IxgRsnCodeDataClasDuplexNo</p> <p>Explanation: This reason code is obsolete and will no longer be returned.</p>
08	xxxx085A	<p>Equate Symbol: IxgRsnCodeMgmtClasDuplexNo</p> <p>Explanation: This reason code is obsolete and will no longer be returned.</p>
08	xxxx085B	<p>Equate Symbol: IxgRsnCodeStorClasDuplexNo</p> <p>Explanation: This reason code is obsolete and will no longer be returned.</p>
08	xxxx085E	<p>Equate Symbol: IxgRsnCodeNoStructName</p> <p>Explanation: Program error. A structure name was not provided for this log stream via the STRUCTNAME parameter or defined for a log stream named on a LIKE parameter. A STRUCTNAME value is required to successfully define a log stream to the LOGR couple data set.</p> <p>Action: Provide a value for the STRUCTNAME parameter or define a structure for the log stream referenced on the LIKE parameter.</p> <p>If you received this reason code from IXCMIAPU, see message IXG041E.</p>
08	xxxx0890	<p>Equate Symbol: IxgRsnCodeAddrSpaceNotAvail</p> <p>Explanation: System error. The system logger address space failed and is not available.</p> <p>Action: Do not issue system logger requests.</p> <p>If you received this reason code from IXCMIAPU, see message IXG008E.</p>

<i>Table 41. Return and Reason Codes for the IXGINVNT Macro (continued)</i>		
Return Code	Reason Code	Meaning and Action
08	xxxx0891	<p>Equate Symbol: IxgRsnCodeAddrSpaceInitializing</p> <p>Explanation: System error. The system logger address space is not available because it is IPLing.</p> <p>Action: Listen for ENF signal 48, which will indicate when the system logger address space is available. Reissue this request. You can also listen for ENF signal 48, which will indicate if the system logger address space will not be available for the life of the IPL. In that case, do not issue system logger services.</p> <p>If you received this reason code from IXCMIAPU, see message IXG008E.</p>
08	xxxx08D4	<p>Equate Symbol: IxgRsnCodeBadRMName</p> <p>Explanation: Program Error. The name of the resource manager specified on the RMNAME parameter was not valid.</p> <p>Action: Correct the RMNAME and retry the request.</p>
08	xxxx08D5	<p>Equate Symbol: IxgRsnCodeBadLSDescription</p> <p>Explanation: Program Error. The name of the field specified in the DESCRIPTION parameter was not valid. DESCRIPTION must be 16 alphanumeric or national (\$,#,@) characters, underscore (_) or period (.), padded on the right with blanks if necessary.</p> <p>Action: Correct the DESCRIPTION field name and retry the request.</p>
08	xxxx08D8	<p>Equate Symbol: IxgRsnCodeBadRetpd</p> <p>Explanation: Program Error. The value specified for RETPD was incorrect. It must be a value ≥ 0 and $\leq 65,536$.</p> <p>Action: Specify a valid value for RETPD and reissue the request.</p>
08	xxxx08E0	<p>Equate Symbol: IxgRsnCodeStgDuplexDasdOnly</p> <p>Explanation: Program Error. The STG_DUPLEX keyword was specified with an invalid parameter when a DASD only logstream was defined or updated. When you define or update a DASD only logstream you must omit the STG_DUPLEX keyword or specify STG_DUPLEX=YES. No other option is allowed because DASD only log streams are unconditionally duplexed to staging data sets.</p> <p>Action: For DASD only log stream DEFINE and UPDATE requests specify STG_DUPLEX=YES or omit the STG_DUPLEX keyword.</p> <p>This error code may also result when using the IXCMIAPU utility when the STG_DUPLEX option is specified for a DASD only log stream. See system logger error messages IXG002E or IXG447I.</p>

Table 41. Return and Reason Codes for the IXGINVNT Macro (continued)

Return Code	Reason Code	Meaning and Action
08	xxxx08E1	<p>Equate Symbol: IxgRsnCodeDuplexModeDasdOnly</p> <p>Explanation: Program Error. The DUPLEXMODE keyword was specified with an invalid parameter when a DASD only logstream was defined or updated. When you define or update a DASD only logstream you must omit the DUPLEXMODE keyword or specify DUPLEXMODE=UNCOND. No other option is allowed because DASD only log streams are unconditionally duplexed to staging data sets.</p> <p>Action: For DASD only log stream DEFINE and UPDATE requests specify DUPLEXMODE=UNCOND or omit the DUPLEXMODE keyword.</p> <p>This error code may also result when using the IXCMIAPU utility when the DUPLEXMODE option is specified for a DASD only log stream. See system logger messages IXG002E or IXG447I.</p>
08	xxxx08E2	<p>Equate Symbol: IxgRsnCodeDasdOnlyConnected</p> <p>Explanation: Environment error. System logger rejected an attempt to connect to a DASD-only log stream because another log stream in the sysplex is already connected to that log stream. Only one system at a time can connect to a DASD-only log stream.</p> <p>Action: Determine which system you want to have a connection to the log stream. If you need this connection, disconnect the first system connection to the log stream and retry this connect request.</p>
08	xxxx08E3	<p>Equate Symbol: IxgRsnCodeLogstreamNotSupported</p> <p>Explanation: Environment error. An attempt to connect or effect the LOGR inventory for the log stream is rejected on this system. The system release level does not support this type of log stream, or a log stream attribute such as EHLQ, Duplexmode(Drxrc), GROUP(TEST), or NewStreamName cannot be processed on this system release level.</p> <p>Action: When attempting to connect or delete a log stream that has the EHLQ attribute, you must do so on at least a z/OS Version 1 Release 3 system release level.</p> <p>If you must use a log stream with the DUPLEXMODE(DRXRC) attribute specified, make sure you do so from a system that is at a release level between z/OS Version 1 Release 7 and z/OS Version 2 Release 2, inclusively.</p> <p>If you must use a log stream with the NEWSTREAMNAME attribute specified, make sure you do so from a system that is at z/OS Version 1 Release 8 release or higher.</p> <p>If you must use a log stream with the GROUP attribute specified, make sure you do so from a system that is at z/OS Version 1 Release 8 release or higher.</p> <p>If you received this reason code from IXCMIAPU, see message IXG233I.</p>

Table 41. Return and Reason Codes for the IXGINVNT Macro (continued)		
Return Code	Reason Code	Meaning and Action
08	xxxx08E4	<p>Equate Symbol: IXGRSNCODEMAXBUFSIZEDASDONLY</p> <p>Explanation: Program error. A value was specified for MAXBUFSIZE on this request, but the log stream was defined as a coupling facility log stream (DASDONLY=NO). MAXBUFSIZE is not a valid parameter on a log stream definition request for a coupling facility log stream.</p> <p>Action: Either remove the MAXBUFSIZE parameter from this request or specify DASDONLY=YES with MAXBUFSIZE.</p> <p>If you received this reason code from IXCMIAPU, see messages IXG433E and IXG434E.</p>
08	xxxx08E5	<p>Equate Symbol: IxgRsnCodeLoggerDuplexDasdOnly</p> <p>Explanation: Program error. The LOGGERDUPLEX keyword was specified with an invalid parameter when a DASD only logstream was defined or updated. When you define or update a DASD only logstream you must omit the LOGGERDUPLEX keyword or specify LOGGERDUPLEX=UNCOND. No other option is allowed because DASD only log streams are unconditionally duplexed to staging data sets.</p> <p>Action: For DASD only log stream DEFINE and UPDATE requests specify LOGGERDUPLEX=UNCOND or omit the LOGGERDUPLEX keyword.</p> <p>This error code may also result when using the IXCMIAPU utility when the LOGGERDUPLEX option is specified for a DASD only log stream. See system logger error messages IXG002E or IXG447I.</p>
08	xxxx08E6	<p>Equate Symbol: IxgRsnCodeBadEhlq</p> <p>Explanation: Program error. The extended high level qualifier for the log stream data sets specified on the EHLQ parameter was incorrect. This could be from a syntax error or by specifying EHLQ and HLQ on the same request.</p> <p>Action: Specify a valid extended high level qualifier (EHLQ) or high level qualifier (HLQ) and reissue the request.</p> <p>If you received this reason code from IXCMIAPU, see message IXG440E.</p>
08	xxxx08E7	<p>Equate Symbol: IxgRsnCodeEhlqTooLong</p> <p>Explanation: Program error. The combined length of the extended high level qualifier (EHLQ value) and the log stream name (with a period delimiter) exceeds 35 characters. The combined length of the EHLQ value, the log stream name, and the logger suffix (with period delimiters) cannot exceed 44 characters.</p> <p>Action: Specify a valid extended high-level qualifier (EHLQ) or high-level qualifier (HLQ) and reissue the request.</p> <p>If you received this reason code from IXCMIAPU, see message IXG441E.</p>

<i>Table 41. Return and Reason Codes for the IXGINVNT Macro (continued)</i>		
Return Code	Reason Code	Meaning and Action
08	xxxx08E8	<p>Equate Symbol: IxgRsnCodeBadNewStreamName</p> <p>Explanation: Program error. The log stream name specified on the NEWSTREAMNAME parameter was not valid. This error code might also result when using the IXCMIAPU DATA TYPE(LOGR) utility when the NEWSTREAMNAME option is specified for a log stream.</p> <p>Action: Reissue the request with a valid log stream name on the NEWSTREAMNAME parameter.</p> <p>If you received this reason code from IXCMIAPU, see message IXG031E.</p>
08	xxxx08E9	<p>Equate Symbol: IxgRsnCodeBadGroup</p> <p>Explanation: Program error. For DEFINE requests, the GROUP value is not allowed because the specified structure is not the same GROUP. For UPDATE requests, the GROUP value is not allowed because the specified (or current) structure is not the same GROUP.</p> <p>Action: Specify a valid GROUP value or use a different structure that matches the desired GROUP value.</p>
08	xxxx08EA	<p>Equate Symbol: IxgRsnCodeBadLsAllocAhead</p> <p>Explanation: Program error. The LS_ALLOCAHEAD value that was specified for a log stream definition was not within the valid range between 0 and 3 (inclusive).</p> <p>Action: Change the LS_ALLOCAHEAD value to be within the valid range. If you received this reason code from IXCMIAPU, see message IXG016E.</p>
0C	xxxx0000	<p>Equate Symbol: IxgRetCodeCompError</p> <p>Explanation: User or System error. One of the following occurred:</p> <ul style="list-style-type: none"> • You issued the FORCE IXGLOGR,ARM command to terminate the system logger address space. • System logger component error occurred. <p>Action: If this reason code is not the result of forcing the system logger address space, search problem reporting data bases for a fix for the problem. If no fix exists, contact the IBM Support Center. Provide the diagnostic data in the answer area (IXGANSAA) and any dumps or LOGREC entries from system logger.</p>

REQUEST=DELETE option of IXGINVNT

The IXGINVNT macro with the DELETE parameter allows a program to delete a log stream entry or coupling facility structure entry in the LOGR policy.

Syntax for REQUEST=DELETE

The IXGINVNT REQUEST=DELETE macro is written as follows:

Syntax	Description
<i>name</i>	<i>name</i> : symbol. Begin <i>name</i> in column 1.
␣	One or more blanks must precede IXGINVNT.
IXGINVNT	
␣	One or more blanks must follow IXGINVNT.
REQUEST=DELETE	
,TYPE=LOGSTREAM	
,TYPE=STRUCTURE	
,ANSAREA= <i>ansarea</i>	<i>ansarea</i> : RS-type address or register (2) - (12).
,ANSLEN= <i>anslen</i>	<i>anslen</i> : RS-type address or register (2) - (12).
,STREAMNAME= <i>streamname</i>	<i>streamname</i> : RS-type address or register (2) - (12).
,STRUCTNAME= <i>structname</i>	<i>structname</i> : RS-type address or register (2) - (12).
	Default: NO_STRUCTNAME
,PLISTVER=IMPLIED_VERSION	
,PLISTVER=MAX	Default: IMPLIED_VERSION
,PLISTVER=0	
,PLISTVER=1	
,PLISTVER=2	
,PLISTVER=3	
,RETCODE= <i>retcode</i>	<i>retcode</i> : RS-type address or register (2) - (12).
,RSNCODE= <i>rsncode</i>	<i>rsncode</i> : RS-type address or register (2) - (12).
,MF=S	Default: MF=S
,MF=(L, <i>list addr</i>)	

Syntax	Description
,MF=(L, <i>list addr,attr</i>)	
,MF=(L, <i>list addr,OD</i>)	
,MF=(E, <i>list addr</i>)	
,MF=(E, <i>list addr,COMPLETE</i>)	
,MF=(E, <i>list addr,NOCHECK</i>)	
,MF=(M, <i>list addr</i>)	
,MF=(M, <i>list addr,COMPLETE</i>)	
,MF=(M, <i>list addr,NOCHECK</i>)	

Parameters for REQUEST=DELETE

The parameters are explained as follows:

REQUEST=DELETE

Requests that an entry for a log stream or coupling facility structure be deleted from the LOGR policy.

,TYPE=LOGSTREAM

Requests that the entry to be deleted from the LOGR policy is a log stream entry.

If you specify TYPE=LOGSTREAM, you must also specify STREAMNAME, ANSAREA, and ANSLEN.

,TYPE=STRUCTURE

Requests that the entry to be deleted from the LOGR policy is a coupling facility entry.

If you specify TYPE=STRUCTURE, you must also specify STRUCTNAME, ANSAREA, and ANSLEN.

,ANSAREA=*ansarea*

Specifies the name (or address in a register) of an answer area containing information about this request. The answer area must be at least 40 bytes. To map this information, use the IXGANSAA macro.

,ANSLEN=*anslen*

Specifies the name (or address in a register) of the 4-byte field containing the answer area length. The length of the answer area must be at least 40 bytes and must be the same length as the field specified in ANSAREA.

To ascertain the optimal answer area length, look at the ANSAA_PREFERRED_SIZE field of the IXGANSAA macro.

,STREAMNAME=*streamname*

Specifies the 26-byte field (or address in a register) of the log stream that you want to delete from the LOGR policy.

The stream name must be 26 characters, padded on the right with blanks, if necessary. The name can be made up of one or more segments, up to the maximum length of 26 characters. The following rules apply:

- Each segment can contain 1-8 numeric, alphabetic, or national (\$, #, or @) characters.
- The first character of each segment must be an alphabetic or national character.
- Each segment must be separated by periods, which count as characters.

STREAMNAME is required for TYPE=LOGSTREAM.

,STRUCTNAME=*structname*

Specify TYPE=STRUCTURE to specify the name (or address in a register) of a 16-byte input field that contains the name of the coupling facility structure you are deleting from the LOGR policy.

STRUCTNAME is required for TYPE=STRUCTURE.

The following rules apply for the structname:

- It can contain numeric, alphabetic, or national (\$, #, or @) characters, or an underscore(_), padded on the right with blanks if necessary
- The first character must be an alphabetic character.

,PLISTVER=IMPLIED_VERSION

,PLISTVER=MAX

,PLISTVER=0

,PLISTVER=1

,PLISTVER=2

,PLISTVER=3

An optional input parameter that specifies the version of the macro. PLISTVER determines which parameter list the system generates.

The values are:

- **IMPLIED_VERSION**, which is the lowest version that allows all parameters specified on the request to be processed. If you omit the PLISTVER parameter, IMPLIED_VERSION is the default. Note that on the list form, the default will cause the smallest parameter list to be created.
- **MAX**, if you want the parameter list to be the largest size currently possible. This size might grow from release to release and affect the amount of storage that your program needs.

If you can tolerate the size change, IBM recommends that you always specify PLISTVER=MAX on the list form of the macro. Specifying MAX ensures that the list-form parameter list is always long enough to hold all the parameters you might specify on the execute form when both forms are assembled using the same level of the system. In this way, MAX ensures that the parameter list does not overwrite nearby storage.

- **0**, which supports all parameters except those specifically referenced in higher versions.

To code: Specify in this input parameter one of the following:

- IMPLIED_VERSION
- MAX
- A decimal value of 0, 1, 2, or 3

,RETCODE=retcode

Specifies a name (or address in a register) of a 4-byte output field where the system will place the return code. The return code is also in general purpose register (GPR) 15.

,RSNCODE=rsncode

Specifies a name (or address in a register) of a 4-byte output field where the system will place the reason code. The reason code is also in general purpose register (GPR) 0, if you received a non-zero return code.

,MF=S

,MF=(L,list addr)

,MF=(L,list addr,attr)

,MF=(L,list addr,OD)

,MF=(E,list addr)

,MF=(E,list addr,COMPLETE)

,MF=(E,list addr,NOCHECK)

,MF=(M,list addr)

,MF=(M,list addr,COMPLETE)

,MF=(M,list addr,NOCHECK)

Use MF=S to specify the standard form of the macro, which builds an inline parameter list and generates the macro invocation to transfer control to the service. MF=S is the default.

Use MF=L to specify the list form of the macro. Use the list form together with the execute form of the macro for applications that require reentrant code. The list form defines an area of storage that the

execute form uses to store the parameters. Only the PLISTVER parameter can be specified on the list form of the macro. IBM recommends that you always specify PLISTVER=MAX on the list form of the macro.

Use MF=E to specify the execute form of the macro. Use the execute form together with the list form of the macro for applications that require reentrant code. The execute form of the macro stores the parameters into the storage area defined by the list form, and generates the macro invocation to transfer control to the service.

Use MF=M together with the list and execute forms of the macro for service routines that need to provide different options according to user-provided input. Use the list form to define a storage area; use the modify form to set the appropriate options; then use the execute form to call the service.

IBM recommends that you use the modify and execute forms in the following order:

- Use MF=(M,*list_addr*,COMPLETE), specifying appropriate parameters, including all required ones.
- Use MF=(M,*list_addr*,NOCHECK), specifying the parameters you want to change.
- Use MF=(E,*list_addr*,NOCHECK), to execute the macro.

,*list_addr*

The name of a storage area to contain the parameters.

,*attr*

An optional 1- to 60-character input string, which can contain any value that is valid on an assembler DS pseudo-op. You can use this parameter to force boundary alignment of the parameter list. If you do not code *attr*, the system provides a value of 0D, which forces the parameter list to a doubleword boundary.

,COMPLETE

Specifies that the system is to check for required parameters and supply defaults for omitted optional parameters.

,NOCHECK

Specifies that the system is not to check for required parameters and is not to supply defaults for omitted optional parameters.

ABEND codes for REQUEST=DELETE

None.

Return and reason codes for REQUEST=DELETE

When IXGINVNT macro returns control to your program, GPR 15 contains a return code and GPR 0 contains a reason code.

The IXGCON macro provides equate symbols for the return and reason codes. The equate symbols associated with each hexadecimal return code are as follows:

00

IXGRETCODEOK - Service completes successfully.

04

IXGRETCODEWARNING - Service completes with a warning.

08

IXGRETCODEERROR - Service does not complete.

0C

IXGRETCODECOMPERROR - Service does not complete.

The following table contains hexadecimal return and reason codes, the equate symbols associated with each reason code, and the meaning and suggested action for each return and reason code. If your action requires you to see an IXG message, refer to [IXG Messages in z/OS MVS System Messages, Vol 10 \(IXC-IZP\)](#).

Table 42. Return and Reason Codes for the IXGINVNT Macro		
Return Code	Reason Code	Meaning and Action
00	xxxx0000	<p>Equate Symbol: IxgRsnCodeOk</p> <p>Explanation: Request processed successfully.</p>
04	xxxx0418	<p>Equate Symbol: IxgRsnCodeUpdateNewnameWarning</p> <p>Explanation: Environment error. Request to update the log stream with a new stream name processed successfully. However, at least one log stream staging data set was not renamed because of an IDCAMS ALTER error.</p> <p>Action: Notify the system programmer and check for any IXG251I hard-copy messages and see the system programmer response for the message identifier that is included in message IXG251I. The system also issues logger message IXG277E. See z/OS DFSMS Access Method Services Commands for the IDCAMS return code information and correct the condition that caused the error. If a staging data set is migrated, the IXG251I messages might indicate that the data set is a "NONVSAM" type entry for the cluster. Migrated staging data sets for the log stream must be recalled before submitting the NEWSTREAMNAME update request as logger does not attempt to rename migrated data sets. The system programmer will need to rename the staging data set.</p> <p>After correcting the error condition, the System Programmer must submit the necessary IDCAMS ALTER entryname NEWNAME() job to get the existing log stream staging data set name updated to match the new stream name change. The system programmer needs to do this before defining a new instance of a log stream that uses the same name as the log stream identified in this message.</p> <p>Failure to get the staging data set renamed correctly can result in a "loss of data" condition when a connection occurs for the log stream that was renamed. If unable to identify the problem source or correct the error, contact the IBM Support Center.</p> <p>If you received this reason code from IXCMIAPU, see message IXG445E.</p>
08	xxxx0801	<p>Equate Symbol: IxgRsnCodeBadParmlist</p> <p>Explanation: Program error. The parameter list could not be accessed.</p> <p>Action: Ensure that the storage area for the parameter list is accessible to the system logger for the duration of the request. The parameter list storage must be addressable in the caller's primary address space and in the same key as the caller.</p>
08	xxxx0802	<p>Equate Symbol: IxgRsnCodeXESerror</p> <p>Explanation: System error. A severe cross-system extended services (XES) error has occurred.</p> <p>Action: See ANSAA_DIAG1 for the XES return code and ANSAA_DIAG2 for the XES reason code.</p>

Table 42. Return and Reason Codes for the IXGINVNT Macro (continued)

Return Code	Reason Code	Meaning and Action
08	xxxx0805	<p>Equate Symbol: IxgRsnCodeAllocError</p> <p>Explanation: Environment error. The system encountered a severe dynamic allocation (SVC 99) error while processing data sets related to the log stream.</p> <p>If you have received this reason code while running a job that uses the IXCIAPU utility, then messages IXG002E and IXG003I will appear in your joblog. Investigating the diag fields in IXG003I may be helpful. IXG003I is documented in <i>z/OS MVS System Messages, Vol 10 (IXC-IZP)</i>.</p> <p>If your application has received this reason code from the IXGINVNT macro, follow the action steps below.</p> <p>Action:</p> <p>IXGINVNT returns information about the error in the answer area, mapped by IXGANSAA. Investigate the meaning of ANSAA_Diag1 and ANSAA_Diag2.</p> <p>ANSAA_Diag1 contains either an internal logger return code or the contents of the 4 byte field S99ERSN. More information on internal logger return codes and S99ERSN appears below.</p> <p>ANSAA_Diag2 contains either the contents of the 4 byte field S99ERSN or the contents of the 2 byte field S99ERROR followed by the 2 byte field S99INFO.</p> <p>More information on these fields appears below.</p> <p>S99ERSN, S99ERROR and S99INFO are fields in the IEFZB4D0 control block that logger uses to communicate with dynamic allocation.</p> <p>If you receive any one of the following internal logger return codes in ANSAA_Diag1, contact IBM: X'04', x'10', x'14', x'1C'.</p> <p>S99ERROR is documented in <i>Interpreting Error Reason Codes from DYNALLOC of the z/OS MVS Programming: Authorized Assembler Services Guide</i>.</p> <p>S99ERSN is documented in <i>S99RBX Fields of the z/OS MVS Programming: Authorized Assembler Services Guide</i>.</p> <p>S99INFO is documented in <i>Interpreting Information Reason Codes from DYNALLOC in the z/OS MVS Programming: Authorized Assembler Services Guide</i>.</p>

Table 42. Return and Reason Codes for the IXGINVNT Macro (continued)		
Return Code	Reason Code	Meaning and Action
		<p>After you have researched the meaning of S99ERROR, S99ERSN and S99INFO, you may be able to find even more information about the meaning of S99ERSN by looking up a DFSMS message whose ID is IGDxxxx. You compute xxx: It is the value found in S99ERSN, converted to decimal. The information for this IGDxxxx message gives the meaning of the value found in S99ERSN, even if the DFSMS message does not appear in syslog. Not all values of S99ERSN map to an IGCxxxx message. Here are some examples of S99ERSN values and the related message ID: If S99ERSN is x'00042CF', the DFSMS message ID would be IGD17103. Sometimes zeros must be inserted after IGD. For example, if S99ERSN is x'00003F6', the DFSMS message ID would be IGD01014. IGD messages are documented in <i>z/OS MVS System Messages, Vol 8 (IEF-IGD)</i>.</p> <p>Look in syslog for any messages that were issued near the time your application invoked the IXGINVNT macro. Look for messages that begin with IXG. Messages of interest will often have 2 message IDs where the first message ID is IXG251I, and the second begins with IGD, IDC, IKJ, IEF or ICH.</p> <p>If message IXG263E was issued, follow the actions documented for that message.</p> <p>If the problem persists, search problem reporting data bases for a fix for the problem. If no fix exists, contact the IBM Support Center.</p>
08	xxxx0808	<p>Equate Symbol: IxgRsnCodeIOError</p> <p>Explanation: System error. A severe log data set I/O error has occurred.</p> <p>Action: Contact the IBM Support Center. Provide the return and reason code.</p>
08	xxxx080A	<p>Equate Symbol: IxgRsnCodeRequestLocked</p> <p>Explanation: Program error. The program issuing the request is holding a lock.</p> <p>Action: Ensure that the program issuing the request is not holding a lock.</p>
08	xxxx080B	<p>Equate Symbol: IxgRsnCodeNoStream</p> <p>Explanation: Program error. The log stream name specified has not been defined in the active system logger couple data set policy.</p> <p>Action: Ensure that the required log stream name has been defined in the active system logger couple data set policy. If the definition appears to be correct, ensure that the application is passing the correct log stream name to the service.</p> <p>If you received this reason code from IXCMIAPU, see message IXG017E.</p>

Table 42. Return and Reason Codes for the IXGINVNT Macro (continued)

Return Code	Reason Code	Meaning and Action
08	xxxx080D	<p>Equate Symbol: IxgRsnCodeNoSAFAuth</p> <p>Explanation: Environment error. The user does not have correct SAF authorization for the request. The caller is not authorized for one of the following objects:</p> <ul style="list-style-type: none"> • The log stream being updated or defined • The log stream named on the LIKE parameter • The log stream named on the NEWSTREAMNAME parameter • The structure specified • The structure extracted from the log stream named on the LIKE parameter • Requesting ZAI=YES for the log stream. <p>Action: IXGINVNT returns information about the error in the answer area that is mapped by IXGANSAA. Investigate the meaning of ANSAA_Diag1, ANSAA_Diag2 and ANSAA_Diag4.</p> <ul style="list-style-type: none"> • ANSAA_Diag1 contains the RACF or installation exit return code from the RACROUTE REQUEST=AUTH macro. • ANSAA_Diag2 contains the RACF or installation exit reason code from the RACROUTE REQUEST=AUTH macro. • ANSAA_Diag4 contains the SAF return code from the RACROUTE REQUEST=AUTH macro. <p>See <i>z/OS Security Server RACROUTE Macro Reference</i> for information about the RACROUTE macro.</p> <p>Define SAF authorization for any log streams and structures specified.</p> <p>If the ZAI keyword is provided, ensure the appropriate access is established for using it. If you received this reason code from IXCMIAPU, see message IXG033E.</p>
08	xxxx080E	<p>Equate Symbol: IxgRsnCodeStreamDefined</p> <p>Explanation: Program error. The log stream name specified on a define request or the new log stream name on an update request had already been defined in the LOGR inventory couple data set.</p> <p>Action: Do one of the following:</p> <ul style="list-style-type: none"> • Use the existing definition for the log stream. • Change the name of the log stream being defined on a define request or the new stream name for an update request. • Delete the existing log stream definition from the inventory and then reissue the IXGINVNT request to redefine it. <p>If you received this reason code from IXCMIAPU, see message IXG012E.</p>

<i>Table 42. Return and Reason Codes for the IXGINVNT Macro (continued)</i>		
Return Code	Reason Code	Meaning and Action
08	xxxx0810	<p>Equate Symbol: IxgRsnCodeStreamInuse</p> <p>Explanation: Environment error. You cannot alter or delete a log stream while an application is connected to it. Some attributes can be updated while there are connections provided the appropriate LOGR couple data set and release levels are in effect.</p> <p>Action: Reissue the request when there are no active connections to the log stream or move to the appropriate release and LOGR couple data set format level.</p> <p>If you received this reason code from IXCMIAPU, see message IXG014E.</p>
08	xxxx0811	<p>Equate Symbol: IxgRsnCodeBadStrname</p> <p>Explanation: Environment error. The structure name specified on the STRUCTNAME parameter is not defined in the CFRM policy.</p> <p>Action: Make sure that the structure you want to specify is defined in the CFRM policy.</p>
08	xxxx0814	<p>Equate Symbol: IxgRsnCodeNotAvailForIPL</p> <p>Explanation: Environment error. The system logger address space is not available for the remainder of this IPL. The system issues messages about this error during system logger initialization.</p> <p>Action: See the explanation for system messages issued during system logger initialization.</p>
08	xxxx0815	<p>Equate Symbol: IxgRsnCodeNotEnabled</p> <p>Explanation: Program error. The program issuing the request is not enabled for I/O and external interrupts, so the request fails.</p> <p>Action: Make sure the program issuing the request is enabled for I/O and external interrupts.</p>
08	xxxx0816	<p>Equate Symbol: IxgRsnCodeBadAnslen</p> <p>Explanation: Program error. The answer area length (ANSLEN parameter) is not large enough. The system logger returned the required size in the Ansaas_Preferred_Size field of the answer area, mapped by IXGANSAA macro.</p> <p>Action: Reissue the request, specifying an answer area of the required size.</p>
08	xxxx0817	<p>Equate Symbol: IxgRsnCodeBadAnsarea</p> <p>Explanation: Program error. The storage area specified on the ANSAREA parameter cannot be accessed. This might occur after the system logger address space has terminated.</p> <p>Action: Specify storage that is in the caller's primary address space and in the same key as the calling program at the time the system logger service was issued. This storage must be accessible until the request completes.</p>

Table 42. Return and Reason Codes for the IXGINVNT Macro (continued)		
Return Code	Reason Code	Meaning and Action
08	xxxx0819	<p>Equate Symbol: IxgRsnCodeSRBMode</p> <p>Explanation: Program error. The calling program is in SRB mode, but task mode is the required dispatchable unit mode for this system logger service.</p> <p>Action: Make sure the calling program is in task mode.</p>
08	xxxx081A	<p>Equate Symbol: IxgRsnCodeMaxStreamConn & IXGINVNT requests</p> <p>Explanation: Environment error. This system has reached the limit for the maximum number of log streams that can be concurrently active. One of the following is true:</p> <ul style="list-style-type: none"> • The limit of 16,384 concurrently active DASDONLY log streams per system has been reached. For this case, the Answer Area field DIAG1 will contain 16,384. • Either the PRODUCTION or TEST GROUP cannot connect to any more log streams. Message IXG075E or IXG076I is issued. In this case, the Answer Area field DIAG1 will contain the number of structures that are in use for this GROUP. • The TEST GROUP has previously failed and a request has been made to define a logstream with GROUP(TEST). Message IXG074I has been previously issued. In this case, the Answer Area field DIAG1 will contain 0. • A Log stream delete cannot be processed because logger needs to perform an internal connect to the Log stream to complete the delete but no more connections are allowed. <p>Action: Your workload need to be planned to either consolidate log streams or balance system activity such that fewer log streams are needed during this time frame.</p>
08	xxxx081B	<p>Equate Symbol: IxgRsnCodePrimaryNotHome</p> <p>Explanation: Program error. The primary address space does not equal the home address space.</p> <p>Action: Make sure that the primary address space equals the home address space when issuing this system logger service.</p>
08	xxxx081E	<p>Equate Symbol: IxgRsnCodeXESStrNotAuth</p> <p>Explanation: Environment error. The system logger address space does not have access authority to the coupling facility structure associated with the log stream specified.</p> <p>Action: Make sure the system logger address space has SAF access to the structure.</p>
08	xxxx081F	<p>Equate Symbol: IxgRsnCodeXcdsError</p> <p>Explanation: System error. System logger encountered an internal problem while processing the LOGR couple data set.</p> <p>Action: Contact the IBM Support Center. Provide the return and reason code and the contents of the answer area (ANSAREA field).</p>

Table 42. Return and Reason Codes for the IXGINVNT Macro (continued)		
Return Code	Reason Code	Meaning and Action
08	xxxx0821	<p>Equate Symbol: IxgRsnCodeDspCreateFailed</p> <p>Explanation: System error. A data space create failed during logger inventory processing.</p> <p>If you have received this reason code while running a job that uses the IXCMIAPU utility, then messages IXG002E and IXG003I will appear in your joblog. Investigating the diag fields in IXG003I may be helpful. Message IXG003I is documented in <i>z/OS MVS System Messages, Vol 10 (IXC-IZP)</i>.</p> <p>If your application has received this reason code from the IXGINVNT macro, follow the action steps below.</p> <p>Action: IXGINVNT returns information about the error in the answer area, mapped by IXGANSAA. Investigate the maning of ANSAA_Diag1 and ANSAA_Diag2.</p> <p>ANSAA_Diag1 contains the return code from the DSPSERV macro.</p> <p>ANSAA_Diag2 contains the reason code from the DSPSERV macro.</p> <p>The DSPSERV macro's return and reason codes are documented in the <i>z/OS MVS Programming: Assembler Services Reference ABE-HSP</i>.</p>
08	xxxx0822	<p>Equate Symbol: IxgRsnCodeBadHlq</p> <p>Explanation: Program error. The high level qualifier specified on the HLQ parameter was incorrect.</p> <p>Action: Specify a valid high level qualifier and reissue the request.</p>
08	xxxx0823	<p>Equate Symbol: IxgRsnCodeNoInvrecSpace</p> <p>Explanation: Environment error. The LOGR couple data set cannot be updated because the maximum number of entries for the specified type has already been reached.</p> <p>Action:</p> <ul style="list-style-type: none"> • Format a new LOGR couple data set using the IXCL1DSU utility. In the new LOGR couple data set either delete unused entries or increase the allowed number of entries on the LSR parameter (for log stream entries) or the LSTRR parameter (for coupling facility structure entries). • PSWITCH the current alternate LOGR couple data set to primary. • Add the new LOGR couple data set as alternate. • PSWITCH the new LOGR couple data set from alternate to primary. <p>If you received this reason code from IXCMIAPU, see message IXG010E.</p>

<i>Table 42. Return and Reason Codes for the IXGINVNT Macro (continued)</i>		
Return Code	Reason Code	Meaning and Action
08	xxxx0824	<p>Equate Symbol: IxgRsnCodeMaxStreamStr</p> <p>Explanation: Program error. A program issued IXGINVNT to associate a structure with a log stream, but the maximum number of log streams allowed (as defined on the LOGSNUM parameter) has been reached for the specified structure.</p> <p>Action: Either specify a structure that has not reached its LOGSNUM limit, or specify a larger LOGSNUM value on the definition for the structure.</p> <p>If you received this reason code from IXCMIAPU, see message IXG011E.</p>
08	xxxx0825	<p>Equate Symbol: IxgRsnCodeStrDefined</p> <p>Explanation: Program error. The structure specified on the IXGINVNT request is already defined in the LOGR inventory couple data set.</p> <p>Action: Either use the existing structure definition, change the name of the structure being defined or delete the existing structure and redefine it.</p> <p>If you received this reason code from IXCMIAPU, see message IXG013E.</p>
08	xxxx0826	<p>Equate Symbol: IxgRsnCodeBadLogsnm</p> <p>Explanation: Program error. The LOGSNUM value specified for a structure definition was not within the valid range between 1 and 512.</p> <p>Action: Change the LOGSNUM value to be within the valid range.</p> <p>If you received this reason code from IXCMIAPU, see message IXG016E.</p>
08	xxxx0827	<p>Equate Symbol: IxgRsnCodeNoStrRecord</p> <p>Explanation: Program error. The coupling facility structure specified in the definition for a log stream is not defined in the LOGR inventory couple data set.</p> <p>Action: Either define the coupling facility structure before referencing it in a log stream definition, or specify an existing structure definition.</p> <p>If you received this reason code from IXCMIAPU, see message IXG018E</p>

<i>Table 42. Return and Reason Codes for the IXGINVNT Macro (continued)</i>		
Return Code	Reason Code	Meaning and Action
08	xxxx0828	<p>Equate Symbol: IxgRsnCodeStrRecordInuse</p> <p>Explanation: Program error. The request to delete a structure definition from the LOGR inventory couple data set cannot be completed because several log stream definitions reference it. You cannot delete a structure definition until all the log streams associated with it have been deleted first.</p> <p>Action: Delete all the log streams associated with the structure you wish to delete, and then reissue the request.</p> <p>If you received this reason code from IXCMIAPU, see message IXG015E.</p>
08	xxxx0829	<p>Equate Symbol: IxgRsnCodeBadStgStorClas</p> <p>Explanation: Program error. The name specified on the STG_STORCLAS parameter is incorrect.</p> <p>Action: Change the staging data set storage class specified to meet the STG_STORCLAS syntax requirements.</p>
08	xxxx082A	<p>Equate Symbol: IxgRsnCodeBadLSStorClas</p> <p>Explanation: The name specified on the LS_STORCLAS parameter is incorrect.</p> <p>Action: Change the log stream data set storage class specified to meet the LS_STORCLAS syntax requirements.</p>
08	xxxx082B	<p>Equate Symbol: IxgRsnCodeBadStreamLike</p> <p>Explanation: Program error. The log stream name specified on the LIKE parameter was not valid.</p> <p>Action: Reissue the request with a valid log stream name on the LIKE parameter.</p> <p>If you received this reason code from IXCMIAPU, see message IXG031E.</p>
08	xxxx082C	<p>Equate Symbol: IxgRsnCodeBadStructName</p> <p>Explanation: Program error. The coupling facility structure name specified on the STRUCTNAME parameter is not valid.</p> <p>Action: Reissue the request with a valid structure name on the STRUCTNAME parameter.</p>
08	xxxx082E	<p>Equate Symbol: IxgRsnCodeNoLogrCDSAvail</p> <p>Explanation: Environment error. The request failed because no LOGR couple data set is available. The operator was prompted to either make a couple data set available or to indicate that the current request should be rejected. The operator specified that the current request should be rejected.</p> <p>Action: System logger services are unavailable for the remainder of this IPL.</p>

<i>Table 42. Return and Reason Codes for the IXGINVNT Macro (continued)</i>		
Return Code	Reason Code	Meaning and Action
08	xxxx082F	<p>Equate Symbol: IxgRsnCodeBadStgDataClas</p> <p>Explanation: Program error. The name specified on the LS_DATACLAS parameter is not valid.</p> <p>Action: Change the data class specified to meet the LS_DATACLAS syntax requirements.</p>
08	xxxx0830	<p>Equate Symbol: IxgRsnCodeBadLSDataClas</p> <p>Explanation: Program error. The name specified on the STG_DATACLAS parameter is not valid.</p> <p>Action: Change the data class specified to meet the STG_DATACLAS syntax requirements.</p>
08	xxxx0831	<p>Equate Symbol: IxgRsnCodeBadStreamName</p> <p>Explanation: Program error. The log stream name specified on the STREAMNAME parameter is not valid.</p> <p>Action: Reissue the request with a valid log stream name on the STREAMNAME parameter.</p> <p>If you received this reason code from IXCMIAPU, see message IXG021E.</p>
08	xxxx0832	<p>Equate Symbol: IxgRsnCodeBadStgMgmtClas</p> <p>Explanation: Program error. The name specified on the STG_MGMTCLAS parameter is not valid.</p> <p>Action: Change the staging data set management class specified to meet the STG_MGMTCLAS syntax requirements.</p>
08	xxxx0833	<p>Equate Symbol: IxgRsnCodeBadLSMgmtClas</p> <p>Explanation: Program error. The name specified on the LS_MGMTCLAS parameter is not valid.</p> <p>Action: Change the log stream data set management class specified to meet the LS_MGMTCLAS syntax requirements.</p>
08	xxxx0834	<p>Equate Symbol: IxgRsnCodeInvalidLSSize</p> <p>Explanation: Program error. A non-zero LS_SIZE is specified, but is not in the range valid for a VSAM linear data set.</p> <p>Action: Either change the LS_SIZE or omit it from the DEFINE request to accept the default value.</p> <p>If you received this reason code from IXCMIAPU, see message IXG040E.</p>

<i>Table 42. Return and Reason Codes for the IXGINVNT Macro (continued)</i>		
Return Code	Reason Code	Meaning and Action
08	xxxx0835	<p>Equate Symbol: IxgRsnCodeInvalidStgSize</p> <p>Explanation: Program error. A non-zero STG_SIZE is specified, but is not in the range valid for a VSAM linear data set.</p> <p>Action: Either change the STG_SIZE or omit it from the DEFINE request to accept the default value.</p> <p>If you received this reason code from IXCMIAPU, see message IXG040E.</p>
08	xxxx0838	<p>Equate Symbol: IxgRsnCodeUnDefSmsClas</p> <p>Explanation: Program error. At least one of the names specified for DATACLAS, MGMTCLAS, or STORCLAS is not defined to SMS.</p> <p>Action: Specify names that are defined to the active SMS configuration.</p> <p>If you received this reason code from IXCMIAPU, see message IXG007E.</p>
08	xxxx0839	<p>Equate Symbol: IxgRsnCodeBadCdsLevel</p> <p>Explanation: The active primary LOGR couple data set is not formatted at the level required for the request. See the explanation of the parameters for the level each requires.</p> <p>Action: Take one of the following actions:</p> <ul style="list-style-type: none"> • Bring a new new active primary LOGR couple data set at the required level into the sysplex and then retry the request. • Remove the keywords requiring an new level of the LOGR couple data set and retry the request.

Table 42. Return and Reason Codes for the IXGINVNT Macro (continued)

Return Code	Reason Code	Meaning and Action
08	xxxx083C	<p>Equate Symbol: IxgRsnCodeBadMaxBufSize</p> <p>Explanation: Program error. For a DEFINE or UPDATE request, the value specified for MAXBUFSIZE was incorrect. It must be a value between 1 and 65,532.</p> <p>For an UPDATE request, one of the following is causing the error:</p> <ul style="list-style-type: none"> • The value specified is less than the MAXBUFSIZE value currently associated with a DASD-only log stream, or • The current DASD-only MAXBUFSIZE value is greater than the MAXBUFSIZE value associated with the STRUCTNAME specified on the update request, or • The current structure MAXBUFSIZE value is greater than the MAXBUFSIZE value associated with the STRUCTNAME specified on the UPDATE request. <p>Action: Do one of the following, depending on the request:</p> <p>For a DEFINE request, specify a valid value for MAXBUFSIZE and reissue the request.</p> <p>For an UPDATE request, do one of the following:</p> <ul style="list-style-type: none"> • Specify a value within the valid range for MAXBUFSIZE that is greater than or equal to the current DASD-only MAXBUFSIZE value. • Ensure that the structure specified on the STRUCTNAME parameter has a maximum buffer size that is greater than or equal to the current MAXBUFSIZE value associated with the log stream specified on the UPDATE request. <p>If you received this reason code from IXCMIAPU, see message IXG009E.</p>
08	xxxx083E	<p>Equate Symbol: IxgRsnCodeNoAvailSysRec</p> <p>Explanation: System error. There were no available system records.</p> <p>Action: Contact the IBM support center. Provide the return and reason codes and the contents of the system logger trace.</p>
08	xxxx0840	<p>Equate Symbol: IxgRsnCodeBadVersion</p> <p>Explanation: Environment error. The parameter list passed to the service routine had an invalid version indicator.</p> <p>Action: Ensure the level of MVS executing the request and the macro library used to compile the invoking routine are compatible.</p>
08	xxxx0842	<p>Equate Symbol: IxgRsnCodeBadAvgBufSize</p> <p>Explanation: Program error. The value specified for AVGBUFSIZE was specified as incorrect. It must be a value between and 65,536 that is less than MAXBUFSIZE.</p> <p>Action: Reissue the request with a valid AVGBUFSIZE value.</p> <p>If you received this reason code from IXCMIAPU, see message IXG022E.</p>

<i>Table 42. Return and Reason Codes for the IXGINVNT Macro (continued)</i>		
Return Code	Reason Code	Meaning and Action
08	xxxx0843	<p>Equate Symbol: IxgRsnCodeXcdsReformat</p> <p>Explanation: Program error. A couple data set record is not valid.</p> <p>Action: Reformat the system logger couple data set.</p> <p>If you received this reason code from IXCMIAPU, see message IXG030E.</p>
08	xxxx0844	<p>Equate Symbol: IxgRsnCodeNoStreamLike</p> <p>Explanation: Program error. The log stream name specified on the LIKE parameter is not defined in the LOGR couple data set.</p> <p>Action: Do one of the following:</p> <ul style="list-style-type: none"> • Define the log stream you wish to reference in the LOGR inventory couple data set and reissue the request. • Reissue the request, specifying a different log stream that is already defined in the LOGR couple data set. <p>If you received this reason code from IXCMIAPU, see message IXG019E.</p>
08	xxxx0845	<p>Equate Symbol: IxgRsnCodeInvalidFunc</p> <p>Explanation: System error. The parameter list for this service contains an unrecognizable function code. The parameter list storage might have been overlaid.</p> <p>Action: Fix the problem and then reissue the request.</p>
08	xxxx084E	<p>Equate Symbol: IxgRsnCodeStrSpaceTooSmall</p> <p>Explanation: Environment error. Structure resources are not available to satisfy the request. All structure resources are allocated as system logger control resources. This condition occurs when the structure resources are consumed by the log streams connection.</p> <p>Action: Increase the size of the structure in the CFRM policy, or use SETXCF ALTER support to dynamically increase the size of the structure.</p>
08	xxxx0850	<p>Equate Symbol: IxgRsnCodeBadVectorLen</p> <p>Explanation: Environment error. The connect request was rejected. System logger was unable to locate a vector table in the hardware system area (HSA) that is large enough for the number of log streams associated with it.</p> <p>Action: Add storage to the vector storage table or retry the connect request later when storage is available.</p>
08	xxxx0851	<p>Equate Symbol: IxgRsnCodeBadCFLevel</p> <p>Explanation: Environment error. The connect request was rejected. The operational level of the coupling facility is not sufficient to support logger functions.</p> <p>Action: Ensure that the coupling facility operational level for logger structures is at least CFLEVEL=1.</p>

<i>Table 42. Return and Reason Codes for the IXGINVNT Macro (continued)</i>		
Return Code	Reason Code	Meaning and Action
08	xxxx0853	<p>Equate Symbol: IxgRsnCodeNoCF</p> <p>Explanation: The connect request was rejected. System logger could not allocate coupling facility structure space, because no suitable coupling facility was available.</p> <p>Action: Check accompanying message IXG206I for a list of the coupling facilities, where space allocation was attempted and the reason why each attempt failed.</p>
08	xxxx0854	<p>Equate Symbol: IxgRsnCodeBadLowoffload</p> <p>Explanation: Program error. The value specified for LOWOFFLOAD is not valid.</p> <p>Action: Change the value to meet the LOWOFFLOAD syntax requirements.</p> <p>If you received this reason code from IXCMIAPU, see message IXG035E.</p>
08	xxxx0855	<p>Equate Symbol: IxgRsnCodeBadHighoffload</p> <p>Explanation: Program error. The value specified for HIGHOFFLOAD is invalid.</p> <p>Action: Change the value to meet the HIGHOFFLOAD syntax requirements.</p> <p>If you received this reason code from IXCMIAPU, see message IXG036E.</p>
08	xxxx0856	<p>Equate Symbol: IxgRsnCodeBadLowHighOffLoad</p> <p>Explanation: Program error. The value specified or defaulted to for the low offload value is equal to or higher than the high offload value. The low offload value must be lower than the high offload value.</p> <p>Action: Change either the LOWOFFLOAD parameter or the HIGHOFFLOAD parameter so that the low offload value is less than the high offload value.</p> <p>If you received this reason code from IXCMIAPU, see messages IXG442E and either IXG035E or IXG036E.</p>
08	xxxx0857	<p>Equate Symbol: IxgRsnCodeDuplexmodeDuplexNo</p> <p>Explanation: Program error. DUPLEXMODE was specified, but the log stream was defined with STG_DUPLEX=NO. The DUPLEXMODE parameter is only valid with STG_DUPLEX=YES.</p> <p>Action: Either change the log stream definition to specify STG_DUPLEX=YES or else omit DUPLEXMODE from the request.</p> <p>If you received this reason code from IXCMIAPU, see message IXG037E.</p>
08	xxxx0858	<p>Equate Symbol: IxgRsnCodeStgSizeDuplexNo</p> <p>Explanation: This reason code is obsolete and will no longer be returned.</p>

<i>Table 42. Return and Reason Codes for the IXGINVNT Macro (continued)</i>		
Return Code	Reason Code	Meaning and Action
08	xxxx0859	Equate Symbol: IxgRsnCodeDataClasDuplexNo Explanation: This reason code is obsolete and will no longer be returned.
08	xxxx085A	Equate Symbol: IxgRsnCodeMgmtClasDuplexNo Explanation: This reason code is obsolete and will no longer be returned.
08	xxxx085B	Equate Symbol: IxgRsnCodeStorClasDuplexNo Explanation: This reason code is obsolete and will no longer be returned.
08	xxxx085E	Equate Symbol: IxgRsnCodeNoStructName Explanation: Program error. A structure name was not provided for this log stream via the STRUCTNAME parameter or defined for a log stream named on a LIKE parameter. A STRUCTNAME value is required to successfully define a log stream to the LOGR couple data set. Action: Provide a value for the STRUCTNAME parameter or define a structure for the log stream referenced on the LIKE parameter. If you received this reason code from IXCMIAPU, see message IXG041E.
08	xxxx0890	Equate Symbol: IxgRsnCodeAddrSpaceNotAvail Explanation: System error. The system logger address space failed and is not available. Action: Do not issue system logger requests. If you received this reason code from IXCMIAPU, see message IXG008E.
08	xxxx0891	Equate Symbol: IxgRsnCodeAddrSpaceInitializing Explanation: System error. The system logger address space is not available because it is IPLing. Action: Listen for ENF signal 48, which will indicate when the system logger address space is available. Reissue this request. You can also listen for ENF signal 48, which will indicate if the system logger address space will not be available for the life of the IPL. In that case, do not issue system logger services. If you received this reason code from IXCMIAPU, see message IXG008E.
08	xxxx08D4	Equate Symbol: IxgRsnCodeBadRMName Explanation: Program Error. The name of the resource manager specified on the RMNAME parameter was not valid. Action: Correct the RMNAME and retry the request.

<i>Table 42. Return and Reason Codes for the IXGINVNT Macro (continued)</i>		
Return Code	Reason Code	Meaning and Action
08	xxxx08D5	<p>Equate Symbol: IxgRsnCodeBadLSDescription</p> <p>Explanation: Program Error. The name of the field specified in the DESCRIPTION parameter was not valid. DESCRIPTION must be 16 alphanumeric or national (\$,#,@) characters, underscore (_) or period (.), padded on the right with blanks if necessary.</p> <p>Action: Correct the DESCRIPTION field name and retry the request.</p>
08	xxxx08D8	<p>Equate Symbol: IxgRsnCodeBadRetpd</p> <p>Explanation: Program Error. The value specified for RETPD was incorrect. It must be a value ≥ 0 and $\leq 65,536$.</p> <p>Action: Specify a valid value for RETPD and reissue the request.</p>
08	xxxx08E0	<p>Equate Symbol: IxgRsnCodeStgDuplexDasdOnly</p> <p>Explanation: Program Error. The STG_DUPLEX keyword was specified with an invalid parameter when a DASD only logstream was defined or updated. When you define or update a DASD only logstream you must omit the STG_DUPLEX keyword or specify STG_DUPLEX=YES. No other option is allowed because DASD only log streams are unconditionally duplexed to staging data sets.</p> <p>Action: For DASD only log stream DEFINE and UPDATE requests specify STG_DUPLEX=YES or omit the STG_DUPLEX keyword.</p> <p>This error code may also result when using the IXCMIAPU DATA TYPE(LOGR) utility when the STG_DUPLEX option is specified for a DASD only log stream. See system logger error messages IXG002E or IXG447I.</p>
08	xxxx08E1	<p>Equate Symbol: IxgRsnCodeDuplexModeDasdOnly</p> <p>Explanation: Program Error. The DUPLEXMODE keyword was specified with an invalid parameter when a DASD only logstream was defined or updated. When you define or update a DASD only logstream you must omit the DUPLEXMODE keyword or specify DUPLEXMODE=UNCOND. No other option is allowed because DASD only log streams are unconditionally duplexed to staging data sets.</p> <p>Action: For DASD only log stream DEFINE and UPDATE requests specify DUPLEXMODE=UNCOND or omit the DUPLEXMODE keyword.</p> <p>This error code may also result when using the IXCMIAPU DATA TYPE(LOGR) utility when the DUPLEXMODE option is specified for a DASD only log stream. See system logger messages IXG002E or IXG447I.</p>

Table 42. Return and Reason Codes for the IXGINVNT Macro (continued)		
Return Code	Reason Code	Meaning and Action
08	xxxx08E2	<p>Equate Symbol: IxgRsnCodeDasdOnlyConnected</p> <p>Explanation: Environment error. System logger rejected an attempt to connect to a DASD-only log stream because another log stream in the sysplex is already connected to that log stream. Only one system at a time can connect to a DASD-only log stream.</p> <p>Action: Determine which system you want to have a connection to the log stream. If you need this connection, disconnect the first system connection to the log stream and retry this connect request.</p>
08	xxxx08E3	<p>Equate Symbol: IxgRsnCodeLogstreamNotSupported</p> <p>Explanation: Environment error. An attempt to connect or effect the LOGR inventory for the log stream is rejected on this system. The system release level does not support this type of log stream, or a log stream attribute such as EHLQ, Duplexmode(Drxrc), GROUP(TEST), or NewStreamName cannot be processed on this system release level.</p> <p>Action: When attempting to connect or delete a log stream that has the EHLQ attribute, you must do so on at least a z/OS Version 1 Release 3 system release level.</p> <p>If you must use a log stream with the DUPLEXMODE(DRXRC) attribute specified, make sure you do so from a system that is at a release level between z/OS Version 1 Release 7 and z/OS Version 1 Release 7 and higher release levels, with z/OS Version 2 Release 2, inclusively.</p> <p>If you must use a log stream with the NEWSTREAMNAME attribute specified, make sure you do so from a system that is at z/OS Version 1 Release 8 release or higher.</p> <p>If you must use a log stream with the GROUP attribute specified, make sure you do so from a system that is at z/OS Version 1 Release 8 release or higher.</p> <p>If you received this reason code from IXCMIAPU, see message IXG233I.</p>
08	xxxx08E4	<p>Equate Symbol: IXGRSNCODEMAXBUFSIZEDASDONLY</p> <p>Explanation: Program error. A value was specified for MAXBUFSIZE on this request, but the log stream was defined as a coupling facility log stream (DASDONLY=NO). MAXBUFSIZE is not a valid parameter on a log stream definition request for a coupling facility log stream.</p> <p>Action: Either remove the MAXBUFSIZE parameter from this request or specify DASDONLY=YES with MAXBUFSIZE.</p> <p>If you received this reason code from IXCMIAPU, see messages IXG433E and IXG434E.</p>

Table 42. Return and Reason Codes for the IXGINVNT Macro (continued)		
Return Code	Reason Code	Meaning and Action
08	xxxx08E5	<p>Equate Symbol: IxgRsnCodeLoggerDuplexDasdOnly</p> <p>Explanation: Program error. The LOGGERDUPLEX keyword was specified with an invalid parameter when a DASD only logstream was defined or updated. When you define or update a DASD only logstream you must omit the LOGGERDUPLEX keyword or specify LOGGERDUPLEX=UNCOND. No other option is allowed because DASD only log streams are unconditionally duplexed to staging data sets.</p> <p>Action: For DASD only log stream DEFINE and UPDATE requests specify LOGGERDUPLEX=UNCOND or omit the LOGGERDUPLEX keyword.</p> <p>This error code may also result when using the IXCMIAPU DATA TYPE(LOGR) utility when the LOGGERDUPLEX option is specified for a DASD only log stream. See system logger error messages IXG002E or IXG447I.</p>
08	xxxx08E6	<p>Equate Symbol: IxgRsnCodeBadEhlq</p> <p>Explanation: Program error. The extended high level qualifier for the log stream data sets specified on the EHLQ parameter was incorrect. This could be from a syntax error or by specifying EHLQ and HLQ on the same request.</p> <p>Action: Specify a valid extended high level qualifier (EHLQ) or high level qualifier (HLQ) and reissue the request.</p> <p>If you received this reason code from IXCMIAPU, see message IXG440E.</p>
08	xxxx08E7	<p>Equate Symbol: IxgRsnCodeEhlqTooLong</p> <p>Explanation: Program error. The combined length of the extended high level qualifier (EHLQ value) and the log stream name (with a period delimiter) exceeds 35 characters. The combined length of the EHLQ value, the log stream name, and the logger suffix (with period delimiters) cannot exceed 44 characters.</p> <p>Action: Specify a valid extended high-level qualifier (EHLQ) or high-level qualifier (HLQ) and reissue the request.</p> <p>If you received this reason code from IXCMIAPU, see message IXG441E.</p>
08	xxxx08E8	<p>Equate Symbol: IxgRsnCodeBadNewStreamName</p> <p>Explanation: Program error. The log stream name specified on the NEWSTREAMNAME parameter was not valid. This error code might also result when using the IXCMIAPU DATA TYPE(LOGR) utility when the NEWSTREAMNAME option is specified for a log stream.</p> <p>Action: Reissue the request with a valid log stream name on the NEWSTREAMNAME parameter.</p> <p>If you received this reason code from IXCMIAPU, see message IXG031E.</p>

Table 42. Return and Reason Codes for the IXGINVNT Macro (continued)		
Return Code	Reason Code	Meaning and Action
08	xxxx08E9	<p>Equate Symbol: IxgRsnCodeBadGroup</p> <p>Explanation: Program error. For DEFINE requests, the GROUP value is not allowed because the specified structure is not the same GROUP. For UPDATE requests, the GROUP value is not allowed because the specified (or current) structure is not the same GROUP.</p> <p>Action: Specify a valid GROUP value or use a different structure that matches the desired GROUP value.</p>
08	xxxx08EA	<p>Equate Symbol: IxgRsnCodeBadLsAllocAhead</p> <p>Explanation: Program error. The LS_ALLOCATE value that was specified for a log stream definition was not within the valid range between 0 and 3 (inclusive).</p> <p>Action: Change the LS_ALLOCATE value to be within the valid range. If you received this reason code from IXCMIAPI, see message IXG016E.</p>
0C	xxxx0000	<p>Equate Symbol: IxgRetCodeCompError</p> <p>Explanation: User or System error. One of the following occurred:</p> <ul style="list-style-type: none"> You issued the FORCE IXGLOGR,ARM command to terminate the system logger address space. System logger component error occurred. <p>Action: If this reason code is not the result of forcing the system logger address space, search problem reporting data bases for a fix for the problem. If no fix exists, contact the IBM Support Center. Provide the diagnostic data in the answer area (IXGANSAA) and any dumps or LOGREC entries from system logger.</p>

Example 1

Issue IXGINVNT REQUEST=DEFINE to define a coupling facility structure associated with one or more log streams.

```

IXGINVNT REQUEST=DEFINE,
TYPE=STRUCTURE,
STRUCTNAME=STRUCT,
LOGSNUM=LOGNUM,
AVGBUFSIZE=AVGBUF,
MAXBUFSIZE=MAXBUF,
ANSAREA=ANSAREA,
ANSLEN=ANSLEN,
RSNCODE=RSNCODE,
MF=S,
RETCODE=RETCODE
STRUCT DC CL16'LIST01'          structure name
LOGNUM DC F'10'                 num allocated logstreams allowed
AVGBUF DC F'256'                average buffer size
MAXBUF DC F'4096'               maximum buffer size
ANSAREA DS CL(ANSAA_LEN)        answer area for log requests
ANSLEN DC A(L'ANSAREA)          length of logger's answer area
RETCODE DS F                    return code from logger
RSNCODE DS F                    reason code from logger
DATAREA DSECT
IXGANSAA LIST=YES                answer area

```

Example 2

Issue IXGINVNT REQUEST=DEFINE to define a log stream that writes to both the coupling facility and DASD log data sets as a model and issue IXGINVNT REQUEST=DEFINE a second time to define another log stream modeled on the first using the LIKE parameter.

```

IXGINVNT REQUEST=DEFINE, X
    TYPE=LOGSTREAM, X
    STREAMNAME=STRNAME, X
    STRUCTNAME=STRUCT, X
    DATACLAS=DATACLAS, X
    MGMTCLAS=MGMTCLAS, X
    STORCLAS=STORCLAS, X
    HLQ=HLQ, X
    MODEL=YES, X
    ANSAREA=ANSAREA, X
    ANSLEN=ANSLEN, X
    RSNCODE=RSNCODE, X
    MF=S, X
    RETCODE=RETCODE
IXGINVNT REQUEST=DEFINE, X
    TYPE=LOGSTREAM, X
    STREAMNAME=STRNAME1, X
    LIKE=STRNAME, X
    STRUCTNAME=STRUCT, X
    ANSAREA=ANSAREA, X
    ANSLEN=ANSLEN, X
    RSNCODE=RSNCODE, X
    MF=S, X
    RETCODE=RETCODE
ANSLEN DC A(L'ANSAREA) length of logger's answer area
STRNAME DC CL26'LOG.STREAM.NAME' stream name for model
STRNAME1 DC CL26'LOG.STREAM1.NAME' stream name for like
STRUCT DC CL16'LIST01' associated structure name
DATACLAS DC CL8'VSAMLS' data class name
MGMTCLAS DC CL8'INTERIM' management class name
STORCLAS DC CL8'STANDARD' storage class name
HLQ DC CL8'USERNAME' high level qualifier
ANSAREA DS CL(ANSAA_LEN) answer area for log requests
RETCODE DS F return code from logger
RSNCODE DS F reason code from logger
DATAAREA DSECT
IXGANSAA LIST=YES answer area

```

Example 3

Issue IXGINVNT REQUEST=UPDATE to update a log stream definition.

```

IXGINVNT REQUEST=UPDATE, X
    TYPE=LOGSTREAM, X
    STREAMNAME=STRNAME, X
    DATACLAS=DATACLAS, X
    MGMTCLAS=MGMTCLAS, X
    STORCLAS=STORCLAS, X
    ANSAREA=ANSAREA, X
    ANSLEN=ANSLEN, X
    RSNCODE=RSNCODE, X
    MF=S, X
    RETCODE=RETCODE
STRNAME DC CL26'LOG.STREAM.NAME' stream name
DATACLAS DC CL8'NEWCLASS' data class name
MGMTCLAS DC CL8'NEWMGMNT' management class name
STORCLAS DC CL8'NEWSTOR' storage class name
ANSAREA DS CL(ANSAA_LEN) answer area for log requests
ANSLEN DC A(L'ANSAREA) length of logger's answer area
RETCODE DS F return code from logger
RSNCODE DS F reason code from logger
DATAAREA DSECT
IXGANSAA LIST=YES answer area

```

Example 4

Issue IXGINVNT to define a log stream with a resource manager associated with it.

IXGINVNT macro

```
IXGINVNT REQUEST=DEFINE,
        TYPE=LOGSTREAM,
        STREAMNAME=SNAME,
        STRUCTNAME=STRUCT,
        RMNAME=RMNAME,
        STG_DUPLEX=NO,
        DESCRIPTION=DESCR,
        ANSAREA=XANSAREA,
        ANSLEN=XANSLEN,
        RSNCODE=RSCODE
*
SNAME   DS      CL26                Stream name
STRUCT  DS      CL16                Structure name
RMNAME  DS      CL8                 Res Man name
DESCR   DS      CL16                Description
XANSAREA DS    CL(ANSAA_LEN)        logger answer area
XANSLEN DC     A(ANSAA_LEN)        Answer area length
RSCODE  DS      F                   Reason code
        DSECT ,
        IXGANSAA ,                 The answer area macro
```

Example 5

Issue IXGINVNT to define a log stream with no retention period and autodeletion. This means that log data is deleted whenever IXGDELET is issued against the log stream.

```
IXGINVNT REQUEST=DEFINE,
        TYPE=LOGSTREAM,
        STREAMNAME=SNAME,
        STRUCTNAME=STRUCT,
        STG_DUPLEX=NO,
        RETPD=0,AUTODELETE=YES,
        ANSAREA=XANSAREA,
        ANSLEN=XANSLEN,
        RSNCODE=RSCODE
SNAME   DS      CL26                Stream name
STRUCT  DS      CL16                Structure name
XANSAREA DS    CL(ANSAA_LEN)        logger answer area
XANSLEN DC     A(ANSAA_LEN)        Answer area length
RSCODE  DS      F                   Reason code
        DSECT ,
        IXGANSAA ,                 The answer area macro
```

Example 6

Issue IXGINVNT to define a log stream with staging data sets and a policy of unconditional duplexing. This means that data will always be duplexed to staging data sets, even if the configuration is not volatile.

```
IXGINVNT REQUEST=DEFINE,
        TYPE=LOGSTREAM,
        STREAMNAME=SNAME,
        STRUCTNAME=STRUCT,
        STG_DUPLEX=YES,DUPLEXMODE=UNCOND,
        ANSAREA=XANSAREA,
        ANSLEN=XANSLEN,
        RSNCODE=RSCODE
SNAME   DS      CL26                Stream name
STRUCT  DS      CL16                Structure name
XANSAREA DS    CL(ANSAA_LEN)        logger answer area
XANSLEN DC     A(ANSAA_LEN)        Answer area length
RSCODE  DS      F                   Reason code
        DSECT ,
        IXGANSAA ,                 The answer area macro
```

Example 7

Issue IXGINVNT REQUEST=DELETE to delete a structure definition.

```
IXGINVNT REQUEST=DELETE,
        TYPE=STRUCTURE,
        STRUCTNAME=STRUCT,
        ANSAREA=ANSAREA,
        ANSLEN=ANSLEN,
X
X
X
X
X
```

```

                RSNCODE=RSNCODE,           X
                MF=S,                       X
                RETCODE=RETCODE
STRUCT   DC    CL16'LIST01'                structure name
ANSAREA DS    CL(ANSAA_LEN)                answer area for log requests
ANSLEN  DC    A(L'ANSAREA)                length of logger's answer area
RETCODE DS    F                            return code from logger
RSNCODE DS    F                            reason code from logger
DATAAREA DSECT
IXGANSAA LIST=YES                          answer area

```

Example 8

Issue IXGINVNT with in list, execute and modify forms.

```

                IXGINVNT MF=(L,IXGINVNT_PLIST)
                IXGINVNT REQUEST=DEFINE,    X
                STREAMNAME=STRNAME,        X
                MF=(M,IXGINVNT_PLIST,NOCHECK)

                IXGINVNT REQUEST=DEFINE,    X
                TYPE=LOGSTREAM,             X
                MODEL=NO,                   X
                ANSAREA=ANSAREA,            X
                ANSLEN=ANSLEN,              X
                RSNCODE=RSNCODE,            X
                MF=(E,IXGINVNT_PLIST,NOCHECK)
                RETCODE=RETCODE            X
ANSLEN  DC    A(L'ANSAREA)                length of logger's answer area
STRNAME DC    CL26'LOG.STREAM.NAME'      stream name
ANSAREA DS    CL(ANSAA_LEN)                answer area for log requests
RETCODE DS    F                            return code from logger
RSNCODE DS    F                            reason code from logger
DATAAREA DSECT
IXGANSAA LIST=YES                          answer area

```

Example 9

Issue IXGINVNT using registers.

```

                LA    R6,STRUCT              load struture name into reg 6
                IXGINVNT REQUEST=DELETE,    X
                TYPE=STRUCTURE,             X
                STRUCTNAME=(6),             X
                ANSAREA=ANSAREA,            X
                ANSLEN=ANSLEN,              X
                RSNCODE=RSNCODE,            X
                MF=S,                       X
                RETCODE=RETCODE
STRUCT   DC    CL16'LIST01'                structure name
ANSAREA DS    CL(ANSAA_LEN)                answer area for log requests
ANSLEN  DC    A(L'ANSAREA)                length of logger's answer area
RETCODE DS    F                            return code from logger
RSNCODE DS    F                            reason code from logger
DATAAREA DSECT
IXGANSAA LIST=YES                          answer area
R6      EQU    6                            set up register 6

```

Example 10

Issue IXGINVNT REQUEST=DEFINE to define a log stream as DASD-only:

```

                IXGINVNT REQUEST=DEFINE,    X
                TYPE=LOGSTREAM,             X
                STREAMNAME=STRNAME,        X
                DASDONLY=YES,               X
                GROUP=PRODUCTION,           X
                MAXBUFSIZE=MAXBUF,         X
                HLQ=HLQ,                    X
                ANSAREA=ANSAREA,            X
                ANSLEN=ANSLEN,              X
                RSNCODE=RSNCODE,            X
                MF=S,                       X
                RETCODE=RETCODE

```

IXGINVNT macro

ANSLEN	DC	A(L'ANSAREA)	length of logger's answer area
STRNAME	DC	CL26'LOG.STREAM.NAME'	log stream name
MAXBUF	DC	F'65532'	maximum buffer size
HLQ	DC	CL8'USERNAME'	high level qualifier
ANSAREA	DS	CL(ANSAA_LEN)	answer area for log requests
RETCODE	DS	F	return code from logger
RSNCODE	DS	F	reason code from logger
DATAREA	DSECT		
		IXGANSAA LIST=YES	answer area

Example 11

Issue IXGINVNT REQUEST=DEFINE to define a log stream as DASD-only and then issue the IXGINVNT REQUEST=UPDATE request to upgrade the DASD-only log stream to a coupling facility log stream, associating it with structure 1:

```
IXGINVNT REQUEST=DEFINE,           X
    TYPE=LOGSTREAM,                X
    STREAMNAME=STRNAME,            X
    DASDONLY=YES,                  X
    GROUP=PRODUCTION,              X
    MAXBUFSIZE=MAXBUF,             X
    HLQ=HLQ,                        X
    ANSAREA=ANSAREA,               X
    ANSLEN=ANSLEN,                 X
    RSNCODE=RSNCODE,               X
    MF=S,                           X
    RETCODE=RETCODE                X
IXGINVNT REQUEST=UPDATE,           X
    TYPE=LOGSTREAM,                X
    STREAMNAME=STRNAME,            X
    STRUCTNAME=STRUCT,             X
    GROUP=TEST,                    X
                                     X
    ANSAREA=ANSAREA,               X
    ANSLEN=ANSLEN,                 X
    RSNCODE=RSNCODE,               X
    MF=S,                           X
    RETCODE=RETCODE                X
ANSLEN DC A(L'ANSAREA)             length of logger's answer area
STRNAME DC CL26'LOG.STREAM.NAME'   log stream name
STRUCT DC CL16'STRUCTURE1'         structure name
ANSAREA DS CL(ANSAA_LEN)           answer area for log requests
RETCODE DS F                       return code from logger
RSNCODE DS F                       reason code from logger
DATAREA DSECT
IXGANSAA LIST=YES                  answer area
```

Chapter 72. IXGOFFLD — Initiate offload to DASD log data sets

Description

The IXGOFFLD macro allows the caller to initiate an offload of log data from the coupling facility structure for coupling facility log streams and from local storage buffers for DASD-only log streams to DASD log data sets.

Environment

The requirements for the caller are:

Environmental factor	Requirement
Minimum authorization:	Problem state. Any PSW key
Dispatchable unit mode:	Task
Cross memory mode:	Any PASN, any HASN, any SASN
AMODE:	31-bit or 64-bit
ASC mode:	Primary or access register (AR)
Interrupt status:	Enabled for I/O and external interrupts
	The caller's parameter list must be resident in the caller's primary address space.
	All storage areas specified must be in the same storage key as the caller.
Locks:	No locks may be held.
Control parameters:	None.

Programming requirements

- Before issuing this request, the caller must have issued IXGCONN to connect to the log stream. The caller must specify AUTH=WRITE on the IXGCONN request.
- The current primary address space must be the same as the HOME address space at the time you issued the IXGCONN macro.
- The parameter list for this service must be addressable in the caller's primary address space.
- Include the IXGCON mapping macro in your program. This macro provides a list of equate symbols for the system logger services.
- Include mapping macro IXGANSAA in your program. This macro shows the format of the answer area output returned for each system logger service in the ANSAREA parameter.

Restrictions

All storage areas specified must be in the same storage key as the caller. Storage areas must exist in the caller's primary address space.

Input register information

Before issuing the IXGOFFLD macro, the caller does not have to place any information into any register unless using it in register notation for a particular parameter, or using it as a base register.

Output register information

When control returns to the caller, the GPRs contain:

Register

Contents

0

Reason code, if register 15 contains a non-zero return code

2-13

Unchanged

14

Used as a work register by the system

15

Return code

When control returns to the caller, the ARs contain:

Register

Contents

0-1

Used as a work register by the system

2-13

Unchanged

14-15

Used as a work register by the system

Some callers depend on register contents remaining the same before and after issuing a service. If the system changes the contents of registers on which the caller depends, the caller must save them before issuing the service, and restore them after the system returns control.

Performance implications

IBM recommends that you use IXGOFFLD only when essential. The offloading process does entail some overhead and may degrade system logger performance.

Syntax

The IXGOFFLD macro is written as follows:

Syntax	Description
<i>name</i>	<i>name</i> : symbol. Begin <i>name</i> in column 1.
␣	One or more blanks must precede IXGOFFLD.
IXGOFFLD	
␣	One or more blanks must follow IXGOFFLD.

Syntax	Description
STREAMTOKEN= <i>streamtoken</i>	<i>streamtoken</i> : RS-type address or address in register (2) - (12).
,ANSAREA= <i>ansarea</i>	<i>ansarea</i> : RS-type address or address in register (2) - (12).
,ANSLEN= <i>anslen</i>	<i>anslen</i> : RS-type address or address in register (2) - (12).
,RETCODE= <i>retcode</i>	<i>retcode</i> : RS-type address or register (2) - (12).
,RSNCODE= <i>rsncode</i>	<i>rsncode</i> : RS-type address or register (2) - (12).
,PLISTVER= <u>IMPLIED_VERSION</u>	Default: PLISTVER=IMPLIED_VERSION
,PLISTVER=MAX	
,PLISTVER=0	
,MF= <u>S</u>	Default: MF=S
,MF=(L, <i>list addr</i>)	<i>list addr</i> : RS-type address or register (1) - (12).
,MF=(L, <i>list addr</i> , <i>attr</i>)	
,MF=(L, <i>list addr</i> , <u>0D</u>)	
,MF=(E, <i>list addr</i>)	
,MF=(E, <i>list addr</i> , <u>COMPLETE</u>)	
,MF=(E, <i>list addr</i> , <u>NOCHECK</u>)	
,MF=(M, <i>list addr</i>)	
,MF=(M, <i>list addr</i> , <u>COMPLETE</u>)	
,MF=(M, <i>list addr</i> , <u>NOCHECK</u>)	

Parameters

The parameters are explained as follows:

name

An optional symbol, starting in column 1, that is the name on the IXGOFFLD macro invocation. The name must conform to the rules for an ordinary assembler language symbol.

STREAMTOKEN=*streamtoken*

A required input parameter that specifies the log stream token that was returned on the IXGCONN service.

To code: Specify the RS-type address, or address in register (2)-(12), of a 16-character field.

,ANSAREA=ansarea

A required input parameter of a virtual storage area, called the answer area. The ANSAREA contains additional error status when the IXGOFFLD service generates an error return code. The format of the returned data is defined by the IXGANSAA mapping macro.

To code: Specify the RS-type address, or address in register (2)-(12), of a field.

,ANSLEN=anslen

A required input parameter that contains the length in bytes of the virtual storage area provided for ANSAREA.

The length of the answer area is described by the IXGANSAA mapping macro.

To code: Specify the RS-type address, or address in register (2)-(12), of a fullword field.

,RETCODE=retcode

An optional output parameter into which the return code is to be copied from GPR 15.

To code: Specify the RS-type address of a fullword field, or register (2)-(12).

,RSNCODE=rsncode

An optional output parameter into which the reason code is to be copied from GPR 0.

To code: Specify the RS-type address of a fullword field, or register (2)-(12).

,PLISTVER=IMPLIED_VERSION**,PLISTVER=MAX****,PLISTVER=0**

An optional input parameter that specifies the version of the macro. PLISTVER determines which parameter list the system generates.

The values are:

- **IMPLIED_VERSION**, which is the lowest version that allows all parameters specified on the request to be processed. If you omit the PLISTVER parameter, IMPLIED_VERSION is the default. Note that on the list form, the default will cause the smallest parameter list to be created.
- **MAX**, if you want the parameter list to be the largest size currently possible. This size might grow from release to release and affect the amount of storage that your program needs.

If you can tolerate the size change, IBM recommends that you always specify PLISTVER=MAX on the list form of the macro. Specifying MAX ensures that the list-form parameter list is always long enough to hold all the parameters you might specify on the execute form when both forms are assembled using the same level of the system. In this way, MAX ensures that the parameter list does not overwrite nearby storage.

- **0**, which supports all parameters except those referenced in higher versions.

To code: Specify one of the following:

- IMPLIED_VERSION
- MAX
- A decimal value of 0

,MF=S**,MF=(L,list addr)****,MF=(L,list addr,attr)****,MF=(L,list addr,OD)****,MF=(E,list addr)****,MF=(E,list addr,COMPLETE)****,MF=(E,list addr,NOCHECK)****,MF=(M,list addr)****,MF=(M,list addr,COMPLETE)****,MF=(M,list addr,NOCHECK)**

Use MF=S to specify the standard form of the macro, which builds an inline parameter list and generates the macro invocation to transfer control to the service. MF=S is the default.

Use MF=L to specify the list form of the macro. Use the list form together with the execute form of the macro for applications that require reentrant code. The list form defines an area of storage that the execute form uses to store the parameters. Only the PLISTVER parameter can be specified on the list form of the macro. IBM recommends that you always specify PLISTVER=MAX on the list form of the macro.

Use MF=E to specify the execute form of the macro. Use the execute form together with the list form of the macro for applications that require reentrant code. The execute form of the macro stores the parameters into the storage area defined by the list form, and generates the macro invocation to transfer control to the service.

Use MF=M together with the list and execute forms of the macro for service routines that need to provide different options according to user-provided input. Use the list form to define a storage area; use the modify form to set the appropriate options; then use the execute form to call the service.

IBM recommends that you use the modify and execute forms in the following order:

- Use MF=(M,*list_addr*,COMPLETE), specifying appropriate parameters, including all required ones.
- Use MF=(M,*list_addr*,NOCHECK), specifying the parameters you want to change.
- Use MF=(E,*list_addr*,NOCHECK), to execute the macro.

,*list_addr*

The name of a storage area to contain the parameters.

,*attr*

An optional 1- to 60-character input string, which can contain any value that is valid on an assembler DS pseudo-op. You can use this parameter to force boundary alignment of the parameter list. If you do not code *attr*, the system provides a value of 0D, which forces the parameter list to a doubleword boundary.

,COMPLETE

Specifies that the system is to check for required parameters and supply defaults for omitted optional parameters.

,NOCHECK

Specifies that the system is not to check for required parameters and is not to supply defaults for omitted optional parameters.

ABEND codes

1C5 **Ixg_Abend_Code** - A System Logger abend has occurred.

Reason Code (Hex)

Explanation

xxxx085F

IxgRsnCodePercToRequestor -

Explanation: Environment error. Percolation to the service requestor's task occurred because of an abend during system logger processing. Retry was not allowed.

Action: Issue the request again. If the problem persists, contact the IBM Support Center.

Return and reason codes

When the IXGOFFLD macro returns control to your program:

- GPR 15 (and *retcode*, if you coded RETCODE) contains a return code.
- When the value in GPR 15 is not zero, GPR 0 (and *rsncode*, if you coded RSNCODE) contains a reason code.

00

IxgRetCodeOk - Successful completion

04

IxgRetCodeWarning - The request was processed successfully, however a warning condition was encountered.

08

IxgRetCodeError - An error has been encountered. The associated reason code provides more information.

0C

IxgRetCodeCompError - A system logger component error has been encountered.

The following table contains hexadecimal return and reason codes, the equate symbols associated with each reason code, and the meaning and suggested action for each return and reason code.

<i>Table 43. Return and Reason Codes for the IXGOFFLD Macro</i>		
Return Code	Reason Code	Meaning and Action
00	xxxx0000	IxgRsnCodeOk - Explanation: Request processed successfully.
08	xxxx0801	IxgRsnCodeBadParmlist - Explanation: Program error. The parameter list is not valid. Either the parameter list storage is inaccessible, or the version of the macro used was not valid. Action: Ensure that the storage area for the parameter list is accessible to the system logger for the duration of the request, and that the macro version is correct. The parameter list storage must be addressable in the caller's primary address space and in the same key as the caller.
08	xxxx0802	IxgRsnCodeXESError - Explanation: System error. A severe cross-system extended services (XES) error has occurred. Action: In the answer area mapped by IXGANSAA, see ANSAA_DIAG1 for the XES return code and ANSAA_DIAG2 for the XES reason code.
08	xxxx0806	IxgRsnCodeBadStmToken - Explanation: Program error. One of the following occurred: <ul style="list-style-type: none"> • The stream token was not valid. • The specified request was issued from an address space other than the connector's address space. Action: Do one of the following: <ul style="list-style-type: none"> • Make sure that the stream token specified is valid. • Ensure that IXGOFFLD requests were issued from the connector's address space.
08	xxxx080A	IxgRsnCodeRequestLocked - Explanation: Program error. The program issuing the request is holding a lock. Action: Ensure that the program issuing the request is not holding a lock.
08	xxxx0814	IxgRsnCodeNotAvailForIPL - Explanation: Environment error. The system logger address space is not available for the remainder of this IPL. The system issues messages about this error during system logger initialization. Action: See the explanation for system messages issued during system logger initialization.
08	xxxx0815	IxgRsnCodeNotEnabled - Explanation: Program error. The program issuing the request is not enabled for I/O and external interrupts, so the request fails. Action: Make sure the program issuing the request is enabled for I/O and external interrupts.

Table 43. Return and Reason Codes for the IXGOFFLD Macro (continued)

Return Code	Reason Code	Meaning and Action
08	xxxx0816	<p>IxgRsnCodeBadAnslen -</p> <p>Explanation: Program error. The answer area length (ANSLEN parameter) is not large enough. The system logger returned the required size in the Ansaas_Preferred_Size field of the answer area, mapped by IXGANSAA macro.</p> <p>Action: Reissue the request, specifying an answer area of the required size.</p>
08	xxxx0817	<p>IxgRsnCodeBadAnsarea -</p> <p>Explanation: Program error. The storage area specified on the ANSAREA parameter cannot be accessed. This might occur after the system logger address space has terminated.</p> <p>Action: Specify storage that is in the callers primary address space and in the same key as the calling program at the time the system logger service was issued. This storage must be accessible until the request completes.</p>
08	xxxx0819	<p>IxgRsnCodeSRBMode -</p> <p>Explanation: Program error. The calling program is in SRB mode, but task mode is the required dispatchable unit mode for this system logger service.</p> <p>Action: Make sure the calling program is in task mode.</p>
08	xxxx081C	<p>IxgRsnCodeNotAuthFunc -</p> <p>Explanation: Program error. One of the following occurred:</p> <ul style="list-style-type: none"> The program connected to the log stream with the AUTH=READ parameter and then tried to delete, write, offload or update data. You cannot write, delete, update or offload data when connected with read authority. The program connected to the log stream with the AUTH=WRITE parameter and was granted limited access (for example, write only log data and disconnect) as per the defined security access profiles, and then tried to perform a log stream access service other than IXGWRITE or IXGCONN (to disconnect). <p>Action: A connection to the log stream with the appropriate access authority must be established before using the log stream offload (IXGOFFLD) service. If AUTH=WRITE was already in use when the error was encountered, then check with your installation's security administrator on obtaining the appropriate access to the log stream.</p>
08	xxxx082D	<p>IxgRsnCodeExpiredStmToken -</p> <p>Explanation: Environment error. The stream token is no longer valid because the connector has been disconnected.</p> <p>Action: Reconnect to the logstream before issuing any functional requests.</p>
08	xxxx0840	<p>IxgRsnCodeBadVersion -</p> <p>Explanation: Environment error. The parameter list passed to the service routine has an incorrect version indicator.</p> <p>Action: Make sure that the level of MVS executing the request and the macro library used to compile the invoking routine are compatible.</p>
08	xxxx0861	<p>IxgRsnCodeRebuildInProgress -</p> <p>Explanation: Environment error. No requests can be processed for this log stream because a coupling facility structure rebuild is in progress for the structure associated with this log stream.</p> <p>Action: Listen for ENF signal 48 that will indicate one of the following:</p> <ul style="list-style-type: none"> The log stream is available because the rebuild completed successfully. Reissue the request. The rebuild failed and the log stream is not available.

Table 43. Return and Reason Codes for the IXGOFFLD Macro (continued)		
Return Code	Reason Code	Meaning and Action
08	xxxx0862	<p>IxgRsnCodeXESPurge -</p> <p>Explanation: Environment error. An cross-system extended services (XES) request has been purged due to rebuild processing.</p> <p>Action: Listen for ENF signal 48 that will indicate one of the following:</p> <ul style="list-style-type: none"> • The log stream is available because the rebuild completed successfully. Reissue the request. • The rebuild failed and the log stream is not available.
08	xxxx0863	<p>IxgRsnCodeStructureFailed -</p> <p>Explanation: Environment error. Either the coupling facility structure associated with the log stream has failed or the coupling facility itself has failed.</p> <p>Action: Listen for ENF signal 48 that will indicate one of the following:</p> <ul style="list-style-type: none"> • The log stream is available because the rebuild completed successfully. Reissue the request. • The rebuild failed and the log stream is not available.
08	xxxx0864	<p>IxgRsnCodeNoConnectivity -</p> <p>Explanation: Environment error. No connectivity exists to the coupling facility associated with the log stream. The system logger will either attempt to rebuild the log stream in another coupling facility or the log stream will be disconnected.</p> <p>Action: Listen for ENF signal 48 that will indicate one of the following:</p> <ul style="list-style-type: none"> • The log stream is available because the rebuild completed successfully. Reissue the request. • The rebuild failed and the log stream is not available. • The log stream has been disconnected from this system. <p>If a re-build initiated because of a loss of connectivity previously failed, an ENF corresponding to this reason code might not be issued. Further action by the installation might be necessary to cause the change of the log stream status again. Check the log for messages IXG101I, IXG107I and related rebuild messages for information on resolving any outstanding issues.</p>
08	xxxx0890	<p>IxgRsnCodeAddrSpaceNotAvail -</p> <p>Explanation: System error. The system logger address space failed and is not available.</p> <p>Action: Do not issue system logger requests.</p>
08	xxxx0891	<p>IxgRsnCodeAddrSpaceInitializing -</p> <p>Explanation: System error. The system logger address space is not available because it is IPLing.</p> <p>Action: Listen for ENF signal 48, which will indicate when the system logger address space is available. When it's available, reconnect to the log stream, then reissue this request. You can also listen for ENF signal 48, which will indicate if the system logger address space will not be available for the life of the IPL. In that case, do not issue system logger services.</p>
08	xxxx08DF	<p>IxgRsnCodeOffLoadFlushError -</p> <p>Explanation: System error. The flush service called by IXGOFFLD encountered a XES error.</p> <p>Action: Examine the answer area, which contains more detailed information about the error.</p>

Table 43. Return and Reason Codes for the IXGOFFLD Macro (continued)

Return Code	Reason Code	Meaning and Action
0C	xxxx0000	<p>Equate Symbol: IxgRetCodeCompError</p> <p>Explanation: User or System error. One of the following occurred:</p> <ul style="list-style-type: none"> You issued the FORCE IXGLOGR,ARM command to terminate the system logger address space. System logger component error occurred. <p>Action: If this reason code is not the result of forcing the system logger address space, search problem reporting data bases for a fix for the problem. If no fix exists, contact the IBM Support Center. Provide the diagnostic data in the answer area (IXGANSAA) and any dumps or LOGREC entries from system logger.</p>

Example

Issue IXGOFFLD to initiate offload processing for a log stream.

```

IXGOFFLD                                @
      STREAMTOKEN=OTOKEN,                @
      ANSAREA=XANSAREA,                  @
      ANSLEN=XANSLEN,                    @
      RSNCODE=RSCODE
OTOKEN  DS  CL16                          Output Stream token
XANSAREA DS  CL(ANSAA_LEN)                 Logger answer area
XANSLEN DC  A(ANSAA_LEN)                   Answer area length
RSCODE  DS  F                               Reason code
      DSECT ,
      IXGANSAA ,                           The answer area macro

```

Chapter 73. IXGQUERY – Query a log stream or system logger for information

Description

The IXGQUERY macro allows a user to retrieve information about a log stream or system logger parameter information.

Environment

The requirements for the caller are:

Environmental factor	Requirement
Minimum authorization:	Problem state. Any PSW key
Dispatchable unit mode:	Task
Cross memory mode:	Any PASN, any HASN, any SASN
AMODE:	31-bit or 64-bit
ASC mode:	Primary or access register (AR)
Interrupt status:	Enabled for I/O and external interrupts
Locks:	No locks may be held.
Control parameters:	None.

Programming requirements

- The parameter list for this service must be addressable in the caller's primary address space.
- Include the IXGCON mapping macro in your program. This macro provides a list of equate symbols for the system logger services.
- Include mapping macro IXGANSAA in your program. This macro shows the format of the answer area output returned for each system logger service in the ANSAREA parameter.

When coding REQUEST=LSCONNINFO or when using default:

- The caller must have a valid connection to the log stream.
- The current primary address space must be the same as the HOME address space at the time you issued the IXGCONN macro.
- Include mapping macro IXGQBUF in your program when CHECKCONNSTATUS=NO is specified. This macro shows the format of the data returned by IXGQUERY.

When coding REQUEST=ZAILOCINFO:

- The current primary address space must be the same as the HOME address space, unless a log stream connection (IXGCONN connect) request was previously performed from the primary address space.
- Include mapping macro IXGQZBUF in your program. This macro shows the format of the data returned by IXGQUERY.

Restrictions

- The caller's output buffer (see BUFFER and BUFFER64) must be in the caller's primary address space and cannot be ALET-qualified.

IXGQUERY

- All storage areas specified must be in the same storage key as the caller.
- The caller cannot have any enabled, unlocked task (EUT) FRRs established.
- There is more than one version of this macro available. The parameters you can use depend on the version you specify on the PLISTVER parameter. See the description of the PLISTVER parameter for more information.
- You can call any of the system logger services in either AMODE 31 or 64, but the parameter list and all other data addresses, with the exception of BUFFER64 must reside in 31-bit storage.

Input register information

Before issuing the IXGQUERY macro, the caller does not have to place any information into any register unless using it in register notation for a particular parameter, or using it as a base register.

Output register information

When control returns to the caller, the GPRs contain:

Register

Contents

0

Reason code, if register 15 contains a non-zero return code

2-13

Unchanged

14

Used as a work register by the system

15

Return code

When control returns to the caller, the ARs contain:

Register

Contents

0-1

Used as a work register by the system

2-13

Unchanged

14-15

Used as a work register by the system

64 Bit Register Usage

If the caller is in Amode 64, then 64-bit register 15 will be altered. If the caller uses Buffer64, then 64-bit registers 0, 1, and 15 may be altered.

Some callers depend on register contents remaining the same before and after issuing a service. If the system changes the contents of registers on which the caller depends, the caller must save them before issuing the service, and restore them after the system returns control.

Performance implications

None.

Syntax

The IXGQUERY macro is written as follows:

Syntax	Description

Syntax	Description
<i>name</i>	<i>name</i> : symbol. Begin <i>name</i> in column 1.
␣	One or more blanks must precede IXGQUERY.
IXGQUERY	
␣	One or more blanks must follow IXGQUERY.
REQUEST=LSCONNINFO	Default: LSCONNINFO
STREAMTOKEN= <i>xstreamtoken</i>	<i>xstreamtoken</i> : RS-type address or address in register (2) - (12).
CHECKCONNSTATUS=NO	Default: NO
,BUFFER= <i>xbuffer</i>	<i>xbuffer</i> : RS-type address or address in register (2) - (12).
,BUFFLEN= <i>xbufflen</i>	<i>xbufflen</i> : RS-type address or address in register (2) - (12).
CHECKCONNSTATUS=YES	
REQUEST=ZAILOCINFO	
,BUFFER64= <i>xbuffer64</i>	<i>xbuffer64</i> : RS-type address or address in register (2) - (12).
,BUFFLEN= <i>xbufflen</i>	<i>xbufflen</i> : RS-type address or address in register (2) - (12).
,ANSAREA= <i>ansarea</i>	<i>ansarea</i> : RS-type address or address in register (2) - (12).
,ANSLEN= <i>anslen</i>	<i>anslen</i> : RS-type address or address in register (2) - (12).
,RETCODE= <i>retcode</i>	<i>retcode</i> : RS-type address or register (2) - (12).
,RSNCODE= <i>rsncode</i>	<i>rsncode</i> : RS-type address or register (2) - (12).
,PLISTVER= <u>IMPLIED_VERSION</u>	Default: PLISTVER=IMPLIED_VERSION
,PLISTVER=MAX	
,PLISTVER=0	
,PLISTVER=1	
,PLISTVER=2	
,MF= <u>S</u>	Default: MF=S

Syntax	Description
,MF=(L, <i>list addr</i>)	<i>list addr</i> : RS-type address or register (1) - (12).
,MF=(L, <i>list addr,attr</i>)	
,MF=(L, <i>list addr,0D</i>)	
,MF=(E, <i>list addr</i>)	
,MF=(E, <i>list addr,COMPLETE</i>)	
,MF=(E, <i>list addr,NOCHECK</i>)	
,MF=(M, <i>list addr</i>)	
,MF=(M, <i>list addr,COMPLETE</i>)	
,MF=(M, <i>list addr,NOCHECK</i>)	

Parameters

The parameters are explained as follows:

name

An optional symbol, starting in column 1, that is the name on the IXGQUERY macro invocation. The name must conform to the rules for an ordinary assembler language symbol.

REQUEST=LSCONNINFO|ZAILOCINFO

An optional keyword input that specifies the type of system logger related information being requested.

DEFAULT: LSCONNINFO

REQUEST=LSCONNINFO

The program requests to obtain information for a connected log stream.

STREAMTOKEN=streamtoken

A required input parameter that specifies the log stream token that was returned by the IXGCONN service.

To code: Specify the RS-type address, or address in register (2)-(12), of a 16-character field.

CHECKCONNSTATUS=NO|YES

An optional keyword input that indicates whether or not only the connection status of the log is to be checked.

DEFAULT: NO

CHECKCONNSTATUS=NO

Indicates that full IXGQUERY processing is to be performed.

,BUFFER=buffer

A required output parameter that specifies the buffer into which the requested data are to be copied. The contents of the buffer are mapped by IXGQBUF.

The buffer cannot be ALET qualified.

To code: Specify the RS-type address, or address in register (2)-(12), of a character field.

,BUFFLEN=bufflen

A required input parameter that specifies the size of the buffer, identified by the BUFFER keyword, relative to different output versions:

If you want to see the GROUP information specified for the log stream, you must specify at least 200 bytes. If you specify less than 200 bytes, IXGQUERY will not return the GROUP information.

If the user-specified buffer is less than 72 bytes, the query request will fail and a specific return or reason code (IxgRetCodeError, IxgRsnCodeBadBufSize) will be returned.

If the user-specified buffer is greater than or equal to 88 bytes, version one information will be returned.

If the user-specified buffer is greater than or equal to 168 bytes, version two information will be returned.

If the user-specified buffer is greater than or equal to 200 bytes, version three information will be returned. If you want to see the GROUP information specified for the log stream, you must specify at least 200 bytes. If you specify less than 200 bytes, IXGQUERY will not return the GROUP information.

See IXGQZBUF in *z/OS MVS Data Areas* in the *z/OS Internet library* (www.ibm.com/servers/resourcelink/svc00100.nsf/pages/zosInternetLibrary) for details.

To code: Specify the RS-type address, or address in register (2)-(12), of a fullword field.

CHECKCONNSTATUS=YES

Indicates only the connection status of the log stream is to be checked.

REQUEST=ZAILOCINFO

The program requests to obtain information for the system logger ZAI parameter options pertaining to the IBM zAware server location.

,BUFFER64=xbuffer64

A required output parameter that specifies the buffer (starting on a full word boundary) into which the requested data are to be copied. The location of this buffer may be anywhere in 64-bit storage.

The contents of the buffer are mapped by IXGQZBUF.

The buffer cannot be ALET qualified.

To code: Specify the RS-type address, or address in register (2)-(12), of a character field.

,BUFFLEN=buflen

A required input parameter that specifies the size of the buffer, identified by the BUFFER64 keyword, relative to different output versions:

- If the user-specified buffer is less than 96 bytes, the query request will fail and a specific return or reason code (IxgRetCodeError, IxgRsnCodeBadBufSize) will be returned.
- If the user specified buffer is greater than or equal to 96 bytes, then version one information will be returned. Meaning, the IXGQZBUF_Hdr fields will be filled in by logger with the following values:
 1. IXGQZBUF_HDR_VER value is assigned a value of 1 ('01'x).
 2. IXGQZBUF_HDR_LEN value is assigned a value of 96 ('60'x).
- If the user specified buffer area length is greater than or equal to 128 bytes, then logger will return all the version 1 information and the version two information. The IXGQZBUF_Hdr fields will be filled in by logger with the following values:
 1. IXGQZBUF_HDR_VER value is assigned a value of 2 ('02'x).
 2. IXGQZBUF_HDR_LEN value is assigned a value of 128 ('80'x).

See IXGQZBUF in *z/OS MVS Data Areas* in the *z/OS Internet library* (www.ibm.com/servers/resourcelink/svc00100.nsf/pages/zosInternetLibrary) for details.

To code: Specify the RS-type address, or address in register (2)-(12), of a fullword field.

,ANSAREA=ansarea

A required input parameter of a virtual storage area, called the answer area. The ANSAREA contains additional error status when the IXGQUERY service generates an error return code. The format of the returned data is defined by the IXGANSAA mapping macro.

To code: Specify the RS-type address, or address in register (2)-(12), of a field.

,ANSLEN=anslen

A required input parameter that contains the length in bytes of the virtual storage area provided for ANSAREA.

The length of the answer area is described by the IXGANSAA mapping macro.

To code: Specify the RS-type address, or address in register (2)-(12), of a fullword field.

,RETCODE=retcode

An optional output parameter into which the return code is to be copied from GPR 15.

To code: Specify the RS-type address of a fullword field, or register (2)-(12).

,RSNCODE=rsncode

An optional output parameter into which the reason code is to be copied from GPR 0.

To code: Specify the RS-type address of a fullword field, or register (2)-(12).

,PLISTVER=IMPLIED_VERSION**,PLISTVER=MAX****,PLISTVER=0****,PLISTVER=1****,PLISTVER=2**

An optional input parameter that specifies the version of the macro. PLISTVER determines which parameter list the system generates.

The values are:

- **IMPLIED_VERSION**, which is the lowest version that allows all parameters specified on the request to be processed. If you omit the PLISTVER parameter, IMPLIED_VERSION is the default. Note that on the list form, the default will cause the smallest parameter list to be created.
- **MAX**, if you want the parameter list to be the largest size currently possible. This size might grow from release to release and affect the amount of storage that your program needs.

If you can tolerate the size change, IBM recommends that you always specify PLISTVER=MAX on the list form of the macro. Specifying MAX ensures that the list-form parameter list is always long enough to hold all the parameters you might specify on the execute form when both forms are assembled using the same level of the system. In this way, MAX ensures that the parameter list does not overwrite nearby storage.

- **0**, which supports all parameters except those referenced in higher versions.
- **1**, which supports both the following parameters and parameters from version 0:
 - CHECKCONNSTATUS
 - REQUEST
- **2**, which supports both the following parameters and parameters from version 0 and 1:
 - BUFFER64

To code: Specify one of the following:

- IMPLIED_VERSION
- MAX
- A decimal value of 0

,MF=S
,MF=(L,list addr)
,MF=(L,list addr,attr)
,MF=(L,list addr,OD)
,MF=(E,list addr)
,MF=(E,list addr,COMPLETE)
,MF=(E,list addr,NOCHECK)
,MF=(M,list addr)
,MF=(M,list addr,COMPLETE)
,MF=(M,list addr,NOCHECK)

Use MF=S to specify the standard form of the macro, which builds an inline parameter list and generates the macro invocation to transfer control to the service. MF=S is the default.

Use MF=L to specify the list form of the macro. Use the list form together with the execute form of the macro for applications that require reentrant code. The list form defines an area of storage that the execute form uses to store the parameters. Only the PLISTVER parameter can be specified on the list form of the macro. IBM recommends that you always specify PLISTVER=MAX on the list form of the macro.

Use MF=E to specify the execute form of the macro. Use the execute form together with the list form of the macro for applications that require reentrant code. The execute form of the macro stores the parameters into the storage area defined by the list form, and generates the macro invocation to transfer control to the service.

Use MF=M together with the list and execute forms of the macro for service routines that need to provide different options according to user-provided input. Use the list form to define a storage area; use the modify form to set the appropriate options; then use the execute form to call the service.

IBM recommends that you use the modify and execute forms in the following order:

- Use MF=(M,*list_addr*,COMPLETE), specifying appropriate parameters, including all required ones.
- Use MF=(M,*list_addr*,NOCHECK), specifying the parameters you want to change.
- Use MF=(E,*list_addr*,NOCHECK), to execute the macro.

,list addr

The name of a storage area to contain the parameters.

,attr

An optional 1- to 60-character input string, which can contain any value that is valid on an assembler DS pseudo-op. You can use this parameter to force boundary alignment of the parameter list. If you do not code *attr*, the system provides a value of OD, which forces the parameter list to a doubleword boundary.

,COMPLETE

Specifies that the system is to check for required parameters and supply defaults for omitted optional parameters.

,NOCHECK

Specifies that the system is not to check for required parameters and is not to supply defaults for omitted optional parameters.

ABEND codes

The IXGQUERY service can issue abend X'1C5' with reason code X'0805'. This abend indicates an abend during system logger processing. If you receive this abend, reissue the request. If the problem persists, contact the IBM Support Center.

Return and reason codes

When the IXGQUERY macro returns control to your program:

- GPR 15 (and *retcode*, if you coded RETCODE) contains a return code.

- When the value in GPR 15 is not zero, GPR 0 (and *rsncode*, if you coded RSNCODE) contains a reason code.

00

IxgRetCodeOk - Successful completion

04

IxgRetCodeWarning - The request was processed successfully, however a warning condition was encountered.

08

IxgRetCodeError - An error has been encountered. The associated reason code provides more information.

0C

IxgRetCodeCompError - A system logger component error has been encountered.

The following table contains hexadecimal return and reason codes, the equate symbols associated with each reason code, and the meaning and suggested action for each return and reason code.

<i>Table 44. Return and Reason Codes for the IXGQUERY Macro</i>		
Return Code	Reason Code	Meaning and Action
00	xxxx0000	IxgRsnCodeOk - Explanation: Request processed successfully.
08	xxxx0801	IxgRsnCodeBadParmlist - Explanation: Program error. The parameter list is not valid. Either the parameter list storage is inaccessible, or the version of the macro used was not valid. Action: Ensure that the storage area for the parameter list is accessible to the system logger for the duration of the request, and that the macro version is correct. The parameter list storage must be addressable in the caller's primary address space and in the same key as the caller.
08	xxxx0802	IxgRsnCodeXESEError - Explanation: System error. A severe cross-system extended services (XES) error has occurred. Action: In the answer area mapped by IXGANSAA, see ANSAA_DIAG1 for the XES return code and ANSAA_DIAG2 for the XES reason code.
08	xxxx0803	IxgRsnCodeBadBuffer - Explanation: The virtual storage area specified by the BUFFER keyword not addressable. Action: Ensure the storage area is accessible to the Logger Services for the duration of the request.
08	xxxx0806	IxgRsnCodeBadStmToken - Explanation: Program error. One of the following occurred: <ul style="list-style-type: none"> • The stream token was not valid. • The specified request was issued from an address space other than the connectors address space. Action: Do one of the following: <ul style="list-style-type: none"> • Make sure that the stream token specified is valid. • Ensure that IXGQUERY requests were issued from the connectors address space.
08	xxxx080A	IxgRsnCodeRequestLocked - Explanation: Program error. The program issuing the request is holding a lock. Action: Ensure that the program issuing the request is not holding a lock.

Table 44. Return and Reason Codes for the IXGQUERY Macro (continued)

Return Code	Reason Code	Meaning and Action
08	xxxx080F	<p>IxgRsnCodeBadBufsize -</p> <p>Explanation: The buffer specified (BUFFER or BUFFER64) is not large enough to contain the data being returned. No data is returned.</p> <p>Action: Obtain a buffer of the length of IXGQBUF or IXGQZBUF (as appropriate) and retry the request.</p>
08	xxxx0814	<p>IxgRsnCodeNotAvailForIPL -</p> <p>Explanation: Environment error. The system logger address space is not available for the remainder of this IPL. The system issues messages about this error during system logger initialization.</p> <p>Action: See the explanation for system messages issued during system logger initialization.</p>
08	xxxx0815	<p>IxgRsnCodeNotEnabled -</p> <p>Explanation: Program error. The program issuing the request is not enabled for I/O and external interrupts, so the request fails.</p> <p>Action: Make sure the program issuing the request is enabled for I/O and external interrupts.</p>
08	xxxx0816	<p>IxgRsnCodeBadAnslen -</p> <p>Explanation: Program error. The answer area length (ANSLEN parameter) is not large enough. The system logger returned the required size in the Ansaas_Preferred_Size field of the answer area, mapped by IXGANSAA macro.</p> <p>Action: Reissue the request, specifying an answer area of the required size.</p>
08	xxxx0817	<p>IxgRsnCodeBadAnsarea -</p> <p>Explanation: Program error. The storage area specified on the ANSAREA parameter cannot be accessed. This may occur after the system logger address space has terminated.</p> <p>Action: Specify storage that is in the callers primary address space and in the same key as the calling program at the time the system logger service was issued. This storage must be accessible until the request completes.</p>
08	xxxx0819	<p>IxgRsnCodeSRBMode -</p> <p>Explanation: Program error. The calling program is in SRB mode, but task mode is the required dispatchable unit mode for this system logger service.</p> <p>Action: Make sure the calling program is in task mode.</p>
08	xxxx081B	<p>IxgRsnCodePrimaryNotHome -</p> <p>Explanation: Program error. The primary address space does not equal the home address space.</p> <p>Action: Either make sure that the primary address space equals the home address space when issuing this type of system logger service or perform a log stream connection (IXGCONN connect) request from the same primary address space and then reissue the IXGQUERY request.</p>
08	xxxx082D	<p>IxgRsnCodeExpiredStmToken -</p> <p>Explanation: Environment error. The stream token is no longer valid because the connector has been disconnected.</p> <p>Action: Reconnect to the logstream before issuing any functional requests.</p>
08	xxxx0840	<p>IxgRsnCodeBadVersion -</p> <p>Explanation: Environment error. The parameter list passed to the service routine has an incorrect version indicator.</p> <p>Action: Make sure that the level of MVS executing the request and the macro library used to compile the invoking routine are compatible.</p>

Table 44. Return and Reason Codes for the IXGQUERY Macro (continued)		
Return Code	Reason Code	Meaning and Action
08	xxxx0861	<p>IxgRsnCodeRebuildInProgress -</p> <p>Explanation: Environment error. No requests can be processed for this log stream because a coupling facility structure rebuild is in progress for the structure associated with this log stream.</p> <p>Action: Listen for ENF signal 48 that will indicate one of the following:</p> <ul style="list-style-type: none"> • The log stream is available because the rebuild completed successfully. Reissue the request. • The rebuild failed and the log stream is not available.
08	xxxx0862	<p>IxgRsnCodeXESPurge -</p> <p>Explanation: Environment error. An cross-system extended services (XES) request has been purged due to rebuild processing.</p> <p>Action: Listen for ENF signal 48 that will indicate one of the following:</p> <ul style="list-style-type: none"> • The log stream is available because the rebuild completed successfully. Reissue the request. • The rebuild failed and the log stream is not available.
08	xxxx0863	<p>IxgRsnCodeStructureFailed -</p> <p>Explanation: Environment error. Either the coupling facility structure associated with the log stream has failed or the coupling facility itself has failed.</p> <p>Action: Listen for ENF signal 48 that will indicate one of the following:</p> <ul style="list-style-type: none"> • The log stream is available because the rebuild completed successfully. Reissue the request. • The rebuild failed and the log stream is not available.
08	xxxx0864	<p>IxgRsnCodeNoConnectivity -</p> <p>Explanation: Environment error. No connectivity exists to the coupling facility associated with the log stream. The system logger will either attempt to rebuild the log stream in another coupling facility or the log stream will be disconnected.</p> <p>Action: Listen for ENF signal 48 that will indicate one of the following:</p> <ul style="list-style-type: none"> • The log stream is available because the rebuild completed successfully. Reissue the request. • The rebuild failed and the log stream is not available. • The log stream has been disconnected from this system. <p>If a rebuild initiated because of a loss of connectivity previously failed, an ENF corresponding to this reason code might not be issued. Further action by the installation might be necessary to cause the change of the log stream status again. Check the log for messages IXG101I, IXG107I and related rebuild messages for information on resolving any outstanding issues.</p>
08	xxxx0890	<p>IxgRsnCodeAddrSpaceNotAvail -</p> <p>Explanation: System error. The system logger address space failed and is not available.</p> <p>Action: Do not issue system logger requests.</p>
08	xxxx0891	<p>IxgRsnCodeAddrSpaceInitializing -</p> <p>Explanation: System error. The system logger address space is not available because it is IPLing.</p> <p>Action: Listen for ENF signal 48, which will indicate when the system logger address space is available. Once it's available, reconnect to the log stream, then reissue this request. You can also listen for ENF signal 48, which will indicate if the system logger address space will not be available for the life of the IPL. In that case, do not issue system logger services.</p>

Table 44. Return and Reason Codes for the IXGQUERY Macro (continued)

Return Code	Reason Code	Meaning and Action
08	xxxx081C	<p>Equate Symbol: IxgRsnCodeNotAuthFunc</p> <p>Explanation: Program error. The program connected to the log stream with the AUTH=WRITE parameter and was granted limited access (for example, write only log data and disconnect) as per the defined security access profiles, and then tried to perform a log stream access service other than IXGWRITE or IXGCONN (to disconnect).</p> <p>Action: A connection to the log stream with the appropriate access authority must be established before using the log stream query (IXGQUERY) service. If AUTH=WRITE was already in use when the error was encountered, then check with your installation's security administrator on obtaining the appropriate access to the log stream.</p>
08	xxxx08D3	<p>IxgRsnCodeFuncNotSupported -</p> <p>Explanation: Environment error. An IXGQUERY was issued and the logger inventory CDS is down-level.</p> <p>Action: Format the highest level system logger couple data set supported by the systems in the sysplex and make it the active primary system logger CDS.</p>
0C	xxxx0000	<p>Equate Symbol: IxgRetCodeCompError</p> <p>Explanation: User or System error. One of the following occurred:</p> <ul style="list-style-type: none"> You issued the FORCE IXGLOGR,ARM command to terminate the system logger address space. System logger component error occurred. <p>Action: If this reason code is not the result of forcing the system logger address space, search problem reporting data bases for a fix for the problem. If no fix exists, contact the IBM Support Center. Provide the diagnostic data in the answer area (IXGANSAA) and any dumps or LOGREC entries from system logger.</p>

Examples

Example 1:

Issue IXQUERY to get information about a log stream.

```

IXGQUERY STREAMTOKEN=OTOKEN,           @
      BUFFER=QRYBUFF,                   @
      BUFFLEN=QRYBUFF_LEN,              @
      ANSAREA=XANSAREA,                  @
      ANSLEN=XANSLEN,                    @
      RSNCODE=RSCODE                     @
OTOKEN  DS  CL16                          Output Stream token
QRYBUFF DS  CL(QBUF_LEN)                  IXGQUERY data area
QRYBUFF_LEN DC A(QBUF_LEN)                IXGQUERY data length
XANSAREA DS  CL(ANSAA_LEN)                Logger answer area
XANSLEN  DC  A(ANSAA_LEN)                 Answer area length
RSCODE   DS  F                             Reason code
      DSECT ,
      IXGQBUF ,                             The macro for IXGQUERY data
      IXGANSAA ,                             The answer area macro

```

Example 2:

Issue IXQUERY to get system logger ZAI location (version 1) parameter information.

```

IXGQUERY REQUEST=ZAILOCINFO,           +
      BUFFER64=QRYZAIBUFF,              +
      BUFFLEN=QRYZAIBUFF_LEN,           +
      ANSAREA=XANSAREA,                  +
      ANSLEN=XANSLEN,                    +
      RSNCODE=RSCODE                     +
QRYZAIBUFF DS  CL(IXGQZBUF_VERS1_LENGTH)  output buffer
QRYZAIBUFF_LEN DC A(IXGQZBUF_VERS1_LENGTH)  buffer size
XANSAREA DS  CL(ANSAA_LEN)                Logger answer area

```

IXGQUERY

XANSLEN	DC	A(ANSAA_LEN)	Answer area length
RSCODE	DS	F	Reason code
		DSECT ,	
		IXGQZBUF ,	The macro for IXGQUERY data
		IXGANSAA ,	The answer area mapping
		IXGCON ,	Return/reason codes

Chapter 74. IXGUPDAT – Update log stream control information

Description

The IXGUPDAT macro allows the caller to update the GMT time stamp maintained in the control information for a log stream. When this field is successfully updated, any future log blocks written to the log stream cannot will have a time stamp less than the updated time stamp. (Note that this service does not affect time stamps that the application imbeds in the log block.)

Environment

The requirements for the caller are:

Environmental factor	Requirement
Minimum authorization:	Problem state. Any PSW key
Dispatchable unit mode:	Task
Cross memory mode:	Any PASN, any HASN, any SASN
AMODE:	31-bit or 64-bit
ASC mode:	Primary or access register (AR)
Interrupt status:	Enabled for I/O and external interrupts
Locks:	No locks may be held.
Control parameters:	None.

Programming requirements

- The caller must have a valid connection to the target log stream, specifying AUTH=WRITE.
- The parameter list for this service must be addressable in the caller's primary address space.
- Include the IXGCON mapping macro in your program. This macro provides a list of equate symbols for the system logger services.
- Include mapping macro IXGANSAA in your program. This macro shows the format of the answer area output returned for each system logger service in the ANSAREA parameter.
- The current primary address space must be the same as the HOME address space at the time you issued the IXGCONN macro.

Restrictions

All storage areas specified must be in the same storage key as the caller. Storage areas that must exist in the caller's primary address space.

Input register information

Before issuing the IXGUPDAT macro, the caller does not have to place any information into any register unless using it in register notation for a particular parameter, or using it as a base register.

Output register information

When control returns to the caller, the GPRs contain:

IXGUPDAT

Register Contents

0

Reason code, if register 15 contains a non-zero return code

2-13

Unchanged

14

Used as a work register by the system

15

Return code

When control returns to the caller, the ARs contain:

Register Contents

0-1

Used as a work register by the system

2-13

Unchanged

14-15

Used as a work register by the system

Some callers depend on register contents remaining the same before and after issuing a service. If the system changes the contents of registers on which the caller depends, the caller must save them before issuing the service, and restore them after the system returns control.

Performance implications

None.

Syntax

The IXGUPDAT macro is written as follows:

Syntax	Description
<i>name</i>	<i>name</i> : symbol. Begin <i>name</i> in column 1.
┌	One or more blanks must precede IXGUPDAT.
IXGUPDAT	
┌	One or more blanks must follow IXGUPDAT.
STREAMTOKEN= <i>streamtoken</i>	<i>streamtoken</i> : RS-type address or address in register (2) - (12).
,GMT_TIMESTAMP= <i>gmt_timestamp</i>	
	<i>gmt_timestamp</i> : RS-type address or address in register (2) - (12).

Syntax	Description
,GMT_TIMESTAMP= <u>NO_GMT_TIMESTAMP</u>	
	Default: GMT_TIMESTAMP=NO_GMT_TIMESTAMP
,ANSAREA= <i>ansarea</i>	<i>ansarea</i> : RS-type address or address in register (2) - (12).
,ANSLen= <i>anslen</i>	<i>anslen</i> : RS-type address or address in register (2) - (12).
,RETCODE= <i>retcode</i>	<i>retcode</i> : RS-type address or register (2) - (12).
,RSNCODE= <i>rsncode</i>	<i>rsncode</i> : RS-type address or register (2) - (12).
,PLISTVER= <u>IMPLIED_VERSION</u>	Default: PLISTVER=IMPLIED_VERSION
,PLISTVER=MAX	
,PLISTVER=0	
,MF= <u>S</u>	Default: MF=S
,MF=(L, <i>list addr</i>)	<i>list addr</i> : RS-type address or register (1) - (12).
,MF=(L, <i>list addr</i> , <i>attr</i>)	
,MF=(L, <i>list addr</i> , <u>0D</u>)	
,MF=(E, <i>list addr</i>)	
,MF=(E, <i>list addr</i> , <u>COMPLETE</u>)	
,MF=(E, <i>list addr</i> , <u>NOCHECK</u>)	
,MF=(M, <i>list addr</i>)	
,MF=(M, <i>list addr</i> , <u>COMPLETE</u>)	
,MF=(M, <i>list addr</i> , <u>NOCHECK</u>)	

Parameters

The parameters are explained as follows:

name

An optional symbol, starting in column 1, that is the name on the IXGUPDAT macro invocation. The name must conform to the rules for an ordinary assembler language symbol.

STREAMTOKEN=*streamtoken*

A required input parameter that specifies the log stream token that was returned on the IXGCONN service.

To code: Specify the RS-type address, or address in register (2)-(12), of a 16-character field.

,GMT_TIMESTAMP=*gmt_timestamp***,GMT_TIMESTAMP=NO GMT_TIMESTAMP**

An optional input parameter that lets you modify the GMT time stamp in the coupling facility structure list controls. You must supply a time stamp that is equal to or greater than the current time stamp maintained in the Log Stream Control information. Once modified, the next log blocks written to the log stream will be assigned a GMT time stamp equal to or greater than the one specified on the IXGUPDAT request. The default is NO_GMT_TIMESTAMP.

If NO_Gmt_TimeStamp is specified for GMT_TimeStamp the macro will be invoked as if GMT_TimeStamp was not specified.

To code: Specify the RS-type address, or address in register (2)-(12), of an 8-character field.

,ANSAREA=*ansarea*

A required input parameter of a virtual storage area, called the answer area. The ANSAREA contains additional error status when the IXGUPDAT service generates an error return code. The format of the returned data is defined by the IXGANSAA mapping macro.

To code: Specify the RS-type address, or address in register (2)-(12), of a field.

,ANSLEN=*anslen*

A required input parameter that contains the length in bytes of the virtual storage area provided for ANSAREA.

The length of the answer area is described by the IXGANSAA mapping macro.

To code: Specify the RS-type address, or address in register (2)-(12), of a fullword field.

,RETCODE=*retcode*

An optional output parameter into which the return code is to be copied from GPR 15.

To code: Specify the RS-type address of a fullword field, or register (2)-(12).

,RSNCODE=*rsncode*

An optional output parameter into which the reason code is to be copied from GPR 0.

To code: Specify the RS-type address of a fullword field, or register (2)-(12).

,PLISTVER=IMPLIED_VERSION**,PLISTVER=MAX****,PLISTVER=0**

An optional input parameter that specifies the version of the macro. PLISTVER determines which parameter list the system generates.

The values are:

- **IMPLIED_VERSION**, which is the lowest version that allows all parameters specified on the request to be processed. If you omit the PLISTVER parameter, IMPLIED_VERSION is the default. Note that on the list form, the default will cause the smallest parameter list to be created.
 - **MAX**, if you want the parameter list to be the largest size currently possible. This size might grow from release to release and affect the amount of storage that your program needs.
- If you can tolerate the size change, IBM recommends that you always specify PLISTVER=MAX on the list form of the macro. Specifying MAX ensures that the list-form parameter list is always long enough to hold all the parameters you might specify on the execute form when both forms are assembled using the same level of the system. In this way, MAX ensures that the parameter list does not overwrite nearby storage.
- **0**, which supports all parameters except those referenced in higher versions.

To code: Specify one of the following:

- IMPLIED_VERSION
- MAX
- A decimal value of 0

,MF=S
,MF=(L,list addr)
,MF=(L,list addr,attr)
,MF=(L,list addr,OD)
,MF=(E,list addr)
,MF=(E,list addr,COMPLETE)
,MF=(E,list addr,NOCHECK)
,MF=(M,list addr)
,MF=(M,list addr,COMPLETE)
,MF=(M,list addr,NOCHECK)

Use MF=S to specify the standard form of the macro, which builds an inline parameter list and generates the macro invocation to transfer control to the service. MF=S is the default.

Use MF=L to specify the list form of the macro. Use the list form together with the execute form of the macro for applications that require reentrant code. The list form defines an area of storage that the execute form uses to store the parameters. Only the PLISTVER parameter can be specified on the list form of the macro. IBM recommends that you always specify PLISTVER=MAX on the list form of the macro.

Use MF=E to specify the execute form of the macro. Use the execute form together with the list form of the macro for applications that require reentrant code. The execute form of the macro stores the parameters into the storage area defined by the list form, and generates the macro invocation to transfer control to the service.

Use MF=M together with the list and execute forms of the macro for service routines that need to provide different options according to user-provided input. Use the list form to define a storage area; use the modify form to set the appropriate options; then use the execute form to call the service.

IBM recommends that you use the modify and execute forms in the following order:

- Use MF=(M,*list_addr*,COMPLETE), specifying appropriate parameters, including all required ones.
- Use MF=(M,*list_addr*,NOCHECK), specifying the parameters you want to change.
- Use MF=(E,*list_addr*,NOCHECK), to execute the macro.

,list addr

The name of a storage area to contain the parameters.

,attr

An optional 1- to 60-character input string, which can contain any value that is valid on an assembler DS pseudo-op. You can use this parameter to force boundary alignment of the parameter list. If you do not code *attr*, the system provides a value of OD, which forces the parameter list to a doubleword boundary.

,COMPLETE

Specifies that the system is to check for required parameters and supply defaults for omitted optional parameters.

,NOCHECK

Specifies that the system is not to check for required parameters and is not to supply defaults for omitted optional parameters.

ABEND codes

The IXGUPDAT service can issue abend X'1C5' with reason code X'085F'. This abend indicates an abend during system logger processing. If you receive this abend, reissue the request. If the problem persists, contact the IBM Support Center.

Return and reason codes

When the IXGUPDAT macro returns control to your program:

- GPR 15 (and *retcode*, if you coded RETCODE) contains a return code.

- When the value in GPR 15 is not zero, GPR 0 (and *rsncode*, if you coded RSNCODE) contains a reason code.

00

IxgRetCodeOk - Successful completion

04

IxgRetCodeWarning - The request was processed successfully, however a warning condition was encountered.

08

IxgRetCodeError - An error has been encountered. The associated reason code provides more information.

0C

IxgRetCodeCompError - A system logger component error has been encountered.

The following table contains hexadecimal return and reason codes, the equate symbols associated with each reason code, and the meaning and suggested action for each return and reason code.

<i>Table 45. Return and Reason Codes for the IXGUPDAT Macro</i>		
Return Code	Reason Code	Meaning and Action
00	xxxx0000	IxgRsnCodeOk - Explanation: Request processed successfully.
08	xxxx0801	IxgRsnCodeBadParmlist - Explanation: Program error. The parameter list is invalid. Either the parameter list storage is inaccessible, or an invalid version of the macro was used. Action: Ensure that the storage area for the parameter list is accessible to the system logger for the duration of the request, and that the macro version is correct. The parameter list storage must be addressable in the caller's primary address space and in the same key as the caller.
08	xxxx0802	IxgRsnCodeXESEError - Explanation: System error. A severe cross-system extended services (XES) error has occurred. Action: See ANSAA_DIAG1 for the XES return code and ANSAA_DIAG2 for the XES reason code.
08	xxxx0806	IxgRsnCodeBadStmToken - Explanation: Program error. One of the following occurred: <ul style="list-style-type: none"> • The stream token was not valid. • The specified request was issued from an address space other than the connectors address space. Action: Do one of the following: <ul style="list-style-type: none"> • Make sure that the stream token specified is valid. • Ensure that IXGUPDAT requests were issued from the connectors address space.
08	xxxx080A	IxgRsnCodeRequestLocked - Explanation: Program error. The program issuing the request is holding a lock. Action: Ensure that the program issuing the request is not holding a lock.
08	xxxx0814	IxgRsnCodeNotAvailForIPL - Explanation: Environment error. The system logger address space is not available for the remainder of this IPL. The system issues messages about this error during system logger initialization. Action: See the explanation for system messages issued during system logger initialization.

Table 45. Return and Reason Codes for the IXGUPDAT Macro (continued)

Return Code	Reason Code	Meaning and Action
08	xxxx0815	<p>IxgRsnCodeNotEnabled -</p> <p>Explanation: Program error. The program issuing the request is not enabled for I/O and external interrupts, so the request fails.</p> <p>Action: Make sure the program issuing the request is enabled for I/O and external interrupts.</p>
08	xxxx0816	<p>IxgRsnCodeBadAnslen -</p> <p>Explanation: Program error. The answer area length (ANSLEN parameter) is not large enough. The system logger returned the required size in the Ansaas_Preferred_Size field of the answer area, mapped by IXGANSAA macro.</p> <p>Action: Reissue the request, specifying an answer area of the required size.</p>
08	xxxx0817	<p>IxgRsnCodeBadAnsarea -</p> <p>Explanation: Program error. The storage area specified on the ANSAREA parameter cannot be accessed. This may occur after the system logger address space has terminated.</p> <p>Action: Specify storage that is in the callers primary address space and in the same key as the calling program at the time the system logger service was issued. This storage must be accessible until the request completes.</p>
08	xxxx0819	<p>IxgRsnCodeSRBMode -</p> <p>Explanation: Program error. The calling program is in SRB mode, but task mode is the required dispatchable unit mode for this system logger service.</p> <p>Action: Make sure the calling program is in task mode.</p>
08	xxxx081C	<p>IxgRsnCodeNotAuthFunc -</p> <p>Explanation: Program error. One of the following occurred:</p> <ul style="list-style-type: none"> • The program connected to the log stream with the AUTH=READ parameter and then tried to delete, write, offload or update data. You cannot write, delete, update or offload data when connected with read authority. • The program connected to the log stream with the AUTH=WRITE parameter and was granted limited access (for example, write only log data and disconnect) as per the defined security access profiles, and then tried to perform a log stream access service other than IXGWRITE or IXGCONN (to disconnect). <p>Action: A connection to the log stream with the appropriate access authority must be established before using the log stream update (IXGUPDAT) service. If AUTH=WRITE was already in use when the error was encountered, then check with your installation's security administrator on obtaining the appropriate access to the log stream.</p>
08	xxxx082D	<p>IxgRsnCodeExpiredStmToken -</p> <p>Explanation: Environment error. The stream token is no longer valid because the connector has been disconnected.</p> <p>Action: Reconnect to the logstream before issuing any functional requests.</p>
08	xxxx0840	<p>IxgRsnCodeBadVersion -</p> <p>Explanation: Environment error. The parameter list passed to the service routine has an incorrect version indicator.</p> <p>Action: Make sure that the level of MVS executing the request and the macro library used to compile the invoking routine are compatible.</p>

Table 45. Return and Reason Codes for the IXGUPDAT Macro (continued)		
Return Code	Reason Code	Meaning and Action
08	xxxx0861	<p>IxgRsnCodeRebuildInProgress -</p> <p>Explanation: Environment error. No requests can be processed for this log stream because a coupling facility structure rebuild is in progress for the structure associated with this log stream.</p> <p>Action: Listen for ENF signal 48 that will indicate one of the following:</p> <ul style="list-style-type: none"> • The log stream is available because the rebuild completed successfully. Reissue the request. • The rebuild failed and the log stream is not available.
08	xxxx0862	<p>IxgRsnCodeXESPurge -</p> <p>Explanation: Environment error. An cross-system extended services (XES) request has been purged due to rebuild processing.</p> <p>Action: Listen for ENF signal 48 that will indicate one of the following:</p> <ul style="list-style-type: none"> • The log stream is available because the rebuild completed successfully. Reissue the request. • The rebuild failed and the log stream is not available.
08	xxxx0863	<p>IxgRsnCodeStructureFailed -</p> <p>Explanation: Environment error. Either the coupling facility structure associated with the log stream has failed or the coupling facility itself has failed.</p> <p>Action: Listen for ENF signal 48 that will indicate one of the following:</p> <ul style="list-style-type: none"> • The log stream is available because the rebuild completed successfully. Reissue the request. • The rebuild failed and the log stream is not available.
08	xxxx0864	<p>IxgRsnCodeNoConnectivity -</p> <p>Explanation: Environment error. No connectivity exists to the coupling facility associated with the log stream. The system logger will either attempt to rebuild the log stream in another coupling facility or the log stream will be disconnected.</p> <p>Action: Listen for ENF signal 48 that will indicate one of the following:</p> <ul style="list-style-type: none"> • The log stream is available because the rebuild completed successfully. Reissue the request. • The rebuild failed and the log stream is not available. • The log stream has been disconnected from this system. <p>If a re-build initiated because of a loss of connectivity previously failed, an ENF corresponding to this reason code might not be issued. Further action by the installation might be necessary to cause the change of the log stream status again. Check the log for messages IXG101I, IXG107I and related rebuild messages for information on resolving any outstanding issues.</p>
08	xxxx0890	<p>IxgRsnCodeAddrSpaceNotAvail -</p> <p>Explanation: System error. The system logger address space failed and is not available.</p> <p>Action: Do not issue system logger requests.</p>
08	xxxx0891	<p>IxgRsnCodeAddrSpaceInitializing -</p> <p>Explanation: System error. The system logger address space is not available because it is IPLing.</p> <p>Action: Listen for ENF signal 48, which will indicate when the system logger address space is available. Once it's available, reconnect to the log stream, then reissue this request. You can also listen for ENF signal 48, which will indicate if the system logger address space will not be available for the life of the IPL. In that case, do not issue system logger services.</p>

Table 45. Return and Reason Codes for the IXGUPDAT Macro (continued)

Return Code	Reason Code	Meaning and Action
08	xxxx08DD	<p>IxgRsnCodeUpdateTimeStampTooSmall -</p> <p>Explanation: Program error. The replacement GMT time stamp is smaller than the time stamp maintained in the coupling facility for the log stream. This error can be caused because the application did in fact specify an invalid time stamp or the time stamp value has changed after its current value was retrieved (e.g., via the IXGQUERY service) because a write or another update request was successfully processed for the log stream somewhere in the sysplex.</p> <p>Action: Invoke the IXGQUERY service to obtain the current time stamp value and determine if the update request should be retried.</p>
08	xxxx08DE	<p>IxgRsnCodeUpdateNoOptions -</p> <p>Explanation: Program error. The IXGUPDAT macro was invoked with no options specified.</p> <p>Action - - Specify at least one option and retry the request.</p>
0C	xxxx0000	<p>Equate Symbol: IxgRetCodeCompError</p> <p>Explanation: User or System error. One of the following occurred:</p> <ul style="list-style-type: none"> You issued the FORCE IXGLOGR,ARM command to terminate the system logger address space. System logger component error occurred. <p>Action: If this reason code is not the result of forcing the system logger address space, search problem reporting data bases for a fix for the problem. If no fix exists, contact the IBM Support Center. Provide the diagnostic data in the answer area (IXGANSAA) and any dumps or LOGREC entries from system logger.</p>

Example

Issue IXGUPDAT to update the time stamp for a log stream.

```

IXGUPDAT                                @
      STREAMTOKEN=OTOKEN,                @
      GMT_TIMESTAMP=GMTTIME,              @
      ANSAREA=XANSAREA,                   @
      ANSLEN=XANSLEN,                     @
      RSNCODE=RSCODE                      @
OTOKEN  DS  CL16                          Output Stream token
GMTTIME DS  CL8                            GMT
XANSAREA DS  CL(ANSAA_LEN)                 Logger answer area
XANSLEN DC  A(ANSAA_LEN)                   Answer area length
RSCODE  DS  F                              Reason code
      DSECT ,
IXGANSAA ,                               The answer area macro

```

Chapter 75. IXGWRITE – Write log data to a log stream

Description

Use the IXGWRITE macro to allow a program to write a log block to a log stream. IXGWRITE returns a unique identifier for each log block written to the log stream.

System logger generates a time stamp for each log block as they are received from applications issuing IXGWRITE and writes the blocks to the log stream in that order. Applications that imbed their own time stamps in log blocks will find that the blocks may not be in application-generated time stamp order, especially if multiple applications are writing to a log stream simultaneously. In order to ensure chronological order of log blocks by application-generated time stamp, applications should provide their own serialization on the log stream.

For information on using the system logger services and the LOGR policy, see *z/OS MVS Programming: Assembler Services Guide*, which also includes information about related macros IXGCONN, IXGBRWSE, IXGINVNT, IXGDELETE, and IXGQUERY.

Environment

The requirements for the caller are:

Environmental factor	Requirement
Minimum authorization:	Problem state with any PSW key. The caller must be supervisor state with any system (0-7) PSW key to either invoke this service in SRB mode or to use the MODE=SYNCEXIT keyword.
Dispatchable unit mode:	Task
Cross memory mode:	Any PASN, any HASN, any SASN
AMODE:	31-bit or 64-bit
ASC mode:	Primary or access register (AR)
Interrupt status:	Enabled for I/O and external interrupts.
Locks:	No locks held.
Control parameters:	<p>All control parameters must be in the primary address space with the following exceptions:</p> <ul style="list-style-type: none"> • The ECB should be addressable from the home address space. • Any parameter area that is explicitly ALET-qualified as allowed by the input parameter (for example, the area referenced by the BUFFER parameter when the BUFFALET parameter is specified) must be in an address or data space that is addressable through a public entry on the caller's dispatchable unit access list (DU-AL). All storage areas specified must be in the same storage key as the caller, with the following exception: <ul style="list-style-type: none"> The parameter area is explicitly storage key qualified as allowed by the input parameters (example: the area referenced by the BUFFER parameter when the BUFFKEY parameter is also specified).

Programming requirements

- Before issuing IXGWRITE, you must put the data you wish to write to the log stream into a buffer specified on the BUFFER parameter. IXGWRITE will then write this buffer to the log stream as a log block.
- The current primary address space from which you issue the IXGWRITE service must be the same as the primary address space at the time you issued the IXGCONN request.
- The parameter list for this service must be addressable in the caller's primary address space.
- The calling program must be connected to the log stream with write authority through the IXGCONN service.
- IXGWRITE cannot be issued if the connection is an import connection (IMPORTCONNECT=YES on the IXGCONN service). The IXGWRITE service must be issued under a write connection (IMPORTCONNECT=NO, which is the default).
- Include the IXGCON mapping macro in your program. This macro provides a list of equate symbols for the system logger services.
- Include mapping macro IXGANSAA in your program. This macro shows the format of the answer area output returned for each system logger service in the ANSAREA parameter.
- When coding the MODE=SYNCECB and ECB parameters, you must ensure that:
 - The virtual storage area specified for the ECB resides on a full word boundary.
 - You initialize the ECB field to zero.
 - The ECB resides in either the common or home address space storage at the time the IXGWRITE request is issued.
 - The storage used for output parameters, such as ANSAREA, RETBLOCKID, and TIMESTAMP, are accessible by both the IXGWRITE invoker and the ECB waiter.

Restrictions

- All storage areas specified on this macro must be in the same storage key as the caller's storage key, with the exception of the BUFFKEY parameter.
Storage areas that are not ALET-qualified must exist in the caller's primary address space. The ECB should be addressable from the home address space.
- There is more than one version of this macro available. The parameters you can use depend on the version you specify on the PLISTVER parameter. See the description of the PLISTVER parameter for more information.
- You can call any of the system logger services in either AMODE 31 or 64, but the parameter list and all other data addresses, with the exception of BUFFER64 must reside in 31-bit storage.

Input register information

Before issuing the IXGWRITE macro, the caller does not have to place any information into any register unless using it in register notation for a particular parameter, or using it as a base register.

Output register information

When control returns to the caller, the GPRs contain:

Register

Contents

0

Reason code, if register 15 contains a non-zero return code

1

Used as a work register by the system

2-13

Unchanged

14

Used as a work register by the system

15

Return code

When control returns to the caller, the ARs contain:

**Register
Contents**

0-1

Used as a work register by the system

2-13

Unchanged

14-15

Used as a work register by the system

Some callers depend on register contents remaining the same before and after issuing a service. If the system changes the contents of registers on which the caller depends, the caller must save them before issuing the service, and restore them after the system returns control.

Performance implications

None.

Syntax

The standard form of the IXGWRITE macro is written as follows:

Syntax	Description
<i>name</i>	<i>name</i> : symbol. Begin <i>name</i> in column 1.
␣	One or more blanks must precede IXGWRITE.
IXGWRITE	
␣	One or more blanks must follow IXGWRITE.
,STREAMTOKEN= <i>streamtoken</i>	<i>streamtoken</i> : RS-type address or register (2) - (12).
,BUFFER= <i>buffer</i>	<i>buffer</i> : RS-type address or register (2) - (12).
BUFFER64= <i>buffer64</i>	<i>buffer64</i> : RS-type address or register (2) - (12).
,BLOCKLEN= <i>blocklen</i>	<i>blocklen</i> : RS-type address or register (2) - (12).
,RETBLOCKID= <i>retblockid</i>	<i>retblockid</i> : RS-type address or register (2) - (12).

IXGWRITE macro

Syntax	Description
,ANSAREA= <i>ansarea</i>	<i>ansarea</i> : RS-type address or register (2) - (12).
,ANSLEN= <i>anslen</i>	<i>anslen</i> : RS-type address or register (2) - (12).
,TIMESTAMP= <i>timestamp</i>	<i>timestamp</i> : RS-type address or register (2) - (12). Default: NO_TIMESTAMP
MODE=SYNC	Default: MODE=SYNC
MODE=ASYNCRESPONSE	
MODE=SYNCECB	
,ECB= <i>ecb</i>	<i>ecb</i> : RS-type address or register (2) - (12).
,PLISTVER=IMPLIED_VERSION	
,PLISTVER=MAX	Default: IMPLIED_VERSION
,PLISTVER= <i>plistver</i>	
,PLISTVER=0	
,PLISTVER=1	
,RETCODE= <i>retcode</i>	<i>retcode</i> : RS-type address or register (2) - (12).
,RSNCODE= <i>rsncode</i>	<i>rsncode</i> : RS-type address or register (2) - (12).
,MF=S	Default: MF=S
,MF=(L, <i>list addr</i>)	
,MF=(L, <i>list addr,attr</i>)	
,MF=(L, <i>list addr,OD</i>)	
,MF=(E, <i>list addr</i>)	
,MF=(E, <i>list addr,COMPLETE</i>)	
,MF=(E, <i>list addr,NOCHECK</i>)	
,MF=(M, <i>list addr</i>)	
,MF=(M, <i>list addr,COMPLETE</i>)	
,MF=(M, <i>list addr,NOCHECK</i>)	

Parameters

The parameters are explained as follows:

,STREAMTOKEN=*streamtoken*

Specifies the name (or address in a register) of a required 16-byte input field containing the token for the log stream that you want to write to. The stream token is returned by the IXGCONN service at connection to the log stream.

,BUFFER=*buffer*

,BUFFER64=*buffer64*

Specifies the field name (or address in a register) of the data to be written to the log.

- **BUFFER=*buffer*** specifies that the location of the buffer is in 31-bit storage.
- **BUFFER64=*buffer64*** specifies that the location of the buffer is in 64-bit storage.

The BUFFER and BUFFER64 parameters are mutually exclusive.

,BLOCKLEN=*blocklen*

Specifies the name (or address in a register) of a 4-byte input field that contains the length in bytes of the log block you are writing to the log stream.

The value of BLOCKLEN must be between 1 and the value for MAXBUFSIZE.

RETBLOCKID=*retblockid*

Specifies the name (or address in a register) of a 8-byte output field where IXGWRITE returns the unique block identifier for the log block written to the log stream.

,ANSAREA=*ansarea*

Specifies the name (or address in a register) of an answer area containing information about this request. The answer area must be at least 40 bytes. To map this information, use the IXGANSAA macro.

,ANSLEN=*anslen*

Specifies the name (or address in a register) of the 4-byte field containing the answer area length. The length of the answer area must be at least 40 bytes and must be the same length as the field specified in ANSAREA.

To ascertain the optimal answer area length, look at the ANSAA_PREFERRED_SIZE field of the IXGANSAA macro.

TIMESTAMP=*timestamp*

Specifies the name (or address in a register) of a 16-byte output field where the Greenwich mean time and local time stamps associated with the requested log block are returned when the write request is successful. Both time stamps will be in time of day (TOD) clock format.

MODE=SYNC

MODE=ASYNCRESPONSE

MODE=SYNCECB

Specifies that the request should be processed in one of the following ways:

- **MODE=SYNC**: Specifies that the request process synchronously. Control is not returned to the caller until request processing is complete. If necessary, the calling program will be suspended until the request completes.
- **MODE=ASYNCRESPONSE**: Specifies that the request process asynchronously. The caller is not notified when the request completes and the answer area (ANSAREA) fields will not contain valid information.
- **MODE=SYNCECB**: Specifies that the request process synchronously if possible. If the request processes asynchronously, control returns to the caller before the request completes and the event control block (ECB) specified on the ECB keyword is posted when the request completes. The ECB keyword is required with **MODE=SYNCECB**.

,ECB=*ecb*

Specifies the name (or address in a register) of a 4-byte input field that contains the event control block (ECB) to be posted when the request completes.

Before coding ECB, you must ensure that:

- You initialize the ECB to zero.
- The ECB must reside in either common storage or the home address space where the IXGWRITE service was issued.
- The virtual storage area specified for the ECB must reside on a fullword boundary.

,PLISTVER=IMPLIED_VERSION**,PLISTVER=MAX****,PLISTVER=0****,PLISTVER=1**

An optional input parameter that specifies the version of the macro. PLISTVER determines which parameter list the system generates.

The values are:

- **IMPLIED_VERSION**, which is the lowest version that allows all parameters specified on the request to be processed. If you omit the PLISTVER parameter, IMPLIED_VERSION is the default. Note that on the list form, the default will cause the smallest parameter list to be created.
- **MAX**, if you want the parameter list to be the largest size currently possible. This size might grow from release to release and affect the amount of storage that your program needs.

If you can tolerate the size change, IBM recommends that you always specify PLISTVER=MAX on the list form of the macro. Specifying MAX ensures that the list-form parameter list is always long enough to hold all the parameters you might specify on the execute form when both forms are assembled using the same level of the system. In this way, MAX ensures that the parameter list does not overwrite nearby storage.

- **0**, which supports all parameters except those specifically referenced in higher versions.
- **1**, which supports both the following parameters and parameters from version 0:
 - REQDATA

To code: Specify in this input parameter one of the following:

- IMPLIED_VERSION
- MAX
- A decimal value of 0 or 1

,RETCODE=*retcode*

Specifies a name (or address in a register) of a 4-byte output field where the system will place the return code. The return code is also in general purpose register (GPR) 15.

,RSNCODE=*rsncode*

Specifies a name (or address in a register) of a 4-byte output field where the system will place the reason code. The reason code is also in general purpose register (GPR) 0, if you received a non-zero return code.

,MF=S
,MF=(L,list addr)
,MF=(L,list addr,attr)
,MF=(L,list addr,OD)
,MF=(E,list addr)
,MF=(E,list addr,COMPLETE)
,MF=(E,list addr,NOCHECK)
,MF=(M,list addr)
,MF=(M,list addr,COMPLETE)
,MF=(M,list addr,NOCHECK)

Use MF=S to specify the standard form of the macro, which builds an inline parameter list and generates the macro invocation to transfer control to the service. MF=S is the default.

Use MF=L to specify the list form of the macro. Use the list form together with the execute form of the macro for applications that require reentrant code. The list form defines an area of storage that the execute form uses to store the parameters. Only the PLISTVER parameter can be specified on the list form of the macro. IBM recommends that you always specify PLISTVER=MAX on the list form of the macro.

Use MF=E to specify the execute form of the macro. Use the execute form together with the list form of the macro for applications that require reentrant code. The execute form of the macro stores the parameters into the storage area defined by the list form, and generates the macro invocation to transfer control to the service.

Use MF=M together with the list and execute forms of the macro for service routines that need to provide different options according to user-provided input. Use the list form to define a storage area; use the modify form to set the appropriate options; then use the execute form to call the service.

IBM recommends that you use the modify and execute forms in the following order:

- Use MF=(M,*list_addr*,COMPLETE), specifying appropriate parameters, including all required ones.
- Use MF=(M,*list_addr*,NOCHECK), specifying the parameters you want to change.
- Use MF=(E,*list_addr*,NOCHECK), to execute the macro.

,list addr

The name of a storage area to contain the parameters.

,attr

An optional 1- to 60-character input string, which can contain any value that is valid on an assembler DS pseudo-op. You can use this parameter to force boundary alignment of the parameter list. If you do not code *attr*, the system provides a value of OD, which forces the parameter list to a doubleword boundary.

,COMPLETE

Specifies that the system is to check for required parameters and supply defaults for omitted optional parameters.

,NOCHECK

Specifies that the system is not to check for required parameters and is not to supply defaults for omitted optional parameters.

ABEND codes

None.

Return and reason codes

When IXGWRITE macro returns control to your program, GPR 15 contains a return code and GPR 0 contains a reason code.

Note: A program invoking the IXGWRITE service may indicate through the MODE parameter that requests which can not be completed synchronously should have control returned to the caller prior to completion

of the request. When the request does complete, the invoker will be notified and the return and reason codes are in the answer area mapped by IXGANSAA.

The IXGCON macro provides equate symbols for the return and reason codes. The equate symbols associated with each hexadecimal return code are as follows:

00

IXGRSNCODEOK - Successful completion.

04

IXGRSNCODEWARNING - The request was processed successfully, however a warning condition was encountered.

08

IXGRETCODEERROR - An error has been encountered. The associated reason code provides more information.

0C

IXGRETCODECOMPERROR - A system logger component error has been encountered.

The following table contains hexadecimal return and reason codes, the equate symbols associated with each reason code, and the meaning and suggested action for each return and reason code.

<i>Table 46. Return and reason codes for the IXGWRITE macro</i>		
Return code	Reason code	Meaning and action
00	xxxx0000	Equate symbol: IxgRsnCodeOk Explanation: Request processed successfully.
04	xxxx0401	Equate symbol: IxgRsnCodeProcessedAsynch Explanation: The program specified MODE=SYNCECB or MODE=ASYNCRESPONSE and the request must be processed asynchronously. Action: For MODE=SYNCECB, wait for the ECB specified on the ECB parameter to be posted, indicating that the request is complete. Check the ANSAA_ASYNC_RETCODE and ANSAA_ASYNC_RSNCODE fields, mapped by IXGANSAA, to determine whether the request completed successfully.
04	xxxx0405	Equate symbol: IxgRsnCodeWarningLossOfData Explanation: Environment error. Returned for READCURSOR, START OLDEST and RESET OLDEST requests. This condition occurs when a system and coupling facility fail and not all of the log data in the log stream could be recovered. <ul style="list-style-type: none">• For READCURSOR: A log block has been returned, but there may be log blocks permanently missing between this log block and the one previously returned.• For START OLDEST and RESET OLDEST: The oldest log blocks in the log stream may be permanently missing, the browse cursor is set at the oldest available log block. Action: If your application cannot tolerate any data loss, stop issuing system logger services to this log stream, disconnect from the log stream, and reconnect to a new, undamaged log stream. You can continue using the log stream if your applications can tolerate data loss.
04	xxxx0407	Equate symbol: IxgRsnCodeConnPossibleLossOfData Explanation: Environment error. The request was successful, but there may be log blocks permanently missing between this log block and the one previously returned. This condition occurs when a system or coupling facility fails and not all of the data in the log stream could be recovered. Action: If your application cannot tolerate any data loss, stop issuing system logger services to this log stream, disconnect from the log stream, and reconnect to a new, undamaged log stream. You can continue using the log stream if your applications can tolerate data loss.

Table 46. Return and reason codes for the IXGWRITE macro (continued)

Return code	Reason code	Meaning and action
04	xxxx0408	<p>Equate symbol: IxgRsnCodeDsDirectoryFullWarning</p> <p>Explanation: Environment error. The request was successful, but the log streams DASD data set directory is full. System logger cannot offload any further data from the coupling facility structure to DASD. The system logger will continue to process IXGWRITE requests until this log streams portion of the coupling facility structure becomes full.</p> <p>Action: Either delete enough data from the log stream to free up space in the log streams data set directory so that offloading can occur or disconnect from the log stream.</p>
04	xxxx0409	<p>Equate symbol: IxgRsnCodeWowWarning</p> <p>Explanation: Environment error. The request was successful, but an error condition was detected during a previous offload of data. System logger might not be able to offload further data. System logger will continue to process IXGWRITE requests only until the interim storage for the log stream is filled. (Interim storage is the coupling facility for a coupling facility log stream and local storage buffers for a DASD-only log stream.)</p> <p>Action: Do not issue any further requests for this log stream and disconnect. Connect to another log stream. Check the system log for message IXG301I to determine the cause of the error. If you cannot fix the error, search problem reporting data bases for a fix for the problem. If no fix exists, contact the IBM Support Center.</p>
04	000040A	<p>Equate symbol: IxgRsnCodeDuplexFailureWarning</p> <p>Explanation: Environment error. The request was successful, but the system logger was unable to duplex log data to staging data sets, even though the log stream definition requested unconditional duplexing to staging data sets by specifying the log stream attributes: STG_DUPLEX=YES, DUPLEXMODE=UNCOND, or STG_DUPLEX=YES,DUPLEXMODE=DRXRC. When DUPLEXMODE=UNCOND is specified, but Logger was unable to obtain a staging data set to duplex the log data. Therefore, the Logger duplexing is being done in local buffers (data space).</p> <p>When DUPLEXMODE=DRXRC is specified for a logstream and being used for (non-local) disaster recovery duplexing, if the internal buffers used for asynchronous buffering of the log blocks become full. Meaning the internal buffers became full before at least one of the full buffers could be written to the staging data set.</p> <p>Action: For DUPLEXMODE=UNCOND, if duplexing to staging data sets is required, disconnect from this log stream and connect to a log stream that can be duplexed to staging data sets.</p> <p>For DUPLEXMODE=DRXRC, if duplexing to a DRXRC-type staging data sets is required, then cause the log data to be offload to the log stream secondary storage (offload data sets) and then continue writing to the log stream.</p>
08	xxxx0801	<p>Equate symbol: IxgRsnCodeBadParmlist</p> <p>Explanation: Program error. The parameter list could not be accessed.</p> <p>Action: Ensure that the storage area for the parameter list is accessible to the system logger for the duration of the request. The parameter list storage must be addressable in the caller's primary address space and in the same key as the caller.</p>
08	xxxx0802	<p>Equate symbol: IxgRsnCodeXESError</p> <p>Explanation: System error. A severe cross-system extended services (XES) error has occurred.</p> <p>Action: See ANSAA_DIAG1 for the XES return code and ANSAA_DIAG2 for the XES reason code.</p>

Table 46. Return and reason codes for the IXGWRITE macro (continued)		
Return code	Reason code	Meaning and action
08	xxxx0803	<p>Equate symbol: IxgRsnCodeBadBuffer</p> <p>Explanation: Program error. The virtual storage area specified on the BUFFER or BUFFER64 parameter is not addressable.</p> <p>Action: Ensure that the storage area specified on the BUFFER or BUFFER64 parameter is accessible to system logger for the duration of the request. If the BUFFKEY parameter is specified, make sure it contains a valid key associated with the storage area. If BUFFKEY is not used, ensure that the storage is in the same key as the program at the time the logger service was requested. The storage must be addressable in the caller's primary address space.</p>
08	xxxx0806	<p>Equate symbol: IxgRsnCodeBadStmToken</p> <p>Explanation: Program error. One of the following occurred:</p> <ul style="list-style-type: none"> • The stream token was not valid. • The specified request was issued from an address space other than the connector's address space. <p>Action: Do one of the following:</p> <ul style="list-style-type: none"> • Make sure that the stream token specified is valid. • Ensure the request was issued from the connector's address space.
08	xxxx0809	<p>Equate symbol: IxgRsnCodeBadWriteSize</p> <p>Explanation: Program error. The size of the log block specified in the BLOCKLEN parameter is not valid. The value for BLOCKLEN must be greater than zero and less than or equal to the maximum buffer size (MAXBUFSIZE) defined in the active system logger couple data set policy for the log stream or for the structure associated with this log stream.</p> <p>Action: Ensure that the value specified on the BLOCKLEN parameter is greater than 0 and less than or equal to the MAXBUFSIZE which is returned on the log stream connect request.</p>
08	xxxx080A	<p>Equate symbol: IxgRsnCodeRequestLocked</p> <p>Explanation: Program error. The program issuing the request is holding a lock.</p> <p>Action: Ensure that the program issuing the request is not holding a lock.</p>
08	xxxx0814	<p>Equate symbol: IxgRsnCodeNotAvailForIPL</p> <p>Explanation: Environment error. The system logger address space is not available for the remainder of this IPL. The system issues messages about this error during system logger initialization.</p> <p>Action: See the explanation for system messages issued during system logger initialization.</p>
08	xxxx0815	<p>Equate symbol: IxgRsnCodeNotEnabled</p> <p>Explanation: Program error. The program issuing the request is not enabled for I/O and external interrupts, so the request fails.</p> <p>Action: Make sure the program issuing the request is enabled for I/O and external interrupts.</p>
08	xxxx0816	<p>Equate symbol: IxgRsnCodeBadAnslen</p> <p>Explanation: Program error. The answer area length (ANSLEN parameter) is not large enough. The system logger returned the required size in the Ansaas_Preferred_Size field of the answer area, mapped by IXGANSAA macro.</p> <p>Action: Re-issue the request, specifying an answer area of the required size.</p>

Table 46. Return and reason codes for the IXGWRITE macro (continued)

Return code	Reason code	Meaning and action
08	xxxx0817	<p>Equate symbol: IxgRsnCodeBadAnsarea</p> <p>Explanation: Program error. The storage area specified on the ANSAREA parameter cannot be accessed. This may occur after the system logger address space has terminated.</p> <p>Action: Specify storage that is in the caller's primary address space and in the same key as the calling program at the time the system logger service was issued. This storage must be accessible until the request completes.</p>
08	xxxx0818	<p>Equate symbol: IxgRsnCodeBadBlockidStor</p> <p>Explanation: Program error. The storage area specified by BLOCKID cannot be accessed.</p> <p>Action: Ensure that the storage area is accessible to system logger for the duration of the request. The storage must be addressable in the caller's primary address space and in the same key as the caller.</p>
08	xxxx081C	<p>Equate symbol: IxgRsnCodeNotAuthFunc</p> <p>Explanation: Program error. The program connected to the log stream with the AUTH=READ parameter and then tried to delete or write data. You cannot write or delete data when connected with read authority.</p> <p>Action: Issue the IXGCONN service with AUTH=WRITE authority and then re-issue this request.</p>
08	xxxx082D	<p>Equate symbol: IxgRsnCodeExpiredStmToken</p> <p>Explanation: Environment error. The stream token is no longer valid because the connector has been disconnected.</p> <p>Action: Connect to the log stream again before issuing any functional requests.</p>
08	xxxx0837	<p>Equate symbol: IxgRsnCodeBadTimestamp</p> <p>Explanation: Program error. The storage area specified by TIMESTAMP cannot be accessed.</p> <p>Action: Ensure that the storage area is accessible to the system logger service for the duration of the request. The storage must be addressable in the caller's primary address space and in the same key as the caller.</p>
08	xxxx083D	<p>Equate symbol: IxgRsnCodeBadECBStor</p> <p>Explanation: Program error. The ECB storage area was not accessible to the system logger.</p> <p>Action: Ensure that the storage area is accessible to the system logger for the duration of the request. The storage must be addressable in the caller's home address space and in the same key as the caller.</p>
08	xxxx083F	<p>Equate symbol: IxgRsnCodeTestartError</p> <p>Explanation: System error. An unexpected error was encountered while attempting to validate the buffer ALET.</p> <p>Action: See ANSAA_DIAG1 in the answer area mapped by the IXGANSAA macro for the return code from the TESTART system service.</p>
08	xxxx0841	<p>Equate symbol: IxgRsnCodeBadBufferAlet</p> <p>Explanation: Program error. The buffer ALET specified is not zero and does not represent a valid entry on the caller's dispatchable unit access list (DUAL). See the ANSAA_DIAG1 field of the answer area, mapped by the IXGANSAA macro, for the return code from the TESTART system service.</p> <p>Action: Ensure that the correct ALET was specified. If not, provide the correct ALET. Otherwise, add the correct ALET to dispatchable unit access list (DUAL).</p>

Table 46. Return and reason codes for the IXGWRITE macro (continued)		
Return code	Reason code	Meaning and action
08	xxxx0849	<p>Equate symbol: IxgRsnCodeBadBuffkey</p> <p>Explanation: Program error. The buffer key specified on the BUFFKEY parameter specifies an invalid key. Either the key is greater than 15 or the program is running in problem state and the specified key is not the same key as the PSW key at the time the system logger service was issued.</p> <p>Action: For problem state programs, either do not specify the BUFFKEY parameter or else specify the same key as the PSW key at the time the system logger service was issued. For supervisor state programs, specify a valid storage key (0 <= key <= 15).</p>
08	xxxx084E	<p>Equate symbol: IXGRSNCODESTRSACETOOSMALL</p> <p>Explanation: Environment error. Structure resources are not available to satisfy the request. All structure resources are allocated as system logger control resources. This condition occurs when the structure resources are consumed by the logstreams connections.</p> <p>Action: Increase the size of the structure in the CFRM policy or use the SETXCF ALTER command to dynamically increase the size of the structure.</p>
08	xxxx085C	<p>Equate symbol: IxgRsnCodeDsDirectoryFull</p> <p>Explanation: Environment error. The interim storage (for example: the coupling facility structure space allocated or the staging data set space) for the log stream is full. System logger's attempts to offload the interim storage log data to DASD has failed because the log stream's data set directory is full. If this reason code is issued by the IXGWRITE request, no further write requests can be processed until additional directory space is available for the log stream.</p> <p>System logger will periodically re-drive its offload attempts for this condition, which is applicable to both coupling facility structure and DASD-only type log streams. If system logger is able to offload log data, then an ENF event will be issued informing the connectors that the log stream should be available for writing more log data. However, the time that passes before you can write to the log stream is unpredictable.</p> <p>The system issues related messages IXG257I, IXG261E, IXG262A and IXG301I.</p> <p>Action: The system programmer must make more log stream data set directory space available.</p> <p>For information about how an authorized application program might respond to this reason code, see Setting up the system logger configuration in the <i>z/OS MVS Programming: Authorized Assembler Services Guide</i>.</p> <p>For information about how an unauthorized application program might respond to this reason code, see IXGWRITE: Writing to a log stream in the <i>z/OS MVS Programming: Assembler Services Guide</i>.</p>

Table 46. Return and reason codes for the IXGWRITE macro (continued)

Return code	Reason code	Meaning and action
08	xxxx085D	<p>Equate symbol: IxgRsnCodeWowError</p> <p>Explanation: Environment error. The interim storage (for example: the coupling facility structure space allocated or the staging data set space) for the log stream is full. System logger's attempts to offload the interim storage log data to DASD have failed because of severe errors. No further write requests can be processed until the offload error condition is cleared.</p> <p>System logger will periodically re-drive its offload attempts for this condition, which is applicable to both coupling facility structure and DASD-only type log streams. If system logger is able to offload log data, then an ENF event will be issued informing the connectors that the log stream should be available for writing more log data. However, the time that passes before you can write to the log stream is unpredictable.</p> <p>The system issues related message IXG301I.</p> <p>Action: The system programmer must correct the severe error condition inhibiting the log stream offload. If you are unable to correct the error, search problem reporting data bases for a fix for the problem. If no fix exists, contact the IBM Support Center.</p> <p>You can retry your write request periodically or wait for the ENF signal that the log stream is available, or disconnect from this log stream and connect to another log stream.</p> <p>For information on how an authorized application program might respond to this reason code, see Setting up the system logger configuration in the z/OS MVS Programming: Authorized Assembler Services Guide.</p> <p>For information on how an authorized application program might respond to this reason code, see IXGWRITE: Writing to a log stream in the z/OS MVS Programming: Assembler Services Guide.</p>
08	xxxx0860	<p>Equate symbol: IxgRsnCodeCFLogStreamStorFull</p> <p>Explanation: Environment error. The coupling facility structure space allocated for this log stream is full. No further requests can be processed until the log data in the coupling facility structure is offloaded to DASD log data sets.</p> <p>Action: Listen to the ENF signal 48 which will indicate that the log stream is available after the data has been offloaded to DASD. For IXGCONN requests, Listen to the ENF signal 48 which will indicate that the structure is available. Then, re-issue the request.</p>
08	xxxx0861	<p>Equate symbol: IxgRsnCodeRebuildInProgress</p> <p>Explanation: Environment error. No requests can be processed for this log stream because a coupling facility structure re-build is in progress for the structure associated with this log stream.</p> <p>Action: Listen for ENF signal 48 that will indicate one of the following:</p> <ul style="list-style-type: none"> • The log stream is available because the re-build completed successfully. Re-issue the request. • The re-build failed and the log stream is not available.
08	xxxx0862	<p>Equate symbol: IxgRsnCodeXESPurge</p> <p>Explanation: Environment error. An cross-system extended services (XES) request has been purged due to re-build processing.</p> <p>Action: Listen for ENF signal 48 that will indicate one of the following:</p> <ul style="list-style-type: none"> • The log stream is available because the re-build completed successfully. Re-issue the request. • The re-build failed and the log stream is not available.

Table 46. Return and reason codes for the IXGWRITE macro (continued)		
Return code	Reason code	Meaning and action
08	xxxx0863	<p>Equate symbol: IxgRsnCodeStructureFailed</p> <p>Explanation: Environment error. Either the coupling facility structure associated with the log stream has failed or the coupling facility itself has failed.</p> <p>Action: Listen for ENF signal 48 that will indicate one of the following:</p> <ul style="list-style-type: none"> • The log stream is available because the re-build completed successfully. Re-issue the request. • The re-build failed and the log stream is not available.
08	xxxx0864	<p>Equate symbol: IxgRsnCodeNoConnectivity</p> <p>Explanation: Environment error. No connectivity exists to the coupling facility associated with the log stream. The system logger will either attempt to re-build the log stream in another coupling facility or the log stream will be disconnected.</p> <p>Action: Listen for ENF signal 48 that will indicate one of the following:</p> <ul style="list-style-type: none"> • The log stream is available because the re-build completed successfully. Re-issue the request. • The re-build failed and the log stream is not available. • The log stream has been disconnected from this system. <p>If a re-build initiated because of a loss of connectivity previously failed, an ENF corresponding to this reason code might not be issued. Further action by the installation might be necessary to cause the change of the log stream status again. Check the log for messages IXG101I, IXG107I and related rebuild messages for information on resolving any outstanding issues.</p>
08	xxxx0865	<p>Equate symbol: IxgRsnCodeStagingDSFull</p> <p>Explanation: Environment error. The staging data set allocated for this log stream on this system is full. No further requests can be processed until enough log data in the coupling facility structure is offloaded to DASD log data sets to relieve the staging data set's full condition.</p> <p>Action: Listen to the ENF signal 48 which will indicate that the log stream is available after room becomes available in the staging data set. Then, re-issue the request.</p>

Table 46. Return and reason codes for the IXGWRITE macro (continued)

Return code	Reason code	Meaning and action
08	xxxx0867	<p>Equate symbol: IxgRsnCodeLocalBufferFull</p> <p>Explanation: Environment error. One of the two following problems was detected:</p> <ul style="list-style-type: none"> The available local buffer space (data space storage) for the system logger address space is full. Ansaas_Diag1 and Ansaas_Diag2 in the Answer Area will contain 0 for this error return. The IXGWRITE is rejected because a caller attempted to write log data when the outstanding asynchronous write activity for this connection was considered too high. The limit for unauthorized IXGWRITE invokers is 2,000 and the limit of 10,000 is used for authorized callers. An unauthorized caller is a caller whose PSW key is ≥ 8 and that is not in supervisor state. ANSAA_DIAG1 in the answer area contains a value of 1 for this error return for unauthorized callers and a value of 2 for authorized callers. ANSAA_DIAG2 contains the total number of outstanding write requests for this connection. <p>No further writing requests can be processed until the log data in the local buffer space is offloaded to DASD log data sets or this connector's prior IXGWRITE requests complete.</p> <p>Note: This reason code applies to both CF and DASD only log stream requests.</p> <p>Action:</p> <ul style="list-style-type: none"> For authorized writers: Listen for the ENF signal 48 that will indicate that the log stream is available. With the first condition, logger issues the ENF signal after the data has been offloaded to DASD. With the second condition, logger issues the ENF signal 48 that the log stream is available when the number of in-flight authorized asynchronous writes is reduced below 85% of the limit. There will be no ENF signal issued when the unauthorized limit is relieved. For unauthorized callers: Wait for a short interval and then reissue the request. If the attempts continue to fail or the ENF signal is not issued for an unacceptable period, consider notifying operations or disconnecting from the log stream.
08	xxxx0868	<p>Equate symbol: IxgRsnCodeStagingDSFormat</p> <p>Explanation: Environment error. The staging data set allocated for this log stream on this system has not finished being formatted for use by System Logger. No further IXGWRITE requests can be processed until the formatting completes.</p> <p>Action: Listen to the ENF signal 48 which will indicate that the logstream is available after formatting process is finished. Then, re-issue the request.</p>
08	xxxx0890	<p>Equate symbol: IxgRsnCodeAddrSpaceNotAvail</p> <p>Explanation: System error. The system logger address space failed and is not available.</p> <p>Action: Do not issue system logger requests.</p>
08	xxxx0891	<p>Equate symbol: IxgRsnCodeAddrSpaceInitializing</p> <p>Explanation: System error. The system logger address space is not available because it is IPLing.</p> <p>Action: Listen for ENF signal 48, which will indicate when the system logger address space is available. Re-connect to the log stream, then re-issue this request. You can also listen for ENF signal 48, which will indicate if the system logger address space will not be available for the life of the IPL. In that case, do not issue system logger services.</p>

Table 46. Return and reason codes for the IXGWRITE macro (continued)

Return code	Reason code	Meaning and action
08	xxxx08D1	<p>Equate symbol: IxgRsnCodePrgramKey</p> <p>Explanation: Environment error. The request was rejected because of one of the following:</p> <ul style="list-style-type: none"> The request was issued in SRB mode while the requestor was in problem program key (key 8-F). The SYNCEXIT parameter was specified while the requestor's PSW key was in problem program key. <p>Action: Change the invoking environment to a system key (key 0-7).</p>
08	xxxx08D2	<p>Equate symbol: IxgRsnCodeNoCompleteExit</p> <p>Explanation: Program error. MODE=SYNCEXIT was specified, but the connection request did not identify a complete exit.</p> <p>Action: Either change this request to a different MODE option, or reconnect to the log stream with a complete exit specified on the COMPLETEXIT parameter.</p>
08	xxxx08D7	<p>Equate symbol: IxgRsnCodeRequestNotAllowed</p> <p>Explanation: Program error. The caller issued an IXGWRITE request while an import connection was active on this system (IXGCONN IMPORTCONNECT=YES).</p> <p>Action: Re-issue the request, based on the type of connection active.</p>
0C	xxxx0000	<p>Equate symbol: IxgRetCodeCompError</p> <p>Explanation: User or System error. One of the following occurred:</p> <ul style="list-style-type: none"> You issued the FORCE IXGLOGR,ARM command to terminate the system logger address space. System logger component error occurred. <p>Action: If this reason code is not the result of forcing the system logger address space, search problem reporting data bases for a fix for the problem. If no fix exists, contact the IBM Support Center. Provide the diagnostic data in the answer area (IXGANSAA) and any dumps or LOGREC entries from system logger.</p>

Example 1

Write data to the log stream synchronously.

```

IXGWRITE STREAMTOKEN=TOKEN,           X
      BUFFER=BUFFER,                   X
      BLOCKLEN=BLKLEN,                  X
      BUFALET=BUFALET,                  X
      RETBLOCKID=RETBK,                  X
      BUFKEY=BUFKEY,                    X
      TIMESTAMP=RET_TIME,                X
      MODE=SYNC,                         X
      ANSAREA=ANSAREA,                   X
      ANSLEN=ANSLEN,                     X
      RSNCODE=RSNCODE,                   X
      MF=S,                               X
      RETCODE=RETCODE
BUFF   DC CL256'BUFFER TEXT'           buffer to write to log stream
BLKLEN DC F'256'                         length of block to be written
ANSLEN DC A(L'ANSAREA)                  length of logger's answer area
BUFKEY DC F'8'                           buffer key
TOKEN  DS CL16                           stream token from connect
RET_TIME DS CL16                          returned timestamp of block
ANSAREA DS CL(ANSAA_LEN)                 answer area for log requests
RETCODE DS F                               return code
RSNCODE DS F                               reason code
BUFALET DC F'1'                          buffer alet secondary
RETBK  DS CL8                             returned block id
DATAREA DSECT
IXGANSAA LIST=YES                         answer area

```

Example 2

Write data to the log stream asynchronously, if synchronous processing is not possible.

```

IXGWRITE STREAMTOKEN=TOKEN,           X
        BUFFER=BUFFER,                 X
        BLOCKLEN=BLKLEN,               X
        BUFALET=BUFALET,               X
        RETBLOCKID=RETBLOCK,           X
        MODE=SYNCECB,                  X
        ECB=ANECB,                     X
        ANSAREA=ANSAREA,               X
        ANSLEN=ANSLEN,                 X
        RSNCODE=RSNCODE,               X
        MF=S,                           X
        RETCODE=RETCODE
*****
*          if return code = '00000401'X then wait
*          on the ecb ANECB for the request to complete
*****
BUFF    DC      CL256'BUFFER TEXT'      buffer to write to log stream
BLKLEN  DC      F'256'                  length of block to be written
ANSLEN  DC      A(L'ANSAREA)            length of logger's answer area
TOKEN   DS      CL16                    stream token from connect
ANSAREA DS      CL(ANSAA_LEN)           answer area for log requests
RETCODE DS      F                        return code
RSNCODE DS      F                        reason code
BUFALET DC      F'1'                    buffer alet secondary
ANECB   DS      F                        ecb to wait on
RETBK   DS      CL8                      returned block id
DATAREA DSECT
        IXGANSAA LIST=YES                answer area

```

Example 3

Write data to the log stream using registers.

```

LA R6,TOKEN                            load stream token in register 6
IXGWRITE STREAMTOKEN=(6),              X
        BUFFER=BUFFER,                 X
        BLOCKLEN=BLKLEN,               X
        RETBLOCKID=RETBLOCK,           X
        MODE=SYNC,                     X
        ANSAREA=ANSAREA,               X
        ANSLEN=ANSLEN,                 X
        RSNCODE=RSNCODE,               X
        MF=S,                           X
        RETCODE=RETCODE
BUFF    DC      CL256'BUFFER TEXT'      buffer to write to log stream
BLKLEN  DC      F'256'                  length of block to be written
ANSLEN  DC      A(L'ANSAREA)            length of logger's answer area
TOKEN   DS      CL16                    stream token from connect
ANSAREA DS      CL(ANSAA_LEN)           answer area for log requests
RETCODE DS      F                        return code
RSNCODE DS      F                        reason code
RETBK   DS      CL8                      returned block id
DATAREA DSECT
        IXGANSAA LIST=YES                answer area
R6      EQU     6                        set up register 6

```

Chapter 76. LINK and LINKX – Pass control to a program in another load module

LINK and LINKX description

The LINK macro is used to pass control to a specified entry name in another load module; the entry name must be a member name or an alias in the directory of a partitioned data set (PDS) or must have been specified in an IDENTIFY macro. The load module containing the program is brought into virtual storage if a usable copy is not available.

If your program is in access register (AR) address space control (ASC) mode, use LINKX. All the parameters on LINK are valid on LINKX.

Descriptions of the LINK and LINKX macro in this information are:

- The standard form of the LINK macro, which includes general information about the LINK and LINKX macros with specific information about the LINK macro. The syntax of the LINK macro and all LINK parameters are explained.
- The standard form of the LINKX macro, which presents information specific to the LINKX macro and callers in AR mode.
- The list form of the LINK and LINKX macros.
- The execute form of the LINK and LINKX macros.

LINK and LINKX processing ensure that the called program receives control in the correct addressing mode. If the called program has an address mode of ANY, it receives control in the AMODE of the calling program. The program issuing the LINK or LINKX macro regains control in its own addressing mode.

The caller optionally can provide a parameter list to be passed to the called program. If the called program terminates abnormally, or if the specified entry point cannot be located, the task is abnormally terminated unless the caller provides an ERRET exit.

Note: The LINK and LINKX macros have the same environment specifications, register information, programming requirements, restrictions and limitations, performance implications, and return and reason codes described below, except where noted in the explanation for LINKX.

Environment

The requirements for the caller of LINK are:

Environmental factor	Requirement
Minimum authorization:	Problem state and any PSW key.
Dispatchable unit mode:	Task
Cross memory mode:	PASN=HASN=SASN
AMODE:	24- or 31-bit for LINK. 24- or 31- or 64-bit for LINKX.
ASC mode:	Primary
Interrupt Status:	Enabled for I/O and external interrupts
Locks:	No locks held
Control parameters:	Must be in the primary address space.

Programming requirements

None.

Restrictions

- The caller cannot have an EUT FRR established.

Register information

After the caller issues the macro, the system might use some registers as work registers or might change the contents of some registers. When the system returns control to the caller, the contents of these registers are not the same as they were before the macro was issued. Therefore, if the caller depends on these registers containing the same value before and after issuing the macro, the caller must save these registers before issuing the macro and restore them after the system returns control.

If the LINK is successful, the GPRs contain the following when the **called program** receives control:

Register

Contents

0

One of the following:

- Used as a work register by the system if SF is specified.
- Otherwise, unchanged.

1

One of the following:

- Address of the PARAM address list if that is coded.
- Otherwise, unchanged if LSEARCH=YES not specified and LINKX not specified, and LINK not issued with SYSSTATE ASCENV=AR.
- Otherwise, used as a work register by the system.

2-13

Unchanged

14

Contains the return address the called module will return to. If the high-order bit of this register is on, the issuer of the LINK or LINKX macro is running in 31-bit mode; if off, the issuer is running in 24-bit mode.

15

Requested program's entry point address

When the target of the LINK or LINKX is AMODE(64), then reg 15 contains

```
xxxxxxxY
```

where Y is:

- 0 if the caller was AMODE 24
- 2 if the caller was AMODE 31
- 4 if the caller was AMODE 64

Upon return to the caller, the GPRs contain whatever values the called program placed there.

If the LINK is not successful and the caller provided an ERRET exit to receive control, the GPRs contain the following:

Register

Contents

0

One of the following:

- Used as a work register by the system if SF is specified.
- Otherwise, unchanged.

1

Bits 0–31 of the 64 bit register contain the abend reason code for the abend code for the ABEND that would have been issued if the caller had not provided an ERRET exit.

Bits 32–63 of the 64 bit register contain the abend code for the ABEND that would have been issued if the caller had not provided an ERRET exit.

2-13

Unchanged

14

Used as a work register by the system

15

Address of the ERRET exit.

Performance implications

None.

Syntax

The standard form of the LINK macro is written as follows:

Syntax	Description
<i>name</i>	<i>name</i> : Symbol. Begin <i>name</i> in column 1.
␣	One or more blanks must precede LINK.
LINK	
␣	One or more blanks must follow LINK.
EP= <i>entry name</i>	<i>entry name</i> : Symbol.
EPLOC= <i>entry name addr</i>	<i>entry name addr</i> : A-type address, or register (2) - (12).
DE= <i>list entry addr</i>	<i>list entry addr</i> : A-type address, or register (2) - (12).
,DCB= <i>dcb addr</i>	<i>dcb addr</i> : A-type address, or register (2) - (12).
,PARAM=(<i>addr</i>)	<i>addr</i> : A-type address, or register (2) - (12).
,PARAM=(<i>addr</i>),VL=1	Note: <i>addr</i> is one or more addresses, separated by commas. For example, (<i>addr,addr,addr</i>)

Syntax	Description
,ID= <i>id nمبر</i>	<i>id nمبر</i> : Symbol or decimal digit, with a maximum value of 4095.
,ERRET= <i>err rtn addr</i>	<i>err rtn addr</i> : A-type address, or register (2) - (12).
,LSEARCH=NO	Default: No
,LSEARCH=YES	

Parameters

The parameters are explained as follows:

EP=entry name

EPLOC=entry name addr

DE=list entry addr

Specifies the entry name, the address of the entry name, or the address of the name field in a 62-byte list entry for the entry name that was constructed using the BLDL macro. If EPLOC is coded, *entry name addr* points to an eight-byte field. If the name is less than eight characters, left-justify the name and pad with blanks on the right to make up the eight characters.

The system ignores the information you specify on the DE parameter if the parameter does one or both of the following:

- Specifies an entry in an authorized library (that is, defined in IEAAPFxx member of parmlib)
- Requests access to a program or library that is controlled by the system authorization facility (SAF)

Instead, the system uses the BLDL macro to construct a new list entry containing the DE information.

Note: When you use the DE parameter with the LINK macro, DE specifies the address of a list that was created by a BLDL macro. BLDL and LINK must be issued from the same task; otherwise, the system might terminate the program with an abend code of 106 and a return code of 15. Therefore, do not issue ATTACH or DETACH between issuances of BLDL and LINK.

,DCB=dcb addr

Specifies the address of the opened data control block for the partitioned data set containing the entry name described above. This parameter must indicate the same DCB specified in the BLDL used to locate the entry name.

If the DCB parameter is omitted or if DCB=0 is specified when the LINK macro is issued by the *job step task*, the data sets referred to by either the STEPLIB or JOBLIB DD statement are first searched for the entry point name. If the entry point name is not found, the link library is searched.

If the DCB parameter is omitted or if DCB=0 is specified when the LINK macro is issued by a *subtask*, the data sets associated with one or more data control blocks referred to by the TASKLIB operand of previous ATTACH macros in the subtasking chain are first searched for the entry point name. If the entry point name is not found, the search is continued as if LINK had been issued by the job step task.

Note: DCB must reside in 24-bit addressable storage.

,PARAM=(addr)

,PARAM=(addr),VL=1

Specifies address(es) to be passed to the called program. To form the parameter list, the macro expands each address inline to a fullword on a fullword boundary, in the order designated. GPR 1 contains the address of the first parameter when the program is given control. (If this parameter is not coded, GPR 1 is not altered unless the execute form of the LINK macro is coded or LSEARCH=YES is specified.)

Specify VL=1 only if the called program can be passed a variable number of parameters. VL=1 causes the high-order bit of the last address parameter to be set to 1; the bit can be checked to find the end of the list.

Note: If you specify only one address for PARAM=, you do not need to enter the parentheses.

,ID=id nmb

Specifies an identifier for this invocation of the macro, useful for debugging purposes. The last fullword of the macro expansion is a NOP instruction containing, in bytes 3 and 4, the identifier you specified.

,ERRET=err rtn addr

Specifies the address of an exit to receive control when an error condition that would cause abnormal termination of the task is detected. The ERRET exit does not receive control when input parameter errors are detected.

,LSEARCH=NO

,LSEARCH=YES

Specifies whether (YES) or not (NO) the search is to be limited to the job pack area and the first library in the normal search sequence.

Return and reason codes

None.

Example 1

Pass control to a specified entry name (PGMLKRUS) in another load module. Let the system find the module from available libraries.

```
LINK EP=PGMLKRUS
```

Example 2

Pass control to a specified entry name (PGMA) in another load module, specifying (in registers 4, 6, 8) three addresses to be passed to the called program.

```
LINK EP=PGMA,PARAM=((4),(6),(8))
```

LINKX — Pass control to a program in another load module

The LINKX macro performs the same function as LINK. It passes control to a specified entry name in another load module. LINKX is intended for use by programs running in access register (AR) mode.

Note: The LINKX macro has the same environment specifications, register information, programming requirements, restrictions and limitations, performance implications, and return and reason codes as the LINK macro, except where noted below.

Environment

The LINKX macro can be used by callers in AR or primary ASC mode.

Programming requirements

If your program is in AR mode, issue the SYSSTATE ASCENV=AR macro before you issue LINKX.

Parameters passed to the called program using the PARAM parameter must reside in your primary address space.

Register information

When the caller regains control or the ERRET exit receives control, the access registers (ARs) are unchanged.

Syntax

The standard form of the LINKX macro is written as follows:

Syntax	Description
<i>name</i>	<i>name</i> : Symbol. Begin <i>name</i> in column 1.
␣	One or more blanks must precede LINKX.
LINKX	
␣	One or more blanks must follow LINKX.
EP= <i>entry name</i>	<i>entry name</i> : Symbol.
EPLOC= <i>entry name addr</i>	<i>entry name addr</i> : A-type address, or register (2) - (12).
DE= <i>list entry addr</i>	<i>list entry addr</i> : A-type address, or register (2) - (12).
,DCB= <i>dcb addr</i>	<i>dcb addr</i> : A-type address, or register (2) - (12).
,PARAM=(<i>addr</i>)	<i>addr</i> : A-type address, or register (2) - (12).
,PARAM=(<i>addr</i>),VL=1	Note: <i>addr</i> is one or more addresses, separated by commas. For example, (<i>addr,addr,addr</i>)
,PLIST4=YES	Default: None.
,PLIST4=NO	
,PLIST8=YES	Default: None.
,PLIST8=NO	
,PLISTARALETs=SYSTEM	Default: ,PLISTARALETs=SYSTEM
,PLISTARALETs=NO	Note: ,PLISTARALETs is valid only with LINKX.
,PLIST8ARALETs=NO	Default: PLIST8ARALETs=NO
,PLIST8ARALETs=YES	Note: PLIST8ARALETs is valid only with LINKX.

Syntax	Description
,ID= <i>id nmbr</i>	<i>id nmbr</i> : Symbol or decimal digit, with a maximum value of 4095.
,ERRET= <i>err rtn addr</i>	<i>err rtn addr</i> : A-type address, or register (2) - (12).
,LSEARCH=NO	Default: NO
,LSEARCH=YES	
,AMODE64OK=NO	Default: NO
,AMODE64OK=YES	

Parameters

The parameters are explained under LINK with the following exceptions. The parameter list on the PARAM parameter is different for callers in AR mode. It is described as follows:

PARAM=(*addr*)

PARAM=(*addr*),VL=1

Specifies an address or addresses to be passed to the called program. LINKX expands each address inline to a fullword boundary and builds a parameter list with the addresses in the order specified. When the called program receives control, GPR1 contains the address of the parameter list. If the program that issued the LINKX macro was in AR mode, access register 1 contains the ALET that qualifies the parameter list address.

When an AR mode caller uses either:

- a parameter list with 4 bytes per entry without specifying PLISTARALET=NO; or
- a parameter list with 8 bytes per entry and specifies PLIST8ARALET=YES,

the addresses passed to the subtask are in the first part of the parameter list and their associated ALETs are in the second part. For a non-AR mode caller, or for an AR mode caller using a parameter list with 4 bytes per entry with PLISTARALET=NO, or for an AR mode caller using a parameter list with 8 bytes per entry without PLIST8ARALET=YES, ALETs are not passed in the parameter list. When ALETs are passed in the parameter list, the ALETs occupy consecutive 4-byte fields, whether the parameter list is 4 or 8 bytes per entry. See the description of the PLIST4 and PLIST8 keywords below for more information about controlling the bytes-per-entry in the parameter list. See the description of the PLISTARALET and PLIST8ARALET keyword below for more information about ALETs and 8-bytes-per-entry parameter lists. See [User parameters](#) for an example of passing a parameter list in AR mode.

When using a 4-bytes-per-entry parameter list, specify VL=1 when you pass a variable number of parameters. VL=1 results in setting the high-order bit of the last address to 1. The 1 in the high-order bit identifies the last address parameter (which is not the last word in the list when the ALETs are also saved). When using an 8-bytes-per-entry parameter list, VL=1 is not valid.

Note: If you specify only one address for PARAM= and you are not using register notation, you do not need to enter the parentheses.

,PLIST4=YES

,PLIST4=NO

,PLIST8=YES

,PLIST8=NO

Defines the size of the parameter list entries for a parameter list to be built by LINKX based on the PARAM keyword.

PLIST4 and PLIST8 cannot be specified together. If neither is specified, the default is:

- If running AMODE 64, PLIST8=YES
- If not running AMODE 64, PLIST4=YES

If running AMODE 64 and PLIST4=YES is specified, the system builds a 4-bytes-per-entry parameter list just as it would if the program were running AMODE 24 or AMODE 31 and did not specify PLIST4 or PLIST8.

If running AMODE 24 or AMODE 31 and PLIST8 is specified, the system builds an 8-bytes-per-entry parameter list just as it would if the program were running AMODE 64 and did not specify PLIST4 or PLIST8.

,PLISTARALETs=SYSTEM

,PLISTARALETs=NO

If the invoker is in AR mode, indicates whether the parameter list is also to contain the ALETs associated with the addresses. If the invoker is not in AR mode, this parameter is ignored.

,PLISTARALETs=SYSTEM

Indicates to follow the default system rules that for an AR mode invoker.

- For AMODE 24/31, the parameter list is also to contain the ALETs.
- For AMODE 64 with PLIST8ARALETs=YES, the parameter list is also to contain the ALETs.
- For other cases, the parameter list is not to contain the ALETs.

,PLISTARALETs=NO

Indicates that the parameter list is not also to contain the ALETs. Do not specify this parameter with PLIST8ARALETs=YES.

,PLIST8ARALETs=NO

,PLIST8ARALETs=YES

If there is to be an 8-byte-per-entry parameter list and the invoker is in AR mode, indicates if the parameter list is also to contain the ALETs associated with the addresses. Otherwise, this parameter is ignored.

,PLIST8ARALETs=NO

Indicates that the 8-byte-per-entry parameter list is to consist of just the 8-byte addresses.

,PLIST8ARALETs=YES

Indicates that the 8-byte-per-entry parameter list is to consist of the following two parts:

- All the 8-byte addresses,
- All the associated ALETs in consecutive 4-byte fields.

,AMODE64OK=NO

,AMODE64OK=YES

Indicates if the system is to accept an attempt to link to an AMODE 64 target routine from an AMODE 24 or AMODE 31 routine.

NO

Indicates that the system is to abend such an attempt.

YES

Indicates that the system is to accept such an attempt.

LINK and LINKX—List form

Two parameter lists are used in a LINK or LINKX macro: a control program parameter list and problem program parameter list. Only the control program parameter list can be constructed in the list form of LINK or LINKX. Address parameters to be passed in a parameter list to the problem program can be provided using the list form of the CALL macro. These parameter lists can be referred to in the execute form of LINK or LINKX.

Syntax

The list form of the LINK or LINKX macro is written as follows:

Syntax	Description
<i>name</i>	<i>name</i> : Symbol. Begin <i>name</i> in column 1.
␣	One or more blanks must precede LINK or LINKX.
LINK LINKX	
␣	One or more blanks must follow LINK or LINKX.
EP= <i>entry name</i>	<i>entry name</i> : Symbol.
EPLOC= <i>entry name addr</i>	<i>entry name addr</i> : A-type address.
DE= <i>list entry addr</i>	<i>list entry addr</i> : A-type address.
,DCB= <i>dcb addr</i>	<i>dcb addr</i> : A-type address.
,PLISTARALETs=SYSTEM	Default: ,PLISTARALETs=SYSTEM
,PLISTARALETs=NO	Note: ,PLISTARALETs is valid only with LINKX.
,PLIST8ARALETs=NO	Default: PLIST8ARALETs=NO
,PLIST8ARALETs=YES	Note: PLIST8ARALETs is valid only with LINKX.
,ERRET= <i>err rtn addr</i>	<i>err rtn addr</i> : A-type address.
,LSEARCH=NO	Default: No
,LSEARCH=YES	
,AMODE64OK=NO	AMODE64OK is valid only with LINKX.

Syntax	Description
,AMODE64OK=YES	Default: NO
,SF=L	

Parameters

The parameters are explained under the standard form of the LINK and LINKX macros, with the following exception:

,SF=L

Specifies the list form of the LINK or LINKX macro.

Note:

1. Coding the LSEARCH parameter causes a parameter list to be created that is different from the list created when LSEARCH is omitted. If you code LSEARCH=YES in either the list or execute form of the macro, you must code it in both forms.
2. If ERRET is coded in the list form and not specified in the execute form, the error routine specified in the list form will be retained and used in the execute form of the macro. If ERRET is specified in both the list and the execute form, the error routine specified in the execute form of the macro will be used.

LINK and LINKX—Execute form

Two parameter lists are used in a LINK or LINKX macro: a control program parameter list and an optional problem program parameter list. Either or both of these lists can be remote and can be referred to and modified by the execute form of LINK or LINKX. If only one of the parameter lists is remote, parameters that require use of the other parameter list cause that list to be constructed inline as part of the macro expansion.

Syntax

The execute form of the LINK or LINKX macro is written as follows:

Syntax	Description
<i>name</i>	<i>name</i> : Symbol. Begin <i>name</i> in column 1.
␣	One or more blanks must precede LINK or LINKX.
LINK LINKX	
␣	One or more blanks must follow LINK or LINKX.
EP= <i>entry name</i>	<i>entry name</i> : Symbol.
EPLOC= <i>entry name addr</i>	<i>entry name addr</i> : RX-type address or register (2) - (12).

Syntax	Description
DE= <i>list entry addr</i>	<i>list entry addr</i> : RX-type address, or register (2) - (12).
,DCB= <i>dcb addr</i>	<i>dcb addr</i> : RX-type address, or register (2) - (12).
,PARAM=(<i>addr</i>)	<i>addr</i> : RX-type address, or register (2) - (12).
,PARAM=(<i>addr</i>),VL=1	Note: <i>addr</i> is one or more addresses, separated by commas. For example, (<i>addr,addr,addr</i>)
,PLIST4=YES	PLIST4 is valid only with LINKX.
,PLIST4=NO	Default: None.
,PLIST8=YES	PLIST8 is valid only with LINKX.
,PLIST8=NO	Default: None.
,PLISTARALET=SYSTEM	Default: ,PLISTARALET=SYSTEM
,PLISTARALET=NO	Note: ,PLISTARALET is valid only with LINKX.
,PLIST8ARALET=NO	Default: PLIST8ARALET=NO
,PLIST8ARALET=YES	Note: PLIST8ARALET is valid only with LINKX.
,ID= <i>id nmb</i>	<i>id nmb</i> : Symbol or decimal digit, with a maximum value of 4095.
,ERRET= <i>err rtn addr</i>	<i>err rtn addr</i> : RX-type address or register (2) - (12).
,LSEARCH=NO	Default: No
,LSEARCH=YES	
,AMODE64OK=NO	AMODE64OK is valid only with LINKX.
,AMODE64OK=YES	Default: NO
,MF=(E, <i>prob addr</i>)	<i>prob addr</i> : RX-type address, or register (1) or (2) - (12).
,SF=(E, <i>ctrl addr</i>)	<i>ctrl addr</i> : RX-type address, or register (2) - (12) or (15).
,MF=(E, <i>prob addr</i>),SF=(E, <i>ctrl addr</i>)	

Parameters

The parameters are explained under the standard form of the LINK and LINKX macros, with the following exceptions:

,MF=(E,prob addr)

,SF=(E,ctrl addr)

,MF=(E,prob addr),SF=(E,ctrl addr)

Specifies the execute form of the LINK or LINKX macro. This form uses a remote problem program parameter list, a remote control program parameter list, or both.

Note:

1. Coding the LSEARCH parameter causes a parameter list to be created that is different from the list created when LSEARCH is omitted. If you code LSEARCH=YES in either the list or execute form of the macro, you must code it in both forms.
2. If ERRET is coded in the list form and not specified in the execute form, the error routine specified in the list form will be retained and used in the execute form of the macro. If ERRET is specified in both the list and the execute form, the error routine specified in the execute form of the macro will be used.

Chapter 77. LOAD — Bring a load module into virtual storage

LOAD description

The LOAD macro is used to bring the load module containing the specified entry name into virtual storage, if a usable copy is not available in virtual storage. Control is not passed to the load module; instead, the load module's entry point address is returned in GPR 0.

LOAD services place the load module in storage above or below 16 megabytes or above 2 gigabytes, depending on the module's RMODE.

The responsibility count for the load module is increased by one.

The load module remains in virtual storage until the responsibility count is reduced to 0 through task terminations. The module also remains until the effects of all outstanding LOAD requests for the module are canceled by using the DELETE macro. There are no other requirements for the module.

Environment

The requirements for the caller are:

Environmental factor	Requirement
Minimum authorization:	Problem state and any PSW key
Dispatchable unit mode:	Task
Cross memory mode:	PASN=HASN=SASN
AMODE:	24- or 31- or 64-bit
RMODE:	Includes 64-bit
ASC mode:	Primary
Interrupt Status:	Enabled for I/O and external interrupts
Locks:	No locks held
Control parameters:	Must be in the primary address space

Programming requirements

- If you code the parameters LSEARCH, LOADPT, or LOADPT64, you obtain a macro-generated parameter list. Therefore, except for the error routine address, all addresses must be specified as A-type addresses or registers (2) - (12).
- LOAD is sensitive to SYSSTATE RMODE64=YES. When LOAD is issued without any of the following parameters – GLOBAL, LSEARCH, ADDR, ADDR64, ADRNAPF, ADRNAPF64, LOADPT, LOADPT64, EXTINFO, and EOM -- and with SYSSTATE RMODE64=YES in effect, it may be invoked from a module at or above 2G. LOAD may be issued with those parameters if it is also issued with the SF parameter, if and only if the parameter list identified by the SF parameter is below 2G and the areas identified by the EP, EPLOC, LOADPT, LOADPT64, and EXTINFO parameters (whichever of those that are used) are below 2G.

Restrictions

- Any module loaded by a task will not be removed from virtual storage unless the task that loaded the module invokes the DELETE macro or terminates.

LOAD macro

- The load module entry name must be listed as a member name or alias in a partitioned data set directory or specified previously by using the IDENTIFY macro. If the LOAD macro cannot find the specified entry name, the caller's task is abended unless the caller provides an ERRET exit.
- The caller cannot have an EUT FRR established.

Input register information

The caller does not have to place information into any register before issuing the LOAD macro. If the caller is using the LOAD macro in register notation for a particular parameter, or as a base register, the caller must place information into the register.

Output register information

If the LOAD is successful, the GPRs contain the following when control returns to the caller:

Register Contents

0

Entry point address of the requested load module. Load services set 64-bit GPR 0 according to the load module's AMODE:

- AMODE 24: bits 32 and 63 are both 0, and bits 0–31 are all set to 0.
- AMODE 31: bit 32 is 1, bit 63 is 0, and bits 0–31 are all set to 0.
- AMODE 64: bit 63 is 1

If the module's AMODE is ANY, it indicates AMODE 24 if the caller is AMODE 24, or AMODE 31 if the caller is AMODE 31 or AMODE 64.

1

The high-order byte contains the load module's APF authorization code.

The low-order 3 bytes contain one of the following values (in priority order):

- If the module is a program object with more than one segment (extent), zeros.

To obtain the length and load point information for each segment, use the information returned by way of the EXTINFO parameter or issue the CSVQUERY macro with the OUTXTLST parameter.

Note: A program object might have more than one segment. One example is the use of the binder RMODE(SPLIT) attribute.

- If the module's length, in doublewords, is greater than or equal to 16 M (2^{24}) bytes, zeros.

To obtain the module length, use the information returned by way of the EXTINFO parameter or issue the CSVQUERY macro with the OUTLENGTH or OUTXTLST parameters.

- Otherwise, the module length, in doublewords.

If the module is a program object, which is bound with the FETCHOPT=NOPACK option, the returned length value is round to the full-page multiple area obtained with GETMAIN to hold the program object. If the program object is bound with the FETCHOPT=PACK option, the returned length value is the size indicated in the directory entry. For further information, view the *z/OS MVS Program Management: User's Guide and Reference* and *z/OS MVS Program Management: Advanced Facilities*.

2-13

Unchanged.

14

Used as a work register by the system.

15

Zero, indicating successful completion.

If the LOAD is not successful and the caller provided an ERRET exit to receive control, the GPRs contain:

Register Contents

0

Used as a work register by the system.

1

System completion code for the abend that would have been issued had the caller not provided an ERRET exit.

2-13

Unchanged.

14

Used as a work register by the system.

15

Reason code (never zero) associated with the system completion code contained in GPR 1.

When control returns to the caller or the ERRET exit receive control, the access registers (ARs) are unchanged.

Some callers depend on register contents remaining the same before and after issuing a service. If the system changes the contents of registers on which the caller depends, the caller must save them before issuing the service, and restore them after the system returns control.

Performance implications

None.

Syntax

The standard form of the LOAD macro is written as follows:

Syntax	Description
<i>name</i>	<i>name</i> : Symbol. Begin <i>name</i> in column 1.
␣	One or more blanks must precede LOAD.
LOAD	
␣	One or more blanks must follow LOAD.
EP= <i>entry name</i>	<i>entry name</i> : Symbol.
EPLOC= <i>entry name addr</i>	<i>entry name addr</i> : If LSEARCH or LOADPT is specified, A-type address or register (2) - (12); otherwise, RX-type address or register (0) or (2) - (12).
DE= <i>list entry addr</i>	<i>list entry addr</i> : If EXTINFO, LOADPT, or LSEARCH is specified, A-type address or register (2) - (12); otherwise, RX-type address, or register (2) - (12).
,DCB= <i>dcb addr</i>	<i>dcb addr</i> : If EXTINFO, LOADPT, or LSEARCH is specified, A-type address or register (2) - (12); otherwise, RX-type address, or register (1) or (2) - (12).

Syntax	Description
,ERRET= <i>err rtn addr</i>	<i>err rtn addr</i> : RX-type address or register (2) - (12).
,LSEARCH=NO	Default: NO
,LSEARCH=YES	
,LOADPT= <i>addr</i>	<i>addr</i> : A-type address or register (2) - (12).
,LOADPT64= <i>addr</i>	<i>addr</i> : A-type address or register (2) - (12).
,EXTINFO= <i>addr</i>	<i>addr</i> : A-type address or register (2) - (12).
,RELATED= <i>value</i>	

Parameters

The parameters are explained as follows:

EP=entry name

EPLOC=entry name addr

DE=list entry addr

Specifies the following:

- When EP, specifies the entry name
- When EPLOC, specifies the address of the name, which must be padded to 8 bytes if necessary
- When DE, specifies the address of the name field in a 62-byte list entry for the entry name that was constructed using the BLDL macro

The system ignores the information you specify on the DE parameter if the parameter does one or both of the following:

- Specifies an entry in an authorized library (that is, defined in IEAAPFxx member of parmlib)
- Requests access to a program or library that is controlled by the System Authorization Facility (SAF)

Instead, the system uses the BLDL macro to construct a new list entry containing the DE information.

Note: When you use the DE parameter with the LOAD macro, BLDL and LOAD must be issued from the same task; otherwise, the system might terminate the program with an abend code of 106 and a return code of 15.

,DCB=dcb addr

Specifies the address of the opened data control block for the partitioned data set containing the entry name described previously. This parameter must indicate the same DCB specified in the BLDL used to locate the entry name.

If the DCB parameter is omitted or if DCB=0 is specified when the LOAD macro is issued by the *job step task*, the data sets referred to by either the STEPLIB or JOBLIB DD statement is first searched for the entry name. If the entry name is not found, the link library is searched.

If the DCB parameter is omitted or if DCB=0 is specified when the LOAD macro is issued by a *subtask*, the data sets associated with one or more data control blocks. They are referred by the TASKLIB

operand of previous ATTACH macro in the sub-tasking chain and are first searched by the entry name. If the entry name is not found, the search is continued as if the LOAD had been issued by the job step task.

Note: DCB must exist in 24-bit addressable storage.

,ERRET=err rtn addr

Specifies the address of a routine to receive control when an error condition that would cause an abnormal termination of the task is detected. Register 1 contains the abend code that would have ended had the task abended, and register 15 contains the reason code that is associated with the abend. The routine does not receive control when input parameter errors are detected.

,LSEARCH=NO

,LSEARCH=YES

Specifies whether (YES) or not (NO) the search is to be limited to the job pack area and the first library in the normal search sequence.

,LOADPT=addr

Specifies that the starting address at which the module was loaded is to be returned to the caller at the indicated address.

,LOADPT64=addr

Specifies an 8-byte area at which the starting address at which the module was loaded is to be returned to the caller.

,EXTINFO=addr

Specifies a 304-byte area, which contains extended information upon return. This area is mapped by dsect EXTI within macro CSVEXTI. Included in this area are:

- The extent list (each entry is mapped by dsect EXTIXE within macro CSVEXTI)
- The authorization code
- The entry point address

By using the EXTINFO keyword, you can avoid the need to call CSVQUERY after doing the LOAD to obtain information that would not otherwise be returned by LOAD. For example, if a program object length were greater than 128 megabytes or had been bound with RMODE=SPLIT, LOAD would not otherwise return the length information.

,RELATED=value

Specifies information used to self-document macros by ‘relating’ functions or services to corresponding functions or services. The format and contents of the information specified are at the discretion of the user, and may be any valid coding values.

The RELATED parameter is available on macros that provide opposite services (for example, ATTACH/DETACH, GETMAIN/FREEMAIN, and LOAD/DELETE), and on macros that relate to previous occurrences of the same macros (for example, CHAP and ESTAE).

For example, the RELATED parameter can be used as follows:

```
LOAD1  LOAD      EP=APGIOHK1,RELATED=(DEL1, 'LOAD  APGIOHK1 ')
      .
      .
      .
DEL1   DELETE    EP=APGIOHK1,RELATED=(LOAD1, 'DELETE APGIOHK1 ')
```

Return and reason codes

When the LOAD macro returns control to the caller, GPR 15 is set to zero if the load request was successful. If the load request was not successful and a caller-provided error routine (specified using the ERRET keyword) receives control, GPR 1 contains the abend code for the abend that would have been issued had the caller not provided an ERRET exit. GPR 15 contains the reason code associated with the abend code in GPR 1.

Example 1

Bring a load module containing a specified entry name (PGMLKRUS) into virtual storage. Allows the system to find the module from available libraries.

```
LOAD    EP=PGMLKRUS
```

Example 2

Bring a load module containing the entry name EPNAME into virtual storage. Indicate that register 7 contains the address of the DCB associated with the partitioned data set that contains this load module. Return the load address of the requested module in the location pointed to by register 8. If an error occurs during this processing, transfer control to the error routine at ERRADDR.

```
LOAD EP=EPNAME,DCB=(7),LOADPT=(8),ERRET=ERRADDR
```

LOAD—List form

The list form of the LOAD macro builds a nonexecutable problem program parameter list that can be referred to or modified by the execute form of the LOAD macro.

Syntax

The list form of the LOAD macro is written as follows:

Syntax	Description
<i>name</i>	<i>name</i> : Symbol. Begin <i>name</i> in column 1.
␣	One or more blanks must precede LOAD.
LOAD	
␣	One or more blanks must follow LOAD.
EP= <i>entry name</i>	<i>entry name</i> : Symbol.
EPLOC= <i>entry name addr</i>	<i>entry name addr</i> : A-type address.
DE= <i>list entry addr</i>	<i>list entry addr</i> : A-type address.
,DCB= <i>dcb addr</i>	<i>dcb addr</i> : A-type address.
,LSEARCH=NO	Default: No
,LSEARCH=YES	
,LOADPT= <i>addr</i>	<i>addr</i> : A-type address.

Syntax	Description
,EXTINFO= <i>addr</i>	<i>addr</i> : A-type address.
,RELATED= <i>value</i>	
,SF=L	

Parameters

The parameters are explained under the standard form of the LOAD macro with the following exception:

,SF=L

Specifies the list form of the LOAD macro.

LOAD - Execute form

The execute form of the LOAD macro can refer to and modify the parameter list constructed by the list form of the macro.

Syntax

The execute form of the LOAD macro is written as follows:

Syntax	Description
<i>name</i>	<i>name</i> : Symbol. Begin <i>name</i> in column 1.
␣	One or more blanks must precede LOAD.
LOAD	
␣	One or more blanks must follow LOAD.
EP= <i>entry name</i>	<i>entry name</i> : Symbol.
EPLOC= <i>entry name addr</i>	<i>entry name addr</i> : RX-type address, or register (2) - (12).
DE= <i>list entry addr</i>	<i>list entry addr</i> : RX-type address, or register (2) - (12).
,DCB= <i>dcb addr</i>	<i>dcb addr</i> : RX-type address, or register (2) - (12).
,ERRET= <i>err rtn addr</i>	<i>err rtn addr</i> : RX-type address, or register (2) - (12).
,LSEARCH=NO	Default: No

LOAD macro

Syntax	Description
,LSEARCH=YES	
,LOADPT= <i>addr</i>	<i>addr</i> : RX-type address or register (2) - (12).
,EXTINFO= <i>addr</i>	<i>addr</i> : A-type address.
,RELATED= <i>value</i>	
,SF=(E, <i>list addr</i>)	<i>list addr</i> : RX-type address or register (2) - (12) or (15).

Parameters

The parameters are explained under the standard form of the LOAD macro with the following exception:

,SF=(E,*list addr*)

Specifies the execute form of the LOAD macro.

Chapter 78. LSEXPAND – Expand the linkage stack capacity

Description

The LSEXPAND macro expands a normal linkage stack, or a recovery linkage stack, to support the specified number of entries by allocating additional DREF storage.

If a program does not specify the LSEXPAND macro, it receives a normal linkage stack with 96 entries and a recovery linkage stack with 24 entries.

Environment

The requirements for the caller are:

Environmental factor	Requirement
Minimum authorization:	Problem state and any PSW key
Dispatchable unit mode:	Task
Cross memory mode:	PASN = HASN
AMODE:	31-bit
ASC mode:	Primary or AR
Interrupt status:	Enabled for I/O and external interrupts
Locks:	No locks held
Control parameters:	Not applicable

Programming requirements

If the system has already issued a stack full program interruption, the system will not accept the LSEXPAND macro. In other words, do not wait until the normal or recovery linkage stacks are full to issue this macro.

Restrictions

None.

Input register information

Before issuing the LSEXPAND macro, the caller does not have to place any information into any register unless using it in register notation for a particular parameter, or using it as a base register.

Output register information

When control returns to the caller, the general purpose registers (GPRs) contain:

Register Contents

0-1

Used as work registers by the system

2-13

Unchanged

LSEXPAND macro

14

Used as a work register by the system

15

Return code

When control returns to the caller, the access registers (ARs) contain:

Register

Contents

0-1

Used as work registers by the system

2-13

Unchanged

14-15

Used as a work register by the system

Some callers depend on register contents remaining the same before and after issuing a service. If the system changes the contents of registers on which the caller depends, the caller must save them before issuing the service, and restore them after the system returns control.

Performance implications

None.

Syntax

The LSEXPAND macro is written as follows:

Syntax	Description
<i>name</i>	<i>name</i> : Symbol. Begin <i>name</i> in column 1.
␣	One or more blanks must precede LSEXPAND.
LSEXPAND	
␣	One or more blanks must follow LSEXPAND.
NORMAL= <i>n</i>	<i>n</i> : Symbol or number or value in register (2) - (12).
RECOVERY= <i>n</i>	<i>n</i> : Symbol or number or value in register (2) - (12).

Parameters

LSEXPAND

Specifies the number of entries that a task has for its normal linkage stack or its recovery linkage stack.

NORMAL=*n*

Specifies the number of entries in the normal linkage table, where *n* can be between 97 and 16000. If you don't specify this parameter, the normal linkage stack has 96 entries.

RECOVERY=*n*

Specifies the number of entries in the recovery linkage stack, where *n* can be between 25 and 4000. If you don't specify this parameter, the recovery linkage stack has 24 entries.

ABEND codes

None.

Return codes

When LSEXPAND macro returns control to your program, GPR 15 contains a return code.

<i>Table 47. Return and Reason Codes for the LSEXPAND Macro</i>	
Hexadecimal Return Code	Meaning and Action
00	Meaning: Successful completion. Action: None.
08	Meaning: Program error. The caller was not unlocked. Action: Release locks before calling LSEXPAND.
0C	Meaning: Program error. The caller was not in task mode. Action: Change your code to run in task mode.
10	Meaning: Program error. The specified normal stack size exceeds 16000. Action: Specify a stack size less than 16000.
14	Meaning: Program error. The specified recovery stack size exceeds 4000. Action: Specify a stack size less than 4000.
18	Meaning: Program error. The recovery stack cannot be expanded because it is currently in use. Action: Restructure your program to issue the LSEXPAND before the stack becomes full.
1C	Meaning: Program error. The normal stack cannot expand because the specified value is smaller than the current normal stack size. Action: Specify a larger stack size.
20	Meaning: Program error. The recovery stack cannot expand because the specified value is smaller than the current recovery stack size. Action: Specify a larger stack size.
24	Meaning: Environmental error. Not enough virtual storage was available for the normal linkage stack or the recovery linkage stack. Action: Retry the request one or more times. If the problem persists, check with the operator to see why there is a storage constraint.

Table 47. Return and Reason Codes for the LSEXPAND Macro (continued)

Hexadecimal Return Code	Meaning and Action
28	Meaning: System error. The normal linkage stack is unchanged. The recovery linkage stack might be expanded. Action: Retry the request.

Example 1

Expand the normal linkage stack to 192 entries.

```
LSEXPAND NORMAL=192
```

Example 2

Expand the recovery linkage stack to 96 entries.

```
LA 6,96  
LSEXPAND RECOVERY=(6)
```

Chapter 79. PGLOAD – Load virtual storage areas into central storage

Description



Attention: Use the PGSER macro rather than PGLOAD.

The PGLOAD macro is used to load specified virtual storage areas into central (also called real) storage in anticipation of future needs. That is, PGLOAD is essentially a page-ahead function. The PGLOAD macro performs this function for virtual addresses below 16 megabytes; the LOAD option of the PGSER macro performs the same function for virtual addresses either above or below 16 megabytes. Note, however, that a page that has been loaded via PGLOAD is eligible for page-out selection in the same manner as a page that has been demand-paged into central storage.

The misuse of this function can have adverse effects on system performance. Causing unnecessary pages to be brought into central storage will force other pages to be displaced and, consequently, cause unnecessary paging activity. Proper use of this function, however, will tend to decrease system overhead resulting from page faults.

Syntax

The standard form of the PGLOAD macro is written as follows:

Syntax	Description
<i>name</i>	<i>name</i> : Symbol. Begin <i>name</i> in column 1.
␣	One or more blanks must precede PGLOAD.
PGLOAD	
␣	One or more blanks must follow PGLOAD.
R	
,A= <i>start addr</i>	<i>start addr</i> : A-type address, or register (1) or (2) - (12).
,ECB= <i>ecb addr</i>	<i>ecb addr</i> : A-type address, or register (0) or (2) - (12).
,EA= <i>end addr</i>	<i>end addr</i> : A-type address, or register (2) - (12) or (15).
	Default: <i>start addr</i> + 1

Syntax	Description
,RELEASE=N	Default: RELEASE=N
,RELEASE=Y	Note: RELEASE=Y may only be specified with EA above.

Parameters

The parameters are explained as follows:

R

Specifies that no parameter list is being supplied with this request.

,A=*start addr*

Specifies the start address of the virtual area to be loaded.

,ECB=*ecb addr*

Specifies the address of an ECB that is used to signal event completion.

,EA=*end addr*

Specifies the end address + 1 of the virtual area to be loaded.

,RELEASE=N

,RELEASE=Y

Specifies that the contents of the virtual area is to remain intact (N) or be released (Y).

When control is returned, register 15 contains one of the following return codes:

Hexadecimal Code

Meaning

00

Operation completed normally; ECB posted complete.

08

Operation proceeding; ECB will be posted when all page-ins are complete.

If control is not returned, an ABEND is issued with the following reason codes in register 15:

Hexadecimal Code

Meaning

10

Virtual subarea list entry or ECB address invalid. No ECB is posted.

If the ECB parameter is coded, the ECB is unchanged if the request was initiated but not complete (return code 8), or if an ABEND was issued with return code 10. Otherwise, the ECB is posted complete with code

0 -

Operation completed successfully.

If the return code issued is 8, the ECB is posted asynchronously when paging I/O has completed, with code

0 -

Operation completed successfully.

Example 1

Page-in a single byte of virtual storage, causing the entire 4096-byte page containing that byte to be paged into central storage.

```
PGLOAD R,A=(R3)
```

Example 2

Page-in the virtual storage lying in the range addressed by registers 3 and 4, and notify the requestor via posting of the ECB when the page-ins are complete.

```
PGLOAD R, A=(R3), EA=(R4), ECB=(R5)
```

Example 3

Discard the contents of the virtual pages totally encompassed by STARTAD and ENDAD before new real frames are assigned.

```
PGLOAD R, A=STANDARD, EA=ENDAD, RELEASE=Y
```

PGLOAD—List form

The list form of the PGLOAD macro uses a virtual subarea list.

Syntax

The list form of the PGLOAD macro is written as follows:

Syntax	Description
<i>name</i>	<i>name</i> : Symbol. Begin <i>name</i> in column 1.
␣	One or more blanks must precede PGLOAD.
PGLOAD	
␣	One or more blanks must follow PGLOAD.
L	
,LA= <i>list addr</i>	<i>list addr</i> : A-type address, or register (1) or (2) - (12).
,ECB= <i>ecb addr</i>	<i>ecb addr</i> : A-type address, or register (0) - (2) or (15).
,RELEASE=N	Default: RELEASE=N
,RELEASE=Y	

Parameters

The parameters are explained under the standard form of the PGLOAD macro, with the following exceptions:

PGLOAD macro

L

Specifies that a parameter list is being supplied with this request.

,LA=*list addr*

Specifies the address of the first entry of a virtual subarea list.

Chapter 80. PGOUT – Page out virtual storage areas from central storage

Description



Attention: Use the PGSER macro rather than PGOUT.

The PGOUT macro is used to initiate page-out operations for specified virtual storage areas that are in central (also called real) storage. The PGOUT macro performs this function for virtual addresses below 16 megabytes; the OUT option of the PGSER macro performs the same function for virtual addresses either above or below 16 megabytes. The PGOUT function is complementary to the PGLOAD function. You have the option of specifying that the virtual pages to be paged out either remain valid in central storage, or be marked invalid and the real frames assigned to them be made available for reuse. The use of this option will not prevent page faults from occurring on the specified storage.

The misuse of this function, like the misuse of the PGLOAD function, can have adverse effects on system performance. On the other hand, proper use of this function will tend to clean out of central storage those pages no longer needed for program execution or not required for some period in the future.

Syntax

The standard form of the PGOUT macro is written as follows:

Syntax	Description
<i>name</i>	<i>name</i> : Symbol. Begin <i>name</i> in column 1.
␣	One or more blanks must precede PGOUT.
PGOUT	
␣	One or more blanks must follow PGOUT.
R	
,A= <i>start addr</i>	<i>start addr</i> : A-type address, or register (1) or (2) - (12).
,EA= <i>end addr</i>	<i>end addr</i> : A-type address, or register (2) - (12) or (15).
,KEEPREL=N	Default: KEEPREL=N
,KEEPREL=Y	

Parameters

The parameters are explained as follows:

R

Specifies that no parameter list is being supplied with this request.

,A=*start addr*

Specifies the start address of the virtual area to be paged out.

,EA=*end addr*

Specifies the end address + 1 of the virtual area to be paged out.

,KEEPREL=N

,KEEPREL=Y

Specifies that the virtual pages will be marked invalid and the real frames freed for reuse (N) or that the virtual pages will not be invalidated (Y).

When control is returned, register 15 contains one of the following return codes:

Hexadecimal Code

Meaning

00

Operation completed normally; paging I/O proceeding asynchronously.

0C

One or more pages specified to be paged out were not paged out. Either the pages were in the nucleus in unusable real frames, in SQA or LSQA, in V=R area allocated region, were page fixed, or the system resources necessary to perform the page out operations were momentarily unavailable. Paging I/O is proceeding normally for all other pages.

10

Operation abnormally terminated. Virtual subarea list entry invalid.

Example 1

Page out the area of central storage totally encompassed by the start and end virtual boundaries specified.

```
PGOUT R, A=(R3), EA=(R4)
```

Example 2

Create an auxiliary storage copy of a virtual area before continuing to use the area. The area will remain in central storage after the page-outs complete.

```
PGOUT R, A=(R3), EA=(R4), KEEPREL=Y
```

PGOUT—List form

The list form of the PGOUT macro uses a virtual subarea list.

Syntax

The list form of the PGOUT macro is written as follows:

Syntax	Description
<i>name</i>	<i>name</i> : Symbol. Begin <i>name</i> in column 1.

Syntax	Description
‡	One or more blanks must precede PGOUT.
PGOUT	
‡	One or more blanks must follow PGOUT.
L	
,LA= <i>list addr</i>	<i>list addr</i> : A-type address, or register (1) or (2) - (12).
,KEEPREL=N	Default: KEEPREL=N
,KEEPREL=Y	

Parameters

The parameters are explained under the standard form of the PGOUT macro, with the following exceptions:

L

Specifies that a parameter list is being supplied with this request.

,LA=*list addr*

Specifies the address of the first entry of a virtual subarea list (VSL). See the topic “Virtual Subarea List (VSL)” in [z/OS MVS Programming: Assembler Services Guide](#) for a description of the VSL.

Chapter 81. PGRLSE – Release virtual storage contents

Description



Attention: Use the PGSER macro rather than PGRLSE.

The PGRLSE macro is used to release to the system all central (also called real) storage and auxiliary storage associated with specified pageable virtual storage areas. The PGRLSE macro performs this function for virtual addresses below 16 megabytes; the RELEASE option of the PGSER macro performs the same function for virtual addresses either above or below 16 megabytes. Use PGRLSE when a large area (one or more complete pages) of virtual storage within your program no longer has significant contents.

Functionally, PGRLSE is equivalent to a FREEMAIN macro followed by a GETMAIN macro. That is, the virtual space is maintained, but the data is discarded. When a released page is next referred to, its contents are binary zeros. Thus, you can help reduce system overhead by releasing virtual storage when you no longer need it.

Note: PGRLSE, PGSER RELEASE, PGSER FREE with RELEASE=Y, and PGFREE RELEASE=Y may ignore some or all of the pages in the input range and will not notify the caller if this was done.

Any pages in the input range that match any of the following conditions will be skipped, and processing continues with the next page in the range:

- Storage is not allocated or all pages in a segment have not yet been referenced.
- Page is in PSA, SQA or LSQA.
- Page is V=R. Effectively, it's fixed.
- Page is in BLDL, (E)PLPA, or (E)MLPA.
- Page has a page fix in progress or a nonzero FIX count.
- Pages with COMMIT in progress or with DISASSOCIATE in progress.

Proper use of this function can increase the amount of storage available to the system and prevent needless paging I/O activity. Usage of PGRLSE may improve operating efficiency when the using program can discard the contents of a large virtual storage area and reuse the virtual storage pages; paging operations may be eliminated for those virtual storage pages when they are reused.

Syntax

The standard form of the PGRLSE macro is written as follows:

Syntax	Description
<i>name</i>	<i>name</i> : Symbol. Begin <i>name</i> in column 1.
␣	One or more blanks must precede PGRLSE.
PGRLSE	
␣	One or more blanks must follow PGRLSE.

Syntax	Description
LA= <i>low addr</i>	<i>low addr</i> : A-type address, or register (0) or (2) - (12).
,HA= <i>high addr</i>	<i>high addr</i> : A-type address, or register (1) or (2) - (12).

Parameters

The parameters are explained as follows:

LA=*low addr*

Specifies the address of the lower boundary of the area to be released.

,HA=*high addr*

Specifies the address of the upper boundary + 1 of the area to be released.

When control is returned, register 15 contains one of the following return codes:

Hexadecimal Code

Meaning

00

Successful completion.

04

Execution failed. The area specified, or a portion of the area, is protected from the requesting program. Any valid portion of the area preceding the protected area is released.

Example 1

Release the contents of the pages included within the specified areas. Only those pages fully encompassed will be nullified.

```
PGRLSE LA=(R4),HA=(R5)
```

Example 2

Perform the operation in Example 1, but use A-type addresses.

```
PGRLSE LA=LOWADDR,HA=HIGHADDR
```

PGRLSE - List form

The list form of the PGRLSE macro is used to construct a control program parameter list.

Syntax

The list form of the PGRLSE macro is written as follows:

Syntax	Description
<i>name</i>	<i>name</i> : Symbol. Begin <i>name</i> in column 1.
␣	One or more blanks must precede PGRLSE.

Syntax	Description
PGRLSE	
␣	One or more blanks must follow PGRLSE.
LA= <i>low addr</i> ,	<i>low addr</i> : A-type address.
,HA= <i>high addr</i> ,	<i>high addr</i> : A-type address.
,MF=L	

Parameters

The parameters are explained under the standard form of the PGRLSE macro, with the following exception:

,MF=L

Specifies the list form of the PGRLSE macro.

PGRLSE - Execute form

A remote control program parameter list is referred to, and can be modified by, the execute form of the PGRLSE macro.

Syntax

The execute form of the PGRLSE macro is written as follows:

Syntax	Description
<i>name</i>	<i>name</i> : Symbol. Begin <i>name</i> in column 1.
␣	One or more blanks must precede PGRLSE.
PGRLSE	
␣	One or more blanks must follow PGRLSE.
LA= <i>low addr</i> ,	<i>low addr</i> : A-type address, or register (0) or (2) - (12).
,HA= <i>high addr</i> ,	<i>high addr</i> : A-type address, or register (1) or (2) - (12).

PGRLSE macro

Syntax	Description
,MF=(E, <i>ctrl addr</i>)	<i>ctrl addr</i> : RX-type address, or register (2) - (12).

Parameters

The parameters are explained under the standard form of the PGRLSE macro, with the following exception:

,MF=(E,*ctrl addr*)

Specifies the execute form of the PGRLSE macro using a remote control program parameter list.

Chapter 82. PGSER – Page services

Description

Note: IBM recommends that you use the PGSER macro for paging services.

The PGSER macro performs the same paging services as the PGLOAD, PGOUT, and PGRLSE macros. PGSER performs these services for addresses either above or below 16 megabytes.

The services are:

- Page load equivalent to the PGLOAD macro.
- Page out equivalent to the PGOUT macro.
- Page release equivalent to the PGRLSE macro.
- The PGSER macro with the PROTECT parameter makes a range of virtual storage pages read-only.
- The PGSER macro with the UNPROTECT parameter makes a range of virtual storage pages modifiable.

Environment

The requirements for the caller are:

Environmental factor	Requirement
Minimum authorization:	Problem state, and any PSW key. To use the PROTECT and UNPROTECT options, the caller must have a PSW key that matches the key of the storage.
Dispatchable unit mode:	Task
Cross memory mode:	PASN=HASN=SASN
AMODE:	24- or 31-bit
ASC mode:	Primary
Interrupt status:	Enabled for I/O and external interrupts
Locks:	No locks held
Control parameters:	Must be in the primary address space

Programming requirements

- The caller must include the IHAPVT mapping macro.
- Regardless of the addressing mode, all addresses passed in registers are used as 31-bit addresses.
- All RX-type addresses are assumed to be in the addressing mode of the caller.

Restrictions

None.

Input register information

Before issuing the PGSER macro, the caller does not have to place any information into any register unless using it in register notation for a particular parameter, or using it as a base register.

Output register information

When control returns to the caller, the GPRs contain:

Register Contents

0-4

Used as work registers by the system

5-13

Unchanged

14

Used as a work register by the system

15

Return code

When control returns to the caller, the access registers (ARs) are unchanged.

Some callers depend on register contents remaining the same before and after issuing a service. If the system changes the contents of registers on which the caller depends, the caller must save them before issuing the service, and restore them after the system returns control.

Performance implications

None.

Syntax

The PGSER macro is written as follows:

Syntax	Description
<i>name</i>	<i>name</i> : Symbol. Begin <i>name</i> in column 1.
␣	One or more blanks must precede PGSER.
PGSER	
␣	One or more blanks must follow PGSER.
R L	
,LOAD ,OUT ,PROTECT ,UNPROTECT ,RELEASE	

Syntax	Description
,LA= <i>list addr</i>	<i>list addr</i> : RX-type address or register (1), (2) - (12).
	Note: This parameter is valid only with L.
,A= <i>start addr</i>	<i>start addr</i> : RX-type address or register (1), (2) - (12).
	Note: This parameter is valid only with R.
,EA= <i>end addr</i>	Default: EA= <i>start addr</i>
	<i>end addr</i> : RX-type address or register (15), (2) - (12).
	Note: This parameter is valid only with R.
,ECB= <i>ecb addr</i>	Default: If LOAD is specified, ECB=0.
	<i>ecb addr</i> : RX-type address or register (0) or (2) - (12).
	Note: This parameter is optional if LOAD is specified and is not valid for OUT and RELEASE.
,RELEASE=Y	Default: RELEASE=N
,RELEASE=N	Note: This parameter may be specified only if LOAD is specified.
,KEEPREL=Y	Default: KEEPREL=N
,KEEPREL=N	Note: This parameter may be specified only if OUT is specified.
,RELATED= <i>value</i>	<i>value</i> : Any valid macro keyword specification.

Parameters

R
L

Specifies the manner in which the input is supplied. If R is specified, the user supplies the starting and ending addresses of the virtual area for which the service needs to be performed. If L is specified, the user supplies the address of the page services list (PSL), which specifies the virtual area for which the service is to be performed. See the topic “Page Service List (PSL)” in *z/OS MVS Programming: Assembler Services Guide* for a description of the PSL.

,LOAD
,OUT
,PROTECT
,UNPROTECT
,RELEASE

Indicates the function to be performed.

LOAD specifies that a page-in operation is to be initiated for the virtual storage area specified, in anticipation of future needs.

OUT specifies that a page-out operation is to be initiated for the virtual storage area specified.

PROTECT specifies that a range of virtual storage be made read-only. R, L, LA, A, EA, and RELATED are valid keywords with the PROTECT option.

UNPROTECT specifies that a range of virtual storage be made modifiable. R, L, LA, A, EA, and RELATED are valid keywords with the UNPROTECT option.

RELEASE specifies the release of all physical paging resources, including both processor storage and auxiliary storage. Functionally, RELEASE is equivalent to a FREEMAIN macro followed by a GETMAIN macro. That is, the virtual space is maintained, but the data is discarded. When a released page is next referred to, its contents are binary zeros.

Note: You must unprotect protected storage before releasing it.

,LA=list addr

Specifies the address of the page services list (PSL) for L requests.

,A=start addr

Specifies the address of the start of the virtual area for R requests.

,EA=end addr

Specifies the address of the last byte on the last page of the virtual area for R requests.

,ECB=ecb addr

Specifies the address of the ECB that is used to signal event completion for a LOAD request.

If an ECB is supplied, the caller must check the return code because the ECB will not be posted if the return code is zero. If an ECB is not supplied, it is not necessary to check the return code because control returns to the caller only if the request was successfully completed; if unsuccessful, page services abnormally terminates the caller. You must ensure that the storage area containing the ECB is not freed and that the key is not altered. If either test fails, page services does not post the ECB.

,RELEASE=Y**,RELEASE=N**

Specifies that all the central (also called real) and auxiliary storage associated with the virtual storage areas is to be released to the system (Y), or that all the central and auxiliary storage associated with the virtual storage areas is not to be released to the system (N).

Note: PGRLSE, PGSER RELEASE, PGSER FREE with RELEASE=Y, and PGFREE RELEASE=Y may ignore some or all of the pages in the input range and will not notify the caller if this was done.

Any pages in the input range that match any of the following conditions will be skipped, and processing continues with the next page in the range:

- Storage is not allocated or all pages in a segment have not yet been referenced.
- Page is in PSA, SQA or LSQA.
- Page is V=R. Effectively, it's fixed.
- Page is in BLDL, (E)PLPA, or (E)MLPA.
- Page has a page fix in progress or a nonzero FIX count.
- Pages with COMMIT in progress or with DISASSOCIATE in progress.

,KEEPREL=Y**,KEEPREL=N**

Specifies that the virtual pages should be validated again after the page-out completes (Y), or that the virtual pages will be marked invalid and the real frames freed for reuse (N).

,RELATED=value

Provides information to document the macro by relating the service performed to some corresponding function or service. The format can be any valid coding value that the user chooses.

ABEND codes

PGSER might abnormally terminate with one of the following abend codes: X'18A', X'28A'. See [z/OS MVS System Codes](#) for explanations and programmer responses.

Return and reason codes

When the PGSER macro returns control to your program, GPR 15 contains one of the following hexadecimal return codes.

Option	Code	Meaning and Action
LOAD	0	<p>Meaning: The operation completed normally and the ECB will not be posted. If no ECB is supplied, the operation is completed or proceeding.</p> <p>Action: None. If the ECB parameter was specified, do not issue a WAIT macro for the ECB after receiving this return code because it will not be posted.</p>
LOAD	8	<p>Meaning: The operation is proceeding. The ECB, if applicable and available, will be posted with X'00' when all page-ins are complete.</p> <p>Action: None. However, if the ECB parameter was specified, issuing a WAIT macro for this ECB will allow your program to synchronize with the completion of the page load operation.</p>
OUT	0	<p>Meaning: The operation completed normally.</p> <p>Action: None.</p>
OUT	C	<p>Meaning: At least one page specified to be paged out was not paged out. The page service is proceeding for the other pages.</p> <p>Action: None.</p>
RELEASE	0	<p>Meaning: The operation completed normally.</p> <p>Note: PGRLSE, PGSER RELEASE, PGSER FREE with RELEASE=Y, and PGFREE RELEASE=Y may ignore some or all of the pages in the input range and will not notify the caller if this was done.</p> <p>Any pages in the input range that match any of the following conditions will be skipped, and processing continues with the next page in the range:</p> <ul style="list-style-type: none"> • Storage is not allocated or all pages in a segment have not yet been referenced. • Page is in PSA, SQA or LSQA. • Page is V=R. Effectively, it's fixed. • Page is in BLDL, (E)PLPA, or (E)MLPA. • Page has a page fix in progress or a nonzero FIX count. • Pages with COMMIT in progress or with DISASSOCIATE in progress. <p>Action: None.</p>

Examples

Example 1

Perform the page-load function for the 4096-byte virtual area starting at BUFFER, supplying no ECB. Include the IHAPVT mapping macro.

```
PGSER R,LOAD,A=BUFFER,EA=BUFFER+4095,ECB=0  
IHAPVT
```

Example 2

Release the virtual area specified in the PSL located at LOADWORD. Include the IHAPVT mapping macro.

```
PGSER L,RELEASE,LA=LOADWORD  
IHAPVT
```

Example 3

Protect the storage area that starts at the address in GPR 4 and ends at the address in the variable ENDIT. Include the IHAPVT mapping macro.

```
PGSER R,PROTECT,A=(4),EA=ENDIT  
IHAPVT
```

Chapter 83. POST – Signal event completion

Description

Use the POST macro to set an event control block (ECB) to indicate the occurrence of an event. If this event satisfies the requirements of an outstanding WAIT or EVENTS macro, the waiting task is taken out of the wait state and dispatched according to its priority. POST processing sets the bits in the ECB as follows:

- Bit 0 to 0 (wait bit)
- Bit 1 to 1 (complete bit)
- Bits 2 through 31 to the specified completion code.

Note: After the bits in the ECB are set, the ECB is considered posted and the awaited event can be recognized as having occurred by programs running in the system. If a program issues another POST against an ECB that is already posted, the other POST has no effect.

For more information on how to use the POST macro to synchronize tasks, see [z/OS MVS Programming: Assembler Services Guide](#).

Environment

The requirements for callers of POST are:

Environmental factor	Requirement
Minimum authorization:	Problem state and any PSW key
Dispatchable unit mode:	Task
Cross memory mode:	One of the following: <ul style="list-style-type: none"> • For LINKAGE=SVC: PASN=HASN=SASN • For LINKAGE=SYSTEM: PASN=HASN=SASN or PASN=HASN=SASN
AMODE:	24- or 31- or 64-bit
ASC mode:	Primary
Interrupt status:	Enabled for I/O and external interrupts
Locks:	<ul style="list-style-type: none"> • For LINKAGE=SVC: No locks held and no enabled unlocked task (EUT) functional recovery routines (FRR) established • For LINKAGE=SYSTEM: No locks held
Control parameters:	The event control block (ECB) must be in the primary address space.

Programming requirements

None.

Restrictions

None.

Input register information

Before issuing the POST macro, the caller does not have to place any information into any register unless using it in register notation for a particular parameter, or using it as a base register.

Output register information

When control returns to the caller the general purpose registers (GPRs) contain:

Register

Contents

0-1

Used as work registers by the system

2-13

Unchanged

14

Used as a work register by the system

15

One of the following:

- If LINKAGE=SVC is specified: Used as a work register by the system
- If LINKAGE=SYSTEM is specified: Return code of 0

Some callers depend on register contents remaining the same before and after issuing a service. If the system changes the contents of registers on which the caller depends, the caller must save them before issuing the service, and restore them after the system returns control.

Performance implications

None.

Syntax

The POST macro is written as follows:

Syntax	Description
<i>name</i>	<i>name</i> : Symbol. Begin <i>name</i> in column 1.
␣	One or more blanks must precede POST.
POST	
␣	One or more blanks must follow POST.
<i>ecb addr</i>	<i>ecb addr</i> : RX-type address, or register (1) or (2) - (12).
<i>,comp code</i>	<i>comp code</i> : Symbol, decimal digit, or register (0) or (2) - (12). If specifying a symbol, it must be valid when used as an operand of a LA instruction.

Syntax	Description
	Range of values: 0 to $(2^{30} - 1)$
	Default: 0
,LINKAGE=SVC	Default: LINKAGE=SVC
,LINKAGE=SYSTEM	
,RELATED= <i>value</i>	<i>value</i> : Any valid macro keyword specification.

Parameters

The explanation of the parameters is as follows:

ecb addr

Specifies the address of the fullword event control block representing the event.

,comp code

Specifies the completion code to be placed in the event control block upon completion.

,LINKAGE=SVC

,LINKAGE=SYSTEM

Specifies the type of linkage that the caller is using to invoke the POST service routine.

For LINKAGE=SVC, the linkage is through an SVC instruction. This linkage is valid only when the caller is in primary mode and the primary, home, and secondary address spaces are the same.

For LINKAGE=SYSTEM, the linkage uses a non-SVC entry. This linkage is valid in cross memory mode or in non-cross memory mode. The ECB must be in the caller's primary address space. LINKAGE=SYSTEM is intended to be used by programs in cross memory mode.

The default is LINKAGE=SVC.

,RELATED=value

Specifies information used to self-document macros by 'relating' functions or services to corresponding functions or services. The format and contents of the information specified are at the discretion of the user and may be any valid coding values.

The RELATED parameter is available on macros that provide opposite services (for example, ATTACH/DETACH, GETMAIN/FREEMAIN, and LOAD/DELETE) and on macros that relate to previous occurrences of the same macros (for example, CHAP and ESTAE).

The RELATED parameter may be used, for example, as follows:

```

WAIT1  WAIT    1, ECB=ECB, RELATED=(RESUME1, 'WAIT FOR EVENT')
      .
      .
RESUME1 POST   ECB, 0, RELATED=(WAIT1, 'RESUME WAITER')
```

Return and reason codes

For LINKAGE=SYSTEM, the return code in register 15 is always zero. Otherwise, the POST macro has no return codes.

Example 1

Signal event completion with a default completion code. POSTECB is the address of an ECB.

POST macro

```
POST    POSTECB
```

Example 2

Signal event completion with a completion code of X'7FF'. POSTECB is the address of an ECB.

```
POST    POSTECB,X'7FF'
```

Chapter 84. QRYLANG – Determine languages available for message translation

Description

The QRYLANG macro enables you to check if a particular language is available into which you can translate system or application messages. It can also provide a list of all active languages currently available for translation. Once you know that the language you want is available, you can issue TRANMSG to retrieve the translated message.

QRYLANG returns the information you request in the language query block (LQB). This block contains the following:

- The standard 3-character code for the language
- The name of the language
- A flag indicating whether the language contains double-byte characters

If you asked for a list of all available languages, QRYLANG returns an LQB with one language entry for each language.

See [z/OS MVS Programming: Assembler Services Guide](#) for more information on using QRYLANG.

Environment

The requirements for the caller are:

Environmental factor	Requirement
Minimum authorization:	Problem state and any PSW key
Dispatchable unit mode:	Task or SRB
Cross memory mode:	PASN=HASN=SASN or PASN≠HASN≠SASN
AMODE:	24- or 31-bit
ASC mode:	Primary
Interrupt Status:	Enabled for I/O and external interrupts
Locks:	No locks held
Control parameters:	Not applicable

Programming requirements

Before invoking QRYLANG you must allocate storage for the LQB.

You must include the following mapping macros:

- CNLMLQB
- CNLMMCA

Restrictions

None.

Input register information

Before issuing the QRYLANG macro, the caller must ensure that the following general purpose register (GPR) contains the specified information:

Register Contents

13
Points to a save area

Output register information

When control returns to the caller, the output registers contain:

Register Contents

- 0**
- The contents of the high-order halfword are not part of the intended programming interface.
 - The low-order halfword contains a reason code.
- 1**
Used as a work register by system
- 2-13**
Unchanged
- 14**
Used as a work register by system
- 15**
Return code

Some callers depend on register contents remaining the same before and after issuing a service. If the system changes the contents of registers on which the caller depends, the caller must save them before issuing the service, and restore them after the system returns control.

Performance implications

None.

Syntax

The QRYLANG macro is written as follows:

Syntax	Description
<i>name</i>	<i>name</i> : Symbol. Begin <i>name</i> in column 1.
␣	One or more blanks must precede QRYLANG.
QRYLANG	
␣	One or more blanks must follow QRYLANG.
LQB= <i>lang qblock addr</i>	<i>lang qblock addr</i> : RX-type address or register (2) - (12).

Syntax	Description
,LQBLN= <i>length of block addr</i>	<i>length of block addr</i> : RX-type address or register (2) - (12).
,LANGNAME= <i>lang addr</i>	<i>lang addr</i> : RX-type address or register (2) - (12).

Parameters

The parameters are explained as follows:

LQB=lang qblock addr

Specifies the storage area or a register pointing to the storage area where QRYLANG is to build the LQB.

,LQBLN=length of block addr

Specifies the fullword or a register containing the length in bytes of the LQB. You must supply the length of the LQB if you are querying more than one language. See *z/OS MVS Programming: Authorized Assembler Services Guide* for information on how to calculate the length of the LQB. If you do not specify LQBLN, QRYLANG will default to the assembled length of the LQB parameter. If you use an RX-type address or register notation for the LQB parameter, you must specify LQBLN.

,LANGNAME=lang addr

Specifies the 24-byte character field or a register pointing to the 24-byte character field containing the name or code of the language to be queried. See *z/OS MVS Programming: Assembler Services Guide* for a listing of the language codes. The language name must match the name specified on the NAME parameter of the LANGUAGE statement in the MMSLSTxx member of SYS1.PARMLIB. If you omit this keyword, QRYLANG returns a list of all currently available languages.

Return and reason codes

When QRYLANG completes, register 15 contains one of the following hexadecimal return codes:

Hexadecimal Code	Meaning
00	Processing completed successfully.
04	Processing did not complete, and storage is not freed.
08	Processing is complete but QRYLANG returned an incomplete LQB to the calling program. For example, the requested language may not be available.
0C	Processing did not complete. The output is unusable.
10	The function did not complete. The output LQB is unusable.

The low-order halfword of register 0 contains the following hexadecimal reason codes from QRYLANG:

Hexadecimal Return Code	Hexadecimal Reason Code	Meaning
00	00	Successful processing.
04	07	This reason code is for internal diagnostic purposes only. Record it and supply it to the appropriate IBM support personnel.

Hexadecimal Return Code	Hexadecimal Reason Code	Meaning
04	08	This reason code is for internal diagnostic purposes only. Record it and supply it to the appropriate IBM support personnel.
04	0B	This reason code is for internal diagnostic purposes only. Record it and supply it to the appropriate IBM support personnel.
04	0C	The passed storage address is not valid.
04	0D	This reason code is for internal diagnostic purposes only. Record it and supply it to the appropriate IBM support personnel.
08	0F	There is insufficient LQB storage for LQB entries.
08	2C	The language you requested is not available.
0C	0A	No storage was obtained.
0C	16	The LQB is too small to handle returned data.
0C	17	The MVS message service is not available.
0C	26	The query request terminated. The MMS user exit has set the processing indicator to a nonzero value.
0C	27	The entry installation exit has failed.
0C	28	The exit installation exit has failed.
0C	2D	The acronym of the control block created when invoking QRYLANG is not "LQB" and is therefore not valid.
0C	2E	The length of the LQB is not valid.
0C	2F	QRYLANG was unable to move the LQB from the caller's address space.
0C	30	QRYLANG was unable to move the LQB to the caller's address space.
10	09	This reason code is for internal diagnostic purposes only. Record it and supply it to the appropriate IBM support personnel.

Example

Check if the language with a language code of JPN is active. If JPN is active, QUERY2A sets a flag within the installation-created control block to "on", indicating that JPN is available.

```

QUERY2A  CSECT
QUERY2A  AMODE 31
QUERY2A  RMODE ANY
          STM   14,12,12(13)
          BALR  12,0
          USING *,12
          ST   13,SAVE+4
          LA   15,SAVE
          ST   15,8(13)
          LR   13,15
*
*****
*          OBTAIN STORAGE AREA FOR INSTLCB AND LQB          *
*****
*

```

```

GETMAIN RU,LV=STORLEN,SP=SP228
*
LR   R3,R1          SAVE ADDRESS OF STORAGE AREA
ST   R3,CVTUSER-CVT ANCHOR INSTALLATION CONTROL BLOCK C
                                FROM GLOBAL COMMUNICATIONS WORD C
                                IN MCA CONTROL BLOCK
XC   0(STORLEN,3),0(3) CLEAR STORAGE AREA
MVC  INSTLACR-INSTLCB(4,R3),=C'INST' SET ACRONYM IN C
                                INSTALLATION CONTROL BLOCK
LA   R4,INSTLLEN(,R3) OBTAIN ADDRESS OF LQB
LA   R5,LQBLEN      GET LQB LENGTH
*
QRYLANG LANGNAME=JPN_CODE,LQB=(R4),LQBLEN=(R5)
*
LTR  R15,R15        IS JAPANESE AVAILABLE
BNZ  END            NO, EXIT
OI   INSTLFLG-INSTLCB(R3),INSTLJPN YES, SET AVAIL. FLAG
*
*****
*   RETURN
*
*****
END   DS   0H
      L    13,SAVE+4
      LM   14,12,12(13)
      BR   14
*****
JPN_CODE DC CL24'JPN'
SAVE     DC 18F'0'
SP228    EQU 228
LQBLEN   EQU (LQBVDAT-LQB)+LQBEBL
STORLEN  EQU INSTLLEN+LQBLEN
R1       EQU 1
R2       EQU 2
R3       EQU 3
R4       EQU 4
R5       EQU 5
R15      EQU 15
*****
DSECT
CVT      DSECT=YES
CNLMCA
CNMLQCB
INSTLCB  DSECT      INSTALLATION CONTROL BLOCK
INSTLACR DS CL4'INST' INSTALLATION CONTROL BLOCK ACRONYM
INSTLFLG DS X      LANGUAGE AVAILABILITY FLAGS
INSTLJPN EQU X'80'  JAPANESE IS AVAILABLE
          DS CL23   RESERVED
INSTLLEN EQU *-INSTLCB
          END QUERY2A

```

Chapter 85. REFPAT – Define and end a reference pattern

Description

The REFPAT macro identifies a large data area and tells the system how the program will be referencing that area. Additionally, the program tells the system how many bytes of data it wants the system to bring into central storage on a page fault (that is, each time the program references data that is not in central storage). Use REFPAT if your program accesses a very large data area in a reference pattern that is consistently in a forward or backward direction. The system responds to REFPAT by bringing multiple pages into central storage on a page fault. REFPAT might significantly improve the performance of the program.

REFPAT INSTALL defines the reference pattern and REFPAT REMOVE removes the definition.

Your program can reference an area with one pattern, then later reference the same area with another pattern. Use REFPAT INSTALL to define the first reference pattern and REFPAT REMOVE to remove the definition. Then, issue REFPAT INSTALL to define another pattern for the same area.

On REFPAT INSTALL, you describe the data area, the reference pattern, and tell the system how many bytes of data you want it to bring into central storage on a page fault. Two parameters, UNITSIZE and GAP, determine the reference pattern:

- UNITSIZE specifies the size of a "reference unit". A reference unit is a grouping of contiguous bytes that the program references. You might decide a reference unit is the group of bytes that make up an element of an array, or the group of bytes that occur between gaps, or a page (4096 bytes).
- GAP defines the size of "gaps" in the reference pattern. Gaps are areas that the program does not reference; they must be uniform in size and appear throughout the data area at repeating intervals. Not all reference patterns include such a gap.

UNITS specifies how many reference units, as defined on UNITSIZE, you want the system to bring into central storage on a page fault.

The data area can be located in the primary address space, or in a data space identified by the STOKEN parameter.

Each pattern defined by REFPAT INSTALL is associated with the task that represents the caller. A task can have up to 100 reference patterns for different data areas, but cannot have multiple patterns for the same area. Multiple tasks can specify a different reference pattern for the same data area. REFPAT REMOVE removes the association between the pattern and the task.

Environment

The requirements for the caller are:

Environmental factor	Requirement
Minimum authorization:	Problem state and any PSW key
Dispatchable unit mode:	Task
Cross memory mode:	PASN=HASN=SASN
AMODE:	31-bit
ASC mode:	Primary or access register (AR)
Interrupt status:	Enabled for I/O and external interrupts
Locks:	No locks held

REFPAT macro

Environmental factor

Control parameters:

Requirement

Must be in the primary address space.

Programming requirements

If your program is in AR mode, make sure the SYSSTATE ASCENV=AR macro has been issued to tell the system to generate code appropriate for AR mode.

Restrictions

If you specify STOKEN for a data space, the data space must be owned by a task in the primary address space.

Input register information

Before issuing the REFPAT macro, the caller does not have to place any information into any register unless using it in register notation for a particular parameter, or using it as a base register.

Output register information

When control returns to the caller, the general purpose registers (GPRs) contain:

Register

Contents

0

Reason code if the return code in GPR 15 is not 0; otherwise, used as a work register by the system

1

Used as a work register by the system

2-13

Unchanged

14

Used as a work register by the system

15

Return code

When control returns to the caller, the ARs contain:

Register

Contents

1

Used as a work register by the system

2-13

Unchanged

14-15

Used as work registers by the system

Some callers depend on register contents remaining the same before and after issuing a service. If the system changes the contents of registers on which the caller depends, the caller must save them before issuing the service, and restore them after the system returns control.

Performance implications

The system rejects the REFPAT macro if the values you specify do not benefit the performance of your program. To make sure the system accepts the macro, ask the system to bring in more than three pages (that is, 12288 bytes) on each page fault.

Syntax

The standard form of the REFPAT macro is written as follows:

Syntax	Description
<i>name</i>	<i>name</i> : Symbol. Begin <i>name</i> in column 1.
␣	One or more blanks must precede REFPAT.
REFPAT	
␣	One or more blanks must follow REFPAT.
INSTALL	
REMOVE	
,PSTART= <i>start</i>	<i>start</i> : RX-type address or address in register (2) - (12).
,PEND= <i>end</i>	<i>end</i> : RX-type address or address in register (2) - (12).
,STOKEN= <i>stoken</i>	<i>stoken</i> : RX-type address or register (2) - (12).
	Default: STOKEN=0
,UNITSIZE= <i>unit size</i>	<i>unit size</i> : RX-type address or register (2) - (12).
	UNITSIZE is required with INSTALL.
,GAP= <i>gap variable</i>	<i>gap variable</i> : RX-type address or register (2) - (12).
	Default: GAP=0
,UNITS= <i>unit number</i>	<i>unit number</i> : RX-type address or register (2) - (12).
	Default: UNITS=1

Parameters

The parameters are explained as follows:

INSTALL REMOVE

INSTALL indicates that the program is to begin referencing the data area according to a defined pattern. Required parameters on the INSTALL request are PSTART, PEND, and UNITSIZE. UNITS, GAP, and STOKEN are optional.

REMOVE indicates that the program has finished referencing the data area, as specified by the previous REFPAT INSTALL request. Required parameters on the REMOVE request are PSTART and PEND. STOKEN is optional on the REMOVE request; UNITSIZE, GAP, and UNITS are not valid.

PSTART and PEND on the INSTALL request must be exactly the same as PSTART and PEND on the REMOVE request for the same reference pattern.

,PSTART=start

A required parameter that contains the address of the first byte of the data area for which the reference pattern applies. PSTART and PEND addresses must not straddle the common area boundaries. That is, for data in the primary address space, all data must be either in low private, in common, or in high private storage.

When a gap exists, define PSTART according to the following rules:

- If direction is forward, PSTART must be the first byte (low-address end) of a reference unit.
- If direction is backward, PSTART must be the last byte (high-address end) of a reference unit.

To code: Specify the RX-type address, or address in register (2)-(12), of a pointer field.

,PEND=end

A required parameter that contains the address of the last byte of the data area for which the reference pattern applies. If *start* is a higher address than *end*, the system knows that data reference is in a backward direction.

Whether or not a gap exists, PEND can be any part of a reference unit or a gap.

To code: Specify the RX-type address, or address in register (2)-(12), of a pointer field.

,STOKEN=stoken

Specifies the STOKEN that identifies the data space that contains the data area. You received the STOKEN either from DSPSERV or from another program.

If you use STOKEN=0 or do not specify STOKEN, the system assumes the data is in the primary address space.

,UNITSIZE=unit size

Specifies the number of consecutive bytes that you want the system to treat as a reference unit. If the pattern includes a gap, the reference unit is the grouping of bytes that lie between the gaps. If the pattern does not include a gap, you can use any logical grouping of bytes that your data structure suggests, such as an element, a row or two, or a page (4096 bytes). UNITSIZE is required for the INSTALL request.

,GAP=gap variable

Specifies the gap, in bytes, of the reference pattern. The default is GAP=0.

,UNITS=unit number

Specifies the number of reference units, as defined on UNITSIZE, the system is to page in at one time. The default is one reference unit or UNITS=1. To figure out how many bytes the system brings in at a time:

- If there is no gap, multiply the UNITS value by the UNITSIZE value and round up to the nearest 4096-byte boundary.
- If there is a gap, the number depends on values of UNITSIZE, GAP, UNITS, plus the location of the reference units and gaps relative to a page boundary. The system brings in the pages that contain the reference units. It does not bring in pages that contain only data in the gap. [z/OS MVS Programming: Assembler Services Guide](#) can help you code the parameters.

Return and reason codes

Return and reason codes, in hexadecimal, from REFPAT are:

Return Code	Reason Code	Meaning
00	None.	REFPAT completed successfully.

Return Code	Reason Code	Meaning
04	xx0001xx	REFPAT completed successfully; however, the system did not accept the reference pattern the caller specified. The system decided that the normal paging algorithms would be more efficient.
08	xx0002xx	Unsuccessful completion. The range that the caller specified on the INSTALL request overlaps the range that a previous request specified.
08	xx0003xx	Unsuccessful completion. The number of existing REFPAT INSTALL requests for the task exceeds 100, the maximum number the system allows.
08	xx0004xx	Unsuccessful completion. LSQA storage is not available for the macro service.
08	xx0101xx	Unsuccessful completion. The caller specified the REMOVE request; however, no INSTALL request was in effect for the specified range. Check to see if the system rejected the previous INSTALL request for the range.

Example 1

Define a reference pattern in which the program processes 8192 bytes and skips over 4096 bytes in a continuing way throughout an array. Registers 4 and 5 contain pointers to locations in storage which contain the starting and ending addresses of the array. Ask the system to bring in eight pages on each page fault.

```
REFPAT  INSTALL ,PSTART=(4) ,PEND=(R5) ,GAP=4096 ,UNITSIZE=8192 ,UNITS=4
```

Example 2

Tell the system you have finished using the array using that pattern:

```
REFPAT  REMOVE ,PSTART=(4) ,PEND=(R5)
```

REFPAT—List form

Use the list form of the REFPAT macro together with the execute form of the macro for programs that require reentrant code. The list form of the macro defines an area of storage, which the execute form of the macro uses to store the parameters.

Syntax

The list form of the REFPAT macro is written as follows:

Syntax	Description
<i>name</i>	<i>name</i> : Symbol. Begin <i>name</i> in column 1.
b	One or more blanks must precede REFPAT.
REFPAT	

Syntax	Description
‡	One or more blanks must follow REFPAT.
MF=(L, <i>list addr</i>)	<i>list addr</i> : Symbol.
MF=(L, <i>list addr,attr</i>)	<i>attr</i> : 1- to 60-character input string.
	Default: 0D

Parameters

The parameters are explained under the standard form of the REFPAT macro with the following exception:

MF=(L,*list addr,attr*)

Specifies the list form of the REFPAT macro. *list addr* defines the area that the system is to use for the parameter list.

attr is an optional 1- to 60-character input string, which can contain any value that is valid on an assembler DS pseudo-op. You can use this parameter to force boundary alignment of the parameter list. If you do not code *attr*, the system provides a value of 0D, which forces the parameter list to a doubleword boundary.

REFPAT—Execute form

Use the execute form of the REFPAT macro together with the list form of the macro for programs that require reentrant code. The execute form of the macro stores the parameters into the storage area defined by the list form.

Syntax

The execute form of the REFPAT macro is written as follows:

Syntax	Description
<i>name</i>	<i>name</i> : Symbol. Begin <i>name</i> in column 1.
‡	One or more blanks must precede REFPAT.
REFPAT	
‡	One or more blanks must follow REFPAT.
INSTALL	
REMOVE	
,PSTART= <i>start</i>	<i>start</i> : RX-type address or register (2) - (12).

Syntax	Description
,PEND= <i>end</i>	<i>end</i> : RX-type address or register (2) - (12).
,STOKEN= <i>stoken</i>	<i>stoken</i> : RX-type address or register (2) - (12).
	Default: STOKEN=0
,UNITSIZE= <i>unit size</i>	<i>unit size</i> : RX-type address or register (2) - (12).
	UNITSIZE is required on INSTALL./.,pend
,GAP= <i>gap variable</i>	<i>gap variable</i> : RX-type address or register (2) - (12).
	Default: GAP=0
,UNITS= <i>unit number</i>	<i>unit number</i> : RX-type address or register (2) - (12).
	Default: UNITS=1
,MF=(E, <i>list addr</i>)	
,MF=(E, <i>list addr</i> ,COMPLETE)	

Parameters

The parameters are explained under the standard form of the REFPEAT macro with the following exception:

,MF=(E,*list addr*)

,MF=(E,*list addr*,COMPLETE)

Specifies the execute form of the REFPEAT macro. *list addr* defines the area that the system uses for the parameter list.

COMPLETE specifies that the system is to check for required parameters and supply optional parameters that are not specified.

Chapter 86. RESERVE — Reserve a device (shared DASD)

Description

The RESERVE macro reserves a device for use by a particular system; it must be issued by each task needing to reserve a device shared with one or more systems. The RESERVE macro protects the caller from interference by other tasks in the system and locks out other systems. The reserve actually occurs when the first I/O is done to the device after the RESERVE macro is issued. When the reserving program no longer needs the reserved device, it should issue a DEQ macro to release the resource. For information about the synchronous reserve feature, see *z/OS MVS Planning: Global Resource Serialization* and *z/OS MVS Initialization and Tuning Guide*.

For information about how to obtain the UCB address for a device, see *Accessing unit control blocks (UCBs)* in *z/OS MVS Programming: Assembler Services Guide* for information about using the UCBSCAN macro.

Environment

The requirements for the caller are:

Environmental factor	Requirement
Minimum authorization:	Problem state with any PSW key.
Dispatchable unit mode:	Task
Cross memory mode:	For LINKAGE=SVC: PASN=HASN=SASN For LINKAGE=SYSTEM: PASN=HASN=SASN or PASN=HASN=SASN
AMODE:	24- or 31- or 64-bit
ASC mode:	Primary
Interrupt status:	Enabled for I/O and external interrupts
Locks:	No locks held
Control parameters:	If the caller's AMODE is 24-bit, all parameters must reside below 16 megabytes.

Programming requirements

None.

Restrictions

If a task issues two RESERVE macros for the same device without an intervening DEQ macro, an abnormal termination results unless the second RESERVE specifies the keyword parameter RET. (If a restart occurs after the caller successfully issued the RESERVE macro for a resource, the system does not reserve the device again; the caller must reissue the RESERVE macro.) If a DEQ macro is not issued for a particular resource, the system releases the reserved resource when the task ends.

The system counts and limits the number of concurrent resource requests in an address space. If an unconditional RESERVE (a RESERVE macro with RET=NONE) causes the number of global resource serialization requests to exceed the limit, the caller is abnormally terminated with a system code of

RESERVE macro

X'538'. For further information about limiting concurrent requests for resources, see [Limiting concurrent requests for resources in z/OS MVS Programming: Assembler Services Guide](#).

Input register information

Before issuing the RESERVE macro, the caller does not have to place any information into any register unless using it in register notation for a particular parameter, or using it as a base register.

Output register information

When control returns to the caller, the GPRs contain:

Register

Contents

0-1

Used as work registers by the system

2-13

Unchanged

14

Used as a work register by the system

15

One of the following:

- If you specify RET=TEST, RET=USE, or RET=HAVE: If all return codes for the resources named in the RESERVE macro are 0, register 15 contains 0. If any of the return codes are not 0, register 15 contains the address of a storage area containing the return codes.
- Otherwise: used as a work register by the system.

When control returns to the caller, the ARs contain:

Register

Contents

0-1

Used as work registers by the system

2-13

Unchanged

14-15

Used as work registers by the system

Some callers depend on register contents remaining the same before and after issuing a service. If the system changes the contents of registers on which the caller depends, the caller must save them before issuing the service, and restore them after the system returns control.

Syntax

The standard form of the RESERVE macro is written as follows:

Syntax	Description
<i>name</i>	<i>name</i> : symbol. Begin <i>name</i> in column 1.
␣	One or more blanks must precede RESERVE.
RESERVE	

Syntax	Description
<code>␣</code>	One or more blanks must follow RESERVE.
<code>qname addr</code>	<i>qname addr</i> : A-type address, or register (2) - (12).
<code>,rname addr</code>	<i>rname addr</i> : A-type address, or register (2) - (12).
<code>,</code>	Default: E
<code>,E</code>	
<code>,S</code>	
<code>,</code>	
<code>,rname length</code>	<i>rname length</i> : symbol, decimal digit, or register (2) - (12).
<code>,SYSTEMS</code>	
<code>)</code>	
<code>,RET=TEST</code>	
<code>,RET=USE</code>	
<code>,RET=HAVE</code>	
<code>,RET=NONE</code>	
<code>,UCB=<i>ucb addr</i></code>	<i>ucb addr</i> : A-type address, or register (2) - (12).
<code>,LOC=BELOW</code>	Default: LOC=BELOW
<code>,LOC=ANY</code>	
<code>,RELATED=<i>value</i></code>	<i>value</i> : any valid macro keyword specification.
<code>,LINKAGE=SVC</code>	DEFAULT: LINKAGE=SVC
<code>,LINKAGE=SYSTEM</code>	

Parameters

The parameters are explained as follows:

(Specifies the beginning of the resource description.

qname addr
Specifies the address in virtual storage of an 8-character name. The name should not start with SYS, so that it will not conflict with system names. Every task issuing RESERVE against the same resource must use the same qname and rname to represent the resource.

,rname addr
Specifies the address in virtual storage of the name used together with qname to represent a single resource. The name can be qualified, and must be from 1 to 255 bytes long.

,E
,S
Specifies whether the request is for exclusive (E) or shared (S) control of the resource. If the resource is modified while under control of the task, the request must be for exclusive control; if the resource is not modified, the request should be for shared control.

,rname length
Specifies the length of the *rname*. If this parameter is omitted, the system uses the assembled length of the *rname*. To override the assembled length, specify this parameter; the value you can code depends on whether or not you also specify MASID and MTCB:

- If you specify MASID and MTCB, you can code a value between 1 and 128.
- If you do not specify MASID and MTCB, you can code a value between 1 and 255.

In either case, you can specify 0, which means that the length of the *rname* must be contained in the first byte at the *rname addr*.

,SYSTEMS
Specifies that the resource is shared among systems.

) Specifies the end of the resource description.

,RET=TEST
,RET=USE
,RET=HAVE
,RET=NONE
RET=TEST, RET=USE, and RET=HAVE specify a conditional request for the resource named on the macro, as follows:

RET=TEST
The availability of the resource is to be tested, but control of the resource is not requested.

RET=USE
Control of the resource is to be assigned to the active task only if the resource is immediately available. When SYNCRES is enabled, the request will be subject to a delay for the reserve even if RET=USE or CONTENTIONACT=FAIL is specified.

RET=HAVE
Control of the resource is requested only if the same task does not already control or have an outstanding request for the same resource.

RET=NONE specifies an unconditional request for the resource named on the macro.

,UCB=ucb addr
Specifies the address of a fullword that contains the address of the UCB for the device to be reserved. The UCB must be allocated to the job step before RESERVE is issued.

Note: The UCB keyword might specify a UCB address for a UCB that resides in storage above or below 16 megabytes. If the UCB address might point to a UCB above 16 megabytes you must also specify LOC=ANY.

,LOC=BELOW**,LOC=ANY**

Specifies the location of the input UCB address. ANY specifies that the input UCB address is to be treated as a 31-bit address. BELOW specifies that the input UCB address is to be treated as a 24-bit address. The default is LOC=BELOW.

,RELATED=value

Specifies information used to self-document macros by “relating” functions or services to corresponding functions or services. The format and contents of the information specified are at the discretion of the user, and may be any valid values.

,LINKAGE=SVC**,LINKAGE=SYSTEM**

Specifies the type of linkage the caller is using to invoke the RESERVE service.

For LINKAGE=SVC, the linkage is through an SVC instruction. This linkage is valid only when the caller is in primary mode and the primary, home, and secondary address spaces are the same.

For LINKAGE=SYSTEM, the linkage uses a non-SVC entry. This linkage is valid in cross memory mode or in non-cross memory mode. LINKAGE=SYSTEM is intended to be used by programs in cross memory mode.

- If ECB= is specified, the ECB (not the address of the ECB) must be addressable from the home address space.

The default is LINKAGE=SVC.

ABEND codes

For unconditional requests only, the caller might encounter abend code X'138' or X'538'. For unconditional or conditional requests, the caller might encounter one of the following abend codes:

- X'238'
- X'338'
- X'438'
- X'738'
- X'838'
- X'938'

See *z/OS MVS System Codes* for explanations and responses for these codes.

Return and reason codes

The system provides return codes only if you specify RET=TEST, RET=USE, or RET=HAVE; for RET=NONE, return to the task indicates that control of the resource has been assigned to the task. If the return code for the resource named in the RESERVE macro is 0, register 15 contains 0. If the return code is not 0, register 15 contains the address of a 12-byte storage area containing the return code, as shown in [Figure 1](#).

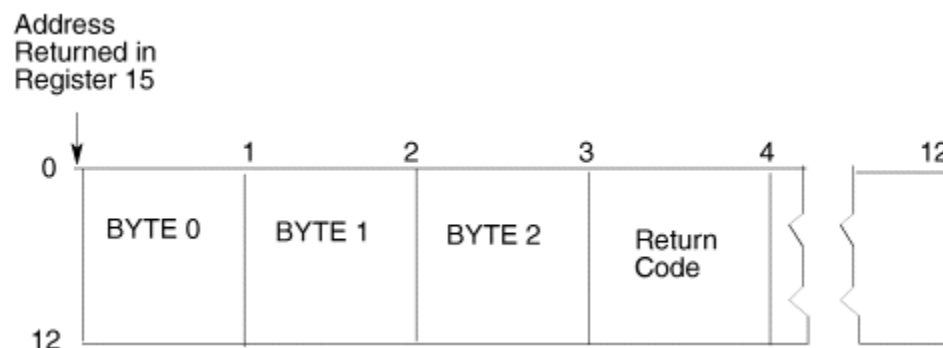

Figure 4. Return Code Area Used by RESERVE

The return codes for the RESERVE macro with the RET=TEST parameter are described in [Table 1](#).

<i>Table 48. Return Codes for the RESERVE Macro with the RET=TEST Parameter</i>	
Hexadecimal Return Code	Meaning and Action
0	<p>Meaning: The resource is immediately available.</p> <p>Action: None required. However, you might take some action based on your application.</p>
4	<p>Meaning: The resource is not immediately available or There might be contention on the reservethe hardware reserve is done synchronously. There might be contention on the reserve.</p> <p>Action: None required. However, you might take some action based on your application.</p>
8	<p>Meaning: A previous request for control of the same resource has been made for the same task. The task has control of the resource.</p> <p>Action: None required. However, you might take some action based on your application.</p> <p>To determine whether the task has exclusive control or shared control of the resource, check bit 3 of Byte 0 as shown in Figure 1. If bit 3 is off, the task has exclusive control; If bit 3 is on, the task has shared control.</p>
14	<p>Meaning: A previous request for control of the same resource has been made for the same task. The task does not have control of the resource.</p> <p>Action: None required. However, you might take some action based on your application.</p>

The return codes for the RESERVE macro with the RET=USE parameter are described in [Table 2](#).

<i>Table 49. Return Codes for the RESERVE Macro with the RET=USE Parameter</i>	
Hexadecimal Return Code	Meaning and Action
0	<p>Meaning: The active task now has control of the resource.</p> <p>Action: None.</p>
4	<p>Meaning: The resource is not immediately available.</p> <p>Action: None required. However, you might take some action based on your application.</p>
8	<p>Meaning: A previous request for control of the same resource has been made for the same task. The task has control of the resource.</p> <p>Action: None required. However, you might take some action based on your application.</p> <p>To determine whether the task has exclusive control or shared control of the resource, check bit 3 of Byte 0 as shown in Figure 1. If bit 3 is off, the task has exclusive control; If bit 3 is on, the task has shared control.</p>

Table 49. Return Codes for the RESERVE Macro with the RET=USE Parameter (continued)

Hexadecimal Return Code	Meaning and Action
14	<p>Meaning: A previous request for control of the same resource has been made for the same task. The task does not have control of the resource.</p> <p>Action: None required. However, you might take some action based on your application.</p>
18	<p>Meaning: Environmental error. The limit for the number of concurrent resource requests has been reached. The task does not have control of the resource unless some previous ENQ or RESERVE request caused the task to obtain control of the resource.</p> <p>Action: Retry the request one or more times. If the problem persists, consult your system programmer, who might be able to tune the system so that the limit is no longer exceeded.</p>

The return codes for the RESERVE macro with the RET=HAVE parameter are described in [Table 3](#).

Table 50. Return Codes for the RESERVE Macro with the RET=HAVE Parameter

Hexadecimal Return Code	Meaning and Action
0	<p>Meaning: The active task now has control of the resource.</p> <p>Action: None.</p>
8	<p>Meaning: A previous request for control of the same resource has been made for the same task. The task has control of the resource.</p> <p>Action: None required. However, you might take some action based on your application.</p> <p>To determine whether the task has exclusive control or shared control of the resource, check bit 3 of Byte 0 as shown in Figure 1. If bit 3 is off, the task has exclusive control; If bit 3 is on, the task has shared control.</p>
14	<p>Meaning: A previous request for control of the same resource has been made for the same task. The task does not have control of the resource.</p> <p>Action: None required. However, you might take some action based on your application.</p>
18	<p>Meaning: Environmental error. The limit for the number of concurrent resource requests has been reached. The task does not have control of the resource unless some previous ENQ or RESERVE request caused the task to obtain control of the resource.</p> <p>Action: Retry the request one or more times. If the problem persists, consult your system programmer, who might be able to tune the system so that the limit is no longer exceeded.</p>

Example

Unconditionally reserve exclusive control of a device. The length of the rname is allowed to default.

```
RESERVE (MAJOR3,MINOR3,E, ,SYSTEMS),UCB=(R3)
```

RESERVE—List form

The list form of the RESERVE macro is written as follows:

Syntax	Description
<i>name</i>	<i>name</i> : symbol. Begin <i>name</i> in column 1.

RESERVE macro

Syntax	Description
␣	One or more blanks must precede RESERVE.
RESERVE	
␣	One or more blanks must follow RESERVE.
(
<i>qname addr</i>	<i>qname addr</i> : A-type address.
,	<i>rname addr</i> : A-type address.
<i>,rname addr</i>	
,	
,E	
,S	
,	<i>rname length</i> : symbol or decimal digit.
<i>,rname length</i>	
,	
,SYSTEMS	
)	
,RET=TEST	
,RET=USE	
,RET=HAVE	
,RET=NONE	
,UCB= <i>ucb addr</i>	<i>ucb addr</i> : A-type address or 0.
,LOC=BELOW	Default: LOC=BELOW
,LOC=ANY	

Syntax	Description
,RELATED= <i>value</i>	<i>value</i> : A-type address.
,MF=L	

Parameters

The parameters are explained under the standard form of the RESERVE macro, with the following exception:

,MF=L

Specifies the list form of the RESERVE macro.

RESERVE - Execute form

The execute form of the RESERVE macro is written as follows:

Syntax	Description
<i>name</i>	<i>name</i> : symbol. Begin <i>name</i> in column 1.
␣	One or more blanks must precede RESERVE.
RESERVE	
␣	One or more blanks must follow RESERVE.
(Note: (and) are the beginning and end of a parameter list. The entire list is optional. If nothing in the list is desired, the (,) , and all parameters between (and) should not be specified. If something in the list is desired, then (,) , and all parameters in the list should be specified as indicated at the left.
<i>qname addr</i>	<i>qname addr</i> : RX-type address, or register (2) - (12).
,	<i>rname addr</i> : RX-type address, or register (2) - (12).
, <i>rname addr</i>	
,	
,E	
,S	

RESERVE macro

Syntax	Description
,	<i>rname length</i> : symbol, decimal digit, or register (2) - (12).
<i>,rname length</i>	Note: <i>rname length</i> must be coded if a register is specified for <i>rname addr</i> above.
,	
,SYSTEMS	
)	
,RET=TEST	
,RET=USE	
,RET=HAVE	
,RET=NONE	
,UCB= <i>ucb addr</i>	<i>ucb addr</i> : RX-type address, or register (2) - (12).
,LOC=BELOW	Default: LOC=BELOW
,LOC=ANY	
,RELATED= <i>value</i>	<i>value</i> : any valid macro keyword specification.
,LINKAGE=SVC	DEFAULT: LINKAGE=SVC
,LINKAGE=SYSTEM	
,MF=(E, <i>list addr</i>)	<i>list addr</i> : RX-type address, or register (1) - (12).

Parameters

The parameters are explained under the standard form of the RESERVE macro, with the following exception:

,MF=(E,ctrl addr)

Specifies the execute form of the RESERVE macro.

list addr specifies the area that the system uses to contain the parameters.

Chapter 87. RETURN – Return control

Description

The RETURN macro restores the control to the calling program and signals normal termination of the called program. The return of control is always made by executing a branch instruction using the address in register 14. Because the RETURN macro uses a BR 14 to pass control, it can be used only when the return is to a program that executes in the same addressing mode. The RETURN macro can restore a designated range of registers, provide a return code in register 15, and flag the save area used by the called program.

If registers are to be restored, or if an indicator is to be placed into the save area, register 13 must contain the address of the save area, which must have the standard format.

Syntax

The RETURN macro is written as follows:

Syntax	Description
<i>name</i>	<i>name</i> : Symbol. Begin <i>name</i> in column 1.
␣	One or more blanks must precede RETURN.
RETURN	
␣	One or more blanks must follow RETURN.
(<i>reg1</i>) (<i>reg1,reg2</i>)	<i>reg1</i> and <i>reg2</i> : Decimal digits, and in the order 14, 15, 0 through 12.
,T	
,RC= <i>ret code</i>	<i>ret code</i> : Decimal digit, symbol, or register (15). The maximum value is 4095.

Parameters

The parameters are explained as follows:

(*reg1*)

(*reg1,reg2*)

Specifies the register or range of registers to be restored from the save area pointed to by the address in register 13. If you omit this parameter, the contents of the registers are not altered. Do not code this parameter when returning control from a program interruption exit routine.

RETURN macro

,T

Causes the control program to flag the save area used by the called program. The low-order bit of word 4 of the save area is set to 1 after the registers have been loaded; this designates that a called program has executed a return to its caller. Do not specify this parameter when returning control from an exit routine.

,RC=*ret code*

Specifies the return code to be passed to the calling program. If a symbol or decimal digit is coded, the return code is placed right-adjusted in register 15 before return is made; if register 15 is coded, the return code has been previously loaded into register 15 and the contents of register 15 are not altered or restored from the save area. (If you omit this parameter, the contents of register 15 are determined by the *reg1* and *reg2* parameters.)

Note: If register 15 is coded and a return code greater than 4095 (decimal) is passed, the results could be either an invalid return code in the message or invalid RC testing.

Example

Restore registers 14-12, flag the save area, and return with a code of 0.

```
RETURN (14,12),T,RC=0
```

Chapter 88. SAVE – Save register contents

Description

The SAVE macro stores the contents of the specified general purpose registers in the save area at the address contained in register 13. If you wish, you may specify an entry point identifier. Write the SAVE macro only at the entry point of a program because the code resulting from the macro expansion requires that register 15 contain the address of the SAVE macro prior to its execution. Do not use the SAVE macro in a program interruption exit routine.

Syntax

The SAVE macro is written as follows:

Syntax	Description
<i>name</i>	<i>name</i> : Symbol. Begin <i>name</i> in column 1.
␣	One or more blanks must precede SAVE.
SAVE	
␣	One or more blanks must follow SAVE.
(<i>reg1</i>) (<i>reg1,reg2</i>)	<i>reg1</i> and <i>reg2</i> : Decimal digits, and in the order 14, 15, 0 through 12.
,	
,T	
, <i>id name</i>	<i>id name</i> : Character string of up to 70 characters or as an *.

Parameters

The parameters are explained as follows:

(*reg1*)

(*reg1,reg2*)

Specifies the register or range of registers to be stored in the save area at the address contained in register 13. The registers are stored in words 4 through 18 of the save area.

SAVE macro

,
,T

Specifies that registers 14 and 15 are to be stored in word 4 and 5, respectively, of the save area. This parameter permits you to save two noncontiguous sets of registers.

If you specify both T and *reg2*, and *reg1* is any of registers 14, 15, 0, 1, or 2, all of registers 14 through the *reg2* value are saved.

,id name

Specifies an identifier to be associated with the SAVE macro. If an asterisk (*) is coded, the identifier is the *name* associated with the SAVE macro, or, if the *name* field is blank, the control section name is used. The identifier aids in locating a program's save area in a dump. If the CSECT instruction name field is blank, the parameter is ignored.

Whenever a symbol or an asterisk is coded, the following macro expansion occurs:

- A count byte containing the number of characters in the identifier name is assembled four bytes following the address contained in register 15.
- The character string containing the identifier name is assembled starting at five bytes following the address contained in register 15.
- An instruction to branch around the count and identifier fields is assembled.

Example

Save registers 14-12, and associate the identifier with the CSECT name.

```
SAVE (14,12),,*
```

Chapter 89. SETRP – Set return parameters

Description

Use the SETRP macro within a recovery routine to indicate the various requests that the recovery routine can make. SETRP is valid for ESTAE-type recovery routines. For more information about recovery routines, see *z/OS MVS Programming: Assembler Services Guide*.

Environment

The requirements for the caller are:

Environmental factor	Requirement
Minimum authorization:	Problem state and any PSW key
Dispatchable unit mode:	Task or SRB
Cross memory mode:	Any PASN, any HASN, any SASN
AMODE:	24- or 31- or 64-bit
ASC mode:	Primary, secondary, or access register (AR) Note: Callers in secondary ASC mode cannot specify the DUMPOPX parameter.
Interrupt status:	Enabled or disabled for I/O and external interrupts
Locks:	The caller may hold locks, but is not required to hold any.
Control parameters:	None

Programming requirements

- If the program is in AR mode, issue the SYSSTATE ASCENV=AR macro before issuing SETRP. SYSSTATE ASCENV=AR tells the system to generate code appropriate for AR mode.
- Include the IHASDWA mapping macro to map the system diagnostic work area (SDWA). (See SDWA in *z/OS MVS Data Areas* in the *z/OS Internet library* (www.ibm.com/servers/resourcelink/svc00100.nsf/pages/zosInternetLibrary) for the mapping provided by IHASDWA.)
- If you plan to specify RETREGS=YES, RUB=*reg info addr*, you must obtain storage for and initialize the register update block (RUB). See the RETREGS parameter description for more information about this area.

Restrictions

- You can use SETRP only if the system provided an SDWA.
- Recovery routines established through the STAE macro, or the STAI parameter on the ATTACH or ATTACHX macro, cannot update registers on retry, so the RETREGS parameter does not apply.

Input register information

Before issuing the SETRP macro, the caller must ensure that the following general purpose register (GPRs) contain the specified information:

**Register
Contents**

SETRP macro

1

If you do not specify the WKAREA parameter, address of the SDWA; otherwise, the caller does not have to place any information into this register.

13

If you specify the REGS parameter, address of a standard 72-byte save area containing the registers to be restored; otherwise, the caller does not have to place any information into this register.

Before issuing the SETRP macro, the caller must ensure that the following access registers (ARs) contain the specified information:

Register

Contents

1

If you do not specify the WKAREA parameter, ALET of the SDWA whose address is in GPR 1; otherwise, the caller does not have to place any information into this register.

13

If you specify the REGS parameter, ALET of the standard 72-byte save area whose address is in GPR 13; otherwise, the caller does not have to place any information into this register.

Output register information

Note: Control does not return to the caller if the caller specifies the REGS parameter.

When control returns to the caller, the general purpose registers (GPRs) contain:

Register

Contents

0-1

Used as work registers by the system

2-13

Unchanged

14-15

Used as work registers by the system

When control returns to the caller, the access registers (ARs) contain:

Register

Contents

0-1

Used as work registers by the system

2-13

Unchanged

14-15

Used as work registers by the system

Some callers depend on register contents remaining the same before and after issuing a service. If the system changes the contents of registers on which the caller depends, the caller must save them before issuing the service, and restore them after the system returns control.

Performance implications

None.

Syntax

The SETRP macro is written as follows:

Syntax	Description
<i>name</i>	<i>name</i> : Symbol. Begin <i>name</i> in column 1.
␣	One or more blanks must precede SETRP.
SETRP	
␣	One or more blanks must follow SETRP.
,WKAREA=(<i>reg</i>)	<i>reg</i> : Decimal digits 1-12. Default: WKAREA=(1)
,REGS=(<i>reg1</i>)	<i>reg1</i> : Decimal digits 0-12, 14, 15.
,REGS=(<i>reg1,reg2</i>)	<i>reg2</i> : Decimal digits 0-12, 14, 15.
	Note: If you specify (<i>reg1,reg2</i>), specify the registers in the same order as in an STM instruction; for example, to restore all registers except register 13, specify REGS=(14,12).
,DUMP=IGNORE ,DUMP=YES ,DUMP=NO	Default: DUMP=IGNORE
,DUMPOPT= <i>parm list addr</i>	<i>parm list addr</i> : RX-type address, or register (2) - (12).
,DUMPOPX= <i>parm list addr</i>	Note: Appropriate only with DUMP=YES.
,REASON= <i>code</i>	<i>code</i> : Any four-byte number specified in decimal (31-bit) or hexadecimal (32-bit).
,RC=0 ,RC=4 ,RC=16	Default: RC=0
,RETADDR= <i>retry addr</i>	<i>retry addr</i> : RX-type address, or register (2) - (12).
	Note: This parameter may be specified only if RC=4 is specified above.
,REMREC=NO	Default: REMREC=NO
,REMREC=YES	

Syntax	Description
,RETREGS=NO	<i>reg info addr</i> : RX-type address, or register (2) - (12).
,RETREGS=YES	Default: RETREGS=NO
,RETREGS=YES,RUB= <i>reg info addr</i>	Note: This parameter may be specified only if RC=4 is specified above.
,RETREGS=64	
,FRESDDWA=NO	Default: FRESDDWA=NO
,FRESDDWA=YES	Note: This parameter may be specified only if RC=4 is specified above.
,COMPCOD= <i>comp code</i>	<i>comp code</i> : Symbol, decimal digit, or register (2) - (12).
,COMPCOD=(<i>comp code</i> ,USER) ,COMPCOD=(<i>comp code</i> ,SYSTEM)	Default: COMPCOD=(<i>comp code</i> ,USER)
,RECPARM= <i>record list addr</i>	<i>record list addr</i> : RX-type address, or register (2) - (12).
,RETRYAMODE= <i>amode</i>	<i>amode</i> : decimal 24, 31, or 64. Only honored for ESTAE, ESTAI, ESTAEX, and IEAARR recovery routines.

Parameters

The parameters are explained as follows:

,WKAREA=(*reg*)

Specifies the address of the SDWA passed to the recovery routine.

,REGS=(*reg1*)

,REGS=(*reg1,reg2*)

Specifies the register or range of registers to be restored from the 72-byte standard save area pointed to by the address in register 13. If you specify REGS, a branch on register 14 instruction will also be generated to return control to the system. If you do not specify REGS, you must code your own branch on whichever register contains the return address.

Note: If you specify *reg1,reg2*, specify the registers in the same order as in an STM instruction; for example, to restore all registers except register 13, specify REGS=(14,12).

,DUMP=IGNORE

,DUMP=YES

,DUMP=NO

Specifies that the dump option fields will not be changed (IGNORE), will be zeroed (NO), or will be merged with dump options specified in previous dump requests, if any (YES). If IGNORE is specified, a previous recovery routine had requested a dump or a dump had been requested through the ABEND macro, and the previous request will remain intact. If NO is specified, no dump will be taken.

DUMP=YES does not guarantee that a SYSABEND/SYSUDUMP will be taken. You may specify this request in an FRR for an SRB but you will get an abdump only if the SRB abend successfully percolates

to a task *and* none of the FRRs for that task choose to retry *and* the final value of the DUMP= remains the same after every recovery routine has received control.

,DUMPOPT=parm list addr

,DUMPOPX=parm list addr

Specifies the address of a parameter list of options. To create the parameter list, use the list form of either the SNAP or SNAPX macro, or code data constants in your program. DUMPOPT specifies the address of a parameter list that the SNAP macro creates. DUMPOPX specifies the address of a parameter list that the SNAPX macro creates. A program in secondary mode cannot use the DUMPOPX parameter.

If the specified dump options include subpools for storage areas to be dumped, up to seven subpools can be dumped. Subpool areas are accumulated and wrapped, so that the eighth subpool area specified replaces the first.

If the dump options specified include ranges of storage areas to be dumped, only the storage areas in the first thirty ranges will be dumped.

The TCB, DCB, ID, and STRHDR options available on SNAP or SNAPX are ignored if they appear in the parameter list. The TCB used is the one for the task that encountered the error. The DCB used is one created by the system, and either SYSABEND, SYSMDUMP, or SYSUDUMP is used as a DDNAME.

,REASON=code

Specifies the reason code that the user wishes to pass to subsequent recovery routines.

,RC=0

,RC=4

,RC=16

Specifies the return code the recovery routine sends to recovery processing to indicate what further action is required:

0

Continue with error processing, causes entry into previously specified recovery routine, if any.

4

Retry using the retry address specified.

16

Valid only for an ESTAI/STAI recovery routine. The system should not give control to any further ESTAI/STAI routines, and should abnormally end the task.

,RETADDR=retry addr

Specifies the address of the retry routine to which control is to be given.

,REMREC=YES

,REMREC=NO

In an ESTAE environment, specifies that the ESTAE entry for the currently running ESTAE routine be removed (REMREC=YES) or not removed (REMREC=NO). This parameter may be specified only when RC=4 is specified, indicating a retry request.

The entry is removed before control returns to the retry point. If REMREC=YES is not coded on any SETRP invocation before the system receives control, the effect is that of specifying REMREC=NO. The REMREC parameter may be used to remove a recovery routine that has been established with a token, although the token cannot be specified when you code the SETRP macro.

,RETREGS=NO

,RETREGS=YES

,RETREGS=YES,RUB=reg info addr

,RETREGS=64

Specifies the contents of the registers to be restored on entry to the retry routine. RETREGS=NO indicates that you do not want the system to restore any register contents from the SDWA.

If you specify RETREGS=YES, in a recovery routine defined through the ESTAE or ESTAEX macro, the ESTAI parameter on the ATTACH or ATTACHX macro, or an associated recovery routine (ARR), the system does the following:

SETRP macro

- Initializes GPRs 0-15 from the SDWASRSV field of the SDWA
- Initializes ARs 0-15 from the SDWAARSV field of the SDWA.

Specifying RETREGS=64 is the same as specifying RETREGS=YES, except the registers for retry are the 64-bit general purpose registers in field SDWAG64.

RUB (register update block) specifies the address of an area that contains register update information for the GPRs. The data you specify in this area will be moved into the SDWASRSV field of the SDWA and will be loaded into the GPRs on entry to the retry routine. You cannot use the RUB to specify data to be moved into the SDWAARSV field for loading the ARs. The maximum length of the RUB is 66 bytes. You must acquire storage for and initialize this area as follows:

- The first two bytes represent the registers to be updated, register 0 corresponding to bit 0, register 1 corresponding to bit 1, and so on. The user indicates which of the registers are to be stored in the SDWA by setting the corresponding bits in these two bytes.
- The remaining 64 bytes contain the update information for the registers, in the order 0-15. If all 16 registers are being updated, this field consists of 64 bytes. If only one register is being updated, this field consists of only 4 bytes for that one register.

For example, if only registers 4, 6, and 9 are being updated:

- Bits 4, 6, and 9 of the first two bytes are set.
- The remaining field consists of 12 bytes for registers 4, 6, and 9; the first 4 bytes are for register 4, followed by 4 bytes for register 6, and 4 final bytes for register 9.

,FRESDDWA=NO

,FRESDDWA=YES

Specifies that the entire SDWA be freed (YES) or not be freed (NO) prior to entry into the retry routine.

,COMPCOD=comp code

,COMPCOD=(comp code,USER)

,COMPCOD=(comp code,SYSTEM)

Specifies the user or system completion code that the user wishes to pass to subsequent recovery routines.

,RECPARM=record list addr

Specifies the address of a user-supplied record parameter list used to update the SDWA with recording information. The parameter list consists of three 8-byte fields:

- The first field contains the load module name.
- The second field contains the CSECT name (assembly module name).
- The third field contains the recovery routine name (assembly module name). If the recovery routine label is not the same as the assembly module name, the label can be used.

The three fields are left-justified, and padded with blanks.

,RETRYAMODE=amode

Specifies an explicit AMODE in which a retry routine receives control. Valid values are 24, 31, and 64. This parameter is only honored for ESTAE, ESTAI, ESTAEX, and IEARR recovery routines. If you do not specify this parameter, RTM selects an AMODE as described in [Providing recovery in z/OS MVS Programming: Assembler Services Guide](#).

ABEND codes

None.

Return and reason codes

None.

Example 1

Request to continue terminating, suppress dumping, restore register 14 from the save area, and pass control to the location it contains, contain the SDWA in the location addressed by register 3, and change the completion code to 10.

```
SETRP RC=0, DUMP=NO, REGS=(14), WKAREA=(3), X
      COMPCOD=(X'00A', USER)
```

Example 2

Retry using address X, take a dump before retry, use the contents of SDWASRSV to initialize the registers, free the SDWA before control is passed to the retry address, and restore registers 14-12.

```
SETRP RC=4, RETREGS=YES, DUMP=YES, FRESDDWA=YES, X
      REGS=(14, 12), RETADDR=X
```

Chapter 90. SNAP and SNAPX – Dump virtual storage and continue

Description

You can use the SNAP macro to obtain a dump of some or all of the storage assigned to the current job step. You can also dump some or all of the control program fields. The SNAP macro causes the specified storage to be displayed in the addressing mode of the caller.

Users typically allocate the SNAP or SNAPX macro output to a sysout data set but instead you can allocate it to a sequential data set, member of a PDS or PDSE or a z/OS UNIX file. If you choose a UNIX file, code FILEDATA=TEXT or FILEDATA=RECORD on the DD statement.

Descriptions of the SNAP and SNAPX macros in this information are:

- The standard form of the SNAP macro, which includes general information about the SNAP and SNAPX macros, with some specific information about SNAP. The topic also describes the syntax of the SNAP macro and explains the SNAP macro parameters.
- The standard form of the SNAPX macro, which presents specific information about the SNAPX macro. The topic describes the syntax of the SNAPX macro and explains the parameters that are valid only on the SNAPX macro.
- The list form of the SNAP and SNAPX macros.
- The execute form of the SNAP and SNAPX macros.

There are three ways to obtain a dump:

1. Spool the dump by specifying SYSOUT=x on the DD statement. The dump is printed without a separate job but is deferred until after the job ends.
2. Select a tape or direct access device. This method requires a separate job step to print the dump. This method might be used if the dump is to be printed more than once.
3. Select a printer on the DD statement. This method is almost never used because the printer cannot be used by anyone else for the duration of the job step.

Both NUC and ALLVNUC are valid. Only ALLVNUC gives you the whole virtual nucleus. For more information about the SNAP macro, see [z/OS MVS Programming: Assembler Services Guide](#).

Note: The SNAP and SNAPX macros have the same environment specifications, register information, programming requirements, restrictions and limitations, performance implications, and return codes described below. However, **IBM recommends** that programs in access register (AR) address space control (ASC) mode use SNAPX. All parameters on SNAP are valid on SNAPX.

Environment

The requirements for the caller are:

Environmental factor	Requirement
Minimum authorization:	Problem state and any PSW key
Dispatchable unit mode:	Task
Cross memory mode:	PASN=HASN=SASN
AMODE:	24- or 31-bit

Environmental factor	Requirement
ASC mode:	Primary or AR Note: If your program is in AR mode and you issue SNAP rather than SNAPX following SYSSTATE ASCENV=AR, the system substitutes the SNAPX macro and issues a message telling you that it made the substitution.
Interrupt status:	Enabled for I/O and external interrupts
Locks:	No locks held, and no enabled, unlocked task (EUT) FRRs established
Control parameters:	Must be in the primary address space

Input register information

Before issuing the SNAP(X) macro, the caller does not have to place any information into any register unless using it in register notation for a particular parameter, or using it as a base register.

Output register information

When control returns to the caller, the general purpose registers (GPRs) contain:

Register Contents

0-1

Used as work registers by the system

2-14

Unchanged

15

Return code

When control returns to the caller, the access registers (ARs) contain:

Register Contents

0-1

Used as work registers by the system

2-13

Unchanged

14-15

Used as work registers by the system

Some callers depend on register contents remaining the same before and after issuing a service. If the system changes the contents of registers on which the caller depends, the caller must save them before issuing the service, and restore them after regaining control.

Programming requirements

Before you issue the SNAP macro, you must open the DCB that you designate on the DCB parameter, and ensure that the DCB is not closed until the SNAP macro returns control. To open the DCB, issue the DCB macro with the following parameters, and issue an OPEN macro for the data set (the DCB and OPEN macros are described in *MVS/DFP Macro Instructions for Data Sets*):

```
DSORG=PS,RECFM=VBA,MACRF=(W),BLKSIZE=nnn,LRECL=xxx,  
and DDNAME=any name but SYSABEND, SYSDUMP or SYSUDUMP
```

Dynamic allocation options

If the DD name for the SNAP dump has the XTIO, UCB nocapture, or DSAB-above-the-line options of dynamic allocation, your DCB must point to a DCBE before you open the DCB. The DCBE must have the LOC=ANY option. You can code that even if the DD name does not have any of these dynamic allocation options. To point the DCB to the DCBE, code the DCBE operand on the DCB macro, or store into the DCBDCBE field if you also turn on the DCBH0 and DCBH1 bits. The DCBE can reside above the 16 MB line even if your program runs in 24-bit.

In order for the OPEN for the DCB to succeed, it is necessary for the NON_VSAM_XTIO=YES option in the DEVSUPxx member of PARMLIB to be active. Your program can test whether that option is in effect by testing the DFAXTBAM bit as mapped by the IHADFA macro. The CVTDFA word points to the DFA.

For dynamic allocation, XTIO option bit is S99TIOTEX, the UCB nocapture option bit is S99ACUCB, and the DSAB-above-the-line option bit is S99DSABA. These options are defined by the IEFZB4D0 macro. For more information about the XTIO option for dynamic allocation of the dump data set, see S99PARMS programming interface in *z/OS MVS Data Areas* in the *z/OS Internet library* (www.ibm.com/servers/resourcelink/svc00100.nsf/pages/zosInternetLibrary).

If a standard dump of 120 characters per line is requested, BLKSIZE must be either 882 or 1632, and LRECL must be 125. A high-density dump printed on a 3800 Printing Subsystem has 204 characters per line. To obtain a high-density dump, you must code CHARS=DUMP on the DD statement describing the dump data set. The BLKSIZE= must be either 1470 or 2724, and the LRECL= must be 209. You can also code CHARS=DUMP on the DD statement describing a dump data set that will not be printed immediately. If you specify CHARS=DUMP and the output device is not a 3800, print lines are truncated and print data is lost. If you open a SNAP data set in a problem program that will be processed by the system loader, your problem program must close the data set.

The DCB and TCB must reside in 24-bit addressable storage. All other parameters can reside above 16 megabytes if the issuer is executing in 31-bit addressing mode.

If the program is in AR mode, issue SNAPX rather than SNAP; issue the SYSSTATE ASCENV=AR macro before SNAPX. SYSSTATE ASCENV=AR tells the system to generate code appropriate for AR mode.

Note: The SNAP and SNAPX parameters cannot be updated using the CHNGDUMP command. Only ABDUMP, SYSMDUMP, SYSUDUMP and SVC DUMP parameters can be altered using CHNGDUMP.

Restrictions

None.

Performance implications

None.

Syntax

The standard form of the SNAP macro is written as follows:

Syntax	Description
<i>name</i>	<i>name</i> : Symbol. Begin <i>name</i> in column 1.
␣	One or more blanks must precede SNAP.
SNAP	

Syntax	Description															
␣	One or more blanks must follow SNAP.															
DCB= <i>dcb addr</i>	<i>dcb addr</i> : A-type address, or register (2) - (12).															
,TCB= <i>tcb addr</i>	<i>tcb addr</i> : A-type address, or register (2) - (12).															
,ID= <i>id nmb</i>	<i>id nmb</i> : Symbol, decimal digit, or register (2) - (12). Value range: 0-255															
,SDATA=ALL																
,SDATA=(<i>sys data code</i>)	<i>sys data code</i> : Any combination of the following, separated by commas. If you specify only one code, you do not need the parentheses.															
	<table border="0"> <tr> <td>NUC</td> <td>CB</td> <td>ERR</td> </tr> <tr> <td>SQA</td> <td>Q</td> <td>IO</td> </tr> <tr> <td>LSQA</td> <td>TRT</td> <td>ALLVNUC</td> </tr> <tr> <td>PCDATA</td> <td></td> <td></td> </tr> <tr> <td>SWA</td> <td>DM</td> <td>SUM</td> </tr> </table>	NUC	CB	ERR	SQA	Q	IO	LSQA	TRT	ALLVNUC	PCDATA			SWA	DM	SUM
NUC	CB	ERR														
SQA	Q	IO														
LSQA	TRT	ALLVNUC														
PCDATA																
SWA	DM	SUM														
,PDATA=ALL																
,PDATA=(<i>prob data code</i>)	<i>prob data code</i> : Any combination of the following, separated by commas. If you specify only one code, you do not need the parentheses.															
	<table border="0"> <tr> <td>PSW</td> </tr> <tr> <td>REGS</td> </tr> <tr> <td>SA or SAH</td> </tr> <tr> <td>JPA or LPA or ALLPA</td> </tr> <tr> <td>SPLS</td> </tr> <tr> <td>SUBTASKS</td> </tr> </table>	PSW	REGS	SA or SAH	JPA or LPA or ALLPA	SPLS	SUBTASKS									
PSW																
REGS																
SA or SAH																
JPA or LPA or ALLPA																
SPLS																
SUBTASKS																
,STORAGE=(<i>strt addr,end addr</i>) ,LIST= <i>list addr</i>	<i>strt addr</i> : A-type address, or register (2) - (12). <i>end addr</i> : A-type address, or register (2) - (12). <i>list addr</i> : A-type address, or register (2) - (12).															
	Note: One or more pairs of addresses may be specified, separated by commas. For example: STORAGE=(<i>strt addr,end addr, strt addr,end addr</i>)															
,STRHDR=(<i>hdr addr</i>)	<i>hdr addr</i> : A-type address, or register (2) - (12).															
,STRHDR= <i>hdr list addr</i>	Note: <i>hdr addr</i> is one or more addresses separated by commas. If you specify only one header address as an A-type address, you do not need the parentheses. If you specify one or more registers, then you must code double parentheses (one set enclosing each register and one set enclosing the list of registers). If STRHDR=(<i>hdr addr</i>) is specified, then STORAGE must also be specified.															

Syntax	Description
	<i>hdr list addr</i> : A-type address, or register (2) - (12). Note: If STRHDR= <i>hdr list addr</i> is specified, then LIST must also be specified.
,SUBPLST= <i>sbp list addr</i>	<i>sbp list addr</i> : A-type address, or register (2) - (12).

Parameters

The parameters are explained as follows:

DCB=*dcb addr*

Specifies the address of a previously opened data control block for the data set that is to contain the dump.

Note:

1. DCB must reside in 24-bit addressable storage.
2. The DCB parameter **is not** required when you issue the list form of SNAP or SNAPX to format a parameter list for the DUMPOPT/DUMPOPX parameter of the ABEND, CALLRTM, or SETRP macros. If the parameter list you specify on DUMPOPT/DUMPOPX contains a DCB value, the system overrides it. The DCB parameter **is** required when you issue the list form of SNAP or SNAPX to format a parameter list for an execute form of SNAP or SNAPX if the execute form does not specify the DCB parameter. That is, if you specify both a list and execute form of SNAP or SNAPX, you must specify DCB on one or the other.
3. If the DD name for the SNAP dump has the XTIOU, UCB nocapture, or DSAB-above-the-line options of dynamic allocation, your DCB must point to a DCBE before you open the DCB. See the "Programming Requirements" section for more details.

,TCB=*tcb addr*

Specifies the address of a fullword on a fullword boundary containing the address of the task control block for a task of the current job step. If omitted, or if the fullword contains 0, the dump is for the active task. If a register is designated, the register can contain 0 to indicate the active task, or can contain the address of a TCB.

Note: TCB must reside in 24-bit addressable storage.

,ID=*id nmb*

Specifies the number that is to be printed in the identification heading with the dump. If the number specified is not in the acceptable value range, it will not be printed properly in the heading.

,SDATA=ALL

,SDATA=(*sys data code*)

Specifies the system control program information to be dumped:

ALL

All of the SDATA options except ALLVNUC (The read-only portion of the nucleus is not included in the dump unless ALLVNUC is also specified as an option.)

NUC

The PSA, SQA, LSQA, and the read/write portion of the nucleus (if the entire nucleus is required, specify the ALLVNUC option.)

Note: The CVT will be included if this option is specified.

SQA

The system queue area (subpools 226, 239, and 245).

LSQA

The local system queue area and subpools 229, 230, and 249.

Note: Subpools 229, 230, and 249 will be dumped only for the current task.

SWA

The scheduler work area related to the task (subpools 236 and 237).

CB

The control blocks for the task.

Q

The global resource serialization control blocks for the task.

TRT

The GTF trace and system trace data. If system tracing is active and the requestor is authorized, all system trace entries for all address spaces are included in the dump. Unauthorized requestors obtain those system trace entries, after the job-start time stamp in the ASCB, for their current address space. If GTF tracing is active, only the GTF trace entries for the current address space are included in the dump.

DM

Data management control blocks for the task.

ERR

Recovery/termination control blocks for the task. These control blocks summarize information that describes abnormal terminations of the task.

IO

Input/Output supervisor control blocks for the task.

ALLVNUC

The entire virtual nucleus, the PSA, LSQA, and SQA. (The NUC option will not dump the read-only section of the nucleus.) If the SNAP parameter list is used for a SYSDUMP, the ALLVNUC option is converted to ALLNUC on the SVC dump parameter list.

Note: The CVT is included if this option is specified.

PCDATA

Program call information for the task.

The SUM option is valid for an abending task or on a list form of the SNAP macro pointed to by the DUMPOPT keyword of the ABEND or SETRP macro. The option SUM causes the dump to contain a summary dump. If SUM is the only option requested, the dump contains a dump header, control blocks, and the other areas listed below. The header information, which is provided for all ABEND dumps, consists of the following information:

- The dump title
- The ABEND code and program status word (PSW) at the time of the error
- If the PSW contains the address of an active load module:
 - The name and PSW address of the load module in error
 - The offset, into the load module, at which the error occurred

The following control blocks and areas are also included in the dump:

- The control blocks dumped for the CB option
- The error control blocks (RTM2WAs and SCBs)
- The save areas
- The registers at the time of the error, except for register 1
- The contents of the load module (if the PSW contains the address of an active load module)
- The module pointed to by the last PRB (if it can be found)
- 1K of storage before and after the addresses pointed to by the PSW and the registers at the time of the error

Note: This storage will only be dumped if the caller is authorized to obtain it. The storage is printed by ascending storage addresses with duplicate addresses removed.

- System trace entries after the job-start time stamp in the ASCB for the current address space

Note: The GTF trace records are not included.

If other options are specified with SUM, the summary dump is dispersed throughout the dump.

,PDATA=ALL

,PDATA=(*prob data code*)

Specifies the problem program information to be dumped:

ALL

All of the following fields.

PSW

Program status word when the SNAP or ABEND macro was issued.

REGS

Contents of the floating-point registers and general-purpose registers (except for GPR 1) when the SNAP or ABEND macro was issued. Also, contents of the vector registers, vector status register, and the vector mask register when the SNAP or ABEND macro was issued for any task that uses the Vector Facility.

SA

Save area linkage information, program call linkage information, and a back trace through save areas.

SAH

Save area linkage information and program call linkage information.

JPA

Contents of job pack area.

LPA

Contents of active link pack area for the requested task.

ALLPA

Contents of job pack area and active link pack area for the requested task.

SPLS

Virtual storage subpools 0-127, 131-132, 252.

SUBTASKS

The designated task and the program data information for all of its subtasks.

,STORAGE=(*strt addr,end addr*)

,LIST=*list addr*

Specifies one or more pairs of starting and ending addresses or a list of starting and ending addresses of areas to be dumped. Each starting address is rounded down to a fullword boundary; each ending address is rounded up to a fullword boundary. The area is then dumped in fullword increments.

Callers executing in either 24-bit or 31-bit addressing mode must set the high-order bit of the fullword containing the last address in this list to 1. Callers executing in 31-bit addressing mode must ensure that this bit is cleared in all other addresses in the list because SNAP processing truncates the list at the first address that contains a 1 in the high order bit.

,STRHDR=(*hdr addr*)

,STRHDR=*hdr list addr*

Specifies one or more header addresses or the address of a list of header addresses. Each header address must be the address of a one byte header length field, which is followed by the text of the header. The header has a maximum length of 100 characters.

If the STORAGE parameter was specified, the STRHDR (storage header) value must be one or more header addresses. The number of pairs of starting and ending addresses specified for STORAGE must be the same as the number of header addresses specified for STRHDR. If a header is not desired for a storage area, a comma must be used to indicate its absence.

If the LIST parameter was specified, the STRHDR value must be the address of a list of header addresses. The list of addresses must begin on a fullword boundary, and the high order bit of the fullword containing the last address of the list must be set to 1. The number of pairs of starting and ending addresses supplied with the LIST parameter must be the same as the number of addresses in the list supplied with STRHDR. If a header is not desired for a storage area, the STRHDR list must contain a zero address to indicate its absence.

,SUBPLST=*sbp list addr*

Specifies the address of a list of subpool numbers to be dumped. Each entry in the list must be a two-byte entry and must specify a valid subpool number. The first halfword of the list must contain the number of subpools in the list and must be on a fullword boundary. If you specify an invalid subpool number or a subpool number for which you do not have authorization, the number is skipped and you receive a comment in the dump output indicating the error. If a subpool contains 4k blocks of data that are mapped from a linear data set, the dump includes only the blocks that have changed since the last DIV SAVE function was invoked.

Note: A maximum of seven subpool numbers is permitted on the list form of the SNAP macro pointed to by the DUMPOPT keyword of ABEND or SETRP.

Return and reason codes

Control is returned to the instruction following the SNAP macro. When control is returned, register 15 contains one of the following return codes:

Hexadecimal Code	Meaning
00	Successful completion.
04	Data control block was not open, or an invalid page exception occurred during the validity check of the DCB parameters.
08	Task control block address was not valid, an invalid page reference occurred during the validity check of the TCB address, a subtask is a job step task, sufficient storage was not available, or the READ for JFCB or JFCBE failed. In all cases, the dump is canceled. (Message IEA997I is issued when the READ for JFCB or JFCBE fails.) Or , the ALET for SNAP parameter list or the ALETs for areas pointed to by the parameter list are not valid.
0C	Data control block type (DSORG, RECFM, MACRF, BLKSIZE, or LRECL) was incorrect, or the DCB's BLKSIZE and/or LRECL were not compatible with the dump format options specified on the dump-related DD statement.
10	DEBCHK TYPE=VERIFY function failed. This may be due to DEBDCBAD not pointing to the DCB (or ACB) passed to DEBCHK.

Example 1

Dump the storage ranges pointed to by register 9, and dump all PDATA and SDATA options.

```
SNAP DCB=(8),TCB=(5),PDATA=ALL,SDATA=ALL,LIST=(9)
```

Example 2

Dump the storage ranges pointed to by register 9, and dump only the trace table and enqueue control blocks.

```
SNAP DCB=(8),TCB=(5),ID=4,LIST=(9),SDATA=(TRT,Q)
```

Example 3

Dump storage area 1000-2000 with no header, and dump storage area 3000-4000 with a header of 'USER LABEL ONE'. The comma specified in the value for STRHDR indicates that no header is wanted for storage area 1000-2000.

```

SNAP   DCB=(8),STORAGE=(1000,2000,3000,4000), X
      :
      :
L1     DC   AL1(L'HDR1)
HDR1   DC   C'USER LABEL ONE'
```

Example 4

Dump storage area 1000-1999 with a header of 'LABEL ONE' and dump storage area 3000-3999 with a header of 'LABEL TWO'.

```

SNAP   DCB=(8),LIST=X,STRHDR=L1
      :
      :
X      DC   A(1000)           Start address
      DC   A(1999)           End address
      DC   A(3000)           Start address
      DC   X'80'             End of list indicator
      DC   AL3(3999)         End address
L1     DC   A(HDR1)          Address of length label for
      :                      header one
      DC   X'80'             End of list
      DC   AL3(HDR2)         Address of length label for
      :                      header two
HDR1   DC   AL1(L'HDR1A)     Length of header one
HDR1A  DC   C'LABEL ONE'     Header one
HDR2   DC   AL1(L'HDR2A)     Length of header two
HDR2A  DC   C'LABEL TWO'     Header two
```

Example 5

Dump subpool 0, 1, and 2 storage related to the current TCB.

```

SNAP   DCB=XYZ,TCB=0,SUBPLST=SUBADDR
      :
      :
SUBADDR DS 0F                Fullword boundary
      DC X'0003'             Number of entries in the list
      DC X'0000'             Subpool 0
      DC X'0001'             Subpool 1
      DC X'0002'             Subpool 2
```

SNAPX – Dump virtual storage and continue

The SNAPX macro performs the same function as SNAP: it enables you to obtain a dump of some or all of the storage assigned to the current job step. SNAPX is intended for use by programs running in access register (AR) mode. Programs running in primary mode can also use SNAPX.

Note: The SNAPX macro has the same environment specifications, register information, programming requirements, restrictions and limitations, performance implications and return codes as the SNAP macro. However, **IBM recommends** that programs in AR ASC mode use SNAPX. All parameters on SNAP are valid on SNAPX.

Syntax

The standard form of the SNAPX macro is written as follows:

SNAP and SNAPX macros

Syntax	Description															
<i>name</i>	<i>name</i> : Symbol. Begin <i>name</i> in column 1.															
␣	One or more blanks must precede SNAPX.															
SNAPX																
␣	One or more blanks must follow SNAPX.															
DCB= <i>dcb addr</i>	<i>dcb addr</i> : A-type address, or register (2) - (12).															
,TCB= <i>tcb addr</i>	<i>tcb addr</i> : A-type address, or register (2) - (12).															
,ID= <i>id nmr</i>	<i>id nmr</i> : Symbol, decimal digit, or register (2) - (12). Value range: 0-255															
,SDATA=ALL																
,SDATA=(<i>sys data code</i>)	<i>sys data code</i> : Any combination of the following, separated by commas. If you specify only one code, you do not need the parentheses.															
	<table border="0"> <tr> <td>NUC</td> <td>CB</td> <td>ERR</td> </tr> <tr> <td>SQA</td> <td>Q</td> <td>IO</td> </tr> <tr> <td>LSQA</td> <td>TRT</td> <td>ALLVNUC</td> </tr> <tr> <td>PCDATA</td> <td></td> <td></td> </tr> <tr> <td>SWA</td> <td>DM</td> <td>SUM</td> </tr> </table>	NUC	CB	ERR	SQA	Q	IO	LSQA	TRT	ALLVNUC	PCDATA			SWA	DM	SUM
NUC	CB	ERR														
SQA	Q	IO														
LSQA	TRT	ALLVNUC														
PCDATA																
SWA	DM	SUM														
,PDATA=ALL																
,PDATA=(<i>prob data code</i>)	<i>prob data code</i> : Any combination of the following, separated by commas. If you specify only one code, you do not need the parentheses.															
	<table border="0"> <tr> <td>PSW</td> </tr> <tr> <td>REGS</td> </tr> <tr> <td>SA or SAH</td> </tr> <tr> <td>JPA or LPA or ALLPA</td> </tr> <tr> <td>SPLS</td> </tr> <tr> <td>SUBTASKS</td> </tr> </table>	PSW	REGS	SA or SAH	JPA or LPA or ALLPA	SPLS	SUBTASKS									
PSW																
REGS																
SA or SAH																
JPA or LPA or ALLPA																
SPLS																
SUBTASKS																
,STORAGE=(<i>strt addr,end addr</i>) ,LIST= <i>list addr</i>	<i>strt addr</i> : A-type address, or register (2) - (12). <i>end addr</i> : A-type address, or register (2) - (12). <i>list addr</i> : A-type address, or register (2) - (12).															

Syntax	Description
	Note: One or more pairs of addresses may be specified, separated by commas. For example: STORAGE=(<i>strt addr,end addr,strt addr,end addr</i>)
,STRHDR=(<i>hdr addr</i>)	<i>hdr addr</i> : A-type address, or register (2) - (12).
,STRHDR= <i>hdr list addr</i>	Note: <i>hdr addr</i> is one or more addresses separated by commas. If you specify only one header address as an A-type address, you do not need the parentheses. If you specify one or more registers, then you must code double parentheses (one set enclosing each register and one set enclosing the list of registers). If you specify STRHDR=(<i>hdr addr</i>), you must also specify STORAGE.
	<i>hdr list addr</i> : A-type address, or register (2) - (12).
	Note: If you specify STRHDR= <i>hdr list addr</i> , you must also specify LIST.
,SUBPLST= <i>sbp list addr</i>	<i>sbp list addr</i> : A-type address, or register (2) - (12).
,DSPSTOR= <i>list addr</i>	<i>list addr</i> : A-type address or reg (2) - (12).

Parameters

Parameters for the SNAPX macro are the same as those for the SNAP macro, except for the DSPSTOR parameter, which is valid only on SNAPX. SDATA=SUM has a different function for callers in AR mode. These two parameters are described as follows:

,SDATA=SUM

The SUM option is valid for an abending task or on a list form of the SNAPX macro pointed to by the DUMPOPX parameter of the ABEND or SETRP macro. For the contents of the summary dump, see the description of the SDATA parameter in the SNAP macro.

,DSPSTOR=*list addr*

Specifies the address of a list of data space storage areas to be dumped. Use this parameter to dump data that is in a data space.

Each entry in the parameter list you create describes an area to be dumped; the entry must contain a start address, end address, and STOKEN. The list must begin on a fullword boundary, and the high order bit of the fullword containing the last end address in the list must be set to 1. The system dumps storage from any data space to which the caller has authority; it does not dump storage to which the caller does not have authority.

You can specify the DSPSTOR parameter for SNAPX parameter lists that are identified by the DUMPOPX parameter on the ABEND or SETRP macro.

SNAP and SNAPX—List form

Use the list form of the SNAP or SNAPX macro to construct a control program parameter list. You can specify any number of storage addresses using the STORAGE parameter. Therefore, the number of starting and ending address pairs in the list form of SNAP or SNAPX must be equal to the maximum number of addresses specified in any execute form of the macro, or a DS instruction must immediately follow the list form to allow for the maximum number of addresses.

Syntax

The list form of the SNAP or SNAPX macro is written as follows:

SNAP and SNAPX macros

Syntax	Description
<i>name</i>	<i>name</i> : Symbol. Begin <i>name</i> in column 1.
␣	One or more blanks must precede SNAP or SNAPX.
SNAP SNAPX	
␣	One or more blanks must follow SNAP or SNAPX.
DCB= <i>dcb addr</i>	<i>dcb addr</i> : A-type address. Note: The DCB parameter is not required in all cases. See the parameter description for details.
,ID= <i>id nmr</i>	<i>id nmr</i> : Symbol or decimal digit. Value range: 0-255
,SDATA=ALL	
,SDATA=(<i>sys data code</i>)	<i>sys data code</i> : Any combination of the following, separated by commas. If you specify only one code, you do not need parentheses.
	<pre> NUC CB ERR SQA Q IO LSQA TRT ALLVNUC PCDATA SWA DM SUM </pre>
,PDATA=ALL	
,PDATA=(<i>prob data code</i>)	<i>prob data code</i> : Any combination of the following, separated by commas. If you specify only one code, you do not need parentheses.
	<pre> PSW REGS SA or SAH JPA or LPA or ALLPA SPLS SUBTASKS </pre>

Syntax	Description
,STORAGE=(<i>strt addr,end addr</i>) ,LIST= <i>list addr</i>	<i>strt addr</i> : A-type address. <i>end addr</i> : A-type address. <i>list addr</i> : A-type address.
	Note: One or more pairs of addresses may be specified, separated by commas. For example:
	STORAGE=(<i>strt addr,end addr,strt addr,end addr</i>)
,STRHDR=(<i>hdr addr</i>) ,STRHDR= <i>hdr list addr</i>	<i>hdr addr</i> : A-type address.
	Note: <i>hdr addr</i> is one or more addresses separated by commas. If you specify only one header address, you do not need the parentheses. If STRHDR=(<i>hdr addr</i>) is specified, then STORAGE must also be specified.
	<i>hdr list addr</i> : A-type address.
	Note: If STRHDR= <i>hdr list addr</i> is specified, then LIST must also be specified.
,SUBPLST= <i>sbp list addr</i>	<i>sbp list addr</i> : A-type address.
,DSPSTOR= <i>list addr</i>	<i>list addr</i> : A-type address or register (2) - (12).
,MF=L	

Parameters

The parameters are explained under the standard form of the SNAP and SNAPX macros, with the following exception:

,MF=L

Specifies the list form of the SNAP or SNAPX macro.

SNAP and SNAPX—Execute form

A remote control-program parameter list is referred to and can be modified by the execute form of the SNAP or SNAPX macro.

If you code only the DCB, ID, MF, or TCB parameters in the execute form of the macro, the bit settings in the parameter list corresponding to the SDATA, PDATA, LIST, and STORAGE parameters are not changed. However, if you code the SDATA, PDATA, or LIST parameters, the bit settings for the coded parameter from the previous request are reset to zero, and only the areas requested in the current macro are dumped.

Syntax

The execute form of the SNAP or SNAPX macro is written as follows:

SNAP and SNAPX macros

Syntax	Description															
<i>name</i>	<i>name</i> : Symbol. Begin <i>name</i> in column 1.															
␣	One or more blanks must precede SNAP.															
SNAP SNAPX																
␣	One or more blanks must follow SNAP.															
DCB= <i>dcb addr</i>	<i>dcb addr</i> : RX-type address, or register (2) - (12). Note: The DCB parameter is not required in all cases. See the parameter description for details.															
,TCB= <i>tcb addr</i> ,TCB='S'	<i>tcb addr</i> : RX-type address, or register (2) - (12).															
,ID= <i>id nmb</i>	<i>id nmb</i> : Symbol, decimal digit or register (2) - (12). Value range: 0-255															
,SDATA=ALL																
,SDATA=(<i>sys data code</i>)	<i>sys data code</i> : Any combination of the following, separated by commas. If you specify only one code, you do not need parentheses.															
	<table border="0"> <tbody> <tr> <td>NUC</td> <td>CB</td> <td>ERR</td> </tr> <tr> <td>SQA</td> <td>Q</td> <td>IO</td> </tr> <tr> <td>LSQA</td> <td>TRT</td> <td>ALLVNUC</td> </tr> <tr> <td>PCDATA</td> <td></td> <td></td> </tr> <tr> <td>SWA</td> <td>DM</td> <td>SUM</td> </tr> </tbody> </table>	NUC	CB	ERR	SQA	Q	IO	LSQA	TRT	ALLVNUC	PCDATA			SWA	DM	SUM
NUC	CB	ERR														
SQA	Q	IO														
LSQA	TRT	ALLVNUC														
PCDATA																
SWA	DM	SUM														
,PDATA=ALL																
,PDATA=(<i>prob data code</i>)	<i>prob data code</i> : Any combination of the following, separated by commas. If you specify only one code, you do not need parentheses.															

Syntax	Description
	PSW REGS SA or SAH JPA or LPA or ALLPA SPLS SUBTASKS
,STORAGE=(<i>strt addr,end addr</i>) ,LIST= <i>list addr</i>	<i>strt addr</i> : RX-type address, or register (2) - (12). <i>end addr</i> : RX-type address, or register (2) - (12). <i>list addr</i> : RX-type address, or register (2) - (12).
	Note: One or more pairs of addresses may be specified, separated by commas. For example:
	STORAGE=(<i>strt addr,end addr,strt addr,end addr</i>)
,STRHDR=(<i>hdr addr</i>) ,STRHDR= <i>hdr list addr</i>	<i>hdr addr</i> : RX-type address, or register (2) - (12). Note: <i>hdr addr</i> is one or more addresses separated by commas. If you specify only one header address as an RX-type address, you do not need the parentheses. If you specify one or more registers, then you must code double parentheses (one set enclosing each register and one set enclosing the list of registers). If STRHDR=(<i>hdr addr</i>) is specified, then STORAGE must also be specified.
	<i>hdr list addr</i> : RX-type address, or register (2) - (12). Note: If STRHDR= <i>hdr list addr</i> is specified, then LIST must also be specified.
,SUBPLST= <i>sbp list addr</i>	<i>sbp list addr</i> : RX-type address, or register (2) - (12).
,DSPSTOR= <i>list addr</i>	<i>list addr</i> : A-type address or register (2) - (12).
,MF=(E, <i>ctrl addr</i>)	<i>ctrl addr</i> : RX-type address, or register (1) or (2) - (12).

Parameters

The parameters are explained under the standard form of the SNAP and SNAPX macros, with the following exceptions:

,TCB='S'

Specifies the task control block of the active task.

Note: TCB='S' causes a dump of the active task if this is the first use of the list form of the SNAP or SNAPX macro or if the TCB specified on a previous execute form of the SNAP or SNAPX macro was the current TCB or TCB='S'.

,MF=(E,*ctrl addr*)

specifies the execute form of the SNAP or SNAPX macro using a remote control program parameter list.

Chapter 91. SPIE – Specify program interruption exit

Description

Note: IBM recommends that you use the ESPIE macro rather than SPIE. Callers in 31-bit addressing mode must use the ESPIE macro, which performs the same function as the SPIE macro for callers in both 24-bit and 31-bit addressing mode.

The SPIE macro specifies the address of an interruption exit routine and the program interruption types that are to cause the exit routine to get control.

Note: In MVS/370 the SPIE environment existed for the life of the task. In later versions of MVS, the SPIE environment is deleted when the request block that created it is deleted. That is, when a program running under a later version of MVS completes, any SPIE environments created by the program are deleted. This might create an incompatibility with MVS/SP Version 1 for programs that depend on the SPIE environment remaining in effect for the life of the task rather than the request block.

Each succeeding SPIE macro completely overrides any previous SPIE macro specifications for the task. The specified exit routine is given control in the key of the TCB when one of the specified program interruptions occurs in any problem program of the task. When a SPIE macro is issued from a SPIE exit routine, the program interruption element (PIE) is reset (zeroed). Thus, a SPIE exit routine should save any required PIE data before issuing a SPIE. If a caller issues an ESPIE macro from within a SPIE exit routine, it has no effect on the contents of the PIE. However, if an ESPIE macro deletes the last SPIE/ESPIE environment, the PIE is freed and the SPIE exit cannot retry.

If the current SPIE environment is cancelled during SPIE exit routine processing, the control program will not return to the interrupted program when the SPIE program terminates. Therefore, if the SPIE exit routine wishes to retry within the interrupted program, a SPIE cancel should not be issued within the SPIE exit routine.

The SPIE macro can be issued by any problem program being executed in the performance of the task. The control program automatically deletes the SPIE exit routine when the request block (RB) that issued the SPIE macro terminates.

A PICA (program interruption control area) is created as part of the expansion of SPIE. The PICA contains the exit routine's address and a code indicating the interruption types specified in SPIE.

For more information on the SPIE macro, see the information on program interruption services in [z/OS MVS Programming: Assembler Services Guide](#).

Environment

The requirements for the caller are:

Environmental factor	Requirement
Minimum authorization:	To issue SPIE without encountering an abnormal end, callers must be in problem state, with a PSW key value that is equal to the TCB assigned key.
Dispatchable unit mode:	Task
Cross memory mode:	PASN=HASN=SASN
AMODE:	24-bit
ASC mode:	Primary
Interrupt status:	Enabled for I/O and external interrupts
Locks:	No locks held

SPIE macro

Environmental factor

Control parameters:

Requirement

Must be in the primary address space

Programming requirements

The caller must include the following mapping macros:

- IHAPIE
- IHAPICA

Restrictions

None.

Input register information

Before issuing the SPIE macro, the caller does not have to place any information into any register unless using it in register notation for a particular parameter, or using it as a base register.

Output register information

When control returns to the caller, the general purpose registers (GPRs) contain the following information:

Register

Contents

0

Used as a work register by the system.

1

If a SPIE environment is already active when you issue the SPIE macro, the SPIE service routine returns the address of the previous PICA in register 1. You can use this PICA to restore the previously active SPIE environment. However, if an ESPIE environment is active when you issue the SPIE macro, the SPIE service returns the address, in register 1, of a PICA in which the first word contains binary zeros. You cannot modify the contents of this PICA, and it contains no useful information except to restore the previous SPIE or ESPIE environment. If no previous SPIE/ESPIE environment is active, the service routine returns a zero in register 1.

2-13

Unchanged.

14-15

Used as work registers by the system.

When control returns to the caller, the access registers (ARs) contain:

Register

Contents

0-1

Used as work registers by the system

2-13

Unchanged

14-15

Used as work registers by the system

Some callers depend on register contents remaining the same before and after issuing a service. If the system changes the contents of registers on which the caller depends, the caller must save them before issuing the service, and restore them after the system returns control.

Performance implications

None.

Syntax

The standard form of the SPIE macro is written as follows:

Syntax	Description
<i>name</i>	<i>name</i> : Symbol. Begin <i>name</i> in column 1.
␣	One or more blanks must precede SPIE.
SPIE	
␣	One or more blanks must follow SPIE.
<i>exit addr</i>	<i>exit addr</i> : A-type address, or register (2) - (12).
<i>,(interrupts)</i>	<i>interrupts</i> : Decimal numbers 1-15 expressed as: single values: (2,3,4,7,8,9,10) ranges of values: ((2,4),(7,10)) combinations: (2,3,4,(7,10))

Parameters

The parameters are explained as follows:

exit addr

Specifies the address of the exit routine to be given control when a specific program interruption occurs. The exit routine receives control in 24-bit addressing mode.

,(interrupts)

Indicates the type of interruption for which the exit routine is to be given control. The interruption types are as follows:

Number

Interruption Type

1

Operation

2

Privileged operation

3

Execute

4

Protection

SPIE macro

5	Addressing
6	Specification
7	Data
8	Fixed-point overflow (maskable)
9	Fixed-point divide
10	Decimal overflow (maskable)
11	Decimal divide
12	Exponent overflow
13	Exponent underflow (maskable)
14	Significance (maskable)
15	Floating-point divide

Note:

1. If an exit address is zero or no parameters are specified, the current SPIE and any previously active ESPIE environments are cancelled.
2. If a program interruption type is maskable, the corresponding program mask bit in the PSW (program status word) is set to 1 when specified and to 0 when not specified. Interruption types that are not maskable and not specified above are handled by the system, which forces an abend with the program check as the completion code. If an ESTAE-type recovery routine is also active, the SDWA indicates a system-forced abnormal termination. The registers at the time of the error are those of the system.
3. If you are using vector instructions and an interruption of 8, 12, 13, 14, or 15 occurs, your recovery routine can check the exception extension code (the first byte of the two-byte interruption code in the EPIE or PIE) to determine whether the exception was a vector or scalar type of exception.

ABEND codes

The SPIE macro might return abend codes X'10E', X'30E', or X'46D'. See [z/OS MVS System Codes](#) for explanations and programmer responses.

Return and reason codes

None.

Example

Give control to an exit routine for interruption 1, 5, 7, 8, 9, and 10. DOITSPIE is the address of the SPIE exit routine.

```
SPIE DOITSPIE,(1,5,(7,10))
```

SPIE—List form

Use the list form of the SPIE macro to construct a control program parameter list in the form of a program interruption control area.

Syntax

The list form of the SPIE macro is written as follows:

Syntax	Description
<i>name</i>	<i>name</i> : Symbol. Begin <i>name</i> in column 1.
b	One or more blanks must precede SPIE.
SPIE	
b	One or more blanks must follow SPIE.
<i>exit addr</i>	<i>exit addr</i> : A-type address.
<i>, (interrupts)</i>	<i>interrupts</i> : Decimal numbers 1-15 expressed as: single values: (2,3,4,7,8,9,10) ranges of values: ((2,4),(7,10)) combinations: (2,3,4,(7,10))
<i>,MF=L</i>	

Parameters

The parameters are explained under the standard form of the SPIE macro, with the following exception:

,MF=L

Specifies the list form of the SPIE macro.

SPIE - Execute form

A remote control program parameter list is used in, and can be modified by, the execute form of the SPIE macro. The PICA (program interruptions control area) can be generated by the list form of SPIE, or you can use the address of the PICA returned in register 1 following a previous SPIE macro. If this macro is being issued to reestablish a previous SPIE environment, code only the MF parameter.

Syntax

The execute form of the SPIE macro is written as follows:

SPIE macro

Syntax	Description
<i>name</i>	<i>name</i> : Symbol. Begin <i>name</i> in column 1.
‡	One or more blanks must precede SPIE.
SPIE	
‡	One or more blanks must follow SPIE.
<i>exit addr</i>	<i>exit addr</i> : RX-type address, or register (2) - (12).
<i>,(interrupts)</i>	<i>interrupts</i> : Decimal numbers 1-15, expressed as single values: (2,3,4,7,8,9,10) ranges of values: ((2,4),(7,10)) combinations: (2,3,4,(7,10))
<i>,MF=(E,ctrl addr)</i>	<i>ctrl addr</i> : RX-type address, or register (1) or (2) - (12).

Parameters

The parameters are explained under the standard form of the SPIE macro, with the following exception:

,MF=(E,ctrl addr)

Specifies the execute form of the SPIE macro using a remote control program parameter list.

Note: If SPIE is coded with a 0 as the control address, the SPIE environment is canceled.

Chapter 92. SPLEVEL – Set macro level

Description

Use the SPLEVEL macro to ensure that the assembler generates the correct level for a particular macro that your program issues. You might need to control the level of a macro expansion if you assemble your program on one version and release of MVS, then run the program on a different version and release of MVS, and one of the following is true:

- Your program issues MVS macros that are downward incompatible to MVS/System Product Version 1.
- Your program issues installation- or vendor-written macros that are incompatible between versions and releases.

See [Compatibility of MVS macros](#) for additional information about the downward incompatible MVS macros. Authorized callers of SPLEVEL should consult “Selecting the Macro Level” in the following for the lists of downward incompatible MVS macros that are authorized:

- [z/OS MVS Programming: Authorized Assembler Services Reference ALE-DYN](#)
- [z/OS MVS Programming: Authorized Assembler Services Reference EDT-IXG](#)
- [z/OS MVS Programming: Authorized Assembler Services Reference LLA-SDU](#)
- [z/OS MVS Programming: Authorized Assembler Services Reference SET-WTO](#)

For installation- or vendor-written macros, see the installation or vendor information to determine if incompatibilities between versions and releases exist.

You can use SPLEVEL in two ways:

- Within your program, issue SPLEVEL with the SET=*n* parameter prior to issuing another macro to set the desired level for that macro. SPLEVEL SET=*n* sets a global symbol (&SYSSPLV) to the value *n*. Certain macros (including all the downward incompatible macros) check this global symbol during assembly to determine which expansion of the macro to generate. Once you set the macro level, all macros in your program that check the &SYSSPLV global symbol expand at that level until you change the level to some other value.

Authorized callers of SPLEVEL should consult the Macro Summary in the chapter entitled “Using the Macros” in the following publications for the lists of authorized macros that check the SPLEVEL global symbol:

- [z/OS MVS Programming: Authorized Assembler Services Reference ALE-DYN](#)
- [z/OS MVS Programming: Authorized Assembler Services Reference EDT-IXG](#)
- [z/OS MVS Programming: Authorized Assembler Services Reference LLA-SDU](#)
- [z/OS MVS Programming: Authorized Assembler Services Reference SET-WTO](#)

See [High Level Assembler Language Reference](#) for information about global set symbols.

- Within a macro you are writing, issue SPLEVEL with the TEST parameter to ensure that the macro level is set:
 1. Define the &SYSSPLV global symbol within your macro.
 2. Issue SPLEVEL TEST, which checks to see if the caller set the macro level.
 3. Define different logical paths within your macro to correspond to the macro level that is in effect.

Existing programs that were assembled using Version 2, Version 3, Version 4, and Version 5 macros will run properly on z/OS.

Environment

The requirements for the caller are:

Environmental factor	Requirement
Minimum authorization:	Problem state and any PSW key.
Dispatchable unit mode:	Task or SRB
Cross memory mode:	Any PASN, any HASN, any SASN
AMODE:	24- or 31-bit
ASC mode:	Primary or access register (AR)
Interrupt status:	Enabled or disabled for I/O and external interrupts
Locks:	The caller may hold locks, but is not required to hold any.
Control parameters:	None.

Programming requirements

None.

Restrictions

None.

Input register information

Before issuing the SPLEVEL macro, the caller does not have to place any information into any register unless using it in register notation for a particular parameter, or using it as a base register.

Output register information

When control returns to the caller, the general purpose registers (GPRs) and access registers (ARs) are all unchanged.

Performance implications

None.

Syntax

The SPLEVEL macro is written as follows:

Syntax	Description
<i>name</i>	<i>name</i> : Symbol. Begin <i>name</i> in column 1.
␣	One or more blanks must precede SPLEVEL.
SPLEVEL	
␣	One or more blanks must follow SPLEVEL.

Syntax	Description
TEST	
SET= <i>n</i>	<i>n</i> : 2, 3, 4, 5 or 6
SET	Default: SET=6

Parameters

The parameters are explained as follows:

TEST

TEST checks the &SYSSPLV global variable, and does the following:

- Sets &SYSSPLV to the default value if &SYSSPLV **does not** contain a value indicating that you did not issue SPLEVEL SET during this assembly.
- Leaves the value of &SYSSPLV unchanged, if &SYSSPLV **does** contain a value indicating that you issued SPLEVEL SET during this assembly.

SET=*n*

SET

Specifies the macro level by setting the global symbol &SYSSPLV.

- SET=*n* places a value in &SYSSPLV equal to *n*, where *n* must be 2, 3, 4, 5 or 6.
- SET without *n*, results in the assembler using the default value, 6.

ABEND codes

None.

Return and reason codes

None.

Example 1

Select the version 1 expansion of a specific downward incompatible macro.

```
SPLEVEL SET=1
```

Example 2

Use SPLEVEL TEST within your own macro to ensure the &SYSSPLV global symbol is set.

```

.
.
.
GBLC    &SYSSPLV          Define global symbol
SPLEVEL TEST             If global symbol has no value,
                          set to the default.
.V5     AIF                ('&SYSSPLV' EQ '1').V1 Use code for V1
        ANOP              This logical path contains instructions appropriate
                          for a V2, V3, V4, or V5 expansion.
.
.
.
.V1     AGO                .COMMON
        ANOP              This logical path contains instructions appropriate
                          for a V1 expansion.
.
.

```

SPLEVEL macro

```
.COMMON ANOP
```

Chapter 93. STAE – Specify task abnormal exit

Note: IBM recommends that you use the ESTAEX macro or ESTAE macro rather than STAE.

Description

The STAE macro enables the user to intercept a scheduled ABEND and to have control returned to him at a specified exit routine address. The STAE macro operates in both problem program and supervisor modes.

Note: The STAE macro is not supported for users executing in 31-bit addressing mode. Such users will be abended.

Syntax

The standard form of the STAE macro is written as follows:

Syntax	Description
<i>name</i>	<i>name</i> : Symbol. Begin <i>name</i> in column 1.
␣	One or more blanks must precede STAE.
STAE	
␣	One or more blanks must follow STAE.
<i>exit addr</i>	<i>exit addr</i> : A-type address, or register (2) - (12).
0	
,CT	Default: CT
,OV	
,PARAM= <i>list addr</i>	<i>list addr</i> : A-type address, or register (2) - (12).
,XCTL=NO	Default: XCTL=NO
,XCTL=YES	
,PURGE=QUIESCE	Default: PURGE=QUIESCE
,PURGE=HALT	
,PURGE=NONE	

Syntax	Description
,ASYNCH=NO	Default: ASYNCH=NO
,ASYNCH=YES	
,RELATED= <i>value</i>	<i>value</i> : Any valid macro keyword specification.

Parameters

The parameters are explained as follows:

exit addr

0

Specifies the address of a STAE exit routine to be entered if the task issuing this macro terminates abnormally. If 0 is specified, the most recent STAE request is canceled.

,CT

,OV

Specifies the creation of a new STAE exit (CT) or indicates that the parameters passed in this STAE macro are to overlay the data contained in the previous STAE exit (OV).

,PARAM=*list addr*

Specifies the address of a user-defined parameter list containing data to be used by the STAE exit routine when it is scheduled for execution.

,XCTL=NO

,XCTL=YES

Specifies that the STAE macro will be canceled (NO) or will not be canceled (YES) if an XCTL macro is issued by this program.

,PURGE=QUIESCE

,PURGE=HALT

,PURGE=NONE

Specifies that all outstanding requests for I/O operations are not saved when the STAE exit is taken (HALT), that I/O processing is allowed to continue normally when the STAE exit is taken (NONE), or that all outstanding requests for I/O operations are saved when the STAE exit is taken (QUIESCE). For QUIESCE, at the end of the STAE exit routine, the user can code a retry routine to handle the outstanding I/O requests.

Note: If any IBM-supplied access method, except EXCP, is being used, the PURGE=NONE option is recommended. If you use PURGE=NONE, all control blocks affected by input/output processing can continue to change during STAE exit routine processing.

If PURGE=NONE is specified and the ABEND was originally scheduled because of an error in input/output processing, an ABEND recursion develops when an input/output interruption occurs, even if the exit routine is in progress. Thus, it appears that the exit routine failed when, in reality, input/output processing caused the failure.

ISAM Notes: If ISAM is being used and PURGE=HALT is specified or PURGE=QUIESCE is specified but I/O is not restored:

- Only the input/output event on which the purge is done is posted. Subsequent event control blocks (ECBs) are not posted.
- The ISAM check routine treats purged I/O as normal I/O.
- Part of the data set may be destroyed if the data set is being updated or added to when the failure occurred.

,ASYNCH=NO**,ASYNCH=YES**

Specifies that asynchronous exit processing is allowed (YES) or is not allowed (NO) while the STAE exit is executing.

ASYNCH=YES must be coded if:

- The STAE exit routine requests any supervisor services that require asynchronous interruptions to complete their normal processing.
- PURGE=QUIESCE is specified for any access method that requires asynchronous interruptions to complete normal input/output processing.
- PURGE=NONE is specified and the CHECK macro is issued in the STAE exit routine for any access method that requires asynchronous interruptions to complete normal input/output processing.

Note: If ASYNCH=YES is specified and the ABEND was originally scheduled because of an error in asynchronous exit handling, an ABEND recursion develops when an asynchronous interruption occurs. Thus, it appears that the exit routine failed when, in reality, asynchronous exit handling caused the failure.

,RELATED=value

Specifies information used to self-document macros by relating functions or services to corresponding functions or services. The format and contents of the information specified are at the discretion of the user, and may be any valid coding values. Control returns to the instruction following the STAE macro.

Return codes

Register 15 contains one of the following hexadecimal return codes from TIMEUSED:

Hexadecimal Return Code	Meaning
00	Successful completion of STAE request.
04	STAE was unable to obtain storage for STAE request.
08	Attempt was made to cancel or overlay a nonexistent STAE request.
0C	Exit routine or parameter list address was invalid, or STAI request was missing a TCB address.
10	Attempt was made to cancel or overlay a STAE request of another user, or an unexpected error was encountered while processing this request.

Example

Request an overlay of the existing STAE recovery exit with the following options: new exit address is ADDR, parameter list is at PLIST, halt I/O, do not take asynchronous exits, transfer ownership to the new request block resulting from any XCTL macros.

```
STAE ADDR,OV,PARAM=PLIST,XCTL=YES,PURGE=HALT,ASYNCH=NO
```

STAE - List form

The list form of the STAE macro is used to construct a remote control program parameter list.

Syntax

The list form of the STAE macro is written as follows:

Syntax	Description
<i>name</i>	<i>name</i> : Symbol. Begin <i>name</i> in column 1.
␣	One or more blanks must precede STAE.
STAE	
␣	One or more blanks must follow STAE.
<i>exit addr</i>	<i>exit addr</i> : A-type address.
,PARAM= <i>list addr</i>	<i>list addr</i> : A-type address.
,PURGE=QUIESCE	Default: PURGE=QUIESCE
,PURGE=HALT	
,PURGE=NONE	
,ASYNCH=NO	Default: ASYNCH=NO
,ASYNCH=YES	
,RELATED= <i>value</i>	<i>value</i> : Any valid macro keyword specification.
,MF=L	

Parameters

The parameters are explained under the standard form of the STAE macro, with the following exception:

,MF=L

Specifies the list form of the STAE macro.

STAE - Execute form

A remote control program parameter list is used in, and can be modified by, the execute form of the STAE macro. The control program parameter list can be generated by the list form of the STAE macro. If you want to dynamically change the contents of the remote STAE parameter list, you can do so by coding a new exit address and/or a new parameter list address. If exit address or PARM= is coded, only the associated field in the remote STAE parameter list is changed. The other field remains as it was before the current STAE request was made.

Syntax

The execute form of the STAE macro is written as follows:

Syntax	Description
<i>name</i>	<i>name</i> : Symbol. Begin <i>name</i> in column 1.
␣	One or more blanks must precede STAE.
STAE	
␣	One or more blanks must follow STAE.
<i>exit addr</i>	<i>exit addr</i> : RX-type address, or register (2) - (12).
0	
,CT	
,OV	
,PARAM= <i>list addr</i>	<i>list addr</i> : RX-type address, or register (2) - (12).
,XCTL=NO	
,XCTL=YES	
,PURGE=QUIESCE	
,PURGE=HALT	
,PURGE=NONE	
,ASYNCH=NO	
,ASYNCH=YES	
,RELATED= <i>value</i>	<i>value</i> : Any valid macro keyword specification.
,MF=(E, <i>ctrl addr</i>)	<i>ctrl addr</i> : RX-type address, or register (1) or (2) - (12).

Parameters

The parameters are explained under the standard form of the STAE macro, with the following exception:

STAE macro

,MF=(E, *ctrl addr*)

Specifies the execute form of the STAE macro using a remote control program parameter list.

Example

Provide the pointer to the recovery code in the register called EXITPTR, and the address of the STAE exit parameter list in register 9. Register 8 points to the area where the STAE parameter list (created with the MF=L option) was moved.

```
STAE (EXITPTR),PARAM=(9),MF=(E,(8))
```

Chapter 94. STATUS – Start and stop a subtask

Description

Use the STATUS macro to change the dispatchability status of one or all of a program's subtasks. For example, the STATUS macro can be used to restart subtasks that were stopped when an attention exit routine was entered.

Environment

The requirements for the caller are:

Environmental factor	Requirement
Minimum authorization:	Problem state and any PSW key
Dispatchable unit mode:	Task
Cross memory mode:	PASN=HASN=SASN or PASN¬=HASN¬=SASN
AMODE:	31-bit
ASC mode:	Primary or access register (AR)
Interrupt status:	Enabled or disabled for I/O and external interrupts
Locks:	No locks held.
Control parameters:	No requirements.

Programming requirements

None.

Restrictions

The caller cannot have an EUT FRR established.

Input register information

Before issuing the STATUS macro, the caller does not have to place any information into any register unless using it in register notation for a particular parameter, or using it as a base register.

Output register information

When control returns to the caller, the GPRs contain:

Register Contents

0-1

Used as work registers by the system

2-13

Unchanged

14

Used as a work register by the system

15

Return code

STATUS macro

When control returns to the caller, the access registers (ARs) contain:

Register Contents

0-1

Used as work registers by the system

2-13

Unchanged

14-15

Used as work registers by the system

Some callers depend on register contents remaining the same before and after issuing a service. If the system changes the contents of registers on which the caller depends, the caller must save them before issuing the service, and restore them after the system returns control.

Performance implications

Using STATUS will degrade performance of the calling program's address space while STATUS runs.

Syntax

The STATUS macro is written as follows:

Syntax	Description
<i>name</i>	<i>name</i> : Symbol. Begin <i>name</i> in column 1.
␣	One or more blanks must precede STATUS.
STATUS	
␣	One or more blanks must follow STATUS.
START STOP	
,TCB= <i>tcb addr</i>	<i>tcb addr</i> : RX-type address or address in register (2) - (12).
,RELATED= <i>value</i>	<i>value</i> : Any valid macro keyword specification.

Parameters

The parameters are explained as follows:

START STOP

Specifies that the task identified on the TCB parameter is to be stopped (STOP) or started (START). If you omit the TCB parameter, all subtasks of the originating task are stopped or started.

Note: This parameter does not ensure that the subtask is stopped when control is returned to the issuer. A subtask can have a “stop deferred” condition that would cause that particular subtask to remain dispatchable until stops are no longer deferred. In a multiprogramming environment, it would be possible to have a task issue the STATUS macro with the STOP parameter and resume processing while the subtask (for which the STOP was issued) is redispached to another processor.

,TCB=tcb addr

Specifies the address of a fullword on a fullword boundary containing the address of the task control block that is to have its START/STOP count adjusted. (If a register is specified, however, the address is of the TCB itself.) If this parameter is not coded, the count is adjusted in the task control blocks for all the subtasks of the originating task.

Note: TCB must reside in 24-bit addressable storage.

,RELATED=value

Specifies information used to self-document macros by “relating” functions or services to corresponding functions or services. The format and contents of the information specified are at the discretion of the user and may be any valid coding values.

The RELATED parameter is available on macros that provide opposite services (for example, ATTACH/DETACH, GETMAIN/FREEMAIN, and LOAD/DELETE) and on macros that relate to previous occurrences of the same macros (for example, CHAP and ESTAE).

The RELATED parameter may be used, for example, as follows:

```

STAT1  STATUS  STOP,TCB=YOURTCB,RELATED=(STAT2,
:
:
:
STAT2  STATUS  START,TCB=YOURTCB,RELATED=(STAT1,
:
:
:
'STOP A SUBTASK')
'START A SUBTASK')
```

Note: Each of these macros will fit on one line when coded, so there is no need for a continuation indicator.

Return codes

Return codes from execution of STATUS are as follows:

<i>Table 52. Return Codes for the STATUS Macro</i>	
Hexadecimal Return Code	Meaning and Action
00	Meaning: Processing completed successfully. Action: No action necessary.
04	Meaning: Program error. START/STOP request failed. The task you specified is not a subtask of the calling program's task. Action: Ensure that you specify a task on the TCB parameter that is a subtask of the calling program.

Example 1

Stop all subtasks.

```
STATUS  STOP
```

Example 2

Create a subtask. Stop the subtask, then restart it.

STATUS macro

```

        PRINT NOGEN
STATUS  CSECT
STATUS  AMODE 31
STATUS  RMODE ANY
*****
* The following code performs the following functions:      *
* 1. Creates a subtask by issuing the ATTACH macro.         *
* 2. Stops the subtask by issuing the STATUS macro with the *
*    STOP parameter.                                       *
* 3. Starts the stopped subtask by issuing the STATUS macro *
*    with the START parameter.                              *
*****
        SPACE 3
*****
* Entry linkage *
*****
        SPACE 3
        STM  R14,R12,12(R13)
        BALR R12,0
        USING BEGN,R12
BEGN    DS  0H
        ST   R13,SAVE+4
        LA  R15,SAVE
        ST  R15,8(0,R13)
        LR  R13,R15
        EJECT
*****
* Attach a subtask and request that it be notified by an ECB when *
* the subtask completes. *
*****
        SPACE 3
ATTCH1  ATTACH EP=SUBTASK,ECB=AMYECB
        SPACE 3
        ST   R1,TCBADDR          SAVE SUBTASK TCB ADDRESS
        EJECT
*****
* Stop the subtask by issuing STATUS STOP, then restart it by *
* issuing STATUS START. *
*****
        SPACE 3
        STATUS STOP,TCB=TCBADDR
        SPACE 3
        .
*****
* Processing of other subtasks continues. *
*****
        .
        STATUS START,TCB=TCBADDR
        SPACE 3
        EJECT
*****
* Wait until subtask completes, then detach it. *
*****
        SPACE 3
        WAIT 1,ECB=AMYECB          WAIT ON E-O-T ECB
        SPACE 3
        DETACH TCBADDR            DETACH SUBTASK
        SPACE 3
        EJECT
*****
* End of job *
*****
        SPACE 3
FINI    DS  0H
        L   R13,SAVE+4
        DROP R12
        LM  R14,R12,12(R13)
        XR  R15,R15
        BR  R14
        EJECT
*****
* Define constants *
*****
SAVE    DC  18F'0'
*
TCBADDR DC  F'0'          ADDRESS OF SUBTASK TCB
AMYECB  DC  F'0'          END-OF-SUBTASK ECB
        EJECT

```



```
*****  
*   Register equates   *  
*****  
      SPACE 3  
R1     EQU  1  
R12    EQU 12  
R13    EQU 13  
R14    EQU 14  
R15    EQU 15  
      LTOrg  
      END
```

Chapter 95. STCKCONV – Store clock conversion routine

Description

The STCKCONV macro converts an input time-of-day (TOD) clock value to time of day and date, and returns the converted values to the caller in the format requested. The input clock value can be either the basic time-of-day (TOD) format or the extended time-of-day (ETOD) format.

- TOD – Unsigned 64-bit binary number
- ETOD – Unsigned 128-bit binary number

See *z/OS MVS Programming: Assembler Services Guide* and *z/Architecture Principles of Operation* for information comparing the formats of the TOD and ETOD.

The STCKCONV time of day and date formats are compatible with the formats returned by the TIME macro, which returns a time of day and date value or the contents of the TOD clock. The STCKCONV time of day and date formats are also compatible with the input formats accepted by the CONVTOD macro, which converts a time of day and date value to TOD clock format. The leap second offset is not considered when determining the output.

Environment

The requirements for the caller are:

Environmental factor	Requirement
Minimum authorization:	Problem state and any PSW key.
Dispatchable unit mode:	Task or SRB
Cross memory mode:	PASN=HASN=SASN or PASN↔=HASN↔=SASN
AMODE:	24-bit or 31-bit addressing mode
ASC mode:	Primary or access register (AR)
Interrupt status:	Enabled or disabled for I/O and external interrupts
Locks:	No requirement
Control parameters:	Must be in the primary address space or be in an address/data space that is addressable through a public entry on the caller's dispatchable unit access list (DU-AL).

Programming requirements

If the program is in AR mode, issue the SYSSTATE ASCENV=AR macro before STCKCONV. SYSSTATE ASCENV=AR tells the system to generate code appropriate for AR mode.

Restrictions

None.

Input register information

Primary-mode callers must make sure that access register 1 is zero before issuing the execute form of the STCKCONV macro. For other registers, the caller does not have to place any information into any register unless using it in register notation for a particular parameter, or using it as a base register.

Output register information

When control returns to the caller, the general purpose registers (GPRs) contain:

Register Contents

0-1

Used as work registers by the system

2-13

Unchanged

14

Used as a work register by the system

15

Return code

When control returns to the caller, the ARs contain:

Register Contents

0-1

Used as work registers by the system

2-13

Unchanged

14-15

Used as work registers by the system

Some callers depend on register contents remaining the same before and after issuing a service. If the system changes the contents of registers on which the caller depends, the caller must save them before issuing the service, and restore them after the system returns control.

Performance implications

None.

Syntax

The standard form of the STCKCONV macro is written as follows:

Syntax	Description
<i>name</i>	<i>name</i> : Symbol. Begin <i>name</i> in column 1.
␣	One or more blanks must precede STCKCONV.
STCKCONV	
␣	One or more blanks must follow STCKCONV.
STCKVAL= <i>TOD clock addr</i>	<i>TOD clock addr</i> : RX-type address or register (2) - (12).
STCKEVAL= <i>ETOD clock addr</i>	<i>ETOD clock addr</i> : RX-type address or register (2) - (12).

Syntax	Description
,CONVVAL= <i>conv addr</i>	<i>conv addr</i> : RX-type address or register (2) - (12).
,TIMETYPE=DEC ,TIMETYPE=BIN ,TIMETYPE=MIC	Default: TIMETYPE=DEC
,DATETYPE=YYYYDDD ,DATETYPE=DDMMYYYY ,DATETYPE=MMDDYYYY ,DATETYPE=YYYYMMDD	Default: DATETYPE=YYYYDDD

Parameters

The parameters are explained as follows:

STCKVAL=*TOD clock addr*

Specifies the address of an 8-byte storage area containing the 64-bit TOD clock value to be converted.

STCKEVAL=*ETOD clock addr*

Specifies the address of a 16-byte storage area containing the 128-bit ETOD clock value to be converted. Only values with the first byte less than x'02' (that is, values before the end of the second epoch) can be converted successfully.

Only one of STCLVAL or STCKEVAL can be specified.

,CONVVAL=*conv addr*

Specifies the address of a 16-byte storage area where the system returns the converted value in the requested format. The first two words contain the time of day and the third word contains the date. Do not use the contents of the fourth word.

,TIMETYPE=DEC

,TIMETYPE=BIN

,TIMETYPE=MIC

Specifies the format in which the converted time of day is returned, as follows:

DEC

Returns the converted time of day as packed decimal digits (without a sign) of the form HHMMSS t hmj u 0000, where

HH

is hours, based on a 24-hour clock

MM

is minutes

SS

is seconds

t

is tenths of a second

h

is hundredths of a second

m

is milliseconds

STCKCONV macro

- i**
is ten-thousandths of a second
- j**
is hundred-thousandths of a second
- u**
is microseconds

BIN

Returns the converted time of day as an unsigned 32-bit binary number with the low-order bit equivalent to 0.01 second. The second word of the converted time value is zero.

MIC

Returns the converted time of day in microseconds as 8 bytes of information, where bit 51 is equivalent to one microsecond.

,DATETYPE=YYYYDDD

,DATETYPE=DDMMYYYY

,DATETYPE=MMDDYYYY

,DATETYPE=YYYYMMDD

Specifies the format in which the converted date is returned, as follows:

Parameter

Form of returned date

YYYYDDD

YYYYYYYDDD

DDMMYYYY

DDMMYYYY

MMDDYYYY

MMDDYYYY

YYYYMMDD

YYYYMMDD

The date is returned as 4 bytes of packed decimal digits (without a sign), where:

YYYY

is the year

DDD

is the day of the year

DD

is the day of the month

MM

is the month of the year

ABEND codes

None.

Return codes

When STCKCONV macro returns control to your program, GPR 15 contains a return code.

<i>Table 53. Return Codes for the STCKCONV Macro</i>	
Hexadecimal Return Code	Meaning and Action
0	Meaning: Successful completion. Action: None.

Table 53. Return Codes for the STCKCONV Macro (continued)

Hexadecimal Return Code	Meaning and Action
C	Meaning: System error. Action: Retry the request.
10	Meaning: Program error. The user's parameter list is not in addressable storage. Action: Ensure that the parameter list address is valid and the storage is addressable.
14	Meaning: Unsuccessful completion. The ETOD value was not valid. Action: Avoid specifying a date or time that occurs after the second epoch (the corresponding ETOD value would have a value greater than x'01' in the first byte).

Example 1

Convert a TOD clock value to time of day in decimal digits, and date in month-day-year format.

```

          STCKCONV STCKVAL=TODSTAMP, CONVVAL=OUTAREA, TIMETYPE=DEC,          X
                    DATETYPE=MMDDYYYY
TODSTAMP DC X'A0569832F1241000'      TOD CLOCK VALUE
OUTAREA  DS CL16                      CONVERTED VALUE

```

Example 2

Convert a TOD clock value to time of day in hundredths of seconds, and date in year-month-day format.

```

          STCK TODCLOCK
          STCKCONV STCKVAL=TODCLOCK, CONVVAL=OUTVAL, TIMETYPE=BIN,          X
                    DATETYPE=YYYYMMDD
TODCLOCK DS XL8      TOD CLOCK VALUE
OUTVAL   DS CL16    CONVERTED VALUE

```

STCKCONV—List form

Use the list form of the STCKCONV macro together with the execute form of the macro for applications that require reentrant code. The list form of the macro defines an area of storage that the execute form of the macro uses to store the parameters.

Syntax

The list form of the STCKCONV macro is written as follows:

Syntax	Description
<i>name</i>	<i>name</i> : Symbol. Begin <i>name</i> in column 1.
␣	One or more blanks must precede STCKCONV.
STCKCONV	
␣	One or more blanks must follow STCKCONV.

Syntax	Description
MF=L	

Parameter

The parameter is explained as follows:

MF=L

Specifies the list form of the STCKCONV macro. Do not specify any other keywords with MF=L. Precede the STCKCONV list form macro invocation with a name starting in column 1 to label the generated parameter list so you can refer to it.

Example

Establish the correct amount of storage for the STCKCONV parameter list.

```
LIST1    STCKCONV MF=L
```

STCKCONV - Execute form

Use the execute form of the STCKCONV macro together with the list form of the macro for applications that require reentrant code. The execute form of the macro stores the parameters into the storage area defined by the list form.

Syntax

The execute form of the STCKCONV macro is written as follows:

Syntax	Description
<i>name</i>	<i>name</i> : Symbol. Begin <i>name</i> in column 1.
␣	One or more blanks must precede STCKCONV.
STCKCONV	
␣	One or more blanks must follow STCKCONV.
STCKVAL= <i>TOD clock addr</i>	<i>TOD clock addr</i> : RX-type address or register (2) - (12).
STCKEVAL= <i>ETOD clock addr</i>	<i>ETOD clock addr</i> RX-type address or register (2) - (12).
,CONVVAL= <i>conv addr</i>	<i>conv addr</i> : RX-type address or register (2) - (12).

Syntax	Description
,TIMETYPE=DEC ,TIMETYPE=BIN ,TIMETYPE=MIC	Default: TIMETYPE=DEC
,DATETYPE=YYYYDDD ,DATETYPE=DDMMYYYY ,DATETYPE=MMDDYYYY ,DATETYPE=YYYYMMDD	Default: DATETYPE=YYYYDDD
,MF=(E, <i>list addr</i>)	<i>list addr</i> : RX-type address or register (1) - (12).

Parameters

The parameters are explained under the standard form of the STCKCONV macro with the following exception:

,MF=(E,*list addr*)

Specifies the execute form of the STCKCONV macro. *list addr* specifies the address of the parameter list created by the list form of the macro.

Example

Convert a TOD clock value to time of day in microseconds and date in year-day of the year format. Specify the address of the appropriate parameter list in LIST1.

```

          STCKCONV STCKVAL=TODCLOCK, CONVVAL=OUTVAL, TIMETYPE=MIC,      X
                    DATETYPE=YYYYDDD, MF=(E, LIST1)
TODCLOCK  DC X'9FE4781301ABE000'    TOD CLOCK VALUE
OUTVAL    DS CL16                    CONVERTED VALUE

```

Chapter 96. STCKSYNC – Store clock synchronous service

Description

The STCKSYNC macro obtains the time-of-day (TOD) clock contents and indicates whether the TOD clock is synchronized with an external time reference (ETR¹) or with Server Time Protocol (STP).

STCKSYNC is for use by programs that are dependent upon synchronized TOD clocks in a multisystem environment. STCKSYNC also provides an optional parameter, ETRID, that returns the network ID of the ETR source with which the TOD clock is synchronized, and, if applicable, CTNID, that returns the timing mode and the Coordinated Timing Network ID (CTN-ID) of the timing network to which the current processor is synchronized.

The time-of-day clock specified can be either the basic time-of-day clock format (TOD) or the extended time-of-day clock format (ETOD).

- TOD – Unsigned 64-bit binary number
- ETOD – Unsigned 128-bit binary number

See *z/OS MVS Programming: Assembler Services Guide* or *z/Architecture Principles of Operation* for information comparing the formats of the TOD and ETOD.

Environment

The requirements for the caller are:

Environmental factor	Requirement
Minimum authorization:	Problem state and any PSW key
Dispatchable unit mode:	Task or SRB
Cross memory mode:	PASN=HASN=SASN or PASN↔=HASN↔=SASN
AMODE:	31-bit
ASC mode:	Primary or access register (AR)
Interrupt status:	Enabled or disabled for I/O and external interrupts
Locks:	Any locks may be held, no locks required
Control parameters:	Must be in the primary address space or be in an address/data space that is addressable through a public entry on the caller's dispatchable unit access list (DU-AL).

Programming requirements

If the program is in AR mode, issue the SYSSTATE ASCENV=AR macro before STCKSYNC. SYSSTATE ASCENV=AR tells the system to generate code appropriate for AR mode.

Restrictions

None.

¹ External time reference (ETR) is the MVS generic name for the IBM Sysplex Timer.

Input register information

For primary ASC mode callers, GPR 13 must contain the address of a 72-byte save area. For AR mode callers, AR/GPR 13 must contain the address of a 72-byte save area.

Output register information

When control returns to the caller, the general purpose registers (GPRs) contain:

Register Contents

0-1

Used as work registers by the system

2-13

Unchanged

14

Used as a work register by the system

15

Return code

When control returns to the caller, the ARs contain:

Register Contents

0-1

Used as work registers by the system

2-13

Unchanged

14-15

Used as work registers by the system

Some callers depend on register contents remaining the same before and after issuing a service. If the system changes the contents of registers on which the caller depends, the caller must save them before issuing the service, and restore them after the system returns control.

Performance implications

None.

Syntax

The STCKSYNC macro is written as follows:

Syntax	Description
<i>name</i>	<i>name</i> : Symbol. Begin <i>name</i> in column 1.
␣	One or more blanks must precede STCKSYNC.
STCKSYNC	
␣	One or more blanks must follow STCKSYNC.

Syntax	Description
TOD= <i>TOD clock addr</i>	<i>TOD clock addr</i> : RX-type address
ETOD= <i>ETOD clock addr</i>	<i>ETOD clock addr</i> : RX-type address
,ETRID= <i>ETR-id addr</i>	<i>ETR-id addr</i> : RX-type address
,CTNID= <i>CTN-id addr</i>	<i>CTN-id addr</i> : RX-type address: RX-type address

Parameters

The parameters are explained as follows:

TOD=*TOD clock addr*

Specifies the address of a doubleword that receives the TOD clock value.

ETOD=*ETOD clock addr*

Specifies the address of a 16-byte area, aligned on a double-word boundary, that receives the extended TOD clock value (ETOD).

Only one of either TOD or ETOD can be specified.

,ETRID=*ETR-id addr*

Specifies the address of a byte that receives the ETR network ID of the ETR with which the TOD clock is synchronized. No ETRID value is returned if the TOD clock is not synchronized with an ETR.

,CTNID=*CTN-id addr*

Specifies the address of a 16-byte area that contains the timing mode and the CTN-ID of the timing network to which the current CEC is synchronized. The CTN-ID is the first 12 bytes and the timing mode is the last byte (15) of this area. If the clock is synchronized to a CTN, the timing mode is either in ETR timing mode (X'80') or STP timing mode (X'40'). If the clock is not synchronized to a CTN, the mode is local (X'00'). The CTN-ID consists of two parts, the STP-ID which is 8 characters in bytes 0 - 7 and the ETR-ID which is a hexadecimal integer value in byte 11 of the returned area. A value of X'FF' in byte 11 should be ignored. Bytes 12 to 14 are not used and will be zeros.

Only one of either TOD or ETOD can be specified.

ABEND codes

None.

Return codes

Return codes from the STCKSYNC macro are returned as hexadecimal values in register 15, as follows:

<i>Table 54. Return Codes for the STCKSYNC Macro</i>	
Hexadecimal Return Code	Meaning and Action
0	<p>Meaning: The TOD clock is synchronized with an ETR or a CTN, or a simulated ETR was requested (through SYS1.PARMLIB member CLOCKxx). If ETRID was specified, the ID of the ETR is returned at <i>id addr</i>.</p> <p>Action: None.</p>

Table 54. Return Codes for the STCKSYNC Macro (continued)

Hexadecimal Return Code	Meaning and Action
4	<p>Meaning: The TOD clock is not synchronized with an ETR or a CTN.</p> <p>Action: None required. However, you might take some action based upon your application.</p>
8	<p>Meaning: System error. The TOD clock is unusable.</p> <p>Action: Reissue the request until it succeeds.</p>
C	<p>Meaning: System error. Timer in the middle of a timing Mode Switch. No data is returned.</p> <p>Action: Reissue the request.</p>

Example 1

Obtain the TOD clock contents and an indication of whether the TOD clock is synchronized with an ETR.

```
TODAREA    STCKSYNC TOD=TODAREA
            DS XL8                TOD CLOCK CONTENTS
```

Example 2

For a caller in AR mode, obtain the TOD clock contents, an indication of whether the TOD clock is synchronized with an ETR, and the network ID of the ETR source with which the TOD clock is synchronized.

```
            SYSSTATE ASCENV=AR
            .
            .
            .
            STCKSYNC TOD=TODAREA,ETRID=IDAREA
TODAREA    DS XL8                TOD CLOCK CONTENTS
IDAREA     DS XL1                ETR NET ID
```

Chapter 97. STIMER – Set interval timer

Description

The STIMER macro sets a timer to a specified time interval or to an interval that will expire at a specified time of day. An optional asynchronous timer completion exit is given control when the time interval expires; if no asynchronous timer completion routine is specified, no indication that the time interval has expired is provided. A second STIMER macro issued before the first time interval expires overrides the first interval and exit routine.

The time interval may be a ‘real-time interval’ (measured continuously in real time by the clock comparator), or a ‘task-time interval’ (measured, only while the task is in execution, by the CPU timer). See *Principles of Operation* for information on the clock comparator and CPU timer. If a real-time interval is specified, the task may elect to either continue (REAL) or suspend (WAIT) execution during the interval. If the task elects to continue execution, it may optionally specify an exit routine to be given control on completion of the time interval. If the task elects to suspend execution, it is restarted at the next sequential instruction, sometime after completion of the time interval. If a task-time interval is specified, the task must continue. It may optionally specify an exit routine to be given control on completion of the interval.

STIMER allows you to set one time interval for one task; STIMERM allows you to set 16 separate time intervals for a task. Using the two macros together allows you to set 17 separate intervals for a task.

For information on how to select an MVS/SP version other than the current version, see [Compatibility of MVS macros](#). If your program is to execute in 31-bit addressing mode, you must use the SP Version 2 expansion of this macro or a later version.

Environment

The requirements for the caller are:

Environmental factor	Requirement
Minimum authorization:	Problem state and any PSW key.
Dispatchable unit mode:	Task
Cross memory mode:	PASN=HASN=SASN
AMODE:	24- or 31- or 64-bit
ASC mode:	Primary
Interrupt status:	Enabled for I/O and external interrupts
Locks:	No locks held
Control parameters:	Must be in the primary address space.

Programming requirements

The timer completion exit routine must be in virtual storage when it is required.

Restrictions

The following restrictions apply to the STIMER macro:

- Only one STIMER invocation can be active at a time. Ensure that any processing your program performs after issuing the STIMER macro does not also invoke the STIMER macro. For concurrent requests, use the STIMERM macro.

STIMER macro

- Do not issue the STIMER macro before invoking dynamic allocation. Use STIMERM instead.
- For REAL or WAIT requests:
 - If you specify a time of day at which the interval will expire (GMT (Greenwich Mean Time), LT (local time), or TOD (Time of Day) parameters), the time of day you specify must not exceed 24:00:00:00; otherwise, your program receives a X'12F' abend.
 - If you specify a time interval on the MICVL parameter, the interval you specify, when added to the current TOD clock contents, must not exceed the maximum value for the clock comparator (X'FFFFFFFFFFFFFFFF'); otherwise, your program receives a X'12F' abend.
- For TASK requests, the time interval you specify on MICVL must not exceed the maximum positive value for the CPU timer (X'7FFFFFFFFFFFFFFF'); otherwise, your program receives a X'12F' abend.
- You can issue STIMER REAL with a timer completion exit routine, and within that routine, you can issue STIMER REAL and specify the same timer completion exit routine. Under these circumstances, IBM recommends that you specify a time interval rather than a time of day on the STIMER you issue within the timer completion exit routine. If you specify a time of day, it is possible for the timer completion exit routine to receive control later than the time of day you specified, resulting in an infinite loop.
- The caller can have no enabled, unlocked task (EUT) FRRs established.
- The time interval you specify on the BINTVL parameter must not exceed X'7FFFFFFF'. If the time interval exceeds X'7FFFFFFF', your program receives a X'12F' abend.
- If you make use of JES2 main task exit routines or have vendor code that could run under the JES2 main task, then this code *cannot* use the STIMER macro. Such use would usurp the timer JES2 sets with its use of the STIMER macro. The exit or vendor code would destroy JES2 processing and lead to unpredictable errors. STIMERM is the macro this code must use instead.

Input register information

Before issuing the STIMER macro, the caller does not have to place any information into any register unless using it in register notation for a particular parameter, or using it as a base register.

Output register information

When control returns to the caller, the registers contain:

Register Contents

0-1
Used as work registers by the system

2-13
Unchanged

14
Used as a work register by the system

15
0 (zero)

When control returns to the caller, the access registers (ARs) contain:

Register Contents

0-1
Used as work registers by the system

2-13
Unchanged

14-15
Used as work registers by the system

Some callers depend on register contents remaining the same before and after issuing a service. If the system changes the contents of registers on which the caller depends, the caller must save them before issuing the service, and restore them after the system returns control.

Performance implications

None.

Syntax

The STIMER macro is written as follows:

Syntax	Description
<i>name</i>	<i>name</i> : Symbol. Begin <i>name</i> in column 1.
␣	One or more blanks must precede STIMER.
STIMER	
␣	One or more blanks must follow STIMER.
REAL REAL, <i>exit rtn addr</i> TASK TASK, <i>exit rtn addr</i> WAIT	<i>exit rtn addr</i> : RX-type address, or register (0) or (2) - (12).
,BINTVL= <i>stor addr</i> ,DINTVL= <i>stor addr</i> ,MICVL= <i>stor addr</i> ,GMT= <i>stor addr</i> ,TUINTVL= <i>stor addr</i> ,TOD= <i>stor addr</i> ,LT= <i>stor addr</i>	<i>stor addr</i> : RX-type address, or register (1) or (2) - (12). Note: The GMT, TOD, and LT parameters must not be specified with TASK above.

Note: The ERRET parameter is obsolete and is ignored by the system. Therefore, the syntax and parameter descriptions for STIMER no longer contain ERRET. However, the system still accepts ERRET, and it is not necessary to delete it from existing code.

Parameters

The parameters are explained as follows:

REAL**REAL,exit rtn addr****TASK****TASK,exit rtn addr****WAIT**

Specifies whether the timer interval is a real-time interval (REAL or WAIT) or a task-time interval (TASK). You must specify one of these parameters.

For REAL, the interval is decreased continuously. If the TOD, GMT, or LT parameter is coded, the interval expires at the indicated time of day.

For TASK, the interval is decreased only when the associated task is running.

For WAIT, the interval is decreased continuously. The task is to be placed in the wait condition until the interval expires.

The *exit rtn addr* is the address of the timer completion exit routine to be given control after the specified time interval expires. The routine does not get control immediately when the interval completes, but at some time after the interval completes, depending on the system's work load and the relative dispatching priority of the associated task. The routine must be in virtual storage when it is required. The exit routine receives control in the same environment that the caller had when the caller issued the STIMER macro. The contents of the registers when the exit routine is given control are as follows:

**Register
Contents**

0-12

Do not contain any information for use by the routine.

13

Address of a system-provided, 72-byte save area.

14

Return address (to the system).

15

Address of the exit routine.

The exit routine is responsible for saving and restoring registers. The exit routine runs as a subroutine, and must return control to the address identified in register 14. Although timing services allows only one active time interval for a task, it does not serialize the use of an asynchronous timer completion exit routine.

,BINTVL=stor addr**,DINTVL=stor addr****,GMT=stor addr****,MICVL=stor addr****,TOD=stor addr****,TUINTVL=stor addr****,LT=stor addr**

Specifies the storage address and format for the time of day, or time interval, to be set. You must specify one of these parameters.

For BINTVL, the address is a 4-byte area containing the time interval. The time interval is represented as an unsigned 32-bit binary number; however, the high-order bit of the time interval must not be set. Therefore, the time interval specified cannot exceed X'7FFFFFFF'. The low-order bit of the time interval has a value of 0.01 second.

For DINTVL, the address is a doubleword in virtual storage containing the time interval. The time interval is presented as zoned decimal digits of the form:

HHMMSSth, where:

HH

is hours (24-hour clock)

MM

is minutes

SS

is seconds

t

is tenths of seconds

h

is hundredths of seconds

For GMT, the address is an 8-byte area containing the Greenwich mean time at which the interval is to be completed. The time is presented as zoned decimal digits of the form HHMMSSth, as described above under DINTVL.

For MICVL, the address is a doubleword containing the time interval. The time interval is represented as an unsigned 64-bit binary number; bit 51 is the low-order bit of the interval value and equivalent to 1 microsecond.

For TUINTVL, the address is a fullword containing the time interval. The time interval is presented as an unsigned 32-bit binary number; the low-order bit has a value of one timer unit (approximately 26.04166 microseconds).

For TOD and LT, the address is a doubleword containing the local time of day at which the interval is to be completed. The time is presented as zoned decimal digits of the form HHMMSSth, as described under DINTVL.

The LT and TOD parameters perform identical functions. However, the name for the LT parameter (LT, or local time) describes the function more accurately than does the name for the TOD parameter (TOD, or time-of-day). Therefore, for clarity purposes, IBM recommends the use of the LT parameter instead of TOD.

Note: For the DINTVL, GMT, TOD, and LT parameters, the zoned decimal digits are not checked for validity. Thus, the specification of incorrect digits can result in an X'0C7' abend, or a time interval different from that desired.

Note:

1. The time interval specified by an STIMER macro has no relation to the time interval specified in an EXEC statement.
2. If no exit routine address is specified, there is no indication of completion except when WAIT is specified.
3. The TTIMER and CPUTIMER macros provide a facility for determining the remaining time interval associated with STIMER.

The priorities of other tasks in the system can also affect the accuracy of the time interval measurement. If you code REAL or WAIT, the interval is decreased continuously and can expire when the task is not active. After the time interval expires, assuming the task is not in the wait condition for any other reasons, the task is placed in the ready condition and competes for control with the other ready tasks in the system. The additional time required before the task becomes active depends on the relative dispatching priority of the task.

ABEND codes

STIMER might abnormally terminate with one the following abend codes: X'12F' (with reason code X'0', X'4', X'C', X'10', X'14', X'28'), or X'AC7' (with reason code X'2'). See [z/OS MVS System Codes](#) for an explanation and response for these codes.

Return and reason codes

STIMER returns a return code of 0 in register 15.

Examples

Example 1: Request the installation's asynchronous exit routine, located at location EXIT, to receive control after fourteen hundredths of a second (specified by INTVLONG) have elapsed in real time.

```

      STIMER   REAL,EXIT,BINTVL=INTVLONG
      :
INTVLONG DC F '14'      TIME INTERVAL

```

Example 2: Request that this task's exit routine, located at location EXIT, receive control when the local time of day specified at location LOCAL occurs.

```

      STIMER   REAL,EXIT,LT=LOCAL
      :
LOCAL      DS      2F

```

Example 3: Request that this task be put into a wait state until 60 seconds have passed.

```

      STIMER   WAIT,BINTVL=INTV2
      :
INTV2      DC   F'6000'

```

Example 4: Request that this task's exit routine, located at location EXIT, receive control when the task has executed 60 seconds.

```

      STIMER   TASK,EXIT,BINTVL=INTV1
      :
INTV1      DC   F'6000'

```

Chapter 98. STIMERM – Set, test, cancel multiple interval timer

Description

The STIMERM macro:

- Sets a timer to a specified time interval (SET parameter)
- Tests the remaining time interval for a timer request (TEST parameter)
- Cancels a specific timer request (CANCEL parameter)

The SET request sets a timer to a specified time interval or to an interval that will expire at a specified time of day.

- A program that is problem state and key 8-15 may not set an STIMERM, if there are currently 16 or more requests in effect for the issuing task.
- A program that is supervisor state or key 0-7 may not set an STIMERM, if there are currently 128 requests in effect for the issuing task.

The time interval is a real-time interval, measured continuously. The task can continue (WAIT=NO) or suspend execution (WAIT=YES). If the task continues execution, it can pass control to an exit routine (EXIT parameter) when the time interval is complete. If you specify an exit routine, the task can optionally pass a parameter to the exit routine (PARM parameter). The task grants control to the optional asynchronous timer completion exit when the time interval expires. If the task did not specify either an asynchronous timer completion routine or WAIT=YES, the task receives no indication that the time interval has expired.

The TEST request tests the remaining time interval for a timer request established through the SET parameter. The ID parameter identifies the particular timer request to be tested and must be established by the current task.

The CANCEL request cancels a specific timer request or all of the current task's timer requests that were established through the SET parameter. The ID parameter identifies the timer request or requests of the current task to be cancelled. If the macro cancels a specific timer request, it may return the remaining time interval for that request to a storage area designated by the TU (Timer Units) or MIC (Microseconds) parameters.

On the TEST and CANCEL requests, the TU and MIC parameters specify the location where the system returns the remaining time:

- If you specify TU, the STIMERM macro returns the amount of time remaining to the designated 4-byte storage area as an unsigned 32-bit binary number containing the number of timer units (approximately 26.04166 microseconds per unit) remaining in the interval.
- If you specify MIC, the STIMERM macro returns the remaining time to the designated 8-byte storage area. Bit 51 of the area is the low-order bit of the interval value and is equivalent to approximately one microsecond.

If the specified timer request does not exist for the current task, or if the timer request exists but has expired, the system sets to zero the storage area designated by TU or MIC.

When you cancel a timer request that specified a timer exit, specify TU or MIC to determine whether the cancel operation was successful:

- If STIMERM returned a value of zero to the storage area designated by TU or MIC, then any associated timer exit has run or will run because its interval expired before the cancel operation completed.
- If STIMERM returned a non-zero value to the storage area designated by TU or MIC, then the timer interval was cancelled and any associated timer exit will not run.

It is your responsibility to set up your program to determine whether the timer exit has run. For information about interval timing, see [z/OS MVS Programming: Assembler Services Guide](#).

Environment

The requirements for the caller are:

Environmental factor	Requirement
Minimum authorization:	Problem state and any PSW key.
Dispatchable unit mode:	Task
Cross memory mode:	PASN=HASN=SASN
AMODE:	24- or 31- or 64-bit
ASC mode:	Primary
Interrupt status:	Enabled for I/O or external interrupts
Locks:	No locks held.
Control parameters:	Must be in the primary address space.

Programming requirements

- All input and output addresses are treated as full 31-bit addresses.
- The parameter lists may be above or below 16 megabytes.
- There is no interaction between the TTIMER macro support and the STIMERM macro support or between the STIMER macro support and the STIMERM macro support.
- If the STIMERM macro service cannot access the macro parameter list or any in-storage parameters, the system abnormally ends the calling program whether or not it specified an ERRET routine.

Restrictions

No enabled, unlocked task (EUT) FRRs may be established.

For SET requests:

- If you specify a time of day at which the interval will expire (GMT, LT, or TOD parameters), the time of day you specify must not exceed 24:00:00.00; otherwise, you receive a X'32E' abend unless you specify ERRET.
- If you specify a time interval on the MICVL parameter, the interval you specify, when added to the current TOD clock contents, must not exceed the maximum value for the clock comparator (X'FFFFFFFFFFFFFFFF'); otherwise, you receive a X'32E' abend unless you specify ERRET.
- The time interval specified by a STIMERM macro has no relation to the time interval specified in an EXEC statement.
- You can issue STIMERM with a timer completion exit routine and, within that routine, you can issue STIMERM and specify the same timer completion exit routine. Under these circumstances, IBM recommends that you specify a time interval rather than a time of day on the STIMERM you issue within the timer completion exit routine. If you specify a time of day, it is possible for the timer completion exit routine to receive control later than the time of day you specified, resulting in an infinite loop.
- The time interval you specify on the BINTVL parameter must not exceed X'7FFFFFFF'. If the time interval exceeds X'7FFFFFFF', your program receives a X'32E' abend unless you use the ERRET parameter to specify a recovery routine.
- No enabled, unlocked task (EUT) FRRs can be established.

TEST and CANCEL requests have no restrictions.

Input register information

Before issuing the STIMERM macro, the caller does not have to place any information into any register unless using it in register notation for a particular parameter or using it as a base register.

Output register information

When control returns to the caller, the general purpose registers contain:

Register Contents

0-1

Used as work registers by the system

2-13

Unchanged

14

Used as a work register by the system

15

Return code

When control returns to the caller, the access registers (ARs) contain:

Register Contents

0-1

Used as work registers by the system

2-13

Unchanged

14-15

Used as work registers by the system

Some callers depend on register contents remaining the same before and after issuing a service. If the system changes the contents of registers on which the caller depends, the caller must save them before issuing the service and restore them after the system returns control.

Performance implications

Syntax

The standard form of the STIMERM macro is written as follows:

Syntax	Description
<i>name</i>	<i>name</i> : Symbol. Begin <i>name</i> in column 1.
␣	One or more blanks must precede STIMERM.
STIMERM	
␣	One or more blanks must follow STIMERM.

Syntax	Description
	Valid parameters (Required parameters are underlined)
SET	For SET: <u>ID</u> , <u>BINTVL</u> or <u>DINTVL</u> or <u>GMT</u> or <u>MICVL</u> or <u>TOD</u>
TEST	or <u>TU</u> <u>INTVL</u> or <u>LT</u> , ERRET, WAIT, EXIT, PARM, RELATED
CANCEL	For TEST: <u>ID</u> , <u>TU</u> or <u>MIC</u> , ERRET, RELATED
	For CANCEL: <u>ID</u> , TU or MIC, ERRET, RELATED
,ID= <i>stor addr</i>	<i>stor addr</i> : RX-type address or register (2) - (12).
,ID=ALL	Note: ID=ALL is only valid on the CANCEL request.
,TU= <i>stor addr</i>	<i>stor addr</i> : RX-type address or register (2) - (12).
,MIC= <i>stor addr</i>	
,BINTVL= <i>stor addr</i> ,DINTVL= <i>stor addr</i> ,MICVL= <i>stor addr</i> ,GMT= <i>stor addr</i> ,TUINTVL= <i>stor addr</i> ,TOD= <i>stor addr</i> ,LT= <i>stor addr</i>	<i>stor addr</i> : RX-type address or register (2) - (12).
,ERRET= <i>err rtn addr</i>	<i>err rtn addr</i> : RX-type address or register (2) - (12).
,EXIT= <i>exit rtn addr</i>	<i>exit rtn addr</i> : RX-type address or register (2) - (12).
	Note: EXIT must not be specified if WAIT=YES is specified.
,PARM= <i>stor addr</i>	<i>stor addr</i> : RX-type address or register (2) - (12).
	Note: If PARM is specified, EXIT must be specified and WAIT=YES must not be specified.
,WAIT=YES ,WAIT=NO	Default: WAIT=NO
,RELATED= <i>value</i>	

Parameters

The parameters are explained as follows:

SET
TEST
CANCEL

Request to establish, return, or cancel a real-time interval. You must specify one of these parameters.

SET indicates a request to establish a real-time interval.

TEST indicates a request to return the remaining time for a request made using the SET parameter.

CANCEL indicates a request to cancel and optionally return the remaining time for a timer request.

If the CANCEL parameter specifies (through ID=) a timer request that was established with the WAIT=YES parameter, the task will still remain in the wait condition.

,ID=stor addr

,ID=ALL

Specifies the address of a 4-byte area containing the identifier assigned to a particular timer request by the timer service routine. When you specify STIMERM SET, the ID is returned in the 4-byte area. Specify this ID on STIMERM TEST or STIMERM CANCEL. ID=ALL, valid only on STIMERM CANCEL, cancels all the current task's timer requests as established by STIMERM SET. If you specify ID=ALL, the system does not return a remaining time interval. Do not specify MIC or TU with ID=ALL.

,TU=stor addr

,MIC=stor addr

Specifies that the remaining time in the interval be returned to the 4-byte or 8-byte area specified in *stor addr*. TU or MIC is required for STIMERM TEST and is optional for STIMERM CANCEL (providing you do not also specify ID=ALL). TU and MIC are mutually exclusive.

For TU, the time is returned to the specified 4-byte area as an unsigned 32-bit binary number. The low-order bit is approximately 26.04166 microseconds (one timer unit). If the time remaining is too great to be expressed in 4 bytes, the remaining time interval is set to the maximum possible value (X'FFFFFFFF') and the return code is set to 4.

For MIC, the time is returned to the specified 8-byte area as microseconds. The 8-byte area stores the remaining interval, which is represented as an unsigned 64-bit binary number; bit 51 is equivalent to one microsecond.

,BINTVL=stor addr

,DINTVL=stor addr

,GMT=stor addr

,MICVL=stor addr

,TUINTVL=stor addr

,TOD=stor addr

,LT=stor addr

Specifies the storage address and format of the time of day, or time interval, to be set. You must specify one of these parameters.

For BINTVL, the address is a 4-byte area containing the time interval. The time interval is represented as an unsigned 32-bit binary number; however, the high-order bit of the time interval must not be set. Therefore, the time interval specified cannot exceed X'7FFFFFFF'. The low-order bit of the time interval has a value of 0.01 second.

For DINTVL, the address is an 8-byte area in virtual storage containing the time interval. The time interval is represented as zoned decimal digits of the form:

HHMMSSth, where:

HH

is hours

MM

is minutes

SS

is seconds

t

is tenths of seconds

h

is hundredths of seconds

For GMT, the address is an 8-byte area containing the Greenwich mean time at which the interval will complete. The time is represented as zoned decimal digits of the form HHMMSSth, as described previously under DINTVL.

For MICVL, the address is an 8-byte storage area containing the time interval. The time interval is represented as an unsigned 64-bit binary number; bit 51 is the low-order bit of the interval value and equivalent to one microsecond.

For TUINTVL, the address is a 4-byte area containing the time interval. The time interval is represented as an unsigned 32-bit binary number; the low-order bit has a value of one timer unit (approximately 26.04166 microseconds).

For TOD and LT, the address is an 8-byte storage area containing the local time of day at which the interval is to be completed. The time of day is represented as zoned decimal digits of the form HHMMSSth, as described previously under DINTVL.

The LT and TOD parameters perform identical functions. However, the name for the LT parameter (LT or local time) describes the function more accurately than does the name for the TOD parameter (TOD or time-of-day). Therefore, for clarity purposes, **IBM recommends** the use of the LT parameter instead of TOD.

Notes on setting the time interval: For the DINTVL, GMT, TOD, and LT parameters, the zoned decimal digits are not checked for validity. Thus, specifying invalid digits can cause a X'0C7' abend or an undesired time interval.

,ERRET=err rtn addr

Specifies the address of the routine to receive control when the STIMERM function cannot be performed. If you omit this parameter and your program encounters an error, the system abnormally ends your program. The specified error routine will be entered in the addressing mode and environment of the STIMERM invoker.

When the routine receives control, the register contents are:

Register**Contents****0**

Address of a 24-byte STIMERM parameter list.

1

Does not contain any information for use by the routine.

2-13

The contents are the same as they were when the caller issued STIMERM.

14

Return address.

15

Return code.

If the macro parameter list or any in-storage parameters are not accessible, the system abnormally ends your program regardless of whether or not you specified ERRET. No error routine will receive control.

,EXIT=exit rtn addr

Specifies the address of an exit routine that will gain asynchronous control after the requested timer interval expires. The system's workload and the relative dispatching priority of the associated task determine exactly when, after the interval completes, the exit routine gets control. The specified exit routine will be entered in the environment of the STIMERM invoker. It will be entered in AMODE 24 if the STIMERM invoker was AMODE 24, AMODE 31 if the STIMERM invoker was AMODE 31, and AMODE

64 if the STIMERM invoker was AMODE 64. If you specify WAIT=YES, you must *not* specify the EXIT parameter.

Exit Routine Interface: The timer exit routine, established with the EXIT parameter in the STIMERM macro, receives control with the following register values:

R0 -

Does not contain any information for use by the routine

R1 -

Points to an 8-byte fetch-protected storage area below 16 megabytes and in the protect key of the program that issued the STIMERM SET macro

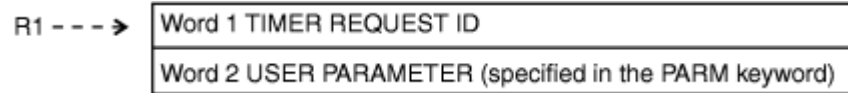

R2-R12 -

Do not contain any information for use by the routine

R13 -

Address of a 72-byte save area provided by the system

R14 -

Return address (to the system)

R15 -

Address of the exit routine

The exit routine receives control in the addressing mode of the STIMERM issuer. If multiple asynchronous exits are established, the exit routines may not receive control in the same order that the intervals expire.

,PARM=stor addr

Specifies the address of a 4-byte parameter that the exit routine receives when the requested timer interval expires. You must *not* specify PARM=stor addr if you specified WAIT=YES. If you specify PARM=stor addr, you must also specify EXIT=exit rtn addr.

An exit routine will be unable to distinguish between the case where PARM= was not specified and the case where the specified PARM value was zero.

,WAIT=YES

,WAIT=NO

Specifies whether the task should be suspended until the requested time interval expires. WAIT=YES specifies that the task should be suspended until the requested time interval expires. If you specify WAIT=NO without specifying EXIT, you will receive no indication when the timer expires. WAIT=NO is the default.

,RELATED=value

Specifies information used to self-document macros by “relating” functions or services to corresponding functions or services. The format and contents of the specified information are at your discretion and may be any valid macro keyword expression.

ABEND codes

On STIMERM SET requests:

- X'32E'

Abend code X'32E' might yield the following reason codes:

- X'10C'
- X'110'
- X'11C'
- X'120'
- X'128'

STIMERM macro

- X'AC7'

Abend code X'AC7' might yield the following reason code:

- X'2'

On STIMERM TEST requests:

- X'32E'

Abend code X'32E' might yield the following reason codes:

- X'210'
- X'220'
- X'224'

On STIMERM CANCEL requests:

- X'32E'

Abend code X'32E' might yield the following reason codes:

- X'310'
- X'320'
- X'324'

See [z/OS MVS System Codes](#) for explanations and programmer responses for these codes.

Return codes

When control is returned, register 15 contains one of the following hexadecimal return codes. Note that for non-zero return codes, the ERRET routine receives control (if you specified ERRET). If you did not specify ERRET, a non-zero return code causes the STIMERM invoker to end abnormally.

Hexadecimal Return Code	Meaning and Action
00	Meaning: The STIMERM service has completed successfully. Action: None.
04	Meaning: For TEST and CANCEL requests, the time remaining is too great to be expressed in 4 bytes. The maximum value (X'FFFFFFFF') is returned. Action: None required. However, you might take some action based upon your application.
0C	Meaning: Program error. For SET requests, the GMT, LT, or TOD at which the interval is to complete exceeds 24:00:00.00. Action: Specify a time of day value that is less than or equal to 2400 hours.
10	Meaning: Program error. Parameters passed to STIMERM are not valid. Action: Ensure that all input parameters are valid.
1C	Meaning: Program error. The request would cause the limit of concurrent STIMERM SET requests for a task to be exceeded. Action: Change your application logic so that fewer STIMERM requests are required.

Table 55. Return Codes for the STIMERM Macro (continued)

Hexadecimal Return Code	Meaning and Action
24	<p>Meaning: Program error. The specified STIMERM ID number was zero, which is not valid.</p> <p>Action: Ensure that the input ID is a valid value.</p>
28	<p>Meaning: Program error. For SET requests, either you specified a time interval on the MICVL parameter that, when added to the current TOD clock contents, exceeds the maximum value for the clock comparator (X'FFFFFFFFFFFFFFFF') or you specified a value greater than X'7FFFFFFF' for BINTVL.</p> <p>Action: Request a smaller time interval.</p>

Example 1

SET a timer to a specified time interval. Specify:

- The address of a 4-byte area in which the identifier assigned by the timer service to this request will be returned
- That control should be given to an asynchronous timer completion exit named TIME, when the time interval expires
- The address of a 4-byte area (containing the time interval of 32 hundredths of seconds) named INTERVAL. Include an error exit routine named ERROR.

```

STIMERM SET, ID=ADDRESS, BINTVL=INTERVAL, EXIT=TIME, ERRET=ERROR
ADDRESS DS F ID RETURNED
INTERVAL DC X'00000020' TIME INTERVAL

```

Example 2

SET a timer to a time interval that specifies the address of a 4-byte area in which the identifier assigned by timer service will be returned. Specify the address of an 8-byte area named INTERVAL that contains the Greenwich mean time at which the interval is to be completed (2:06 PM). Specify that the task should be suspended until the requested time interval expires. Include an error exit routine named EXITX.

```

STIMERM SET, ID=ADDRESS, GMT=INTERVAL, WAIT=YES, ERRET=EXITX
ADDRESS DS F ID RETURNED
INTERVAL DC X'F1F4F0F6F0F0F0' EXPIRATION TIME OF DAY

```

Example 3

SET a timer to a time interval that specifies the address of a 4-byte area in which the identifier assigned by timer service will be returned. Specify the address of an 8-byte area in register 8 that contains the time interval (represented as zoned decimal digits). Specify, in register 10, the address of the exit routine that will gain control asynchronously when the requested time interval expires. Specify the address of a 4-byte parameter to be passed to the exit routine when the requested time interval expires. Include the address of an exit error routine in register 9.

```

STIMERM SET, ID=(7), DINTVL=(8), PARM=USERDATA, ERRET=(9), EXIT=(10)
USERDATA DC CL4'ABCD' PARAMETER PASSED TO EXIT ROUTINE

```

Example 4

Test the remaining time interval for a timer request established with the SET parameter, specifying (in register 4) the address of a 4-byte area from which the identifier assigned by the timer service will be

STIMERM macro

obtained. Specify that the time be returned as an unsigned 32-bit binary number in a 4-byte area called INTERVAL. Include the address of an exit error routine called XYZ.

```
STIMERM TEST, ID=(4), TU=INTERVAL, ERRET=XYZ
INTERVAL DS XL4    REMAINING TIME
```

Example 5

Test the remaining time interval for a timer request established with the SET parameter, specifying the address of a 4-byte area from which the identifier assigned by the timer service will be obtained. Specify that the time be returned in microseconds in an 8-byte area called INTERVAL. Include the address of an exit error routine called ERRORADD.

```
STIMERM TEST, ID=ADDR, MIC=INTERVAL, ERRET=ERRORADD
ADDR      DS F      ID TO BE TESTED
INTERVAL  DS XL8    REMAINING TIME
```

Example 6

Cancel a timer request established with a SET parameter, specifying the address of a 4-byte area named ADDRESS containing the identifier assigned by the timer service. The time interval remaining should be returned as an unsigned 32-bit binary number in a 4-byte area called INTERVAL. An exit error routine named ERROR is also specified.

```
STIMERM CANCEL, ID=ADDRESS, TU=INTERVAL, ERRET=ERROR
ADDRESS   DS F      ID TO BE CANCELLED
INTERVAL  DS XL4    REMAINING TIME
```

Example 7

Cancel a timer request established with a SET parameter, specifying the address of a 4-byte area named PLACE containing the identifier assigned by the timer service. The time interval remaining should be returned in an 8-byte area called INTERVAL. An exit error routine named EXITA is also specified.

```
STIMERM CANCEL, ID=PLACE, MIC=INTERVAL, ERRET=EXITA
PLACE     DS F      ID TO BE CANCELLED
INTERVAL  DS XL8    REMAINING TIME
```

Example 8

Cancel all the timer requests established with STIMERM SET for the current task.

```
STIMERM CANCEL, ID=ALL
```

STIMERM—List form

Use the list form of the STIMERM macro together with the execute form of the macro for applications that require reentrant code. The list form of the macro defines an area of storage, which the execute form of the macro uses to store the parameters.

Syntax

The list form of the STIMERM macro is written as follows:

Syntax	Description
<i>name</i>	<i>name</i> : Symbol. Begin <i>name</i> in column 1.

Syntax	Description
␣	One or more blanks must precede STIMERM.
STIMERM	
␣	One or more blanks must follow STIMERM.
SET	
TEST	
CANCEL	
,MF=L	
,RELATED= <i>value</i>	

Parameters

The parameters are explained as follows:

,MF=L

Specifies the list form of the STIMERM macro. If you do not specify MF=L, the standard form of the macro is expanded. If you do specify MF=L, the only keyword allowed is RELATED.

Example 1

Establish a remote STIMERM SET parameter list.

```
REMOTE STIMERM SET ,MF=L
```

Example 2

Establish a remote STIMERM TEST or CANCEL parameter list.

```
STIMERM TEST ,MF=L
```

Example 3

Establish the appropriate storage for the execute form of the STIMERM CANCEL macro.

```
STIMERM CANCEL ,MF=L
```

STIMERM - Execute form

Use the execute form of the STIMERM macro together with the list form of the macro for applications that require reentrant code. The execute form of the macro stores the parameters into the storage area defined by the list form.

Syntax

The execute form of the STIMERM macro is written as follows:

Syntax	Description
<i>name</i>	<i>name</i> : Symbol. Begin <i>name</i> in column 1.
b	One or more blanks must precede STIMERM.
STIMERM	
b	One or more blanks must follow STIMERM.
	Valid parameters (Required parameters are underlined)
SET	For SET: <u>ID</u> , <u>BINTVL</u> or <u>DINTVL</u> or <u>GMT</u> or <u>MICVL</u> or <u>TOD</u>
TEST	or <u>TUINTVL</u> or <u>LT</u> , ERRET, WAIT, EXIT, PARM, RELATED
CANCEL	For TEST: <u>ID</u> , <u>TU</u> or <u>MIC</u> , ERRET, RELATED
	For CANCEL: <u>ID</u> , TU or MIC, ERRET, RELATED
,ID= <i>stor addr</i>	<i>stor addr</i> : A-type address or register (2) - (12).
,ID=ALL	Note: ID=ALL is valid only on the CANCEL request.
,TU= <i>stor addr</i> ,MIC= <i>stor addr</i>	<i>stor addr</i> : A-type address or register (2) - (12).
,BINTVL= <i>stor addr</i> ,DINTVL= <i>stor addr</i> ,GMT= <i>stor addr</i> ,MICVL= <i>stor addr</i> ,TOD= <i>stor addr</i> ,TUINTVL= <i>stor addr</i> ,LT= <i>stor addr</i>	<i>stor addr</i> : A-type address or register (2) - (12).
,ERRET= <i>err rtn addr</i>	<i>err rtn addr</i> : A-type address or register (2) - (12).
,WAIT=YES ,WAIT=NO	Default: WAIT=NO

Syntax	Description
,EXIT= <i>exit rtn addr</i>	<i>exit rtn addr</i> : A-type address or register (2) - (12). Note: EXIT must not be specified if WAIT=YES is specified.
,PARM= <i>stor addr</i>	<i>stor addr</i> : A-type address or register (2) - (12). Note: If PARM is specified, EXIT must be specified and WAIT=YES must not be specified.
,MF=(E, <i>ctrl addr</i>)	<i>ctrl addr</i> : A-type address or register (0), (2)-(12) for TEST and CANCEL, register (1)-(12) for SET.
,RELATED= <i>value</i>	

Parameters

The parameters are explained in the standard form of the STIMERM macro, with the following exception.

,MF=(E,*ctrl addr*)

Specifies the execute form of the STIMERM macro using a remote problem-program parameter list.

Example 1

Set a timer to a time interval of 15 microseconds, specifying the address of a 4-byte area in which the identifier assigned to this request by timer service will be returned. Specify:

- The address of an 8-byte area in INTERVAL that contains the time interval (represented as an unsigned 64-bit binary number)
- The address of a program to receive asynchronous control after the requested timer interval expires
- The address of a 4-byte parameter to be passed to the exit routine when the requested time interval expires
- The address of the appropriate parameter list in REMOTE

Include the address of an error routine in register 9.

```

          STIMERM SET, ID=(4), MICVL=(INTERVAL), EXIT=ROUTE, PARM=DATA,      X
          MF=(E, REMOTE), ERRET=(9)
DATA      DC CL4'WXYZ'                PARAMETER PASSED TO THE EXIT ROUTINE
INTERVAL  DC X'000000000000F000'      TIME INTERVAL

```

Example 2

Test the remaining time interval for a timer request established with the SET parameter, specifying the address of a 4-byte area from which the identifier assigned by timer service will be obtained. Specify that register 3 will point to the appropriate list. Specify that the time be returned in microseconds in an 8-byte area at the address named INTERVAL. Include the address of an exit error routine called ERR.

```

          STIMERM TEST, ID=ADDR, MIC=INTERVAL, MF=(E, (3)), ERRET=ERR
INTERVAL DS XL8      REMAINING TIME

```

Example 3

Cancel the timer request established with a SET parameter. Specify the address of a 4-byte identifier (assigned by timer service) named ADDRESS and that the time interval remaining be returned as an unsigned binary number in a 4-byte area named INTERVAL. Specify that register 0 will point to the appropriate list. Specify an error exit routine named ERROR.

```
STIMERM CANCEL, ID=ADDRESS, TU=INTERVAL, MF=(E, (0)), ERRET=ERROR
ADDRESS DS F          ID TO BE CANCELLED
INTERVAL DS XL4      REMAINING TIME
```

Chapter 99. STORAGE – Obtain and release storage

Description

The STORAGE macro requests that the system obtain or release an area of virtual storage in the primary address space. The two functions of the macro are:

- STORAGE OBTAIN, which obtains virtual storage in an address space
- STORAGE RELEASE, which releases virtual storage in an address space.

If you use STORAGE OBTAIN to request real storage backing above 2 gigabytes, but your system does not support 64-bit storage, your request will be treated as a request for backing above 16 megabytes, even on earlier releases of z/OS that do not support backing above 2 gigabytes. However, boundary requirements indicated by the CONTBDY and STARTBDY parameters will be ignored by earlier releases of z/OS.

The value for EXECUTABLE must match what was coded or defaulted on STORAGE OBTAIN.

Environment

The requirements on the caller are:

Environmental factor	Requirement
Minimum authorization:	For subpools 0-127: problem state and PSW key 8-15. For subpools 131 and 132: a PSW key mask (PKM) that allows the calling program to switch its PSW key to match the key of the storage to be obtained or released.
Dispatchable unit mode:	Task
Cross memory mode:	Any PASN, any HASN, any SASN
AMODE:	24- or 31- or 64-bit
RMODE:	Includes 64-bit
ASC mode:	For LINKAGE=SYSTEM: Primary or AR For LINKAGE=SVC: Primary
Interrupt status:	Enabled for I/O and external interrupts
Locks:	No locks held.
Control parameters:	No requirement.

Programming requirements

None.

Restrictions

None.

Register information

Register usage varies depending on the type of STORAGE request. For specific information, see the descriptions of STORAGE OBTAIN and STORAGE RELEASE.

Performance implications

None.

OBTAIN option of STORAGE

The STORAGE macro with the OBTAIN parameter requests that the system allocate an area of virtual storage to the active task. Each virtual storage area begins on a doubleword or page boundary. The amount of storage you request must not exceed the amount available; the amount available depends on how much storage has already been allocated, and on your user region size. Valid subpools available for problem-state callers are 0 - 127, 129 - 132, 240, and 250 - 252. When a task terminates, the system frees any storage in subpools 0 - 127 which is allocated to the terminating task. The system does not free storage in subpools 131 and 132 until the job-step task terminates.

Note: When you obtain storage, the system clears the requested storage to zeros if you obtain either:

- 8192 bytes or more from a pageable, private storage subpool and PAGEFRAMESIZE1M is not specified on the LOC keyword.
- 4096 bytes or more from a pageable, private storage subpool, with BNDRY=PAGE or STARTBDY=12 specified and PAGEFRAMESIZE1M is not specified on the LOC keyword..

In all other cases, you must not assume that the storage is cleared to zeros.

The caller can specify CHECKZERO=YES to detect these and other cases where the system clears the requested storage to zeros.

Input register information for LINKAGE=SYSTEM

Before issuing the STORAGE macro with the OBTAIN parameter, the caller does not have to place any information into any register unless using it in register notation for a particular parameter, or using it as a base register.

Output register information for LINKAGE=SYSTEM

When control returns to the caller, the general-purpose registers (GPRs) contain:

Register

Contents

0

For a successful request in which maximum and minimum lengths were specified, contains the length of the storage obtained. Otherwise, used as a work register by the system.

1

The address of the allocated storage when STORAGE OBTAIN is successful; otherwise, used as a work register by the system.

Note: A successful STORAGE OBTAIN returns a 64-bit pointer to the obtained area (bits 0-32 is zero).

2-13

Unchanged.

14

Used as a work register by the system.

15

For a conditional request, contains the return code. For an unconditional request, which is used as a work register by the system.

When control returns to the caller, the access registers (ARs) contain:

Register

Contents

0

Used as work registers by the system.

1

0 when the STORAGE OBTAIN is successful; otherwise, used as work register by the system.

2-13

Unchanged

14-15

Used as work registers by the system.

Some callers depend on register contents remaining the same before and after issuing a service. If the system changes the contents of registers on which the caller depends, the caller must save them before issuing the service, and restore them after the service returns control.

Input register information for LINKAGE=SVC

Before issuing the STORAGE macro with the OBTAIN parameter, the caller does not have to place any information into any register unless using it in register notation for a particular parameter, or using it as a base register.

Output register information for LINKAGE=SVC

When control returns to the caller, the general-purpose registers (GPRs) contain:

Register

Contents

0

For a successful request in which maximum and minimum lengths were specified, contains the length of the storage obtained. Otherwise, used as a work register by the system.

1

The address of the allocated storage when STORAGE OBTAIN is successful; otherwise, used as a work register by the system.

Note: A successful STORAGE OBTAIN returns a 64-bit pointer to the obtained area (bits 0-32 is zero).

2-13

Unchanged.

14

Used as a work register by the system.

15

Contains the return code.

When control returns to the caller, the access registers (ARs) contain:

Register

Contents

0

Used as work registers by the system.

1

0 when the STORAGE OBTAIN is successful; otherwise, used as work register by the system.

2-13

Unchanged

14-15

Used as work registers by the system.

Some callers depend on register contents remaining the same before and after issuing a service. If the system changes the contents of registers on which the caller depends, the caller must save them before issuing the service, and restore them after the service returns control.

Syntax

The STORAGE macro with the OBTAIN parameter is written as follows:

Syntax	Description
<i>name</i>	<i>name</i> : Symbol. Begin <i>name</i> in column 1.
␣	One or more blanks must precede STORAGE.
STORAGE	
␣	One or more blanks must follow STORAGE.
OBTAIN	
,LENGTH= <i>length value</i>	<i>length value</i> : Symbol, decimal number, or register (0), (2) - (12).
,LENGTH=(<i>max amount,min amount</i>)	<i>max amount</i> : Symbol, decimal number, or register (0), (2) - (12). <i>min amount</i> : Symbol, decimal number, or register (1) - (12).
,ADDR= <i>stor addr</i>	<i>stor addr</i> : RX-type address or register (1) - (12). Default: ADDR=(1).
,INADDR= <i>stor addr</i>	<i>stor addr</i> : RX-type address or register (1)-(12). Note: This parameter can only be specified with LOC=EXPLICIT.
,SP= <i>subpool number</i>	<i>subpool number</i> : Symbol, decimal number 0-127, 131, 132, or register (2) - (12), (15). Default: SP=0.
,BNDRY=DBLWD	
,BNDRY=PAGE	Default: BNDRY=DBLWD
,CONTBDY= <i>containing_bdy</i>	<i>containing_bdy</i> : Decimal number 3-31 or register (2) - (12).
,STARTBDY= <i>starting_bdy</i>	<i>starting_bdy</i> : Decimal number 3-31 or register (2) - (12).

Syntax	Description
,KEY=key number	key number: Decimal number 0-15 or register (2) - (12).
	Note: KEY is valid only when you also specify SP. You cannot specify both KEY and CALLRKY=YES.
,CALLRKY=NO	Default: CALLRKY=NO
,CALLRKY=YES	Notes: You cannot specify both CALLRKY=YES and KEY. Valid only with LINKAGE=SYSTEM.
,LOC=24	
,LOC=(24,31)	
,LOC=(24,64)	
,LOC=31	
,LOC=(31,31)	
,LOC=(31,64)	
,LOC=(31,PAGEFRAMESIZE1MB)	
,LOC=RES	Default: LOC=RES
,LOC=(RES,31)	
,LOC=(RES,64)	
,LOC=EXPLICIT	Note: You must specify the INADDR parameter with
,LOC=(EXPLICIT,24)	EXPLICIT.
,LOC=(EXPLICIT,31)	
,LOC=(EXPLICIT,64)	
,LOC=(EXPLICIT,PAGEFRAMESIZE1MB)	
,LINKAGE=SYSTEM	Default: LINKAGE=SYSTEM
,LINKAGE=SVC	
,RTCD=rtcd addr	rtcd addr: RX-type address, register (15), or register (2) - (12). Default: RTCD=(15).
,COND=YES	Default: COND=NO
,COND=NO	

Syntax	Description
,CHECKZERO=YES	Default: CHECKZERO=NO
,CHECKZERO=NO	
,BACK=BYSPT	Default: BACK=BYSPT
,BACK=NONE	
,BACK=ALL	
,FIX=NONE	Default: FIX=NONE
,FIX=SHORT	
,FIX=LONG	
,EXECUTABLE=YES	Default: EXECUTABLE=YES
,EXECUTABLE=NO	
,RELATED= <i>value</i>	<i>value</i> : Any valid macro parameter specification.

Parameters

The parameters are explained as follows:

OBTAIN

Requests that the system obtain virtual storage.

,LENGTH=*length value*

,LENGTH=(*max amount,min amount*)

Specifies the amount of storage the system is to obtain. *length value* specifies the length, in bytes, of the requested virtual storage. *max length* and *min length* specify the maximum and minimum amounts of storage. These numbers should be a multiple of 8; if they are not, the system uses the next higher multiple of 8.

If you specify LENGTH=(*max amount,min amount*), the system returns a value in general-purpose register 0 to tell you the amount of storage it obtained.

,ADDR=*stor addr*

Specifies the location where the system returns the address of the storage it allocates.

,INADDR=*stor addr*

Specifies the desired virtual address for the storage to be obtained. When you specify INADDR, you must specify EXPLICIT on the LOC parameter.

Note:

1. The address specified on INADDR must be on a doubleword boundary.
2. Make sure that the virtual storage address specified on INADDR and the central storage backing specified on the LOC=EXPLICIT parameter are a valid combination. For example, if the address specified on INADDR is for virtual storage above 16 megabytes, specify LOC=EXPLICIT or LOC=(EXPLICIT,ANY). Valid combinations include:
 - Virtual above, central any
 - Virtual any, central any

- Virtual below, central below
- Virtual below, central any

,SP=subpool number

Specifies the subpool number for the storage. Valid subpools for programs in problem state are 0 - 127, 131, and 132. See the discussion of subpool handling in *z/OS MVS Programming: Assembler Services Guide* for information and requirements which pertain to specific subpools. If you specify a register, the subpool number must be in bits 24-31 of the register, with bits 0-23 set to zero. If you omit this parameter, the system uses subpool 0.

,BNDRY=DBLWD**,BNDRY=PAGE**

Specifies whether the storage is to be aligned on a doubleword boundary (DBLWD) or a page boundary (PAGE). The default is BNDRY=DBLWD.

,CONTBDY=containing_bdy

Specifies the boundary that the obtained storage must be contained within. Specify a power of 2 that represents the containing boundary. Supported values are 3-31. For example, CONTBDY=10 means that the containing boundary is 2^{10} , or 1024 bytes. The containing boundary must be at least as large as the maximum requested boundary. The obtained storage will not cross an address that is a multiple of the requested boundary.

If a register is specified, the value must be in bits 24-31 of the register. Do not specify CONTBDY on a variable-length request.

CONTBDY is not valid with LOC=EXPLICIT or BNDRY=PAGE.

CONTBDY applies to all subpools.

If you omit this parameter, there is no containing boundary.

,STARTBDY=starting_bdy

Specifies the boundary that the obtained storage must start on. Specify a power of 2 that represents the start boundary. Supported values are 3-31. For example, STARTBDY=10 means the start boundary is 2^{10} , or 1024 bytes. The obtained storage will begin on an address that is a multiple of the requested boundary.

If a register is specified, the value must be in bits 24-31 of the register. Do not specify STARTBDY on a variable-length request.

STARTBDY is not valid with LOC=EXPLICIT or BNDRY=PAGE.

STARTBDY applies to all subpools.

If you omit this parameter, the start boundary is 8 bytes (equivalent to specifying STARTBDY=3).

,KEY=key number

Indicates the storage key of the storage to be obtained. You can obtain storage in your storage key or in key 9. If you pass the storage key in a register, it must be in bits 56-59 in that register. KEY is valid only when SP is specified, and applies to subpools 129 - 132, 227 - 231, 241, and 249. See the discussion of subpool handling in *z/OS MVS Programming: Assembler Services Guide* for information on system-assigned defaults and authorization requirements which pertain to specific subpools.

,CALLRKY=NO**,CALLRKY=YES**

Specifies how the system assigns the key for the storage to be obtained:

CALLRKY=NO

The system assigns the value according to the specified subpool:

- For subpools 129 - 132, 227 - 231, 241, and 249, the system assigns the value specified on the KEY parameter (or 0, if the KEY parameter is omitted) as the storage key
- For subpools 0 - 127, the system assigns the value from the TCB key at the time of the first request to obtain storage. See the discussion of subpool handling in *z/OS MVS Programming:*

Assembler Services Guide for information on system-assigned defaults and authorization requirements which pertain to specific subpools.

- For all other subpools, the system ignores the CALLRKY parameter.

CALLRKY=YES

The system assigns the caller's current PSW key as the storage key. When you specify CALLRKY=YES, do not also specify KEY. Specify CALLRKY only when obtaining storage from subpools 129 - 132, 227 - 231, 241, 244, and 249. For all other subpools, the system ignores the CALLRKY parameter.

The default is CALLRKY=NO.

CALLRKY is valid only with LINKAGE=SYSTEM.

,LOC=24
,LOC=(24,31)
,LOC=(24,64)
,LOC=31
,LOC=(31,31)
,LOC=(31,64)
,LOC=(31,PAGEFRAMESIZE1MB)
,LOC=RES
,LOC=(RES,31)
,LOC=(RES,64)
,LOC=EXPLICIT
,LOC=(EXPLICIT,24)
,LOC=(EXPLICIT,31)
,LOC=(EXPLICIT,64)
,LOC=(EXPLICIT,PAGEFRAMESIZE1MB)

Specifies the location of virtual storage and central (also called real) storage. This is especially helpful for callers with 24-bit dependencies. When LOC is specified, central storage is allocated anywhere until the storage is fixed (for example, using the PGSER macro). You can specify the location of central storage (after the storage is fixed) and virtual storage (whether the storage is fixed) using the following LOC parameter values:

LOC=24 indicates that central and virtual storage is to be located below 16 megabytes. LOC=24 must not be used to allocate disabled reference (DREF) storage.

Note: Specifying LOC=BELOW is the same as specifying LOC=24. LOC=BELOW is still supported, but IBM recommends using LOC=24 instead.

LOC=(24,31) indicates that virtual storage is to be located below 16 megabytes and central storage can be located anywhere below 2 gigabytes.

Note: Specifying LOC=(BELOW,ANY) is the same as specifying LOC=(24,31). LOC=(BELOW,ANY) is still supported, but IBM recommends using LOC=(24,31) instead.

LOC=(24,64) indicates that virtual storage is to be located below 16 megabytes and central storage can be located anywhere in 64-bit storage.

LOC=31 and LOC=(31,31) indicate that virtual and central storage can be located anywhere below 2 gigabytes.

Note: Specifying LOC=ANY or LOC=(ANY,ANY) is the same as specifying LOC=31 or LOC=(31,31). LOC=ANY and LOC=(ANY,ANY) are still supported, but IBM recommends using LOC=31 or LOC=(31,31) instead.

LOC=(31,64) indicates that virtual storage is to be located below 2 gigabytes and central storage can be located anywhere in 64-bit storage.

LOC=(31,PAGEFRAMESIZE1MB) locates virtual storage below 2 gigabytes and backs central storage anywhere in 64-bit storage, preferably by 1 MB page frames. PAGEFRAMESIZE1MB is only allowed for user region low private unauthorized subpools 0-127, 131, and 132.

When you use LOC=RES to allocate storage that can reside either above or below 16 megabytes, LOC=RES indicates that the location of virtual and central storage depends on the location of the caller. If the caller resides below 16 megabytes, virtual and central storage is to be located below 16 megabytes. If the caller resides above 16 megabytes, virtual and central storage is to be located either above or below 16 megabytes.

LOC=(RES,31) indicates that the location of virtual storage depends upon the location of the caller. If the caller resides below 16 megabytes, virtual storage is to be located below 16 megabytes; if the caller resides above 16 megabytes, virtual storage can be located anywhere below 2 gigabytes. In either case, central storage can be located anywhere below 2 gigabytes.

Note: Specifying LOC=(RES,ANY) is the same as specifying LOC=(RES,31). LOC=(RES,ANY) is still supported, but IBM recommends using LOC=(RES,31) instead.

LOC=(RES,64) indicates that the location of virtual storage depends upon the location of the caller. If the caller resides below 16 megabytes, virtual storage is to be located below 16 megabytes; if the caller resides above 16 megabytes, virtual storage can be located anywhere in 31-bit storage. In either case, central storage can be located anywhere in 64-bit storage.

Note: If your program resides below 16 megabytes but runs with 31-bit addressing mode, you can specify LOC=RES (as a default or explicitly) or LOC=(RES,31) to obtain storage from a subpool supported only above 16 MB. Do not specify subpools supported only above 16 megabytes on requests using LOC=RES or LOC=(RES,31) if your program resides below 16 megabytes and runs with 24-bit addressing.

LOC=EXPLICIT, LOC=(EXPLICIT,24), LOC=(EXPLICIT,31), or LOC=(EXPLICIT,64) specify that the requested virtual storage is to be at the address which is specified with the INADDR parameter, which is required with EXPLICIT. EXPLICIT is valid only for subpools 0 - 127, 129 - 132, 240, 244, 250, 251, and 252. You cannot specify the BNDRY or LENGTH=(*max amount,min amount*) parameter with EXPLICIT.

Note: Specifying LOC=(EXPLICIT,BELOW) is the same as specifying LOC=(EXPLICIT,24). Specifying LOC=(EXPLICIT,ANY) is the same as specifying LOC=(EXPLICIT,31). The newer specifications are recommended, but the older specifications are still supported.

LOC=(EXPLICIT,31) indicates that virtual storage is to be at the address which is specified on the INADDR parameter, and central storage can be located anywhere below 2 gigabytes.

LOC=(EXPLICIT,24) indicates that virtual storage is to be at the address which is specified on the INADDR parameter, and central storage is to be located below 16 megabytes. The virtual storage address specified on the INADDR parameter must be below 16 megabytes.

LOC=EXPLICIT and LOC=(EXPLICIT,64) indicate that virtual storage is to be at the address specified on the INADDR parameter, and central storage can be located anywhere in 64-bit storage.

When you specify EXPLICIT on a request for storage from the same virtual page as previously requested storage, you must request it in the same key, subpool, and central storage area as on the previous storage request. For example, if you request virtual storage backed with central storage below 16 megabytes, any subsequent requests for storage from that virtual page must be specified as LOC=(EXPLICIT,24).

LOC=(EXPLICIT,PAGEFRAMESIZE1MB) locates virtual storage at the address specified by the INADDR parameter and backs central storage anywhere in 64-bit storage, preferably by 1 MB page frames. PAGEFRAMESIZE1MB can be specified only for user region low private unauthorized subpools 0-127, 131, and 132.

,LINKAGE= SYSTEM

,LINKAGE=SVC

Specifies the type of entry linkage to be used.

LINKAGE=SYSTEM

The STORAGE OBTAIN macro receives control through PC entry.

LINKAGE=SVC

The STORAGE OBTAIN macro receives control through SVC entry.

,BACK=BYSPT**,BACK=NONE****,BACK=ALL**

Specifies a preference for how much storage should be backed by real storage at the time the storage is obtained.

BACK=BYSPT

Storage should be backed by pageable storage subpools.

BACK=NONE

No storage should be backed.

BACK=ALL

All storage should be backed.

,FIX=NONE**,FIX=SHORT****,FIX=LONG**

Indicates to the system the anticipated amount of time that the storage obtained by this STORAGE OBTAIN is fixed.

FIX=NONE

The storage will not be fixed.

FIX=SHORT

The amount of time anticipated for the FIX is short.

FIX=LONG

The amount of time anticipated for the FIX is long. (In general, the duration of a fix is long if it can be measured in seconds.)

,RTCD=*rtcd addr*

Specifies the location where the system is to store the return code. This parameter is valid only with COND=YES. The return code is also in GPR 15.

,COND=NO**,COND=YES**

COND=YES specifies that the active unit of work should not be abnormally terminated if there is insufficient contiguous virtual storage to satisfy the request, and instead should return to the caller with a nonzero return code. Use of COND=YES does not prevent all abnormal terminations. For example, if the request has incorrect or inconsistent parameters, the system abnormally terminates the active unit of work. If you specify COND=YES, you may also specify the RTCD parameter to define the location where the system is to store the return code.

COND=NO indicates that the request is unconditional. The system abnormally terminates the active unit of work if the STORAGE OBTAIN request cannot complete successfully. This situation occurs if the parameters passed on the request are incorrect or inconsistent, if the system encounters internal errors, or if there is not enough contiguous virtual storage to satisfy the request. COND=NO is the default.

,CHECKZERO=YES**,CHECKZERO=NO**

Specifies whether the return code for a successful completion should indicate if the system has cleared the requested storage to zeros. When CHECKZERO=NO is specified or defaulted, the return code for a successful completion is 0. When CHECKZERO=YES is specified, the return code for a successful completion is X'14' if the system has cleared the requested storage to zeros, and 0 if the system has not cleared the requested storage to zeros.

There is no performance cost to specifying CHECKZERO=YES.

Programs that issue the STORAGE macro with the CHECKZERO parameter can run on any z/OS system. On a down-level system, CHECKZERO is ignored, and the return code for a successful completion (conditional or unconditional) is 0.

,EXECUTABLE=YES**,EXECUTABLE=NO**

Specifies if code can be executed from the obtained storage on a system that has implemented instruction-execution-protection. It is only valid when requesting storage from a private storage subpool.

,EXECUTABLE=YES

This parameter indicates that code is able to be executed from the obtained storage.

,EXECUTABLE=NO

This parameter indicates that code will not be able to be executed from the obtained storage on a system that has implemented instruction-execution-protection. The specification of NO will be ignored when executed on a system that has not implemented instruction-execution-protection or is not running an appropriate level of z/OS.

,RELATED=value

Specifies information used to self-document macro by “relating” functions or services to corresponding functions or services. The format and contents of the information which is specified are at the discretion of the user, and can be any valid coding values.

ABEND codes

STORAGE OBTAIN might issue the hexadecimal abend codes in the following list. For detailed abend code information, see [z/OS MVS System Codes](#).

- 178
- 278
- 378
- 478
- 778
- 878
- 978
- A78
- B78
- D78

Return and reason codes

When control returns from the STORAGE OBTAIN request and you specified a conditional request, bits 32-63 of GPR 15 (and *rtcd addr*, if you coded RTCD) contain one of the following hexadecimal return codes. The contents of bits 0-31 of GPR 15 are unpredictable.

<i>Table 56. Return Codes for STORAGE OBTAIN</i>	
Return Code	Meaning and Action
0	<p>Meaning: Successful completion. CHECKZERO=YES was not specified, or the system has not cleared the requested storage to zeros.</p> <p>Action: None.</p>

<i>Table 56. Return Codes for STORAGE OBTAIN (continued)</i>	
Return Code	Meaning and Action
4	<p>If you did not specify EXPLICIT on the LOC parameter:</p> <ul style="list-style-type: none"> • Meaning: Environmental error. Virtual storage was not obtained because insufficient storage is available. • Action: Consult the system programmer to see if you have exceeded an installation-determined private storage limit. <p>If you specified EXPLICIT on the LOC parameter:</p> <ul style="list-style-type: none"> • Meaning: Program error. Virtual storage was not obtained because part of the requested storage area is outside the bounds of the user region. • Action: Determine why your program is mistakenly requesting storage outside the user region. If your region size is too small, consult the system programmer about increasing the region size.
8	<p>Meaning: System error. Virtual storage was not obtained because the system has insufficient central storage to back the request.</p> <p>Action: Report the problem to the system programmer so the cause of the problem can be determined and corrected.</p>
C	<p>Meaning: System error. Virtual storage was not obtained because the system cannot page in the page table associated with the storage to be allocated.</p> <p>Action: Report the problem to the system programmer so the cause of the problem can be determined and corrected.</p>
10	<p>Meaning: Program error. Virtual storage was not obtained for one of the reasons listed below. This reason code applies only to STORAGE requests with LOC=EXPLICIT specified.</p> <ul style="list-style-type: none"> • Part of the requested area is allocated already. • Virtual storage was already allocated in the same page as this request, but one of the following characteristics of the storage was different: <ul style="list-style-type: none"> – The subpool – The key – Central storage backing <p>Action: Determine why your program is attempting to obtain allocated storage or why your program is attempting to obtain virtual storage with different attributes from the same page of storage. Correct the coding error.</p>
14	<p>Meaning: Successful completion. The system has cleared the requested storage to zeros. This return code occurs only when CHECKZERO=YES is specified.</p> <p>Action: None.</p>
18	<p>Meaning: PAGEFRAMESIZE1MB was specified on the LOC=parameter on a STORAGE OBTAIN request for a subpool other than 0-127, 129 - 132, 240, 244 or 250-252.</p> <p>Action: None.</p>

RELEASE option of STORAGE

The STORAGE macro with the RELEASE parameter requests that the system release an area of virtual storage or an entire virtual storage subpool, previously allocated through the STORAGE or GETMAIN macro. The system abends the active task if the specified virtual storage does not start on a doubleword boundary or, for an unconditional request, if the specified area or subpool is not allocated to the task identified as the owning task.

Input register information

Before issuing the STORAGE macro with the RELEASE parameter, the caller does not have to place any information into any register unless using it in register notation for a particular parameter, or using it as a base register.

Output register information

When control returns to the caller, the general purpose registers (GPRs) contain:

Register Contents

0-1

Used as work registers by the system.

2-13

Unchanged.

14

Used as a work register by the system.

15

For a conditional request, contains the return code. For an unconditional request, used as a work register by the system.

When control returns to the caller, the access registers (ARs) contain:

Register Contents

0-1

Used as work registers by the system

2-13

Unchanged

14-15

Used as work registers by the system

Some callers depend on register contents remaining the same before and after issuing a service. If the system changes the contents of registers on which the caller depends, the caller must save them before issuing the service, and restore them after the service returns control.

Syntax

The STORAGE macro with the RELEASE option is written as follows:

Syntax	Description
<i>name</i>	<i>name</i> : Symbol. Begin <i>name</i> in column 1.
‡	One or more blanks must precede STORAGE.

STORAGE macro

Syntax	Description
STORAGE	
	One or more blanks must follow STORAGE.
RELEASE	
,LENGTH= <i>length value</i> ,ADDR= <i>stor addr</i>	
,LENGTH= <i>length value</i> ,ADDR= <i>stor addr</i> ,SP= <i>subpool number</i>	
	<i>length value</i> : Symbol, decimal number, or register (0), (2) - (12).
	<i>stor addr</i> : RX-type address or register (1) - (12).
	<i>subpool number</i> : Symbol, decimal number 0-127, 131, 132, or register (2) - (12), (15).
	Default: SP=0.
,KEY= <i>key number</i>	<i>key number</i> : Decimal number 0-15 or register (2) - (12).
	Note: KEY is valid only when SP is specified.
,RTCD= <i>rtcd addr</i>	<i>rtcd addr</i> : RX-type address, register (15), or register (2) - (12). Default: RTCD=(15).
,COND=YES	Default: COND=NO
,COND=NO	
,EXECUTABLE=YES	Default: EXECUTABLE=YES
,EXECUTABLE=NO	
,RELATED= <i>value</i>	<i>value</i> : Any valid macro parameter specification.

Parameters

The parameters are explained as follows:

RELEASE

Requests that the system release virtual storage.

,LENGTH=length value

Specifies the number of bytes of storage that the system is to release. If you specify LENGTH, you must also specify ADDR. To free an entire subpool, use SP instead of LENGTH and ADDR. Do not specify a length value of 0 with an address of 0. This combination causes STORAGE RELEASE to free the subpool specified with the SP parameter, or subpool 0 if the SP parameter is omitted.

,ADDR=stor addr

Specifies the address of the storage to be released. If you specify ADDR, you must also specify LENGTH. To free an entire subpool, use SP instead of LENGTH and ADDR.

,SP=subpool number

Specifies the subpool number for the storage to be released. The valid subpool numbers are 0-127, 131, and 132. If you specify the subpool in a register, the subpool number must be in bits 24-31 of the register, with bits 0-23 set to zero. If you omit this parameter, the system uses subpool 0.

A request to release all the storage in a subpool is known as a **subpool release**. To issue a subpool release, use SP to indicate the subpool and do not specify LENGTH or ADDR. A caller in problem state can issue a subpool release for subpools 1-127, 131, and 132. A caller in problem state cannot issue a subpool release for subpool 0. See the description of subpool handling in *z/OS MVS Programming: Assembler Services Guide* for information and requirements pertaining to specific subpools.

,KEY=key number

Indicates the storage key of the storage to be released. The valid storage keys are your program's storage key or key 9. If you pass the storage key in a register, it must be in bits 56-59 in that register. KEY is valid only when SP is specified and applies only to subpools 131 and 132. KEY allows you to release storage in the specified storage key. See the discussion of subpool handling in *z/OS MVS Programming: Assembler Services Guide* for information on authorization requirements pertaining to specific subpools.

,RTCD=rtcd addr

Specifies the location where the system is to store the return code. This parameter is valid only for conditional requests. The return code is also in GPR 15.

,COND=NO**,COND=YES**

Specifies whether the request is unconditional or conditional.

COND=YES specifies that the task should not abend if the system cannot release the storage. However, the system cannot prevent some abends. The RTCD parameter specifies the location where the system is to store a return code.

COND=NO specifies that the system is to abend the active task if it cannot release the storage. COND=NO is the default.

,EXECUTABLE=YES**,EXECUTABLE=NO**

Specifies if code can be executed from the obtained storage on a system that has implemented instruction-execution-protection. It is only valid when requesting storage from a private storage subpool. The specified executable setting must either explicitly or by default match the executable setting of the storage.

,EXECUTABLE=YES

This parameter indicates that code is able to be executed from the obtained storage.

,EXECUTABLE=NO

This parameter indicates that code will not be able to be executed from the obtained storage on a system that has implemented instruction-execution-protection. The specification of NO will be ignored when executed on a system that has not implemented instruction-execution-protection or is not running an appropriate level of z/OS.

,RELATED=value

Specifies information used to self-document macro by “relating” functions or services to corresponding functions or services. The format and contents of the information specified are at the discretion of the user, and can be any valid coding values.

ABEND codes

STORAGE RELEASE might issue the hexadecimal abend codes in the following list. For detailed abend code information, see [z/OS MVS System Codes](#).

- 178
- 278
- 378
- 478
- 778
- 878
- 978
- A78
- B78
- D78

Return and reason codes

When the STORAGE macro returns control to your program and you specified a conditional request, GPR 15 (and *rtcd addr*, if you coded RTCD) contains one of the following hexadecimal return codes:

Table 57. Return Codes for the STORAGE RELEASE	
Return Code	Meaning and Action
0	<p>Meaning: Successful completion.</p> <p>Action: None.</p>
4	<p>Meaning: Program error. Not all requested virtual storage was freed.</p> <p>Action: Check your program for the following kinds of errors:</p> <ul style="list-style-type: none"> • The address of the storage area to be freed is not correct. • The subpool you have specified does not match the subpool of the storage to be freed. • The key you have specified does not match the key of the storage to be freed. • The EXECUTABLE setting does not match the executable setting of the storage to be freed.
8	<p>Meaning: Program error. No virtual storage was freed because part of the storage area to be freed is fixed.</p> <p>Action: Check for the following kinds of errors:</p> <ul style="list-style-type: none"> • You passed an incorrect storage area address to the STORAGE macro. • You attempted to free storage that is fixed.

Examples of the OBTAIN and RELEASE options

Example 1

Request that the system obtain 1000 bytes of virtual storage from subpool 127 and return its address in register 3. If the request fails, the system is to abnormally end the caller.

```
LA      2,1000
STORAGE OBTAIN,LENGTH=(2),ADDR=(3),SP=127,LOC=ANY,COND=NO
```

```
* Release 1000 bytes from subpool 127 and abnormally end the
* caller if the request fails. Assume that the length of the storage
* is still in register 2 and the address of the storage is still in
* register 3.
```

```
STORAGE RELEASE,LENGTH=(2),ADDR=(3),SP=127,COND=NO
```

Example 2

Request that the system obtain 4096 bytes from subpool 101 and return the address at the location defined by the RX-type address STRGA. If the request fails, the system is to save a return code at MY_RC.

```
STORAGE OBTAIN,LENGTH=ONE_PAGE,ADDR=STRGA,SP=MY_SUBPOOL, X
LOC=ANY,COND=YES,RTCD=MY_RC

* Release 4096 bytes from subpool 101.

STORAGE RELEASE,LENGTH=ONE_PAGE,ADDR=STRGA,SP=MY_SUBPOOL, X
COND=YES,RTCD=MY_RC

MY_RC DS F
STRGA DS F
ONE_PAGE EQU 4096
MY_SUBPOOL EQU 101
```

Example 3

Request that the system obtain 4096 bytes from subpool 101. If that much is not available, settle for a minimum of 1024 bytes. The system is to return the address of the storage at the RX-type address STRGA. If the request fails, the system is to store a return code at MY_RC.

```
STORAGE OBTAIN,LENGTH=(ONE_PAGE,ONE_K),ADDR=STRGA, X
SP=MY_SUBPOOL,LOC=ANY,COND=YES,RTCD=MY_RC
ST 0,STRG_LEN

* Release the storage in subpool 101. The address of the
* storage is at the RX-type address 'STRGA'. Note that
* LENGTH=STRG_LEN is not valid.

L 3,STRG_LEN
STORAGE RELEASE,LENGTH=(3),ADDR=STRGA,SP=MY_SUBPOOL, X
COND=YES,RTCD=MY_RC

MY_RC DS F
STRG_LEN DS F
STRGA DS F
ONE_PAGE EQU 4096
ONE_K EQU 1024
MY_SUBPOOL EQU 101
```

Example 4

Code the instructions to set up an 18-word save area, such as one that a program in AR address space control (ASC) mode would obtain to call a program in primary mode. The program issuing the STORAGE macro is in 31-bit addressing mode, and the code is reentrant.

```
PGM CSECT
PGM AMODE 31
PGM RMODE ANY
BAKR 14,0 SAVE CALLER'S ARS, GPRS AND RETURN
ADDRESS ON LINKAGE STACK
* SAC 512 SWITCH TO AR ASC MODE
LAE 12,0(15,0) SET UP PROGRAM BASE REGISTER AND AR
USING PGM,12
STORAGE OBTAIN,LENGTH=72 GET REENTRANT SAVEAREA
LAE 13,0(1,0) PUT SAVEAREA ADDRESS IN AR/GPR 13
MVC 4(4,13),=C'F1SA' PUT ACRONYM INTO SAVEAREA TO
* INDICATE STATUS SAVED ON LINKAGE STACK
* BEGIN PROGRAM CODE HERE
```

STORAGE macro

To release this save area, issue the following instructions:

```
.  
LAE 1,0(13,0)          COPY SAVEAREA ADDRESS  
STORAGE RELEASE,ADDR=(1),LENGTH=72  FREE SAVEAREA  
  
.  
SLR 15,15             SET RETURN CODE OF ZERO  
PR                    RETURN TO CALLER, RESTORE CALLERS STATUS
```

Chapter 100. SYMRBLD – Building a symptom record

Description

The SYMRBLD macro generates code to build a symptom record. A symptom record is a data area that contains a description of a program failure combined with a description of the environment where the failure occurred. The symptom record consists of six sections. These sections are numbered 1 through 5, including an additional section that is numbered 2.1. The purpose of each section is as follows:

- Section 1 (Environmental Data) - This section is filled in by the SYMREC macro. The environmental data the SYMREC macro stores in this section includes the processor model and serial numbers, data and time, name of the customer installation, and the product ID of the control program.
- Section 2 (Control Data) - This section contains the lengths and offsets of the remaining sections.
- Section 2.1 (Component Data) - This section identifies the application in which the error occurred.
- Section 3 (Primary SDB symptoms) - This section contains the primary string of problem symptoms. This data is used for duplicate problem recognition.
- Section 4 (Secondary SDB symptoms) - This section contains any additional diagnostic values saved at the time of the error.
- Section 5 (Variable Data) - This section contains diagnostic data, such as portions of data areas or parameter lists pertinent to the error.

Input to the SYMRBLD macro is a storage area for the symptom record, and the diagnostic data for sections 2.1, 3, 4, and 5 of the symptom record. The SYMRBLD macro must be invoked several times to build a complete symptom record. The following describes the sequence:

1. Invoke SYMRBLD with the INITIAL parameter to initialize sections 1 and 2, and provide application data for section 2.1.
2. Invoke SYMRBLD with the PRIMARY parameter to store symptoms into section 3. You may invoke this parameter more than once for one error.
3. Optionally invoke SYMRBLD with the SECONDARY parameter to store symptoms into section 4.
4. Optionally invoke SYMRBLD with the VARIABLE parameter to store data into section 5.
5. Invoke SYMRBLD with the COMPLETE parameter to set the lengths of sections 3, 4, and 5 in section 2.1 and optionally code SYMRBLD to invoke the SYMREC macro for recording to the logrec data set. If you do not code SYMRBLD to invoke the SYMREC macro, your records will not be recorded to the logrec data set.
6. Invoke SYMRBLD with the RESET parameter to rebuild the symptom record using the same storage area and application information that was specified using the INITIAL parameter. The RESET parameter is useful when the primary, secondary, and variable sections of the symptom record are to be changed but the application information in section 2.1 remains the same.

The following description of the SYMRBLD macro is divided into six sections:

- SYMRBLD with the INITIAL parameter
- SYMRBLD with the PRIMARY parameter
- SYMRBLD with the SECONDARY parameter
- SYMRBLD with the VARIABLE parameter
- SYMRBLD with the COMPLETE parameter
- SYMRBLD with the RESET parameter

There is no list or execute form of the macro.

Environment

Requirements for the caller are:

Environmental factor	Requirement
Minimum authorization:	Problem state, and any PSW key.
Dispatchable unit mode:	Task or SRB
Cross memory mode:	Any PASN, any HASN, any SASN
AMODE:	24- or 31-bit
ASC mode:	Primary, secondary, or access register (AR)
Interrupt status:	Enabled or disabled for I/O and external interrupts
Locks:	No locks held.
Control parameters:	Must be in the primary address space or be in an address/data space that is addressable through a public entry on the caller's dispatchable unit access list (DU-AL).

Programming requirements

The maximum size of the symptom record is 1900 bytes. In addition to providing storage for the symptom record, 100 bytes must be provided for a work area; therefore, the maximum amount of storage needed is 2000 bytes.

The symptom record storage must reside in the primary address space.

Restrictions

None.

Input register information

When specifying SYMRBLD COMPLETE with INVOKE=YES (the default) the caller must ensure that register 13 points to a standard 72-byte save area.

Once you specify SR on SYMRBLD INITIAL and you plan to specify either SYMRBLD PRIMARY, SYMRBLD SECONDARY, SYMRBLD VARIABLE, or SYMRBLD COMPLETE without respecifying the SR parameter, you must put the address of the storage area into register 1.

Output register information

When control returns to the caller, the general purpose registers (GPRs) contain:

Register

Contents

0

Reason code from the SYMREC macro if you code SYMRBLD COMPLETE with INVOKE=YES; otherwise, used as a work register by the system.

1

Used as a work register by the system.

2-13

Unchanged.

14

Used as a work register by the system.

15

Return code from the SYMREC macro if you code SYMRBLD COMPLETE with INVOKE=YES; otherwise, used as a work register by the system.

When control returns to the caller, the access registers (ARs) contain:

**Register
Contents**

0-1

Used as work registers by the system

2-13

Unchanged

14-15

Used as work registers by the system

Some callers depend on register contents remaining the same before and after issuing a service. If the system changes the contents of registers on which the caller depends, the caller must save them before issuing the service, and restore them after the system returns control.

Performance implications

None.

Syntax with INITIAL option

The standard form of the SYMRBLD macro with the INITIAL option is written as follows:

Syntax	Description
<i>name</i>	<i>name</i> : Symbol. Begin <i>name</i> in column 1.
␣	One or more blanks must precede SYMRBLD.
SYMRBLD	
␣	One or more blanks must follow SYMRBLD.
INITIAL	
,SR= <i>storage addr</i>	<i>storage addr</i> : RX-type address or address in register (2)-(12).
,PRIMLEN= <i>primary length</i>	<i>primary length</i> : Decimal digit, RX-type address, or address in register (2)-(12).
,SECLLEN= <i>secondary length</i>	<i>secondary length</i> : Decimal digit, RX-type address, or address in register (2)-(12).
	Default: 0

Syntax	Description
,VARLEN= <i>variable length</i>	<i>variable length</i> : Decimal digit, RX-type address, or address in register (2)-(12).
	Default: 0
,ARCHLEV=10	This is the architecture level of the symptom record.
,COMPDESC= <i>comp desc</i>	<i>comp desc</i> : RX-type address or address in register (2)-(12).
,PROBLEM= <i>problem id</i>	<i>problem id</i> : RX-type address or address in register (2)-(12).
,SERVLEV= <i>service level</i>	<i>service level</i> : RX-type address or address in register (2)-(12).
,NOCONVERTS	
,PROGRAM= <i>progname</i>	<i>progname</i> : RX-type address or address in register (2)-(12).
,PROGLEV= <i>proglevel</i>	<i>proglevel</i> : RX-type address or address in register (2)-(12).

Parameters with INITIAL option

The parameters for SYMRBLD INITIAL are explained as follows:

INITIAL

Sets sections 1, 2, and 2.1 of the symptom record to zero, and initializes the offsets of sections 3, 4, and 5 in section 2.1.

,SR=*storage addr*

Specifies the address of the storage area, on a doubleword boundary, used for the symptom record. The storage area must reside in the primary address space.

The maximum size of the symptom record is 1900 bytes. Sections 1, 2, and 2.1 use 212 bytes of the total 1900 bytes. Sections 3, 4, and 5 use the remaining 1688 bytes. In addition to providing storage for the symptom record, 100 bytes must be provided for a work area, therefore, the maximum amount of storage needed is 2000 bytes.

Use the PRIMLEN, SECLen, and VARLEN parameters to specify the length of sections 3, 4, and 5, respectively.

,PRIMLEN=*primary length*

Specifies the address of a required halfword input variable that contains the maximum length in bytes of the primary symptom string. You can also directly specify a decimal digit for the length (for example, PRIMLEN=900). If you use register notation, the register contains the address of the length rather than the length itself.

The following formula calculates the length of the primary symptom string:

```
Lengths of all SDBKEYs + length of all data provided with
the DATA keyword + the number of times SDBKEY is specified
```



```
+ the length of all data specified with the SDBSTRING keyword
+ the number of times the SDBSTRING keyword is provided.
```

Note that this field cannot be zero and the maximum size of the entire symptom record is 1900 bytes.

,SECLen=secondary length

Specifies the address of an optional halfword input variable that contains the maximum length in bytes of the secondary symptom string. You can also directly specify a decimal digit for the length (for example, SECLen=900). If you use register notation, the register contains the address of the length rather than the length itself.

The following formula calculates the length of the secondary symptom string:

```
Lengths of all SDBKEYs + length of all data provided with
the DATA keyword + the number of times SDBKEY is specified
+ the length of all data specified with the SDBSTRING keyword
+ the number of times the SDBSTRING keyword is provided.
```

Note that the maximum size of the entire symptom record is 1900 bytes.

If a length of zero is specified, the secondary symptom string is ignored. If SECLen is not specified, the default is zero.

,VARLEN=variable length

Specifies the address of an optional halfword input variable that contains the maximum length in bytes of the variable data section. You can also directly specify a decimal digit for the length (for example, VARLEN=900). If you use register notation, the register contains the address of the length rather than the length itself.

The following formula calculates the length of the variable data section:

```
The length provided must be the total length of the variable data items
+ the number of items (x) 4.
```

(The 4 is for the 2 byte key + 2 bytes for the length.) Note that the maximum size of the entire symptom record is 1900 bytes.

If a length of zero is specified, section 5 is ignored. If VARLEN is not specified, the default is zero.

,ARCHLEV=10

Specifies the architecture level of the symptom record. The only valid value is 10.

,COMPDESC=comp desc

Specifies the address of an optional 32-character input text description of the failing module's subfunction; for example, IOS - IOSB Analysis Routine.

,PROBLEM=problem id

Specifies the address of an optional 8-character input problem identifier used to associate the symptom record with other symptom records or with other problem indicators.

,SERVLEV=service level

Specifies the address of an optional 8-character input service level. When a value is provided, the code is normally at a higher level than the release level. The values of this field can be any information that is indicative of the service level; for example, PTF#, APAR#, or user modification number.

,NOCONVERTS

Indicates no data conversion from binary to hexadecimal EBCDIC is needed for this symptom record.

,PROGRAM=programe

Specifies the address of a required 8-character input variable that contains the name of the failing program. When this parameter is specified, the PIDS/aaaaaaaa SDB symptom is automatically put into section 3 of the symptom record. **aaaaaaaa** indicates the *programe*.

,PROGLEV=proglevel

Specifies the address of a required 8-character input variable that contains the name of the program major level.

Syntax with PRIMARY option

The standard form of the SYMRBLD macro with the PRIMARY option is written as follows:

Syntax	Description
<i>name</i>	<i>name</i> : Symbol. Begin <i>name</i> in column 1.
␣	One or more blanks must precede SYMRBLD.
SYMRBLD	
␣	One or more blanks must follow SYMRBLD.
PRIMARY	
,SR= <i>storage addr</i>	<i>storage addr</i> : RX-type address or address in register (2)-(12).
,SDBSTRING= <i>SDB string</i>	<i>SDB string</i> : RX-type address or address in register (2)-(12).
,SDBKEY= <i>SDB key</i>	<i>SDB key</i> : SDB key name, or SDB key literal in single quotation marks. See the parameter description for a list of valid SDB key names and literals. Note: You must code either SDBSTRING or SDBKEY or both.
,SDBLEN= <i>SDB length</i>	<i>SDB length</i> : Decimal digit 1-256, or register (2)-(12).
,SDBLENVAR= <i>SDB variable</i>	<i>SDB variable</i> : RX-type address or address in register (2)-(12). Note: 1. If you use register notation for <i>SDB length</i> , the register contains the length itself rather than the address of the length. 2. SDBLEN (or SDBLENVAR) is valid with SDBSTRING only.
,DATA= <i>data</i>	<i>data</i> : RX-type address or address in register (2)-(12). Note: DATA is required with SDBKEY only.
,LEN= <i>data length</i>	<i>data length</i> : Decimal digit 1-13, or register (2)-(12).
,LENVAR= <i>data variable</i>	<i>data variable</i> : RX-type address or address in register (2)-(12). Note: 1. If you use register notation for <i>data length</i> , the register contains the length itself rather than the address of the length. 2. LEN (or LENVAR) is valid with DATA only.

Syntax	Description
,CONVERT=YES	Default: CONVERT=NO
,CONVERT=NO	Note: CONVERT is valid with DATA only.
,TYPE=TEST ,TYPE=NOTEST	Default: TYPE=TEST

Parameters with PRIMARY option

The parameters for SYMRBLD PRIMARY are explained as follows:

PRIMARY

Indicates that the symptom data provided is concatenated to section 3, the primary symptom string. The primary symptom string is an EBCDIC character string of problem symptoms. The primary symptom string is used to eliminate reporting duplicate problems repeatedly.

You would use the primary symptom string because, in most cases, the PIDS/aaaaaaaa symptom is in section 3 of the symptom record. When the symptom record is initialized by invoking SYMRBLD INITIAL, the symptom is created from the data supplied with the PROGRAM parameter and is placed as the first symptom in section 3.

The suggested minimum list of symptoms includes:

- Return or reason codes - PRCS/aaaaaaaa
- CSECT name - RIDS/aaaaaaaa
- Load module name - RIDS/aaaaaaaa#L

Note: The following restrictions apply to symptoms in the primary symptom string:

- The symptom data cannot contain imbedded blanks. The '#' is used to substitute for desired blanks.
- The total length of each symptom may not exceed 15 characters. The symptom length includes the SDB key, a slash, and the EBCDIC data. Remember that hexadecimal data doubles in length when converted to hexadecimal representation in EBCDIC.

,SR=storage addr

Specifies the address of the storage area, on a doubleword boundary, used for the symptom record.

This is the same storage area you specified on SYMRBLD INITIAL. If you do not specify SR with SYMRBLD PRIMARY, the default is to use the storage area address you placed in register 1.

,SDBSTRING=SDB string

Specifies the address of an optional character input string to be added to the primary symptom string. The data is a list of symptoms separated by a blank. A symptom is an SDB key followed by a slash and EBCDIC data.

You must code either SDBSTRING or SDBKEY or both. When you code both on the same macro, the data provided with the SDBSTRING parameter is put into the symptom string first.

,SDBKEY=SDB key

Specifies an optional name from the set of SDB keys. You can provide the SDB key name, or specify the SDB key literal in single quotation marks (for example, specify either SDBKEY=SDBAB_S, or SDBKEY='AB/S').

You must code either SDBSTRING or SDBKEY or both. When you code both on the same macro, the data provided with the SDBSTRING parameter is put into the symptom string first.

The following table contains the valid SDB key names and literals:

<i>Table 58. Valid SDB Key Names and Literals</i>		
SDB Key Name	SDB Key Literal	Description
SDBAB_S	AB/S	System abend or program check.
SDBAB_U	AB/U	User abend code.
SDBADRS	ADRS/	Any software routine, CSECT, or program address; displacement within a routine; or offset within a field or data area.
SDBDEVS	DEVS/	IBM device types.
SDBFLDS	FLDS/	A field, data area, or label involved with the problem. If a field name is longer than 10 characters, use two keys and split the name of the field.
SDBLVLS	LVLS/	The system release or program product/component level where the problem occurs.
SDBMS	MS/	Program- or device-issued message. If there is no identifier, enter the message as it appears and MS/NOID to denote this.
SDBOPCS	OPCS/	Software program operation code, I/O read/write command codes, teleprocessing operation codes and request codes.
SDBOVS	OVS/	Overlaid storage.
SDBPCSS	PCSS/	Any software statement, JCL, operator or user commands, parameters, program language statements, data set names, library names, teleprocessing logical and physical unit names, program function keys or other operator keys, environments, process names, procedures or other symptoms which do not fit other key descriptions in this table.
SDBPIDS	PIDS/	Product identifier.
SDBPRCS	PRCS/	Any program-generated return, reason, step, condition, or device status code.
SDBPTFS	PTFS/	Program temporary fix (PTF) or Authorized Program Analysis Report (APAR) associated with the problem.
SDBPUBS	PUBS/	Publication identifier.
SDBREGS	REGS/	A register number associated with the problem, followed by the offset from the PSW.
SDBREGS_CR	REGS/CR	A control register associated with the problem. This symptom is followed with a symptom containing the value in the register.
SDBREGS_FP	REGS/FP	A floating point register associated with the problem. This symptom is followed with a symptom containing the value in the register.
SDBREGS_GR	REGS/GR	A general purpose register associated with the problem. This symptom is followed with a symptom containing the value in the register.

<i>Table 58. Valid SDB Key Names and Literals (continued)</i>		
SDB Key Name	SDB Key Literal	Description
SDBREGS_AR	REGS/AR	An access register associated with the problem. This symptom is followed with a symptom containing the value in the register.
SDBRIDS	RIDS/	Module CSECT name.
SDBRIDSL	RIDS/	Load module name.
SDBRIDSR	RIDS/	Recovery routine CSECT name.
SDBSIG	SIG/	System- or device-issued operator warning signal.
SDBVALU	VALU/	Contents of a register. This SDB keyword must be preceded with one of the following: REGS/CRhh, REGS/FPhh, or REGS/GRhh.
SDBVALU_B	VALU/B	Binary value of a field in error. This SDB key must be preceded by the name of the field. The most appropriate SDB key is FLDS/.
SDBVALU_C	VALU/C	Character value of a field in error. This SDB key must be preceded by the name of the field. The most appropriate SDB key is FLDS/.
SDBVALU_H	VALU/H	Hexadecimal value of a field in error. This SDB key must be preceded by the name of the field. The most appropriate SDB key is FLDS/.
SDBWS_D	WS/D	System- or device-issued disabled WAIT code.
SDBWS_E	WS/E	System- or device-issued enabled WAIT code.

,SDBLEN=SDB length

Specifies an optional decimal value from 1 to 256 that is the length of the data provided. If you use register notation, the register contains the length itself rather than the address of the length. This parameter is mutually exclusive with the SDBLENVAR parameter, and is valid with SDBSTRING only.

,SDBLENVAR=SDB variable

Specifies the address of an optional halfword that contains the length of the data provided. The length of the data must be from 1 to 256 bytes. This parameter is mutually exclusive with the SDBLEN parameter, and is valid with SDBSTRING only.

,DATA=data

Specifies the address of the area that contains the data associated with the key specified by the SDBKEY parameter. DATA is required with SDBKEY only.

,LEN=data length

Specifies an optional decimal value from 1 to 13 that is the length of the data provided. If you use register notation, the register contains the length itself rather than the address of the length. This parameter is mutually exclusive with the LENVAR parameter, and is valid with DATA only.

,LENVAR=data variable

Specifies the address of an optional halfword that contains the length of the data provided. The length of the data must be from 1 to 13 bytes. This parameter is mutually exclusive with the LEN parameter, and is valid with DATA only.

SYMRBLD macro

,CONVERT=YES

,CONVERT=NO

Indicates that one to four bytes of binary data specified by the DATA parameter should be converted to hexadecimal representation in EBCDIC. If the length of the binary data is greater than four bytes, the results of the conversion are unpredictable.

If CONVERT is specified with the user abend code SDB key, SDBAB_U, the binary data is converted to decimal EBCDIC.

The default is CONVERT=NO. CONVERT is valid with DATA only.

,TYPE=TEST

,TYPE=NOTEST

Specifies whether code is generated to test if the data fits in the symptom record before storing the data. TYPE=NOTEST indicates that the data and key are unconditionally moved into the symptom record.

The default is TYPE=TEST.

Syntax with SECONDARY option

The standard form of the SYMRBLD macro with the SECONDARY option is written as follows:

Syntax	Description
<i>name</i>	<i>name</i> : Symbol. Begin <i>name</i> in column 1.
␣	One or more blanks must precede SYMRBLD.
SYMRBLD	
␣	One or more blanks must follow SYMRBLD.
SECONDARY	
,SR= <i>storage addr</i>	<i>storage addr</i> : RX-type address or address in register (2)-(12).
,SDBSTRING= <i>SDB string</i>	<i>SDB string</i> : RX-type address or address in register (2)-(12).
,SDBKEY= <i>SDB key</i>	<i>SDB key</i> : SDB key name, or SDB key literal in single quotation marks. See the parameter description for a list of valid SDB key names and literals.
	Note: You must code either SDBSTRING or SDBKEY or both.
,SDBLEN= <i>SDB length</i>	<i>SDB length</i> : Decimal digit 1-256, or register (2)-(12).

Syntax	Description
,SDBLENVAR= <i>SDB variable</i>	<i>SDB variable</i> : RX-type address or address in register (2)-(12). Note: 1. If you use register notation for <i>SDB length</i> , the register contains the length itself rather than the address of the length. 2. SDBLEN (or SDBLENVAR) is valid with SDBSTRING only.
,DATA= <i>data</i>	<i>data</i> : RX-type address or address in register (2)-(12). Note: DATA is required with SDBKEY only.
,LEN= <i>data length</i>	<i>data length</i> : Decimal digit 1-13, or register (2)-(12).
,LENVAR= <i>data variable</i>	<i>data variable</i> : RX-type address or address in register (2)-(12). Note: 1. If you use register notation for <i>data length</i> , the register contains the length itself rather than the address of the length. 2. LEN (or LENVAR) is valid with DATA only.
,CONVERT=YES	Default: CONVERT=NO
,CONVERT=NO	Note: CONVERT is valid with DATA only.
,TYPE=TEST ,TYPE=NOTEST	Default: TYPE=TEST

Parameters with SECONDARY option

The parameters for SYMRBLD SECONDARY are explained as follows:

SECONDARY

Indicates that the symptom data provided is concatenated to section 4, the secondary symptom string. The secondary symptom string is an EBCDIC character string of problem symptoms, SDB key/data pairs. The purpose of the secondary symptom string is to save diagnostic data at the time of the error. This data may not be duplicated for each instance of the problem.

The suggested minimum list of symptoms includes:

- Module assembly level - LVLS/aaa
- Field name related to the error and contents - FLDS/av10 VALU/Cav8

Binary and hex data can be provided with the VALU/B and VALU/H keys.

Note: The following restrictions apply to symptoms in the secondary symptom string:

- The symptom data cannot contain imbedded blanks. The '#' is used to substitute for desired blanks.
- The total length of each symptom (key/data) may not exceed 15 characters. The symptom length includes the SDB key, a slash, and the EBCDIC data. Remember that hexadecimal data doubles in length when converted to hexadecimal representation in EBCDIC.

,SR=storage addr

Specifies the address of the storage area, on a doubleword boundary, used for the symptom record. This is the same storage area you specified on SYMRBLD INITIAL. If you do not specify SR with SYMRBLD SECONDARY, the default is to use the storage area address you placed in register 1.

,SDBSTRING=SDB string

Specifies the address of an optional character input string to be added to the secondary symptom string. The data is a list of symptoms separated by a blank. A symptom is an SDB key followed by a slash and EBCDIC data.

You must code either SDBSTRING or SDBKEY or both. When you code both on the same macro, the data provided with the SDBSTRING parameter is put into the symptom string first.

,SDBKEY=SDB key

Specifies an optional name from the set of SDB keys. You can provide the SDB key name, or specify the SDB key literal in single quotation marks (for example, specify either SDBKEY=SDBAB_S, or SDBKEY='AB/S'). See [Table 58 on page 960](#) for valid SDB key names and literals.

You must code either SDBSTRING or SDBKEY or both. When you code both on the same macro, the data provided with the SDBSTRING parameter is put into the symptom string first.

,SDBLEN=SDB length

Specifies an optional decimal value from 1 to 256 that is the length of the data provided. If you use register notation, the register contains the length itself rather than the address of the length. This parameter is mutually exclusive with the SDBLENVAR parameter, and is valid with SDBSTRING only.

,SDBLENVAR=SDB variable

Specifies the address of an optional halfword that contains the length of the data provided. The length of the data must be from 1 to 256 bytes. This parameter is mutually exclusive with the SDBLEN parameter, and is valid with SDBSTRING only.

,DATA=data

Specifies the address of the area that contains the data associated with the key specified by the SDBKEY parameter. DATA is required with SDBKEY only.

,LEN=data length

Specifies an optional decimal value from 1 to 13 that is the length of the data provided. If you use register notation, the register contains the length itself rather than the address of the length. This parameter is mutually exclusive with the LENVAR parameter, and is valid with DATA only.

,LENVAR=data variable

Specifies the address of an optional halfword that contains the length of the data provided. The length of the data must be from 1 to 13 bytes. This parameter is mutually exclusive with the LEN parameter, and is valid with DATA only.

,CONVERT=YES**,CONVERT=NO**

Indicates that one to four bytes of binary data specified by the DATA parameter should be converted to hexadecimal representation in EBCDIC. If the length of the binary data is greater than four bytes, the results of the conversion are unpredictable.

If CONVERT is specified with the user abend code SDB key, SDBAB_U, the binary data is converted to decimal EBCDIC.

The default is CONVERT=NO. CONVERT is valid with DATA only.

,TYPE=TEST**,TYPE=NOTEST**

Specifies whether code is generated to test if the data fits in the symptom record before storing the data. TYPE=NOTEST indicates that the data and key are unconditionally moved into the symptom record.

The default is TYPE=TEST.

Syntax with VARIABLE option

The standard form of the SYMRBLD macro with the VARIABLE option is written as follows:

Syntax	Description
<i>name</i>	<i>name</i> : Symbol. Begin <i>name</i> in column 1.
␣	One or more blanks must precede SYMRBLD.
SYMRBLD	
␣	One or more blanks must follow SYMRBLD.
VARIABLE	
,SR= <i>storage addr</i>	<i>storage addr</i> : RX-type address or address in register (2)-(12).
,S5KEY= <i>5key</i>	<i>5key</i> : Section 5 key name, or section 5 key literal in single quotation marks. See the parameter description for valid section 5 key names and literals.
,DATA= <i>data</i>	<i>data</i> : RX-type address or address in register (2)-(12).
,LEN= <i>data length</i>	<i>data length</i> : Decimal digit 1-256, or register (2)-(12).
,LENVAR= <i>data variable</i>	<i>data variable</i> : RX-type address or address in register (2)-(12). Note: If you use register notation for <i>data length</i> , the register contains the length itself rather than the address of the length.
,TYPE=NOTEST	Default: TYPE=TEST
,TYPE=TEST	

Parameters with VARIABLE option

The parameters for SYMRBLD VARIABLE are explained as follows:

VARIABLE

Indicates that the symptom data provided is concatenated to section 5, the variable data section. The variable data section is in key/length/data format. The purpose of the variable data section is to provide additional serviceability data for debugging. Examples of serviceability data are a parameter list, a text description of the problem, or a portion of a data area.

Syntax	Description
COMPLETE	
,SR= <i>storage addr</i>	<i>storage addr</i> : RX-type address or address in register (2)-(12).
,INVOKE=YES	Default: INVOKE=YES
,INVOKE=NO	
,RETCODE= <i>return code</i>	<i>return code</i> : RX-type address or address in register (2)-(12). Note: RETCODE is valid with INVOKE=YES only.
,RSNCODE= <i>reason code</i>	<i>reason code</i> : RX-type address or address in register (2)-(12). Note: RSNCODE is valid with INVOKE=YES only.

Parameters with COMPLETE option

The parameters for SYMRBLD COMPLETE are explained as follows:

COMPLETE

Indicates that the symptom record is complete, and is ready to be written to the logrec data set.

SYMRBLD COMPLETE is required before the symptom record can be successfully written to the logrec data set.

,SR=*storage addr*

Specifies the address of the storage area, on a doubleword boundary, used for the symptom record. This is the same storage area you specified on SYMRBLD INITIAL. If you do not specify SR with SYMRBLD COMPLETE, the default is to use the storage area address you placed in register 1.

,INVOKE=NO

,INVOKE=YES

Indicates whether to invoke the SYMREC macro that writes the symptom records out to the logrec data set. For unauthorized programs, your installation controls which programs can write symptom records and whether to write the symptom record to the logrec data set, the job log, both or neither through an installation-written exit. This exit is called ASREXIT. For more information about ASREXIT, see [z/OS MVS Installation Exits](#). Records written for authorized programs always go to the logrec data set.

The default is INVOKE=YES.

,RETCODE=*return code*

Specifies the location where the system is to store the return code from the SYMREC macro. (The SYMRBLD macro does not itself generate any return codes.) RETCODE is valid with INVOKE=YES only. The return code is also in general purpose register (GPR) 15 if you code INVOKE=YES.

,RSNCODE=*reason code*

Specifies the location where the system is to store the reason code from the SYMREC macro. (The SYMRBLD macro does not itself generate any reason codes.) RSNCODE is valid with INVOKE=YES only. The reason code is also in GPR 0 if you code INVOKE=YES.

ABEND codes with COMPLETE option

None.

Return and reason codes (for SYMRBLD COMPLETE, INVOKE=YES)

The SYMRBLD macro itself does not generate any return codes. However, if you specify INVOKE=YES on SYMRBLD COMPLETE (or take the default), you can receive return codes and reason codes from the SYMREC macro. The return code from SYMREC is in GPR 15 (and *return code* if you coded RETCODE); the reason code from SYMREC is in GPR 0 (and *reason code* if you coded RSNCODE). See [“Return and reason codes”](#) on page 973 for a list of return codes from the SYMREC macro.

Syntax with RESET option

The standard form of the SYMRBLD macro with the RESET option is written as follows:

Syntax	Description
<i>name</i>	<i>name</i> : Symbol. Begin <i>name</i> in column 1.
␣	One or more blanks must precede SYMRBLD.
SYMRBLD	
␣	One or more blanks must follow SYMRBLD.
RESET	
,SR= <i>storage addr</i>	<i>storage addr</i> : RX-type address or address in register (2)-(12).
,PRIMLEN= <i>primary length</i>	<i>primary length</i> : Decimal digit, RX-type address, or address in register (2)-(12).
,SECLLEN= <i>secondary length</i>	<i>secondary length</i> : Decimal digit, RX-type address, or address in register (2)-(12).
,VARLEN= <i>variable length</i>	<i>variable length</i> : Decimal digit, RX-type address, or address in register (2)-(12).

Parameters with RESET option

The parameters for SYMRBLD RESET are explained as follows:

RESET

Rebuilds the symptom record using the same storage area and application information that was specified using the INITIAL parameter. This is useful when the primary, secondary, and variable sections of the symptom record are to be changed but the application information in section 2.1 remains the same.

,SR=storage addr

Specifies the address of the storage area, on a doubleword boundary, used for the symptom record. This is the same storage area you specified on SYMRBLD INITIAL. The storage area must reside in the primary address space.

The maximum size of the symptom record is 1900 bytes. Sections 1, 2, and 2.1 use 212 bytes of the total 1900 bytes. Sections 3, 4, and 5 use the remaining 1688 bytes. In addition to providing storage for the symptom record, 100 bytes must be provided for a work area; therefore, the maximum amount of storage needed is 2000 bytes.

Use the PRIMLEN, SECLen, and VARLEN parameters to specify the length of sections 3, 4, and 5 respectively.

,PRIMLEN=primary length

Specifies the address of an optional halfword input variable that contains the maximum length in bytes of the primary symptom string. You can also directly specify a decimal digit for the length (for example, PRIMLEN=900). If you use register notation, the register contains the address of the length rather than the length itself.

The following formula calculates the length of the primary symptom string:

```
Lengths of all SDBKEYs + length of all data provided with
the DATA keyword + the number of times SDBKEY is specified
+ the length of all data specified with the SDBSTRING keyword
+ the number of times the SDBSTRING keyword is provided.
```

Note that this field cannot be zero and the maximum size of the entire symptom record is 1900 bytes.

If you do not specify PRIMLEN, the length of the primary symptom string will not change from the length you specified on SYMRBLD INITIAL, or on a previous SYMRBLD RESET.

,SECLen=secondary length

Specifies the address of an optional halfword input variable that contains the maximum length in bytes of the secondary symptom string. You can also directly specify a decimal digit for the length (for example, SECLen=900). If you use register notation, the register contains the address of the length rather than the length itself.

The following formula calculates the length of the secondary symptom string:

```
Lengths of all SDBKEYs + length of all data provided with
the DATA keyword + the number of times SDBKEY is specified
+ the length of all data specified with the SDBSTRING keyword
+ the number of times the SDBSTRING keyword is provided.
```

Note that the maximum size of the entire symptom record is 1900 bytes.

If you do not specify SECLen, the length of the secondary symptom string will not change from the length you specified on SYMRBLD INITIAL, or on a previous SYMRBLD RESET.

,VARLEN=variable length

Specifies the address of an optional halfword input variable that contains the maximum length in bytes of the variable data section. You can also directly specify a decimal digit for the length (for example, VARLEN=900). If you use register notation, the register contains the address of the length rather than the length itself.

The following formula calculates the length of the variable data section:

```
The length provided must be the total length of the variable data items
+ the number of items (x) 4.
```

(The 4 is for the 2 byte key + 2 bytes for the length.) Note that the maximum size of the entire symptom record is 1900 bytes.

If you do not specify VARLEN, the length of the variable data section will not change from the length you specified on SYMRBLD INITIAL, or on a previous SYMRBLD RESET.

Example

The following is an example of invoking SYMRBLD to build a symptom record:

- SYMRBLD INITIAL initializes sections 1 and 2 of the symptom record and provides component data for section 2.1.
- SYMRBLD PRIMARY stores the following primary symptom string data:
 - Program return code: PRCS/00028878
 - CSECT name: RIDS/ABE5698J
 - Load module name: RIDS/ABD5698J#L

Note: The symptom PIDS/ABE5698J is automatically placed as the first symptom in the primary symptom string.
- SYMRBLD SECONDARY stores the following secondary symptom string data:
 - Module assembly level: LVLS/C20
 - Field name: FLDS/COUNTER
 - Value: VALU/HFFFFFFF
- SYMRBLD VARIABLE stores additional data that can be used for debugging in section 5 of the symptom record.
- SYMRBLD COMPLETE indicates that the record is complete. INVOKE=YES indicates that the record is written to the logrec data set. by the SYMREC macro.

```

SYMRBLD INITIAL,SR=SREC,
          PRIMLEN=100,SECLN=50,VARLEN=50,
          ARCHLEV=10,COMPDS=MYCOMP,
          PROGRAM=PROGNAME,PROGLEV=REL6,
          PROBLEM=MYPROB,
          SERVLN=MYSERV

SYMRBLD PRIMARY,SDBSTRING=S1_DATA

SYMRBLD SECONDARY,SDBSTRING=S2_DATA,SDBKEY=SDBVALU_H,
          DATA=COUNTER,CONVERT=YES

SYMRBLD VARIABLE,S5KEY=S5HEX,DATA=MYVARDAT

SYMRBLD COMPLETE,INVOKE=YES

SREC      DS      CL600
MYCOMP    DC      CL13 'COMPONENT XXX'
MYPROB    DC      CL14 'DATABASE ERROR'
MYSERV    DC      CL9  'VERSION 1'
PROGNAME  DC      CL8  'ABE5698J'
REL6      DC      CL3  'REL6'
S1_DATA   DC      CL43 'PRCS/00028878 RIDS/ABE5698J RIDS/ABD5698J#L'
S2_DATA   DC      CL22 'LVLS/C20 FLDS/COUNTER'
MYVARDAT  DC      XL2  '01E4'
COUNTER   DC      X'FFFFFFF'

```

Chapter 101. SYMREC – Process a symptom record

Description

The SYMREC macro updates a symptom record with system environment information and then logs the symptom record in the logrec data set. The symptom record is a data area in the user's application that has been mapped by the ADSR mapping macro.

As an application detects errors during execution, it stores diagnostic information into the symptom record and issues the SYMREC macro to log the record. The diagnostic information consists of a description of a programming failure and a description of the environment in which the failure occurred.

When the SYMREC macro is invoked, it checks that all the required input fields of the ADSR symptom record are set by the caller. If the required input fields are not set, SYMREC issues appropriate return and reason codes.

The SYMREC macro can be used for authorized and unauthorized programs. Your installation controls which programs can write symptom records and whether to write the symptom record to the logrec data set, the job log, both or neither through an installation-written exit. This exit is called ASREXIT. For further information about ASREXIT, see *z/OS MVS Installation Exits*. SYMRBLD is a related macro. For more information see *z/OS MVS Programming: Assembler Services Guide*.

Environment

The requirements for the caller are:

Environmental factor	Requirement
Minimum authorization:	Problem state, and any PSW key.
Dispatchable unit mode:	Task or SRB
Cross memory mode:	Any PASN, any HASN, any SASN
AMODE:	24- or 31-bit
ASC mode:	Primary
Interrupt status:	Enabled or disabled for I/O and external interrupts. If disabled, the input data to SYMREC must be in fixed storage or in disabled reference (DREF) storage.
Locks:	The caller may hold locks, but is not required to hold any.
Control parameters:	Must be in the primary address space.

Programming requirements

The caller must include the ADSR mapping macro to map the symptom record specified on the SR parameter. The caller must fill in this symptom record. For more information on the ADSR mapping macro, see *z/OS MVS Data Areas* in the *z/OS Internet library* (www.ibm.com/servers/resourcelink/svc00100.nsf/pages/zosInternetLibrary).

Restrictions

Although callers in 24-bit or 31-bit addressing mode can issue the SYMREC macro, the addresses passed to the SYMREC service must be 31-bit addresses.

Input register information

The SYMREC macro is sensitive to the SYSSTATE macro with the OSREL parameter

- If the caller has issued the SYSSTATE macro with the OSREL=ZOSV1R6 parameter (Version 1 Release 6 of z/OS or later) before issuing the SYMREC macro, the caller does not have to place any information into any general purpose register (GPR) unless using it in register notation for a particular parameter, or using it as a base register.
- Otherwise, the caller must ensure that the following general purpose register contains the specified information:

Register Contents

13

The address of an 18-word save area

Output register information

When control returns to the caller, the general purpose registers (GPRs) contain:

Register Contents

0

Reason code

1

Used as a work register by the system

2-13

Unchanged

14

Used as a work register by the system

15

Return code

When control returns to the caller, the access registers (ARs) contain:

Register Contents

0-1

Used as work registers by the system

2-13

Unchanged

14-15

Used as work registers by the system

Some callers depend on register contents remaining the same before and after issuing a service. If the system changes the contents of registers on which the caller depends, the caller must save them before issuing the service, and restore them after the system returns control.

Performance implications

None.

Syntax

The standard form of the SYMREC macro is written as follows:

Syntax	Description
<i>name</i>	<i>name</i> : Symbol. Begin <i>name</i> in column 1.
␣	One or more blanks must precede SYMREC.
SYMREC	
␣	One or more blanks must follow SYMREC.
SR= <i>addr</i>	<i>addr</i> : A-type address or register 2-12.

Parameters

The parameters are explained as follows:

SR=*addr*

Specifies the address of the symptom record. The SR parameter is required.

ABEND codes

None.

Return and reason codes

When SYMREC returns control, registers 15 and 0 contain the following hexadecimal return codes and reason codes, respectively:

Hexadecimal Return Code	Hexadecimal Reason Code	Meaning and Action
0000	0000	Meaning: SYMREC completed successfully and the symptom record was recorded. Action: None.
0004	0164	Meaning: Program error. An attempt to write section 1 information from the completed symptom record failed. The area was not accessible to a write request. The entire input record was recorded. Action: Make sure that the storage containing the input symptom record is not released before the SYMREC request completes.

Hexadecimal Return Code	Hexadecimal Reason Code	Meaning and Action
0008	0158	<p>Meaning: Program error. The total length of the input symptom record exceeds the maximum. A partial symptom record was recorded.</p> <p>Action: Correct the length of the symptom record. The maximum length of the symptom record is 1900 bytes. Sections 1, 2, and 2.1 of the symptom record are fixed in length. The length of sections 1, 2, and 2.1 combined is 212 bytes. Therefore, the combined length of sections 3, 4, and 5 must be less than or equal to 1688 bytes.</p>
0008	015C	<p>Meaning: Program error. Optional segments of the input symptom record were not accessible. The record includes the accessible entries of the input symptom record. A partial symptom record was recorded.</p> <p>Action: Verify that all optional sections (sections 4 and 5) of the symptom record are accessible.</p>
000C	0104	<p>Meaning: Program error. The first 2 bytes of the input symptom record do not contain the SR operand. No symptom record was recorded.</p> <p>Action: Verify that the correct address for the input symptom record was provided to the SYMREC service and that the first 2 bytes of the symptom record contain 'SR'.</p>
000C	0108	<p>Meaning: Program error. The input symptom record does not contain the required entries for section 2. No symptom record was recorded.</p> <p>Action: Make sure the following fields have been supplied in section 2 of the symptom record: the length of section 2 and the length/offset of section 2.1 and 3.</p>
000C	010C	<p>Meaning: Program error. The input symptom record does not contain the required entries for section 2.1. No symptom record was recorded.</p> <p>Action: Make sure the following fields have been supplied in section 2.1 of the symptom record: section 2.1 identifier, architecture level of the symptom record, and the component release level or PID release level. Also verify that the length of section 2.1 is correct in section 2.</p>
000C	0114	<p>Meaning: Program error. The input symptom record does not contain the required entries for section 3. No symptom record was recorded.</p> <p>Action: Make sure that the primary symptom string contains at least one symptom.</p>
000C	0128	<p>Meaning: Program error. This reason code is set when the input symptom record cannot be referenced. No symptom record was recorded.</p> <p>Action: Verify that the correct address for the symptom record was provided to the SYMREC macro and that this storage is accessible.</p>

Hexadecimal Return Code	Hexadecimal Reason Code	Meaning and Action
000C	012C	<p>Meaning: Program error. All required sections of the symptom record could not be referenced. No symptom record was recorded.</p> <p>Action: Verify that all required sections (sections 1, 2, 2.1 and 3) of the symptom record are accessible.</p>
000C	0134	<p>Meaning: Program error. The input symptom record address is in non-accessible storage. No symptom record was recorded.</p> <p>Action: Verify the input parameter list provided to the SYMREC request.</p>
000C	0144	<p>Meaning: Program error. No symptom record was recorded. One of the following occurred:</p> <ul style="list-style-type: none"> The caller is in cross memory mode and the home address space is not accessible because it is swapped out or going through address space termination. <p>Action: Make sure that the home address space is non-swappable during the SYMREC request. An address space can be made non-swappable using the SYSEVENT macro.</p> <ul style="list-style-type: none"> The caller is disabled, but it did not obtain MVS-recognized (valid) disablement. Valid disablement is obtained through a SETLOCK OBTAIN,TYPE=CPU request, available to supervisor state and key 0 callers only. <p>Action: Use the SETLOCK OBTAIN, TYPE=CPU to disable normally.</p>
000C	0F1C	<p>Meaning: Program error. The installation exit ASREXIT prevented the unauthorized caller from writing the symptom record to the logrec data set. No symptom record was recorded.</p> <p>Action: None. The installation has decided that unauthorized programs cannot write to the logrec data set.</p>
0010	0F04	<p>Meaning: Environmental error. There was insufficient space in the LOGREC buffer to accommodate the symptom record. No symptom record was recorded.</p> <p>Action: The request might be successful if retried. If the problem persists, record the return and reason code and supply it to the appropriate system support personnel.</p>
0010	0F08	<p>Meaning: System error. The SYMREC service could not acquire storage for a work area or a copy of the symptom record. No symptom record was recorded.</p> <p>Action: The request might be successful if retried. If the problem persists, record the return and reason code and supply it to the appropriate system support personnel.</p>

Hexadecimal Return Code	Hexadecimal Reason Code	Meaning and Action
0010	0F0C	Meaning: System error. Failure occurred while the symptom record was being moved to the LOGREC buffer. No symptom record was recorded. Action: Record the return and reason code and supply it to the appropriate IBM support personnel.
0010	0F10	Meaning: System error. The SYMREC service has a logic error. No symptom record was recorded. Action: Record the return and reason code and supply it to the appropriate IBM support personnel.
0010	0F14	Meaning: System error. The SYMREC service has shut itself down. It has exceeded the maximum allowable logic errors for the service routine. No symptom record was recorded. Action: Record the return and reason code and supply it to the appropriate IBM support personnel.
0010	0F18	Meaning: System error. The SYMREC service has shut itself down. It has exceeded the maximum allowable incomplete SYMREC requests for processing. No symptom record was recorded. Action: Record the return and reason code and supply it to the appropriate IBM support personnel.
0014	—	Meaning: System error. SYMREC is not operable. Action: Record the return and reason code and supply it to the appropriate IBM support personnel.

SYMREC—List form

Use the list form of the SYMREC macro together with the execute form of the macro for applications that require reentrant code. The list form of the macro defines an area of storage, which the execute form of the macro uses to store the parameters.

Syntax

The list form of the SYMREC macro is written as follows:

Syntax	Description
<i>name</i>	<i>name</i> : Symbol. Begin <i>name</i> in column 1.
␣	One or more blanks must precede SYMREC.
SYMREC	
␣	One or more blanks must follow SYMREC.

Syntax	Description
SR= <i>addr</i>	<i>addr</i> : A-type address (31 bit).
,MF=(L)	

Parameters

The parameters are explained under the standard form of the SYMREC macro with the following exception:

,MF=L

Specifies the list form of the SYMREC macro.

SYMREC - Execute form

Use the execute form of the SYMREC macro together with the list form of the macro for applications that require reentrant code. The execute form of the macro stores the parameters into the storage area defined by the list form.

Syntax

The execute form of the SYMREC macro is written as follows:

Syntax	Description
<i>name</i>	<i>name</i> : Symbol. Begin <i>name</i> in column 1.
␣	One or more blanks must precede SYMREC.
SYMREC	
␣	One or more blanks must follow SYMREC.
SR= <i>addr</i>	<i>addr</i> : A-type address (31 bit) or register 2-12. <i>addr</i> : A-type address (31 bit) or register 2-12. <i>addr</i> : A-type address (31 bit) or register 2-12.
,MF=(E, <i>list addr</i>)	<i>list addr</i> : RX-type address or register 2-12.

Parameters

The parameters are explained under the standard form of the SYMREC macro with the following exception:

SYMREC macro

,MF=(E,*list addr*)

Specifies the execute form of the SYMREC macro. This form uses a remote parameter list.

Chapter 102. SYNCH and SYNCHX – Take a synchronous exit to a processing program

Description

The SYNCH macro allows a program to take a synchronous exit to a processing program. After the processing program has finished, the program that issued the SYNCH macro regains control. The SYNCH macro is intended for use by primary mode programs only. If your program is in access register (AR) mode, use SYNCHX, which provides the same function as SYNCH.

Descriptions of the SYNCH and SYNCHX macro in this information are:

- The standard form of the SYNCH macro, which includes general information about the SYNCH and SYNCHX macros with specific information about the SYNCH macro. The syntax of the SYNCH macro and its parameters are explained.
- The standard form of the SYNCHX macro, which presents information specific to the SYNCHX macro. The topic explains the syntax of the SYNCHX macro and the parameters that are valid only on SYNCHX.
- The list form of the SYNCH and SYNCHX macros.
- The execute form of the SYNCH and SYNCHX macros.

If the caller is in AR mode, the system passes the following values, unchanged, to the processing program:

- ARs 0-13
- Bits 16 and 17 of the current PSW indicating the ASC mode (primary or AR mode, where primary=secondary=home)
- Extended authorization index (EAX)

Parameters for SYNCH and SYNCHX must be in the caller's primary address space. Callers in AR mode must initialize AR 1 to zero before issuing SYNCHX.

Note: The SYNCH and SYNCHX macros have the same environment specifications, register information, programming requirements, restrictions and limitations, performance implications, and return and reason codes described below, except where noted in the explanation for SYNCHX.

Environment

The requirements for the caller are:

Environmental factor	Requirement
Minimum authorization:	Problem state and any PSW key.
Dispatchable unit mode:	Task
Cross memory mode:	PASN=HASN=SASN
AMODE:	24- or 31-bit for SYNCH; 24- or 31- or 64-bit for SYNCHX.
ASC mode:	Primary
Interrupt Status:	Enabled for I/O and external interrupts
Locks:	No locks held
Control parameters:	Must be in the primary address space.

Programming requirements

None.

Restrictions

None.

Input register information

Before issuing the SYNCH(X) macro, the caller does not have to place any information into any register unless using it in register notation for a particular parameter, or using it as a base register.

Output register information

When control returns to the caller, the GPRs contain:

Register Contents

0-1

Values the processing program placed there before it returned to the caller

2-13

If RESTORE=YES, unchanged; if RESTORE=NO, values the processing program placed there before it returned to the caller

14

Used as a work register by the system

15

Value the processing program placed there before it returned to the caller

Some callers depend on register contents remaining the same before and after issuing a service. If the system changes the contents of registers on which the caller depends, the caller must save them before issuing the service, and restore them after the system returns control.

Performance implications

None.

Syntax

The standard form of the SYNCH macro is written as follows:

Syntax	Description
<i>name</i>	<i>name</i> : Symbol. Begin <i>name</i> in column 1.
␣	One or more blanks must precede SYNCH.
SYNCH	
␣	One or more blanks must follow SYNCH.
<i>entry point addr</i>	<i>entry point addr</i> : RX-type address, or register (2) - (12) or (15).

Syntax	Description
,RESTORE=NO	Default: RESTORE=NO
,RESTORE=YES	
,AMODE=24	Default: AMODE=CALLER.
,AMODE=31	Note: AMODE=DEFINED can be specified only
,AMODE=DEFINED	if the entry point address is provided in
,AMODE=CALLER	a register.
,RMODE64=NO	Default: RMODE64=NO
,RMODE64=YES	Note: RMODE64=YES can be specified only with SYNCHX.

Parameters

The parameters are explained as follows:

entry point addr

Specifies the address of the entry point of the processing program to receive control.

,RESTORE=NO

,RESTORE=YES

Specifies whether registers 2-13 are to be restored when control returns to the caller.

,AMODE=24

,AMODE=31

,AMODE=DEFINED

,AMODE=CALLER

Specifies the addressing mode in which the requested program is to receive control.

If AMODE=24 is specified, the requested program will receive control in 24-bit addressing mode.

If AMODE=31 is specified, the requested program will receive control in 31-bit addressing mode.

If AMODE=DEFINED is specified, the user must provide the entry point using a register and not an RX-type address. The requested program will receive control in the addressing mode indicated by the high order bit of the entry point address. If the bit is set to 0, the requested program will receive control in 24-bit addressing mode; if the bit is set to 1, the requested program will receive control in 31-bit addressing mode.

If AMODE=CALLER is specified, the requested program will receive control in the addressing mode of the caller.

,RMODE64=NO

,RMODE64=YES

Specifies whether the residency mode in which the requested program is to receive control is RMODE 64 or not.

When RMODE64=YES, the entry point address in a register is treated as an 8-byte address. An entry point address that is not in a register is treated as 8-bytes.

Return and reason codes

None.

Example 1

Take a synchronous exit to PROGRAMA. Do not restore registers 2-13 when control returns.

```
LOAD EP=PROGRAMA,DCB=LIB1      Load desired program
LR   R8,R0                      Obtain the entry point
SYNCH (R8),RESTORE=NO
```

Example 2

Take a synchronous exit to a program labeled SUBRTN and restore registers 2-13 when control returns.

```
SYNCH SUBRTN,RESTORE=YES
```

Example 3

Take a synchronous exit to the program located at the address given in register 8 and restore registers 2-13 when control returns. Indicate that this program is to execute in 24-bit addressing mode.

```
SYNCH (8),RESTORE=YES,AMODE=24
```

Example 4

Take a synchronous exit to the program located at the address given in register 8 and restore registers 2-13 when control returns. Indicate that this program is to receive control in the addressing mode defined by the high-order bit of its entry point address.

```
SYNCH (8),RESTORE=YES,AMODE=DEFINED
```

Example 5

Take a synchronous exit to the program located at the address given in register 8 and restore registers 2-13 when control returns. Indicate that this program is to receive control in the addressing mode as the caller.

```
SYNCH (8),RESTORE=YES,AMODE=CALLER
```

SYNCHX - Take a synchronous exit to a processing program

The SYNCHX macro provides the same function as the SYNCH macro. All parameters on the SYNCH macro are valid for the SYNCHX macro.

SYNCHX is intended for use by programs running in AR mode.

Note: The SYNCHX macro has the same environment specifications, register information, programming requirements, restrictions and limitations, performance implications, and return and reason codes as the SYNCH macro, except where noted below.

Environment

The SYNCHX macro can be used by callers in AR or primary ASC mode.

Programming requirements

If your program is in AR mode, (1) issue the SYSSTATE ASCENV=AR macro before you issue SYNCHX, and (2) initialize AR 1 to zero.

Register information

When control returns to the caller, the access registers (ARs) contain:

Register Contents

0-13

Unchanged

14-15

Used as work registers by the system

Syntax

The SYNCHX macro is written as follows:

Syntax	Description
<i>name</i>	<i>name</i> : Symbol. Begin <i>name</i> in column 1.
␣	One or more blanks must precede SYNCHX.
SYNCHX	
␣	One or more blanks must follow SYNCHX.
<i>entry point addr</i>	<i>entry point addr</i> : RX-type address, or register (2) - (12) or (15).
,RESTORE=NO	Default: RESTORE=NO
,RESTORE=YES	
,AMODE=24	Default: AMODE=CALLER
,AMODE=31	
,AMODE=64	
,AMODE=DEFINED	Note: AMODE=DEFINED can only be specified if the entry point is provided in a register. AMODE=DEFINED can only be used to SYNCHX to amode 24 and amode 31 programs.
,AMODE=CALLER	

Parameters

The parameters are described under the syntax of the standard form of the SYNCH macro. If AMODE=64 is specified, the requested program will receive control in 64-bit addressing mode.

SYNCH and SYNCHX—List form

The list form of the SYNCH or SYNCHX macro is used to construct a control parameter list.

Syntax

The list form of the SYNCH or SYNCHX macro is written as follows:

Syntax	Description
<i>name</i>	<i>name</i> : Symbol. Begin <i>name</i> in column 1.
␣	One or more blanks must precede SYNCH or SYNCHX.
SYNCH SYNCHX	
␣	One or more blanks must follow SYNCH or SYNCHX.
,RESTORE=NO	Default: RESTORE=NO
,RESTORE=YES	
,AMODE=24	Default: AMODE=CALLER
,AMODE=31	
,AMODE=DEFINED	
,AMODE=CALLER	
,MF=L	

Parameters

The parameters are explained under the standard form of the SYNCH macro, with the following exception:

,MF=L

Specifies the list form of the SYNCH or SYNCHX macro.

Example

Use the list form of the SYNCH macro to specify that registers 2-13 are to be restored when control returns from executing the SYNCH macro and that the addressing mode of the program is to be defined by the high-order bit of the entry point address. Assume that the execute form of the macro specifies the program address.

```
SYNCH ,RESTORE=YES,AMODE=DEFINED,MF=L
```

SYNCH and SYNCHX—Execute form

The execute form of the SYNCH or SYNCHX macro uses a remote control-program parameter list that can be generated by the list form of SYNCH or SYNCHX.

Syntax

The execute form of the SYNCH or SYNCHX macro is written as follows:

Syntax	Description
<i>name</i>	<i>name</i> : Symbol. Begin <i>name</i> in column 1.
␣	One or more blanks must precede SYNCH or SYNCHX.
SYNCH SYNCHX	
␣	One or more blanks must follow SYNCH or SYNCHX.
<i>entry point addr</i>	<i>entry point addr</i> : RX-type address, or register (2) - (12) or (15).
,RESTORE=NO	
,RESTORE=YES	
,AMODE=24	
,AMODE=31	Note: AMODE=DEFINED can be specified only if the
,AMODE=DEFINED	entry point address is provided in a register.
,AMODE=CALLER	
,MF=(E, <i>ctrl addr</i>)	<i>ctrl addr</i> : RX-type address or register (1), (2) - (12).

Parameters

The parameters are explained under the standard form of the SYNCH macro, with the following exception:

,MF=(E,*ctrl addr*)

Specifies the execute form of the SYNCH or SYNCHX macro.

Example

Use the execute form of the SYNCH macro to take a synchronous exit to the program located at the address given in register 8 and restore registers 2-13 when control returns. Indicate that the program is

SYNCH and SYNCHX macros

to receive control in the same addressing mode as the caller and that the parameter list is located at SYNCHL2.

```
SYNCH (8),RESTORE=YES,AMODE=CALLER,MF=(E,SYNCHL2)
```

Chapter 103. SYSEVENT – System event

Description

The SYSEVENT macro provides the interface to the system resource manager (SRM). Using SYSEVENT mnemonics, you can notify SRM of an event or ask SRM to perform a specific function. Out of the many different SYSEVENTs, only the following ones are unauthorized:

- FREEAUX
- QVS
- REQFASD
- REQLPDAT with ENTRY=UNAUTHPC option
- QRYCONT with ENTRY=UNAUTHPC option

See *z/OS MVS Programming: Authorized Assembler Services Reference SET-WTO* for more information on these unauthorized SYSEVENTs, as well as all of the authorized SYSEVENTs.

Chapter 104. SYSSTATE – Identify system state

Description

Use the SYSSTATE macro to generate code that is correct for the environment in which the program will run. Some macros need to know one or more of the following characteristics about that environment:

- The addressing mode (AMODE) at the time the macro is issued
- The residency mode (RMODE) at the time the macro is issued
- The ASC mode of the program at the time the macro is issued
- The architectural level in which the program will run at the time the macro is issued
- The earliest release level that the program will run on at the time the macro is issued

For those macros that are sensitive to their environment, SYSSTATE identifies the environment. During the assembly stage, SYSSTATE sets one or more of the following:

- Global character symbol &SYSAM64, to identify the AMODE
- Global character symbol &SYSRM64 to identify the RMODE
- Global character symbol &SYSASCE, to identify the ASC mode
- Global arithmetic symbol &SYSALVL, to identify the Architectural level
- Global character symbols &SYSOSREL and &SYSOSREL_NAME, to identify the release level

Later, when the program is assembled, the macros check the global symbol(s) and generate the correct code.

IBM recommends that you issue the SYSSTATE macro before issuing other macros. Once a program has issued SYSSTATE, there is no need to reissue it unless the program switches from one ASC mode to another, or from one AMODE to another, or has code paths that are isolated according to architecture level or z/OS release. If you switch AMODE or ASC mode or to a different architecture code path or a different z/OS release code path, you should issue SYSSTATE immediately after the switch to indicate the new state. Without this information, the system assumes the macro is issued:

- In AMODE other than 64-bit
- In RMODE other than 64-bit
- In primary ASC mode
- In ESA/390 architectural level
- Prior to z/OS V1R6

Also, it is recommended that:

- If you know that your program will run on or after a particular release of z/OS, use SYSSTATE with the OSREL parameter.
- If you know that your program will run on or after the release of z/OS that provided the SYSSTATE macro with which you are assembling, use SYSSTATE with OSREL=SYSSTATE.
- When using SYSSTATE with OSREL, use SYSSTATE ARCHLVL=OSREL, as that will set the ARCHLVL accordingly.

Another way to use the SYSSTATE macro is within a macro you write yourself. For example, you can issue SYSSTATE with the TEST parameter to ensure that the &SYSASCE global symbol has been set:

1. Define the &SYSASCE global symbol within your macro.
2. Issue SYSSTATE TEST, which sets &SYSASCE to the default if it has not yet been set.
3. Define different logical paths within your macro to correspond to the ASC mode that is in effect based on the value of &SYSASCE.

SYSSTATE macro

A program need use SYSSTATE TEST only when it wants to query the value of one of the variables. When setting variables (i.e., not SYSSTATE TEST), you can specify one or more of the parameters available. The variables associated with not-specified variables remain unchanged.

Environment

The requirements for the caller are:

Environmental factor	Requirement
Minimum authorization:	Problem state, and any PSW key.
Dispatchable unit mode:	Task or SRB
Cross memory mode:	Any PASN, any HASN, any SASN
AMODE:	24- or 31- or 64-bit
ASC mode:	Primary or AR
Interrupt status:	Enabled or disabled for I/O and external interrupts
Locks:	The caller may hold locks, but is not required to hold any.
Control parameters:	None.

Programming requirements

None.

Restrictions

None.

Input register information

Before issuing the SYSSTATE macro, the caller does not have to place any information into any register unless using it in register notation for a particular parameter, or using it as a base register.

Output register information

When control returns to the caller, the general purpose registers (GPRs) contain the following information:

Register Contents

0-15
Unchanged

When control returns to the caller, the access registers (ARs) contain:

Register Contents

0-15
Unchanged

Performance implications

None.

Syntax

The SYSSTATE macro is written as follows:

Syntax	Description
<i>name</i>	<i>name</i> : Symbol. Begin <i>name</i> in column 1.
␣	One or more blanks must precede SYSSTATE.
SYSSTATE	
␣	One or more blanks must follow SYSSTATE.
TEST	
ASCENV= <u>P</u>	Default: ASCENV=P
ASCENV=AR	
AMODE64= <u>NO</u>	Default: AMODE64=NO
AMODE64=YES	
RMODE64= <u>NO</u>	Default: RMODE64=NO
RMODE64=YES	
ARCHLVL= <u>0</u>	Default: ARCHLVL=0
ARCHLVL=1	
ARCHLVL=2	
ARCHLVL=3	
ARCHLVL=4	
ARCHLVL=5	
ARCHLVL=6	
ARCHLVL=7	
ARCHLVL=OSREL	
OSREL= <i>osrel</i>	
PUSH	
POP	

Parameters

The parameters are explained as follows:

TEST

TEST checks each one of the global symbols &SYSASCE, &SYSAM64, and &SYSALVL, and does the following for each as required:

- Sets the global symbol to its default, if the global symbol **does not** contain a value indicating that it had been set by a prior SYSSTATE macro.
- Leaves the global symbol unchanged, if the global symbol **does** contain a value indicating that you issued a specific SYSSTATE during this assembly.

ASCENV=P

ASCENV=AR

Indicates your program's ASC mode by setting the global symbol &SYSASCE.

- ASCENV=P indicates that the program is in primary mode.
- ASCENV=AR indicates that the program is in AR mode.

AMODE64=NO

AMODE64=YES

Indicates whether your program is AMODE 64 at this point. It sets the global symbol &SYSAM64.

- AMODE64=YES should be specified for any part of your program that runs in AMODE 64. Some macros process differently according to this specification. For example, macros such as ATTACHX, CALL, LINKX, LOAD, and XCTLX build parameter lists consisting of 8-byte entries when SYSSTATE AMODE64=YES.
- AMODE64=NO should be specified for programs, or parts of programs, that do not run in AMODE 64.

ARCLVL=0

ARCLVL=1

ARCLVL=2

ARCLVL=3

ARCLVL=4

ARCLVL=5

ARCLVL=6

ARCLVL=OSREL

Indicates the architectural level of the system for which the subsequent section of your program is designed by setting the global symbol &SYSALVL.

0

Means that the architecture is ESA/390. When bit CVTOS390_R10 in byte CVTOSLV2 of the CVT data area is off, your program should not assume that ARCLVL=1 or ARCLVL=2 capabilities are available.

1

Means that the architecture is ESA/390. When bit CVTOS390_R10 in byte CVTOSLV2 of the CVT data area is on, ARCLVL=1 capabilities are available.

2

Means that the architecture is z/Architecture. Macros that pay attention to ARCLVL will avoid generating z/Architecture instructions when ARCLVL < 2 is in effect. When byte FLCARCH in the PSA data area is not zero, ARCLVL=1 and ARCLVL=2 capabilities are available. If you set an ARCLVL value less than the latest, your program can still run on more recent levels of the system, but it might not take advantage of all the new functions.

3

Means that the architecture is the architecture level required by z/OS V2R1, which corresponds, roughly, to the IBM System z9 processor.

4

Means that the architecture is the architecture level required by z/OS V2R2, which corresponds, roughly, to the IBM System z10 processor.

5

Means that the architecture corresponds, roughly, to the IBM System z196 processor.

6

Means that the architecture is the architecture level required by z/OS V2R3, which corresponds, roughly, to the IBM System zEC12 processor.

OSREL

Indicates to set the ARCHLVL according to the OSREL specification using the following rules:

- When the OSREL release is at least z/OS V2R3, set &SYSALVL to 6.
- When the OSREL release is at least z/OS V2R2, set &SYSALVL to 4.
- When the OSREL release is at least z/OS V2R1, set &SYSALVL to 3.
- When the OSREL release is at least z/OS V1R6, set &SYSALVL to 2.
- Otherwise, set &SYSALVL to 1.

When an ARCHLVL greater than 0 is in effect, be aware of the following points:

- Macros may expect that there is addressability to the literal area of your assembly language program at the point where the macro is invoked.
- You might still need to use the IEABRC or IEABRCX macro to have subsequent macros generate code that avoids the use of base-displacement branch instructions, since many macros are not sensitive to the value specified for SYSSTATE ARCHLVL. See *z/OS MVS Programming: Assembler Services Reference IAR-XCT* for details about the IEABRC and IEABRCX macros.

OSREL=*osrel*

Indicates the earliest operating system release that subsequent macros may assume the code is running on by setting the global symbol &SYSOSREL and &SYSOSREL_NAME. Specify *osrel* by specifying the release name in the form ZOSVnRm, where *n* is the version number and *m* is the release number. For example, specify OSREL=ZOSV1R6 for z/OS V1R6. For each new release, an analogous value will be added for *osrel*. The system also provides global character macro variables for each supported release which you can check within a macro. These macro variables are of the form &SYSOSREL_ZOSVnRm.

You can also specify OSREL=SYSSTATE, which indicates that the OSREL is to match the release of z/OS that provided the SYSSTATE macro with which you are assembling.

You can also specify OSREL=MIGLIB, which indicates that the OSREL is to match the oldest supported release of z/OS at the time that the release of z/OS that provided the SYSSTATE macro with which you are assembling became available. Modules such as IBM-provided IPCS modules in SYS1.MIGLIB might use this.

PUSH

Saves current SYSSTATE global symbol settings. You can nest PUSH/POP to a depth of 255.

POP

Restore SYSSTATE global symbol settings to the previously saved levels. You can nest PUSH/POP to a depth of 255.

RMODE64=NO**RMODE64=YES**

Indicates whether your program is RMODE 64 at this point. It sets the global symbol &SYSRM64.

- RMODE64=YES should be specified for any part of your program that runs in RMODE 64. Some macros process differently according to this specification. For example, macros such as DELETE and LOAD accommodate data above 2G when SYSSTATE RMODE64=YES.
- RMODE64=NO should be specified for programs, or parts of programs, that do not run in RMODE 64.
- Even though your whole module might be RMODE64, you should have RMODE64=YES in effect only for macros that document that they support SYSSTATE RMODE64=YES.

ABEND codes

None.

Return and reason codes

None.

Example 1

Change to AR mode and set the global symbol.

```
SAC      512
SYSSTATE ASCENV=AR
```

Example 2

The following example shows how you would code the SYSSTATE macro to indicate that your code was in a section that knew that it was running on z/OS V1R6 or later:

```
L      15,X'10'    Get CVT address
TM    CVTOSLV3-CVT(15),CVTZOS_V1R6
JZ    NOT_V1R6
SYSSTATE PUSH    save SYSSTATE values
SYSSTATE OSREL=ZOSV1R6
LXRES ELXLIST=...
SYSSTATE POP    restore SYSSTATE values
NOT_V1R6 DS 0H
```

Example 3

The following example shows how you would use SYSSTATE to temporarily indicate a program's ASC mode, and then change back to the prior setting. In this example, the program issues SYSSTATE PUSH to save the current mode, changes to AR mode issues SYSSTATE to indicate that the program is running in AR ASC mode, and then issues SYSSTATE POP to restore the program to whatever the prior mode was:

```
SAC      512
SYSSTATE PUSH
SYSSTATE ASCENV=AR
* code running in AR-mode
SYSSTATE POP
```

Example 4

The following example shows how you would code a macro to be sensitive to SYSSTATE with the OSREL parameter, in this case for release z/OS V1R6:

```
MACRO
TESTMAC
GBLC  &SYSOSREL
GBLC  &SYSOSREL_ZOSV1R6
SYSSTATE TEST
AIF  (&SYSOSREL GE &SYSOSREL_ZOSV1R6).GENV1R6
* produce code suitable for prior to z/OS v1 R6
AGO  .MACEND
.GENV1R6 ANOP
* produce code suitable for z/OS v1 R6 or later
.MACEND ANOP
MEND
```

Chapter 105. TCBTOKEN – Request or translate the TTOKEN

Description

The TTOKEN is the 16-byte identifier of a task. Unlike a TCB address, each TTOKEN is unique within the IPL; the system does not reassign this same identifier to any other TCB.

The TCBTOKEN macro provides three mutually exclusive services depending on how you specify the TYPE parameter:

- TYPE=CURRENT gives you the TTOKEN for the current task.
- TYPE=PARENT gives you the TTOKEN for the task that attached the current task.
- TYPE=JOBSTEP gives you the TTOKEN for the current task's job step task.

z/OS MVS Programming: Extended Addressability Guide describes TTOKENs.

Environment

The requirements for the caller are:

Environmental factor	Requirement
Minimum authorization:	Problem state and any PSW key.
Dispatchable unit mode:	Task
Cross memory mode:	Any
AMODE:	31-bit
ASC mode:	Primary or AR
Interrupt Status:	Enabled or disabled for I/O and external interrupts
Locks:	The caller can hold locks, but is not a requirement.
Control parameters:	Must reside in the primary address space or in an address or data space that is addressable through a public entry on the caller's dispatchable unit access list (DU-AL).

Programming requirements

None.

Restrictions

None.

Input register information

Before issuing the TCBTOKEN macro, the caller does not have to place any information into any register unless using it in register notation for a particular parameter, or using it as a base register.

Output register information

When control returns to the caller, the general purpose registers (GPRs) contain:

TCBTOKEN macro

Register Contents

- 0**
Used as a work register by the system
- 1**
Address of the TCBTOKEN parameter list
- 2-13**
Unchanged
- 14**
Used as a work register by the system
- 15**
Return code

When control returns to the caller, the ARs contain:

Register Contents

- 0**
Used as a work register by the system
- 1**
ALET used to address the TCBTOKEN parameter list
- 2-13**
Unchanged
- 14-15**
Used as work registers by the system

Some callers depend on register contents remaining the same before and after issuing a service. If the system changes the contents of registers on which the caller depends, the caller must save them before issuing the service, and restore them after the system returns control.

Performance implications

None.

Syntax

The standard form of the TCBTOKEN macro is written as follows:

Syntax	Description
<i>name</i>	<i>name</i> : Symbol. Begin <i>name</i> in column 1.
┌	One or more blanks must precede TCBTOKEN.
TCBTOKEN	
┌	One or more blanks must follow TCBTOKEN.

Syntax	Description
TYPE=CURRENT TYPE=PARENT TYPE=JOBSTEP	
,TTOKEN= <i>ttoken addr</i>	<i>ttoken addr</i> : RX-type address.
,RELATED= <i>value</i>	<i>value</i> : Any valid macro parameter specification.

Parameters

The parameters are explained as follows:

TYPE=CURRENT

TYPE=PARENT

TYPE=JOBSTEP

Specifies the type of TCB information requested, as follows:

CURRENT

The system returns the TTOKEN of the currently active task. The TTOKEN is returned at the address specified by the TTOKEN parameter. Instead of using the TCBTOKEN service, you may use the STCBTTKN field of the STCB data area associated with the current task (for which the TCB address is in the PSATOLD field).

PARENT

The system returns the TTOKEN of the task that attached the currently active task. The TTOKEN is returned at the address specified by the TTOKEN parameter. Instead of using the TCBTOKEN service, you may use the STCBTTKN field of the STCB data area associated with the parent task (for which the TCB address is in the TCBOTC field of the TCB for the current task, for which the TCB address is in the PSATOLD field).

JOBSTEP

The system returns the TTOKEN of the job step task associated with the currently active task. The TTOKEN is returned at the address specified by the TTOKEN parameter. Instead of using the TCBTOKEN service, you may use the STCBTTKN field of the STCB data area associated with the jobstep task associated with the current task (for which the TCB address is in the TCBJSTCB field of the TCB for the current task, for which the TCB address is in the PSATOLD field).

,TTOKEN=*ttoken addr*

Specifies the address at which the 16-byte TTOKEN associated with the specified TCB is returned.

,RELATED=*value*

Specifies information used to self-document macros by “relating” functions or services to corresponding functions or services. The format and contents of the information specified are at the discretion of the user and may be any valid coding values.

ABEND codes

None.

Return codes

When TCBTOKEN returns control, register 15 contains one of the following return codes:

Table 60. Return codes for the TCBTOKEN macro	
Hexadecimal return code	Meaning and action
00	Meaning: TCBTOKEN services completed successfully. Action: None.
10	Meaning: The TCB could not be referenced. Action: Ensure that the input TCB address is valid.
14	Meaning: The TCB did not pass the acronym check. Action: Ensure that the input TCB address is valid.
18	Meaning: The TCB has terminated. Action: None required.
20	Meaning: An unexpected error occurred. Action: Reissue TCBTOKEN.
24	Meaning: The contents of access register 1, used to address the parameter list, were not valid. Action: Change your program to run in primary mode or set access register 1 to zero.
28	Meaning: The parameter list is not valid. Action: Ensure that the parameter list address is valid and addressable in the calling program's key.
30	Meaning: The task is scheduled for termination, but has not yet terminated. Action: None required.
34	Meaning: The caller is not running in task mode. Action: Change your program to run in task mode.

Example

Obtain the TTOKEN for the currently active task and store it in CURRENT_TTOKEN.

```
TCBTOKEN TYPE=CURRENT,TTOKEN=CURRENT_TTOKEN
```

TCBTOKEN—List form

The list form of the TCBTOKEN macro builds a nonexecutable parameter list that the execute form of the TCBTOKEN macro can refer to.

Syntax

The list form of the TCBTOKEN macro is written as follows:

Syntax	Description
<i>name</i>	<i>name</i> : Symbol. Begin <i>name</i> in column 1.

Syntax	Description
␣	One or more blanks must precede TCBTOKEN.
TCBTOKEN	
␣	One or more blanks must follow TCBTOKEN.
,RELATED= <i>value</i>	<i>value</i> : Any valid macro parameter specification.
,MF=L	

Parameters

The parameters are explained below:

,MF=L

Specifies the list form of the TCBTOKEN macro.

TCBTOKEN—Execute form

The execute form of the TCBTOKEN macro modifies and executes the parameter list that the list form of TCBTOKEN generated.

Syntax

The execute form of the TCBTOKEN macro is written as follows:

Syntax	Description
<i>name</i>	<i>name</i> : Symbol. Begin <i>name</i> in column 1.
␣	One or more blanks must precede TCBTOKEN.
TCBTOKEN	
␣	One or more blanks must follow TCBTOKEN.
TYPE=CURRENT TYPE=PARENT TYPE=JOBSTEP	

TCBTOKEN macro

Syntax	Description
,TTOKEN= <i>ttoken addr</i>	<i>ttoken addr</i> : RX-type address.
,RELATED= <i>value</i>	<i>value</i> : Any valid macro parameter specification.
,MF=(E, <i>cntl addr</i>)	<i>cntl addr</i> : RX-type address or register (1) - (12).

Parameters

The parameters are the same as those for the standard form of the TCBTOKEN macro with the following addition:

,MF=(E,*cntl addr*)

Specifies the execute form of the TCBTOKEN macro. This form uses a remote parameter list. The *cntl addr* specifies the address of the remote parameter list that the list form of the macro generates.

Chapter 106. TESTART – Tests the validity of ALETs

Description

TESTART tests for conditions that lead to an access register translation (ART) program interruption. Use it to test:

- The validity of an access list entry token (ALET)
- The validity of the extended authorization index (EAX) authority of the program that passed the ALET
- The value of an ALET
- If a specified ALET points to an entry for a SCOPE=COMMON data space.

By testing for these conditions, your program can avoid using an ALET that would cause an ART program interruption.

For information about ALETs, EAXs, and EAX-authorization, see [z/OS MVS Programming: Extended Addressability Guide](#).

Environment

Requirements for the caller are:

Environmental factor	Requirement
Minimum authorization:	Problem state.
Dispatchable unit mode:	Task or SRB
Cross memory mode:	Any PASN, any HASN, any SASN
AMODE:	Any
ASC mode:	Primary or AR
Interrupt status:	Enabled or disabled for I/O and external interrupts
Locks held:	The caller can be locked or unlocked.
Control parameters:	Not applicable

Programming requirements

None.

Restrictions

None.

Input register information

The input to the macro is the ALET and the caller's EAX.

Output register information

When control returns to the caller, the general purpose registers (GPRs) contain:

**Register
Contents**

TESTART macro

0-1

Used as work registers by the system

2-13

Unchanged

14

Used as a work register by the system

15

Return code

When control returns to the caller, the access registers (ARs) contain:

Register

Contents

0-1

Used as work registers by the system

2-13

Unchanged

14-15

Used as work registers by the system

Performance implications

None.

Syntax

The TESTART macro is written as follows:

Syntax	Description
<i>name</i>	<i>name</i> : Symbol. Begin <i>name</i> in column 1.
␣	One or more blanks must precede TESTART.
TESTART	
␣	One or more blanks must follow TESTART.
ALET=(<i>access-reg</i>)	<i>access-reg</i> : Access register (0) - (15).
,EAX=(<i>eax</i>)	<i>eax</i> : Register (0) - (14).
,CADS=YES	Default: CADS=NO
,CADS=NO	

Parameters

The parameters are explained as follows:

ALET=(access-reg)

Specifies an access register 0 through 15 that contains the ALET to be tested.

,EAX=(eax)

Specifies a general purpose register 0 through 14 that contains the EAX to be used in the test, in bit positions 0-15. (The system ignores bits 16 - 31.)

,CADS=YES

,CADS=NO

Specifies if TESTART is to check the caller's PASN-AL to see if the specified ALET points to an entry for a SCOPE=COMMON data space. If CADS=YES is specified, TESTART returns *one* of the following return codes:

- X'08' if the ALET does not represent a SCOPE=COMMON data space
- X'18' if the ALET is for a SCOPE=COMMON data space.

If CADS=NO is specified, TESTART does not indicate whether or not the specified ALET is for a SCOPE=COMMON data space.

ABEND codes

None.

Return codes

When TESTART macro returns control to your program, GPR 15 contains a return code.

Table 61. Return Codes for the TESTART Macro	
Hexadecimal Return Code	Meaning and Action
00	Meaning: The specified ALET is 0. Action: None.
04	Meaning: The specified ALET represents a valid entry n the PASN-AL. Action: None required. However, you might take some action based upon your application.
08	Meaning: The specified ALET represents a valid entry on the DU-AL. If CADS=YES was specified on the call, the ALET <i>does not</i> point to an entry for a SCOPE=COMMON data space. Action: None required. However, you might take some action based upon your application.
0C	Meaning: The specified ALET is 1. Action: None required. However, you might take some action based upon your application.
10	Meaning: The specified ALET and/or EAX will cause an ART program interruption. Action: None required. However, you might take some action based upon your application.
14	Meaning: A system error occurred in the TESTART service routine. Action: Retry the request.

Table 61. Return Codes for the TESTART Macro (continued)	
Hexadecimal Return Code	Meaning and Action
18	<p>Meaning: The program specified CADS=YES on the call to TESTART. The specified ALET points to an entry for a SCOPE=COMMON data space.</p> <p>Action: None required. However, you might take some action based upon your application.</p>

Example 1

Request that TESTART verify the following two conditions:

- The ALET in AR1 passed by the caller is zero or is a valid ALET on the caller's dispatchable unit access list. The caller's registers were saved in the linkage stack prior to this example.
- The caller is EAX-authorized to data being passed as a parameter that can be accessed by the called program that runs with an authorized EAX.

```

R1      EQU    1           General register 1
AR1     EQU    1           Access register 1
R15     EQU    15         General register 15
*
      SLR    R15,R15       Set a zero code for the ESTA
      EREG  AR1,AR1       Extract GPR/AR 1 from the linkage stack
      ESTA  R0,R15        Place the caller's EAX in R1 bits 0-15
      TESTART ALET=(AR1),EAX=(R1) Test the ALET/EAX
      CL    R15,=X'00000004' Test the TESTART return code
      BH    ERROR         Branch to error routine when the return
*                               code is greater than 4

```

Example 2

Request that TESTART verify the following two conditions:

- The ALET passed by the caller (on the linkage stack) points to an entry for a SCOPE=COMMON data space
- The caller is EAX-authorized to data being passed as a parameter that can be accessed by the called program that runs with an authorized EAX.

```

R1      EQU    1           General register 1
AR1     EQU    1           Access register 1
R15     EQU    15         General register 15
*
      SLR    R15,R15       Set a zero code for the ESTA
      EREG  AR1,AR1       Extract GPR/AR 1 from the linkage stack
      ESTA  R0,R15        Place the caller's EAX in R1 bits 0-15
      TESTART ALET=(AR1),EAX=(R1),CADS=YES Test the ALET/EAX
      CL    R15,=X'00000018' Test the TESTART return code
      BE    CADS_ALET      Branch to CADS ALET routine processing

```

Chapter 107. TIME – Obtain time and date

Description

The TIME macro returns the local time of day and date, the Coordinated Universal Time (UTC) (or the Greenwich mean time) of day and date, or the contents of the time-of-day (TOD) clock. The time-of-day clock referenced can be either in the basic time-of-day format (TOD) or the extended time-of-day format (ETOD).

- TOD – Unsigned 64-bit binary number
- ETOD – Unsigned 128-bit binary number

You can use the STCKCONV and CONVTOD macros to convert between TOD-clock format and various time of day and date formats. The STCKCONV macro converts a TOD-clock value to a time of day and date value and the CONVTOD macro converts a time of day and date value to a TOD clock value. See *z/OS MVS Programming: Assembler Services Guide* and *z/Architecture Principles of Operation* for information comparing the formats of the TOD and ETOD.

In a system using an external time reference (ETR²), the TOD clocks are set automatically at system initialization. However, in a system without an ETR, the time of day and date are only as accurate as the information entered by the operator. System response time also influences the accuracy of the values returned by the TIME macro.

There are two different linkage methods that can be specified. The TIME macro with LINKAGE=SYSTEM can be used by a program in primary or AR mode, in cross memory mode, and in either an enabled or disabled state. The LINKAGE=SYSTEM parameter also permits a choice of formats for the date value returned, as well as list and execute forms of the macro. With LINKAGE=SVC, the caller cannot be in cross memory mode or AR mode, must be in an enabled state, and has no choice of the format for the returned date value.

IBM recommends the use of the LINKAGE=SYSTEM parameter on the TIME macro. The LINKAGE=SVC parameter is provided solely for compatibility with existing programs.

The following description of the TIME macro is divided into two sections, LINKAGE=SYSTEM and LINKAGE=SVC. There are list and execute forms of the macro for LINKAGE=SYSTEM, but not for LINKAGE=SVC.

LINKAGE=SYSTEM

Environment

The requirements for the caller are:

Environmental factor	Requirement
Minimum authorization:	Problem state and any PSW key.
Dispatchable unit mode:	Task or SRB
Cross memory mode:	PASN=HASN=SASN or PASN=HASN=SASN
AMODE:	24- or 31- or 64-bit
ASC mode:	Primary or access register (AR)
Interrupt status:	Enabled or disabled for I/O and external interrupts

² External time reference (ETR) is the MVS generic name for the IBM Sysplex Timer.

TIME macro

Environmental factor

Locks:

Control Parameters:

Requirement

The caller may hold locks, but is not required to hold any.

Must be in the primary address space or be in an address/data space that is addressable through a public entry on the caller's dispatchable unit access list (DU-AL).

Programming requirements

If the program is in AR mode, issue the SYSSTATE ASCENV=AR macro before TIME. SYSSTATE ASCENV=AR tells the system to generate code appropriate for AR mode.

Restrictions

None.

Input register information

Before issuing the TIME macro, the caller does not have to place any information into any register unless using it in register notation for a particular parameter or using it as a base register.

Output register information

When control returns to the caller, the general purpose registers (GPRs) contain:

Register

Contents

0-1

Used as work registers by the system

2-13

Unchanged

14

Used as a work register by the system

15

Return code

When control returns to the caller, the ARs contain:

Register

Contents

0-1

Used as work registers by the system

2-13

Unchanged

14-15

Used as work registers by the system

Some callers depend on register contents remaining the same before and after issuing a service. If the system changes the contents of registers on which the caller depends, the caller must save them before issuing the service, and restore them after the system returns control.

Performance implications

None.

Syntax

The standard form of the TIME macro with LINKAGE=SYSTEM is written as follows:

Syntax	Description
<i>name</i>	<i>name</i> : Symbol. Begin <i>name</i> in column 1.
␣	One or more blanks must precede TIME.
TIME	
␣	One or more blanks must follow TIME.
DEC, <i>stor addr</i>	Default: DEC
BIN, <i>stor addr</i>	<i>stor addr</i> : RX-type address or register (2) - (12).
MIC, <i>stor addr</i>	
STCK, <i>stor addr</i>	
STCKE, <i>stor addr</i>	
,ZONE=LT	Default: ZONE=LT
,ZONE=UTC GMT	Note: This parameter has no meaning if STCK or STCKE is specified.
,LINKAGE=SYSTEM	Note: LINKAGE=SVC is the default.
,DATETYPE=YYYYDDD ,DATETYPE=MMDDYYYY ,DATETYPE=DDMMYYYY ,DATETYPE=YYYYMMDD	Default: DATETYPE=YYYYDDD

Parameters

The parameters are explained as follows:

DEC,*stor addr*

BIN,*stor addr*

MIC,*stor addr*

STCK,*stor addr*

STCKE,*stor addr*

Specifies the format in which the time of day and date, or TOD clock contents, are returned. *stor addr* specifies the address of a 16-byte storage area in which TIME will return the values. The first two words of this area contain the time of day, or TOD clock contents, in the requested format. The third word contains the date in the requested format. Set the fourth word to zero before issuing TIME.

TIME macro

DEC returns the time of day as 8 bytes of packed decimal digits (without a sign) of the form HHMMSSthmiju0000, where:

HH

is hours, based on a 24-hour clock

MM

is minutes

SS

is seconds

t

is tenths of seconds

h

is hundredths of seconds

m

is milliseconds

i

is ten-thousandths of seconds

j

is hundred-thousandths of seconds

u

is microseconds

BIN returns the time of day as an unsigned 32-bit binary number with the low-order bit equivalent to 0.01 second. The second word of the time value returned is zero.

MIC returns the time of day since midnight in microseconds. The value is returned as 8 bytes of information where bit 51 is equivalent to one microsecond.

STCK returns the contents of the basic TOD clock as an unsigned 64-bit binary number where bit 51 is equivalent to one microsecond.

STCKE returns the contents of the extended TOD clock (ETOD) as an unsigned 128-bit binary number where bit 59 is equivalent to one microsecond.

Note: The resolution of the time-of-day clock is model dependent. See *Principles of Operation* for an explanation of the rate advancement.

,ZONE=LT

,ZONE=UTC|GMT

LT specifies that the local time and date are to be returned. UTC or GMT specifies that an externally-sourced time and date such as Coordinated Universal Time (UTC) or Greenwich Mean Time (GMT) are to be returned. Refer to the information on time in *z/Architecture Principles of Operation, SA22-7832* for a discussion of the differences between UTC and GMT.

ZONE is not meaningful if STCK or STCKE is specified.

,LINKAGE=SYSTEM

Specifies that non-SVC linkage is used to invoke the TIME service routine.

,DATETYPE=YYYYDDD

,DATETYPE=MMDDYYYY

,DATETYPE=DDMMYYYY

,DATETYPE=YYYYMMDD

Specifies the format in which the converted date is returned. For each parameter, the format of the returned date is as follows:

DATETYPE

Form of Returned Date

YYYYDDD

0YYYYDDD

MMDDYYYY
MMDDYYYY

DDMMYYYY
DDMMYYYY

YYYYMMDD
YYYYMMDD

The date is returned as packed decimal digits without a sign, where:

YYYY
is the year

DDD
is the day of the year

MM
is the month of the year

DD
is the day of the month

For example, with DATETYPE=YYYYDDD, January 21, 2000 would be returned as a converted TOD value of 02000021.

ABEND codes

None.

Return codes

When TIME macro returns control to your program, GPR 15 contains a return code and GPR 0 contains a reason code.

Hexadecimal Return Code	Meaning and Action
00	Meaning: Successful completion. Action: None.
04	Meaning: Programming error. TOD clocks are not initialized. Action: Retry the request later in the IPL.
08	Meaning: Environmental error. The TOD clock is not usable. Action: Retry the request.
0C	Meaning: System error. Action: Retry the request.
10	Meaning: Programming error. The user's parameter list is not in addressable storage. Action: Ensure that the parameter list is in the caller's Primary address space. If in AR mode, the PASN access list must not be used for addressing the parameter list.

Example 1

Request the local time of day and date (in year/day of the year format) to be returned in decimal digits in a 16-byte area called TIMEDATE.

TIME macro

```
TIME    DEC, TIME DATE, ZONE=LT, LINKAGE=SYSTEM
TIMEDATE DS CL16          TIME AND DATE RETURNED
```

Example 2

Request the GMT time of day and date to be returned in a 16-byte area called OUTVAL. The GMT time of day should be returned as microseconds and the date should be returned in a day/month/year format.

```
OUTVAL  TIME  MIC, OUTVAL, ZONE=GMT, LINKAGE=SYSTEM, DATETYPE=DDMMYYYY
        DS    CL16          TIME AND DATE RETURNED
```

LINKAGE=SYSTEM - List form

Use the list form of the TIME macro (LINKAGE=SYSTEM) together with the execute form of the macro for applications that require reentrant code. The list form of the macro defines an area of storage that the execute form of the macro uses to store the parameters.

Syntax

The list form of the TIME macro is written as follows:

Syntax	Description
<i>name</i>	<i>name</i> : Symbol. Begin <i>name</i> in column 1.
	One or more blanks must precede TIME.
TIME	
	One or more blanks must follow TIME.
LINKAGE=SYSTEM	Note: LINKAGE=SYSTEM must be specified in order to obtain the list form of the TIME macro.
,MF=L	

Parameters

The parameters are explained under the standard form of the TIME macro with LINKAGE=SYSTEM, with the following exception:

,MF=L

Specifies the list form of the TIME macro.

Example

Establish the correct amount of storage for the TIME parameter list.

```
LIST1   TIME  LINKAGE=SYSTEM, MF=L
```

LINKAGE=SYSTEM - Execute form

Use the execute form of the TIME macro (LINKAGE=SYSTEM) together with the list form of the macro for applications that require reentrant code. The execute form of the macro stores the parameters into the storage area defined by the list form.

Syntax

The execute form of the TIME macro is written as follows:

Syntax	Description
<i>name</i>	<i>name</i> : Symbol. Begin <i>name</i> in column 1.
␣	One or more blanks must precede TIME.
TIME	
␣	One or more blanks must follow TIME.
DEC, <i>stor addr</i>	Default: DEC
BIN, <i>stor addr</i>	<i>stor addr</i> : RX-type address or register (2) - (12).
MIC, <i>stor addr</i>	
STCK, <i>stor addr</i>	
STCKE, <i>stor addr</i>	
,ZONE=LT	Default: ZONE=LT
,ZONE=UTC GMT	Note: This parameter has no meaning if STCK is specified.
,LINKAGE=SYSTEM	Note: LINKAGE=SYSTEM must be specified in order to obtain the execute form of the TIME macro.
,DATETYPE=YYYYDDD	Default: DATETYPE=YYYYDDD
,DATETYPE=MMDDYYYY	Note: This parameter has no meaning if STCK is specified.
,DATETYPE=DDMMYYYY	
,DATETYPE=YYYYMMDD	
,MF=(E, <i>list addr</i>)	<i>list addr</i> : RX-type address or register (2) - (12).

Parameters

The parameters are explained under the standard form of the TIME macro with LINKAGE=SYSTEM, with the following exception:

,MF=(E,*list addr*)

Specifies the execute form of the TIME macro. *list addr* specifies the address of the parameter list created by the list form of the macro.

Example

Request the local time of day and date to be returned in a 16-byte area called OUTAREA. The local time of day should be returned as decimal digits and the local date should be returned in year/month/day format. Specify the address of the appropriate parameter list in LIST1.

```
OUTAREA    TIME    DEC,OUTAREA, LINKAGE=SYSTEM, MF=(E, LIST1) , DATETYPE=YYYYMMDD
           DS      CL16          TIME AND DATE RETURNED
```

LINKAGE=SVC

Environment

The requirements for the caller are:

Environmental factor	Requirement
Minimum authorization:	Problem state and any PSW key.
Dispatchable unit mode:	Task
Cross memory mode:	PASN=HASN=SASN
AMODE:	24- or 31-bit addressing mode
ASC mode:	Primary
Interrupt status:	Enabled for I/O and external interrupts
Locks:	No locks held
Control Parameters:	Must be in the primary address space.

Programming requirements

None.

Restrictions

The caller cannot have any enabled, unlocked task (EUT) FRRs established.

Input register information

Before issuing the TIME macro, the caller does not have to place any information into any register unless using it in register notation for a particular parameter or using it as a base register.

Output register information

When control returns to the caller, the registers contain:

**Register
Contents**

0

The time of day if you specified DEC, BIN, or TU. If you did not specify any of these parameters, register 0 is used as a work register by the system.

1

Contains the date, if you specified DEC, BIN, TU, or MIC. If you did not specify any of these parameters, register 1 is used as a work register by the system.

2-13

Unchanged.

14

Used as a work register by the system.

15

Return code.

Some callers depend on register contents remaining the same before and after issuing a service. If the system changes the contents of registers on which the caller depends, the caller must save them before issuing the service, and restore them after the system returns control.

Performance implications

None.

Syntax

The standard form of the TIME macro with LINKAGE=SVC is written as follows:

Syntax	Description
<i>name</i>	<i>name</i> : Symbol. Begin <i>name</i> in column 1.
␣	One or more blanks must precede TIME.
TIME	
␣	One or more blanks must follow TIME.
DEC	Default: DEC
BIN	<i>stor addr</i> : RX-type address or register (0) or (2) - (12).
TU	
MIC, <i>stor addr</i>	
STCK, <i>stor addr</i>	
,ZONE=LT	Default: ZONE=LT
,ZONE=UTC GMT	Note: This parameter has no meaning if STCK is specified.
,LINKAGE=SVC	Default: LINKAGE=SVC

Syntax	Description

Note: The ERRET parameter is obsolete and will be ignored by the system. Therefore, the syntax and parameter descriptions for TIME no longer contain ERRET. However, the system will still accept ERRET and it is not necessary to delete it from existing code.

Parameters

The parameters are explained as follows:

DEC

BIN

TU

MIC,*stor addr*

STCK,*stor addr*

Specifies the form in which the time of day and date, or TOD clock contents, is returned.

DEC returns the time of day in register 0 as packed decimal digits, without a sign, of the form

HHMMSS t h, where:

HH

is hours (24-hour clock)

MM

is minutes

SS

is seconds

t

is tenths of seconds

h

is hundredths of seconds

BIN returns the time of day in register 0 as an unsigned 32-bit binary number. The low-order bit is equivalent to 0.01 second.

TU returns the time of day in register 0 as an unsigned 32-bit binary number. The low-order bit is approximately 26.04166 microseconds (one timer unit).

MIC returns the time of day in microseconds. The *stor addr* is the address of an 8-byte area in storage with bit 51 equivalent to one microsecond.

STCK returns the contents of the TOD clock as an unsigned 64-bit binary number where bit 51 is equivalent to one microsecond. The *stor addr* is the address of an 8-byte area in storage.

Note: The resolution of the time-of-day clock is model dependent. See *Principles of Operation* for an explanation of the rate advancement.

The date is returned in register 1 as packed decimal digits of the form

0CYDDDF, where:

C

is a digit representing the century. In the years 1900 through 1999, the macro will return a value of C=0. In the years 2000 through 2099, the macro will return a value of C=1.

YY

is the last two digits of the year.

DDD

is the day of the year.

F

is a 4-bit sign character that allows the data to be unpacked and printed.

,ZONE=LT**,ZONE=UTC|GMT**

Specifies that the local time and date (LT) or the Coordinated Universal Time (UTC) or Greenwich mean time (GMT) and date are to be returned.

,LINKAGE=SVC

Specifies that the linkage used to invoke the TIME service routine is through an SVC instruction.

ABEND codes

10B

See [z/OS MVS System Codes](#) for an explanation and programmer responses for this code.

Return and reason codes

The only return code from the TIME macro is a zero in register 15 indicating successful completion.

Example 1

Request the system to store the time-of-day clock in the address pointed to by register 2.

```
TIME STCK,(2)
```

Example 2

Request that the current local time and date be returned as packed decimal digits in registers 0 and 1.

```
TIME DEC,ZONE=LT,LINKAGE=SVC
```

Example 3

Request that the current time of day in microsecond format be returned in the location OUTAREA. Note that the default is taken for LINKAGE.

```
TIME MIC,OUTAREA
.
.
OUTAREA DS 2F
```

Chapter 108. TIMEUSED – Obtain accumulated CPU or vector time

Description

The TIMEUSED macro returns an 8-byte integer in a doubleword storage area that you specify. The number is the total CPU or vector time that is used by the current TCB up until you issue the macro. The format of the number is time-of-day (TOD) clock or microseconds time format.

Note: TIMEUSED returns normalized CPU time. Some servers are configured with IBM z Application Assist Processors (zAAP) or IBM z Integrated Information Processors (zIIP), which run at a faster speed than the normal CP processors. In this case, zAAP time and zIIP time are normalized to the equivalent time it would take to run on a normal CP when accumulated into total CPU time.

Environment

The requirements for the caller are:

Environmental factor	Requirement
Minimum authorization:	Problem state and any PSW key.
Dispatchable unit mode:	Task
Cross memory mode:	PASN=HASN=SASN or PASN=HASN=SASN
AMODE:	31- or 64-bit
ASC mode:	Primary or access register (AR)
Interrupt status:	Enabled for I/O and external interrupts
Locks:	No locks held
Control parameters:	Must be in the primary address space or be in an address space/data space that is addressable through a public entry on the caller's dispatchable unit access list (DU-AL).

Programming requirements

None.

Restrictions

None.

Input register information

For TIME_ON_CP=YES, register 13 contains the address of a 36-word save area in F4SA format that resides below the 2-gigabyte bar.

Otherwise, before issuing the TIMEUSED macro, the caller does not have to place any information into any register unless they use it in register notation for a particular parameter, or use it as a base register.

Output register information

When control returns to the caller after the call to TIMEUSED, the general-purpose registers (GPR) contain:

TIMEUSED macro

Register	Contents
0 - 1	Used as work registers by the system
2 - 13	Unchanged
14	Used as a work register by the system
15	Return code

When control returns to the caller after the call to TIMEUSED, the AR contains:

Register	Contents
0 - 1	Used as work registers by the system
2 - 13	Unchanged
14 - 15	Used as work registers by the system

Some callers depend on register contents to remain the same before and after they issue a service. If the system changes the contents of registers on which the caller depends, the caller must save them before they issue the service, and restore them after the system returns control.

Performance implications

When your application uses TIMEUSED LINKAGE=SYSTEM without the CPU and VECTOR parameters (or can change to do so), consider use of the ECT parameter that gives access to the Extract-CPU-Time (ECT) facility that is available on IBM System z9® or later hardware.

- If your application might run on some systems that support the ECT facility and on some systems that do not, you can use the ECT=COND parameter to check for availability of this facility. The ECT=COND parameter adds a small extra overhead when run on a system that does not support the ECT facility, but results in a much faster path when run on a system, which does support the facility.
- If your application always runs on a system that supports the ECT facility, use ECT=YES without specifying the LINKAGE parameter. This provides better performance than using LINKAGE=SYSTEM,ECT=COND.

The TIMEUSED support to use the Extract-CPU-Time facility is available on z/OS V1R8 or later systems.

Syntax

The TIMEUSED macro is written as follows:

Syntax	Description
<i>name</i>	<i>name</i> : Symbol. Begin <i>name</i> in column 1.
	One or more blanks must precede TIMEUSED.
TIMEUSED	
	One or more blanks must follow TIMEUSED.
STORADR= <i>addr</i>	<i>addr</i> : RX-type address or register (2)-(12).

Syntax	Description
,LINKAGE=SYSTEM	Default: See the parameter description.
,RELATED= <i>value</i>	<i>value</i> : Any valid macro parameter specification
,CPU=TOD	Default: CPU=TOD
,CPU=MIC	
,VECTOR=TOD	
,VECTOR=MIC	
,ECT=SYSTEM	Default: ECT=SYSTEM
,ECT=COND	
,ECT=YES	
,TIME_ON_CP=YES	
,OFFLOAD_TIME=YES	
,OFFLOAD_ON_CP=YES	

Parameters

The parameters are explained as follows:

STORADR=*addr*

When TIME_ON_CP, OFFLOAD_TIME, and OFFLOAD_ON_CP are not specified, STORADR=*addr* specifies the address of a doubleword area where the accumulated CPU or vector time is returned. When in AMODE 64 and invoking TIMEUSED with LINKAGE=SYSTEM or ECT=YES, the area can be in 64-bit storage; otherwise, it must be in 31-bit storage. The time interval is represented as an unsigned 64-bit binary number. If you specify CPU=TOD or VECTOR=TOD, bit 51 is the low-order bit of the interval value and equivalent to 1 microsecond. If you specify CPU=MIC or VECTOR=MIC, bit 63 is the low-order bit of the interval value and equivalent to 1 microsecond.

When ECT=YES and one or more of TIME_ON_CP, OFFLOAD_TIME, and OFFLOAD_ON_CP are specified, STORADR=*addr* specifies the address of an 8-word area in 31-bit storage of the primary address space where one or more accumulated time values are returned. It is recommended that the area is on a doubleword boundary. Each time interval is represented as an unsigned 64-bit binary number. Bit 51 is equivalent to 1 microsecond.

On output where the return code is 0:

- Words 0-1 = Total time.
- Words 2-3 = Time on CP when TIME_ON_CP=YES.
- Words 4-5 = Offload time (unnormalized) when OFFLOAD_TIME=YES.
- Words 6-7 = Offload on CP when OFFLOAD_ON_CP=YES. Any subfield that is not requested to be returned is unpredictable.

,LINKAGE=SYSTEM

Indicates that the linkage is by non-branch entry. Do not specify LINKAGE with ECT=YES. You must specify LINKAGE=SYSTEM for all other unauthorized invocations.

,RELATED=value

Specifies information used to self-document macros by “relating” functions or services to corresponding functions or services. The format and contents of the information that is specified are at the discretion of the user and can be any valid coding values.

,CPU=TOD**,CPU=MIC****,VECTOR=TOD****,VECTOR=MIC**

Specifies that TIMEUSED returns the total CPU or vector time in either TOD clock format (CPU=TOD or VECTOR=TOD) or in microseconds (CPU=MIC or VECTOR=MIC).

,ECT=SYSTEM**,ECT=COND****,ECT=YES**

Specifies which instruction service the system is to use.

SYSTEM

Specifies that the system determines which instruction service to use. For LINKAGE=BRANCH, the system uses the Extract CPU Time instruction service when that service is available. For LINKAGE=SYSTEM, it will not use the Extract CPU Time instruction service.

COND

Specifies that the system is conditionally to use the Extract CPU Time instruction service. If the service and instruction are available, the system uses that service. Otherwise, the system uses the regular TIMEUSED service. Output is in TOD format. Use only with LINKAGE=SYSTEM. Do not specify the CPU or VECTOR parameters. You must include the CVT, IHAECVT, and IHAPSA mapping macros.

YES

Specifies that the system is unconditionally to use the Extract CPU Time instruction service. You must verify that the service and instruction are available (running on z/OS V1R8 or later, with bit FLCFECT on in byte FLCFACL3 in macro IHAPSA). Output is in TOD format. Do not specify the CPU, VECTOR, or LINKAGE parameters. You must include the CVT, IHAECVT, and IHAPSA mapping macros.

,TIME_ON_CP=YES

The system is to return information about TIME_ON_CP for the task, which is adjusted for the time spent within the current dispatch. Requires the ECT=YES and STORADR parameters and can be specified along with either OFFLOAD_TIME=YES or OFFLOAD_ON_CP=YES, or both. You must include DSECTs CVT and IHAECVT. The function is available only if bit CVTECT1 in byte CVTOSLV8 of the CVT data area is on.

,OFFLOAD_TIME=YES

The system is to return information about time on offload engines for the task, which is adjusted for the time spent within the current dispatch. This time is unnormalized (it is in the units that apply to the offload processors). Requires the ECT=YES and STORADR parameters and can be specified along with TIME_ON_CP=YES or OFFLOAD_ON_CP=YES, or both. You must include DSECTs CVT and IHAECVT. The function is available only if bit CVTECT1 in byte CVTOSLV8 of the CVT data area is on.

,OFFLOAD_ON_CP=YES

The system is to return information about time on a standard CP that was eligible for offload, which is adjusted for the time spent within the current dispatch. Requires the ECT=YES and STORADR parameters and can be specified along with either TIME_ON_CP=YES or OFFLOAD_TIME=YES, or both. You must include DSECTs CVT and IHAECVT. The function is available only if bit CVTECT1 in byte CVTOSLV8 of the CVT data area is on.

ABEND codes

The caller might encounter system completion code X'012'. See [z/OS MVS System Codes](#) for an explanation and programmer response for this code.

Return codes

Register 15 contains one of the following hexadecimal return codes from TIMEUSED:

<i>Table 63. Return and Reason Codes for the TIMEUSED Macro</i>	
Hexadecimal Return Code	Meaning and Action
0	Meaning: The service completed successfully. Action: None.
8	Meaning: Unexpected error. Action: Reissue the TIMEUSED macro.

Examples

Example 1

Request the total CPU time in TOD clock format to be stored at the address in register 2.

```
TIMEUSED  STORADR=(2),LINKAGE=SYSTEM,CPU=TOD
```

Example 2

Request the total vector time in microseconds to be stored at the address in register 2.

```
TIMEUSED  STORADR=(2),LINKAGE=SYSTEM,VECTOR=MIC
```

Chapter 109. TRANMSG – Translate messages

Description

The TRANMSG macro returns a translated message or messages in a requested language. TRANMSG translates any of the following forms of messages:

- Self-defined text
- A message text block (MTB)
- A message parameter block (MPB)
- A combination of the above

TRANMSG uses a message input/output block (MIO) as input. You can either create the MIO, or let TRANMSG create it for you. You must create the MIO if you are translating multi-line messages with continuation lines. If you create the MIO for multi-line messages, it must contain the following:

- Code of the desired language
- Addresses of the messages to be translated
- Address of an output buffer in the calling program's address space into which TRANMSG is to return the translated messages.

You must also set the MIOCONT flag on in the MIO for multi-line messages with continuation lines.

Otherwise, use parameters on TRANMSG to provide that information, so TRANMSG can build the MIO correctly.

Upon return, each translated message is in the output buffer in the form of an MTB, and the MIO contains the addresses of the MTBs. If the translated message has more than one line, the MTB will indicate multiple lines by showing more than one message entry area within the MTB associated with the translated message.

See [z/OS MVS Programming: Assembler Services Guide](#) for more information on using TRANMSG.

Environment

The requirements for the caller are:

Environmental factor	Requirement
Minimum authorization:	Problem state and any PSW key.
Dispatchable unit mode:	Task or SRB
Cross memory mode:	PASN=HASN=SASN or PASN≠=HASN≠=SASN
AMODE:	24- or 31-bit
ASC mode:	Primary
Interrupt Status:	Enabled for I/O and external interrupts
Locks:	No locks held
Control parameters:	Not applicable

Programming requirements

Before invoking TRANMSG, you must obtain storage for:

- The MIO

TRANMSG macro

- The output buffer where TRANMSG will return the translated messages.

The size of the storage you will need for the MIO and output buffer depends on the number and size of messages you are translating. See *z/OS MVS Data Areas* in the *z/OS Internet library* (www.ibm.com/servers/resourcelink/svc00100.nsf/pages/zosInternetLibrary) for a mapping of the MIO. Storage must be in the address space in which the calling program issued TRANMSG.

You must include the following mapping macros:

- CNLMMIO
- CNLMMCA

Restrictions

If TRANMSG builds the MIO for your application:

- Message translation starts at the first message in the message entry list (*list addr* in the INBUF parameter).
- The first message must contain a message identifier.
- You must supply all parameters on TRANMSG.

If you provide a formatted MIO, the only required parameter is MIO.

Input register information

Before issuing the TRANMSG macro, the caller must ensure that register 13 contains the address of an 18-word save area, which can be provided through the use of standard linkage conventions.

Output register information

When the TRANMSG macro returns control, the output registers contain the following values:

Register

Contents

0

The contents of the high-order halfword are not part of the intended programming interface. The low-order halfword contains a reason code.

1

Used as a work register by system

2-13

Unchanged

14

Used as a work register by system

15

Return code

Some callers depend on register contents remaining the same before and after issuing a service. If the system changes the contents of registers on which the caller depends, the caller must save them before issuing the service, and restore them after the system returns control.

Performance implications

Translating multiple messages on one invocation of TRANMSG is more efficient than invoking TRANMSG multiple times with one message for each invocation.

Syntax

If you build the MIO, code the TRANMSG macro as follows:

Syntax	Description
<i>name</i>	<i>name</i> : Symbol. Begin <i>name</i> in column 1.
‡	One or more blanks must precede TRANMSG.
TRANMSG	
‡	One or more blanks must follow TRANMSG.
MIO= <i>msg block addr</i>	<i>msg block addr</i> : RX-type address or register (2) - (12).

If you want the TRANMSG macro to build the MIO, code TRANMSG as follows:

Syntax	Description
<i>name</i>	<i>name</i> : Symbol. Begin <i>name</i> in column 1.
‡	One or more blanks must precede TRANMSG.
TRANMSG	
‡	One or more blanks must follow TRANMSG.
MIO= <i>msg block addr</i>	<i>msg block addr</i> : RX-type address or register (2) - (12).
,MIOL= <i>length of block addr</i>	<i>length of block addr</i> : RX-type address or register (2) - (12).
,INBUF=(<i>list addr, num of</i>	<i>list addr</i> : RX-type address or register (2) - (12).
<i>entries addr</i>)	<i>num of entries</i> : RX-type address or register (2) - (12).
,OUTBUF= <i>output buffer addr</i>	<i>output buffer addr</i> : RX-type address or register (2) - (12).
,OUTBUFL= <i>output buffer</i>	<i>output buffer length addr</i> : RX-type address or register (2) - (12).
<i>length addr</i>	
,LANGCODE= <i>lang code addr</i>	<i>lang code addr</i> : RX-type address or register (2) - (12).

Syntax	Description

Parameters

The parameters are explained as follows:

MIO=msg block addr

Specifies the address, or a register, containing the address of an area containing the MIO or the address where TRANMSG is to build or find the MIO. If you have built the MIO, code only this parameter. Specify all other parameters only if TRANMSG is to build the MIO.

,MIOL=length of block addr

Specifies the address of a fullword or a register containing the length in bytes of the MIO. The length value is right-justified and padded with blanks. This parameter is required if TRANMSG is to build the MIO.

,INBUF=(list addr, num of entries addr)

Specifies the address of a register pointing to the list of addresses of the self-defined text, MPB, or MTB that TRANMSG is to use as input, and the number of entries in the list, respectively. This parameter is required if TRANMSG is to build the MIO.

,OUTBUF=output buffer addr

Specifies the address of a register containing the address of the output buffer into which TRANMSG is to return translated messages in the form of MTBs. This parameter is required if TRANMSG is to build the MIO.

,OUTBUFL=output buffer length addr

Specifies the address of a fullword or a register containing the length in bytes of the output buffer. This parameter is required if TRANMSG is to build the MIO.

,LANGCODE=lang code addr

Specifies the address of, or a register pointing to, the 3-byte character field containing the code of the language into which you want the messages translated. *z/OS MVS Programming: Assembler Services Guide* contains a list of language codes. This parameter is required if TRANMSG is to build the MIO.

Return and reason codes

While TRANMSG provides return and reason codes in registers 15 and 0, respectively, you can determine exactly which message failed by looking at the reason code returned for each message in the MIOREAS field of the MIO variable data area. See *z/OS MVS Data Areas* in the *z/OS Internet library* (www.ibm.com/servers/resourcelink/svc00100.nsf/pages/zosInternetLibrary) for a mapping of the MIO.

When TRANMSG completes, register 15 contains one of the following hexadecimal return codes:

Hexadecimal Return Code	Meaning
00	Processing completed successfully.
04	Processing complete. The output is complete, but TRANMSG might not have translated everything (for example, one variable in your message might not have translated).
08	Processing complete. The output is usable, but incomplete (for example, you might not have received all lines of a multiline message).
0C	Processing ended prematurely. The output is unusable. Possible causes are: <ul style="list-style-type: none"> You have attempted to translate too many messages at one time. The MIO is not valid The output buffer is too small for any messages.

Hexadecimal Return Code	Meaning
10	Processing did not complete. The output is unpredictable.

When TRANMSG completes, the low-order halfword of register 0 contains one of the following hexadecimal reason codes:

Hexadecimal Return Code	Hexadecimal Reason Code	Meaning
00	00	Successful processing.
04	07	This reason code is for internal diagnostic purposes only. Record it and supply it to the appropriate IBM support personnel.
04	08	This reason code is for internal diagnostic purposes only. Record it and supply it to the appropriate IBM support personnel.
04	0B	This reason code is for internal diagnostic purposes only. Record it and supply it to the appropriate IBM support personnel.
04	0C	The passed storage address is not valid.
04	0D	This reason code is for internal diagnostic purposes only. Record it and supply it to the appropriate IBM support personnel.
04	1A	TRANMSG returned a token value as text.
04	1B	The translated message is not a valid mixed DBCS string.
04	1C	A substitution token that is in the MPB is not in the message skeleton.
04	1D	A substitution token that is in the message skeleton is not in the MPB.
04	1F	The internal day code is not valid.
04	21	The required date format is not available. TRANMSG used the default.
04	22	A date formatting failure occurred.
04	23	The required time format is not available. TRANMSG used the default.
04	24	This reason code is for internal diagnostic purposes only. Record it and supply it to the appropriate IBM support personnel.
04	25	This reason code is for internal diagnostic purposes only. Record it and supply it to the appropriate IBM support personnel.
04	32	Input for the date format is not numeric. TRANMSG returned the date without formatting it.
08	01	The language you requested is not available. TRANMSG returned a U.S. English message.

Hexadecimal Return Code	Hexadecimal Reason Code	Meaning
08	03	The buffer space is insufficient for the output parameter blocks. The output was truncated.
08	14	The message identifier is longer than the text of the message continuation.
08	18	The input message length is not valid.
08	19	The input message does not match a message in the run-time message file.
08	1E	TRANMSG did not find a match in the target language run-time message file.
08	20	This reason code is for internal diagnostic purposes only. Record it and supply it to the appropriate IBM support personnel.
08	2B	This reason code is for internal diagnostic purposes only. Record it and supply it to the appropriate IBM support personnel.
08	33	TRANMSG could not match the message ID in the message skeleton to those contained in the run-time message file.
08	34	TRANMSG attempted to match message text against an English message skeleton with translated line numbers. Input to TRANMSG must be an MPB when you use English message skeletons with translated line numbers.
0C	02	TRANMSG did not copy the input parameter block from the caller's address space.
0C	04	TRANMSG was unable to copy the MIO from the caller's address space.
0C	05	The MIO acronym is not valid.
0C	06	TRANMSG was unable to copy the MIO and output parameter blocks to the caller's address space.
0C	0A	TRANMSG could not obtain storage.
0C	10	The length of the MIO is less than the minimum length for a valid MIO.
0C	11	The length of the MTB is less than the minimum length for a valid MTB.
0C	12	The length of the MPB is less than the minimum length for a valid MPB.
0C	13	The MTB record count is not valid. The message record count must be one (1).
0C	15	The input message has a length less than three. A valid input message must have at least one character each for the message identifier and the message text, separated by a blank character.
0C	17	The MVS message service is unavailable.

Hexadecimal Return Code	Hexadecimal Reason Code	Meaning
0C	26	The translation request terminated. The MMS user exit has set the processing indicator to a nonzero value.
0C	27	The entry installation exit has failed.
0C	28	The exit installation exit has failed.
0C	29	The continuation ID in a multi-line message has zero length.
0C	2A	The MIO invocation type is not valid.
0C	31	The MIOXLATE field in the MIO is not valid.
0C	39	The MIO is too small.
0C	3A	The number in the list of entries is not a valid value.
10	09	This reason code is for internal diagnostic purposes only. Record it and supply it to the appropriate IBM support personnel.

If you translate multiple lines of message text

The return code and reason code you receive will reflect the most severe condition. Multiple lines of message text can be either multi-line messages or multiple messages. You will need to check the MIOREASN field contained within the variable message entry areas of the MIO to determine processing status of each line. The MIOREASN field provides reasons for the errors.

If you received return codes 0 or 4, check field MIOTRUNC in the MIO to see if TRANMSG processed all message input.

It is possible that the output buffer was not large enough to hold all the translated messages. A return code of 0 or 4 might indicate this situation. Check the MIOTRUNC field of the MIO. If MIOTRUNC is 0, TRANMSG processed all messages. If MIOTRUNC is nonzero, it contains the number of the first message that did not fit into the input buffer.

If TRANMSG processing ended prematurely

You can increase the output buffer size, then reissue TRANMSG, or you can redrive message translation (that is, restart message translation at the point where it ended.) You can redrive message translation by using the same MIO and input and output data areas. Save the output of the failing message translation before redriving because TRANMSG reuses these fields on subsequent calls to translate the remaining messages. To redrive message translation, do the following:

1. First, determine where processing stopped. The nonzero number in the MIOTRUNC field is the number of the output message TRANMSG truncated because it did not fit into the output buffer. For example, if you issue TRANMSG to return five translated messages, and the output buffer can hold only three messages, TRANMSG will not return the fourth and fifth message in the output buffer. When TRANMSG completes, the MIOTRUNC field would contain a value of 4.
2. Set the MIOXLATE field of the MIO to the value of the MIOTRUNC field; in this case, 4.
3. If the first message to be translated is a continuation message (contains no message ID), also set the MIOMID field to the message value, and the MIOMIDL field to the message ID length of the associated continuation message.
4. Issue TRANMSG again to translate the remaining messages, starting, in this case, with the fourth message.

Repeat this process until MIOTRUNC is 0, indicating that all input messages have been processed.

TRANMSG macro

If you don't want to redrive using the same MIO, allocate a new, larger output buffer, change the MIO output buffer pointer, the length fields MIOBFPTR and MIOBFSIZ, and the MIOXLATE field. Issue TRANMSG again until MIOTRUNC is 0.

Example 1

Translate U.S. English text to Japanese using self-defined text as input. TRANMSG will build the MIO.

```
TRANSSDT CSECT
TRANSSDT AMODE 31
TRANSSDT RMODE ANY
          STM 14,12,12(13)
          BALR 12,0
          USING *,12
          ST 13,SAVE+4
          LA 15,SAVE
          ST 15,8(13)
          LR 13,15

*****
*          GETMAIN STORAGE AREA FOR THE MIO          *
*****
*
          GETMAIN RU,LV=STORLEN,SP=SP230
          LR R4,R1          SAVE STORAGE ADDRESS
          USING MIO,R4
          L R2,MLENGTH          OBTAIN LENGTH OF MIO AREA
          AR R2,R1          CALCULATE ADDRESS OF OUTPUT BUFFER
*
*****
*          ISSUE TRANSLATE FOR MESSAGE          *
*****
*          TRANMSG MIO=MIO,MIOL=MLENGTH,INBUF=(SDTA,ONE),
          OUTBUF=(R2),OUTBUFL=OUTAREAL,LANGCODE=LC          C
*****
*          FREE STORAGE AREA FOR THE MIO          *
*****
*          FREEMAIN RU,LV=STORLEN,SP=SP230,A=(4)          *
*
          L 13,SAVE+4
          LM 14,12,12(13)
          BR 14
          DROP
*****
MLENGTH DC A(MLEN)
OUTAREAL DC A(STORLEN-MLEN)
SDT DC H'37'
DC CL37'XXXX01 ENGLISH MESSAGE WITH ID XXXX01'
SDTA DC A(SDT)
LC DC CL3'JPN'
SP230 EQU 230
ONE DC F'1'
SAVE DC 18F'0'
R1 EQU 1
R2 EQU 2
R4 EQU 4
MLEN EQU (MIOVDAT-MIO)+MIOMSGL
STORLEN EQU 512
*****
DSECT
CNLMMCA
CNLMMIO
END TRANSSDT
```

Example 2

Translate U.S. English text to Japanese. Build your own MIO.

```
TRANS2A CSECT
TRANS2A AMODE 31
TRANS2A RMODE ANY
          STM 14,12,12(13)
          BALR 12,0
```

```

USING *,12
ST 13,SAVE+4
LA 15,SAVE
ST 15,8(13)
LR 13,15
*
*****
* GETMAIN STORAGE AREA *
*****
*
GETMAIN RU,LV=STORLEN,SP=SP230
LR R4,R1
XC 0(MIOVDAT-MIO,R4),0(R4) CLEAR MIO HEADER SECTION
MVC MIOACRN-MIO(L'MIOACRN,R4),=C'MIO ' SET ACRONYM
MVI MIOVRSN-MIO(R4),$MIO_VERSION SET VERSION NUMBER
MVC MIOSIZE-MIO(4,R4),MLENGTH SAVE MIO SIZE
MVC MIOLANG-MIO(L'MIOLANG,R4),=C'JPN' SET LANGUAGE NAME
L R3,MLENGTH CALCULATE OUTAREA ADD
AR R3,R4 GET MIO ADDRESS
ST R3,MIOBFPTR-MIO(,R4) SET OUTAREA ADDRESS
MVC MIOBFSIZ-MIO(L'MIOBFSIZ,R4),OUTAREAL SET OUTAREA LENGTH
LA R3,1
ST R3,MIOXLATE-MIO(,R4) SET TO FIRST MSG
MVI MIOMID-MIO(R4),C' ' INIT MSGID TO SPACES
MVC MIOMID-MIO+1(L'MIOMID-1,R4),MIOMID-MIO(R4)
LA R3,MIOMSGL GET LENGTH OF MIO
ST R3,MIOVDATL-MIO(,R4) SAVE VARIABLE AREA LENGTH
LA R3,1
ST R3,MIOMSGNO-MIO(,R4) SET NUMBER OF MSGS C
TO TRANSLATE
LA R3,MIOVDAT-MIO GET OFFSET TO VAR. AREA
ST R3,MIOOFFST-MIO(,R4) SAVE OFFSET TO 1ST MSG
AR R3,R4 POINT TO MIO VARIABLE AREA
XC 0(MIOMSGL,R3),0(R3) CLEAR MSG ENTRY AREA
LA R2,SDT OBTAIN INPUT AREA ADDRESS
ST R2,MIOINPTP-MIOMSG(,R3) SAVE INPUT AREA ADDRESS
MVI MIOINFL-MIOMSG(R3),MIOXLATF INDICATE TRANSLATE
*
*****
* ISSUE TRANSLATE FOR MESSAGE *
*****
*
TRANMSG MIO=(R4)
*
*****
* FREE STORAGE AREA *
*****
*
FREEMAIN RU,LV=STORLEN,SP=SP230,A=(4)
*
*****
L 13,SAVE+4
LM 14,12,12(13)
BR 14
DROP
*****
DS 0F
MLENGTH DC A(MLEN)
OUTAREAL DC A(STORLEN-MLEN)
SDT DC H'37'
DC CL37'XXXX01 ENGLISH MESSAGE WITH ID XXXX01'
INAREA DC A(SDT)
LC DC CL3'JPN'
SP230 EQU 230
ONE DC F'1'
SAVE DC 18F'0'
R1 EQU 1
R2 EQU 2
R3 EQU 3
R4 EQU 4
MLEN EQU (MIOVDAT-MIO)+MIOMSGL
STORLEN EQU 512
*****
DSECT
CNLMCA
CNLMIO
END TRANS2A

```

Example 3

Translate three single-line U.S. English messages to Japanese using self-defined text as input.

```

TRANMUL CSECT
TRANMUL AMODE 31
TRANMUL RMODE ANY
STM 14,12,12(13)
BALR 12,0
USING *,12
ST 13,SAVE+4
LA 15,SAVE
ST 15,8(13)
LR 13,15
*
*****
* GETMAIN STORAGE AREA *
*****
*
GETMAIN RU,LV=STORLEN,SP=SP230
LR R4,R1 SAVE STORAGE ADDRESS
USING MIO,R4
L R2,MLENGTH OBTAIN LENGTH OF MIO AREA
AR R2,R1 CALCULATE ADDRESS OF OUTPUT BUFFER
*
*****
* ISSUE TRANSLATE FOR MESSAGE *
*****
*
TRANMSG MIO=MIO,MIOI=MLENGTH,INBUF=(SDT1A,THREE),
OUTBUF=(R2),OUTBUFL=OUTAREAL,LANGCODE=LC
*****
* FREE STORAGE AREA *
*****
*
FREEMAIN RU,LV=STORLEN,SP=SP230,A=(4)
*
*****
L 13,SAVE+4
LM 14,12,12(13)
BR 14
DROP
*****
MLENGTH DC A(MLEN)
OUTAREAL DC A(STORLEN-MLEN)
SDT1 DC H'33'
DC CL33'XXX0A THIS IS MESSAGE NUMBER ONE'
SDT2 DC H'33'
DC CL33'XXX0B THIS IS MESSAGE NUMBER TWO'
SDT3 DC H'35'
DC CL35'XXX0C THIS IS MESSAGE NUMBER THREE'
SDT1A DC A(SDT1)
SDT2A DC A(SDT2)
SDT3A DC A(SDT3)
LC DC CL3'JPN'
SP230 EQU 230
THREE DC F'3'
SAVE DC 18F'0'
R1 EQU 1
R2 EQU 2
R4 EQU 4
MLEN EQU (MIOVDAT-MIO)+(3*MIOMSGL)
STORLEN EQU 512
*****
DSECT
CNLMMCA
CNLMMIO
END TRANMUL

```

Example 4

Translate U.S. English text to Japanese using an MTB as input. Create the input MTB.

```

TRANMTBA CSECT
TRANMTBA AMODE 31
TRANMTBA RMODE ANY
STM 14,12,12(13)
BALR 12,0

```

```

USING  *,12
ST     13,SAVE+4
LA     15,SAVE
ST     15,8(13)
LR     13,15
*
*****
*     GETMAIN STORAGE AREA
*****
*
    GETMAIN RU,LV=STORLEN,SP=SP230
    LR     R4,R1             SAVE STORAGE ADDRESS
    USING MIO,R4
    L      R2,MLENGTH       OBTAIN LENGTH OF MIO AREA
    AR     R2,R4             CALCULATE ADDRESS OF MTB
    USING MTB,R2
    MVC    MTBACRN,=C'MTB '   SET ACRONYM
    MVI    MTBVRSN,$MTB_VERSION SET VERSION NUMBER
    MVC    MTBLNGCD,LC        SET LANGUAGE CODE
    LA     R3,MTBLEN         CALCULATE SIZE OF MTB
    ST     R3,MTBSIZE        SAVE MTB SIZE
    LA     R3,MTBV DAT-MTB    OBTAIN LENGTH OF MTB HEADER
    ST     R3,MTBOFFST       SAVE OFFSET TO MTB VARIABLE AREA
    MVC    MTBCOUNT,ONE      SAVE RECORD COUNT
    MVC    MTBV DATL,SDTLEN   SAVE MTB VARIABLE AREA SIZE
    AR     R3,R2             POINT TO MTB VARIABLE AREA
    USING MTBMSG,R3
    MVC    MTBMSG(39),SDT     SET MESSAGE LENGTH
    ST     R2,LIST           SAVE MTB ADDRESS LIST
    LA     R3,39(,R3)        SAVE ADDRESS OF OUTPUT BUFFER
*****
*     ISSUE TRANSLATE FOR MESSAGE
*****
*
    TRANMSG MIO=MIO,MIOL=MLENGTH,INBUF=(LIST,ONE),          C
            OUTBUF=(R3),OUTBUFL=OUTAREAL,LANGCODE=LC
*****
*     FREE STORAGE AREA
*****
*
    FREEMAIN RU,LV=STORLEN,SP=SP230,A=(4)
*
*****
    L      13,SAVE+4
    LM     14,12,12(13)
    BR     14
*****
MLENGTH DC  A(MLEN)
OUTAREAL DC  A(STORLEN-(MLEN+MTBLEN))
SDT      DC  H'37'
LC       DC  CL37'XXXX01 ENGLISH MESSAGE WITH ID XXXX01'
SP230    EQU  230
ONE      DC  F'1'
ZERO     DC  F'0'
SDTLEN   DC  F'39'
SAVE     DC  18F'0'
LIST     DC  F'0'
R1       EQU  1
R2       EQU  2
R3       EQU  3
R4       EQU  4
STORLEN  EQU  512
MLEN     EQU  (MIOVDAT-MIO)+MIOMSGL
MTBLEN   EQU  (MTBV DAT-MTB)+39
*****
DSECT
CNLMCA
CNLMIO
CNLMTB
END TRANMTBA

```

Example 5

Translate a U.S. English multiline message into Japanese. Create the MIO.

```

TRANSLA CSECT
TRANSLA AMODE 31
TRANSLA RMODE ANY

```

```

STM      14,12,12(13)
BALR    12,0
USING   *,12
ST      13,SAVE+4
LA      15,SAVE
ST      15,8(13)
LR      13,15
*
*****
*      GETMAIN STORAGE AREA
*****
*
      GETMAIN RU,LV=STORLEN,SP=SP230
LR      R4,R1
XC      0(MIOVDAT-MIO,R4),0(R4)      CLEAR MIO HEADER SECTION
MVC     MIOACRN-MIO(L'MIOACRN,R4),=C'MIO ' SET ACRONYM
MVI     MIOVRSN-MIO(R4),$MIO_VERSION SET VERSION NUMBER
MVC     MIOSIZE-MIO(4,R4),MLENGTH    SAVE MIO SIZE
MVC     MIOLANG-MIO(L'MIOLANG,R4),=C'JPN' SET LANGUAGE NAME
L       R3,MLENGTH
AR      R3,R4
ST      R3,MIOBFPTR-MIO(,R4)        SET OUTAREA ADDRESS
MVC     MIOBFSIZ-MIO(L'MIOBFSIZ,R4),OUTAREAL SET OUTAREA LENGTH
LA      R3,1
ST      R3,MIOXLATE-MIO(,R4)        SET TO FIRST MSG
MVI     MIOMID-MIO(R4),C' '         INIT MSGID TO SPACE
MVC     MIOMID-MIO+1(L'MIOMID,R4),MIOMID-MIO(R4) CLEAR MSGID
LA      R3,MSGLEN
ST      R3,MIOVDATL-MIO(,R4)        SAVE VARIABLE AREA LENGTH
LA      R3,3
ST      R3,MIOMSGNO-MIO(,R4)        SET NUMBER OF MSGS
*
LA      R3,MIOVDAT-MIO
ST      R3,MIOOFFST-MIO(,R4)        GET OFFSET TO VAR. AREA
AR      R3,R4
LA      R15,MIOVDAT-MIO
AR      R15,R4
LA      R3,SDT1A
XC      0(MIOMSGL,R15),0(R15)        CLEAR MSG ENTRY AREA
MVC     MIOINPTP-MIOMSG(4,R15),0(R3) GET ADDRESS OF SDT
MVI     MIOINFL-MIOMSG(R15),MIOXLATF INDICATE TRANSLATE
LA      R3,4(,R3)
LA      R15,MIOMSGL(,R15)
L       0,TWO
LOOP    DS      0H
XC      0(MIOMSGL,R15),0(R15)        CLEAR MSG ENTRY AREA
MVC     MIOINPTP-MIOMSG(4,R15),0(R3) GET ADDRESS OF SDT
OI      MIOINFL-MIOMSG(R15),MIOXLATF INDICATE TRANSLATE
OI      MIOINFL-MIOMSG(R15),MIOCONT  INDICATE CONTINUATION
LA      R3,4(,R3)
LA      R15,MIOMSGL(,R15)
BCT     0,LOOP
*
*****
*      ISSUE TRANSLATE FOR MESSAGE
*****
*
      TRANMSG MIO=(R4)
*
*****
*      FREE STORAGE AREA
*****
*
      FREEMAIN RU,LV=STORLEN,SP=SP230,A=(4)
*
*****
*
L       13,SAVE+4
LM      14,12,12(13)
BR      14
*****
MLENGTH DC      A(MLEN)
OUTAREAL DC     A(STORLEN-MLEN)
TWO      DC      F'2'
SDT1     DC      H'33'
SDT2     DC      CL33'MSGID1 ENGLISH MESSAGE - LINE ONE'
SDT3     DC      H'28'
SDT3     DC      CL28'ENGLISH MESSAGE - LINE TWO '
SDT3     DC      H'30'
SDT3     DC      CL30'ENGLISH MESSAGE - LINE THREE '
SDT1A    DC      A(SDT1)
SDT2A    DC      A(SDT2)
SDT3A    DC      A(SDT3)

```

```
LC      DC      CL3 'JPN'  
SAVE   DC      18F '0'  
SP230  EQU     230  
R1     EQU     1  
R2     EQU     2  
R3     EQU     3  
R4     EQU     4  
R15    EQU     15  
MSGLEN EQU     3*MIOMSGL  
MLEN   EQU     (MIOVDAT-MIO)+MSGLEN  
STORLEN EQU     512  
*****  
DSECT  
CNLMMCA  
CNLMMIO  
END  TRANSLA
```

Chapter 110. TTIMER – Test interval timer

Description

The TTIMER macro tests the timer interval established by an STIMER macro. It also optionally cancels the remaining time interval.

If MIC is specified, the remaining time is returned to the doubleword area specified in the address. Bit 51 of the area is the low-order bit of the interval value and equivalent to one microsecond. If a time interval has not been set or has already expired, the area is set to zero.

Note: The resolution of the timer is model dependent. See *Principles of Operation* for additional details concerning timing facilities.

Environment

The requirements for the caller are:

Environmental factor	Requirement
Minimum authorization:	Problem state and any PSW key
Dispatchable unit mode:	Task
Cross memory mode:	PASN=HASN=SASN
AMODE:	24- or 31- or 64-bit
ASC mode:	Primary
Interrupt status:	Enabled or disabled for I/O and external interrupts
Locks:	No locks held
Control parameters:	Must be in the primary address space

Programming requirements

For information about programs in 64-bit addressing mode (AMODE 64), see [z/OS MVS Programming: Extended Addressability Guide](#).

Restrictions

Time intervals established via the STIMER SET macro cannot be tested or cancelled with the TTIMER macro.

Input register information

Before issuing the TTIMER macro, the caller does not have to place any information into any register unless using it in register notation for a particular parameter or using it as a base register.

Output register information

When control returns to the caller, the GPRs contain:

Register	Contents
----------	----------

0	
----------	--

	Used as a work register by the system if you do not specify TU. If you specify TU, register 0 contains the amount of time remaining in a timer interval.
--	--

TTIMER macro

1

Used as a work register by the system.

2-13

Unchanged.

14

Used as a work register by the system.

15

Return code.

Some callers depend on register contents remaining the same before and after issuing a service. If the system changes the contents of registers on which the caller depends, the caller must save them before issuing the service and restore them after the system returns control.

Performance implications

None.

Syntax

The TTIMER macro is written as follows:

Syntax	Description
<i>name</i>	<i>name</i> : Symbol. Begin <i>name</i> in column 1.
␣	One or more blanks must precede TTIMER.
TTIMER	
␣	One or more blanks must follow TTIMER.
CANCEL	
,TU	Default: TU
,MIC, <i>stor addr</i>	<i>stor addr</i> : RX-type address, or register (0) or (2) - (12).

The ERRET parameter is obsolete and is ignored by the system. Therefore, the syntax and parameter descriptions for TTIMER no longer contain ERRET. However, the system still accepts ERRET and it is not necessary to delete it from existing code.

Parameters

The parameters are explained as follows:

CANCEL

Specifies that the remaining time interval and any exit routine are to be canceled. If the time interval has already expired, the CANCEL option has no effect and a value of zero time remaining is returned. In this case, a specified exit will still receive control. If a nonzero time remaining is returned when the

CANCEL option is specified, any exit routine is canceled. If CANCEL is not designated, the unexpired portion of the time interval remains in effect.

If WAIT was coded in the STIMER macro that established the interval, the task is not taken out of the wait condition and CANCEL is ignored.

,TU

,MIC,stor addr

Specifies that the remaining time in the interval be returned.

For TU, the time is returned in register 0 as an unsigned 32-bit binary number. The low-order bit is approximately 26.04166 microseconds (one timer unit). If the time remaining is too great to be expressed in four bytes, the remaining time interval is set to the maximum possible value (X'FFFFFFFF') and the return code is set to 4.

For MIC, the time is returned in microseconds. The *stor addr* is the doubleword area on a doubleword boundary where the remaining interval is to be stored.

ABEND codes

12E

See [z/OS MVS System Codes](#) for an explanation and programmer responses for this code.

Return codes

When TTIMER macro returns control to your program, GPR 15 contains a return code.

Table 64. Return Codes for the TTIMER Macro	
Hexadecimal Return Code	Meaning and Action
00	Meaning: Successful completion. Action: None.
04	Meaning: You specified the TU parameter, but the time remaining is greater than X'FFFFFFFF'. Action: None required. However, you might take some action based upon your application.

Example 1

Cancel the task's current time interval. The time remaining, if any, should be returned in timer units in register 0.

```
TTIMER CANCEL ,TU
```

Example 2

Return the time remaining, in microseconds, to the storage location addressed by the label OUTAREA. Do not cancel the interval.

```
TTIMER ,MIC,OUTAREA
.
.
DS 0D
OUTAREA DC 2F
```

Chapter 111. UCBDEVN – Return EBCDIC device number for a UCB

Description

Use the UCBDEVN macro to obtain the printable EBCDIC format for the device number of a given unit control block (UCB). When issuing UCBDEVN, an unauthorized caller must pass a copy of the UCB unless one of the following is true:

- The caller received the UCB address from an authorized program that can guarantee that the UCB is pinned or cannot be deleted by a dynamic configuration change.
- The caller is running in an environment where dynamic configuration changes cannot occur.
- The caller can otherwise guarantee that the UCB will not be deleted.

The caller can obtain a copy of the UCB by using the UCBSCAN macro. See [z/OS MVS Programming: Assembler Services Guide](#) for information about accessing UCBs.

Before issuing UCBDEVN, authorized callers must pin the UCB unless one of the following is true:

- The caller is running in an environment where dynamic configuration changes cannot occur.
- The caller can otherwise guarantee that the UCB will not be deleted.

If you are coding an authorized program that must pin the UCB, see [z/OS MVS Programming: Authorized Assembler Services Guide](#) for information about accessing UCBs.

Environment

The requirements for the caller are:

Environmental factor	Requirement
Minimum authorization:	Problem state and any PSW key
Dispatchable unit mode:	Task or SRB
Cross memory mode:	Any PASN, any HASN, any SASN.
AMODE:	24- or 31-bit
ASC mode:	Primary
Interrupt status:	Enabled or disabled for I/O and external interrupts
Locks:	No locks held
Control parameters:	No requirement

Programming requirements

If you do not specify the UCBPTR parameter, you must include the IEFUCBOB mapping macro and establish addressability to the UCB common segment through a USING statement.

Restrictions

The caller of UCBDEVN cannot pass a copy of a UCB for a nonbase exposure of a multiple-exposure device.

When issuing UCBDEVN, the caller cannot pass a copy of an alias UCB of a parallel access volume.

UCBDEVN macro

UCBDEVN accepts above 16 megabyte UCBs, below 16 megabyte UCBs, and captured UCBs as input. To specify an above 16 megabyte UCB, the caller must run in AMODE 31. If the caller runs in AMODE 31 and passes a 24-bit UCB pointer, the pointer must have a clean high order byte.

Input register information

Before issuing the UCBDEVN macro, the caller must ensure that GPR 13 contains the address of an 18-word save area.

Output register information

When control returns to the caller, the GPRs contain:

Register Contents

0-1

Used as work registers by the system

2-13

Unchanged

14-15

Used as work registers by the system

Some callers depend on register contents remaining the same before and after issuing a service. If the system changes the contents of registers on which the caller depends, the caller must save them before issuing the service, and restore them after the system returns control.

Performance implications

None.

Syntax

The UCBDEVN macro is written as follows:

Syntax	Description
<i>name</i>	<i>name</i> : Symbol. Begin <i>name</i> in column 1.
┌	One or more blanks must precede UCBDEVN.
UCBDEVN	
┌	One or more blanks must follow UCBDEVN.
DEVN= <i>devnumber</i>	<i>devnumber</i> : RS-type address.
XDEVN= <i>xdevn</i>	<i>xdevn</i> : Mutually exclusive with the DEVN keyword.
,UCBPTR= <i>ucbptr</i>	<i>ucbptr</i> : RX-type address. Note: If you omit this parameter, the system assumes that you have established addressability to the UCB common segment.

Syntax	Description
,NONBASE=NO	Default: NO
,NONBASE=YES	

Parameters

The parameters are explained as follows:

DEVN=devnumber

Specifies the name of the fullword area in which the system returns the EBCDIC device number.

XDEVN=xdevn

Ten character field containing the EBCDIC form of the UCB name. The first byte is the length of the returned UCB name text. The remainder of the field contains the returned UCB name text, left-justified and padded with blanks. The string that is returned is a logical device number composed of 4 or more hex digits.

XDEVN is mutually exclusive with the DEVN keyword.

,UCBPTR=ucbptr

Specifies a fullword containing the address of the UCB common segment, which contains the device number you need. If you omit this parameter, you must do the following:

- Include the IEFUCBOB mapping macro in your program to map the UCB.
- Establish addressability to the UCB common segment through a USING statement.
- Place the address of the UCB common segment in the register specified in the USING statement.

If the UCB common segment is for a multiple exposure device, the system returns printable EBCDIC for the base exposure device number.

,NONBASE=NO

,NONBASE=YES

Specifies which device number the caller should receive for a specified alias UCB of a parallel access volume. NO specifies the base device number, and YES specifies the alias device number.

Return and reason codes

UCBDEVN does not return any return codes.

Example

Use the UCBDEVN macro to obtain the printable EBCDIC form of the device number for the UCB whose address is in UCBVAL. The system is to return the value in the fullword named WORD1.

```
UCBDEVN DEVN=WORD1,UCBPTR=UCBVAL
```

Chapter 112. UCBINFO – Return information from a UCB

Description

Use the UCBINFO macro to obtain information from a unit control block (UCB) for a specified device. The UCBINFO macro provides the following options:

DEVCOUNT

Returns a count of the UCBs for a device class or device group.

DEVINFO

Returns information about a device, particularly, why the device is offline. For the base UCB of a Parallel Access Volume (PAV), DEVINFO returns the number of alias UCBs that are defined, and the number that are usable. Also, the DEVINFO can return an indicator in the IOSDDEVI mapping macro reflecting whether the device is a Hyper Parallel Access Volume (HyperPAV) device.

GETCDR

Returns the Configuration Data Record (CDR) for a specific device-path from the Configuration Data Table (CDT).

HYPERPAVALIASES

Returns information for HyperPAV aliases that are configured in the same logical subsystem as the input device. The HYPERPAVALIASES function allows you to obtain selected information for each alias exposure of a Parallel Access Volume (PAV) device in HyperPAV mode. All alias exposures contained in the logical subsystem are returned in the output PAVAREA. The data returned by this function is mapped by the mapping macro IOSDPAVA and consists of a header and one or more entries.

PATHINFO

Returns information about the device path and type of channel path associated with the device.

PATHMAP

Returns information about the device path.

PRFXDATA

Obtains a copy of the UCB prefix extension segment.

PAVINFO

Returns information about the alias UCBs for a Parallel Access Volume (PAV) or a Hyper Parallel Access Volume (HyperPAV).

The options of the UCBINFO macro have the same environmental specifications, programming requirements, restrictions, register information, and performance implications described below, except where noted in the explanations of each option.

Environment

The requirements for the caller are:

Environmental factor	Requirement
Minimum authorization:	Problem state and any PSW key.
Dispatchable unit mode:	Task or SRB
Cross memory mode:	Any PASN, any HASN, any SASN
AMODE:	24- or 31-bit
ASC mode:	Primary or access register (AR)

UCBINFO macro

Environmental factor	Requirement
Interrupt status:	Enabled or disabled for I/O and external interrupts
Locks:	The caller may hold locks, but is not required to hold any
Control parameters:	Control parameters must be in the primary address space or, for AR-mode callers, must be in an address/data space that is addressable through a public entry on the caller's dispatchable unit access list (DU-AL).

Programming requirements

Before issuing the UCBINFO macro, you can issue the UCBSCAN macro to obtain the device number, which you must provide as input to UCBINFO. See [z/OS MVS Programming: Assembler Services Guide](#) for information about accessing UCBs.

The caller must include the appropriate mapping macro for the UCBINFO option being used:

Option

Mapping Macro

DEVCOUNT

None

DEVINFO

IOSDDEVI mapping macro

HYPERPAVALIASES

IOSDPAVA mapping macro

PATHINFO

IOSDPATH mapping macro

PATHMAP

IOSDMAP mapping macro

PAVINFO

IOSDPAVA mapping macro

PRFXDATA

IOSDUPI mapping macro

Restrictions

None.

Input register information

Before issuing the UCBINFO macro, the caller does not have to place any information into any register unless using it in register notation for a particular parameter, or using it as a base register.

Output register information

When control returns to the caller, the GPRs contain:

Register

Contents

0

A reason code; otherwise, used as a work register by the system

1

Used as a work register by the system

2-13

Unchanged

14

Used as a work register by the system

15

A return code

When control returns to the caller, the ARs contain:

Register**Contents****0-1**

Used as work registers by the system

2-13

Unchanged

14-15

Used as work registers by the system

Performance implications

None.

UCBINFO DEVCOUNT

Use the UCBINFO DEVCOUNT macro to obtain a count of the UCBs for a device class.

Syntax

The standard form of the DEVCOUNT option of the UCBINFO macro is written as follows:

Syntax	Description
<i>name</i>	<i>name</i> : symbol. Begin <i>name</i> in column 1.
␣	One or more blanks must precede UCBINFO.
UCBINFO	
␣	One or more blanks must follow UCBINFO.
DEVCOUNT	
,COUNT= <i>count addr</i>	<i>count addr</i> : RS-type address or register (2) - (12).
,GROUP=DEVICELASS	
,DEVCLASS=ALL	Default: ALL
,DEVCLASS=CHAR	
,DEVCLASS=COMM	

UCBINFO macro

Syntax	Description
,DEVCLASS=CTC	
,DEVCLASS=DASD	
,DEVCLASS=DISP	
,DEVCLASS=TAPE	
,DEVCLASS=UREC	
,GROUP=OTHER	
,DEVGROU=PAVBASE	Default: PAVBASE
,DEVGROU=PAVALIAS	
,SUBCHANNELSET=ID	
,SCHSET= <i>schset addr</i>	<i>schset addr</i> : RS-type address or register (2) - (12).
,SCHSET=0	Default: 0
,SUBCHANNELSET=ALL	
,IOCTOKEN= <i>ioctoken addr</i>	<i>ioctoken addr</i> : RX-type address or register (2) - (12).
,PLISTVER=IMPLIED_VERSION	
,PLISTVER=MAX	Default: IMPLIED_VERSION
,PLISTVER= <i>plistver</i>	<i>plistver</i> : 2
,RETCODE= <i>retcode addr</i>	<i>retcode addr</i> : RX-type address or register (2) - (12).
,RSNCODE= <i>rsncode addr</i>	<i>rsncode addr</i> : RX-type address or register (2) - (12).

Parameters

The parameters are explained as follows:

DEVCOUNT

Specifies that the system is to return a count of the UCBs.

,COUNT=*count addr*

Specifies the address of the fullword field that is to receive the count.

,GROUP=DEVICECLASS

GROUP specifies the grouping upon which the UCB count is based.

DEVICECLASS indicates that the UCB count is based on device classes.

,DEVICECLASS=ALL|CHAR|COMM|CTC|DASD|DISP|TAPE|UREC

Specifies the device class for which the corresponding UCBs are to be counted:

ALL

Counts UCBs for all device classes

CHAR

Counts UCBs for character reader device class

COMM

Counts UCBs for communications device class

CTC

Counts UCBs for channel to channel device class

DASD

Counts UCBs for direct access device class

DISP

Counts UCBs for display device class

TAPE

Counts UCBs for tape device class

UREC

Counts UCBs for unit record device class

,GROUP=OTHER

GROUP specifies the grouping upon which the UCB count is based.

OTHER indicates that the UCB count is not based on device classes.

,DEVGROUP=PAVBASE**,DEVGROUP=PAVALIAS**

Specifies the device group for which the corresponding UCBs are to be counted.

- **PAVBASE**, counts UCBs for Parallel Access Volume (PAV) base UCBs.
- **PAVALIAS**, counts UCBs for Parallel Access Volume (PAV) alias UCBs.

,SUBCHANNELSET=ID**,SUBCHANNELSET=ALL****,SUBCHANNELSET=ID**

Indicates the UCB count is based on one subchannel set. DEFAULT: ID

,SCHSET=schset addr**,SCHSET=0**

Specifies the name (RS-type), or address in register (2)-(12), of an optional byte input that specifies a subchannel set for which the UCBINFO request is to be performed. DEFAULT: 0.

,SUBCHANNELSET=ALL

Indicates the UCB count is based on all subchannel sets. DEFAULT: ID

,IOCTOKEN=ioctoken addr

Specifies the address of a 48-character storage area that contains the MVS I/O configuration token. The caller can obtain this token by issuing the IOCINFO macro. *z/OS MVS Programming: Assembler Services Reference ABE-HSP* If the I/O configuration token that is current when UCBINFO is invoked does not match the token whose address is supplied here, the system issues a return code to the caller.

If you set the input IOCTOKEN (specified by *ioctoken addr*) to binary zeros, UCBINFO sets IOCTOKEN to the current I/O configuration token.

,PLISTVER=IMPLIED_VERSION**,PLISTVER=MAX****,PLISTVER=plistver**

Specifies the version of the macro. PLISTVER determines which parameter list the system generates. PLISTVER is an optional input parameter on all forms of the macro, including the list form. When using PLISTVER, specify it on all macro forms used for a request and with the same value on all of the macro forms. The values are:

- **IMPLIED_VERSION**, which is the lowest version that allows all parameters specified on the request to be processed. If you omit the PLISTVER parameter, IMPLIED_VERSION is the default.
- **MAX**, if you want the parameter list to be the largest size currently possible. This size might grow from release to release and affect the amount of storage that your program needs.

If you can tolerate the size change, IBM recommends that you always specify PLISTVER=MAX on the list form of the macro. Specifying MAX ensures that the list-form parameter list is always long enough to hold all the parameters you might specify on the execute form; in this way, MAX ensures that the parameter list does not overwrite nearby storage.

- **2**, if you use the currently available parameters.

To code, specify in this input parameter one of the following:

- IMPLIED_VERSION
- MAX
- A decimal value of 2.

,RETCODE=retcode addr

Specifies the address of a fullword field into which the system copies the return code from GPR 15.

,RSNCODE=rsncode addr

Specifies the address of a fullword field into which the system copies the reason code from GPR 0.

Return and reason codes

When the UCBINFO DEVCOUNT macro returns control to your program, GPR 15 (or *retcode addr*, if you coded RETCODE) contains a return code, and GPR 0 (or *rsncode addr*, if you coded RSNCODE) contains a reason code.

Hexadecimal Return Code	Hexadecimal Reason Code	Meaning and Action
00	None	Meaning: The DEVCOUNT function completed successfully. Action: None.
08	01	Meaning: Program error. A caller in AR mode specified an ALET that was not valid. Action: Correct the ALET and reissue the macro.
08	02	Meaning: Program error. The system could not access the caller's parameter list. This might be due to using a keyword that requires authorization but the caller was not authorized, that is the Supervisor state or PSW key 0 - 7. Action: Ensure that you have met the environmental requirements for the macro and reissue the macro.
08	05	Meaning: Program error. An error occurred when the system referenced the caller-supplied area specified in the IOCTOKEN parameter. This reason code is valid only for callers using the IOCTOKEN parameter. Action: Correct the IOCTOKEN parameter.
08	0B	Meaning: The value specified on the SCHSET keyword is not valid. Action: Enter the correct value on the SCHSET keyword.
0C	None	Meaning: Environmental error. The I/O configuration token supplied through the IOCTOKEN parameter is not current. This return code is valid only for callers using the IOCTOKEN parameter. Action: Obtain the current I/O configuration token by issuing an IOCINFO macro or by setting the input IOCTOKEN parameter in the UCBINFO macro to zero.
20	None	Meaning: System error. An unexpected error occurred. Action: Supply the return code to the appropriate IBM support personnel.

Example

To invoke UCBINFO to return a count of all DASD devices, code:

```

UCBINFO  DEVCOUNT, COUNT=CTAREA, DEVCLASS=DASD,          X
         RETCODE=INFORTCD, RSNCD=RSNCD
         .
         .
         .
         DS  0D
CTAREA   DS  F
INFORTCD DS  F
RSNCD    DS  F

```

UCBINFO DEVCOUNT—List form

Use the list form of the DEVCOUNT option of the UCBINFO macro together with the execute form for applications that require reentrant code. The list form of the macro defines an area of storage that the execute form uses to contain the parameters.

This macro is an alternative list form macro, and requires a different technique for using the list form as compared to the conventional list form macros. See [Alternative list form macros](#) for further information.

The list form of the DEVCOUNT option of the UCBINFO macro is written as follows:

Syntax	Description
<i>name</i>	<i>name</i> : symbol. Begin <i>name</i> in column 1.
␣	One or more blanks must precede UCBINFO.
UCBINFO	
␣	One or more blanks must follow UCBINFO.
,PLISTVER=IMPLIED_VERSION	
,PLISTVER=MAX	Default: IMPLIED_VERSION
,PLISTVER= <i>plistver</i>	<i>plistver</i> : 2
MF=(L, <i>list addr</i>)	<i>list addr</i> : RX-type address
MF=(L, <i>list addr</i> , <i>attr</i>)	<i>attr</i> : 1- to 60-character input string
MF=(L, <i>list addr</i> ,0D)	Default: 0D

Parameters

The parameters are explained under the standard form of UCBINFO DEVCOUNT with the following exceptions:

UCBINFO macro

MF=(L,*list addr*)

MF=(L,*list addr,attr*)

MF=(L,*list addr,0D*)

Specifies the list form of the UCBINFO DEVCOUNT macro.

list addr is the name of a storage area to contain the parameters.

attr is an optional 1- to 60-character input string, which can contain any value that is valid on an assembler DS pseudo-op. You can use this parameter to force boundary alignment of the parameter list. If you do not code *attr*, the system provides a value of 0D, which forces the parameter list to a doubleword boundary.

UCBINFO DEVCOUNT—Execute form

Use the execute form of the DEVCOUNT option of the UCBINFO macro together with the list form of the macro for applications that require reentrant code. The execute form of the macro stores the parameters into the storage area defined by the list form.

The execute form of the DEVCOUNT option of the UCBINFO macro is written as follows:

Syntax	Description
<i>name</i>	<i>name</i> : symbol. Begin <i>name</i> in column 1.
␣	One or more blanks must precede UCBINFO.
UCBINFO	
␣	One or more blanks must follow UCBINFO.
DEVCOUNT	
,COUNT= <i>count addr</i>	<i>count addr</i> : RS-type address or register (2) - (12).
,GROUP=DEVICELASS	
,DEVCLASS=ALL	Default: ALL
,DEVCLASS=CHAR	
,DEVCLASS=COMM	
,DEVCLASS=CTC	
,DEVCLASS=DASD	
,DEVCLASS=DISP	
,DEVCLASS=TAPE	
,DEVCLASS=UREC	

Syntax	Description
,GROUP=OTHER	
,DEVGROUP=PAVBASE	Default: PAVBASE
,SUBCHANNELSET=ID	
,SCHSET= <i>schset addr</i>	<i>schset addr</i> : RS-type address or register (2) - (12).
,SCHSET=0	Default: 0
,SUBCHANNELSET=ALL	
,IOCTOKEN= <i>ioctoken addr</i>	<i>ioctoken addr</i> : RX-type address or register (2) - (12).
,PLISTVER=IMPLIED_VERSION	
,PLISTVER=MAX	Default: IMPLIED_VERSION
,PLISTVER= <i>plistver</i>	<i>plistver</i> : 2
,RETCODE= <i>retcode addr</i>	<i>retcode addr</i> : RX-type address or register (2) - (12).
,RSNCODE= <i>rsncode addr</i>	<i>rsncode addr</i> : RX-type address or register (2) - (12).
,MF=(E, <i>list addr</i>)	<i>list addr</i> : RX-type address or address in register (2) - (12).
,MF=(E, <i>list addr</i> ,COMPLETE)	Default: COMPLETE

Parameters

The parameters are explained under the standard form of UCBINFO DEVCOUNT with the following exceptions:

,MF=(E,*list addr*)

,MF=(E,*list addr*,COMPLETE)

Specifies the execute form of the UCBINFO DEVCOUNT macro.

list addr specifies the area that the system uses to contain the parameters.

COMPLETE, which is the default, specifies that the macro is to check for required parameters and supply defaults for omitted optional parameters.

UCBINFO DEVINFO

Use the UCBINFO DEVINFO macro to obtain information about a device, specifically, reasons why the device is offline.

Syntax

The standard form of the DEVINFO option of the UCBINFO macro is written as follows:

Syntax	Description
<i>name</i>	<i>name</i> : symbol. Begin <i>name</i> in column 1.
␣	One or more blanks must precede UCBINFO.
UCBINFO	
␣	One or more blanks must follow UCBINFO.
DEVINFO	
,DEVIAREA= <i>deviarea addr</i>	<i>deviarea addr</i> : RX-type address or register (2) - (12).
,DEVN= <i>devn addr</i>	<i>devn addr</i> : RS-type address or register (2) - (12).
,SCHSET= <i>schset addr</i>	<i>schset addr</i> : RS-type address or register (2) - (12).
,SCHSET=0	Default: 0
,IOCTOKEN= <i>ioctoken addr</i>	<i>ioctoken addr</i> : RX-type address or register (2) - (12).
,PLISTVER=IMPLIED_VERSION	
,PLISTVER=MAX	Default: IMPLIED_VERSION
,PLISTVER= <i>plistver</i>	<i>plistver</i> : 2
,RETCODE= <i>retcode addr</i>	<i>retcode addr</i> : RX-type address or register (2) - (12).
,RSNCODE= <i>rsncode addr</i>	<i>rsncode addr</i> : RX-type address or register (2) - (12).

Parameters

The parameters are explained as follows:

DEVINFO

Specifies that the system is to return information about the specified device.

,DEVIAREA=deviarea addr

Specifies the address of a required 256-byte output field into which the system is to return information about the specified device. This field is mapped by the mapping macro IOSDDEVI.

,DEVN=devn addr

Specifies the address of a halfword that contains, in binary form, the device number of the device. The DEVN and UCBPTR parameters are mutually exclusive.

,SCHSET=schset addr**,SCHSET=0**

Specifies the name (RS-type), or address in register (2)-(12), of an optional byte input that specifies a subchannel set for which the device information is to be obtained. DEFAULT: 0.

,IOCTOKEN=ioctoken addr

Specifies the address of a 48-character storage area that contains the MVS I/O configuration token. The caller can obtain this token by issuing the IOCINFO macro. If the I/O configuration token that is current when UCBINFO is invoked does not match the token whose address is supplied here, the system issues a return code to the caller.

If you set the input IOCTOKEN (specified by *ioctoken addr*) to binary zeros, UCBINFO sets IOCTOKEN to the current I/O configuration token.

,PLISTVER=IMPLIED_VERSION**,PLISTVER=MAX****,PLISTVER=plistver**

Specifies the version of the macro. PLISTVER determines which parameter list the system generates. PLISTVER is an optional input parameter on all forms of the macro, including the list form. When using PLISTVER, specify it on all macro forms used for a request and with the same value on all of the macro forms. The values are:

- **IMPLIED_VERSION**, which is the lowest version that allows all parameters specified on the request to be processed. If you omit the PLISTVER parameter, IMPLIED_VERSION is the default.
- **MAX**, if you want the parameter list to be the largest size currently possible. This size might grow from release to release and affect the amount of storage that your program needs.

If you can tolerate the size change, IBM recommends that you always specify PLISTVER=MAX on the list form of the macro. Specifying MAX ensures that the list-form parameter list is always long enough to hold all the parameters you might specify on the execute form; in this way, MAX ensures that the parameter list does not overwrite nearby storage.

- **2**, if you use the currently available parameters.

To code, specify in this input parameter one of the following:

- IMPLIED_VERSION
- MAX
- A decimal value of 2

,RETCODE=retcode addr

Specifies the address of a fullword field into which the system copies the return code from GPR 15.

,RSNCODE=rsncode addr

Specifies the address of a fullword field into which the system copies the reason code from GPR 0.

Return and reason codes

When the UCBINFO DEVINFO macro returns control to your program, GPR 15 (or *retcode addr*, if you coded RETCODE) contains a return code, and GPR 0 (or *rsncode addr*, if you coded RSNCODE) contains a reason code.

Hexadecimal Return Code	Hexadecimal Reason Code	Meaning and Action
00	None	Meaning: The DEVINFO function completed successfully. Action: None.

Hexadecimal Return Code	Hexadecimal Reason Code	Meaning and Action
04	None	Meaning: Program error. No UCB exists for the device number specified in the DEVN parameter. Action: Correct the device number and reissue the macro.
08	01	Meaning: Program error. A caller in AR mode specified an ALET that was not valid. Action: Correct the ALET and reissue the macro.
08	02	Meaning: Program error. An error occurred when the system tried to access the caller's parameter list. This might be due to using a keyword that requires authorization but the caller was not authorized, that is the Supervisor state or PSW key 0 - 7. Action: Ensure that you have met the environmental requirements for the macro, and reissue the macro.
08	08	Meaning: Program error.
08	05	Meaning: Program error. An error occurred when the system referenced the caller-supplied area specified in the IOCTOKEN parameter. This reason code is valid only for callers using the IOCTOKEN parameter. Action: Correct the IOCTOKEN parameter.
08	09	Meaning: Program error. An error occurred when the system attempted to reference the area specified by the DEVIAREA parameter. Action: Correct the address specified on the DEVIAREA parameter and reissue the macro.
08	0B	Meaning: The value specified on the SCHSET keyword is not valid. Action: Enter a valid value.
0C	None	Meaning: Environmental error. The I/O configuration token supplied through the IOCTOKEN parameter is not current. This return code is valid only for callers using the IOCTOKEN parameter. Action: Obtain the current I/O configuration token by issuing an IOCINFO macro or by setting the input IOCTOKEN parameter in the UCBINFO macro to zero.
20	None	Meaning: System error. An unexpected error occurred. Action: Supply the return code to the appropriate IBM support personnel.
28	None	Meaning: Program error. The device number provided by the caller is an alias device number of a parallel access volume. For information about a parallel access volume, the caller must specify the base device number. Action: Correct the DEVN parameter and reissue the macro.

Example

To invoke UCBINFO to return device information, code:

```

UCBINFO  DEVINFO,DEVIAREA=INFOAREA,DEVN=DEVNUM,          X
RETCODE=INFORTCD
.
.
.
      DS  0D
INFOAREA DS  CL256
INFORTCD DS  F

```

UCBINFO DEVINFO - List form

Use the list form of the DEVINFO option of the UCBINFO macro together with the execute form for applications that require reentrant code. The list form of the macro defines an area of storage that the execute form uses to contain the parameters.

This macro is an alternative list form macro, and requires a different technique for using the list form as compared to the conventional list form macros. See [Alternative list form macros](#) for further information.

The list form of the DEVINFO option of the UCBINFO macro is written as follows:

Syntax	Description
<i>name</i>	<i>name</i> : symbol. Begin <i>name</i> in column 1.
␣	One or more blanks must precede UCBINFO.
UCBINFO	
␣	One or more blanks must follow UCBINFO.
,PLISTVER=IMPLIED_VERSION	
,PLISTVER=MAX	Default: IMPLIED_VERSION
,PLISTVER= <i>plistver</i>	<i>plistver</i> : 2
MF=(L, <i>list addr</i>)	<i>list addr</i> : RX-type address
MF=(L, <i>list addr</i> , <i>attr</i>)	<i>attr</i> : 1- to 60-character input string
MF=(L, <i>list addr</i> ,0D)	Default: 0D

Parameters

The parameters are explained under the standard form of UCBINFO DEVINFO with the following exceptions:

MF=(L,*list addr*)

MF=(L,*list addr*,*attr*)

MF=(L,*list addr*,0D)

Specifies the list form of the UCBINFO DEVINFO macro.

list addr is the name of a storage area to contain the parameters.

attr is an optional 1- to 60-character input string, which can contain any value that is valid on an assembler DS pseudo-op. You can use this parameter to force boundary alignment of the parameter list. If you do not code *attr*, the system provides a value of 0D, which forces the parameter list to a doubleword boundary.

UCBINFO DEVINFO - Execute form

Use the execute form of the DEVINFO option of the UCBINFO macro together with the list form of the macro for applications that require reentrant code. The execute form of the macro stores the parameters into the storage area defined by the list form.

The execute form of the DEVINFO option of the UCBINFO macro is written as follows:

Syntax	Description
<i>name</i>	<i>name</i> : symbol. Begin <i>name</i> in column 1.
␣	One or more blanks must precede UCBINFO.
UCBINFO	
␣	One or more blanks must follow UCBINFO.
DEVINFO	
,DEVIAREA= <i>deviarea addr</i>	<i>deviarea addr</i> : RX-type address or register (2) - (12).
,DEVN= <i>devn addr</i>	<i>devn addr</i> : RS-type address or register (2) - (12).
,SCHSET= <i>schset addr</i>	<i>schset addr</i> RS-type address or register (2) - (12).
,SCHSET=0	Default: 0
,IOCTOKEN= <i>ioctoken addr</i>	<i>ioctoken addr</i> : RX-type address or register (2) - (12).
,PLISTVER=IMPLIED_VERSION	
,PLISTVER=MAX	Default: IMPLIED_VERSION
,PLISTVER= <i>plistver</i>	<i>plistver</i> : 2
,RETCODE= <i>retcode addr</i>	<i>retcode addr</i> : RX-type address or register (2) - (12).
,RSNCODE= <i>rsncode addr</i>	<i>rsncode addr</i> : RX-type address or register (2) - (12).
,MF=(E, <i>list addr</i>)	<i>list addr</i> : RX-type address or address in register (2) - (12).
,MF=(E, <i>list addr</i> ,COMPLETE)	Default: COMPLETE

Parameters

The parameters are explained under the standard form of UCBINFO DEVINFO with the following exceptions:

,MF=(E,*list addr*)

,MF=(E,*list addr*,COMPLETE)

Specifies the execute form of the UCBINFO DEVINFO macro.

list addr specifies the area that the system uses to contain the parameters.

COMPLETE, which is the default, specifies that the macro is to check for required parameters and supply defaults for omitted optional parameters.

UCBINFO GETCDR

Use the UCBINFO GETCDR macro to ****fill in the blank****

Syntax

The standard form of the GETCDR option of the UCBINFO macro is written as follows:

Syntax	Description
<i>name</i>	<i>name</i> : symbol. Begin <i>name</i> in column 1.
ᵇ	One or more blanks must precede UCBINFO.
UCBINFO	
ᵇ	One or more blanks must follow UCBINFO.
DEVINFO	
,DEVIAREA= <i>deviarea addr</i>	<i>deviarea addr</i> : RX-type address or register (2) - (12).
,DEVN= <i>devn addr</i>	<i>devn addr</i> : RS-type address or register (2) - (12).
,SCHSET= <i>schset</i>	<i>schset</i> RS-type address or register (2) - (12).
,SCHSET=0	Default: 0
,IOCTOKEN= <i>ioctoken addr</i>	<i>ioctoken addr</i> : RX-type address or register (2) - (12).
,PLISTVER=IMPLIED_VERSION	
,PLISTVER=MAX	Default: IMPLIED_VERSION

Syntax	Description
,PLISTVER= <i>plistver</i>	<i>plistver</i> : 2
,RETCODE= <i>retcode addr</i>	<i>retcode addr</i> : RX-type address or register (2) - (12).
,RSNCODE= <i>rsncode addr</i>	<i>rsncode addr</i> : RX-type address or register (2) - (12).

UCBINFO GETCDR - List form

Use the list form of the GETCDR option of the UCBINFO macro together with the execute form for applications that require reentrant code. The list form of the macro defines an area of storage that the execute form uses to contain the parameters.

This macro is an alternative list form macro, and requires a different technique for using the list form as compared to the conventional list form macros. See [Alternative list form macros](#) for further information.

The list form of the GETCDR option of the UCBINFO macro is written as follows:

Syntax	Description
<i>name</i>	<i>name</i> : symbol. Begin <i>name</i> in column 1.
␣	One or more blanks must precede UCBINFO.
UCBINFO	
␣	One or more blanks must follow UCBINFO.
GETCDR	
,PLISTVER=IMPLIED_VERSION	
,PLISTVER=MAX	Default: IMPLIED_VERSION
,PLISTVER= <i>plistver</i>	<i>plistver</i> : 2
MF=(L, <i>list addr</i>)	<i>list addr</i> : RX-type address
MF=(L, <i>list addr</i> , <i>attr</i>)	<i>attr</i> : 1- to 60-character input string
MF=(L, <i>list addr</i> ,0D)	Default: 0D

Parameters

The parameters are explained under the standard form of UCBINFO GETCDR with the following exceptions:

MF=(L,*list addr*)**MF=(L,*list addr,attr*)****MF=(L,*list addr,0D*)**

Specifies the list form of the UCBINFO GETCDR macro.

list addr is the name of a storage area to contain the parameters.

attr is an optional 1- to 60-character input string, which can contain any value that is valid on an assembler DS pseudo-op. You can use this parameter to force boundary alignment of the parameter list. If you do not code *attr*, the system provides a value of 0D, which forces the parameter list to a doubleword boundary.

UCBINFO GETCDR - Execute form

Use the execute form of the GETCDR option of the UCBINFO macro together with the list form of the macro for applications that require reentrant code. The execute form of the macro stores the parameters into the storage area defined by the list form.

The execute form of the GETCDR option of the UCBINFO macro is written as follows:

Syntax	Description
<i>name</i>	<i>name</i> : symbol. Begin <i>name</i> in column 1.
␣	One or more blanks must precede UCBINFO.
UCBINFO	
␣	One or more blanks must follow UCBINFO.
GETCDR	
,DEVN= <i>devn addr</i>	<i>devn addr</i> : RS-type address or register (2) - (12).
,SCHSET= <i>schset addr</i>	<i>schset addr</i> : RS-type address or register (2) - (12).
,SCHSET=0	Default: 0
,PATHMASK= <i>pathmask addr</i>	<i>pathmask addr</i> : RS-type address or register (2) - (12).
,PATHMASK=0	Default: 0
,CDRAREA= <i>cdrarea addr</i>	<i>cdrarea addr</i> : RS-type address or register (2) - (12).
,CDRLEN= <i>cdrlen addr</i>	<i>cdrlen addr</i> : RS-type address or register (2) - (12).
,IOCTOKEN= <i>ioctoken addr</i>	<i>ioctoken addr</i> : RX-type address or register (2) - (12).
,PLISTVER=IMPLIED_VERSION	

Syntax	Description
,PLISTVER=MAX	Default: IMPLIED_VERSION
,PLISTVER= <i>plistver</i>	<i>plistver</i> : 2
,RETCODE= <i>retcode addr</i>	<i>retcode addr</i> : RX-type address or register (2) - (12).
,RSNCODE= <i>rsncode addr</i>	<i>rsncode addr</i> : RX-type address or register (2) - (12).
,MF=(E, <i>list addr</i>)	<i>list addr</i> : RX-type address or address in register (2) - (12).
,MF=(E, <i>list addr</i> ,COMPLETE)	Default: COMPLETE

Parameters

The parameters are explained under the standard form of UCBINFO GETCDR with the following exceptions:

,MF=(E,*list addr*)

,MF=(E,*list addr*,COMPLETE)

Specifies the execute form of the UCBINFO GETCDR macro.

list addr specifies the area that the system uses to contain the parameters.

COMPLETE, which is the default, specifies that the macro is to check for required parameters and supply defaults for omitted optional parameters.

UCBINFO HYPERPAVALIASES

Use the UCBINFO HYPERPAVALIASES macro to obtain information for each alias exposure of a Parallel Access Volume (PAV) in HyperPAV mode. All alias exposures contained in the logical subsystem for the input device are returned in the output PAVAREA. The data returned by this function is mapped by macro IOSDPAVA and consists of a header and one or more entries.

If the input device is not a HyperPAV device, a non-zero return code is returned.

Syntax

The standard form of the HYPERPAVALIASES option of the UCBINFO macro is written as follows:

Syntax	Description
<i>name</i>	<i>name</i> : symbol. Begin <i>name</i> in column 1.
␣	One or more blanks must precede UCBINFO.
UCBINFO	
␣	One or more blanks must follow UCBINFO.

Syntax	Description
HYPERPAVALIASES	
,PAVAREA= <i>pavarea addr</i>	<i>pavarea addr</i> : RS-type address or register (2) - (12).
,PAVLEN= <i>pavlen addr</i>	<i>pavlen addr</i> : RS-type address or register (2) - (12).
,SCHINFO=NO YES	Default: NO
,DEVN= <i>devn addr</i>	<i>devn addr</i> : RS-type address or register (2) - (12).
,SCHSET= <i>schset addr</i>	<i>schset addr</i> : RS-type address or register (2) - (12).
,SCHSET=0	Default: 0
,IOCTOKEN= <i>ioctoken addr</i>	<i>ioctoken addr</i> : RX-type address or register (2) - (12).
,PLISTVER=IMPLIED_VERSION	
,PLISTVER=MAX	Default: IMPLIED_VERSION
,PLISTVER= <i>plistver</i>	<i>plistver</i> : 2
,RETCODE= <i>retcode addr</i>	<i>retcode addr</i> : RX-type address or register (2) - (12).
,RSNCODE= <i>rsncode addr</i>	<i>rsncode addr</i> : RX-type address or register (2) - (12).

Parameters

The parameters are explained as follows:

,PAVAREA=*pavarea addr*

This parameter is required and is the name (RS-type), or address in register (2) - (12), of the work area which is to receive the PAV information. The caller must specify the PAVLEN keyword to indicate the length of the PAVAREA. The area is mapped by macro IOSDPAVA.

,PAVLEN=*pavlen addr*

This parameter is the name (RS-type), or address in register (2) - (12), of a required fullword input variable which specifies the length of the PAVAREA.

,SCHINFO=NO| YES

This parameter is an optional keyword input that indicates whether to also retrieve model dependent subchannel data for the device.

Note: Retrieving subchannel data can cause overhead since a Store Subchannel (STSCH) instruction must be issued to retrieve the data. Users who do not need this information might want to bypass this overhead by indicating NO for the SCHINFO keyword. **DEFAULT:** NO.

,SCHINFO=NO

Do not include model dependent subchannel data.

,SCHINFO=YES

Include model dependent subchannel data.

,DEVN=devn addr

Specifies the address of a halfword that contains, in binary form, the device number of the device.

,SCHSET=schset addr**,SCHSET=0**

Specifies the name (RS-type), or address in register (2)-(12), of an optional byte input that specifies a subchannel set for which the device information is to be obtained. DEFAULT: 0.

,IOCTOKEN=ioctoken addr

Specifies the address of a 48-character storage area that contains the MVS I/O configuration token. The caller can obtain this token by issuing the IOCINFO macro, which is described in *z/OS MVS Programming: Assembler Services Reference ABE-HSP*. If the I/O configuration token that is current when UCBINFO is invoked does not match the token whose address is supplied here, the system issues a return code to the caller.

If you set the input IOCTOKEN (specified by *ioctoken addr*) to binary zeros, UCBINFO sets IOCTOKEN to the current I/O configuration token.

,PLISTVER=IMPLIED_VERSION**,PLISTVER=MAX****,PLISTVER=plistver**

Specifies the version of the macro. PLISTVER determines which parameter list the system generates. PLISTVER is an optional input parameter on all forms of the macro, including the list form. When using PLISTVER, specify it on all macro forms used for a request and with the same value on all of the macro forms. The values are:

- **IMPLIED_VERSION**, which is the lowest version that allows all parameters specified on the request to be processed. If you omit the PLISTVER parameter, IMPLIED_VERSION is the default.
- **MAX**, if you want the parameter list to be the largest size currently possible. This size might grow from release to release and affect the amount of storage that your program needs.

If you can tolerate the size change, IBM recommends that you always specify PLISTVER=MAX on the list form of the macro. Specifying MAX ensures that the list-form parameter list is always long enough to hold all the parameters you might specify on the execute form; in this way, MAX ensures that the parameter list does not overwrite nearby storage.

- **2**, if you use the currently available parameters.

To code, specify in this input parameter one of the following:

- IMPLIED_VERSION
- MAX
- A decimal value of 2

,RETCODE=retcode addr

Specifies the address of a fullword field into which the system copies the return code from GPR 15.

,RSNCODE=rsncode addr

Specifies the address of a fullword field into which the system copies the reason code from GPR 0.

Return and reason codes

When the UCBINFO HYPERPAVALIASES macro returns control to your program, GPR 15 (or *retcode addr*, if you coded RETCODE) contains a return code, and GPR 0 (or *rsncode addr*, if you coded RSNCODE) contains a reason code.

Hexadecimal Return Code	Hexadecimal Reason Code	Meaning and Action
00	None	Meaning: The HYPERPAVALIASES function completed successfully. Action: None.
04	None	Meaning: Program error. No UCB exists for the device number specified in the DEVN parameter. Action: Correct the device number and reissue the macro.
08	01	Meaning: Program error. A caller in AR mode specified an ALET that was not valid. Action: Correct the ALET and reissue the macro.
08	02	Meaning: Program error. An error occurred when the system tried to access the caller's parameter list. This might be due to using a keyword that requires authorization but the caller was not authorized, that is Supervisor state or PSW key 0 - 7. Action: Ensure that you have met the environmental requirements for the macro, and reissue the macro.
08	05	Meaning: Program error. An error occurred when the system referenced the caller-supplied area specified in the IOCTOKEN parameter. This reason code is valid only for callers using the IOCTOKEN parameter. Action: Correct the IOCTOKEN parameter.
08	0A	Meaning: Program error. An error occurred when the system attempted to reference the area specified by the PAVAREA parameter. Action: Correct the address specified on the PAVAREA parameter and reissue the macro.
08	0B	Meaning: The value specified on the SCHSET keyword is not valid. Action: Enter a valid value.
0C	None	Meaning: Environmental error. The I/O configuration token supplied through the IOCTOKEN parameter is not current. This return code is valid only for callers using the IOCTOKEN parameter. Action: Obtain the current I/O configuration token by issuing an IOCINFO macro or by setting the input IOCTOKEN parameter in the UCBINFO macro to zero.
20	None	Meaning: System error. An unexpected error occurred. Action: Supply the return code to the appropriate IBM support personnel.
30	01	Meaning: Program error. The device number provided by the caller is not a HyperPAV device. Action: Correct the DEVN parameter and reissue the macro.
30	02	Meaning: Program error. The work area specified with the PAVAREA parameter is not large enough to contain the minimum amount of data. No data is returned. Action: Increase the size of the specified work area and reissue the macro.
30	03	Meaning: Program error. The work area specified with the PAVAREA parameter is not large enough to contain an entry for each alias device. Action: Increase the size of the specified work area and reissue the macro.

UCBINFO macro

Hexadecimal Return Code	Hexadecimal Reason Code	Meaning and Action
34	01	<p>Meaning: Environmental error. The input device is a HyperPAV device for which logical subsystem information does not currently exist.</p> <p>Action: Contact your system programmer.</p>

Example

To invoke UCBINFO to return information about HyperPAV alias UCBs for a base device number, code:

```
UCBINFO  HYPERPAVALIASES,DEVN=DEVNUM,      X
         PAVAREA=INFOAREA,PAVLEN=AREALEN,   X
         RETCODE=INFORTCD
         .
         .
         .
         DS  0D
DEVNUM   DS  H
INFOAREA DS  CL1024
AREALEN  DS  F
INFORTCD DS  F
```

UCBINFO HYPERPAVALIASES - List form

Use the list form of the HYPERPAVALIASES option of the UCBINFO macro together with the execute form for applications that require reentrant code. The list form of the macro defines an area of storage that the execute form uses to contain the parameters.

This macro is an alternative list form macro, and requires a different technique for using the list form as compared to the conventional list form macros. See [Alternative list form macros](#) for further information.

The list form of the HYPERPAVALIASES option of the UCBINFO macro is written as follows:

Syntax	Description
<i>name</i>	<i>name</i> : symbol. Begin <i>name</i> in column 1.
␣	One or more blanks must precede UCBINFO.
UCBINFO	
␣	One or more blanks must follow UCBINFO.
HYPERPAVALIASES	
,PLISTVER=IMPLIED_VERSION	
,PLISTVER=MAX	Default: IMPLIED_VERSION
,PLISTVER= <i>plistver</i>	<i>plistver</i> : 2
MF=(L, <i>list addr</i>)	<i>list addr</i> : RX-type address
MF=(L, <i>list addr</i> , <i>attr</i>)	<i>attr</i> : 1- to 60-character input string

Syntax	Description
MF=(L, <i>list addr</i> ,0D)	Default: 0D

Parameters

The parameters are explained under the standard form of UCBINFO HYPERPAVALIASES with the following exceptions:

MF=(L,*list addr*)

MF=(L,*list addr*,*attr*)

MF=(L,*list addr*,0D)

Specifies the list form of the UCBINFO HYPERPAVALIASES macro.

list addr is the name of a storage area to contain the parameters.

attr is an optional 1- to 60-character input string, which can contain any value that is valid on an assembler DS pseudo-op. You can use this parameter to force boundary alignment of the parameter list. If you do not code *attr*, the system provides a value of 0D, which forces the parameter list to a doubleword boundary.

UCBINFO HYPERPAVALIASES - Execute form

Use the execute form of the HYPERPAVALIASES option of the UCBINFO macro together with the list form of the macro for applications that require reentrant code. The execute form of the macro stores the parameters into the storage area defined by the list form.

The execute form of the HYPERPAVALIASES option of the UCBINFO macro is written as follows:

Syntax	Description
<i>name</i>	<i>name</i> : symbol. Begin <i>name</i> in column 1.
␣	One or more blanks must precede UCBINFO.
UCBINFO	
␣	One or more blanks must follow UCBINFO.
HYPERPAVALIASES	
,PAVAREA= <i>pavarea addr</i>	<i>pavarea addr</i> : RS-type address or register (2) - (12).
,PAVLEN= <i>pavlen addr</i>	<i>pavlen addr</i> : RS-type address or register (2) - (12).
,SCHINFO=NO YES	Default: NO
,DEVN= <i>devn addr</i>	<i>devn addr</i> : RS-type address or register (2) - (12).

Syntax	Description
,SCHSET= <i>schset addr</i>	<i>schset addr</i> : RS-type address or register (2) - (12).
,SCHSET=0	Default: 0
,IOCTOKEN= <i>ioctoken addr</i>	<i>ioctoken addr</i> : RX-type address or register (2) - (12).
,PLISTVER=IMPLIED_VERSION	
,PLISTVER=MAX	Default: IMPLIED_VERSION
,PLISTVER= <i>plistver</i>	<i>plistver</i> : 2
,RETCODE= <i>retcode addr</i>	<i>retcode addr</i> : RX-type address or register (2) - (12).
,RSNCODE= <i>rsncode addr</i>	<i>rsncode addr</i> : RX-type address or register (2) - (12).
,MF=(E, <i>list addr</i>)	<i>list addr</i> : RX-type address or address in register (2) - (12).
,MF=(E, <i>list addr</i> ,COMPLETE)	Default: COMPLETE

Parameters

The parameters are explained under the standard form of UCBINFO HYPERPAVALIASES with the following exceptions:

,MF=(E,*list addr*)

,MF=(E,*list addr*,COMPLETE)

Specifies the execute form of the UCBINFO HYPERPAVALIASES macro.

list addr specifies the area that the system uses to contain the parameters.

COMPLETE, which is the default, specifies that the macro is to check for required parameters and supply defaults for omitted optional parameters.

UCBINFO PATHINFO

Use the UCBINFO PATHINFO macro to obtain information about the device path and type of channel path associated with the device.

Syntax

The standard form of the PATHINFO option of the UCBINFO macro is written as follows:

Syntax	Description
<i>name</i>	<i>name</i> : symbol. Begin <i>name</i> in column 1.
␣	One or more blanks must precede UCBINFO.

Syntax	Description
UCBINFO	
‡	One or more blanks must follow UCBINFO.
PATHINFO	
,PATHAREA= <i>patharea addr</i>	<i>patharea addr</i> : RX-type address or register (2) - (12).
,DEVN= <i>devn addr</i>	<i>devn addr</i> : RS-type address or register (2) - (12).
,SCHSET= <i>schset addr</i>	<i>schset addr</i> : RS-type address or register (2) - (12).
,SCHSET=0	Default: 0
,IOCTOKEN= <i>ioctoken addr</i>	<i>ioctoken addr</i> : RX-type address or register (2) - (12).
,PLISTVER=IMPLIED_VERSION	
,PLISTVER=MAX	Default: IMPLIED_VERSION
,PLISTVER= <i>plistver</i>	<i>plistver</i> : 2
,RETCODE= <i>retcode addr</i>	<i>retcode addr</i> : RX-type address or register (2) - (12).
,RSNCODE= <i>rsncode addr</i>	<i>rsncode addr</i> : RX-type address or register (2) - (12).

Parameters

The parameters are explained as follows:

PATHINFO

Specifies that the system is to return information about the device path and type of channel path for the specified device.

,PATHAREA=*patharea addr*

Specifies the address of the required 256-byte output field into which the system is to return information about the device path and type of channel path for the specified device. This field is mapped by the mapping macro IOSDPATH.

,DEVN=*devn addr*

Specifies the address of a halfword that contains, in binary form, the device number of the device.

,SCHSET=*schset addr***,SCHSET=0**

Specifies the name (RS-type), or address in register (2)-(12), of an optional byte input that specifies a subchannel set for which the system is to return information about the device path and type of channel path. DEFAULT: 0.

,IOCTOKEN=*ioctoken addr*

Specifies the address of a 48-character storage area that contains the MVS I/O configuration token. The caller can obtain this token by issuing the IOCINFO macro. *z/OS MVS Programming: Assembler Services Reference ABE-HSP* If the I/O configuration token that is current when UCBINFO is invoked does not match the token whose address is supplied here, the system issues a return code to the caller.

If you set the input IOCTOKEN (specified by *ioctoken addr*) to binary zeros, UCBINFO sets IOCTOKEN to the current I/O configuration token.

,PLISTVER=IMPLIED_VERSION**,PLISTVER=MAX****,PLISTVER=*plistver***

Specifies the version of the macro. PLISTVER determines which parameter list the system generates. PLISTVER is an optional input parameter on all forms of the macro, including the list form. When using PLISTVER, specify it on all macro forms used for a request and with the same value on all of the macro forms. The values are:

- **IMPLIED_VERSION**, which is the lowest version that allows all parameters specified on the request to be processed. If you omit the PLISTVER parameter, IMPLIED_VERSION is the default.
- **MAX**, if you want the parameter list to be the largest size currently possible. This size might grow from release to release and affect the amount of storage that your program needs.

If you can tolerate the size change, IBM recommends that you always specify PLISTVER=MAX on the list form of the macro. Specifying MAX ensures that the list-form parameter list is always long enough to hold all the parameters you might specify on the execute form; in this way, MAX ensures that the parameter list does not overwrite nearby storage.

- **2**, if you use the currently available parameters.

To code, specify in this input parameter one of the following:

- IMPLIED_VERSION
- MAX
- A decimal value of 2

,RETCODE=*retcode addr*

Specifies the address of a fullword field into which the system copies the return code from GPR 15.

,RSNCODE=*rsncode addr*

Specifies the address of a fullword field into which the system copies the reason code from GPR 0.

Return and reason codes

When the UCBINFO PATHINFO macro returns control to your program, GPR 15 (or *retcode addr*, if you coded RETCODE) contains a return code, and GPR 0 (or *rsncode addr*, if you coded RSNCODE) contains a reason code.

Hexadecimal Return Code	Hexadecimal Reason Code	Meaning and Action
00	None	Meaning: The PATHINFO function completed successfully. Action: None.
04	None	Meaning: Program error. No UCB exists for the device number specified in the DEVN parameter. Action: Correct the device number and reissue the macro.

Hexadecimal Return Code	Hexadecimal Reason Code	Meaning and Action
08	01	Meaning: Program error. A caller in AR mode specified an ALET that was not valid. Action: Correct the ALET and reissue the macro.
08	02	Meaning: Program error. An error occurred when the system tried to access the caller's parameter list. This might be due to using a keyword that requires authorization but the caller was not authorized, that is the Supervisor state or PSW key 0 - 7. Action: Ensure that you have met the environmental requirements for the macro, and reissue the macro.
08	03	Meaning: Program error. An unauthorized caller specified the UCBPTR parameter. Action: Specify the DEVN parameter instead of the UCBPTR parameter to indicate the device for which the system is to obtain path information.
08	05	Meaning: Program error. An error occurred when the system referenced the caller-supplied area specified in the IOCTOKEN parameter. This reason code is valid only for callers using the IOCTOKEN parameter. Action: Correct the IOCTOKEN parameter.
08	08	Meaning: Program error. An error occurred when the system attempted to reference the area specified by the PATHAREA parameter. Action: Correct the address specified on the PATHAREA parameter and reissue the macro.
08	0B	Meaning: The value specified on the SCHSET keyword is not valid. Action: Enter a valid value.
0C	None	Meaning: Environmental error. The I/O configuration token supplied through the IOCTOKEN parameter is not current. This return code is valid only for callers using the IOCTOKEN parameter. Action: Obtain the current I/O configuration token by issuing an IOCINFO macro or by setting the input IOCTOKEN parameter in the UCBINFO macro to zero.
18	04	Meaning: System error. The subchannel is in permanent error and cannot be accessed. Action: Supply the return and reason codes to the appropriate IBM support personnel.
18	08	Meaning: Environmental error. The UCB is not connected to a subchannel. Action: Verify that there is a device at the device number associated with the subchannel, and reissue the macro.
20	None	Meaning: System error. An unexpected error occurred. Action: Supply the return code to the appropriate IBM support personnel.

Example

To invoke UCBINFO to return device path and type of channel path information, code:

```
UCBINFO  PATHINFO ,PATHAREA=INFOAREA ,DEVN=DEVNUM ,          X
RETCODE=INFORTCD
.
.
```

UCBINFO macro

```
INFOAREA DS 0D
INFORTCD DS CL256
DEVNUM   DS  F
          DS  H
```

UCBINFO PATHINFO - List form

Use the list form of the PATHINFO option of the UCBINFO macro together with the execute form for applications that require reentrant code. The list form of the macro defines an area of storage that the execute form uses to contain the parameters.

This macro is an alternative list form macro, and requires a different technique for using the list form as compared to the conventional list form macros. See [Alternative list form macros](#) for further information.

The list form of the PATHINFO option of the UCBINFO macro is written as follows:

Syntax	Description
<i>name</i>	<i>name</i> : symbol. Begin <i>name</i> in column 1.
␣	One or more blanks must precede UCBINFO.
UCBINFO	
␣	One or more blanks must follow UCBINFO.
,PLISTVER=IMPLIED_VERSION	
,PLISTVER=MAX	Default: IMPLIED_VERSION
,PLISTVER= <i>plistver</i>	<i>plistver</i> : 2
MF=(L, <i>list addr</i>)	<i>list addr</i> : RX-type address
MF=(L, <i>list addr</i> , <i>attr</i>)	<i>attr</i> : 1- to 60-character input string
MF=(L, <i>list addr</i> ,0D)	Default: 0D

Parameters

The parameters are explained under the standard form of UCBINFO PATHINFO with the following exceptions:

MF=(L,*list addr*)

MF=(L,*list addr*,*attr*)

MF=(L,*list addr*,0D)

Specifies the list form of the UCBINFO PATHINFO macro.

list addr is the name of a storage area to contain the parameters.

attr is an optional 1- to 60-character input string, which can contain any value that is valid on an assembler DS pseudo-op. You can use this parameter to force boundary alignment of the parameter

list. If you do not code *attr*, the system provides a value of 0D, which forces the parameter list to a doubleword boundary.

UCBINFO PATHINFO - Execute form

Use the execute form of the PATHINFO option of the UCBINFO macro together with the list form of the macro for applications that require reentrant code. The execute form of the macro stores the parameters into the storage area defined by the list form.

The execute form of the PATHINFO option of the UCBINFO macro is written as follows:

Syntax	Description
<i>name</i>	<i>name</i> : symbol. Begin <i>name</i> in column 1.
␣	One or more blanks must precede UCBINFO.
UCBINFO	
␣	One or more blanks must follow UCBINFO.
PATHINFO	
,PATHAREA= <i>patharea addr</i>	<i>patharea addr</i> : RX-type address or register (2) - (12).
,DEVN= <i>devn addr</i>	<i>devn addr</i> : RS-type address or register (2) - (12).
,SCHSET= <i>schset addr</i>	<i>schset addr</i> RS-type address or register (2) - (12).
,SCHSET=0	Default: 0
,IOCTOKEN= <i>ioctoken addr</i>	<i>ioctoken addr</i> : RX-type address or register (2) - (12).
,PLISTVER=IMPLIED_VERSION	
,PLISTVER=MAX	Default: IMPLIED_VERSION
,PLISTVER= <i>plistver</i>	<i>plistver</i> : 2
,RETCODE= <i>retcode addr</i>	<i>retcode addr</i> : RX-type address or register (2) - (12).
,RSNCODE= <i>rsncode addr</i>	<i>rsncode addr</i> : RX-type address or register (2) - (12).

UCBINFO macro

Syntax	Description
,MF=(E, <i>list addr</i>)	<i>list addr</i> : RX-type address or address in register (2) - (12).
,MF=(E, <i>list addr</i> ,COMPLETE)	Default: COMPLETE

Parameters

The parameters are explained under the standard form of UCBINFO PATHINFO with the following exceptions:

,MF=(E,*list addr*)

,MF=(E,*list addr*,COMPLETE)

Specifies the execute form of the UCBINFO PATHINFO macro.

list addr specifies the area that the system uses to contain the parameters.

COMPLETE, which is the default, specifies that the macro is to check for required parameters and supply defaults for omitted optional parameters.

UCBINFO PATHMAP

Use the UCBINFO PATHMAP macro to obtain information about the device path.

Syntax

The standard form of the PATHMAP option of the UCBINFO macro is written as follows:

Syntax	Description
<i>name</i>	<i>name</i> : symbol. Begin <i>name</i> in column 1.
␣	One or more blanks must precede UCBINFO.
UCBINFO	
␣	One or more blanks must follow UCBINFO.
PATHMAP	
,MAPAREA= <i>maparea addr</i>	<i>maparea addr</i> : RX-type address or register (2) - (12).
,DEVN= <i>devn addr</i>	<i>devn addr</i> : RS-type address or register (2) - (12).
,SCHSET= <i>schset addr</i>	<i>schset addr</i> : RS-type address or register (2) - (12).
,SCHSET=0	Default: 0
,IOCTOKEN= <i>ioctoken addr</i>	<i>ioctoken addr</i> : RX-type address or register (2) - (12).

Syntax	Description
,PLISTVER=IMPLIED_VERSION	
,PLISTVER=MAX	Default: IMPLIED_VERSION
,PLISTVER= <i>plistver</i>	<i>plistver</i> : 2
,RETCODE= <i>retcode addr</i>	<i>retcode addr</i> : RX-type address or register (2) - (12).
,RSNCODE= <i>rsncode addr</i>	<i>rsncode addr</i> : RX-type address or register (2) - (12).

Parameters

The parameters are explained as follows:

PATHMAP

Specifies that the system is to return information about the device path for the specified device.

,MAPAREA=*maparea addr*

Specifies a required 40-byte field into which the system is to return information about the device path for the specified device. This field is mapped by the mapping macro IOSDMAP.

,DEVN=*devn addr*

Specifies the address of a halfword that contains, in binary form, the device number of the device.

,SCHSET=*schset addr*

,SCHSET=0

Specifies the name (RS-type), or address in register (2)-(12), of an optional byte input that specifies a subchannel set for which the information about the device path is to be returned. DEFAULT: 0.

,IOCTOKEN=*ioctoken addr*

Specifies the address of a 48-character storage area that contains the MVS I/O configuration token. The caller can obtain this token by issuing the IOCINFO macro. *z/OS MVS Programming: Assembler Services Reference ABE-HSP* If the I/O configuration token that is current when UCBINFO is invoked does not match the token whose address is supplied here, the system issues a return code to the caller.

If you set the input IOCTOKEN (specified by *ioctoken addr*) to binary zeros, UCBINFO sets IOCTOKEN to the current I/O configuration token.

,PLISTVER=IMPLIED_VERSION

,PLISTVER=MAX

,PLISTVER=*plistver*

Specifies the version of the macro. PLISTVER determines which parameter list the system generates. PLISTVER is an optional input parameter on all forms of the macro, including the list form. When using PLISTVER, specify it on all macro forms used for a request and with the same value on all of the macro forms. The values are:

- **IMPLIED_VERSION**, which is the lowest version that allows all parameters specified on the request to be processed. If you omit the PLISTVER parameter, IMPLIED_VERSION is the default.
- **MAX**, if you want the parameter list to be the largest size currently possible. This size might grow from release to release and affect the amount of storage that your program needs.

If you can tolerate the size change, IBM recommends that you always specify PLISTVER=MAX on the list form of the macro. Specifying MAX ensures that the list-form parameter list is always long enough to hold all the parameters you might specify on the execute form; in this way, MAX ensures that the parameter list does not overwrite nearby storage.

UCBINFO macro

- 2, if you use the currently available parameters.

To code, specify in this input parameter one of the following:

- IMPLIED_VERSION
- MAX
- A decimal value of 2

,RETCODE=retcode addr

Specifies the address of a fullword field into which the system copies the return code from GPR 15.

,RSNCODE=rsncode addr

Specifies the address of a fullword field into which the system copies the reason code from GPR 0.

Return and reason codes

When the UCBINFO PATHMAP macro returns control to your program, GPR 15 (or *retcode addr*, if you coded RETCODE) contains a return code, and GPR 0 (or *rsncode addr*, if you coded RSNCODE) contains a reason code.

Hexadecimal Return Code	Hexadecimal Reason Code	Meaning and Action
00	None	Meaning: The PATHMAP function completed successfully. Action: None.
04	None	Meaning: Program error. No UCB exists for the device number specified in the DEVN parameter. Action: Correct the device number and reissue the macro.
08	01	Meaning: Program error. A caller in AR mode specified an ALET that was not valid. Action: Correct the ALET and reissue the macro.
08	02	Meaning: Program error. An error occurred when the system tried to access the caller's parameter list. This might be due to using a keyword that requires authorization but the caller was not authorized, that is the Supervisor state or PSW key 0 - 7. Action: Ensure that you have met the environmental requirements for the macro, and reissue the macro.
08	05	Meaning: Program error. An error occurred when the system referenced the caller-supplied area specified in the IOCTOKEN parameter. This reason code is valid only for callers using the IOCTOKEN parameter. Action: Correct the IOCTOKEN parameter.
08	06	Meaning: Program error. An error occurred when the system attempted to reference the area specified by the MAPAREA parameter. Action: Correct the address specified for MAPAREA and reissue the macro.
08	0B	Meaning: The value specified on the SCHSET keyword is not valid. Action: Enter a valid value.
0C	None	Meaning: Environmental error. The I/O configuration token supplied through the IOCTOKEN parameter is not current. This return code is valid only for callers using the IOCTOKEN parameter. Action: Obtain the current I/O configuration token by issuing an IOCINFO macro or by setting the input IOCTOKEN parameter in the UCBINFO macro to zero.

Hexadecimal Return Code	Hexadecimal Reason Code	Meaning and Action
10	04	Meaning: System error. The subchannel is in permanent error and cannot be accessed. Action: Supply the return and reason code to the appropriate IBM support personnel.
20	None	Meaning: System error. An unexpected error occurred. Action: Supply the return code to the appropriate IBM support personnel.

Example

To invoke UCBINFO to return device path information, code:

```

UCBINFO PATHMAP ,MAPAREA=INFOAREA ,DEVN=DEVNUM,          X
RETCODE=INFORTCD
.
.
.
DS 0D
INFOAREA DS CL256
INFORTCD DS F
DEVNUM DS H

```

UCBINFO PATHMAP - List form

Use the list form of the PATHMAP option of the UCBINFO macro together with the execute form for applications that require reentrant code. The list form of the macro defines an area of storage that the execute form uses to contain the parameters.

This macro is an alternative list form macro, and requires a different technique for using the list form as compared to the conventional list form macros. See [Alternative list form macros](#) for further information.

The list form of the PATHMAP option of the UCBINFO macro is written as follows:

Syntax	Description
<i>name</i>	<i>name</i> : symbol. Begin <i>name</i> in column 1.
␣	One or more blanks must precede UCBINFO.
UCBINFO	
␣	One or more blanks must follow UCBINFO.
,PLISTVER=IMPLIED_VERSION	
,PLISTVER=MAX	Default: IMPLIED_VERSION
,PLISTVER= <i>plistver</i>	<i>plistver</i> : 2
MF=(L, <i>list addr</i>)	<i>list addr</i> : RX-type address

Syntax	Description
MF=(L, <i>list addr</i> , <i>attr</i>)	<i>attr</i> : 1- to 60-character input string
MF=(L, <i>list addr</i> ,0D)	Default: 0D

Parameters

The parameters are explained under the standard form of UCBINFO PATHMAP with the following exceptions:

MF=(L,*list addr*)

MF=(L,*list addr*,*attr*)

MF=(L,*list addr*,0D)

Specifies the list form of the UCBINFO PATHMAP macro.

list addr is the name of a storage area to contain the parameters.

attr is an optional 1- to 60-character input string, which can contain any value that is valid on an assembler DS pseudo-op. You can use this parameter to force boundary alignment of the parameter list. If you do not code *attr*, the system provides a value of 0D, which forces the parameter list to a doubleword boundary.

UCBINFO PATHMAP - Execute form

Use the execute form of the PATHMAP option of the UCBINFO macro together with the list form of the macro for applications that require reentrant code. The execute form of the macro stores the parameters into the storage area defined by the list form.

The execute form of the PATHMAP option of the UCBINFO macro is written as follows:

Syntax	Description
<i>name</i>	<i>name</i> : symbol. Begin <i>name</i> in column 1.
␣	One or more blanks must precede UCBINFO.
UCBINFO	
␣	One or more blanks must follow UCBINFO.
PATHMAP	
,MAPAREA= <i>maparea addr</i>	<i>maparea addr</i> : RX-type address or register (2) - (12).
,DEVN= <i>devn addr</i>	<i>devn addr</i> : RS-type address or register (2) - (12).
,SCHSET= <i>schset addr</i>	<i>schset addr</i> : RS-type address or register (2) - (12).

Syntax	Description
,SCHSET=0	Default: 0
,IOCTOKEN= <i>ioctoken addr</i>	<i>ioctoken addr</i> : RX-type address or register (2) - (12).
,PLISTVER=IMPLIED_VERSION	
,PLISTVER=MAX	Default: IMPLIED_VERSION
,PLISTVER= <i>plistver</i>	<i>plistver</i> : 2
,RETCODE= <i>retcode addr</i>	<i>retcode addr</i> : RX-type address or register (2) - (12).
,RSNCODE= <i>rsncode addr</i>	<i>rsncode addr</i> : RX-type address or register (2) - (12).
,MF=(E, <i>list addr</i>)	<i>list addr</i> : RX-type address or address in register (2) - (12).
,MF=(E, <i>list addr</i> ,COMPLETE)	Default: COMPLETE

Parameters

The parameters are explained under the standard form of the UCBINFO PATHMAP macro with the following exceptions:

,MF=(E,*list addr*)

,MF=(E,*list addr*,COMPLETE)

Specifies the execute form of the UCBINFO PATHMAP macro.

list addr specifies the area that the system uses to contain the parameters.

COMPLETE, which is the default, specifies that the macro is to check for required parameters and supply defaults for omitted optional parameters.

UCBINFO PAVINFO

Use the UCBINFO PAVINFO macro to obtain selected information applicable to each exposure (base and alias) of a Parallel Access Volume (PAV).

Syntax

The standard form of the PAVINFO option of the UCBINFO macro is written as follows:

Syntax	Description
<i>name</i>	<i>name</i> : symbol. Begin <i>name</i> in column 1.
␣	One or more blanks must precede UCBINFO.

UCBINFO macro

Syntax	Description
UCBINFO	
␣	One or more blanks must follow UCBINFO.
PAVINFO	
PAVINFOSUM=NO	Default: NO
PAVINFOSUM=YES	
,PAVAREA= <i>pavarea addr</i>	<i>pavarea addr</i> : RX-type address or register (2) - (12).
,PAVLEN= <i>pavarea addr</i>	<i>pavarea addr</i> : RX-type address or register (2) - (12).
,SCHINFO=NO	Default: NO
,SCHINFO=YES	
,EXTFORMAT=NO	Default: NO
,EXTFORMAT=YES	
,OUTVERSION= <i>outver</i>	Default: 3
,DEVN= <i>devn addr</i>	<i>devn addr</i> : RS-type address or register (2) - (12).
,SCHSET= <i>schset addr</i>	<i>schset addr</i> : RS-type address or register (2) - (12).
,SCHSET=0	Default: 0
,IOCTOKEN= <i>ioctoken addr</i>	<i>ioctoken addr</i> : RX-type address or register (2) - (12).
,PLISTVER=IMPLIED_VERSION	
,PLISTVER=MAX	Default: IMPLIED_VERSION
,PLISTVER= <i>plistver</i>	<i>plistver</i> : 2
,RETCODE= <i>retcode addr</i>	<i>retcode addr</i> : RX-type address or register (2) - (12).
,RSNCODE= <i>rsncode addr</i>	<i>rsncode addr</i> : RX-type address or register (2) - (12).

Parameters

The parameters are explained as follows:

PAVINFO

Obtain selected information that applies to each exposure of a Parallel Access Volume (PAV) device. The data returned by this function is mapped by the mapping macro IOSDPAVA and consists of a header and one or more entries. Depending on the input device, the following is returned:

- When the input device is a PAV-base, the first entry represents the base and each subsequent entry represents each of the bound PAV-alias devices associated with the base. Note that if the base has no bound PAV-aliases, then only the first entry is filled in.
- When the input is a non-PAV DASD device, only the first entry is filled in.
- When the input device is a PAV-alias or a non-DASD, a non-zero return code is returned.

PAVINFORMSUM=NO

PAVINFORMSUM=YES

Specifies whether to retrieve only a sum of channel measurement data and model dependent subchannel data for the base device and all of its aliases.

Note: The model dependent subchannel data is only retrieved if SCHINFO=YES.

NO

Do not just retrieve a total of channel measurement data and model dependent subchannel data for the base device and all of its aliases. This option causes a PAVA entry to be created for the base device and each of its aliases.

YES

Retrieve only a sum of channel measurement data and model dependent subchannel data for the base device and all of its aliases. This option causes the first PAVA entry to contain information on the base device, however, the measurement-related fields (such as PAVACMB, PAVASMDB, and PAVAECMB) will contain totals for the base and all of its aliases.

,PAVAREA=*pavarea addr*

Specifies the address of a required output field into which the system will return information about the alias UCBs for the specified base device number. This field is mapped by the mapping macro IOSDPAVA.

,PAVLEN=*pavarea addr*

Specifies the address or a register containing the length of the area specified by the PAVAREA parameter.

,SCHINFO=NO

,SCHINFO=YES

This parameter specifies whether or not to retrieve model-dependent subchannel data (control unit busy time, switch busy time, and device busy time) for the device. If you issue this request from a system running on a z990 or higher processor, the system ignores the SCHINFO parameter, but still returns the device busy time.

NO

Do not retrieve model-dependent subchannel data for the device. Note that even if you specify NO on a z990 or higher processor, the service will still return the device busy time.

YES

Retrieve model-dependent subchannel data for the device, which includes control unit busy time, switch busy time, and device busy time. If you specify YES on a z990 or higher processor, the service will still return the device busy time.

,EXTFORMAT=NO

,EXTFORMAT=YES

This parameter specifies whether an extended format PAV area should be created. An extended format PAV area contains a length field in each entry that defines the actual length of the entry. This allows the PAV entry to be extended compatibly to add new information. A non-extended

format PAV area contains entries which are fixed in size (60 bytes) and cannot be extended to contain new data. See the mapping macro IOSDPAVA for more information.

Note: The value specified for the EXTFORMAT keyword on the UCBINFO PAVINFO macro must match the value specified on the IOSDPAVA macro. Otherwise, your program may not work correctly.

NO

Create the non-extended format PAV area.

YES

Create the extended format PAV area.

,OUTVERSION=*outver*

Specifies the output version to be used when creating an extended format PAV area. The output version controls the size of the PAV entries that are returned. This parameter is used only if EXTFORMAT(YES) is specified; it is ignored for EXTFORMAT(NO) requests. If an output version that is less than 3 is specified, version 3 is used. If an output version that is higher than the currently supported version is specified, the highest supported version is used.

Note: Currently, version 3 is the only supported value.

,DEVN=*devn addr*

Specifies the address of a halfword that contains the base device number in binary form.

,SCHSET=*schset addr***,SCHSET=0**

Specifies the name (RS-type), or address in register (2)-(12), of an optional byte input that specifies a subchannel set for which the information that applies to each exposure of a Parallel Access Volume (PAV) device is to be obtained. DEFAULT: 0.

,IOCTOKEN=*ioctoken addr*

Specifies the address of a 48-character storage area that contains the MVS I/O configuration token. The caller can obtain this token by issuing the IOCINFO macro. *z/OS MVS Programming: Assembler Services Reference ABE-HSP* If the I/O configuration token that is current when UCBINFO is invoked does not match the token whose address is supplied here, the system issues a return code to the caller.

If you set the input IOCTOKEN (specified by *ioctoken addr*) to binary zeros, UCBINFO sets IOCTOKEN to the current I/O configuration token.

,PLISTVER=IMPLIED_VERSION**,PLISTVER=MAX****,PLISTVER=*plistver***

Specifies the version of the macro. PLISTVER determines which parameter list the system generates. PLISTVER is an optional input parameter on all forms of the macro, including the list form. When using PLISTVER, specify it on all macro forms used for a request and with the same value on all of the macro forms. The values are:

- **IMPLIED_VERSION**, which is the lowest version that allows all parameters specified on the request to be processed. If you omit the PLISTVER parameter, IMPLIED_VERSION is the default.
- **MAX**, if you want the parameter list to be the largest size currently possible. This size might grow from release to release and affect the amount of storage that your program needs.

If you can tolerate the size change, IBM recommends that you always specify PLISTVER=MAX on the list form of the macro. Specifying MAX ensures that the list-form parameter list is always long enough to hold all the parameters you might specify on the execute form; in this way, MAX ensures that the parameter list does not overwrite nearby storage.

- **2**, if you use the currently available parameters.

To code, specify in this input parameter one of the following:

- IMPLIED_VERSION
- MAX

- A decimal value in the range of 1 - 3.

,RETCODE=retcode addr

Specifies the address of a fullword field into which the system copies the return code from GPR 15.

,RSNCODE=rsncode addr

Specifies the address of a fullword field into which the system copies the reason code from GPR 0.

Return and reason codes

When the UCBINFO PAVINFO macro returns control to your program, GPR 15 (or *retcode addr*, if you coded RETCODE) contains a return code, and GPR 0 (or *rsncode addr*, if you coded RSNCODE) contains a reason code.

Hexadecimal Return Code	Hexadecimal Reason Code	Meaning and Action
00	None	Meaning: The PAVINFO function completed successfully. Action: None.
04	None	Meaning: Program error. No UCB exists for the device number specified in the DEVN parameter. Action: Correct the device number and reissue the macro.
08	01	Meaning: Program error. A caller in AR mode specified an ALET that was not valid. Action: Correct the ALET and reissue the macro.
08	02	Meaning: Program error. An error occurred when the system tried to access the caller's parameter list. This might be due to using a keyword that requires authorization but the caller was not authorized, that is the Supervisor state or PSW key 0 - 7. Action: Ensure that you have met the environmental requirements for the macro, and reissue the macro.
08	03	Meaning: Program error. An unauthorized caller specified the UCBPTR parameter. Action: Specify the DEVN parameter instead of the UCBPTR parameter to indicate the device for which the system is to obtain information.
08	05	Meaning: Program error. An error occurred when the system referenced the caller-supplied area specified in the IOCTOKEN parameter. This reason code is valid only for callers using the IOCTOKEN parameter. Action: Correct the IOCTOKEN parameter and reissue the macro.
08	0A	Meaning: Program error. An error occurred when the system attempted to reference the area specified by the PAVAREA parameter. Action: Correct the address specified on the PAVAREA parameter and reissue the macro.
08	0B	Meaning: The value specified on the SCHSET keyword is not valid. Action: Enter a valid value.
0C	None	Meaning: Environmental error. The I/O configuration token supplied through the IOCTOKEN parameter is not current. This return code is valid only for callers using the IOCTOKEN parameter. Action: Obtain the current I/O configuration token by issuing an IOCINFO macro or by setting the input IOCTOKEN parameter in the UCBINFO macro to zero.

Hexadecimal Return Code	Hexadecimal Reason Code	Meaning and Action
1C	01	Meaning: Program error. The device number provided by the caller specifies a device that is not a DASD or is a PAV alias device. Action: Correct the DEVN parameter and reissue the macro.
1C	02	Meaning: Program error. The work area specified with the PAVAREA parameter is not large enough to contain the minimum amount of data. No data is returned. Action: Increase the size of the specified work area and reissue the macro.
1C	03	Meaning: Program error. The work area specified with the PAVAREA parameter is not large enough to contain an entry for each alias device. Action: Increase the size of the specified work area and reissue the macro.
20	None	Meaning: System error. An unexpected error occurred. Action: Supply the return code to the appropriate IBM support personnel.
28	None	Meaning: Program error. The device number provided by the caller is an alias device number of a parallel access volume. The caller must specify the base device number. Action: Correct the DEVN parameter and reissue the macro.

Example

To invoke UCBINFO to return information about alias UCBs for a base device number, code:

```
UCBINFO PAVINFO,DEVN=DEVNUM,PAVAREA=INFOAREA,PAVLEN=AREALEN, X
        RETCODE=INFORTCD
        .
        .
        .
DEVNUM  DS  0D
INFOAREA DS  H
AREALEN DS  CL256
INFORTCD DS  F
```

UCBINFO PAVINFO - List form

Use the list form of the PAVINFO option of the UCBINFO macro together with the execute form for applications that require reentrant code. The list form of the macro defines an area of storage that the execute form uses to contain the parameters.

The list form of the PAVINFO option of the UCBINFO macro is written as follows:

Syntax	Description
<i>name</i>	<i>name</i> : symbol. Begin <i>name</i> in column 1.
␣	One or more blanks must precede UCBINFO.
UCBINFO	
␣	One or more blanks must follow UCBINFO.

Syntax	Description
,PLISTVER=IMPLIED_VERSION	
,PLISTVER=MAX	Default: IMPLIED_VERSION
,PLISTVER= <i>plistver</i>	<i>plistver</i> : 2
MF=(L, <i>list addr</i>)	<i>list addr</i> : RX-type address
MF=(L, <i>list addr</i> , <i>attr</i>)	<i>attr</i> : 1- to 60-character input string
MF=(L, <i>list addr</i> ,0D)	Default: 0D

Parameters

The parameters are explained under the standard form of UCBINFO PAVINFO with the following exceptions:

MF=(L,*list addr*)

MF=(L,*list addr*,*attr*)

MF=(L,*list addr*,0D)

Specifies the list form of the UCBINFO PAVINFO macro.

list addr is the name of a storage area to contain the parameters.

attr is an optional 1- to 60-character input string, which can contain any value that is valid on an assembler DS pseudo-op. You can use this parameter to force boundary alignment of the parameter list. If you do not code *attr*, the system provides a value of X'0D', which forces the parameter list to a doubleword boundary.

UCBINFO PAVINFO - Execute form

Use the execute form of the PAVINFO option of the UCBINFO macro together with the list form of the macro for applications that require reentrant code. The execute form of the macro stores the parameters into the storage area defined by the list form.

The execute form of the PAVINFO option of the UCBINFO macro is written as follows:

Syntax	Description
<i>name</i>	<i>name</i> : symbol. Begin <i>name</i> in column 1.
␣	One or more blanks must precede UCBINFO.
UCBINFO	
␣	One or more blanks must follow UCBINFO.
PAVINFO	

UCBINFO macro

Syntax	Description
PAVINFOSUM=NO	Default: NO
PAVINFOSUM=YES	
,PAVAREA= <i>pavarea addr</i>	<i>pavarea addr</i> : RX-type address or register (2) - (12).
,PAVLEN= <i>pavlen addr</i>	<i>pavlen addr</i> : RX-type address or register (2) - (12).
,SCHINFO=NO	Default: NO
,SCHINFO=YES	
,EXTFORMAT=NO	Default: NO
,EXTFORMAT=YES	
,OUTVERSION= <i>outver</i>	Default: 3
,DEVN= <i>devn addr</i>	<i>devn addr</i> : RX-type address or register (2) - (12).
,SCHSET= <i>schset addr</i>	<i>schset addr</i> : RS-type address or register (2) - (12).
,SCHSET=0	Default: 0
,IOCTOKEN= <i>ioctoken addr</i>	<i>ioctoken addr</i> : RX-type address or register (2) - (12).
,PLISTVER=IMPLIED_VERSION	
,PLISTVER=MAX	Default: IMPLIED_VERSION
,PLISTVER= <i>plistver</i>	<i>plistver</i> : 2
,RETCODE= <i>retcode addr</i>	<i>retcode addr</i> : RX-type address or register (2) - (12).
,RSNCODE= <i>rsncode addr</i>	<i>rsncode addr</i> : RX-type address or register (2) - (12).
,MF=(E, <i>list addr</i>)	<i>list addr</i> : RX-type address or address in register (2) - (12).
,MF=(E, <i>list addr</i> ,COMPLETE)	Default: COMPLETE

Parameters

The parameters are explained under the standard form of UCBINFO PAVINFO with the following exceptions:

,MF=(E,*list addr*)

,MF=(E,*list addr*,COMPLETE)

Specifies the execute form of the UCBINFO PAVINFO macro.

list addr specifies the area that the system uses to contain the parameters.

COMPLETE, which is the default, specifies that the macro is to check for required parameters and supply defaults for omitted optional parameters.

UCBINFO PRFXDATA

Use the UCBINFO PRFXDATA macro to obtain a copy of the UCB prefix extension segment.

Syntax

The standard form of the PRFXDATA option of the UCBINFO macro is written as follows:

Syntax	Description
<i>name</i>	<i>name</i> : symbol. Begin <i>name</i> in column 1.
␣	One or more blanks must precede UCBINFO.
UCBINFO	
␣	One or more blanks must follow UCBINFO.
PRFXDATA	
,DEVN= <i>devn addr</i>	<i>devn addr</i> : RS-type address or register (2) - (12).
,SCHSET= <i>schset addr</i>	<i>schset addr</i> : RS-type address or register (2) - (12).
,SCHSET=0	Default: 0
,UCBPAREA= <i>ucbparea addr</i>	<i>ucbparea addr</i> : RX-type address or register (2) - (12).
,IOCTOKEN= <i>ioctoken addr</i>	<i>ioctoken addr</i> : RX-type address or register (2) - (12).
,PLISTVER=IMPLIED_VERSION	
,PLISTVER=MAX	Default: IMPLIED_VERSION
,PLISTVER= <i>plistver</i>	<i>plistver</i> : 2
,RETCODE= <i>retcode addr</i>	<i>retcode addr</i> : RX-type address or register (2) - (12).

Syntax	Description
,RSNCODE= <i>rsncode addr</i>	<i>rsncode addr</i> : RX-type address or register (2) - (12).

Parameters

The parameters are explained as follows:

PRFXDATA

Specifies that the system is to obtain information from the UCB prefix extension segment.

,DEVN=*devn addr*

Specifies the address of a halfword that contains, in binary form, the device number of the device.

,SCHSET=*schset addr*

,SCHSET=0

Specifies the name (RS-type), or address in register (2)-(12), of an optional byte input that specifies a subchannel set for which the information from the UCB prefix extension segment is to be obtained.

DEFAULT: 0.

,UCBPAREA=*ucbparea addr*

Specifies the address of a 48-character storage area into which the system copies the UCB prefix extension segment. The IOSDUPI mapping macro maps the area.

,IOCTOKEN=*ioctoken addr*

Specifies the address of a 48-character storage area that contains the MVS I/O configuration token. The caller can obtain this token by issuing the IOCINFO macro. *z/OS MVS Programming: Assembler Services Reference ABE-HSP* If the I/O configuration token that is current when UCBINFO is invoked does not match the token whose address is supplied here, the system issues a return code to the caller.

If you set the input IOCTOKEN (specified by *ioctoken addr*) to binary zeros, UCBINFO sets IOCTOKEN to the current I/O configuration token.

,PLISTVER=IMPLIED_VERSION

,PLISTVER=MAX

,PLISTVER=*plistver*

Specifies the version of the macro. PLISTVER determines which parameter list the system generates. PLISTVER is an optional input parameter on all forms of the macro, including the list form. When using PLISTVER, specify it on all macro forms used for a request and with the same value on all of the macro forms. The values are:

- **IMPLIED_VERSION**, which is the lowest version that allows all parameters specified on the request to be processed. If you omit the PLISTVER parameter, IMPLIED_VERSION is the default.
- **MAX**, if you want the parameter list to be the largest size currently possible. This size might grow from release to release and affect the amount of storage that your program needs.

If you can tolerate the size change, IBM recommends that you always specify PLISTVER=MAX on the list form of the macro. Specifying MAX ensures that the list-form parameter list is always long enough to hold all the parameters you might specify on the execute form; in this way, MAX ensures that the parameter list does not overwrite nearby storage.

- **2**, if you use the currently available parameters.

To code, specify in this input parameter one of the following:

- IMPLIED_VERSION
- MAX
- A decimal value of 2

,RETCODE=retcode addr

Specifies the address of a fullword field into which the system copies the return code from GPR 15.

,RSNCODE=rsncode addr

Specifies the address of a fullword field into which the system copies the reason code from GPR 0.

Return and reason codes

When the UCBINFO PRFXDATA macro returns control to your program, GPR 15 (or *retcode addr*, if you coded RETCODE) contains a return code, and GPR 0 (or *rsncode addr*, if you coded RSNCODE) contains a reason code.

Hexadecimal Return Code	Hexadecimal Reason Code	Meaning and Action
00	None	Meaning: The PRFXDATA function completed successfully. Action: None.
04	None	Meaning: Program error. No UCB exists for the device number specified in the DEVN parameter. Action: Correct the device number and reissue the macro.
08	01	Meaning: Program error. A caller in AR mode specified an ALET that was not valid. Action: Correct the ALET and reissue the macro.
08	02	Meaning: Program error. An error occurred when the system tried to access the caller's parameter list. This might be due to using a keyword that requires authorization but the caller was not authorized, that is the Supervisor state or PSW key 0 - 7. Action: Ensure that you have met the environmental requirements for the macro, and reissue the macro.
08	03	Meaning: Program error. An unauthorized caller specified the UCBPTR parameter. Action: Specify the DEVN parameter instead of the UCBPTR parameter to indicate the device for which the system is to obtain information.
08	05	Meaning: Program error. An error occurred when the system referenced the caller-supplied area specified in the IOCTOKEN parameter. This reason code is valid only for callers using the IOCTOKEN parameter. Action: Correct the IOCTOKEN parameter.
08	0B	Meaning: The value specified on the SCHSET keyword is not valid. Action: Enter a valid value.
0C	None	Meaning: Environmental error. The I/O configuration token supplied through the IOCTOKEN parameter is not current. This return code is valid only for callers using the IOCTOKEN parameter. Action: Obtain the current I/O configuration token by issuing an IOCINFO macro or by setting the input IOCTOKEN parameter in the UCBINFO macro to zero.
20	None	Meaning: System error. An unexpected error occurred. Action: Supply the return code to the appropriate IBM support personnel.

Example

To invoke UCBINFO to obtain a copy of the UCB prefix extension segment, code:

UCBINFO macro

```
UCBINFO PRFXDATA,DEVN=DEVNUM,UCBPAREA=UAREA,          X
RETCODE=INFORTCD
.
.
.
DEVNUM DS 0D
UAREA  DS H
INFORTCD DS CL48
INFORTCD DS F
```

UCBINFO PRFXDATA - List form

Use the list form of the PRFXDATA option of the UCBINFO macro together with the execute form for applications that require reentrant code. The list form of the macro defines an area of storage that the execute form uses to contain the parameters.

This macro is an alternative list form macro, and requires a different technique for using the list form as compared to the conventional list form macros. See [Alternative list form macros](#) for further information.

The list form of the PRFXDATA option of the UCBINFO macro is written as follows:

Syntax	Description
<i>name</i>	<i>name</i> : symbol. Begin <i>name</i> in column 1.
␣	One or more blanks must precede UCBINFO.
UCBINFO	
␣	One or more blanks must follow UCBINFO.
,PLISTVER=IMPLIED_VERSION	
,PLISTVER=MAX	Default: IMPLIED_VERSION
,PLISTVER= <i>plistver</i>	<i>plistver</i> : 2
MF=(L, <i>list addr</i>)	<i>list addr</i> : RX-type address
MF=(L, <i>list addr</i> , <i>attr</i>)	<i>attr</i> : 1- to 60-character input string
MF=(L, <i>list addr</i> ,0D)	Default: 0D

Parameters

The parameters are explained under the standard form of UCBINFO PRFXDATA with the following exceptions:

MF=(L,*list addr*)

MF=(L,*list addr*,*attr*)

MF=(L,*list addr*,0D)

Specifies the list form of the UCBINFO PRFXDATA macro.

list addr is the name of a storage area to contain the parameters.

attr is an optional 1- to 60-character input string, which can contain any value that is valid on an assembler DS pseudo-op. You can use this parameter to force boundary alignment of the parameter list. If you do not code *attr*, the system provides a value of 0D, which forces the parameter list to a doubleword boundary.

UCBINFO PRFXDATA - Execute form

Use the execute form of the PRFXDATA option of the UCBINFO macro together with the list form of the macro for applications that require reentrant code. The execute form of the macro stores the parameters into the storage area defined by the list form.

The execute form of the PRFXDATA option of the UCBINFO macro is written as follows:

Syntax	Description
<i>name</i>	<i>name</i> : symbol. Begin <i>name</i> in column 1.
␣	One or more blanks must precede UCBINFO.
UCBINFO	
␣	One or more blanks must follow UCBINFO.
PRFXDATA	
,DEVN= <i>devn addr</i>	<i>devn addr</i> : RS-type address or register (2) - (12).
,SCHSET= <i>schset addr</i>	<i>schset addr</i> : RS-type address or register (2) - (12).
,SCHSET=0	Default: 0
,UCBPTR= <i>ucbptr addr</i>	<i>ucbptr addr</i> : RS-type address or register (2) - (12). Note: Specify either DEVN or UCBPTR, but not both.
,UCBPAREA= <i>ucbparea addr</i>	<i>ucbparea addr</i> : RX-type address or register (2) - (12).
,IOCTOKEN= <i>ioctoken addr</i>	<i>ioctoken addr</i> : RX-type address or register (2) - (12).
,PLISTVER=IMPLIED_VERSION	
,PLISTVER=MAX	Default: IMPLIED_VERSION
,PLISTVER= <i>plistver</i>	<i>plistver</i> : 2

UCBINFO macro

Syntax	Description
,RETCODE= <i>retcode addr</i>	<i>retcode addr</i> : RX-type address or register (2) - (12).
,RSNCODE= <i>rsncode addr</i>	<i>rsncode addr</i> : RX-type address or register (2) - (12).
,MF=(E, <i>list addr</i>)	<i>list addr</i> : RX-type address or address in register (2) - (12).
,MF=(E, <i>list addr</i> ,COMPLETE)	Default: COMPLETE

Parameters

The parameters are explained under the standard form of UCBINFO PRFXDATA with the following exceptions:

,MF=(E,*list addr*)

,MF=(E,*list addr*,COMPLETE)

Specifies the execute form of the UCBINFO PRFXDATA macro.

list addr specifies the area that the system uses to contain the parameters.

COMPLETE, which is the default, specifies that the macro is to check for required parameters and supply defaults for omitted optional parameters.

Chapter 113. UCBSCAN – Scan UCBs

Description

Use the UCBSCAN macro to scan unit control blocks (UCBs) and return a copy of a UCB.

Two types of scans are available with UCBSCAN: A scan of all UCBs, and a scan of all UCBs within a particular device class. For each type of scan, the caller may optionally:

- Restrict the scan to UCBs defined as static or installation-static.
- Restrict the scan to UCBs with 3-digit device numbers.
- Request alias UCBs for a parallel access volume.
- Specify the device number with which the scan should begin.

UCBSCAN presents the UCBs in ascending device number order. On each invocation, UCBSCAN returns a copy of requested UCB segments and data in caller-supplied areas. See [z/OS MVS Programming: Assembler Services Guide](#) for information on accessing UCBs.

Environment

The requirements for the caller are:

Environmental factor	Requirement
Minimum authorization:	Problem state with any PSW key.
Dispatchable unit mode:	Task or SRB
Cross memory mode:	Any PASN, any HASN, any SASN.
AMODE:	24- or 31-bit.
ASC mode:	Primary or access register (AR).
Interrupt status:	Enabled or disabled for I/O and external interrupts
Locks:	The caller may hold locks, but is not required to hold any.
Control parameters:	Must be in the primary address space or, for AR-mode callers, must be in an address/data space that is addressable through a public entry on the caller's dispatchable unit access list (DU-AL).

Programming requirements

If in AR mode, issue SYSSTATE ASCENV=AR before issuing UCBSCAN.

Restrictions

None.

Input register information

Before issuing the UCBSCAN macro, the caller does not have to place any information into any register unless using it in register notation for a particular parameter, or using it as a base register.

Output register information

When control returns to the caller, the general purpose registers (GPRs) contain:

Register Contents

0

Reason code if GPR 15 contains a return code of 04 or 08; otherwise, used as a work register by the system

1

Used as a work register by the system

2-13

Unchanged

14

Used as a work register by the system

15

Return code

When control returns to the caller, the access registers (ARs) contain:

Register Contents

0-1

Used as work registers by the system

2-13

Unchanged

14-15

Used as work registers by the system

Performance implications

None.

Syntax

The standard form of the UCBSCAN macro is written as follows:

Syntax	Description
<i>name</i>	<i>name</i> : Symbol. Begin <i>name</i> in column 1.
	One or more blanks must precede UCBSCAN.
UCBSCAN	
	One or more blanks must follow UCBSCAN.
COPY	
,WORKAREA= <i>workarea addr</i>	<i>workarea addr</i> : RX-type address or register (2) - (12).

Syntax	Description
,UCBAREA= <i>ucbarea addr</i>	<i>ucbarea addr</i> : RX-type address or register (2) - (12).
,CMXTAREA= <i>cmxtarea addr</i>	<i>cmxtarea addr</i> : RX-type address or register (2) - (12).
,CMXTAREA=NONE	Default: NONE
,UCBPAREA= <i>ucbparea addr</i>	<i>ucbparea addr</i> : RX-type address or register (2) - (12).
,UCBPAREA=NONE	Default: NONE
,DCEAREA= <i>dcearea addr</i>	<i>dcearea addr</i> : RX-type address or register (2) - (12).
,DCEAREA=NONE	Default: NONE
,DCELEN= <i>length addr</i>	<i>length addr</i> : RS-type address or register (2) - (12).
	Note: DCELEN is valid only with DCEAREA and is required with DCEAREA.
,VOLSER= <i>volser addr</i>	<i>volser addr</i> : RS-type address or register (2) - (12).
,VOLSER=NONE	Default: NONE
,DEVNCHAR= <i>devnchar addr</i>	<i>devnchar addr</i> : RS-type address or register (2) - (12).
,DEVN= <i>devn addr</i>	<i>devn addr</i> : RS-type address or register (2) - (12).
,DEVN=0	Default: 0
,DYNAMIC=NO	Default: NO
,DYNAMIC=YES	
,RANGE=3DIGIT	Default: 3DIGIT
,RANGE=ALL	
,UNBOUND_ALIAS=NO	Default: NO
,UNBOUND_ALIAS=YES	
SPECIAL=NO	Default: NO
SPECIAL=YES	
SPECIAL=ONLY	

Syntax	Description
,DEVCLASS=ALL	Default: ALL
,DEVCLASS=CHAR	
,DEVCLASS=COMM	
,DEVCLASS=CTC	
,DEVCLASS=DASD	
,DEVCLASS=DISP	
,DEVCLASS=TAPE	
,DEVCLASS=UREC	
,DEVCID= <i>devcid addr</i>	<i>devcid addr</i> : RS-type address
,DEVCID=0	Default: 0
,IOCTOKEN= <i>ioctoken addr</i>	<i>ioctoken addr</i> : RX-type address or register (2) - (12).
,IOCTOKEN=NONE	Default: NONE
,PLISTVER=IMPLIED_VERSION	
,PLISTVER=MAX	Default: IMPLIED_VERSION
,PLISTVER= <i>plistver</i>	<i>plistver</i> : 1
,RETCODE= <i>retcode addr</i>	<i>retcode addr</i> : RX-type address or register (2) - (12).
,RSNCODE= <i>rsncode addr</i>	<i>rsncode addr</i> : RX-type address or register (2) - (12).

Parameters

The parameters are explained as follows:

COPY

Specifies that a copy of the UCB is to be obtained. See [z/OS HCD Planning](#) for a list of the MVS services that accept a UCB copy.

Note: When you issue UCBSCAN to obtain a UCB copy, the UCBID field in the copy is set to x'CC'.

,WORKAREA=*workarea addr*

Specifies the address of a 100-character work area used by the UCBSCAN service. The caller must initialize this work area to binary zeros before starting a UCB scan. On subsequent invocations of UCBSCAN within the same scan, the caller must leave the contents of this work area unchanged.

,UCBAREA=ucbarea addr

Specifies the address of a 48-character storage area that will receive a copy of the UCB common segment and the UCB device-dependent segment. See *z/OS HCD Planning* for a list of the MVS services that accept a UCB copy.

The caller does not need to initialize this area. Use the IEFUCBOB mapping macro to map the area. The contents of certain fields in the copy are:

- The UCBEXTP field contains either:
 - The address of the CMXTAREA, if CMXTAREA is below 16 MB
 - 0, if CMXTAREA is above 16 MB or if the CMXTAREA parameter is not specified
- The UCBNXUCB field is 0, because this field is not valid in the UCB copy.
- Address fields in the copy might not contain valid addresses, so do not use these addresses to reference the data areas they point to.

,CMXTAREA=cmxtarea addr**,CMXTAREA=NONE**

Specifies the address of a 32-character storage area that will receive a copy of the UCB common extension segment. See *z/OS HCD Planning* for a list of the MVS services that accept a UCB copy and require this segment as part of a UCB copy.

Use the UCBCMEXT DSECT in the IEFUCBOB mapping macro to map the area. If the CMXTAREA area is below 16 MB, the UCBEXTP field in the UCBAREA area contains the address of the CMXTAREA area. If the CMXTAREA area is above 16 MB, the caller must explicitly supply the address of the CMXTAREA area because the UCBEXTP field will contain 0.

The UCBIEXT field contains 0 because this field is not valid in the UCB copy.

The UCBCLEXT field contains the address of the DCEAREA if the UCB has a device class extension and the caller specified the DCEAREA parameter. Otherwise, the field contains 0.

,UCBPAREA=ucbparea addr**,UCBPAREA=NONE**

Specifies the address of a 48-character storage area that will receive a copy of the UCB prefix extension segment. This keyword is required if SUBCHANNELSET=ALL is specified. The area can be mapped by the IOSDUPI mapping macro.

,DCEAREA=dcearea addr**,DCEAREA=NONE**

Specifies the address of a storage area that will receive a copy of the UCB device class extension segment. See *z/OS HCD Planning* for a list of the MVS services that accept a UCB copy and require this segment as part of a UCB copy.

Note: If DCEAREA=NONE is coded, then DCELEN=0 must be coded. If DCEAREA=NONE is defaulted, then DCELEN does not have to be coded.

,DCELEN=length addr

Specifies the address of a 2-byte field that contains the length of the area specified by DCEAREA. The length specified must be 1 through 256 bytes. DCELEN is required with DCEAREA.

,VOLSER=volser addr**,VOLSER=NONE**

Specifies the address of a 6-character field that indicates, in EBCDIC, the volume serial number of the device for which a UCB copy is to be obtained.

,DEVNCHAR=devnchar addr

Specifies the address of a 4-character field that is to receive the EBCDIC device number associated with the UCB copy.

,DEVN=devn addr**,DEVN=0**

Specifies (DEVN=devn addr) an input halfword that contains, in binary form, the device number with which the scan is to begin. The default, DEVN=0, starts the scan with the first UCB.

,SUBCHANNELSET=ID

,SUBCHANNELSET=ALL

,SUBCHANNELSET=ID

Indicates the UCB scan is based on one subchannel set. DEFAULT: ID

,SCHSET=*x*schset

SCHSET=0

Specifies the name (RS-type), or address in register (2)-(12), of an optional byte input that specifies a subchannel set for which the UCB scan is to be performed. DEFAULT: 0.

,SUBCHANNELSET=ALL

Indicates the UCB scan is based on all subchannel sets. DEFAULT: ID

,LDEVNCHAR=*x*ldevnchar

Indicates the name (RS-type), or address in register (2)-(12), of an optional 5 character output which is to contain the EBCDIC logical device number associated with the UCB copy.

Note: A logical device number is represented by the 1-digit subchannel set id followed by a 4-digit device number, sdddd.

,DYNAMIC=NO

,DYNAMIC=YES

Specifies whether the scan should be restricted to static and installation-static UCBs (DYNAMIC=NO) or should also include dynamic UCBs (DYNAMIC=YES).

,RANGE=3DIGIT

,RANGE=ALL

Specifies whether the scan should be restricted to UCBs with 3-digit device numbers (3DIGIT) or should also include UCBs with 4-digit device numbers (ALL).

,UNBOUND_ALIAS=NO

,UNBOUND_ALIAS=YES

,UNBOUND_ALIAS=ONLY

Specifies whether the scan should include unbound alias UCBs.

YES

Include unbound alias UCBs

NO

Do not include unbound alias UCBs

ONLY

Include only unbound alias UCBs

Note: The UNBOUND_ALIAS function is intended for IOS use only.

SPECIAL=NO

SPECIAL=YES

SPECIAL=ONLY

Specifies whether the UCB is findable (SPECIAL=YES) or not (SPECIAL=NO). SPECIAL=ONLY should be used to scan for only special devices. Special devices are those UCBs that represent devices that are not PAV-alias devices in the alternate subchannel set. The 3390S and 3390D device types are special devices.

,DEVCLASS=ALL

,DEVCLASS=CHAR

,DEVCLASS=COMM

,DEVCLASS=CTC

,DEVCLASS=DASD

,DEVCLASS=DISP

,DEVCLASS=TAPE

,DEVCLASS=UREC

Specifies the device class that is to be scanned:

ALL

Scans UCBs for all device classes

CHAR

Scans UCBs for character reader device class

COMM

Scans UCBs for communications device class

CTC

Scans UCBs for channel to channel device class

DASD

Scans UCBs for direct access device class

DISP

Scans UCBs for display device class

TAPE

Scans UCBs for tape device class

UREC

Scans UCBs for unit record device class

,DEVCID=*devcid addr*

Specifies the address of an 8-bit input field that contains the device class ID of the device class to be scanned. The value in this byte represents the third byte in the UCBTYP field of each device in the class.

If you specify DEVCID, only UCBs of the particular device class specified will be presented, and the DEVCLASS parameter is ignored.

,IOCTOKEN=*ioctoken addr***,IOCTOKEN=NONE**

Specifies the address of a 48-character storage area that contains the MVS I/O configuration token. The caller can obtain this token by issuing the IOCINFO macro. If the I/O configuration token that is current when UCBSCAN is invoked does not match the token whose address is supplied as input by *ioctoken addr*, the caller will be notified through a return code.

If the input IOCTOKEN (specified by *ioctoken addr*) is set to binary zeros, UCBSCAN will set IOCTOKEN to the current I/O configuration token at the start of the scan.

,PLISTVER=IMPLIED_VERSION**,PLISTVER=MAX****,PLISTVER=*plistver***

Specifies the version of the macro. PLISTVER determines which parameter list the system generates. PLISTVER is an optional input parameter on all forms of the macro, including the list form. When using PLISTVER, specify it on all macro forms used for a request and with the same value on all of the macro forms. The values are:

- **IMPLIED_VERSION**, which is the lowest version that allows all parameters specified on the request to be processed. If you omit the PLISTVER parameter, IMPLIED_VERSION is the default.
- **MAX**, if you want the parameter list to be the largest size currently possible. This size might grow from release to release and affect the amount of storage that your program needs.

If you can tolerate the size change, IBM recommends that you always specify PLISTVER=MAX on the list form of the macro. Specifying MAX ensures that the list-form parameter list is always long enough to hold all the parameters you might specify on the execute form; in this way, MAX ensures that the parameter list does not overwrite nearby storage.

- **1**, if you use the currently available parameters.

To code, specify in this input parameter one of the following:

- IMPLIED_VERSION
- MAX
- A decimal value of 1

,RETCODE=retcode addr

Specifies the fullword location where the system is to store the return code. The return code is also in GPR 15.

,RSNCODE=rsncode addr

Specifies the fullword location where the system is to store the reason code. The reason code is also in GPR 0.

Return and reason codes

When control returns from USBSCAN, GPR 15 (and *retcode addr*, if you coded RETCODE) contains a return code and, for some return codes, GPR 0 (or *rsncode addr*, if you coded RSNCODE) contains a reason code.

Hexadecimal Return Code	Hexadecimal Reason Code	Meaning and Action
00	None	Meaning: UCBSCAN completed successfully. Action: None.
04	01	Meaning: UCBSCAN processing ended. All UCBs that met the search criteria have been presented to the caller. The contents of UCBAREA are unchanged, and WORKAREA has been reset to binary zeros. Action: None.
08	01	Meaning: Program error. A caller in AR mode specified an ALET that was not valid. Action: Correct the ALET and reissue the macro. Possibly the caller wrote over an area in the parameter list; look for this error.
08	02	Meaning: Program error. An error occurred when the system tried to access the caller's parameter list. Action: Ensure that you have met the environmental requirements for the macro, and reissue the macro.
08	03	Meaning: Program error. An error occurred in referencing the caller-supplied area for the UCB copy; the area was specified in the UCBAREA parameter. Action: Correct the UCBAREA parameter.
08	04	Meaning: Program error. An error occurred in referencing the caller-supplied area for the UCB prefix extension segment data. This reason code is valid only for callers using the UCBPAREA parameter. Action: Correct the UCBPAREA parameter.
08	05	Meaning: Program error. An error occurred when the system referenced the caller-supplied area specified in the IOCTOKEN parameter. This reason code is valid only for callers using the IOCTOKEN parameter. Action: Correct the IOCTOKEN parameter.
08	08	Meaning: Program error. An error occurred in referencing the caller-supplied work area specified in the WORKAREA parameter. Action: Correct the WORKAREA parameter.
08	09	Meaning: Program error. An error occurred in referencing the caller-supplied CMXTAREA area. This reason code is valid only for callers using the CMXTAREA parameter. Action: Correct the CMXTAREA parameter.

Hexadecimal Return Code	Hexadecimal Reason Code	Meaning and Action
08	0B	Meaning: Program error. An error occurred in referencing the caller-supplied DCEAREA area. This reason code is valid only for callers using the DCEAREA parameter. Action: Correct the DCEAREA parameter.
08	0C	Meaning: Program error. The caller specified a volume serial number that is not valid. (Note that binary zeros are not considered valid.) This reason code is valid only for callers using the VOLSER parameter. Action: Correct the VOLSER parameter.
08	0D	Meaning: Program error. For the DCEAREA token, the caller specified a length that is negative, is zero, or exceeds 256 bytes. This reason code is valid only for callers using the DCELEN parameter. Action: Correct the DCELEN parameter.
08	0E	Meaning: The value specified on the SCHSET keyword is not valid. Action: Correct the SCHSET value.
0C	None	Meaning: Environmental error. The I/O configuration has changed, so that the I/O configuration token supplied through the IOCTOKEN parameter is not current. This return code is valid only for callers using the IOCTOKEN parameter. Action: Obtain the current I/O configuration token by issuing an IOCINFO macro or by setting the input IOCTOKEN parameter in the UCBINFO macro to zero. Start the scan from the beginning.
20	None	Meaning: System error. An unexpected error occurred. Action: Supply the return code to the appropriate IBM support personnel.

UCBSCAN COPY - List form

Use the list form of the UCBSCAN macro together with the execute form for applications that require reentrant code. The list form of the macro defines an area of storage that the execute form uses for storing the parameters.

Syntax

This macro is an alternative list form macro, and requires a different technique for using the list form as compared to the conventional list form macros. See [Alternative list form macros](#) for further information.

The list form of the COPY function of the UCBSCAN macro is written as follows:

Syntax	Description
<i>name</i>	<i>name</i> : Symbol. Begin <i>name</i> in column 1.
␣	One or more blanks must precede UCBSCAN.
UCBSCAN	
␣	One or more blanks must follow UCBSCAN.

Syntax	Description
,PLISTVER=IMPLIED_VERSION	
,PLISTVER=MAX	Default: IMPLIED_VERSION
,PLISTVER= <i>plistver</i>	<i>plistver</i> : 1
MF=(L, <i>list addr</i>)	<i>list addr</i> : Symbol.
MF=(L, <i>list addr,attr</i>)	<i>attr</i> : 1- to 60-character input string.
MF=(L, <i>list addr,OD</i>)	Default: 0D

Parameters

The parameters are explained under that standard form of the UCBSCAN macro with the following exceptions:

MF=(L,*list addr*)

MF=(L,*list addr,attr*)

MF=(L,*list addr,OD*)

Specifies the list form of the UCBSCAN macro.

The *list addr* parameter specifies the address of the storage area for the parameter list.

attr is an optional 1- to 60-character input string, which can contain any value that is valid on an assembler DS pseudo-op. You can use this parameter to force boundary alignment of the parameter list. If you do not code *attr*, the system provides a value of 0D, which forces the parameter list to a doubleword boundary.

UCBSCAN COPY - Execute form

Use the execute form of the UCBSCAN macro together with the list form for applications that require reentrant code. The execute form of the macro stores the parameters into the storage area defined by the list form.

Syntax

The execute form of the COPY function of the UCBSCAN macro is written as follows:

Syntax	Description
<i>name</i>	<i>name</i> : Symbol. Begin <i>name</i> in column 1.
␣	One or more blanks must precede UCBSCAN.
UCBSCAN	
␣	One or more blanks must follow UCBSCAN.

Syntax	Description
COPY	
,WORKAREA= <i>workarea addr</i>	<i>workarea addr</i> : RX-type address or register (2) - (12).
,UCBAREA= <i>ucbarea addr</i>	<i>ucbarea addr</i> : RX-type address or register (2) - (12).
,CMXTAREA= <i>cmxtarea addr</i>	<i>cmxtarea addr</i> : RX-type address or register (2) - (12).
,CMXTAREA=NONE	Default: NONE
,UCBPAREA= <i>ucbparea addr</i>	<i>ucbparea addr</i> : RX-type address or register (2) - (12).
,UCBPAREA=NONE	Default: NONE
,DCEAREA= <i>dcearea addr</i>	<i>dcearea addr</i> : RX-type address or register (2) - (12).
,DCEAREA=NONE	Default: NONE
,DCELEN= <i>length addr</i>	<i>length addr</i> : RS-type address or register (2) - (12).
	Note: DCELEN is valid only with DCEAREA and is required with DCEAREA.
,VOLSER= <i>volser addr</i>	<i>volser addr</i> : RS-type address or register (2) - (12).
,VOLSER=NONE	Default: NONE
,DEVNCHAR= <i>devnchar addr</i>	<i>devnchar addr</i> : RS-type address or register (2) - (12).
,DEVN= <i>devn addr</i>	<i>devn addr</i> : RS-type address or register (2) - (12).
,DEVN=0	Default: 0
,SUBCHANNELSET=ID	
,SCHSET= <i>xschset</i>	<i>xschset</i> RS-type address or register (2) - (12).
,SCHSET=0	Default: 0
,SUBCHANNELSET=ALL	
,DYNAMIC=NO	Default: NO
,DYNAMIC=YES	
,RANGE=3DIGIT	Default: 3DIGIT

UCBSCAN macro

Syntax	Description
,RANGE=ALL	
,UNBOUND_ALIAS=NO	Default: NO
,UNBOUND_ALIAS=YES	
,UNBOUND_ALIAS=ONLY	
,DEVCLASS=ALL	Default: ALL
,DEVCLASS=CHAR	
,DEVCLASS=COMM	
,DEVCLASS=CTC	
,DEVCLASS=DASD	
,DEVCLASS=DISP	
,DEVCLASS=TAPE	
,DEVCLASS=UREC	
,DEVCID= <i>devcid addr</i>	<i>devcid addr</i> : RS-type address
,DEVCID=0	Default: 0
,IOCTOKEN= <i>ioctoken addr</i>	<i>ioctoken addr</i> : RX-type address or register (2) - (12).
,IOCTOKEN=NONE	Default: NONE
,PLISTVER=IMPLIED_VERSION	
,PLISTVER=MAX	Default: IMPLIED_VERSION
,PLISTVER= <i>plistver</i>	<i>plistver</i> : 1
,RETCODE= <i>retcode addr</i>	<i>retcode addr</i> : RX-type address or register (2) - (12).
,RSNCODE= <i>rsncode addr</i>	<i>rsncode addr</i> : RX-type address or register (2) - (12).
,MF=(E, <i>list addr</i>)	<i>list addr</i> : RX-type address or register (2) - (12).
,MF=(E, <i>list addr</i> ,COMPLETE)	Default: COMPLETE

Parameters

The parameters are explained under the standard form of the COPY function of the UCBSCAN macro with the following exceptions:

,MF=(E,*list addr*)

,MF=(E,*list addr*,COMPLETE)

Specifies the execute form of the UCBSCAN macro.

The *list addr* parameter specifies the address of the storage area for the parameter list.

COMPLETE specifies that the system is to check for required parameters and supply defaults for optional parameters that were not specified.

Chapter 114. UPDTMPB – Update a message parameter block for substitution data

Description

To build a message parameter block (MPB), you must issue both BLDMPB and UPDTMPB. BLDMPB initializes the MPB, and UPDTMPB adds one substitution token to the MPB each time you issue it. Issue UPDTMPB once for each substitution token in the message.

You can also use UPDTMPB to replace or change the value of a particular substitution token in an existing MPB. See *z/OS MVS Programming: Assembler Services Guide* for more information on using UPDTMPB.

Environment

The requirements for the caller are:

Environmental factor	Requirement
Minimum authorization:	Problem state and any PSW key
Dispatchable unit mode:	Task or SRB
Cross memory mode:	PASN=HASN=SASN or PASN-=-HASN-=-SASN
AMODE:	24- or 31-bit
ASC mode:	Primary
Interrupt Status:	Enabled for I/O and external interrupts
Locks:	No locks held
Control parameters:	Not applicable

Programming requirements

You must include the mapping macro CNLMMPB.

Restrictions

None.

Input register information

Before issuing the UPDTMPB macro, the caller does not have to place any information into any register unless using it in register notation for a particular parameter, or using it as a base register.

Output register information

When control returns to the caller, the general purpose registers (GPRs) contain:

Register	Contents
0	Reason code
1	Used as a work register by system

UPDTMPB macro

2-13

Unchanged

14

Used as a work register by system

15

Return code

Some callers depend on register contents remaining the same before and after issuing a service. If the system changes the contents of registers on which the caller depends, the caller must save them before issuing the service, and restore them after the system returns control.

Performance implications

None.

Syntax

The UPDTMPB macro is written as follows:

Syntax	Description
<i>name</i>	<i>name</i> : Symbol. Begin <i>name</i> in column 1.
␣	One or more blanks must precede UPDTMPB.
UPDTMPB	
␣	One or more blanks must follow UPDTMPB.
MPBPTR= <i>mpb addr</i>	<i>mpb addr</i> : RX-type address or register (2) - (12).
,MPBLEN= <i>mpb length addr</i>	<i>mpb length addr</i> : RX-type address or register (2) - (12).
,SUBOOFST= <i>new/changed blk offset addr</i>	<i>new/changed blk offset addr</i> : RX-type address or register (2) - (12).
,SUBCOFST= <i>existing blk offset addr</i>	<i>existing blk offset addr</i> : RX-type address or register (2) - (12).
,TOKEN= <i>token name addr</i>	<i>token name addr</i> : RX-type address or register (2) - (12).
,TOKLEN= <i>token length addr</i>	<i>token length addr</i> : RX-type address or register (2) - (12).
,TOKTYPE= <i>token type addr</i>	<i>token type addr</i> : RX-type address or register (2) - (12).

Syntax	Description
,SUBSDATA= <i>sub data addr</i>	<i>sub data addr</i> : RX-type address or register (2) - (12).
,SUBSLEN= <i>sub data length</i>	<i>sub data length addr</i> : RX-type address or register (2) - (12).
<i>addr</i>	

Parameters

The parameters are explained as follows:

MPBPTR=*mpb addr*

specifies the address or a register containing the address of the MPB to be modified.

,MPBLEN=*mpb len addr*

specifies the address or a register containing the address of the length of the area addressed by MPBPTR.

,SUBOOFST=*new/changed blk offset addr*

specifies the address of the area or a register into which UPDTMPB returns the value of the offset from the start of the MPB to the new or changed substitution block. A substitution block contains all the information that you need to format substitution data. It consists of a token field, token length, substitution length, token type, and substitution data.

,SUBCOFST=*existing blk offset addr*

specifies the address of the offset or a register containing the offset from the start of the MPB to the existing substitution block that UPDTMPB is to update. If you do not specify SUBCOFST, UPDTMBP will build a new substitution block.

,TOKEN=*token name addr*

specifies the address of the area or a register pointing to the area containing the substitution token name.

,TOKLEN=*token length addr*

specifies the address of the area or a register containing the length of the TOKEN field. If you do not specify TOKLEN, UPDTMPB uses, as a default, the length of the TOKEN field in the DSECT mapping. You must specify TOKLEN if you use register notation for the TOKEN keyword.

,TOKTYPE=*token type addr*

specifies the address of the area or a register containing the 1-byte token type. This field can have the following values and meanings:

Value	Meaning
0	text
1	date
2	time
3	day of week

,SUBSDATA=*sub data addr*

specifies the address of the area or a register pointing to the area containing the substitution data.

If TOKTYPE is 0, SUBSDATA can contain any text with a length defined SUBSLEN.

If TOKTYPE is 1, SUBSDATA must be eight bytes long and in the format *yyyymmdd*, where:

- *yyyy* is the year number, expressed as a 4-digit EBCDIC string in the range 0000 to 9999.
- *mm* is the month number, expressed as a 2-digit EBCDIC string in the range 01 to 12.

UPDTMPB macro

- *dd* is the day number, expressed as a 2-digit EBCDIC string in the range 01 to 31.

If TOKTYPE is 2, SUBSDATA must be twelve bytes long in the format *hhmmssdddddd*, where:

- *hh* is the hours in a 24-hour clock, expressed as a 2-digit EBCDIC string in the range 00 to 23.
- *mm* is the minutes, expressed as a 2-digit EBCDIC string in the range 00 to 59.
- *ss* is the seconds, expressed as a 2-digit EBCDIC string in the range 00 to 59. EBCDIC blanks are considered zeros.
- *dddddd* is the decimal seconds, expressed as a 6-digit EBCDIC string in the range 000000 to 999999. EBCDIC blanks are considered zeros.

If TOKTYPE is 3, SUBSDATA must be one byte long in the format *d*, where *d* is the day number, expressed as a 1-digit EBCDIC string in the range 1 to 7. The days are defined in parmlib member CNLcccxx. Day 1 is Sunday, 2 is Monday, and so on.

,SUBSLEN=*sub data length addr*

specifies the address of the area or a register pointing to the area containing the length of the substitution data. If you do not specify SUBSLEN, UPDTMPB uses, as a default, the length of the SUBSDATA field in the DSECT mapping. You must specify SUBSLEN if you use register notation for the SUBSDATA parameter.

Return and reason codes

When UPDTMPB completes, register 15 contains one of the following hexadecimal return codes:

Hexadecimal Return Code	Meaning
00	Processing completed successfully.
0C	Processing unsuccessful. See reason codes.

When UPDTMPB completes, register 0 contains one of the following hexadecimal reason codes:

Hexadecimal Return Code	Hexadecimal Reason Code	Meaning
00	00	Successful processing.
0C	33	There is insufficient storage in the MPB.
0C	35	The value for TOKLEN is either zero or negative.
0C	36	The value for SUBSLEN is negative.
0C	37	The TOKTYPE value is not valid.
0C	38	SUBCOFST is not valid.
0C	3B	The MPB acronym is not valid.

Example

Build and update an MPB for a message that contains substitution data for the third day of the week.

```
BLDMPBA CSECT
BLDMPBA AMODE 31
BLDMPBA RMODE ANY
          STM 14,12,12(13)
          BALR 12,0
          USING *,12
          ST 13,SAVE+4
          LA 15,SAVE
          ST 15,8(13)
          LR 13,15
```

```

*          OBTAIN WORKING STORAGE AREA          *
*****
GETMAIN RU,LV=STORLEN,SP=SP230
LR      R4,R1
*
*****
*          CREATE MPB HEADER SECTION          *
*****
*          BLDMPB MPBPTR=(R4),MPBLEN=MPBL,MSGID=MSGID,          X
          MSGIDLEN=MIDLEN
*
*****
*          ADD SUBSTITUTION DATA TO MPB          *
*****
*          LR      R2,R4
          A      R2,MPBL
          USING VARS,R2
*
*          UPDTMPB MPBPTR=(R4),MPBLEN=MPBL,SUBOOFST=VARS,          X
          TOKEN=TOKN,TOKLEN=TOKL,TOKTYPE=TOKT,          X
          SUBSDATA=SDATA,SUBSLEN=SDATAL
*
*
*****
*          FREE STORAGE AREA          *
*****
*          FREEMAIN RU,LV=STORLEN,SP=SP230,A=(4)
*
*          L      13,SAVE+4
          LM     14,12,12(13)
          BR     14
*****
MPBL     DC      A(MPBLEN)
MSGID    DC      CL10'MSGID2'
MIDLEN   DC      A(MIDL)
TOKN     DC      CL3'DAY'
TOKL     DC      F'3'
TOKT     DC      CL1'3'
SDATAL   DC      CL1'3'
SDATA    DC      A(SDL)
SAVE     DC      18F'0'
SP230    EQU     230
STORLEN  EQU     256
SDL      EQU     6
MIDL     EQU     6
MPBLEN   EQU     (MPBV DAT-MPB)+(MPBMID-MPBMMSG)+(MPBSUB-MPBSB)+MIDL+SDL
R1       EQU     1
R2       EQU     2
R4       EQU     4
*****
          DSECT
          CNLMMPB
VARS     DSECT
VARSAREA DS      CL24
VARSLEN  EQU     *-VARS
          END BLDMPBA

```

Chapter 115. VRADATA – Update variable recording area data

Description

The VRADATA macro copies service information into a variable recording area (VRA), usually the system diagnostic work area (SDWAVRA). This information can later be recorded in the LOGREC data set if software errors occur. (See the SETRP macro, RECORD=YES parameter description, for more information on recording the SDWA data area.) The information copied into the VRA using this macro is in a key, length, data format defined by the IHAVRA mapping macro. The key and length are one-byte fields; the data can vary in length. The IHAVRA mapping macro is shown in *z/OS MVS Data Areas* in the *z/OS Internet library* (www.ibm.com/servers/resourcelink/svc00100.nsf/pages/zosInternetLibrary) under VRAMAP.

Environment

The requirements for the caller are:

Environmental factor	Requirement
Minimum authorization:	Problem state and any PSW key
Dispatchable unit mode:	Task or SRB
Cross memory mode:	Any PASN, any HASN, any SASN
AMODE:	24- or 31- or 64-bit
ASC mode:	Primary, secondary, or access register (AR)
Interrupt status:	Enabled or disabled for I/O and external interrupts
Locks:	The caller may hold locks, but is not required to hold any.
Control parameters:	None

Programming requirements

- If your program is in AR mode, issue the SYSSTATE ASCENV=AR macro before issuing VRADATA. SYSSTATE ASCENV=AR tells the system to generate code appropriate for AR mode.
- You must include the IHASDWA mapping macro as a DSECT in your program if you accept the default for VRAINIT, VRACLEN, VRAMLEN, or if you specify VRAINIT=SDWAVRA. You must also place the address of the SDWA data area into the SDWAREG register (or default register 1) if you accept the default for any of these three parameters.
- You must include the IHAVRA mapping macro as a DSECT in your program. If you include the IHASDWA mapping macro, IHAVRA is automatically included.
- You can issue VRADATA more than once in a program, but you need to specify VRAINIT, VRACLEN, and VRAMLEN only once for a particular series of updates to the VRA.
- If you specify a key on the KEY parameter, but no data on the DATA parameter, the length field for the VRA entry (LEN parameter) is zero. You must be running in the key the SDWA was obtained in. Refer to *z/OS MVS Programming: Assembler Services Guide* for more information.

Restrictions

None.

Input register information

Before issuing the VRADATA macro, the AR-mode caller must ensure that the following GPRs contain the specified information.

Register Contents

- 1**
Address of the SDWA if you do not specify the SDWAREG parameter on this invocation or any previous invocation of the VRADATA macro; otherwise, the caller does not have to place any information into this register.
- 14**
Address of the next available field in the VRA if you do not specify the VRAREG parameter on this invocation or any previous invocation of the VRADATA macro; otherwise, the caller does not have to place any information into this register.

Before issuing the VRADATA macro, the caller must ensure that the following ARs contain the specified information.

Register Contents

- 1**
ALET of the SDWA whose address is in GPR 1, only if you do not specify the SDWAREG parameter on this invocation or any previous invocation of the VRADATA macro; otherwise, the caller does not have to place any information into this register.
- 14**
ALET of the next available space in the VRA whose address is in GPR 14 only if you do not specify the VRAREG parameter on this invocation or any previous invocation of the VRADATA macro; otherwise, the caller does not have to place any information into this register.

Output register information

When control returns to the caller, the general purpose registers (GPRs) contain:

Register Contents

- 0-13**
Unchanged
- 14**
Address of the next available space in the VRA for the next invocation of VRADATA if you did not specify the VRAREG parameter on this invocation or any previous invocation; otherwise, unchanged.
- 15**
Used as a work register if you did not specify the WORKREG parameter on this invocation or any previous invocation of the VRADATA macro; otherwise, unchanged.

When control returns to the caller, the access registers (ARs) contain:

Register Contents

- 0-1**
Used as work registers by the system
- 2-13**
Unchanged
- 14-15**
Used as work registers by the system

Some callers depend on register contents remaining the same before and after issuing a service. If the system changes the contents of registers on which the caller depends, the caller must save them before issuing the service, and restore them after the system returns control.

Performance implications

None.

Syntax

The VRADATA macro is written as follows:

Syntax	Description
<i>name</i>	<i>name</i> : Symbol. Begin <i>name</i> in column 1.
␣	One or more blanks must precede VRADATA.
VRADATA	
␣	One or more blanks must follow VRADATA.
VRAINIT= <i>vra addr</i>	<i>vra addr</i> : RX-type address, or the symbol SDWAVRA. Default: address of SDWAVRA
,VRACLEN= <i>curr len addr</i> or (<i>curr len addr</i> ,0)	<i>curr len addr</i> : RX-type address. Default: address of SDWAURAL.
,VRAMLEN= <i>max len addr</i>	<i>max len addr</i> : RX-type address. Default: address of SDWAVRAL.
,KEY= <i>key nمبر</i>	<i>key nمبر</i> : Symbol or decimal digit.
,LENADDR= <i>data len addr</i>	<i>data len addr</i> : RX-type address.
,LEN= <i>data len value</i>	<i>data len value</i> : Symbol or decimal digit. Default: length of DATA storage.
,DATA= <i>data addr</i>	<i>data addr</i> : RX-type address, or register (1) - (15).
,SDWAREG= <i>reg</i>	<i>reg</i> : Symbol or decimal digits 1-15. Default: 1

Syntax	Description
,VRAREG=(<i>reg,descr</i>)	<i>reg</i> : Symbol or decimal digits 1-15.
	Default: 14
	<i>descr</i> : SET or NOTSET
	Default: NOTSET if VRAINIT is specified,
	otherwise SET.
,WORKREG= <i>reg</i>	<i>reg</i> : Symbol or decimal digits 1-15.
	Default: 15
,TYPE=(LEN,TEST) ,TYPE=(LEN,NOTEST) ,TYPE=(LEN,NOT) ,TYPE=(NOLEN,TEST) ,TYPE=(NOLEN,NOTEST) ,TYPE=(NOLEN,NOT) ,TYPE=(NOL,TEST) ,TYPE=(NOL,NOTEST) ,TYPE=(NOL,NOT)	Default: LEN,TEST

Parameters

The parameters are explained as follows:

VRAINIT=*vra addr*

Specifies the address of the variable recording area to be initialized and updated. The value in the register specified by the VRAREG parameter is also initialized unless VRAREG=(,SET) is specified. If VRAINIT=SDWAVRA is specified, the SDWA data area is also updated to indicate that the VRA contains data in key-length-data format that is to be displayed in hexadecimal. If VRAINIT is not specified, VRAINIT=SDWAVRA is assumed. All subsequent VRADATA macros use the specified VRAINIT value until you specify another VRAINIT value.

,VRACLEN=*curr len addr*

Specifies the address of a one-byte field that contains the length of the current VRA. This value changes as information is added in the VRA. If you do not specify VRACLEN, you can obtain the current length of the VRA from the SDWAURAL field of the SDWA.

,VRACLEN=(*curr len addr*, 0)

Specifies that the area containing the length is to be zeroed.

All subsequent VRADATA macros use the specified VRACLEN value until you specify another VRACLEN value.

,VRAMLEN=*max len addr*

Specifies the address of a two-byte field that contains the maximum length of the VRA. If you do not specify VRAMLEN, the maximum length is obtained from SDWAVRAL.

All subsequent VRADATA macros use the specified VRAMLEN value until you specify another VRAMLEN value.

,KEY=*key number*

Specifies the key value to be placed in the VRAKEY field of the current VRA entry. The IHAVRA mapping macro (VRAMAP) defines the valid key values.

,LENADDR=*data len addr***,LEN=*data len value***

Specifies the length of the data for the VRA entry. The maximum length is 255 bytes. Omit this parameter unless the DATA parameter is a register value or a displacement plus a register, or if the defined data length must be overridden because it is larger than 255 bytes. For bit string data, use this parameter to indicate how many bytes the bit string occupies. The data length field pointed to by LENADDR must be a two-byte area with the length right-justified in the area.

,DATA=*data addr*

Specifies the address of the data to be copied into the VRA. The data must correspond to the key specified by the KEY parameter. If you specify DATA, you must specify KEY. You must also specify LEN or LENADDR if DATA has a register value or if the data length is greater than 255 bytes.

,SDWAREG=*reg*

Specifies a register containing the address of the SDWA data area. You must place the address in this register before invoking VRADATA. The VRADATA macro preserves the contents of this register. If you do not specify SDWAREG, register 1 is the default.

,VRAREG=(*reg,descr*)

Specifies a register to contain the address of the next available field in the VRA and a description of whether or not the register value is already set (SET) or not set (NOTSET). If VRAINIT is specified, the default is NOTSET. If VRAINIT is not specified, the default is SET. If you specify NOTSET or default to it, the system program places the address of the VRA plus the current length in the register before updating the VRA.

After updating the VRA, the system updates the register to point to the next available field in the VRA. If you do not specify VRAREG, register 14 is the default.

,WORKREG=*reg*

Specifies a work register. Each time you invoke the VRADATA macro, the contents of this register are destroyed. If you do not specify WORKREG, register 15 is the default.

,TYPE=(LEN,TEST)**,TYPE=(LEN,NOTEST)****,TYPE=(LEN,NOT)****,TYPE=(NOLEN,TEST)****,TYPE=(NOLEN,NOTEST)****,TYPE=(NOLEN,NOT)****,TYPE=(NOL,TEST)****,TYPE=(NOL,NOTEST)****,TYPE=(NOL,NOT)**

Specifies whether (LEN) or not (NOLEN) you want the current length of the VRA stored in the VRALEN area and also specifies whether (TEST) or not (NOTEST) you want the VRA tested to see if it is full before adding the new entry. If you specify TEST, the current length of the VRA must already be in the VRACLEN area.

If you do not need to store the length or test to see if the new entry fits, specify NOLEN and NOTEST. These specifications considerably reduce the amount of code generated by the VRADATA macro. If you do not specify TYPE, the value LEN, TEST is the default.

ABEND codes

None.

Return and reason codes

None.

Example 1

Initialize the SDWA data area to indicate that the VRA contains hexadecimal data, in key, length, data format. Also, move two pieces of data into the SDWAVRA, and indicate that no test of the length of the

VRADATA macro

VRA is needed, (because the data fits in the VRA). The second request indicates that the length used is to be stored in the VRA current length field. The pieces of data are the IHAVRA mapping macro name and the contents of a control block.

```
VRADATA VRAINIT=SDWAVRA , KEY=VRACBM , DATA=MYCBNAME , X  
        TYPE=(NOLEN,NOTEST)  
VRADATA KEY=VRACB , DATA=MYCB , TYPE=(LEN,NOTEST)
```

Example 2

Initialize a variable recording area that is not the SDWA. Move in a piece of data, specifying its length. (The piece of data is an ASID.)

```
VRADATA VRAINIT=LRBTUSR , VRACLEN=LRBTCLEN , X  
        VRAMLEN=LBRTMLEN  
VRADATA KEY=VRAAID , DATA=(REGA) , LEN=ASIDLEN
```

Chapter 116. WAIT – Wait for one or more events

Description

The WAIT macro informs the system that performance of the active task cannot continue until one or more specific events, each represented by a different event control block (ECB), have occurred. Bit 0 and bit 1 of each ECB must be set to zero before it is used. The caller must be enabled, unlocked, and in primary address space control (ASC) mode.

The system takes the following action:

- For each event that has already occurred (each ECB is already posted), the count of the number of events is decreased by one.
- If the number of events is zero by the time the last event control block is checked, control is returned to the instruction following the WAIT macro.
- If the number of events is not zero by the time the last ECB is checked, control is not returned to the issuing program until sufficient ECBs are posted to bring the number to zero. Control is then returned to the instruction following the WAIT macro.

For more information on how to use the WAIT macro to synchronize tasks, see [z/OS MVS Programming: Assembler Services Guide](#).

Environment

The requirements for callers of WAIT are:

Environmental factor	Requirement
Minimum authorization:	Problem state and any PSW key.
Dispatchable unit mode:	Task
Cross memory mode:	One of the following: <ul style="list-style-type: none"> • For LINKAGE=SVC: PASN=HASN=SASN, • For LINKAGE=SYSTEM: PASN=HASN=SASN or PASN=HASN=SASN
AMODE:	24- or 31- or 64-bit
RMODE:	Includes 64-bit
ASC mode:	Primary
Interrupt status:	Enabled for I/O and external interruptions
Locks:	No locks held
Control parameters:	ECB and ECBLIST must be in the home address space.

Programming requirements

None.

Restrictions

When using LINKAGE=SVC (the default), the caller cannot have an EUT FRR established.

Input register information

Before issuing the WAIT macro, the caller does not have to place any information into any register unless using it in register notation for a particular parameter, or using it as a base register.

Output register information

When control returns to the caller, the general purpose registers (GPRs) contain:

Register Contents

0-1
Used as work registers by the system

2-13
Unchanged

14-15
Used as work registers by the system

When control returns to the caller, the access registers (AR) contain:

Register Contents

0-1
Used as work registers by the system

2-13
Unchanged

14-15
Used as work registers by the system

Some callers depend on register contents remaining the same before and after issuing a service. If the system changes the contents of registers on which the caller depends, the caller must save them before issuing the service, and restore them after the system returns control.

Performance implications

None.

Syntax

The WAIT macro is written as follows:

Syntax	Description
<i>name</i>	<i>name</i> : Symbol. Begin <i>name</i> in column 1.
␣	One or more blanks must precede WAIT.
WAIT	
␣	One or more blanks must follow WAIT.

Syntax	Description
<i>event nmb</i> ,	<i>event nmb</i> : Symbol, decimal digit, or register (0) or (2) - (12). Default: 1 Value range: 0-255
ECB= <i>ecb addr</i>	<i>ecb addr</i> : RX-type address, or register (1) or (2) - (12).
ECBLIST= <i>ecb list addr</i>	<i>ecb list addr</i> : RX-type address, or register (1) or (2) - (12).
,LONG=NO	Default: LONG=NO
,LONG=YES	
,LINKAGE=SVC	Default: LINKAGE=SVC
,LINKAGE=SYSTEM	
,RELATED= <i>value</i>	<i>value</i> : Any valid macro keyword specification.

Parameters

The parameters are explained as follows:

***event nmb*,**

Specifies the number of events waiting to occur.

ECB=*ecb addr*

ECBLIST=*ecb list addr*

Specifies the address of an ECB on a fullword boundary or the address of a virtual storage area containing one or more consecutive fullwords on a fullword boundary. Each fullword contains the address of an ECB; the high order bit in the last fullword must be set to one to indicate the end of the list.

The ECB parameter is valid only if the number of events is specified as one or is omitted. The number of ECBs in the list specified by the ECBLIST form must be equal to or greater than the specified number of events.

If you specify ECBLIST, *ecb list addr* and all ECBs on the list must be in the home address space.

,LONG=NO

,LONG=YES

Specifies whether the task is entering a long wait (YES) or a regular wait (NO).

,LINKAGE=SVC

,LINKAGE=SYSTEM

Specifies whether WAIT is to be called through an SVC (LINKAGE=SVC) or not (LINKAGE=SYSTEM).

When the caller is not in cross memory mode (the primary, secondary, and home address spaces are the same) and no EUT FRR is established, use LINKAGE=SVC. With this parameter, linkage is through an SVC instruction.

When the caller is in cross memory mode (the primary, secondary, and home address spaces are not the same) or if an EUT FRR is established, use LINKAGE=SYSTEM. With this parameter, linkage is through a PC instruction. Note that the ECB must be in the home address space.

WAIT macro

,RELATED=value

Specifies information used to self-document macros by “relating” functions or services to corresponding functions or services. The format and contents of the information specified are at the discretion of the user and may be any valid coding values.

The RELATED parameter is available on macros that provide opposite services (for example, ATTACH/DETACH, GETMAIN/FREEMAIN, and LOAD/DELETE) and on macros that relate to previous occurrences of the same macros (for example, CHAP and ESTAE).

The RELATED parameter may be used, for example, as follows:

```
WAIT1   WAIT      1,ECB=ECB,RELATED=(RESUME1,
                  'WAIT FOR EVENT')
.
.
RESUME1 POST     ECB,0,RELATED=(WAIT1,
                  'RESUME WAITER')
```

Note: Each of these macros will fit on one line when coded, so there is no need for a continuation indicator.



CAUTION: A job step with all of its tasks in a WAIT condition is terminated upon expiration of the time limits that apply to it.

Example

You have previously initiated one or more activities to be completed asynchronously to your processing. As each activity was initiated, you set up an ECB in which bits 0 and 1 were set to zero. You now wish to suspend your task via the WAIT macro until a specified number of these activities have been completed.

Completion of each activity must be made known to the system via the POST macro. POST causes an addressed ECB to be marked complete. If completion of the event satisfies the requirements of an outstanding WAIT, the waiting task is marked ready and will be executed when its priority allows.

ABEND codes

WAIT might abnormally terminate with one of the following abend codes:

- X'101'
- X'201'
- X'301'
- X'401'

These hexadecimal codes are described in [z/OS MVS System Codes](#).

Return and reason codes

None.

Example 1

Wait for one event to occur (with a default count).

```
        WAIT   ECB=WAITECB
        .
        .
WAITECB DC     F'0'
```

Example 2

Wait for 2 events to occur.

```
        WAIT    2,ECBLIST=LISTECBS
        .
LISTECBS DC    A(ECB1)
         DC    A(ECB2)
         DC    A(X'80000000'+ECB3)
```

Example 3

Enter a long wait for a task.

```
        WAIT    1,ECBLIST=LISTECBS, LONG=YES
        .
LISTECBS DC    A(ECB1)
         DC    A(ECB2)
         DC    X'80'
         DC    AL3(ECB3)
```

Chapter 117. WTL – Write to log

Description

Note: IBM recommends you use the WTO macro with the MCSFLAG=HRDCPY parameter instead of WTL, because WTO supplies more data than WTL.

The WTL macro causes a message to be written to the system log (SYSLOG) or the operations log (OPERLOG) log stream depending on which one of these logs, or both, is active.

Note: When a message is recorded in SYSLOG, the exact format of the output of the WTL macro varies depending on the job entry subsystem (JES2 or JES3) that is being used, the output class that is assigned to the log at system initialization, and whether DLOG is in effect for JES3. See the following for information on the format of logged messages:

- [z/OS MVS System Messages, Vol 1 \(ABA-AOM\)](#)
- [z/OS MVS System Messages, Vol 2 \(ARC-ASA\)](#)
- [z/OS MVS System Messages, Vol 3 \(ASB-BPX\)](#)
- [z/OS MVS System Messages, Vol 4 \(CBD-DMO\)](#)
- [z/OS MVS System Messages, Vol 5 \(EDG-GLZ\)](#)
- [z/OS MVS System Messages, Vol 6 \(GOS-IEA\)](#)
- [z/OS MVS System Messages, Vol 7 \(IEB-IEE\)](#)
- [z/OS MVS System Messages, Vol 8 \(IEF-IGD\)](#)
- [z/OS MVS System Messages, Vol 9 \(IGF-IWM\)](#)
- [z/OS MVS System Messages, Vol 10 \(IXC-IZP\)](#)

[z/OS JES3 Commands](#) also contains information on the format of logged messages.

Environment

The requirements for the caller are:

Environmental factor	Requirement
Minimum authorization:	Problem state and any PSW key.
Dispatchable unit mode:	Task
Cross memory mode:	PASN=HASN=SASN
AMODE:	24- or 31-bit
ASC mode:	Primary
Interrupt status:	Enabled for I/O and external interrupts
Locks:	No locks held
Control parameters:	Must be in the primary address space.

Programming requirements

None.

Restrictions

Message text cannot exceed 126 characters. If the message text exceeds 126 characters, truncation occurs at the last embedded blank before the 126th character; when there are no embedded blanks, truncation occurs after the 126th character.

Input register information

Before issuing the WTL macro, the caller does not have to place any information into any register unless using it in register notation for a particular parameter, or using it as a base register.

Output register information

When control returns to the caller, the GPRs contain:

Register

Contents

0

Reason code

1-14

Unchanged

15

Return code

When control returns to the caller, the access registers (ARs) contain:

Register

Contents

0-1

Used as work registers by the system

2-13

Unchanged

14-15

Used as work registers by the system

Some callers depend on register contents remaining the same before and after issuing a service. If the system changes the contents of registers on which the caller depends, the caller must save them before issuing the service, and restore them after the system returns control.

Performance implications

None.

Syntax

The standard form of the WTL macro is written as follows:

Syntax	Description
<i>name</i>	<i>name</i> : Symbol. Begin <i>name</i> in column 1.
‡	One or more blanks must precede WTL.
WTL	

Syntax	Description
b	One or more blanks must follow WTL.
'msg'	msg: Up to 126 characters.

Parameters

The parameter is explained as follows:

'msg'

Specifies the message to be written to the system log and/or the operations log. The message must be enclosed in apostrophes, which will not appear in the system log. The message can include any character that can be used in a C-type (character) DC statement, and is assembled as a variable-length record. See "Timing and Communication" in *z/OS MVS Programming: Assembler Services Guide* for a list of the printable EBCDIC characters passed to display devices or printers.

ABEND codes

None.

Return and reason codes

When the WTL macro returns control to your program, GPR 15 contains a return code and GPR 0 contains a reason code. WTL issues a return code (either 00 or 04), with multiple reason codes for each. The return codes indicate the following:

- 00 - WTL wrote the message to the system log, the operations log, or both.
- 04 - WTL could not write the message to either the system log or the operations log.

Return Code	Reason Code	Meaning and Action
0	None	<p>Meaning: WTL processing completed successfully. The system logged the message in SYSLOG, and, if OPERLOG was requested, the system logged the message in OPERLOG.</p> <p>Action: None.</p>
0	04	<p>Meaning: WTL processing completed successfully. The message was logged in the operations log (OPERLOG log stream). The system log was not active.</p> <p>Action: If you want the message logged in the system log, start the system log and rerun the program.</p>

Return Code	Reason Code	Meaning and Action
0	08	<p>Meaning: WTL processing completed, but the message was only logged in the operations log because the WTL system log buffers are full.</p> <p>Action: Do one of the following, if you want subsequent messages logged in the system log:</p> <ul style="list-style-type: none"> • Enter a CONTROL M,LOGLIM command to change the allocated number of WTL system log buffers dynamically. • Change the LOGLIM value, specifying the number of WTL system log buffers on the INIT statement in the CONSOLxx parmlib member. This value will take effect at the next IPL.
0	0C	<p>Meaning: WTL processing completed, but the message was only logged in the system log because the operations log was not active.</p> <p>Action: If you want the message logged in the operations log, start the operations log and rerun the program. This will also place the message in the system log.</p>
0	10	<p>Meaning: WTL processing completed, but the message was only logged in the system log. The message was not logged in the OPERLOG log stream because of a storage problem.</p> <p>Action: If you want the message logged in the operations log, retry the request. This will also place the message in the system log. If the problem persists, contact the IBM Support Center. Provide the return and reason code.</p>
04	04	<p>Meaning: System error. WTL processing was not successful. Recovery could not be established.</p> <p>Action: Retry the request. If the problem persists, record the return and reason code and supply them to the appropriate IBM support personnel.</p>
04	08	<p>Meaning: Environmental error. The system log and the operations log are not active.</p> <p>Action: Start the logs and rerun your program.</p>
04	0C	<p>Meaning: Environmental error. The WTL limit has been reached.</p> <p>Action: Do one of the following:</p> <ol style="list-style-type: none"> 1. Retry the request when the shortage is relieved. 2. Issue a CONTROL M,LOGLIM command to change the allocated number of WTL SYSLOG buffers. 3. Change the LOGLIM value on the INIT statement in the CONSOLxx member of SYS1.PARMLIB. This new value will take effect at the next IPL. <p>Note: If the problem is persistent, you might want to perform step 2 first and step 3 at the next IPL.</p>

Return Code	Reason Code	Meaning and Action
04	10	<p>Meaning: System error. An internal error occurred. The system issues message IEE390I.</p> <p>Action: Contact the IBM Support Center. Provide the return and reason code.</p>
04	14	<p>Meaning: System error. The system encountered a (VSM) error. The system issues message IEE390I.</p> <p>Action: Contact the IBM Support Center. Provide the return and reason code.</p>
04	18	<p>Meaning: Environmental error. The message was not logged in either the system log or the operations log, because neither log is active.</p> <p>Action: Do one of the following:</p> <ul style="list-style-type: none"> • If you want to log the message in the operations log, start the operations log with the VARY OPERLOG,HARDCPY command and rerun the program. • If you want the message logged in the system log, start the system log (SYSLOG) with the VARY SYSLOG,HARDCPY command and rerun the program.
04	1C	<p>Meaning: Environmental error. The message was not logged in the system log, as requested, because the WTL limit has been reached. The operation log was not active at the time, so the message was not logged there either.</p> <p>Action: To log the message in the system log, do the following:</p> <ul style="list-style-type: none"> • Issue a CONTROL M,LOGLIM command to change the allocated number of WTL SYSLOG buffers. • Change the LOGLIM value on the INIT statement in the CONSOLxx member of SYS1.PARMLIB. This new value will take effect at the next initialization. • Retry the request when the storage shortage has been relieved. <p>If the problem persists, issue the CONTROL M,LOGLIM command first, and change the LOGLIM value in CONSOLxx at your next IPL.</p> <p>To log the message in the operations log, start the operations log and rerun the program.</p>
04	20	<p>Meaning: Environmental error. The message was not logged in the operations log, as requested, because of storage problems. The system log was not active.</p> <p>Action: To log the message in the operations log, retry the request. If the problem persists, contact the IBM Support Center, providing the return and reason codes.</p> <p>To log the message in the system log also, start the system log and rerun the program.</p>

WTL macro

Return Code	Reason Code	Meaning and Action
04	24	<p>Meaning: Environmental error. The message was not logged in the system log because the WTL limit has been reached, and was not logged in the operation log because of storage problems.</p> <p>Action: To log the message in the operations log, retry the request. If the problem persists, contact the IBM Support Center, providing the return and reason codes.</p>

Example 1

Write a message to the system log.

```
WTL 'THIS IS THE STANDARD FORMAT FOR THE WTL MACRO'
```

Example 2

Write a message constructed in the list form of WTL.

```
WTL MF=(E,(R2))
```

WTL - List form

The list form of the WTL macro is used to construct a control program parameter list. The message parameter must be provided in the list form of the macro.

Syntax

The list form of the WTL macro is written as follows:

Syntax	Description
<i>name</i>	<i>name</i> : Symbol. Begin <i>name</i> in column 1.
␣	One or more blanks must precede WTL.
WTL	
␣	One or more blanks must follow WTL.
'msg'	<i>msg</i> : Up to 126 characters.
,MF=L	

Parameters

The parameters are explained under the standard form of the WTL macro with the following exception:

,MF=L

Specifies the list form of the WTL macro.

WTL - Execute form

The execute form of the WTL macro uses a remote control program parameter list. The parameter list can be generated by the list form of WTL. You cannot modify the message in the execute form.

Syntax

The execute form of the WTL macro is written as follows:

Syntax	Description
<i>name</i>	<i>name</i> : Symbol. Begin <i>name</i> in column 1.
␣	One or more blanks must precede WTL.
WTL	
␣	One or more blanks must follow WTL.
MF=(E, <i>list addr</i>)	<i>list addr</i> : RX-type address, or register (1) or (2) - (12).

Parameters

The parameters are explained under the standard form of the WTL macro with the following exception:

MF=(E,*list addr*)

Specifies the execute form of the WTL macro.

list addr specifies the area that the system uses to store the parameters.

Chapter 118. WTO- Write to operator

Description

The WTO macro allows you to write messages to one or more operator consoles. See [z/OS MVS Programming: Assembler Services Guide](#) for more information on using WTO.

Environment

Requirements for the caller are:

Environmental factor	Requirement
Minimum authorization:	Problem state and any PSW key.
Dispatchable unit mode:	Task
Cross memory mode:	PASN=HASN=SASN
AMODE:	24- or 31- or 64-bit
ASC mode:	Primary
Interrupt status:	Enabled for I/O and external interrupts
Locks:	No locks held
Control parameters:	Must be in the primary address space.

Programming requirements

Be aware of the following when coding the WTO macro:

- MCSFLAG=REG0 is not supported on z/OS V1R7 and higher.
- You should clear register zero.
- If the list and execute forms of the WTO macro are in separate modules, both modules must be assembled or compiled with the same level of WTO.
- If the execute form of the macro specifies TEXT=(*text addr*), CART, KEY, TOKEN, CONSID, or CONSNAME, then the list form, to ensure that the parameter list is generated correctly, must specify the same parameters without data. For example,:

```
WTO 'USR001I FOR SPECIAL REQUESTS CONTACT SYSTEM SUPPORT',CONSID=,MF=L
```

If you specify parameter values on the list form, the system issues an MNOTE and ignores the data.

- For any WTO parameters that allow a register specification, the value must be right-justified in the register.
- If you specify the TEXT keyword for a multi-line WTO, you must code its parameters in the following way:
 - On the list form, omit *text addr* for each line, but include *line type*. If you specify *text addr*, the system ignores the data and issues an MNOTE.
 - On the execute form, omit *line type* for each line, but include *text addr*.
- When using any parameter with an address, the data being referenced must be accessible by the caller issuing the WTO.
- As of z/OS 1.4.2, to prevent parameter lists that are not valid from causing system errors, the WTO service records the errors as symptom records in LOGREC. One example of an invalid parameter list is an invalid combination of WTO parameters. The system may also issue a D23 abend for diagnostic

purposes only; the program issuing the WTO is not abended. Message processing continues as far as possible using the invalid parameter list.

Due to these invalid parameter list errors, you may notice that some messages that once were processed are no longer able to be processed; your program may also receive different return codes. However, in these cases, the symptom record is always issued, and the diagnostic D23 abend is issued if possible. IBM recommends that you correct all WTO errors, regardless of whether or not the message is actually displayed. For an example LOGREC symptom record, see [“Example 4” on page 1144](#).

If a dump is needed along with the diagnostic D23 abend to debug the problem, the following SLIP can be set to cause dumps to be taken:

```
SLIP SET,ENABLE,COMP=D23,ACTION=SVCD,END
```

Restrictions

- You can issue a WTO of up to 10 lines. A WTO over 10 lines produces a return code of 04. The return code indicates that only 10 lines are processed and the rest are ignored.
- The caller cannot have an EUT FRR established.

Input register information

Before issuing the WTO macro, the caller does not have to place any information into any register unless using it in register notation for a particular parameter or using it as a base register.

Output register information

When control returns to the caller, the output registers contain the following values:

Register

Contents

0

Used as a work register by the system unless WTO returns code X'20' in register 15. In that case, register 0 contains the number of active WTO buffers for the issuer's address space.

1

Message identification number if the WTO macro completed normally (you can use this number to delete the message when it is no longer needed); otherwise, used as a work register by the system.

2-13

Unchanged.

14

Used as a work register by the system.

15

Return code.

When control returns to the caller, the access registers (ARs) contain:

Register

Contents

0-1

Used as work registers by the system

2-13

Unchanged

14-15

Used as work registers by the system

Some callers depend on register contents remaining the same before and after issuing a service. If the system changes the contents of registers on which the caller depends, the caller must save them before issuing the service, and restore them after the system returns control.

Performance implications

None.

Syntax

The standard form of the WTO macro is written as follows:

Syntax	Description																					
<i>name</i>	<i>name</i> : Symbol. Begin <i>name</i> in column 1.																					
␣	One or more blanks must precede WTO.																					
WTO																						
␣	One or more blanks must follow WTO.																					
' <i>msg</i> '	<i>msg</i> : Up to 126 characters.																					
(' <i>text</i> ')	<i>text</i> : Up to 126 characters.																					
(' <i>text</i> ', <i>line type</i>)																						
TEXT= <i>text addr</i>	<i>text addr</i> : RX-type address or register (2) - (12).																					
TEXT=(<i>text addr</i> , <i>line type</i>)	Note: If you code ' <i>msg</i> ' or (' <i>text</i> '...), it must be the first positional parameter.																					
TEXT=((<i>text addr</i> , <i>line type</i>),...(<i>text addr</i> , <i>line type</i>))																						
	The permissible <i>line types</i> , text lengths, and maximum numbers of each line type are shown below:																					
	<table border="1"> <thead> <tr> <th>line type</th> <th>text</th> <th>maximum number</th> </tr> </thead> <tbody> <tr> <td>C</td> <td>34 char</td> <td>1 C type</td> </tr> <tr> <td>L</td> <td>70 char</td> <td>2 L type</td> </tr> <tr> <td>D</td> <td>70 char</td> <td>10 D type</td> </tr> <tr> <td>DE</td> <td>70 char</td> <td>1 DE type</td> </tr> <tr> <td></td> <td>or</td> <td></td> </tr> <tr> <td>E</td> <td>None</td> <td>1 E type</td> </tr> </tbody> </table>	line type	text	maximum number	C	34 char	1 C type	L	70 char	2 L type	D	70 char	10 D type	DE	70 char	1 DE type		or		E	None	1 E type
line type	text	maximum number																				
C	34 char	1 C type																				
L	70 char	2 L type																				
D	70 char	10 D type																				
DE	70 char	1 DE type																				
	or																					
E	None	1 E type																				
	The maximum total number of lines that can be coded in one instruction is 10.																					
,ROUTCDE=(<i>routing code</i>)	<i>routing code</i> : Decimal digit from 1 to 28. The <i>routing code</i> is one or more codes, separated by commas, or a hyphen to indicate a range.																					

Syntax	Description
,MCSFLAG=(<i>flag name</i>)	<i>flag name</i> : Any combination of the following, separated by commas: CMD HRDCPY RESP REPLY NOTIME BRDCST
,DESC=(<i>descriptor code</i>)	<i>descriptor code</i> : Decimal number from 1 to 13. The <i>descriptor code</i> is one or more codes, separated by commas.
,CART= <i>cmd/resp token</i>	<i>cmd/resp token</i> : RX-type address or register (2) - (12).
,KEY= <i>key</i>	<i>key</i> : RX-type address or register (2) - (12).
,TOKEN= <i>token</i>	<i>token</i> : RX-type address or register (2) - (12).
,CONSID= <i>console id</i> ,CONSNAME= <i>console name</i>	<i>console id</i> : RX-type address or register (2) - (12). <i>console name</i> : RX-type address or register (2) - (12).

Parameters

The parameters are explained as follows:

'msg'

('text')

('text',line type)

TEXT=(text addr)

TEXT=(text addr,line type)

TEXT=((text addr,line type),...(text addr,line type))

Specifies the message or multiple-line message to be written to one or more operator consoles.

The parameter *'msg'* is used to write a single-line message to the operator. In the format, the message must be enclosed in apostrophes, which do not appear on the console. To have apostrophes appear in the message text, use two apostrophes to get one to appear. For example, "Message Off" would appear on a display as 'Message Off'. The message text can include any character that can be used in a character (C-type) DC instruction. When a program issues a WTO macro, the system translates the text; only standard printable EBCDIC characters are passed to MCS-managed display devices. The EBCDIC characters that can be displayed are listed in *z/OS MVS Programming: Assembler Services Guide*. All other characters are replaced by blanks. Unless the console has dual-case capability, lowercase characters are displayed or printed as uppercase characters.

The message is assembled as a variable-length record. The parameters TEXT=(*text addr*) and TEXT=(*text addr,line type*) represent a 4-byte address of a message to be displayed. The message consists of a 2-byte message length followed by the message text. The 2-byte message length describes the length of the message text only. There are no boundary requirements.

The parameters (*text*) and (*text addr,line type*) are used to write a multiple-line message to the operator. The text is one line of the multiple-line message. Inline text consists of a character string enclosed in apostrophes (which do not appear on the operator console). Any character valid in a C-type DC instruction can be coded. The maximum number of characters depends on which line type is specified. The message can be up to ten lines long; the system truncates the message at the end of the tenth line. The ten-line limit does not include the control line (message IEE9321I), as explained under line type C below.

Note:

1. If the parameter (*text*) is coded without repetition, for example, (*text*), the message appears as a single-line message.
2. All lines of a multiple-line WTO must be consistently specified with the message text or the TEXT keyword. When coding the TEXT keyword for a multiple-line message:
 - You can specify a maximum of 10 lines.
 - Do not exceed the 70-character limit for the macro parameter value.
3. For a multiple-line message, you must clear the three high-order bytes of register 0.

The line type defines the type of information contained in the “text” field of each line of the message:

C

Indicates that the “text” parameter is the text to be contained in the control line of the message. The control line normally contains a message title. C may only be coded for the first line of a multiple-line message. If this parameter is omitted and descriptor code 9 is coded, the system generates a control line (message IEE932I) containing only a message identification number. The control line remains static while you scroll through all the lines of a multiple-line message displayed on an MCS console (provided that the message is displayed in an out-of-line display area). Control lines are optional.

L

Indicates that the “text” parameter is a label line. Label lines contain message heading information; they remain static while you scroll through all the lines of a multiple-line message displayed on an MCS console (provided that the message is displayed in an out-of-line display area). Label lines are optional. If coded, lines must either immediately follow the control line, or another label line or be the first line of the multiple-line message if there is no control line. Only two label lines may be coded per message.

D

Indicates that the “text” parameter contains the information to be conveyed to the operator by the multiple-line message. While you scroll through all lines of a multiple-line message displayed on an MCS console, the data lines are paged.

DE

Indicates that the “text” parameter contains the last line of information to be passed to the operator. Specify DE on the last line of text of the WTO. If there is no text on the last line, specify E.

E

Indicates that the previous line of text was the last line of text to be passed to the operator. The “text” parameter, if any, coded with a line type of E is ignored. If the last line has text, specify DE.

,ROUTCDE=(routing code)

Specifies the routing code or codes to be assigned to the message.

The routing codes are:

The routing codes are:

Code

Meaning

1

Operator Action

The message indicates a change in the system status. It demands action by the operator at the console with master authority.

2**Operator Information**

The message indicates a change in system status. It does not demand action; rather, it alerts the operator at the console with master authority to a condition that might require action.

This routing code is used for any message that indicates job status when the status is not requested specifically by an operator inquiry. It is also used to route processor and problem program messages to the system operator.

3**Tape Pool**

The message gives information about tape devices, such as the status of a tape unit or reel, the disposition of a tape reel, or a request to mount a tape.

4**Direct Access Pool**

The message gives information about direct access storage devices (DASD), such as the status of a direct access unit or volume, the disposition of a volume, or a request to mount a volume.

5**Tape Library**

The message gives tape library information, such as a request by volume serial numbers for tapes for system or problem program use.

6**Disk Library**

The message gives disk library information, such as a request by volume serial numbers for volumes for system or problem program use.

7**Unit Record Pool**

The message gives information about unit record equipment, such as a request to mount a printer train.

8**Teleprocessing Control**

The message gives the status or disposition of teleprocessing equipment, such as a message that describes line errors.

9**System Security**

The message gives information about security checking, such as a request for a password.

10**System/Error Maintenance**

The message gives problem information for the system programmer, such as a system error, an uncorrectable I/O error, or information about system maintenance.

11**Programmer Information**

This is commonly referred to as write to programmer (WTP). The message is intended for the problem programmer. This routing code is used when the program issuing the message cannot route the message to the programmer through a system output (SYSOUT) data set. The message appears in the JESYSMSG data set.

12**Emulation**

The message gives information about emulation. (These message identifiers are not included in this publication.)

13-20

For customer use only.

21-28

For subsystem use only.

29

Disaster recovery.

30-40

For IBM use only.

41

The message gives information about JES3 job status.

42

The message gives general information about JES2 or JES3.

43-64

For JES use only.

65-96

Messages associated with particular processors.

97-128

Messages associated with particular devices.

If you omit the ROUTCDE, DESC, and CONSID or CONSNAME parameters, the system uses the routing code specified on the ROUTCODE parameter on the DEFAULT statement in the CONSOLxx member of SYS1.PARMLIB.

Note: Routing codes 1, 2, 3, 4, 7, 8, and 10 cause hard copy of the message when display consoles are used, or more than one console is active. All other routing codes may go to hard copy as a PARMLIB option or as a result of a VARY HARDCPY command.

,MCSFLAG=(flag name)

Specifies one or more flag names whose meanings are shown below:

<i>Table 65. MCSFLAG Flag Names for WTO Macro</i>	
Flag Name	Meaning
RESP	The WTO is an immediate command response.
REPLY	This WTO is a reply to a WTOR.
BRDCST	Broadcast the message to all active consoles.
HRDCPY	Queue the message for hardcopy only.
NOTIME	Do not append time to the message.
CMD	The WTO is a recording of a system command issued for hardcopy log purposes.

,DESC=(descriptor code)

Specifies the message descriptor code or codes to be assigned to the message. Descriptor codes 1 through 6, 11 and descriptor code 12 are mutually exclusive. Codes 7 through 10, and 13, can be assigned in combination with any other code.

The descriptor codes are:

Code**Meaning**

1

System Failure

The message indicates an error that disrupts system operations. To continue, the operator must reIPL the system or restart a major subsystem. This causes the audible alarm to be issued.

Note:

- Descriptor code 1 messages are retained if the Action Message Retention Facility (AMRF) is active.
- Descriptor code 1 messages do not automatically roll off a console in RD mode.

2

Immediate Action Required

The message indicates that the operator must perform an action immediately. The message issuer could be in a wait state until the action is performed or the system needs the action as soon as possible to improve performance. The task waits for the operator to complete the action. This causes the audible alarm to be issued.

Note:

- When an authorized program issues a message with descriptor code 2, a DOM macro *must* be issued to delete the message after the requested action is performed.
- Descriptor code 2 messages are retained if the Action Message Retention Facility (AMRF) is active.
- Descriptor code 2 messages do not automatically roll off a console in RD mode.

3

Eventual Action Required

The message indicates that the operator must perform an action eventually. The task does not wait for the operator to complete the action.

If the task can determine when the operator has performed the action, the task should issue a DOM macro to delete the message when the action is complete.

Note: Descriptor code 3 messages are retained if the Action Message Retention Facility (AMRF) is active.

4

System Status

The message indicates the status of a system task or of a hardware unit.

5

Immediate Command Response

The message is issued as an immediate response to a system command. The response does not depend on another system action or task.

6

Job Status

The message indicates the status of a job or job step.

7

Task-Related

The message is issued by an application or system program. Messages with this descriptor code are deleted when the job step that issued them ends.

8

Out-of-Line

The message, which is one line of a group of one or more lines, is to be displayed out-of-line. If a message cannot be displayed out-of-line because of the device being used, descriptor code 8 is ignored, and the message is displayed in-line with the other messages.

Note: Both descriptor codes 8 and 9 must be specified to cause a message to be displayed out-of-line.

9

Operator's Request

The message is written in response to an operator's request for information by a DEVSERV, DISPLAY, TRACK, or MONITOR command.

Note: Both descriptor codes 8 and 9 must be specified to cause a message to be displayed out-of-line.

10

Not defined

Descriptor code 10 is not currently in use.

11

Critical Eventual Action Required

The message indicates that the operator must perform an action eventually, and the action is important enough for the message to remain on the display screen until the action is completed. The task does not wait for the operator to complete the action. This causes the audible alarm to be issued.

Avoid using this descriptor code for non-critical messages because the display screen could become filled.

If the task can determine when the operator has performed the action, the task should issue a DOM macro to delete the message when the action is complete.

Note:

- Descriptor code 11 messages are retained if the Action Message Retention Facility (AMRF) is active.
- Descriptor code 11 messages do not automatically roll off a console in RD mode.

12

Important Information

The message contains important information that must be displayed at a console, but does not require any action in response.

13

Automation Information

Indicates that this message was previously automated.

Action messages may have an * sign or @ sign displayed before the first character of the message. The * sign indicates that the WTO was issued by an authorized program. The @ sign indicates that the WTO was issued by an unauthorized program. These action messages cause the audible alarm to sound on operator consoles so-equipped.

All WTO messages with descriptor codes of 1, 2, or 11 are action messages that have an @ sign printed before the first character. This indicates a need for operator action.

The system holds messages with descriptor codes 1, 2, 3, or 11 until you delete them. When you no longer need messages with descriptor codes 1, 2, 3, or 11, you should delete those messages using the DOM macro. If messages with descriptor codes 1, 2, 3, or 11 also have descriptor code 7, the system deletes them automatically at job step. The system adds descriptor code 7 to all messages with descriptor code 1 or 2.

WTO macro

On operator consoles that support color, descriptor codes determine the color in which a message should be displayed. The colors used are described in [z/OS MVS System Commands](#).

The message processing facility (MPF) can suppress messages. For MPF to suppress messages, the hardcopy log must be active. The suppressed messages do not appear on any console; they do appear on the hardcopy log.

,CART=cmd/resp token

Specifies an 8-character input field containing a command and response token to be associated with this message. The command and response token is used to associate user information with a command and its command response. You can supply any value as a command and response token. When you specify this parameter in the list form, code it as CART= with nothing after the equal sign.

,KEY=key

Specifies an input field containing an 8-byte key to be associated with this message. The key must be EBCDIC if used with the MVS DISPLAY R command for retrieval purposes, but it must not be '*'. If a register is used, it contains the address of the key. When you specify this parameter in the list form, code it as KEY= with nothing after the equal sign.

,TOKEN=token

Specifies an input field containing a 4-byte token to be associated with this message. This field is used to identify a group of messages that can be deleted by a DOM macro that includes TOKEN. The token must be unique within an address space and can be any value. When you specify this parameter in the list form, code it as TOKEN= with nothing after the equal sign.

Note: When you code the TOKEN parameter using a register, the register must contain the token itself, rather than the address of the token.

,CONSID=console id

Specifies a 4-byte field containing the ID of the console to receive a message. If you specify a 4-byte console ID, or if you specify a console ID for an extended MCS console, you must use CONSID. To view a list of valid console IDs, issue the DISPLAY CONSOLES command.

Note:

1. If you code the CONSID parameter using a register, the register must contain the console ID itself, rather than the address of the console ID.
2. When you code CONSID on the list form of WTO, code it as CONSID= with nothing after the equal sign.
3. CONSID is mutually exclusive with the CONSNAME parameter.

,CONSNAME=console name

Specifies an 8-byte field containing a 2- through 8-character name, left-justified and padded with blanks, of the console to receive a message. When you specify this parameter in the list form, code it as CONSNAME= with nothing after the equal sign.

This parameter is mutually exclusive with the CONSID parameter. Do not use CONSNAME to pass a console name, together with register 0 to pass a console ID, because the results are unpredictable. Be sure to clear the low-order byte of register 0 if you add the CONSNAME parameter to an existing invocation of WTO.

ABEND codes

WTO might abnormally terminate with abend code X'D23'. See [z/OS MVS System Codes](#) for an explanation and programmer response for this code.

Return and reason codes

When the WTO macro returns control to your program, GPR 15 contains one of the following return codes:

Hexadecimal Return Code	Meaning and Action
00	Meaning: Processing completed successfully. Action: None.
02	Meaning: Processing was not completely successful. This could be due to inconsistent parameters given to WTO, or it could be an environmental problem. Action: A D23 abend has been issued for diagnostic purposes only. No dump has been taken; if a dump is needed, you must set a SLIP trap. Correct any inconsistencies in the WTO invocation.
04	Meaning: Program error. The length of text for a message line was not correct. Action: <ul style="list-style-type: none"> • Make sure your text is properly referenced. If you are using the TEXT parameter, make sure it is pointing to valid data. • Make sure your message text is defined correctly. If you are using the TEXT parameter, make sure the first two bytes of data in the area pointed to by the TEXT parameter value contain the length of the message text. In all cases, correct the problem and retry the request.
18	Meaning: Program error. The WPL was invalid and a symptom record was written to LOGREC to describe the error. The message was not processed. Action: Correct the WPL.
30	Meaning: Environmental error. For routing code 11, the required resource was not available and the request was ignored. For any other routing code, the request was processed. Action: Retry the request when the resource you need is available.

Example 1

Issue a WTO with routing codes 1 and 10, descriptor code 2.

```
WTO      'USR001I CRITICAL RESOURCE SHORTAGE DETECTED',      X
         ROUTCDE=(1,10),                                     X
         DESC=(2)
```

Example 2

Issue a WTO using the TEXT parameter. The message is to be sent to a console whose ID is contained in register 5 as a command response. A command and response token is also defined for this message. This example assumes a console ID was stored in field SAVECNID and a cart in SAVECART prior to issuing the WTO.

```
R0      EQU      0
R4      EQU      4
R5      EQU      5
.
.
.
LA      R4,MYMSG      ADDRESS OF MESSAGE AREA
L       R5,SAVECNID   CONSOLE ID
XR      R0,R0        CLEAR REGISTER 0
WTO     TEXT=(R4),CONSID=(R5),CART=SAVECART,      X
         DESC=(5)
.
.
.
```

WTO macro

```
MYMSG DC AL2(L'CATTXT)
CATTXT DC C'USR100I PROCESSING COMPLETE, NO ERRORS.'
SAVECART DS CL8
SAVECNID DS F
```

Example 3

Issue a multiline message using the TEXT parameter. This is an important information message which is not to be sent to the hardcopy log.

```
R0 EQU 0
.
.
XR R0,R0 CLEAR REG0 BEFORE MULTILINE
WTO TEXT=((MESSAG1,D),(MESSAG2,D),(MESSAG3,DE)), X
DESC=(7,12)
.
.
MESSAG1 DC AL2(L'MSG1TXT)
MSG1TXT DC C'USR005I ALL JOBS REQUIRING MORE THAN 2 TAPES MUST BE RUNX
ON THIRD SHIFT'
MESSAG2 DC AL2(L'MSG2TXT)
MSG2TXT DC C'JOBS REQUIRING 2 TAPES MAY BE RUN ON SECOND SHIFT'
MESSAG3 DC AL2(L'MSG3TXT)
MSG3TXT DC C'OR ON FIRST SHIFT WITH THE OPERATORS PERMISSION.'
```

Example 4

To prevent parameter lists that are not valid from causing system errors, the WTO service records the errors as symptom records in LOGREC. Here is a sample symptom record:

```
THE SYMPTOM RECORD DOES NOT CONTAIN A SECONDARY SYMPTOM STRING.
FREE FORMAT COMPONENT INFORMATION:
KEY = F000 LENGTH = 000024 (0018)
+000 C9D5C3D6 D9D9C5C3 E340E6E3 D640C9D5 |INCORRECT WTO IN|
+010 E5D6C3C1 E3C9D6D5 |VOCATION |
KEY = F000 LENGTH = 000010 (000A)
+000 C1E4E3C8 D6D9C9E9 C5C4 |AUTHORIZED |
KEY = F000 LENGTH = 000009 (0009)
+000 C1E2C9C4 61F0F0F0 F1 |ASID/0001 |
KEY = F000 LENGTH = 000016 (0010)
+000 D1D6C2D5 C1D4C561 5CD4C1E2 E3C5D95C |JOBNAME/*MASTER*|
KEY = F000 LENGTH = 000025 (0019)
+000 C9D5E5D6 D2C5D961 C9C5C5C3 C2F9F9F9 |INVOKER/IEECB999|
+010 4EF0F0F0 F0F4C5C4 F2 |+00004ED2 |
KEY = F000 LENGTH = 000032 (0020)
+000 C5D5C4D3 C9D5C540 C4C5E3C5 C3E3C5C4 |ENDLINE DETECTED|
+010 40C2C5C6 D6D9C540 E6D7D3D3 C9D5C5E2 | BEFORE WPLINES|
KEY = F000 LENGTH = 000017 (0011)
+000 C3E4D9D9 C5D5E340 D3C9D5C5 61F0F0F0 |CURRENT LINE/000|
+010 F2 |2 |
KEY = F000 LENGTH = 000003 (0003)
+000 E6D7D3 |WPL |
KEY = FF00 LENGTH = 000216 (00D8)
+000 00480050 F0F0F2F2 40C5D5C1 C2D3C5C4 |...&0022 ENABLED|
+010 4040F0F0 F2F340C5 D5C1C2D3 C5C44040 | 0023 ENABLED |
+020 F0F0F2F4 40C5D5C1 C2D3C5C4 4040F0F0 |0024 ENABLED 00|
+030 F2F540C5 D5C1C2D3 C5C44040 F0F0F2F6 |25 ENABLED 0026|
+040 40C5D5C1 C2D3C5C4 0400007C 10000000 | ENABLED...@....|
+050 00000000 00000000 000004D2 00000000 |.....K....|
+060 LENGTH(0048) ==> ALL BYTES CONTAIN X'00'.
+090 00000000 40404040 40404040 00000000 |.... |
+0A0 LENGTH(0032) ==> ALL BYTES CONTAIN X'00'.
+0C0 00000000 2000C103 00103000 F0F0F2F7 |.....A.....0027|
+0D0 40C5D5C1 C2D3C5C4 |ENABLED |
KEY = F000 LENGTH = 000010 (000A)
+000 D4C1D1D6 D940E3C5 E7E3 |MAJOR TEXT |
KEY = F000 LENGTH = 000034 (0022)
+000 40C9C5C5 F7F3F5C9 40F1F74B F2F74BF3 |IEE000I 17.27.3|
+010 F940C4E4 D4D4E840 C4C9E2D7 D3C1E840 |9 DUMMY DISPLAY |
+020 F2F3F4 |234 |
```

This symptom record indicates that this is a WTO error. It also indicates whether the WTO issuer was authorized. The symptom record also contains the following information:

- The ASID, job name, program name, and an offset into the program that issued the WTO. You can use this information to help identify the issuer.
- A description of the error.
- The message line number where the error was detected.
- The text of the first line, if the message is a multi-line WTO.

Once you diagnose the reason for the error, correct the WTO invocation to issue the message properly, or contact the owner of the application that is issuing the WTO to have it corrected.

WTO - List form

Use the list form of the WTO macro together with the execute form of the macro for applications that require reentrant code. The list form of the macro defines an area of storage, which the execute form of the macro uses to store the parameters.

Syntax

The list form of the WTO macro is written as follows:

Syntax	Description																					
<i>name</i>	<i>name</i> : Symbol. Begin <i>name</i> in column 1.																					
b	One or more blanks must precede WTO.																					
WTO																						
b	One or more blanks must follow WTO.																					
<i>'msg'</i> <i>('text')</i> <i>('text',line type)</i> TEXT= TEXT=(<i>(,line type),(line type),...,(line type)</i>)	<p><i>msg</i>: Up to 126 characters. <i>text</i>: Up to 126 characters.</p> <p>Note:</p> <ol style="list-style-type: none"> 1. If you code <i>'msg'</i> or <i>('text'...)</i>, it must be the first parameter you code. 2. For a single-line WTO, the parameter value is not required on TEXT for the list form. Code only TEXT=. Then code TEXT=<i>text addr</i> on the execute form. 																					
	<p>The permissible <i>line types</i>, text lengths, and maximum numbers of each line type are shown below:</p> <table border="1"> <thead> <tr> <th>line type</th> <th>text</th> <th>maximum number</th> </tr> </thead> <tbody> <tr> <td>C</td> <td>34 char</td> <td>1 C type</td> </tr> <tr> <td>L</td> <td>70 char</td> <td>2 L type</td> </tr> <tr> <td>D</td> <td>70 char</td> <td>10 D type</td> </tr> <tr> <td>DE</td> <td>70 char</td> <td>1 DE type</td> </tr> <tr> <td></td> <td>or</td> <td></td> </tr> <tr> <td>E</td> <td>None</td> <td>1 E type</td> </tr> </tbody> </table>	line type	text	maximum number	C	34 char	1 C type	L	70 char	2 L type	D	70 char	10 D type	DE	70 char	1 DE type		or		E	None	1 E type
line type	text	maximum number																				
C	34 char	1 C type																				
L	70 char	2 L type																				
D	70 char	10 D type																				
DE	70 char	1 DE type																				
	or																					
E	None	1 E type																				

Syntax	Description
	The maximum total number of lines that can be coded in one instruction is 10.
,ROUTCDE=(<i>routing code</i>)	<i>routing code</i> : Decimal digit from 1 to 28. The <i>routing code</i> is one or more codes, separated by commas, or a hyphen to indicate a range.
,MCSFLAG=(<i>flag name</i>)	<i>flag name</i> : Any combination of the following, separated by commas: CMD HRDCPY RESP REPLY NOTIME BRDCST
,DESC=(<i>descriptor code</i>)	<i>descriptor code</i> : Decimal digit from 1 to 13. The <i>descriptor code</i> is one or more codes, separated by commas.
,CART=	Parameter value not required for list form. Code only CART=. If you code CART on the list form of WTO, you must code CART on the execute form.
,KEY=	Parameter value not required for list form. Code only KEY=. If you code KEY on the list form of WTO, you must code KEY on the execute form.
,TOKEN=	Parameter value not required for list form. Code only TOKEN=. If you code TOKEN on the list form of WTO, you must code TOKEN on the execute form.
,CONSID= ,CONSNAME=	Parameter value not required for list form. Code only CONSID= or CONSNAME=. If you code CONSID (or CONSNAME) on the list form of WTO, you must code CONSID (or CONSNAME) on the execute form.
,MF=L	

Parameters

The parameters are explained under the standard form of the WTO macro, with the following exception:

,MF=L

Specifies the list form of the WTO macro.

Example

Set up the list form of a WTO, and send an immediate action message to the master console.

```
MYLIST  WTO  'USR001I CRITICAL RESOURCE SHORTAGE DETECTED',      X
          ROUTCDE=(1,10),                                       X
          DESC=(2),CONSID=,MF=L
```

WTO - Execute form

Use the execute form of the WTO macro together with the list form of the macro for applications that require reentrant code. The execute form of the macro stores the parameters into the storage area defined by the list form.

The message cannot be modified on the execute form of the macro if you code inline text ('msg' or ('text'...)) on the list form.

Syntax

The execute form of the WTO macro is written as follows:

Syntax	Description
<i>name</i>	<i>name</i> : Symbol. Begin <i>name</i> in column 1.
␣	One or more blanks must precede WTO.
WTO	
␣	One or more blanks must follow WTO.
TEXT= <i>text addr</i> TEXT=((<i>text addr</i>),(<i>text addr</i>),...(<i>text addr</i>))	<i>text addr</i> : RX-type address or register (2) - (12). Note: 1. If you code TEXT= <i>text addr</i> on the execute form of WTO, you must code TEXT= on the list form. 2. If you specify inline text on the list form ('msg' or ('text'...)), do not code the TEXT keyword on the execute form.
,CART= <i>cmd/resp token</i>	<i>cmd/resp token</i> : RX-type address or register (2) - (12). If you code CART on the execute form of WTO, you must code CART on the list form.

WTO macro

Syntax	Description
<code>,KEY=key</code>	<i>key</i> : RS-type address or register (2) - (12). If you code KEY on the execute form of WTO, you must code KEY on the list form.
<code>,TOKEN=token</code>	<i>token</i> : RX-type address or register (2) - (12). If you code TOKEN on the execute form of WTO, you must code TOKEN on the list form.
<code>,CONSID=console id</code>	<i>console id</i> : RX-type address or register (2) - (12).
<code>,CONSNAME=console name</code>	<i>console name</i> : RS-type address or register (2) - (12). If you code CONSID (or CONSNAME) on the execute form of WTO, you must code CONSID (or CONSNAME) on the list form.
<code>,MF=(E,list addr)</code>	<i>list addr</i> : RX-type address, or register (1) - (12).

Parameters

The parameters are explained under the standard form of the WTO macro, with the following exception:

,MF=(E,list addr)

Specifies the execute form of the WTO macro.

list addr specifies the area that the system uses to store the parameters.

Example 1

Write a message with a prebuilt parameter list pointed to by register 1.

```
WTO      MF=(E,(1))
```

Example 2

Issue a WTO whose list form is defined at label MYLIST, and is pointed to by register 2. Send the WTO to the console with an ID of 1, pointed to by register 4.

```
R2      EQU    2
R4      EQU    4
.
.
.
LA      R2,MYLIST          ADDRESS OF PARAMETER LIST
L       R4,MYCONID        CONSOLE ID
WTO     MF=(E,(R2)),CONSID=(R4)
.
.
.
MYCONID DC    F'1'
```

Chapter 119. WTOR - Write to operator with reply

Description

The WTOR macro causes a message requiring a reply to be written to one or more operator consoles and the hardcopy log. The macro also provides the information required by the system to return the reply to the issuing program. See *z/OS MVS Programming: Assembler Services Guide* for more information on using the WTOR macro.

For information about how to select the macro for an MVS/SP version other than the current version, see *Compatibility of MVS macros*.

Environment

Requirements for the caller are:

Environmental factor	Requirement
Minimum authorization:	Problem state and any PSW key
Dispatchable unit mode:	Task
Cross memory mode:	PASN=HASN=SASN
AMODE:	24- or 31- or 64-bit
ASC mode:	Primary
Interrupt status:	Enabled for I/O and external interrupts
Locks:	No locks held
Control parameters:	Must be in the primary address space

Programming requirements

Be aware of the following when coding the WTOR macro:

- MCSFLAG=REG0 is not supported on z/OS V1R7 and higher.
- If the list and execute forms of the WTOR macro are in separate modules, both modules must be assembled or compiled with the same level of WTOR.
- IBM recommends that you begin the parameter list for WTOR on a fullword boundary.
- If the execute form of the macro specifies RPLYISUR, CART, CONSID, CONSNAME, KEY, or TOKEN, the list form, to ensure that the parameter list is generated correctly, must specify the same parameters without data. If you specify parameter values on the list form, the system issues an MNOTE and ignores the data.
- For any WTOR parameters that allow a register specification, the value must be right-justified in the register.
- As of z/OS 1.4.2, to prevent parameter lists that are not valid from causing system errors, the WTOR service records the errors as symptom records in LOGREC. One example of an invalid parameter list is an invalid combination of WTOR parameters. The system may also issue a D23 abend for diagnostic purposes only; the program issuing the WTOR will not be abended. Message processing will continue as far as possible using the invalid parameter list.

Due to these invalid parameter list errors, you may notice that some messages that once were processed are no longer able to be processed; your program may also receive different return codes. However, in these cases, the symptom record will always be issued, and the diagnostic D23 abend will be issued if possible. IBM recommends that you correct all WTOR errors, regardless of whether or not

WTOR macro

the message is actually displayed. For an example LOGREC symptom record, see [“Example 4” on page 1144](#) in the WTO description.

If a dump is needed along with the diagnostic D23 abend to debug the problem, the following SLIP can be set to cause dumps to be taken:

```
SLIP SET,ENABLE,COMP=D23,ACTION=SVCD,END
```

Restrictions

- The WTOR macro can issue only single-line messages.
- The caller cannot have an EUT FRR established.

Input register information

Before issuing the WTOR macro, the caller does not have to place any information into any register unless using it in register notation for a particular parameter, or using it as a base register.

Output register information

When control returns to the caller, the GPRs contain:

Register

Contents

0

Used as a work register by the system.

1

Message identification number if the WTOR macro completed normally (you can use this number to delete the message when it is no longer needed); otherwise, used as a work register by the system.

2-13

Unchanged.

14

Used as a work register by the system.

15

Return code.

When control returns to the caller, the access registers (ARs) contain:

Register

Contents

0-1

Used as work registers by the system

2-13

Unchanged

14-15

Used as work registers by the system

Some callers depend on register contents remaining the same before and after issuing a service. If the system changes the contents of registers on which the caller depends, the caller must save them before issuing the service, and restore them after the system returns control.

Performance implications

None.

Syntax

The standard form of the WTOR macro is written as follows:

Syntax	Description
<i>name</i>	<i>name</i> : Symbol. Begin <i>name</i> in column 1.
␣	One or more blanks must precede WTOR.
WTOR	
␣	One or more blanks must follow WTOR.
' <i>msg</i> ', <i>reply addr</i> , <i>reply length</i> , <i>ecb addr</i> TEXT=(<i>text addr</i> , <i>reply addr</i> , <i>reply length</i> , <i>ecb addr</i>)	<i>msg</i> : Up to 122 characters. <i>text addr</i> : RX-type address or register (2) - (12). <i>reply addr</i> : A-type address, or register (2) - (12). <i>reply length</i> : Symbol, decimal number, or register (2) - (12). The minimum length is 1; the maximum length is 119. <i>ecb addr</i> : A-type address, or register (2) - (12).
,ROUTCDE=(<i>routing code</i>)	<i>routing code</i> : Decimal digit from 1 to 28. The <i>routing code</i> is one or more codes, separated by commas, or a hyphen to indicate a range.
,MCSFLAG=(<i>flag name</i>)	<i>flag name</i> : Any combination of the following, separated by commas: BRDCST HRDCPY RESP REPLY NOTIME
,DESC=(<i>descriptor code</i>)	<i>descriptor code</i> : Decimal number 7 or 13. If you code both 7 and 13, separate them with commas.

Syntax	Description
,MSGTYP=(<i>msg type</i>)	<p><i>msg type</i>: Any of the following:</p> <p>N SESS,JOBNAMES</p> <p>Y SESS,STATUS</p> <p>SESS JOBNAMES,STATUS</p> <p>JOBNAMES SESS,JOBNAMES,STATUS</p> <p>STATUS</p> <p>Note: IBM recommends that you do not use MSGTYP=Y. See the MSGTYP explanation on page “,MSGTYP=(<i>msg type</i>)” on page 1155 for more information.</p>
,RPLYISUR= <i>reply console</i>	<i>reply console</i> : RX-type address or register (2) - (12).
,CART= <i>cmd/resp token</i>	<i>cmd/resp token</i> : RX-type address or register (2) - (12).
,CONSID= <i>console id</i>	<i>console id</i> : RX-type address or register (2) - (12).
,CONSNAME= <i>console name</i>	<i>console name</i> : RX-type address or register (2) - (12).
,KEY= <i>key</i>	<i>key</i> : RX-type address or register (2) - (12).
,TOKEN= <i>token</i>	<i>token</i> : RX-type address or register (2) - (12).

Parameters

The parameters are explained as follows:

'msg',reply addr,reply length,ecb addr
TEXT=(*text addr,reply addr,reply length,ecb addr*)

'msg' is used to write the message to the operator. The message must be enclosed in apostrophes, which do not appear on the console. It can include any character that can be used in a character (C-type) DC instruction. When a program issues a WTOR macro, the system translates the text; only standard printable EBCDIC characters are passed to the display devices. All other characters are replaced by blanks. A list of these EBCDIC characters is provided in *z/OS MVS Programming: Assembler Services Guide*. Unless the console has dual-case capability, lowercase characters are converted to uppercase by the display station or printer and displayed or printed as uppercase characters.

The message is assembled as a variable-length record. *text addr* contains an address that points to a message to be displayed. The message contains a 2-byte text field length followed by the text. The 2-byte message length describes the length of the message text only. There are no boundary requirements.

Note: All WTOR messages are action messages. An indicator is printed before the first character of an action message to indicate a need for operator action. Action messages will cause the audible alarm to sound on operator consoles so-equipped.

reply addr specifies the address in virtual storage of the area into which the system is to place the reply. The reply is left-justified at this address.

reply length specifies the length, in bytes, of the reply message.

ecb addr specifies the address of the event control block (ECB) to be used by the system to indicate the completion of the reply. The value of the ECB data must point to a fullword boundary. The ECB should be zeroed before the WTOR issued. After the system receives the reply, the ECB appears as follows:

Offset	Length(bytes)	Contents
0	1	Completion code

Note: Use RPLYISUR to obtain the 4-byte console ID and console name of the console issuing the reply.

,ROUTCDE=(routing code)

Specifies the routing code or codes to be assigned to the message.

The routing codes are:

The routing codes are:

Code

Meaning

1

Operator Action

The message indicates a change in the system status. It demands action by the operator at the console with master authority.

2

Operator Information

The message indicates a change in system status. It does not demand action; rather, it alerts the operator at the console with master authority to a condition that might require action.

This routing code is used for any message that indicates job status when the status is not requested specifically by an operator inquiry. It is also used to route processor and problem program messages to the system operator.

3

Tape Pool

The message gives information about tape devices, such as the status of a tape unit or reel, the disposition of a tape reel, or a request to mount a tape.

4

Direct Access Pool

The message gives information about direct access storage devices (DASD), such as the status of a direct access unit or volume, the disposition of a volume, or a request to mount a volume.

5

Tape Library

The message gives tape library information, such as a request by volume serial numbers for tapes for system or problem program use.

6

Disk Library

The message gives disk library information, such as a request by volume serial numbers for volumes for system or problem program use.

7**Unit Record Pool**

The message gives information about unit record equipment, such as a request to mount a printer train.

8**Teleprocessing Control**

The message gives the status or disposition of teleprocessing equipment, such as a message that describes line errors.

9**System Security**

The message gives information about security checking, such as a request for a password.

10**System/Error Maintenance**

The message gives problem information for the system programmer, such as a system error, an uncorrectable I/O error, or information about system maintenance.

11**Programmer Information**

This is commonly referred to as write to programmer (WTP). The message is intended for the problem programmer. This routing code is used when the program issuing the message cannot route the message to the programmer through a system output (SYSOUT) data set. The message appears in the JESYSMSG data set.

12**Emulation**

The message gives information about emulation. (These message identifiers are not included in this publication.)

13-20

For customer use only.

21-28

For subsystem use only.

29

Disaster recovery.

30-40

For IBM use only.

41

The message gives information about JES3 job status.

42

The message gives general information about JES2 or JES3.

43-64

For JES use only.

65-96

Messages associated with particular processors.

97-128

Messages associated with particular devices.

If you omit the ROUTCDE, and CONSID or CONSNAME parameters, the system uses the routing code specified on the ROUTCODE parameter on the DEFAULT statement in the CONSOLxx member of SYS1.PARMLIB.

,MCSFLAG=(flag name)

Specifies one or more flag names whose meanings are shown below:

<i>Table 66. MCSFLAG Flag Names for WTOR Macro</i>	
Flag Name	Meaning
RESP	The WTOR is an immediate command response.
REPLY	This is a reply to a WTOR.
BRDCST	Broadcast the message to all active consoles.
HRDCPY	Queue the message for hard copy only.
NOTIME	Do not append time to the message.

,DESC=(descriptor code)

Specifies the message descriptor code or codes to be assigned to the message. Valid descriptor codes for the WTOR macro are:

7

Retain action message for life-of-task

13

Message previously automated

All WTOR messages are action messages that have an @ sign displayed before the first character. This indicates a need for operator action.

The system adds descriptor code 7 to all WTOR messages. The system holds all WTOR messages until one of the following events occurs:

- The system deletes the WTOR message when the reply is received.
- You delete the WTOR message using the DOM macro. You should delete any unanswered WTOR messages that are no longer current.
- The system deletes the WTOR message at task termination.

The message processing facility (MPF) can suppress messages. For MPF to suppress messages, the hardcopy log must be active. The suppressed messages do not appear on any console; they do appear on the hardcopy log.

,MSGTYP=(msg type)

Specifies how the message is to be routed to consoles on which the MONITOR command is active. If you specify anything other than MSGTYP=N, which is the default, your message is routed according to your specification on MSGTYP, and the ROUTCDE parameter is ignored.

For SESS, JOBNAMEs, or STATUS, the message is to be routed to the console that issued the MONITOR SESS, MONITOR JOBNAMEs, or MONITOR STATUS command, respectively. When the message type is identified by the operating system, the message is routed to only those consoles that requested the information.

For Y or N, the message type describes what functions (MONITOR SESS, MONITOR JOBNAMEs, and MONITOR STATUS) are desired. N, or omission of the MSGTYP parameter, indicates that the message is to be routed as specified in the ROUTCDE parameter. Y creates an area in the WTO parameter list in which you can set message type information if you are coding a WTOR without any of the following parameters:

- KEY
- TOKEN
- CONSID
- CONSNAME
- TEXT

- RPLYISUR
- CART
- LINKAGE
- SYNCH

IBM recommends that you do not use MSGTYP=Y.

,RPLYISUR =reply console

Specifies a 12-byte field where the system will place the 8-byte console name and the 4-byte console ID of the console through which the operator replies to this message. When you specify this keyword in the list form, code it as RPLYISUR= with nothing after the equal sign.

,CART=cmd/resp token

Specifies an 8-byte field containing a command and response token to be associated with this message. The command and response token is used to associate user information with a command and its command response. When you specify this keyword in the list form, code it as CART= with nothing after the equal sign.

,CONSID=console id

Specifies a 4-byte field containing the ID of the console to receive a message. To view a list of valid console IDs, issue the DISPLAY CONSOLES command. Use this ID in place of a console ID in register 0. If you specify a 4-byte console ID, or if you specify a console ID for an extended MCS console, you must use CONSID instead of register 0. If you specify a 1-byte console ID, you must right-justify it and pad to the left with zeros.

Note:

1. If you code the CONSID parameter using a register, the register must contain the console ID itself, rather than the address of the console ID.
2. When you code CONSID on the list form of WTOR, code it as CONSID= with nothing after the equal sign.
3. Do not use both CONSID and register 0 to pass a console ID, because the results are unpredictable.
4. CONSID is mutually exclusive with the CONSNAME parameter.

,CONSNAME=console name

Specifies an 8-byte field containing a 2- through 8- character name, left-justified and padded with blanks, of the console to receive a message. This parameter is mutually exclusive with the CONSID parameter. When you specify this keyword in the list form, code it as CONSNAME= with nothing after the equal sign. Do not use CONSNAME to pass a console name, together with register 0 to pass a console ID, because the results are unpredictable. Be sure to clear the low-order byte of register 0 if you add the CONSNAME parameter to an existing invocation of WTOR.

,KEY=key

Specifies a field containing an 8-byte key to be associated with this message. The key must be EBCDIC if used with the MVS DISPLAY R command for retrieval purposes, but it must not be '*'. The key must be left-justified and padded on the right with blanks. If a register is used, it contains the address of the key. When this keyword is specified in the list form, it must be coded as KEY= with nothing after the equal sign.

,TOKEN=token

Specifies a field containing a 4-byte token to be associated with this message. This field is used to identify a group of messages that can be deleted by a DOM macro that includes TOKEN. The token must be unique within an address space and can be any value. When you specify this keyword on the list form, code it as TOKEN= with nothing after the equal sign.

Note: When you code the TOKEN parameter using a register, the register must contain the token itself, rather than the address of the token.

ABEND codes

WTOR might abnormally terminate with abend code X'D23'. See [z/OS MVS System Codes](#) for an explanation and programmer response for this code.

Return and reason codes

When the WTOR macro returns control to your program, GPR 15 contains one of the following return codes.

Hexadecimal Return Code	Meaning and Action
00	<p>Meaning: Processing completed successfully.</p> <p>Action: None. Be sure to delete the request by issuing the DOM macro.</p>
02	<p>Meaning: Processing was not completely successful. This could be due to inconsistent parameters given to WTOR, or it could be an environmental problem.</p> <p>Action: A D23 abend has been issued for diagnostic purposes only. No dump has been taken; if a dump is needed, you must set a SLIP trap. Correct any inconsistencies in the WTOR invocation.</p>
04	<p>Meaning: Program error. The length of text for a message line was not correct.</p> <p>Action:</p> <ul style="list-style-type: none"> • Make sure your text is properly referenced. If you are using the TEXT parameter, make sure it is pointing to valid data. • Make sure your message text is defined correctly. If you are using the TEXT parameter, make sure the first two bytes of data in the area pointed to by the TEXT parameter value contain the length of the message text. <p>In all cases, correct the problem and retry the request.</p>
18	<p>Meaning: Program error. The WPL was invalid and a symptom record was written to LOGREC to describe the error. The message was not processed.</p> <p>Action: Correct the WPL.</p>

Example 1

Issue a WTOR to a console whose ID is in register 4.

```

      WTOR  'USR902A REPLY YES OR NO TO CONTINUE.' ,REPLY,L8,REPECB, X
          CONSID=(R4) ,RPLYISUR=CONINFO
      .
      .
R4      EQU 4
L8      EQU 8
REPLY   DS  CL8
REPECB  DS  F
CONINFO DS  CL12

```

Example 2

Issue a WTOR with the TEXT parameter. The message is to go to a specific console whose name is in field TOCON.

```

R4      EQU 4
LENG72 EQU 72
      .
      .

```

WTOR macro

```

      .
      LA   R4,CATMSG
      WTOR TEXT=(CATMSG,REPAREA,LENG72,IDSECB),           X
          CONSNAME=TOCON,                               X
          RPLYISUR=IDSAREA
      .
      .
      CATMSG DC AL2(L'REP99)
      REP99  DC C'USR999A ENTER LIST OF USERIDS.'
      TOCON  DC CL8'ALTCON '
      REPAREA DS CL72
      IDSECB DS F
      IDSAREA DS CL12
  
```

Example 3

Issue a WTOR using the TEXT parameter with the list and execute forms of the macro. The console ID to which the message is to be queued is assumed to be in field MYCONID. On the TEXT parameter for the execute form, commas mark the positions of *reply addr* and *ecb addr*; for the list form, a comma marks the position of *reply length*.

```

      R12   EQU   12
      C50   EQU   50                               LENGTH OF REPLY AREA
          USING *,R12
      .
      .
      WTOR MF=(E,M2,EXTENDED),TEXT=(MESSAGE,,C50,),CONSID=MYCONID, X
          RPLYISUR=MYCONAR
      .
      .
      M2    DS    0H
      WTOR TEXT=(,RAREA,,MYECB),CONSID=,ROUTCDE=(2),RPLYISUR=,MF=L
      MYCONID DS F
      RAREA  DS CL50
      MYECB  DS F
      MYCONAR DS CL12
      MESSAGE DC AL2(L'MTEXT)
      MTEXT  DC C'USR930A REQUEST IS AMBIGUOUS. RESPECIFY DEVICE.'
      END
  
```

WTOR - List form

Use the list form of the WTOR macro together with the execute form of the macro for applications that require reentrant code. The list form of the macro defines an area of storage, which the execute form of the macro uses to store the parameters.

The message parameter must be provided in the list form.

Syntax

The list form of the WTOR macro is written as follows:

Syntax	Description
<i>name</i>	<i>name</i> : Symbol. Begin <i>name</i> in column 1.
b	One or more blanks must precede WTOR.
WTOR	

Syntax	Description
<code>␣</code>	One or more blanks must follow WTOR.
<code>'msg',reply addr,reply length,ecb addr</code> <code>TEXT=(,reply addr,reply length,ecb addr)</code>	<p><i>msg</i>: Up to 122 characters. <i>reply addr</i>: A-type address. <i>reply length</i>: Symbol or decimal number. The minimum length is 1; the maximum length is 119. <i>ecb addr</i>: A-type address.</p> <p>Note:</p> <ol style="list-style-type: none"> 1. If you code <i>'msg',reply addr,reply length,ecb addr</i>, it must be the first parameter you code. 2. If you do not code <i>reply addr</i> on the list form of WTOR, mark its position with a comma, and code <i>reply addr</i> on the execute form. The same is true for <i>reply length</i> and <i>ecb addr</i>.
<code>,ROUTCDE=(routing code)</code>	<i>routing code</i> : Decimal digit from 1 to 28. The <i>routing code</i> is one or more codes, separated by commas, or a hyphen to indicate a range.
<code>,MCSFLAG=(flag name)</code>	<p><i>flag name</i>: Any combination of the following, separated by commas:</p> <p>RESP REPLY</p> <p>NOTIME BRDCST</p>
<code>,DESC=(descriptor code)</code>	<i>descriptor code</i> : Decimal number 7 or 13. If you code both 7 and 13, separate them with commas.
<code>,RPLYISUR=</code>	Parameter value not required for list form. Code only RPLYISUR=. If you code RPLYISUR on the list form of WTOR, you must code RPLYISUR on the execute form.
<code>,CART=</code>	Parameter value not required for list form. Code only CART=. If you code CART on the list form of WTOR, you must code CART on the execute form.
<code>,CONSID=</code>	Parameter value not required for list form. Code only CONSID= or CONSNAME=.
<code>,CONSNAME=</code>	If you code CONSID (or CONSNAME) on the list form of WTOR, you must code CONSID (or CONSNAME) on the execute form.

Syntax	Description
,KEY=	Parameter value not required for list form. Code only KEY=. If you code KEY on the list form of WTOR, you must code KEY on the execute form.
,TOKEN=	Parameter value not required for list form. Code only TOKEN=. If you code TOKEN on the list form of WTOR, you must code TOKEN on the execute form.
,MF=L	

Parameters

The parameters are explained under the standard form of the WTOR macro, with the following exception:

,MF=L

Specifies the list form of the WTOR macro.

WTOR - Execute form

Use the execute form of the WTOR macro together with the list form of the macro for applications that require reentrant code. The execute form of the macro stores the parameters into the storage area defined by the list form.

The message cannot be modified on the execute form of the macro if you code inline text ('msg?..') on the list form.

Syntax

The execute form of the WTOR macro is written as follows:

Syntax	Description
<i>name</i>	<i>name</i> : Symbol. Begin <i>name</i> in column 1.
␣	One or more blanks must precede WTOR.
WTOR	
␣	One or more blanks must follow WTOR.

Syntax	Description
<code>,reply addr,reply length,ecb addr</code> <code>TEXT=(text addr,reply addr,reply length,ecb addr)</code>	<p><i>reply addr</i>: RX-type address, or register (2) - (12). <i>reply length</i>: Symbol, decimal number, or register 2-12. The minimum length is 1; the maximum length is 119. <i>ecb addr</i>: RX-type address, or register (2) - (12). <i>text addr</i>: RX-type address or register (2) - (12).</p> <p>Note:</p> <ol style="list-style-type: none"> 1. If you code <i>reply addr,reply length,ecb addr</i>, it must be the first parameter you code and must be preceded by a comma. 2. If you specify inline text on the list form (<i>'msg'...</i>), do not code the TEXT keyword on the execute form. 3. If you do not code <i>reply addr</i> on the execute form of WTOR, mark its position with a comma, and code <i>reply addr</i> on the list form. The same is true for <i>reply length</i> and <i>ecb addr</i>.
<code>,RPLYISUR=reply console</code>	<p><i>reply console</i>: RX-type address or register (2) - (12). If you code RPLYISUR on the execute form of WTOR, you must code RPLYISUR on the list form.</p>
<code>,CART=cmd/resp token</code>	<p><i>cmd/resp token</i>: RX-type address or register (2) - (12). If you code CART on the execute form of WTOR, you must code CART on the list form.</p>
<code>,CONSID=console id</code>	<p><i>console id</i>: RX-type address or register (2) - (12).</p>
<code>,CONSNAME=console name</code>	<p><i>console name</i>: RS-type address or register (2) - (12). If you code CONSID (or CONSNAME) on the execute form of WTOR, you must code CONSID (or CONSNAME) on the list form.</p>
<code>,KEY=key</code>	<p><i>key</i>: RS-type address or register (2) - (12). If you code KEY on the execute form of WTOR, you must code KEY on the list form.</p>
<code>,TOKEN=token</code>	<p><i>token</i>: RX-type address or register (2) - (12). If you code TOKEN on the execute form of WTOR, you must code TOKEN on the list form.</p>
<code>,MF=(E,list addr)</code> <code>,MF=(E,list addr,EXTENDED)</code>	<p><i>list addr</i>: RX-type address, or register (1) - (12).</p>

Parameters

The parameters are explained under the standard form of the WTOR macro, with the following exception:

,reply addr,reply length,ecb addr

If you code *reply addr,reply length,ecb addr*, it must be the first parameter you code and must be preceded by a comma.

,MF=(E,list addr)

,MF=(E,list addr,EXTENDED)

Specifies the execute form of the WTOR macro.

list addr specifies the area that the system uses to store the parameters.

If you specify *reply addr*, *reply length*, or *ecb addr*, on the execute form of WTOR, and any of the following parameters are specified on the list and/or execute form, you must specify EXTENDED for the system to generate the parameter list correctly:

- KEY
- TOKEN
- CONSID
- CONSNAME
- TEXT
- RPLYISUR
- CART
- SYNCH
- Any value of ROUTCDE higher than 16

Chapter 120. XCTL and XCTLX - Pass control to a program in another load module

XCTL and XCTLX description

The XCTL macro passes control to a specified entry name in a load module; the entry name must be a member name, an alias in a directory of a partitioned data set, or have been specified in an IDENTIFY macro. The system brings the load module (called the **target module**) containing the entry name into storage if a usable copy is not already available. Control passes from the program that issues the XCTL or XCTLX (called the **XCTL issuer**) to the target module; control does not return to the XCTL issuer. Rather, control returns to the program that caused the XCTL issuer to run. The use count for the XCTL issuer's load module is decremented by 1. If the use count becomes zero, the system deletes the XCTLX issuer's module and reassigns that storage.

Descriptions of the XCTL and XCTLX macro in this information are:

- The standard form of the XCTL macro, which includes general information about the XCTL and XCTLX macros with specific information about the XCTL macro. The syntax of the XCTL macro and all XCTL parameters are described.
- The standard form of the XCTLX macro, which presents information specific to the XCTLX macro. The topic explains the syntax of the XCTLX macro and the parameters that are valid only on XCTLX.
- The list form of the XCTL and XCTLX macros.
- The execute form of the XCTL and XCTLX macros.

The XCTL or XCTLX issuer can pass data to the target module in register 1 in several ways:

- Using XCTL without LSEARCH and PARAM, placing the data directly in register 1. This choice is not available to the caller in AR mode.
- Using the execute form of the macro, placing the address of the data on the MF parameter. For this choice, the issuer might have used the CALL macro to build a user parameter list.
- Using the execute form of XCTL or XCTLX, specifying the location or locations of the data on the PARAM parameter. XCTL or XCTLX builds a list of the addresses (a user parameter list) at the location you specify on the MF parameter.

The data passed to the target module must not reside within the XCTL issuer's module; if the system deletes the XCTL issuer's module, any data in that module is not available. For more help in understanding passing parameters with XCTL and XCTLX, see [“Examples of passing data to the target module” on page 1172](#).

The target module gets control in the residency mode and addressing mode established by the link-edit. If XCTL=YES was specified on the ESTAE or ESTAEX macro that set up recovery for the XCTL issuer, then the ESTAE-type recovery routine covers the target module also.

The target module must return to the program that caused the XCTL issuer to run. According to linkage conventions, the target module is responsible for restoring the status of the program that originally caused the XCTL issuer to run. The status includes the contents of registers 2 through 14, as well as other information that is expected by the program that caused the XCTL issuer to run, such as:

- The program interruption control area (PICA)
- The program mask.

The system abnormally terminates the task under either of the following conditions:

- The system cannot locate the entry point that is to receive control
- The XCTL issuer added entries to the linkage stack, and did not remove those entries prior to issuing the XCTL.

Environment

The requirements for the caller are:

Environmental factor	Requirement
Minimum authorization:	Problem state and any PSW key
Dispatchable unit mode:	Task
Cross memory mode:	PASN=HASN=SASN
AMODE:	24-bit or 31-bit for XCTL; 24- or 31- or 64-bit for XCTLX
ASC mode:	Primary or access register
Interrupt status:	Enabled for I/O and external interrupts
Locks:	No locks held
Control parameters:	Must reside in the primary address space
User parameters:	Must reside in the primary address space

Syntax

The standard form of the XCTL macro is written as follows:

Syntax	Description
<i>name</i>	<i>name</i> : Symbol. Begin <i>name</i> in column 1.
␣	One or more blanks must precede XCTL.
XCTL	
␣	One or more blanks must follow XCTL.
(<i>reg1</i>), (<i>reg1,reg2</i>),	<i>reg1</i> and <i>reg2</i> : Decimal digits in the order 2 through 12.
EP= <i>entry name</i>	<i>entry name</i> : Symbol.
EPLOC= <i>entry name addr</i>	<i>entry name addr</i> : A-type address or register (2) - (12).
DE= <i>list entry addr</i>	<i>list entry addr</i> : A-type address, or register (2) - (12).
,DCB= <i>dcb addr</i>	<i>dcb addr</i> : A-type address, or register (2) - (12).
,LSEARCH=NO	Default: LSEARCH=NO
,LSEARCH=YES	

Parameters

The parameters are explained as follows:

(reg1),

(reg1,reg2),

Specifies the register or range of registers to be restored before the target routine gets control from the save area at the address contained in register 13. Note that the registers must be specified as decimal numbers; forms like "(R2,R12)" are not accepted.

EP=entry name

EPLOC=entry name addr

DE=list entry addr

Specifies the entry name, the address of the entry name, or the address of a 62-byte list entry for the entry name that was constructed using the BLDL macro. If EPLOC is coded, the name must be padded to eight bytes, if necessary.

The system ignores the information you specify on the DE parameter if the parameter does one or both of the following:

- Specifies an entry in an authorized library (that is, defined in IEAAPFxx member of parmlib)
- Requests access to a program or library that is controlled by the system authorization facility (SAF)

Instead, the system uses the BLDL macro to construct a new list entry containing the DE information.

Note: When you use the DE parameter with the XCTL macro, DE specifies the address of a list that was created by a BLDL macro. BLDL and XCTL must be issued from the same task; otherwise, the system might terminate the program with an abend code of 106 and a return code of 15. Therefore, do not issue an ATTACH or a DETACH macro between issuances of the BLDL and the XCTL macros.

,DCB=dcb addr

Specifies the address of the opened data control block for the partitioned data set containing the entry name described above. This parameter must indicate the same DCB used in the BLDL mentioned above. The DCB must not be defined in the XCTL issuer.

If the DCB parameter is omitted or if DCB=0 is specified when the XCTL macro is issued by the job step task, the data sets referred to by either the STEPLIB or JOBLIB DD statement are first searched for the entry name. If the entry name is not found, the link library is searched.

If the DCB parameter is omitted or if DCB=0 is specified when the XCTL macro is issued by a subtask, the data sets associated with one or more data control blocks referred to by the TASKLIB operand of previous ATTACH macros in the subtasking chain are first searched for the entry point name. If the entry point name is not found, the search is continued as if the XCTL had been issued by the job step task.

Note: The DCB must reside in 24-bit addressable storage.

,LSEARCH=NO

,LSEARCH=YES

Specifies whether (YES) or not (NO) you want the search limited to the job pack area and the first library in the normal search sequence.

Note: When you use LSEARCH on XCTL, the system does not pass the contents of register 1 to the target module, unless you specify MF=(E,(1)) on the execute form.

Return and reason codes

None.

Example

Pass control through the address of the entry name (XCTLEP), and have registers 2 through 12 restored.

```
XCTL (2,12),EPLOC=XCTLEP
```

XCTLX - Pass control to a program in another load module

The XCTLX macro performs the same function as XCTL: it causes control to pass to a specified entry name in another load module, the target module. XCTLX is intended for use by programs running in access register (AR) mode. Programs running in primary mode can also use XCTLX.

If your program runs in AR mode, before you issue the XCTLX macro, issue the SYSSTATE ASCENV=AR macro to tell the XCTLX macro to generate code appropriate for AR mode.

Syntax

The XCTLX macro is written as follows:

Syntax	Description
<i>name</i>	<i>name</i> : Symbol. Begin <i>name</i> in column 1.
b	One or more blanks must precede XCTLX.
XCTLX	
b	One or more blanks must follow XCTLX.
(<i>reg1</i>),	<i>reg1 and reg2</i> : Decimal digits in the order 2 through 12.
(<i>reg1,reg2</i>),	
EP= <i>entry name</i>	<i>entry name</i> : Symbol.
EPLOC= <i>entry name addr</i>	<i>entry name addr</i> : A-type address or register (2) - (12).
DE= <i>list entry addr</i>	<i>list entry addr</i> : A-type address, or register (2) - (12).
,DCB= <i>dcb addr</i>	<i>dcb addr</i> : A-type address, or register (2) - (12).
,LSEARCH=NO	Default: LSEARCH=NO
,LSEARCH=YES	

Parameters

The parameters are described under the syntax of the standard form of the XCTL macro.

XCTL and XCTLX - List form

Two parameter lists are used on XCTL or XCTLX: a control parameter list and an optional user parameter list. The list form uses only the control parameter list. The execute form builds a user parameter list and passes it to the target module.

Syntax

The list form of the XCTL or XCTLX macro is written as follows:

Syntax	Description
<i>name</i>	<i>name</i> : Symbol. Begin <i>name</i> in column 1.
␣	One or more blanks must precede XCTL or XCTLX.
XCTL XCTLX	
␣	One or more blanks must follow XCTL or XCTLX.
EP= <i>entry name</i> ,	<i>entry name</i> : Symbol.
EPLOC= <i>entry name addr</i> ,	<i>entry name addr</i> : A-type addresses.
DE= <i>list entry addr</i> ,	<i>list entry addr</i> : A-type address.
,DCB= <i>dcb addr</i> ,	<i>dcb addr</i> : A-type address.
,LSEARCH=NO,	Default: LSEARCH=NO
,LSEARCH=YES,	
,SF=L	

Parameters

The parameters are explained under the standard form of the XCTL macro, with the following exception:

,SF=L

Specifies the list form of the XCTL or XCTLX macro.

Note: If you code LSEARCH in either the list or execute form of the macro, you must code it in both.

XCTL - Execute form

Two parameter lists are available in the XCTL macro: a control parameter list and an optional user parameter list. The control parameter list can be either inline or remote (that is, in an area you specifically obtained); the user parameter list **must** be remote.

Syntax

The execute form of the XCTL macro is written as follows:

XCTL and XCTLX macros

Syntax	Description
<i>name</i>	<i>name</i> : Symbol. Begin <i>name</i> in column 1.
␣	One or more blanks must precede XCTL.
XCTL	
␣	One or more blanks must follow XCTL.
(<i>reg1</i>), (<i>reg1,reg2</i>),	<i>reg1</i> and <i>reg2</i> : Decimal digits or RX-type addresses, and in the order 2 through 12.
EP= <i>entry name</i> ,	<i>entry name</i> : Symbol.
EPLOC= <i>entry name addr</i> ,	<i>entry name addr</i> : RX-type address or register (2) - (12).
DE= <i>list entry addr</i> ,	<i>list entry addr</i> : RX-type address, or register (2) - (12).
,DCB= <i>dcb addr</i> ,	<i>dcb addr</i> : RX-type address, or register (2) - (12).
,PARAM=(<i>parm</i>),	<i>parm</i> : RX-type address, or register (2) - (12).
,PARAM=(<i>parm</i>),VL=1,	<i>parm</i> is one or more addresses, separated by commas. For example, PARAM=(<i>parm,parm,parm</i>)
,LSEARCH=NO,	Default: LSEARCH=NO
,LSEARCH=YES,	
,MF=(E, <i>user area</i>)	<i>user area</i> : RX-type address, or register (1) or (2) - (12).
,SF=(E, <i>ctrl area</i>)	<i>ctrl area</i> : RX-type address, or register (2) - (12) or (15).
,MF=(E, <i>user area</i>),SF=(E, <i>ctrl</i>	
<i>area</i>)	

Parameters

The parameters are explained under the standard form of the XCTL macro, with the following exceptions:

PARAM=(*parm*)

PARAM=(*parm*),VL=1

Specifies one or more parameters to be passed to the target module. XCTL builds the user parameter list consisting of a fullword address for each parameter in the order specified, placed at the location

designated by MF=(E,user area). When the target module gets control, register 1 contains the address of the location designated by user area.

Use VL=1 if you are passing the target module a variable number of parameters. VL=1 causes the high-order bit of the last address parameter to be set to 1; the target module can check the last bit to find the end of the list.

LSEARCH=NO**LSEARCH=YES**

Specifies whether (YES) or not (NO) you want the search limited to the job pack area and to the first library in the normal search sequence.

Note:

1. Do not use register 1 to pass parameters to the target module unless you use XCTL and omit both LSEARCH and PARAM.
2. If you code LSEARCH in either the list or execute form of the macro, you must code it in both.

,MF=(E,user area)**,SF=(E,ctrl area)****,MF=(E,user area),SF=(E,ctrl area)**

Specifies the execute form of the XCTL macro.

Use MF=(E,user area) to specify the address of data you want the target module to receive in register 1. If you specify PARAM, MF=(E,user area) is required and identifies the remote location where you want XCTL to build the parameter list.

Use SF=(E,ctrl area) to point to a remote control parameter list. If you do not specify SF, XCTL builds the control parameter list inline.

XCTLX - Execute form

Two parameter lists are available in the XCTLX macro: a control parameter list and an optional user parameter list. The control parameter list can be either inline or remote (that is, in an area you specifically obtained); the user parameter list must be remote.

Syntax

The execute form of the XCTLX macro is written as follows:

Syntax	Description
<i>name</i>	<i>name</i> : Symbol. Begin <i>name</i> in column 1.
␣	One or more blanks must precede XCTLX.
XCTLX	
␣	One or more blanks must follow XCTLX.
(<i>reg1</i>), (<i>reg1,reg2</i>),	<i>reg1</i> and <i>reg2</i> : Decimal digits or RX-type addresses, and in the order 2 through 12.

XCTL and XCTLX macros

Syntax	Description
EP= <i>entry name</i> ,	<i>entry name</i> : Symbol.
EPLOC= <i>entry name addr</i> ,	<i>entry name addr</i> : RX-type address or register (2) - (12).
DE= <i>list entry addr</i> ,	<i>list entry addr</i> : RX-type address, or register (2) - (12).
,DCB= <i>dcb addr</i> ,	<i>dcb addr</i> : RX-type address, or register (2) - (12).
,PARAM=(<i>parm</i>),	<i>parm</i> : RX-type address, or register (2) - (12).
,PARAM=(<i>parm</i>),VL=1,	<i>parm</i> is one or more addresses, separated by commas. For example, PARAM=(<i>parm,parm,parm</i>)
,LSEARCH=NO,	Default: LSEARCH=NO
,LSEARCH=YES,	
,PLIST4=YES	Default: None.
,PLIST4=NO	
,PLIST8=YES	Default: None.
,PLIST8=NO	
,PLISTARALETs=SYSTEM	Default: ,PLISTARALETs=SYSTEM
,PLISTARALETs=NO	Note: ,PLISTARALETs is valid only with XCTLX.
,PLIST8ARALETs=NO	Default: PLIST8ARALETs=NO
,PLIST8ARALETs=YES	Note: PLIST8ARALETs is valid only with XCTLX.
,MF=(E, <i>user area</i>)	<i>user area</i> : RX-type address, or register (1) or (2) - (12).
,SF=(E, <i>ctrl area</i>)	<i>ctrl area</i> : RX-type address, or register (2) - (12) or (15).
,MF=(E, <i>user area</i>),SF=(E, <i>ctrl area</i>)	

Parameters

The parameters are explained under the standard form of the XCTL macro, with the following exceptions:

PARAM=(parm)**PARAM=(parm),VL=1**

Specifies an address or addresses to be passed to the target module. XCTLX expands each address inline to a fullword boundary and builds a parameter list with the addresses in the order specified, placed at the location designated by MF=(E,user area). When the target module receives control, GPR1 contains the address of the location designated by 'user area'. When PARAM is not specified, XCTLX passes GPR1 and AR1 unchanged to the target module.

When an AR mode caller uses either:

- a parameter list with 4 bytes per entry without specifying PLISTARALETs=NO; or
- a parameter list with 8 bytes per entry and specifies PLIST8ARALETs=YES,

The addresses passed to the subtask are in the first part of the parameter list and their associated ALETs are in the second part. For a non-AR mode caller, or for an AR mode caller using a parameter list with 4 bytes per entry with PLISTARALETs=NO, or for an AR mode caller using a parameter list with 8 bytes per entry without PLIST8ARALETs=YES, ALETs are not passed in the parameter list. When ALETs are passed in the parameter list, the ALETs occupy consecutive 4-byte fields, whether the parameter list is 4 or 8 bytes per entry. See the description of the PLIST4 and PLIST8 keywords below for more information about controlling the bytes-per-entry in the parameter list. See the description of the PLISTARALETs and PLIST8ARALETs keyword below for more information about ALETs and 8-bytes-per-entry parameter lists. See [User parameters](#) for an example of passing a parameter list in AR mode.

When using a 4-bytes-per-entry parameter list, specify VL=1 when you pass a variable number of parameters. VL=1 results in setting the high-order bit of the last address to 1. The 1 in the high-order bit identifies the last address parameter (which is not the last word in the list when the ALETs are also saved). When using an 8-bytes-per-entry parameter list, VL=1 is not valid.

Note: If you specify only one address for PARAM= and you are not using register notation, you do not need to enter the parentheses.

LSEARCH=NO**LSEARCH=YES**

Specifies whether (YES) or not (NO) you want the search limited to the job pack area and to the first library in the normal search sequence.

Note: If you code LSEARCH in either the list or execute form of the macro, you must code it in both.

,PLIST4=YES**,PLIST4=NO****,PLIST8=YES****,PLIST8=NO**

Defines the size of the parameter list entries for a parameter list to be built by XCTLX based on the PARAM keyword.

PLIST4 and PLIST8 cannot be specified together. If neither is specified, the default is:

- If running AMODE 64, PLIST8=YES
- If not running AMODE 64, PLIST4=YES

If running AMODE 64 and PLIST4=YES is specified, the system builds a 4-bytes-per-entry parameter list just as it would if the program were running AMODE 24 or AMODE 31 and did not specify PLIST4 or PLIST8.

If running AMODE 24 or AMODE 31 and PLIST8 is specified, the system builds an 8-bytes-per-entry parameter list just as it would if the program were running AMODE 64 and did not specify PLIST4 or PLIST8.

,PLISTARAETS=SYSTEM

,PLISTARAETS=NO

If the invoker is in AR mode, indicates whether the parameter list is also to contain the ALETs associated with the addresses. If the invoker is not in AR mode, this parameter is ignored.

,PLISTARAETS=SYSTEM

Indicates to follow the default system rules that for an AR mode invoker:

- For AMODE 24/31, the parameter list is also to contain the ALETs.
- For AMODE 64 with PLIST8ARAETS=YES, the parameter list is also to contain the ALETs.
- For other cases, the parameter list is not to contain the ALETs.

,PLISTARAETS=NO

Indicates that the parameter list is not also to contain the ALETs. Do not specify this parameter with PLIST8ARAETS=YES.

,PLIST8ARAETS=NO

,PLIST8ARAETS=YES

If there is to be an 8-byte-per-entry parameter list and the invoker is in AR mode, indicates if the parameter list is also to contain the ALETs associated with the addresses. Otherwise, this parameter is ignored.

,PLIST8ARAETS=NO

Indicates that the 8-byte-per-entry parameter list is to consist of just the 8-byte addresses.

,PLIST8ARAETS=YES

Indicates that the 8-byte-per-entry parameter list is to consist of the following two parts:

- All the 8-byte addresses,
- All the associated ALETs in consecutive 4-byte fields.

,MF=(E,*user area*)

,SF=(E,*ctrl area*)

,MF=(E,*user area*),SF=(E,*ctrl area*)

Specifies the execute form of the XCTL macro.

Use MF=(E,*user area*) to specify the address of data you want the target module to receive in register 1. If you specify PARAM, MF=(E,*user area*) is required and identifies the remote location where you want XCTLX to build the parameter list.

Use SF=(E,*ctrl area*) to point to a remote control parameter list. If you do not specify SF, XCTLX builds the control parameter list inline.

Examples of passing data to the target module

These examples all perform the following function: pass control using the address of the entry name (XCTLEP), have registers 2 through 12 restored, and have the target module receive data in register 1. The control parameter list is inline.

Example 1

An XCTL issuer (not in AR mode) wants to pass a 6-byte token to the target module. The issuer puts the token into register 1 and issues the macro.

```
XCTL (2,12),EPLOC=XCTLEP
```

When the target module receives control, register 1 contains the token.

Example 2

An XCTL issuer (not in AR mode) wants to pass data that resides at the location ADDRDATA.

```
XCTL (2,12),EPLOC=XCTLEP,MF=(E,ADDRDATA)
```

When the target module receives control, register 1 contains the address of ADDRDATA.

Example 3

An XCTLX issuer (in primary or AR mode) wants to pass an address of a parameter list that was built by the CALL macro. The parameter list resides at the location PARM1. Additionally, the issuer wants to limit the search for the target module.

```
XCTLX (2,12),EPLOC=XCTLEP,LSEARCH=YES,MF=(E,PARM1)
```

When the target module receives control, register 1 contains the address of PARM1.

Example 4

An XCTLX issuer (in primary or AR mode) wants to pass a parameter list consisting of the addresses of three parameters. The issuer wants XCTLX to build a user parameter list at the address contained in register 3, and then pass this address to the target module. The three parameters are DATA1, DATA2, and DATA3.

```
XCTLX (2,12),EPLOC=XCTLEP,PARAM=(DATA1,DATA2,DATA3),MF=(E,(3))
```

When the target module receives control, register 1 contains the address of the user parameter list that contains the fullword addresses of DATA1, DATA2, and DATA3, in that order.

Appendix A. Accessibility

Accessible publications for this product are offered through [IBM Documentation \(www.ibm.com/docs/en/zos\)](http://www.ibm.com/docs/en/zos).

If you experience difficulty with the accessibility of any z/OS information, send a detailed message to the [Contact the z/OS team web page \(www.ibm.com/systems/campaignmail/z/zos/contact_z\)](http://www.ibm.com/systems/campaignmail/z/zos/contact_z) or use the following mailing address.

IBM Corporation
Attention: MHVRCFS Reader Comments
Department H6MA, Building 707
2455 South Road
Poughkeepsie, NY 12601-5400
United States

Accessibility features

Accessibility features help users who have physical disabilities such as restricted mobility or limited vision use software products successfully. The accessibility features in z/OS can help users do the following tasks:

- Run assistive technology such as screen readers and screen magnifier software.
- Operate specific or equivalent features by using the keyboard.
- Customize display attributes such as color, contrast, and font size.

Consult assistive technologies

Assistive technology products such as screen readers function with the user interfaces found in z/OS. Consult the product information for the specific assistive technology product that is used to access z/OS interfaces.

Keyboard navigation of the user interface

You can access z/OS user interfaces with TSO/E or ISPF. The following information describes how to use TSO/E and ISPF, including the use of keyboard shortcuts and function keys (PF keys). Each guide includes the default settings for the PF keys.

- *z/OS TSO/E Primer*
- *z/OS TSO/E User's Guide*
- *z/OS ISPF User's Guide Vol I*

Dotted decimal syntax diagrams

Syntax diagrams are provided in dotted decimal format for users who access IBM Documentation with a screen reader. In dotted decimal format, each syntax element is written on a separate line. If two or more syntax elements are always present together (or always absent together), they can appear on the same line because they are considered a single compound syntax element.

Each line starts with a dotted decimal number; for example, 3 or 3.1 or 3.1.1. To hear these numbers correctly, make sure that the screen reader is set to read out punctuation. All the syntax elements that have the same dotted decimal number (for example, all the syntax elements that have the number 3.1)

are mutually exclusive alternatives. If you hear the lines 3.1 USERID and 3.1 SYSTEMID, your syntax can include either USERID or SYSTEMID, but not both.

The dotted decimal numbering level denotes the level of nesting. For example, if a syntax element with dotted decimal number 3 is followed by a series of syntax elements with dotted decimal number 3.1, all the syntax elements numbered 3.1 are subordinate to the syntax element numbered 3.

Certain words and symbols are used next to the dotted decimal numbers to add information about the syntax elements. Occasionally, these words and symbols might occur at the beginning of the element itself. For ease of identification, if the word or symbol is a part of the syntax element, it is preceded by the backslash (\) character. The * symbol is placed next to a dotted decimal number to indicate that the syntax element repeats. For example, syntax element *FILE with dotted decimal number 3 is given the format 3 * FILE. Format 3* FILE indicates that syntax element FILE repeats. Format 3* * FILE indicates that syntax element * FILE repeats.

Characters such as commas, which are used to separate a string of syntax elements, are shown in the syntax just before the items they separate. These characters can appear on the same line as each item, or on a separate line with the same dotted decimal number as the relevant items. The line can also show another symbol to provide information about the syntax elements. For example, the lines 5.1*, 5.1 LASTRUN, and 5.1 DELETE mean that if you use more than one of the LASTRUN and DELETE syntax elements, the elements must be separated by a comma. If no separator is given, assume that you use a blank to separate each syntax element.

If a syntax element is preceded by the % symbol, it indicates a reference that is defined elsewhere. The string that follows the % symbol is the name of a syntax fragment rather than a literal. For example, the line 2.1 %OP1 means that you must refer to separate syntax fragment OP1.

The following symbols are used next to the dotted decimal numbers.

? indicates an optional syntax element

The question mark (?) symbol indicates an optional syntax element. A dotted decimal number followed by the question mark symbol (?) indicates that all the syntax elements with a corresponding dotted decimal number, and any subordinate syntax elements, are optional. If there is only one syntax element with a dotted decimal number, the ? symbol is displayed on the same line as the syntax element, (for example 5? NOTIFY). If there is more than one syntax element with a dotted decimal number, the ? symbol is displayed on a line by itself, followed by the syntax elements that are optional. For example, if you hear the lines 5 ?, 5 NOTIFY, and 5 UPDATE, you know that the syntax elements NOTIFY and UPDATE are optional. That is, you can choose one or none of them. The ? symbol is equivalent to a bypass line in a railroad diagram.

! indicates a default syntax element

The exclamation mark (!) symbol indicates a default syntax element. A dotted decimal number followed by the ! symbol and a syntax element indicate that the syntax element is the default option for all syntax elements that share the same dotted decimal number. Only one of the syntax elements that share the dotted decimal number can specify the ! symbol. For example, if you hear the lines 2? FILE, 2.1! (KEEP), and 2.1 (DELETE), you know that (KEEP) is the default option for the FILE keyword. In the example, if you include the FILE keyword, but do not specify an option, the default option KEEP is applied. A default option also applies to the next higher dotted decimal number. In this example, if the FILE keyword is omitted, the default FILE(KEEP) is used. However, if you hear the lines 2? FILE, 2.1, 2.1.1! (KEEP), and 2.1.1 (DELETE), the default option KEEP applies only to the next higher dotted decimal number, 2.1 (which does not have an associated keyword), and does not apply to 2? FILE. Nothing is used if the keyword FILE is omitted.

*** indicates an optional syntax element that is repeatable**

The asterisk or glyph (*) symbol indicates a syntax element that can be repeated zero or more times. A dotted decimal number followed by the * symbol indicates that this syntax element can be used zero or more times; that is, it is optional and can be repeated. For example, if you hear the line 5.1* data area, you know that you can include one data area, more than one data area, or no data area. If you hear the lines 3* , 3 HOST, 3 STATE, you know that you can include HOST, STATE, both together, or nothing.

Notes:

1. If a dotted decimal number has an asterisk (*) next to it and there is only one item with that dotted decimal number, you can repeat that same item more than once.
2. If a dotted decimal number has an asterisk next to it and several items have that dotted decimal number, you can use more than one item from the list, but you cannot use the items more than once each. In the previous example, you can write HOST STATE, but you cannot write HOST HOST.
3. The * symbol is equivalent to a loopback line in a railroad syntax diagram.

+ indicates a syntax element that must be included

The plus (+) symbol indicates a syntax element that must be included at least once. A dotted decimal number followed by the + symbol indicates that the syntax element must be included one or more times. That is, it must be included at least once and can be repeated. For example, if you hear the line 6.1+ data area, you must include at least one data area. If you hear the lines 2+, 2 HOST, and 2 STATE, you know that you must include HOST, STATE, or both. Similar to the * symbol, the + symbol can repeat a particular item if it is the only item with that dotted decimal number. The + symbol, like the * symbol, is equivalent to a loopback line in a railroad syntax diagram.

Notices

This information was developed for products and services that are offered in the USA or elsewhere.

IBM may not offer the products, services, or features discussed in this document in other countries. Consult your local IBM representative for information on the products and services currently available in your area. Any reference to an IBM product, program, or service is not intended to state or imply that only that IBM product, program, or service may be used. Any functionally equivalent product, program, or service that does not infringe any IBM intellectual property right may be used instead. However, it is the user's responsibility to evaluate and verify the operation of any non-IBM product, program, or service.

IBM may have patents or pending patent applications covering subject matter described in this document. The furnishing of this document does not grant you any license to these patents. You can send license inquiries, in writing, to:

*IBM Director of Licensing
IBM Corporation
North Castle Drive, MD-NC119
Armonk, NY 10504-1785
United States of America*

For license inquiries regarding double-byte character set (DBCS) information, contact the IBM Intellectual Property Department in your country or send inquiries, in writing, to:

*Intellectual Property Licensing
Legal and Intellectual Property Law
IBM Japan Ltd.
19-21, Nihonbashi-Hakozakicho, Chuo-ku
Tokyo 103-8510, Japan*

The following paragraph does not apply to the United Kingdom or any other country where such provisions are inconsistent with local law: INTERNATIONAL BUSINESS MACHINES CORPORATION PROVIDES THIS PUBLICATION "AS IS" WITHOUT WARRANTY OF ANY KIND, EITHER EXPRESS OR IMPLIED, INCLUDING, BUT NOT LIMITED TO, THE IMPLIED WARRANTIES OF NON-INFRINGEMENT, MERCHANTABILITY OR FITNESS FOR A PARTICULAR PURPOSE. Some states do not allow disclaimer of express or implied warranties in certain transactions, therefore, this statement may not apply to you.

This information could include technical inaccuracies or typographical errors. Changes are periodically made to the information herein; these changes will be incorporated in new editions of the publication. IBM may make improvements and/or changes in the product(s) and/or the program(s) described in this publication at any time without notice.

This information could include missing, incorrect, or broken hyperlinks. Hyperlinks are maintained in only the HTML plug-in output for IBM Documentation. Use of hyperlinks in other output formats of this information is at your own risk.

Any references in this information to non-IBM websites are provided for convenience only and do not in any manner serve as an endorsement of those websites. The materials at those websites are not part of the materials for this IBM product and use of those websites is at your own risk.

IBM may use or distribute any of the information you supply in any way it believes appropriate without incurring any obligation to you.

Licensees of this program who wish to have information about it for the purpose of enabling: (i) the exchange of information between independently created programs and other programs (including this one) and (ii) the mutual use of the information which has been exchanged, should contact:

*IBM Corporation
Site Counsel
2455 South Road*

Poughkeepsie, NY 12601-5400
USA

Such information may be available, subject to appropriate terms and conditions, including in some cases, payment of a fee.

The licensed program described in this document and all licensed material available for it are provided by IBM under terms of the IBM Customer Agreement, IBM International Program License Agreement or any equivalent agreement between us.

Any performance data contained herein was determined in a controlled environment. Therefore, the results obtained in other operating environments may vary significantly. Some measurements may have been made on development-level systems and there is no guarantee that these measurements will be the same on generally available systems. Furthermore, some measurements may have been estimated through extrapolation. Actual results may vary. Users of this document should verify the applicable data for their specific environment.

Information concerning non-IBM products was obtained from the suppliers of those products, their published announcements or other publicly available sources. IBM has not tested those products and cannot confirm the accuracy of performance, compatibility or any other claims related to non-IBM products. Questions on the capabilities of non-IBM products should be addressed to the suppliers of those products.

All statements regarding IBM's future direction or intent are subject to change or withdrawal without notice, and represent goals and objectives only.

This information contains examples of data and reports used in daily business operations. To illustrate them as completely as possible, the examples include the names of individuals, companies, brands, and products. All of these names are fictitious and any similarity to the names and addresses used by an actual business enterprise is entirely coincidental.

COPYRIGHT LICENSE:

This information contains sample application programs in source language, which illustrate programming techniques on various operating platforms. You may copy, modify, and distribute these sample programs in any form without payment to IBM, for the purposes of developing, using, marketing or distributing application programs conforming to the application programming interface for the operating platform for which the sample programs are written. These examples have not been thoroughly tested under all conditions. IBM, therefore, cannot guarantee or imply reliability, serviceability, or function of these programs. The sample programs are provided "AS IS", without warranty of any kind. IBM shall not be liable for any damages arising out of your use of the sample programs.

Terms and conditions for product documentation

Permissions for the use of these publications are granted subject to the following terms and conditions.

Applicability

These terms and conditions are in addition to any terms of use for the IBM website.

Personal use

You may reproduce these publications for your personal, noncommercial use provided that all proprietary notices are preserved. You may not distribute, display or make derivative work of these publications, or any portion thereof, without the express consent of IBM.

Commercial use

You may reproduce, distribute and display these publications solely within your enterprise provided that all proprietary notices are preserved. You may not make derivative works of these publications, or

reproduce, distribute or display these publications or any portion thereof outside your enterprise, without the express consent of IBM.

Rights

Except as expressly granted in this permission, no other permissions, licenses or rights are granted, either express or implied, to the publications or any information, data, software or other intellectual property contained therein.

IBM reserves the right to withdraw the permissions granted herein whenever, in its discretion, the use of the publications is detrimental to its interest or, as determined by IBM, the above instructions are not being properly followed.

You may not download, export or re-export this information except in full compliance with all applicable laws and regulations, including all United States export laws and regulations.

IBM MAKES NO GUARANTEE ABOUT THE CONTENT OF THESE PUBLICATIONS. THE PUBLICATIONS ARE PROVIDED "AS-IS" AND WITHOUT WARRANTY OF ANY KIND, EITHER EXPRESSED OR IMPLIED, INCLUDING BUT NOT LIMITED TO IMPLIED WARRANTIES OF MERCHANTABILITY, NON-INFRINGEMENT, AND FITNESS FOR A PARTICULAR PURPOSE.

IBM Online Privacy Statement

IBM Software products, including software as a service solutions, ("Software Offerings") may use cookies or other technologies to collect product usage information, to help improve the end user experience, to tailor interactions with the end user, or for other purposes. In many cases no personally identifiable information is collected by the Software Offerings. Some of our Software Offerings can help enable you to collect personally identifiable information. If this Software Offering uses cookies to collect personally identifiable information, specific information about this offering's use of cookies is set forth below.

Depending upon the configurations deployed, this Software Offering may use session cookies that collect each user's name, email address, phone number, or other personally identifiable information for purposes of enhanced user usability and single sign-on configuration. These cookies can be disabled, but disabling them will also eliminate the functionality they enable.

If the configurations deployed for this Software Offering provide you as customer the ability to collect personally identifiable information from end users via cookies and other technologies, you should seek your own legal advice about any laws applicable to such data collection, including any requirements for notice and consent.

For more information about the use of various technologies, including cookies, for these purposes, see IBM's Privacy Policy at ibm.com/privacy and IBM's Online Privacy Statement at ibm.com/privacy/details in the section entitled "Cookies, Web Beacons and Other Technologies," and the "IBM Software Products and Software-as-a-Service Privacy Statement" at ibm.com/software/info/product-privacy.

Policy for unsupported hardware

Various z/OS elements, such as DFSMSdfp, JES2, JES3, and MVS, contain code that supports specific hardware servers or devices. In some cases, this device-related element support remains in the product even after the hardware devices pass their announced End of Service date. z/OS may continue to service element code; however, it will not provide service related to unsupported hardware devices. Software problems related to these devices will not be accepted for service, and current service activity will cease if a problem is determined to be associated with out-of-support devices. In such cases, fixes will not be issued.

Minimum supported hardware

The minimum supported hardware for z/OS releases identified in z/OS announcements can subsequently change when service for particular servers or devices is withdrawn. Likewise, the levels of other software products supported on a particular release of z/OS are subject to the service support lifecycle of those

products. Therefore, z/OS and its product publications (for example, panels, samples, messages, and product documentation) can include references to hardware and software that is no longer supported.

- For information about software support lifecycle, see: [IBM Lifecycle Support for z/OS \(www.ibm.com/software/support/systemsz/lifecycle\)](http://www.ibm.com/software/support/systemsz/lifecycle)
- For information about currently-supported IBM hardware, contact your IBM representative.

Programming interface information

This information is intended to help the customer to code macros that are available to all assembler language programs. This information documents intended programming interfaces that allow the customer to write programs to obtain services of z/OS.

Trademarks

IBM, the IBM logo, and ibm.com are trademarks or registered trademarks of International Business Machines Corp., registered in many jurisdictions worldwide. Other product and service names might be trademarks of IBM or other companies. A current list of IBM trademarks is available on the Web at [Copyright and Trademark information \(www.ibm.com/legal/copytrade.shtml\)](http://www.ibm.com/legal/copytrade.shtml).

UNIX is a registered trademark of The Open Group in the United States and other countries.

Index

Numerics

- 31-bit addressing mode
 - macros requiring expansion
 - STIMER macro [915](#)
 - SYNCH [979](#)
 - WTOR macro [1149](#)
 - XCTL macro [1163](#)

A

- accessibility
 - contact IBM [1175](#)
 - features [1175](#)
- action message [1141](#), [1153](#)
- addressing mode and the services [2](#)
- ALET qualification
 - of parameters [3](#)
- AMODE (addressing mode)
 - changing
 - using the LINK macro [783](#)
- AR () mode
 - description [3](#)
- ASC (address space control) mode
 - defining [3](#)
- assistive technologies [1175](#)

B

- branch macro
 - converting to relative branch [123](#), [125](#)

C

- callable service
 - coding [14](#)
- central storage
 - loading virtual storage [807](#)
- coding the callable services [14](#)
- coding the macros [11](#)
- completion of an event
 - signalling [825](#)
- contact
 - z/OS [1175](#)
- continuation line [13](#)
- control
 - passing to another load module [783](#)

D

- data sharing with IARVSERV macro [57](#)
- device measurement block index
 - obtaining [423](#)

E

- ECB (event control block)
 - setting [825](#)
- ETR (external time reference)
 - checking for TOD clock synchronization with [911](#)
- event
 - signalling completion [825](#)

F

- feedback [xlvi](#)

I

- I/O configuration token
 - obtaining [423](#)
- IARCP64 macro [23](#)
- IARR2V macro [37](#)
- IARST64 macro [43](#)
- IARV64 macro
 - REQUEST=CHANGEATTRIBUTE [82](#)
- IARVSERV macro
 - data sharing [57](#)
- IDENTIFY macro [113](#)
- IEA4APE callable service [285](#)
- IEA4APE2 callable service [289](#)
- IEA4DPE callable service [295](#)
- IEA4DPE2 callable service [299](#)
- IEA4PME2 callable service [303](#)
- IEA4PSE callable service [311](#)
- IEA4PSE2 callable service [317](#)
- IEA4RLS callable service [323](#)
- IEA4RLS2 callable service [327](#)
- IEA4RPI callable service [333](#)
- IEA4RPI2 callable service [339](#)
- IEA4TPE callable service [345](#)
- IEA4XFR callable service [349](#)
- IEA4XFR2 callable service [355](#)
- IEAARR macro [117](#)
- IEABRC macro [123](#)
- IEABRCX macro [125](#)
- IEAFP macro [129](#)
- IEAINTKN macro [143](#)
- IEALSQRY macro [147](#)
- IEAMETR macro [151](#)
- IEAN4CR callable service [171](#)
- IEAN4DL macro [177](#)
- IEAN4RT callable service [181](#)
- IEANTCR callable service [155](#)
- IEANTDL macro [161](#)
- IEANTRT callable service [165](#)
- IEATXDC macro [203](#)
- IEAVAPE callable service [207](#)
- IEAVAPE2 callable service [211](#)
- IEAVDPE callable service [219](#)
- IEAVDPE2 callable service [223](#)

IEAVPME2 callable service [227](#)
IEAVPSE callable service [235](#)
IEAVPSE2 callable service [241](#)
IEAVRLS callable service [247](#)
IEAVRLS2 callable service [251](#)
IEAVRPI callable service [257](#)
IEAVRPI2 callable service [263](#)
IEAVTPE callable service [269](#)
IEAVXFR callable service [273](#)
IEAVXFR2 callable service [279](#)
IEFDDSRV macro [361](#)
IEFOPZQ macro [375](#)
IEFPRMLB macro [387](#)
IEFSSI macro [415](#)
incident token
 building [143](#)
IOCINFO macro [423](#)
IOS (input/output supervisor)
 building control unit entry [439](#)
 obtaining information [431](#)
IOSCHPD macro [431](#)
IOSCUMOD macro [439](#)
ITTUINIT service [509](#)
ITTUTERM service [513](#)
ITTUWRIT service [517](#)
ITZEVENT macro [521](#)
ITZQUERY macro [531](#)
IXGBRWSE macro [537](#)
IXGCONN macro [583](#)
IXGDELET macro [607](#)
IXGIMPRT macro [623](#)
IXGINVNT macro [637](#)
IXGOFFLD macro [741](#)
IXGQUERY macro [753](#)
IXGUPDAT macro [763](#)
IXGWRITE macro [765](#)

K

keyboard
 navigation [1175](#)
 PF keys [1175](#)
 shortcut keys [1175](#)

L

LINK and LINKX macros [783](#)
linkage stack
 query macro [147](#)
LOAD macro [795](#)
load module
 adding an entry name [113](#)
 bringing into virtual storage [795](#)
 passing control [783](#)
Logrec Data Set
 symptom record entries from SYMREC macro [971](#)
LSEXPAND macro [803](#)

M

macro
 coding [11](#)
 forms [10](#)

macro (*continued*)
 level
 selecting [1](#)
 sample [12](#)
 selecting level [1](#)
 user parameter, passing [4](#)
 X-macros
 using [9](#)
multiple timer
 setting [921](#)

N

navigation
 keyboard [1175](#)

P

paging service
 PGLOAD macro [807](#)
 PGOUT macro [811](#)
 PGRLSE macro [815](#)
 PGSER macro [819](#)
PGLOAD macro [807](#)
PGOUT macro [811](#)
PGRLSE macro [815](#)
PGSER macro [819](#)
POST macro [825](#)
process symptom record [971](#)
program object
 bringing into virtual storage [795](#)

Q

QRYLANG macro [829](#)

R

REFPAT macro [835](#)
RESERVE macro [843](#)
RETURN macro [853](#)

S

SAVE macro [855](#)
sending to IBM
 reader comments [xlvii](#)
service
 ALET qualification [3](#)
 summary [15](#)
services
 addressing mode [2](#)
 ASC mode
 defining [3](#)
 using [1](#)
 SETRP macro [857](#)
shared DASD
 reserve a device [843](#)
sharing storage with IARVSERV macro [57](#)
shortcut keys [1175](#)
SNAP and SNAPX macros [865](#)
specify program interruption exit [881](#)
SPIE macro [881](#)

SPLEVEL macro [887](#)
STAE macro [891](#)
STATUS macro [897](#)
STCKCONV macro [903](#)
STCKSYNC macro [911](#)
STIMER macro [915](#)
STIMERM macro [921](#)
STORAGE macro [935](#)
subtask
 changing status [897](#)
summary of changes
 z/OS MVS Programming: Assembler Services Reference
 IAR-XCT [xlix](#), [li](#)
symptom record [971](#)
SYMRBLD macro [953](#)
SYMREC macro [971](#)
SYNCH and SYNCHX macros [979](#)
synchronous exit [982](#)
SYSEVENT macro [987](#)
SYSSTATE macro [989](#)

T

TCBTOKEN macro [995](#)
TESTART macro [1001](#)
time interval
 testing [921](#)
TIME macro [1005](#)
timer
 setting a multiple [921](#)
TIMEUSED macro [1017](#)
TOD (time-of-day) clock
 checking for synchronization with ETR [911](#)
 converting value [903](#)
 obtaining contents [911](#), [1005](#)
TRANMSG macro [1023](#)
TTIMER macro [1037](#)

U

UCB (unit control block)
 scanning [1093](#)
UCBDEVN macro [1041](#)
UCBINFO macro [1045](#)
UCBSCAN macro [1093](#)
UPDTMPB macro [1107](#)
user interface
 ISPF [1175](#)
 TSO/E [1175](#)
user parameter
 passing [4](#)

V

virtual storage
 bringing in a load module [795](#)
 bringing in a program object [795](#)
 loading [807](#), [819](#)
 page-ahead function [807](#)
 paging out [811](#), [819](#)
 planning for future needs [807](#)
 releasing contents [815](#), [819](#)
Virtual storage

Virtual storage (*continued*)
 sharing with IARVSRV macro [57](#)
VRA (variable recording area)
 updating data [1113](#)
VRADATA macro [1113](#)

W

WAIT macro [1119](#)
WTL macro [1125](#)
WTO macro [1133](#)
WTOR macro [1149](#)

X

X-macros
 using [9](#)
XCTL and XCTLX macros [1163](#)

Z

z/OS MVS Programming: Assembler Services Reference
 IAR-XCT
 summary of changes [xlix](#), [li](#)



Product Number: 5650-ZOS

SA23-1370-40

