

z/OS



MVS System Commands

Version 2 Release 2

Note

Before using this information and the product it supports, read the information in "Notices" on page 987.

This edition applies to Version 2 Release 2 of z/OS (5650-ZOS) and to all subsequent releases and modifications until otherwise indicated in new editions.

© **Copyright IBM Corporation 1988, 2016.**

US Government Users Restricted Rights – Use, duplication or disclosure restricted by GSA ADP Schedule Contract with IBM Corp.

Contents

Figures xi

Tables xiii

About this document xv

Who should use this information xv

How to use this document xv

z/OS information xv

How to send your comments to IBM xvii

If you have a technical problem xvii

Summary of changes xix

Summary of changes for Version 2 Release 2 (V2R2), as updated December 2016 xix

Summary of changes for Version 2 Release 2 (V2R2), as updated June 2016 xix

Summary of changes for Version 2 Release 2 (V2R2), as updated March 2016 xix

Summary of changes for Version 2 Release 2 (V2R2), as updated December 2015 xix

Summary of changes in z/OS Version 2 Release 2 (V2R2) xx

Summary of changes for z/OS Version 2 Release 1 (V2R1), as updated February 2015 xxii

Summary of changes for z/OS Version 2 Release 1 (V2R1), as updated March 2014 xxiii

z/OS Version 2 Release 1 summary of changes xxiv

Chapter 1. System operations 1

Starting, loading, and initializing the system. 2

Starting the system 2

Preparing the system hardware 3

Loading the system software 3

Initializing the system software 7

Logging on to the system 9

Starting and specifying parameters for the job entry subsystem 10

Controlling the system. 10

Displaying current system status 11

Displaying the status of devices and availability of paths 11

Sending commands to systems in a sysplex. 12

Using commands that have sysplex scope 12

Sharing system commands 15

Setting the time and changing the system parameters 20

Using the system restart function 20

Responding to IEA502A 20

Responding to BLW004A 21

Activating a workload management service policy 21

Controlling time-sharing 22

Controlling jobs 22

Starting a job 23

Stopping a job 23

Cancelling a job 23

Passing information to a job 23

Restarting a job 23

Deferred restart 24

Controlling started tasks 25

Controlling system information recording 25

System management facilities 26

System trace 27

The generalized trace facility 27

Master trace 27

Component trace 27

Logrec recording medium 27

Controlling automatic tape switching. 28

Defining automatically switchable devices 28

Displaying information about automatically switchable devices 29

Interacting with system functions 29

Device allocation 30

Hot I/O detection 32

Device boxing 32

Command flooding. 36

Class M1 commands 36

Class M2 commands 37

Class M3 commands 39

Class C1 commands 39

Class C2 commands 39

Class C3 commands 39

Inline commands 39

Setting up hardware event data collection 40

Accessing the output from a hardware event data collection run. 43

Interpreting the z/OS UNIX system services output files 45

HISSERV service overview 53

Bypassing HIS to exploit the CPU Measurement Facility 54

Responding to failing devices 54

Quiescing the system 55

Stopping the system 55

Recovery from hardware problems 55

Hardware problems 56

Information provided with machine checks. 56

CPU errors 57

Service processor damage 60

Storage errors 60

Channel subsystem errors 62

I/O device errors 66

Diagnosing problems in a switched fabric 75

Additional recovery actions 90

Chapter 2. System Reconfiguration 91

Dynamic I/O configuration 91

Logical and physical reconfiguration 92

Reconfiguration support according to processor types	92
Uniprocessor (UP)	92
Multiprocessor (MP)	92
Reconfiguring a central processor	93
Actions to reconfigure a central processor offline	93
Reconfiguring a central processor with an ICRF	93
Actions to bring online a central processor and its ICRF	94
Removing the last ICRF	94
Actions to take offline a central processor and its ICRF	94
Reconfiguring central storage	94
Physical view of central storage	95
Specifying the RSU parameter	95
Reconfiguring channel paths.	98
Actions to reconfigure channel paths	99
Reconfiguring I/O devices	99
Reconfiguring a coupling facility	100

Chapter 3. z/OS operator console operations. 101

Console characteristics and operations	101
General characteristics of display consoles.	101
Operations on display consoles in full-capability mode	106
Handling consoles in error conditions	115
Placing a console in offline status.	119
Interchanging your consoles on a control unit	119
Defining and changing console characteristics	120
Using operator commands to change CONSOLxx statements	120
Changing console characteristics	124
Controlling system messages and commands	139
Defining program function keys (PFKs)	145
Processing hardcopy	148

Chapter 4. MVS system commands reference 153

Command syntax notation	167
How to read syntax conventions	167
System command formats	168
Typical format	168
A second format	169
ACTIVATE command	170
Restrictions	170
Syntax.	170
Parameters	170
CANCEL command	174
Syntax.	175
Parameters	175
CHNGDUMP command.	179
Dump options and modes	179
Changing the dump mode and options.	180
Scope in a sysplex.	180
Syntax.	180
Removing options from or resetting the system dump options lists	180
Parameters	181

Options for SDUMP, SYSABEND, SYSUDUMP, and SYSMDUMP	183
Resetting dump mode to add and the dump options to initial values	188
Example: how CHNGDUMP commands affect dump modes and options	188
Setting the dump modes and options	190
CMDS command	200
Syntax.	200
Parameters	200
CONFIG command	202
Syntax.	203
Reconfiguring the system directly	203
Reconfiguring the system with a CONFIGxx parmlib member	215
Reconfiguring the system in response to a configuration display.	216
CONTROL command.	217
Scope in a sysplex.	218
Syntax.	218
Changing out of line display area specifications	219
Deleting retained action messages	219
Halting the printing or the display of a status display	221
Controlling displays in areas	221
Removing information from the screen.	222
Activating, deactivating, or displaying the status of the action message retention facility	224
Changing or displaying the number of allowed WTL SYSLOG buffers	224
Changing or displaying the number of allowed WTO and WTOR message buffers	225
Changing the time the system waits for ROUTE command responses	226
Increasing the maximum number of reply IDs	227
Changing or displaying the status of WTO installation exit IEAVMXIT	227
Displaying the SMCS APPLID of the current system and VTAM generic resource name for SMCS	228
Setting the APPLID of the system	229
Setting or turning off the VTAM generic resource name for SMCS	229
Changing a PFK definition	230
Deleting message queues	232
Changing or displaying message deletion and format specifications	233
Changing the operating mode of a console	237
Selecting the message levels for a console	238
DEVSERV command	239
Using the DEVSERV QDASD option	240
Using the DEVSERV QTAPE option	241
Using the DEVSERV QPAVS option	241
Using the DEVSERV QLIB option	241
Syntax.	242
Parameters	242
DISPLAY command	261
Scope in a sysplex.	263
Syntax.	265
Displaying MVS device allocation group locks information	265

Displaying MVS device allocation settings information	266	Displaying message flood automation information	376
Displaying MVS device allocation IGDE information	267	Displaying MVS message service status and languages	378
Displaying APPC/MVS information	267	Displaying message suppression, retention, color, intensity, and highlighting options	378
Displaying ASCH configuration information	273	Displaying status of z/OS UNIX System Services	380
Displaying auxiliary storage information	275	Displaying operator information (OPDATA)	401
Displaying auto-reply policy and WTORS information	277	Displaying PCIE information	402
Displaying the current system level language environment run-time options	278	Displaying PARMLIB information	403
Displaying CONTROL command functions	280	Displaying commands defined for PFKs	406
Displaying attached coupling facility information	280	Displaying PPTs	407
Displaying console group definitions	281	Displaying registered products	409
Displaying console status information	282	Displaying entries in the list of APF-authorized libraries	411
Displaying DIAG parmlib information	287	Displaying PROG defaults	412
Displaying data lookaside facility information	287	Displaying dynamic exits	412
Displaying dump options or dump data set status	290	Displaying LNKLST information	415
Displaying extended MCS information	293	Displaying LPA information	416
Displaying the timer synchronization mode and ETR ports	298	Displaying the status of the REFRPROT option	417
Displaying global resource serialization information	299	Displaying the status of the TRACKDIRLOAD option	417
Displaying Generic Tracker information	314	Displaying system requests	418
Displaying hardware event data collection status	322	Displaying resource recovery services (RRS) information	424
Displaying Basic HyperSwap information	325	Displaying SLIP trap information	427
Displaying ICSF information	326	Displaying SMF data	428
Displaying the data set optimization configuration	326	Displaying the in-storage copy of the SMF limits	429
Displaying TSO/E parmlib information	330	Displaying storage management subsystem information	432
Displaying I/O configuration information	331	Displaying information about all subsystems	452
Displaying captured UCB information	332	Displaying static system symbols	454
Displaying IOS control unit group information	332	Displaying the local and coordinated universal time and date	455
Displaying dynamic channel path management information	334	Displaying component or transaction trace status	456
Displaying encryption key manager (EKM) status	334	Displaying device status and allocation	460
Displaying zHPF facility status	335	Displaying Unicode services	463
Displaying FICON switch data information	336	Displaying virtual storage information	465
Displaying IOS group information	336	Displaying workload manager information	467
Displaying IOS HYPERPAV information	336	Displaying cross system coupling facility (XCF) information	473
Displaying the IBM zHyperWrite data replication status	337	DUMP command	487
Displaying MIDAW facility status	337	Wildcards	487
Displaying MIH and I/O timing limits	337	Syntax	488
Displaying IOS recovery options	341	Parameters	488
Displaying IOS storage residency information	341	Specifying dump options	489
Displaying the devices stopped by the IOACTION command	342	DUMPDS command	507
Displaying IPL information	342	Syntax	508
Displaying PCIE-related parameters	344	Adding system dump resources	509
Displaying system activity	344	Enabling and disabling automatic dump data set allocation	512
Displaying started task status	353	Making dump data sets ready to receive dumps	513
Displaying library lookaside information	355	Deleting system dump resources	513
Displaying the system logger and its log streams	356	Setting the name-pattern for dump data sets	516
Displaying the logrec recording medium	367	FORCE command	517
Displaying system configuration information	368	Considerations	517
		Syntax	518
		Parameters	518
		HALT command	521

Syntax	521	Dynamically activating maintenance for z/OS UNIX System Services (z/OS UNIX)	576
IOACTION command	522	Stopping a physical file system (PFS) through a logical file system (LFS) interface	577
Syntax	522	Passing a MODIFY command string to a physical file system (PFS) through a logical file system (LFS)	577
Parameters	522	Replacing the sysplex root file system in the shared file system configuration (z/OS UNIX)	578
LIBRARY command	523	Stopping a temporary file system (TFS)	579
LOG command	524	Changing the virtual lookaside facility (VLF) parameters	579
Syntax	524	Enabling and disabling the Application Response Measurement (ARM) services	580
Parameters	524	Starting, stopping and modifying options for the guest platform management provider	581
LOGOFF command	524	Changing workload manager resource states	582
Syntax	524	Specifying data set selection criteria for an external writer	583
Parameters	524	Causing an external writer to pause	585
LOGON command	525	MODIFY (F) JES3 commands	586
Syntax	526	MONITOR command	587
Parameters	526	Scope in a sysplex	587
MODE command	527	Syntax	588
Syntax	527	Parameters	588
Controlling the recording of hard machine check interruptions	529	MOUNT command	589
Controlling the recording of system recovery and degradation machine check interruptions	531	Scope in a sysplex	589
Displaying recording and monitoring status	532	Syntax	589
MODIFY command	532	Parameters	589
Summary of MODIFY	533	Tape library dataserver considerations	590
Using asterisks in MODIFY commands	534	Tape multi-volume considerations	591
MODIFY command syntax	536	PAGEADD command	591
Syntax	536	Syntax	592
Parameters	536	Parameters	592
Passing information to a z/OS UNIX System Services application	538	PAGEDEL command	593
Controlling the CIM server	538	Syntax	594
Modifying TSO/VTAM time sharing	539	Parameters	594
Communicating with System REXX	540	QUIESCE command	595
Controlling z/OS UNIX System Services (z/OS UNIX)	543	Syntax	595
Communicating with the catalog address space	549	REPLY command	596
Processing the common event adapter (CEA) parameters	550	Using system symbols in REPLY commands	596
Refreshing the common event adapter (CEA) component information	550	Scope in a sysplex	597
Displaying the common event adapter (CEA) component TSO/E address space information	551	Syntax	597
Managing common event adapter (CEA) REXX exec tracing	551	Replying to system information requests	597
Displaying the common event adapter (CEA) environment	552	Replying to system requests during recovery processing	598
Disconnecting the common event adapter (CEA) from the IPCS sysplex dump directory data set	554	Replying to system security WTORs	598
Adjusting the common event adapter (CEA) mode of operation	554	Setting the time-of-day clock	598
Communicating with the device manager address space	555	Specifying component trace options	600
Changing the DLF processing mode	559	Specifying dump options	600
Changing the DLF parameters	560	Specifying SMF options	601
Displaying DLF status	560	Specifying system parameters	602
Starting, configuring, and stopping hardware event data collection	561	RESET command	603
Building and replacing library lookaside directories	573	Scope in a sysplex	603
Operating with the network file system server	574	Syntax	603
Managing the object access method (OAM)	574	Forcing a hung console offline or freeing console resources	603
Recycling z/OS UNIX System Services (z/OS UNIX)	575	Changing service classes or quiescing work	604
		ROUTE command	606
		Restrictions	607

How MVS displays aggregated response from ROUTE	608	SETLOGR command	687
Using system symbols in ROUTE commands	609	Scope in a Sysplex.	687
Syntax.	610	Syntax.	688
Parameters	610	SETLOGR CTRACE command	688
SEND command	614	SETLOGR FORCE command	689
Scope in a sysplex.	614	SETLOGR MANAGE command	695
Syntax.	615	SETLOGR MONITOR command	697
Communicating with other operators	615	SETLOGR ZAI command	700
Communicating with specified users	616	SETLOGRC command	703
Communicating with all logged-on terminal users	617	Syntax.	704
Saving messages in the broadcast data set	618	Parameters	704
Listing the notices section of the broadcast data set	619	SETMF command	705
Deleting a message from the broadcast data set (notices section)	620	Syntax.	705
SET command	620	Parameters	706
Scope in a sysplex.	622	SETOMVS command	707
Syntax.	623	Syntax.	708
Parameters	624	Parameters	709
SETALLOC command	634	SETPROG command	720
Syntax.	635	Syntax.	721
Parameters	636	Updating the APF list	721
SETAPPC command	648	Updating dynamic exits	723
Syntax.	648	Updating LNKLST concatenations	728
Parameters	648	Managing dynamic LPA content	732
SETAUTOR command	654	Protecting REFR programs	736
Syntax.	654	Tracking directed load modules	736
Parameters	654	SETRRS command.	736
Examples.	654	Syntax.	737
SETCEE command	655	SETRRS ARCHIVELOGGING command	737
Syntax.	655	SETRRS CANCEL command	738
Parameters	655	SETRRS SHUTDOWN command	739
SETCON command	656	SETSMF command	740
Scope in a sysplex.	656	Syntax.	740
Syntax.	656	Parameters	740
Parameters	656	SETSMS command	741
SETETR command	657	Scope in a sysplex.	744
Syntax.	658	Syntax.	744
Parameters	658	Parameters	744
SETGRS command	658	SETSSI command	760
Syntax.	658	Syntax.	760
Parameters	659	Parameters	760
SETGTZ command	663	SETUNI command	763
Syntax.	663	Syntax.	764
SETGTZ TRACKING command	663	Parameters	764
SETGTZ CLEAR command.	664	SETXCF command	776
SETGTZ EXCLUDE command.	664	Scope in a sysplex.	776
SETGTZ DEBUG command	669	Syntax.	776
SETGTZ DIAGNOSE command	671	SETXCF COUPLE command	777
SETGTZ PERSIST command	671	SETXCF DUMPCF command	780
SETHS command	672	SETXCF FORCE command	781
Syntax.	673	SETXCF FUNCTIONS command	784
SETICSF command	673	SETXCF MODIFY command	784
SETIOS command	674	SETXCF PRSMPOLICY command	788
Syntax.	675	SETXCF START command	788
Parameters	676	SETXCF STOP command	798
SETLOAD command	685	SLIP command	803
Syntax.	685	Syntax.	803
Parameters	685	Using SLIP commands	804
		Processing of SLIP commands	805
		Coding SLIP command parameters	805
		Setting a SLIP trap.	811
		Modifying an existing SLIP trap	879

Deleting an existing SLIP trap	880	Specifying TRACE TT options	917
START command	881	UNLOAD command	920
Syntax	881	Scope in a sysplex	920
Starting a system task from a console	882	Syntax	920
Starting the APPC/MVS address space	886	Parameters	920
Starting the APPC/MVS transaction scheduler		VARY command	921
address space	887	Scope in a sysplex	922
Starting the Common Event Adapter address		Syntax	923
space	887	Controlling problem determination mode for the	
Starting the Generalized Trace Facility	888	system console	923
I Starting IBM Generic Tracker for z/OS	890	Controlling MCS, HMCS and SMCS consoles	926
Starting hardware instrumentation services		Controlling hardcopy processing	935
(HIS)	890	Placing a console online or offline	938
Starting the Base Control Program internal		Processing devices or a path to devices attached	
interface (BCPii) address space after BCPii has		to a control unit	939
been terminated	891	Defining a tape device as automatically	
I Starting IBM Health Checker for z/OS	892	switchable	940
Starting the library lookaside (LLA) address		Placing an I/O device or a range of I/O devices	
space	892	online or offline	941
Starting the Object Access Method (OAM)	893	Allowing or preventing allocation from using an	
Starting Resource Recovery Services (RRS)	893	offline tape device	946
Starting the System Object Model (SOM)		Controlling a global resource serialization	
subsystem	895	complex	946
Starting TSO/VTAM time-sharing	895	Placing an I/O Path or Paths Online or Offline	948
Starting the virtual lookaside facility or data		Changing the state of coupling facility cache	
lookaside facility	897	structures and volumes	951
Starting an external writer	898	Placing an optical drive or library online or	
STOP command	899	offline	954
Syntax	899	Placing a system-managed tape library online or	
Stopping a running program	899	offline	955
Parameters	900	Analyzing the state of the PDSE subsystem	955
Stopping an ASCH initiator	902	Releasing PDSE latches	955
Stopping the data lookaside facility (DLF)	902	Modifying processing of PDSE monitor	955
I Stopping the generalized tracking facility	903	Display current state of the PDSE monitor	956
Stopping the hardware instrumentation services		Changing the SMS status of a storage group or	
(HIS)	903	volume	956
Stopping the Base Control Program internal		Updating space statistics for volumes in the	
interface (BCPii) address space	903	SMS configuration	958
I Stopping IBM Health Checker for z/OS	904	Controlling DFSMStvs processing	959
Stopping the library lookaside (LLA) address		Controlling CICSVR processing	968
space	904	Placing a switch port online or offline	969
Stopping the Object Access Method (OAM)		Controlling an application environment	970
Address Space	905	Activating a service policy	973
Stopping a System Object Model (SOM)	905	Removing a System from the XCF Sysplex	974
Stopping a temporary file system (TFS)	905	WRITELOG command	976
Stopping the virtual lookaside facility (VLF)	906	Syntax	976
STOPMN command	906	Parameters	976
Scope in a sysplex	906		
Syntax	906	Appendix A. HIS MAP format.	977
Parameters	906		
SWAP command	907	Appendix B. Accessibility	983
Syntax	907	Accessibility features	983
Operator-requested DDR	907	Consult assistive technologies	983
System-initiated DDR	908	Keyboard navigation of the user interface	983
SWITCH command	909	Dotted decimal syntax diagrams	983
Syntax	909		
Parameters	909	Notices	987
TRACE command	910	Policy for unsupported hardware	988
Syntax	910	Minimum supported hardware	989
Parameters	911	Trademarks	989
Specifying TRACE CT options	915		

Index 991

Figures

1.	Format of the LOAD Parameter	4	21.	Typical system command format	168
2.	Example of a Successful Response to a DISPLAY AUTOSWITCH Command	29	22.	System command format required for some commands	169
3.	Boxed device recovery procedure	35	23.	Display output illustration (column descriptions)	353
4.	Data structure of a basic sampling entry	50	24.	Display Output from D A,WTOR (Membername)	354
5.	Data structure of a guest program parameter under a TCB	52	25.	Display Output for D A,WTOR (Membername and Identifier)	354
6.	Data structure of a guest program parameter under an SRB	52	26.	Display Output for D A,WTOR (Membername and JOBNAME)	354
7.	Data structure of a diagnostic sampling entry	53	27.	Display Output from D A,SYM1	354
8.	DASD Devices shared between two systems	64	28.	Display Output from D A,SYMTEST	355
9.	DASD device shared by three systems	75	29.	Display Output from D A,SYMBOLS	355
10.	Example of a switched fabric.	77	30.	Sample output for the DISPLAY SMFLIM,S command	431
11.	Example of source and destination directors	78	31.	Sample output for the DISPLAY SMFLIM,R command	431
12.	Example of static routing in a switched fabric	78	32.	Sample output for the DISPLAY SMFLIM,R,MEMBER=SMFLIMU6,RULE=1 command	432
13.	Example of dynamic routing in a switched fabric	79	33.	Sample output for the DISPLAY SMFLIM,R,JOBNAME=XTUSI06,NOPGMNAME command	432
14.	Example of link aggregation	79	34.	DISPLAY SMS command syntax	434
15.	Example of static routing with aggregate links	83	35.	Sample output for the SET SMFLIM=(S1,S2,C) command	634
16.	Example of dynamic routing.	85	36.	IEAVTSZR procedure example	822
17.	Comparison of the display screens of full-capability and output-only display consoles	105			
18.	Example of DISPLAY CONSOLES,BACKLOG command output	118			
19.	Example of DISPLAY CONSOLES,ROUT=5 command output	124			
20.	Format of a console screen in message stream mode	137			

Tables

1. Possible Values IMSI Characters	6	36. Summary of the MODIFY command	533
2. MVS System Commands With Sysplex Scope	13	37. Examples of START commands to start jobs	535
3. Correcting boxed conditions	35	38. Examples of MODIFY commands	535
4. z/OS UNIX files generated by the HIS Profiler	45	39. Possible Volume and Device Combinations on	
5. IBM Defaults for PFKs	109	MOUNT Command	590
6. Checking the Commands Defined for Each		40. Summary of the REPLY Command	596
PFK	110	41. Summary of the RESET Command	603
7. Comparison of system commands and		42. Summary of the SEND Command	614
CONSOLE parameters in CONSOLxx	120	43. Sysplex Scope for SET Command	622
8. Comparison of system commands and INIT		44. Syntax for the SET command	623
statements in CONSOLxx	121	45. Summary of the SETGTZ command	663
9. Comparison of VARY HARDCPY commands		46. SETGTZ TRACKING command	663
and HARDCOPY statements in CONSOLxx	123	47. SETGTZ CLEAR command	664
10. Command groups used to determine		48. SETGTZ EXCLUDE command	665
command authority	125	49. SETGTZ DEBUG command	670
11. MVS Commands, RACF Access Authorities,		50. SETGTZ DIAGNOSE command	671
and Resource Names	127	51. SETGTZ PERSIST command	672
12. Message Routing Codes	139	52. Summary of the SETLOGR command	687
13. System command summary	154	53. Sysplex Scope for the SETLOGR Command	688
14. Syntax conventions	167	54. SETLOGR CTRACE command	688
15. Specifying FORCE with EMIF	172	55. SETLOGR FORCE command	690
16. CANCEL Command Tasks	174	56. SETLOGR MANAGE command	695
17. Summary of the CHNGDUMP Command	179	57. SETLOGR MONITOR command	697
18. Affects on the CSA storage captured in an		58. SETLOGR MONITORCommand	700
SVC dump	184	59. 1-Character parameter limit multipliers	709
19. Example of How CHNGDUMP Commands		60. Summary of the SETRRS command	736
Affect Dump Modes and Options	189	61. Comparison of SET SMS with SETSMS	743
20. Summary of the CONFIG Command	202	62. Incorrect Combinations of SETSMS	
21. Summary of the CONTROL Command	217	Parameters	744
22. Sysplex Scope for CONTROL Command	218	63. Summary of the SETXCF Command	776
23. Summary of the DISPLAY command	261	64. Sysplex Scope for the SETXCF Command	776
24. Sysplex Scope for DISPLAY Command	263	65. Summary of the SLIP Command	803
25. Summary of the Display GTZ Command	314	66. Summary of the SLIP SET parameters	813
26. Displaying System Activity: Information for		67. Summary of the START command	881
the LIST Operand	346	68. Summary of the STOP Command	899
27. Displaying System Activity: Information for		69. Summary of the SWAP Command	907
the ALL Operand	347	70. Summary of the VARY Command	921
28. Displaying System Activity: Information for a		71. Sysplex Scope for VARY Command	923
Specific Name	348	72. Actions for VARY WLM,APPLENV	971
29. Examples of START Commands to Start Jobs	350	73. General map record header format	977
30. Examples of DISPLAY Commands	351	74. Type I - Information record	977
31. Affects on the CSA storage captured in an		75. Type B = Boundary record	978
SVC dump	495	76. Type A = Address Space record	979
32. Summary of the DUMPDS Command	508	77. Type M = Module record	979
33. FORCE command tasks	517	78. Type C= CSECT record	981
34. Summary of the MODE Command	527	79. Type E = Entry Point	982
35. MODE parameters allowed for machine check			
interruptions	528		

About this document

This document describes how to use MVS™ system operator commands for the z/OS (5650-ZOS) operating systems. Although you can also perform many of the tasks described in this book using JES2 or JES3 commands, this book describes only the MVS (base control program) system commands. For information about commands for other z/OS elements, such as communications server (IP and SNA), DFSMS, JES2, JES3, and RACF®, see *z/OS V2R2 Information Roadmap*. For information about commands for other software products that run on z/OS, see *z/OS Software Products Collection*, SK3T-4270.

Who should use this information

This document is intended for anyone using a console and system commands to control the operating system. This document assumes that the user understands the hardware controls and features of the installation. It also assumes that the user understands the general organization and functions of a z/OS operating system.

How to use this document

To describe the basic tasks within these general tasks and to provide a convenient system commands reference, this document is organized as follows:

- Chapter 1, “System operations,” on page 1, describes the tasks of running the system from the time the system comes up to the time the system goes down for a normal or abnormal reason.
- Chapter 2, “System Reconfiguration,” on page 91, describes the reconfiguration actions of hardware units and partitions. The chapter shows how to physically or logically reconfigure the hardware units of a system; and for a partitionable processor complex, how to partition the complex into two sides or merge the two sides together.
- Chapter 3, “z/OS operator console operations,” on page 101, describes the consoles that MVS supports as operators' consoles. “Console characteristics and operations” on page 101 describes the operations and characteristics that you *cannot* define, including the operations that are common on all operator's consoles. “Defining and changing console characteristics” on page 120 describes the console characteristics that you *can* define, including the commands that operators and system programmers can use to tailor the consoles and console operations to the installation's requirements. “Defining and changing console characteristics” on page 120 also describes how to restrict the use of system commands based on which operator issues the command and/or which MCS, HMCS or SMCS console the operator uses.
- Chapter 4, “MVS system commands reference,” on page 153, summarizes the function, syntax, and parameters of all the MVS system commands that you can use to control the system.

z/OS information

This information explains how z/OS references information in other documents and on the web.

When possible, this information uses cross document links that go directly to the topic in reference using shortened versions of the document title. For complete titles and order numbers of the documents for all products that are part of z/OS, see *z/OS V2R2 Information Roadmap*.

To find the complete z/OS® library, go to IBM Knowledge Center (<http://www.ibm.com/support/knowledgecenter/SSLTBW/welcome>).

How to send your comments to IBM

We appreciate your input on this documentation. Please provide us with any feedback that you have, including comments on the clarity, accuracy, or completeness of the information.

Use one of the following methods to send your comments:

Important: If your comment regards a technical problem, see instead “If you have a technical problem.”

- Send an email to mhvrcfs@us.ibm.com.
- Send an email from the "Contact us" web page for z/OS (<http://www.ibm.com/systems/z/os/zos/webqs.html>).

Include the following information:

- Your name and address
- Your email address
- Your phone or fax number
- The publication title and order number:
z/OS MVS System Commands
SA38-0666-07
- The topic and page number or URL of the specific information to which your comment relates
- The text of your comment.

When you send comments to IBM®, you grant IBM a nonexclusive right to use or distribute the comments in any way appropriate without incurring any obligation to you.

IBM or any other organizations use the personal information that you supply to contact you only about the issues that you submit.

If you have a technical problem

Do not use the feedback methods that are listed for sending comments. Instead, take one or more of the following actions:

- Visit the IBM Support Portal (support.ibm.com).
- Contact your IBM service representative.
- Call IBM technical support.

Summary of changes

This information includes terminology, maintenance, and editorial changes. Technical changes or additions to the text and illustrations for the current edition are indicated by a vertical line to the left of the change.

Summary of changes for Version 2 Release 2 (V2R2), as updated December 2016

The following changes are made for z/OS V2R2 as updated December 2016.

New

- The M parameter has been added in “Displaying SMF data” on page 428.

Summary of changes for Version 2 Release 2 (V2R2), as updated June 2016

The following changes are made for z/OS V2R2 as updated June 2016.

New

- The LINKINFO parameter has been added to the DISPLAY M command.
- The M parameter has been added to the DISPLAY SMF command.

Summary of changes for Version 2 Release 2 (V2R2), as updated March 2016

The following changes are made for z/OS V2R2 as updated March 2016.

Changed

- “Communicating with System REXX” on page 540 is updated to include several new parameters.
- Information about PROGxx is updated. See “Updating LNKLST concatenations” on page 728.
- Information about the SET TIMEZONE command is updated. See “SET command” on page 620.
- Information about using the HMCS console for initialization is updated. See “Starting the system” on page 2 and “Preparing the system hardware” on page 3.

Summary of changes for Version 2 Release 2 (V2R2), as updated December 2015

The following changes are made for z/OS V2R2 as updated December 2015.

New

- DISPLAY ICSF command: Use this command to display certain ICSF options, status for available cryptographic devices, information about network-attached open cryptographic servers (remote devices), information pertaining to active

key data sets (KDS), status of the master key registers for the available cryptographic devices, and list the systems that are available to participate in commands with a SYSPLEX scope.

- The DISPLAY IEFOPZ command was added. See “Displaying the data set optimization configuration” on page 326 for more information.
- DISPLAY SMFLIM command: Use this command to display the storage limits that are specified in the in-storage copy of the SMFLIMxx parmlib members.
- SETICSF command: Use this command to perform specific ICSF administration functions.
- The SET IEFOPZ command was added. See “Displaying the data set optimization configuration” on page 326 for more information.
- SET SMFLIM command: Use this command to update the in-storage copy of the SMF limit rules with the values specified in the SMFLIMxx parmlib members.

Changed

- The MODIFY LLA command was updated to support updating an entire LLA managed library or updating a specific member of that library. See “Building and replacing library lookaside directories” on page 573 for more information.
- The SETLOGR MANAGE command was updated to support the act of preventing a z/OS image from accessing LOGR couple data sets. See “Syntax” on page 695 and “Parameters” on page 695 for information.

Summary of changes in z/OS Version 2 Release 2 (V2R2)

The following changes were made to this information in z/OS Version 2 Release 2 (V2R2).

New

- The MANAGE option was added to the IXGCNF parameter of the DISPLAY LOGGER command as described in “Displaying the system logger and its log streams” on page 356.
- “Displaying status of z/OS UNIX System Services” on page 380 was updated.
 - An example was provided that shows a sample display when the KERNELSTACKS(ABOVE) option is specified for the BPXPRMxx parmlib statement.
 - A new option, PROCESSES, was added to the DISPLAY OMVS,STORAGE command.
- New ALERT parameter on the DISPLAY SMS command, to display storage groups that have reached thresholds. For details, refer to “Displaying storage management subsystem information” on page 432.
- New SYMNAME parameter on the DISPLAY SYMBOLS command displays all system symbols matching the symbol name specified. See “Displaying static system symbols” on page 454.
- You can pass a MODIFY command to a PFS through an LFS interface, as described in “Passing a MODIFY command string to a physical file system (PFS) through a logical file system (LFS)” on page 577.
- New keyword GRSMON=xx on the SETGRS command, to specify a GRSMONxx parmlib member.
- New sub-command SETGTZ PERSIST was added to operator command SETGTZ as described in “SETGTZ PERSIST command” on page 671.
- The IOTTAPE class keyword was added to the SETIOS MIH command in “SETIOS command” on page 674.

- New parameters DEALLOCCURDS and DEALLOC added to the SETLOGR FORCE command as described in “SETLOGR FORCE command” on page 689.
- Added new SETLOGR MANAGE command as described in “SETLOGR MANAGE command” on page 695.
- New DELETEFORCE and SERVICEMASK parameters on the SETPROG EXIT command, as described in “Updating dynamic exits” on page 723.
- New USER_ACSVAR parameter on the SETSMS command, to specify values for the ACS read-only variable USER_ACSVAR.
- The DELETE parameter to dynamically deactivate and delete a subsystem was added in “SETSSI command” on page 760.
- “Indirect Addresses” on page 805 was updated to indicate changes to the displacement element of an indirect address.
- The START GTZ command was added in “Starting IBM Generic Tracker for z/OS” on page 890.
- The START *hzsproc* command was added in “Starting IBM Health Checker for z/OS” on page 892.
- The STOP GTZ command was added in “Stopping the generalized tracking facility” on page 903.
- The STOP *hzsproc* command was added in “Stopping IBM Health Checker for z/OS” on page 904.
- The TIMEOUT parameter was added in “VARY CN command” on page 926, along with information about automatic timeout for consoles.

Updated

- Information has been updated in “Setting up hardware event data collection” on page 40, “Accessing the output from a hardware event data collection run” on page 43, and “Interpreting the z/OS UNIX system services output files” on page 45.
- The example command output has been updated in “Displaying hardware event data collection status” on page 322.
- The range of acceptable *pfid* values has been updated in “Displaying PCIE information” on page 402.
- The rules for subsystem name (subname) for the SETSSI commands has been added in “MVS commands, RACF access authorities, and resource names” on page 127.
- The following commands, which previously required that DFSMStvs was installed, now display information about forward recovery when DFSMStvs is not installed:
 - DISPLAY SMS,DSNAME(*datasetname*)
 - DISPLAY SMS,LOG(*logstreamid* | ALL)
 - VARY SMS,LOG(*logstreamid*),QUIESCE | DISABLE | ENABLE

For more information, refer to “Displaying storage management subsystem information” on page 432 and “VARY command” on page 921.
- The DISPLAY SYMBOLS SUMMARY command now displays longer symbol names and substitution text. See “Displaying static system symbols” on page 454.
- Information about automatic logoff (TIMEOUT) has been added in “Logging on to the system” on page 9, “LOGON command” on page 525, and “LOGOFF command” on page 524.

- Information about concurrent logon has been added in “Logging on to the system” on page 9 and “LOGON command” on page 525.
- The MODIFY CEA,DISPLAY command now provides an example of the F CEA,D,PARMS command, which displays the current settings for each statement in the CEAPRMxx parmlib member.
- Table 36 on page 533 was updated to include the new MODIFY OMVS,PFS command.
- Syntax and parameter information has been updated in “Starting, configuring, and stopping hardware event data collection” on page 561.
- The DEVSUP parameter on the SET command was updated to accept multiple DEVSUP:xx parmlib member names, to be processed on the same command. For details, see “Parameters” on page 624.
- You can now use the SETLOGRC command to specify a data set name or log stream name, and you can also switch to using a new data set without issuing an IPL. For details, see “SETLOGRC command” on page 703.

Summary of changes for z/OS Version 2 Release 1 (V2R1), as updated February 2015

The following changes are made for z/OS Version 2 Release 1 (V2R1), as updated February 2015.

New

- The following new SDUMP, SYSABEND, SYSUDUMP, and SYSMDUMP options were added for the “CHNGDUMP command” on page 179:
 - HCSABYASID
 - HCSANoOwner
 - HCSASysOwner
- The NAME parameter has been added to the DISPLAY HS,CONFIG command in “Displaying Basic HyperSwap information” on page 325 and to the SETHS SWAP command in “SETHS command” on page 672.
- The DISPLAY IOS, HYPERWRITE command has been added in “Displaying the IBM zHyperWrite data replication status” on page 337.
- The DISPLAY IQP command has been added in “Displaying PCIE-related parameters” on page 344.
- The following new SDATA options were added for the “DUMP command” on page 487:
 - HCAS
 - HCNO
 - HCSY
- A new UNFENCE parameter has been added for the “SETHS command” on page 672.
- A new FABRICPRTY parameter has been added for the “SETIOS command” on page 674.
- The following new SDATA options were added for the “SLIP command” on page 803:
 - HCSABYASID
 - HCSANoOwner
 - HCSASysOwner

Changed

- In “Counter sets output in a .CNT file” on page 45, the multithreading (MT) utilization counter set is added.
- The following commands are updated for multithreading (MT) support:
 - DISPLAY - See “Displaying hardware event data collection status” on page 322. The description is extended to cover all subtypes of SMF record type 113.
 - MODIFY - See “Starting, configuring, and stopping hardware event data collection” on page 561. The description is extended to cover all subtypes of SMF record type 113.
 - START - See “Starting hardware instrumentation services (HIS)” on page 890. The description is extended to cover all subtypes of SMF record type 113.
- The descriptions of the CSA, LSQA, RGN, and SQA options have been updated in “CHNGDUMP command” on page 179 and “DUMP command” on page 487.
- The ARM and ARMRESTART parameters, which were omitted in previous editions, have been restored in the syntax diagram and parameter description in “FORCE command” on page 517.
- Under the SLIP command, the topic formerly entitled, “Keeping PER Traps from Slowing System Performance,” has been updated and replaced by “Performance considerations for designing a SLIP trap” on page 813.
- The rules for using wildcard characters with the VARY SMS,MONDS command have been updated in “Changing the state of coupling facility cache structures and volumes” on page 951.

Summary of changes for z/OS Version 2 Release 1 (V2R1), as updated March 2014

The following changes are made for z/OS Version 2 Release 1 (V2R1) as updated March 2014.

New

- The topic, “Diagnosing problems in a switched fabric” on page 75, provides guidance for problem determination.
- In “MVS commands, RACF access authorities, and resource names” on page 127, the **SETGRS CNS** command also requires CONTROL access to the MVS.SETGRS.GRS resource in the OPERCMDS class.
- A note about command format has been added to the “Syntax” topics of the **DISPLAY GTZ** and **SETGTZ** commands.
- Information about the **PWT** parameter is added to the **SETOMVS** command.
- In “Starting a system task from a console” on page 882, guidance has been added to the description of the SUB=*subsystemname* parameter about not specifying SUB=MSTR unless a program specifically supports it.
- The **VARY SMS, . . . ,SPACE** command allows you to update space statistics in the ACDS for a pool storage group or a DASD volume. For details, see “Updating space statistics for volumes in the SMS configuration” on page 958.
- Various new and changed topics document support for the new XCF Note Pad Service function. The XCF Note Pad Service is a new application programming interface that allows programs to manipulate notes in an XCF note pad. A note pad is an abstraction layered on top of the existing coupling facility list structure interfaces. You can use the new IXCNOTE macro to manipulate data in a coupling facility list structure, provided the note pad abstraction meets the needs of the application.

z/OS Version 2 Release 1 summary of changes

See the following publications for all enhancements to z/OS Version 2 Release 1 (V2R1):

- *z/OS Migration*
- *z/OS Planning for Installation*
- *z/OS Summary of Message and Interface Changes*
- *z/OS Introduction and Release Guide*

Chapter 1. System operations

The tasks of starting, running, and stopping the MVS operating system involve controlling the MVS system software and most of the installation's hardware, including processors, channel paths, and I/O devices. This book is for people who need reference information about these tasks and the MVS system commands. They include:

- Those who develop procedures for the daily operations, including system programmers and lead operators
- Operators who want to learn how to use a console to control MVS and how to change some of the console's characteristics

System planners and system programmers should refer to the *z/OS MVS Planning: Operations* for information on planning:

- System and sysplex operation management
- MCS (multiple console support) consoles
- HMCS (HMC multiple console support) consoles
- SMCS (SNA multiple console support) consoles
- Extended MCS (Extended multiple console support) consoles

This chapter describes how to operate an MVS system using MVS system commands. Subsystem (JES2 or JES3) commands can perform many of the same functions as MVS system commands but are described in *z/OS JES2 Commands* and *z/OS JES3 Commands*.

The tasks of operating the MVS system that are described in this chapter include:

- "Starting, loading, and initializing the system" on page 2
- "Controlling the system" on page 10
- "Controlling time-sharing" on page 22
- "Controlling jobs" on page 22
- "Controlling started tasks" on page 25
- "Controlling system information recording" on page 25
- "Controlling automatic tape switching" on page 28
- "Interacting with system functions" on page 29
- "Command flooding" on page 36
- "Setting up hardware event data collection" on page 40
- "Accessing the output from a hardware event data collection run" on page 43
- "Responding to failing devices" on page 54
- "Quiescing the system" on page 55
- "Stopping the system" on page 55
- "Recovery from hardware problems" on page 55

Controlling MVS involves issuing commands on a console and responding to messages that appear on the console screen. Other books that describe controlling MVS include:

- *z/OS MVS JCL Reference*, which documents two job control language statements (the COMMAND statement and the JCL command statement) that you can use to enter system commands through the input job stream.
- *z/OS MVS Planning: Operations*, which contains information about using MCS, HMCS, SMCS and extended MCS consoles as well as MVS message and command processing.
- *z/OS MVS Planning: Global Resource Serialization*, which contains information about controlling a global resource serialization (GRS) ring.

Starting, loading, and initializing the system

Before the system can do work, you must:

1. Start the system.
2. Prepare the system hardware.
3. Load the system software.
4. Initialize the system software. At this point, your installation might require you to logon to the console. See “Logging on to the system” on page 9.
5. Set the time and date, as required.
6. Start the job entry subsystem (JES2 or JES3).
7. Specify all job entry subsystem parameters.

The following sections describe in detail how to start, load, and initialize the system.

Starting the system

You must decide which console to use to start your system:

Using the HMCS console for initialization

The HMCS console can be used to IPL z/OS. Use of the system console or NIP consoles defined in HCD is not required when using HMCS consoles to IPL. If the HMCS console is not available, z/OS looks in the IODF for devices to be used as NIP consoles.

Important: If automation is used to remotely IPL the z/OS system, the nucleus initialization program (NIP) console must be powered off or disconnected from the z/OS partition that is to be IPLed, before the IPL is initiated. Failure to do so will prevent automation from receiving messages issued during the IPL and prevent automation from taking any appropriate actions.

Using the MCS console for initialization

In HCD, you can specify a list of device numbers to use as NIP consoles. The initialization programs use the first online and ready device in the list. NIP consoles must be devices that are locally connected to the system using control units that do not support systems network architecture (SNA) protocols. This means that SMCS consoles cannot be used as NIP consoles. If that device is also specified on a CONSOLE statement in CONSOLxx, it is initialized as an MCS console and appears to change to an MCS console when console initialization is complete. If no NIP consoles are defined, or no NIP consoles are online when MVS is loaded, MVS tries to use the system console during initialization.

| **Important:** If automation is used to remotely IPL the z/OS system, the system console (the "Operating System Messages" window located on the Hardware Management Console) must be used to IPL the system. The HMCS console (the "Integrated 3270 Console" located on the Hardware Management Console) or the NIP Console must be powered down or disconnected or from the z/OS partition that is to be IPLed, before the IPL is initiated. Failure to do so will prevent automation from receiving messages issued during the IPL and prevent automation from taking any appropriate actions.

Using the system console for initialization

If neither the HMCS or MCS console is available, the system console is used to initialize the system. The system console is located on the Hardware Management Console (HMC), where you load the system software and specify the LOAD parameter. Then you use this console to initialize the system. The initialization programs might require setting initial values, specifying an alternate master catalog, and setting the time and date.

Preparing the system hardware

To prepare the system hardware for work:

1. Turn on power for the processor.
2. Perform the initial microprogram load (IML) function for the processor.
3. Specify the central storage configuration.
4. Ensure that all volumes required by the system are online.
5. If necessary, ensure that the console device is powered on and connected to the system. To use an HMCS to IPL the system, ensure that the Integrated 3270 Console icon is set to connect to the appropriate LPAR.

| **Important:** If automation is used to remotely IPL the z/OS system, the HMCS console (the "Integrated 3270 Console" located on the Hardware Management Console) must be disconnected from the z/OS partition that is to be IPLed, before the IPL is initiated. Failure to do so will prevent automation from receiving messages issued during the IPL and prevent automation from taking any appropriate actions.

6. Switch into the configuration all control units for devices that the system needs.

For more information on these procedures, see the processor operator's guide or your installation's operations procedures.

Loading the system software

Once the system hardware is ready, you can use the hardware management console (HMC) to load the system software. Consider the following information for loading system software through the HMC:

1. This task is available in Operator, Advanced Operator, System Programmer, or Service Representative mode.
2. Other products and documentation may refer to this operation as an initial program load (IPL).
3. For daily or routine loading of images, you can customize activation profiles to specify how you want to load images, then use a profile with the Activate task to perform all the operations necessary to make an image operational, including loading it with a control program.

Load (except for a coupling facility image) causes a program to be read from a designated device and initiates the execution of that program. If the CPC is operating in logically partitioned (LPAR) mode, the logical partition is the target of the load. Otherwise, if the CPC is operating in basic mode, the CPC is the target of the load.

You can monitor IPL messages from the system, MCS (via a NIP console) or HMCS console. If you are loading the system software from an HMCS, you must first activate the HMCS by connecting the Integrated 3270 icon to the appropriate LPAR.

To perform a load, do the following:

1. Open the **Task List** from the **Views** area.
2. Open **CPC Recovery** from the **Task List Work Area**.
3. Open **Groups** from the **Views** area.
4. Open the group that contains the CPC image that you want to load.
5. Select one object.
Load is considered a disruptive task. If the object is locked, you must unlock it before continuing.
6. Drag and drop the selected object on **Load** in the **CPC Recovery** tasks area. The **Load** window is displayed with the information that was last used when the CPC image was loaded.
7. Review the information on the window to verify that the object you will load is the correct one. If the information is correct, select the **OK** push button. The **Load Task Confirmation** window is displayed.
8. Review the information on the window to verify that the object you will load is the correct one. If the information is correct, select the **Yes** push button. The **Load Progress** window displays indicating the progress of the load and the outcome.
9. Select the **OK** push button to close the window when the load completes successfully. Otherwise, if the load does not complete successfully, follow the directions on the window to determine the problem and how to correct it.

Use the online help to get additional information for loading a CPC image.

Explanation of the A=INITIALIZE SYSTEM CONTROL PROGRAM, A2 Field

This field specifies the LOAD parameter. The format of the LOAD parameter is:

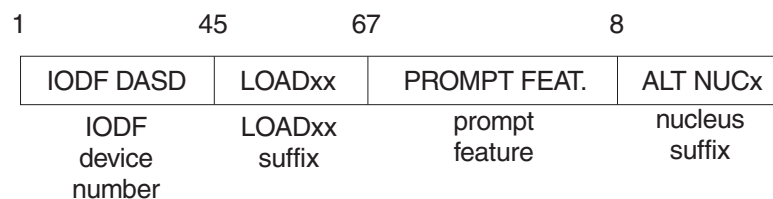

Figure 1. Format of the LOAD Parameter

The LOAD parameter is eight characters long and contains the following information:

1. The first four characters (characters 1 through 4 of the LOAD parameter) specify the hexadecimal device number for the device that contains the I/O definition file (IODF) VSAM data set. This is also the device on which the search for the LOADxx member of SYSn.IPLPARM or SYS1.PARMLIB begins.

The device number can be in the range X'0000' to X'FFFF'. If the number is less than 4 digits, specify leading zeros before the device number. This device must be in the same subchannel set as the IPL device. If you do not specify the device number, the system uses the device number of the system residence (SYSRES) volume.

2. The next two characters (characters 5 and 6 of the LOAD parameter) specify the suffix of the LOADxx parmlib member that the system is to use. The LOADxx member contains information about the name of the IODF data set, which master catalog to use, and which IEASYSxx members of SYS1.PARMLIB to use.

The default for the LOADxx suffix is zeros. The system reads the LOADxx and NUCLSTxx members from SYSn.IPLPARM or SYS1.PARMLIB on the volume specified on the LOAD parameter (or the SYSRES volume, if a volume is not specified). Once the system opens the master catalog, the system reads all other members from the SYS1.PARMLIB data set that is pointed to by the master catalog. This SYS1.PARMLIB might be different from the SYS1.PARMLIB data set to which the LOAD parameter points.

For more information about LOADxx, see the description of LOADxx in *z/OS MVS Initialization and Tuning Reference*.

3. The next character (character 7 of the LOAD parameter) specifies the prompting and message suppression characteristics that the system is to use at IPL. This character is commonly known as an initialization message suppression indicator (IMSI).

Suppressing Informational Messages: Some IMSI characters suppress informational messages from the system console, which can speed up the initialization process and reduce message traffic to the console. It can also cause you to miss some critical messages, so you should always review the hardcopy log after initialization is complete.

When the system suppresses informational messages, it displays the following messages:

- Messages with descriptor codes 1, 2, 3, 11, or 12
- Write-to-operator with reply (WTOR) messages
- Command responses
- Synchronous messages that can indicate problems during initialization.

It does not display the contents of a parmlib member, even if the L option has been specified.

Prompting for Operator Responses: You can specify an IMSI character that tells the system to issue a MASTER CATALOG prompt, a SYSTEM PARAMETERS prompt, both, or none:

- If the system issues a MASTER CATALOG prompt, the operator response overrides the values that are specified on the SYSCAT parameter in the LOADxx parmlib member.
- If the system issues a SYSTEM PARAMETERS prompt, the operator response overrides the values that are specified on the SYSPARM parameter in LOADxx. Also, if LOADxx specifies the IEASYMxx parameter which in turn specifies a SYSPARM parameter for IEASYSxx, then the operator response also overrides the values that the SYSPARM parameter in IEASYMxx specifies.
- If the system *does not* prompt the operator, the system uses the values specified in LOADxx. If the SYSCAT and SYSPARM statements are not specified in LOADxx, the system issues one or both prompts to obtain the missing information.

Prompting for the Name of the Master Catalog: If you choose an IMSI character that tells the system *not* to prompt for the master catalog name, the system uses the name specified on the SYSCAT parameter in the LOADxx parmlib member.

The default for the system parameter prompt is to use IEASYS00 in SYS1.PARMLIB, and the default for the master catalog prompt is to use SYSCATLG in SYS1.NUCLEUS.

The following table shows the possible values for the IMSI character. The default value is *period (.)*.

Table 1. Possible Values IMSI Characters

IMSI Character	Display Informational Messages	Prompt for Master Catalog Response	Prompt for System Parameters Response
<i>period (.)</i> or <i>blank</i>	No	No	No
A	Yes	Yes	Yes
C	No	Yes	No
D	Yes	Yes	No
M	Yes	No	No
P	No	Yes	Yes
S	No	No	Yes
T	Yes	No	Yes

- The last character (character 8 of the LOAD parameter) specifies the alternate nucleus identifier (0-9). Use this character at the system programmer's direction. If you do not specify an alternate nucleus identifier, the system loads the standard (or primary) nucleus (IEANUC01) and an architectural extension of the nucleus (IEANUC11 or IEANUC21), unless the NUCLEUS statement is specified in the LOADxx member. For more information, see *z/OS MVS Initialization and Tuning Reference*.

Also consider the following:

- Decide whether to accept the system prompt indicator default. The default causes the system to suppress messages and not prompt the operator. You might miss critical messages during initialization, so you should review the hardcopy log.
New installations might want to select prompt feature A (display all messages and prompt the operator) or M (display all messages but do not prompt operator) on the Hardware Management Console while validating changes and analyzing system errors during the initialization process. Specifying either A or M might increase message traffic.
- Omit the LOAD parameter when you accept all the IBM-supplied defaults.
- Each character in the LOAD parameter is positional. If you change any of the defaults you *must* retype the characters or use periods (...) to hold the positions.
- You *cannot* leave any leading spaces blank, unless the defaults are accepted for the rest of the LOAD parameter.

Explanation of the A=INITIALIZE SYSTEM CONTROL PROGRAM, A3 Field

This field specifies the operator load function to IPL the MVS operating system.

Selecting the operator load function causes the hardware to read an IPL (initial program loader) program into storage from the system residence volume. For this reason, loading and initializing the system is often called the “IPL procedure” or just “IPL”. Likewise, “IPLing” the system means loading and initializing the system.

The IPL program is what actually loads the system software; if the IPL program does not get into storage or does not receive control properly, the entire load process stops and the processor pauses. If the IPL program does not finish properly, it puts the system into a disabled wait state with an error code in the low-order 12 bits of the program status word (PSW). To continue loading the system, display the PSW, note the error code, and follow the instructions for that code given in *z/OS MVS System Codes*. The processor operations documentation tells you how to display the PSW.

Initializing the system software

Once the software is loaded into storage, it must be given specific starting values before it can do work. These values are supplied through a LOADxx parmlib member specified by the LOAD parameter through the Hardware Management Console, HMCS, system console or the NIP console during the initialization process.

In certain situations, the system prompts you to specify an alternate master catalog; then it prompts for system parameters that are not specified in LOADxx. The following sections explain how to respond to those prompts.

Specifying an Alternate Master Catalog

During system initialization, unless the SYSCAT parameter is specified in the LOAD parameter, the system issues the following message:

```
IEA347A SPECIFY MASTER CATALOG PARAMETER
```

You must respond to this message. You can respond in one of two ways:

- If your installation uses the default member of SYS1.NUCLEUS, SYSCATLG, to find the master catalog, press the ENTER key.
- If your installation uses an alternate member of SYS1.NUCLEUS, SYSCATnn, to find an alternate master catalog, enter two characters for *nn*.

Specifying System Parameters Not Defined in LOADxx

The LOAD parameter can supply values not defined at system installation time. If this is not done, you must supply them as system parameters in response to the following system message:

```
IEA101A SPECIFY SYSTEM PARAMETERS FOR product-name
```

You must respond to this message. You can respond with specific system parameters, such as

```
REPLY 00,CLPA,SYSP=83,LNK=(04,05,PQ),SYSNAME=AQ
```

However, a typographical error made in this response can lead to undesirable system operation. To help avoid this situation, the system programmer can specify system parameters in IEASYSxx parmlib members. If this has been done, you can respond to message IEA101A in one of the following ways:

- To use the system parameters specified in the IEASYS00 parmlib member, press the ENTER key.

- To use system parameters specified by IEASYSxx parmlib members along with IEASYS00, use the SYSP operand on the REPLY command to specify the 2-character suffixes that identify the IEASYSxx parmlib members.

For example, to use the parameters specified in parmlib members IEASYSAA and IEASYSBB along with IEASYS00, enter:

```
REPLY 00,SYSP=(AA,BB)
```

Note: Depending on the specific system parameter, a parameter value specified in the alternate parmlib members supplements or overrides the value specified in IEASYS00.

If the reply is longer than one line (there are 80 characters per line), you can follow the last parameter with a comma or a blank and CONT. For details on how to continue system parameters, see “Specifying system parameters” on page 602 in the description of the REPLY command in this book.

For details about parmlib members, see *z/OS MVS Initialization and Tuning Reference*.

Setting the Time and Date

If the time-of-day (TOD) clock on the target processor is not set or if your installation specifies the OPERATOR PROMPT parameter in the CLOCKxx member of SYS1.PARMLIB that the system uses for initialization, the system prompts you during initialization to set the correct time and date with message IEA886A and/or message IEA888A. Message IEA886A asks you to specify values for the time and date. Message IEA888A displays the time and date and lets you accept or change these values. In response to either message, set an accurate time and date according to your installation's requirements.

For example, suppose the system issues:

```
IEA888A UTC DATE=1991.301,CLOCK=22.31.53
*00 IEA888A LOCAL DATE=1991.301,CLOCK=17.31.53 REPLY U, OR UTC/LOCAL TIME
```

The values in this message indicate that the local time is 5:31:53 P.M. on October 28, 1991 and that Coordinated Universal Time (UTC) is five hours later than local time in your time zone. If the local time at your installation is really 8:00:00 A.M. on October 29, 1991, reply as follows:

```
R 00,DATE=1991.302,CLOCK=13.00.00,GMT
```

The system responds with:

```
IEA888A UTC DATE=1991.302,CLOCK=13.00.00
*00 IEA888A LOCAL DATE=1991.301,CLOCK=08.00.00 REPLY U, OR UTC/LOCAL TIME
```

Note that the system sets the local time but not the local date from the time and date you specify. To set the local date, reply as follows:

```
R 00,DATE=1991.302
```

If the new UTC and local time values are still not accurate enough, you can reply with new UTC time values now (and as many times as you need) to bring the system's values closer to what your installation requires. When you are satisfied with the system's values, reply as follows:

```
R 00,U
```

See “REPLY command” on page 596.

Initializing MCS, HMCS and SMCS consoles

Message IEE612I appears on an MCS, HMCS and SMCS console when it completes initialization.

If you enter the command DISPLAY C,K (or D C,K), the system displays a summary of the CONTROL commands. You can use these commands to change the characteristics of the console. See “Displaying CONTROL command functions” on page 280 for information about the DISPLAY C,K command.

Logging on to the system

Your installation can control the use of the system commands and access to MCS, HMCS and SMCS consoles through the system authorization facility (SAF) and the Resource Access Control Facility (RACF). Your installation can require operators to use the LOGON command to log on to the system and identify themselves.

Your installation can specify the LOGON attribute for MCS, HMCS and SMCS consoles in two ways. First, a default LOGON attribute can be specified for all consoles active on a system by specifying the LOGON keyword on the DEFAULT statement in the CONSOLxx parmlib member. Second, individual consoles can override the default LOGON attribute by specifying the LOGON keyword on the CONSOLE statement in the CONSOLxx parmlib member. For more information on specifying LOGON consult *z/OS MVS Planning: Operations* and *z/OS MVS Initialization and Tuning Reference*.

Your installation can specify that LOGON is required by specifying LOGON(REQUIRED) on the DEFAULT statement (for all MCS, HMCS and SMCS consoles) or on the CONSOLE statement (for a single console). When LOGON is a system requirement, you can issue commands only through a master authority console until RACF is fully initialized and able to process logon requests. Until RACF is initialized, you cannot issue any commands from any non-master authority console.

Once RACF is fully initialized, all operators are required to logon. The IEE187I message prompts you for a user ID and password. Optionally, you might enter a group id and a security label. See “LOGON command” on page 525 for more information.

IBM suggests that SMCS consoles be LOGON(REQUIRED), either using the system-wide DEFAULT LOGON specification or the CONSOLE LOGON specification of the console.

| A TIMEOUT value may be specified for a console. If an operator has logged on to
| the console with a user ID, the system will automatically log the user ID off after
| the number of minutes specified by TIMEOUT have elapsed without any console
| input activity (pressing an attention-generating key, such as Enter, PA1, PA2, or a
| PFK).

| Your installation can specify that LOGON is automatic by specifying
| LOGON(AUTO) on the DEFAULT statement (for all MCS, HMCS and SMCS
| consoles) or on the CONSOLE statement (for a single console). When LOGON is
| not a system requirement, after the security product is fully initialized, the system
| will automatically issue an MCS LOGON command to each active MCS, HMCS or
| SMCS console; system operators may log on to these consoles but are not required
| to do so. Automatic logon affects only *full capability* consoles. If a TIMEOUT

value is specified for a console, it will be ignored when the user ID matches the console name and the console is in LOGON(AUTO) mode.

Your RACF administrator creates RACF user profiles for each operator. Each operator can have access to different commands, consoles, data sets, and other RACF-protected resources, according to the person's responsibilities. The RACF administrator also creates RACF resource profiles that protect *all* operator commands. If you need more information on creating profiles for operators, consoles, MVS commands, and other resources, see the *z/OS Security Server RACF Security Administrator's Guide*.

Your installation can specify that LOGON is optional by specifying LOGON(OPTIONAL) on the DEFAULT statement (for all consoles on the system) or on the CONSOLE statement (for a single console). Code the OPTIONAL parameter when your installation has selected consoles defined in RACF to allow the operator to log on.

z/OS MVS Planning: Operations has more information about controlling system commands and consoles in a secure environment.

Typically, an operator logs on to a single console. If your installation wishes to allow an operator to be concurrently logged on to multiple consoles within a system or sysplex, your security administrator can allow this. When the security profile MVS.MULTIPLE.LOGON.CHECK is defined in the OPERCMDS class, an operator may log on to multiple consoles. Defining this profile allows all operators to be able to log on multiple times. There is no limit to the number of consoles to which an operator may be logged on. Operators are still required to provide a password while logging on to each console.

Starting and specifying parameters for the job entry subsystem

Even after the system is initialized, it cannot accept work until the job entry subsystem (JES2 or JES3) is started. The system automatically starts JES2 or JES3 if your installation provides this capability. Otherwise, you must issue the START command. For further information about starting JES, see either *z/OS JES2 Commands* or *z/OS JES3 Commands*. See "START command" on page 881.

Controlling the system

Controlling the operating system effectively, includes the following tasks:

- Display current system status, such as the number of active jobs and teleprocessing functions, so you can take appropriate actions to operate the system efficiently and to correct potential problems
- Display the status of devices and availability of paths.
- Communicate among several consoles.
- Communicate within a sysplex. In a sysplex, several MVS systems function together to process work, and you might need to know about the operations of more than one system in a sysplex.
- Set the time and change the system parameters.
- Use the system restart function to control certain system functions.
- Respond to message IEA502A.
- Respond to message BLW004A.
- Activate a workload management service policy for a sysplex.

MVS provides system and subsystem commands that display job and system status either when requested or continually at a regular interval. Other commands route status information to one or more consoles and provide communication among operators in a multiple-console environment, as well as communication with time-sharing users. Many commands let you display information about all the systems in a sysplex, and some commands allow you to control any target system in the sysplex.

The following sections describe in detail how to control the system.

Displaying current system status

Using the **DISPLAY** command, you can display overview information about all current system activity and detailed information about active batch jobs, started tasks, system address spaces, and/or logged-on time-sharing users. (The **DISPLAY** command in Chapter 4, “MVS system commands reference,” on page 153 describes the overview and detailed information you can display.) The command produces a one-time display of status as it is at the time you enter the command.

To help you keep up with the system's needs, you can enter the **DISPLAY R** command to display system requests waiting for replies or actions, mount requests not yet fulfilled, and devices waiting for operator intervention. You can use the information in the display to take any necessary actions. See “Displaying system requests” on page 418 for information about the **DISPLAY R** command.

Using the **MONITOR** command, you can keep track of jobs starting and stopping. In response to the **MONITOR** command, the system displays the job identification whenever a job starts or stops. Using this command, you can also request that the system notify you of TSO logons, JCL failures, and data set allocations. See “**MONITOR** command” on page 587. You can also use the **SETCON MONITOR** command to enable or disable monitoring messages for jobs, TSO/E sessions, and data set allocations. See “**SETCON** command” on page 656.

Displaying the status of devices and availability of paths

There are three commands that you can use to display the status of devices and the availability of the paths these devices are on.

The **DISPLAY U** command allows you to keep track of the availability for allocation of the following devices attached to the system:

- Channel-to-channel (CTC) links
- Direct access storage devices (DASDs)
- Graphic devices
- Magnetic tape units
- Communication equipment
- Unit record devices

This command displays device status and the job names and ASIDs of device users. Knowing what jobs and ASIDs are using a particular device allows you to determine whether you can take the device offline. See “Displaying device status and allocation” on page 460 for information about the **DISPLAY U** command.

The **DISPLAY M** command allows you to keep track of the availability of channel paths and devices on these paths. See “Displaying system configuration information” on page 368 for information about the **DISPLAY M** command.

The **DEVSERV PATHS** command can help you solve hardware or configuration problems. The display includes the status of paths, the channel path ids, the logical mode of devices, the number of data sets allocated on volumes, and volume serial labels. Because the DEVSERV command causes the system to issue an I/O request on paths to a device or devices, the resulting display reflects the current physical state of the path. Comparable displays from the DISPLAY M command reflect less recent information from the last use of MVS control blocks. For example, assume that an I/O device is performing below normal and you suspect that some paths to the device are offline. The DISPLAY M command might tell you that there are four paths online to the device. The DEVSERV PATHS command might tell you that there is actually only one online path. The DEVSERV command is more current and thus more accurate. See “DEVSERV command” on page 239 for information about the DEVSERV command.

Sending commands to systems in a sysplex

You can use the CONTROL V command to direct commands from a console to a specific system in a sysplex. The CMDSYS parameter on the CONTROL V command specifies which system receives all commands (not specifically routed elsewhere by the ROUTE command) entered from a particular console. See “CONTROL command” on page 217.

You can use the ROUTE command to send commands to be processed on other systems in the sysplex. See “ROUTE command” on page 606.

You can use the VARY CN command to specify from what systems in a sysplex a specified console receives unsolicited messages. Use the MSCOPE, AMSCOPE, and DMSCOPE parameters for purposes of control. See “VARY CN command” on page 926.

Some commands have an L=name parameter. You can use this parameter to specify the name of a console on a different system in the sysplex. These commands can communicate with the named console and receive messages from that system.

Using commands that have sysplex scope

Commands that have sysplex scope have the following characteristics:

- They affect resources that are shared throughout the sysplex. Examples of such resources include the Sysplex Timer, the coupling facility, couple data sets, and certain DASD volumes.
- You can issue them from any system in the sysplex; the results are identical.
- The results of issuing them are sysplex wide *without the need to use ROUTE *ALL*. You should not use any form of the ROUTE command to issue a command with sysplex scope because doing so is redundant. Here's why:
 - You use ROUTE to have a command issued on a particular system, group of systems, or all systems in the sysplex. Using the ROUTE command is the logical equivalent of walking up to a console attached to each system you route to, and issuing the command from that console.
 - You do not need to issue a command with sysplex scope on a particular system, group of systems, or all systems in the sysplex. You issue the command once from any system.

Note that a command can have sysplex scope when you use particular parameters, and not have sysplex scope when you use other parameters.

Commands that have sysplex scope are so noted in the documentation for that command, and include those in the following table. If a command has *All* under “Conditions”, then the command has sysplex scope under all circumstances and for all variations.

Table 2. MVS System Commands With Sysplex Scope

Command	Conditions
CHNGDUMP	Has sysplex scope only when all systems are connected to the same coupling facilities, and you specify ,SDUMP,SYSFAIL,STRLIST=.
CONTROL C,A	All
CONTROL C,D	Has sysplex scope only when you specify L=.
CONTROL M	Has sysplex scope only when you do not specify MLIM, UEXIT, LOGLIM, or APPLID.
CONTROL <i>other</i>	Other parameters of CONTROL have sysplex scope only when you specify L=.
DISPLAY CF	Has sysplex scope only when displaying information about the coupling facility and only for those systems connected to the coupling facility. Does not have sysplex scope when displaying an individual system's coupling facility configuration information (coupling facility channels and paths).
DISPLAY CNGRP	All
DISPLAY CONSOLES	Has sysplex scope unless you specify DISPLAY C,B or DISPLAY C,U.
DISPLAY DUMP	Has sysplex scope only when you issue the OPTIONS parameter to display the results of a CHNGDUMP ...SDUMP,SYSFAIL,STRLIST= command.
DISPLAY EMCS	Has sysplex scope, except when you specify STATUS=B or STATUS=ERR. When you specify STATUS=FULL, consoles from all systems will be displayed (for consoles that are not active on the system where this command is processed, some information will not be displayed).
DISPLAY GRS	Has sysplex scope unless you specify SUSPEND. Also, note the following about DISPLAY GRS,C and DISPLAY GRS,RES: the output generated by these commands includes both system-specific information (S=SYSTEM) and sysplex information (S=SYSTEMS). The S=SYSTEM information is valid only for the system on which you issue the command. The S=SYSTEMS information is identical regardless of the system on which you issue the command.
DISPLAY GRS,ANALYZE	Has sysplex scope for Enqs, but can be limited to a system. Note that D GRS,ANALYZE,LATCH only returns latch analyze information for the system the command is running in.
DISPLAY LOGGER	Has sysplex scope when you use either L or C,SYSPLEX options.
DISPLAY OPDATA	Has sysplex scope for the PREFIX operand, the MODE operand, and the MONITOR operand (except for SPACE and DSNAME, and all MONITOR operands issued from a TSO user).
DISPLAY PFK	Has sysplex scope only when you specify CN=.

Table 2. MVS System Commands With Sysplex Scope (continued)

Command	Conditions
DISPLAY R	Has sysplex scope, but the output might be different on different consoles, because the output of DISPLAY R is dependent on the routing criteria for the console specified by CN=. If you do not specify CN=, the routing criteria of the console issuing the command is used. If you issue the command in a program (by using the MGCRC macro) the console you specify in the macro is used. If you specify a console ID of 0, all retained messages are included in the command response.
DISPLAY WLM	All
DISPLAY XCF,ARMSTATUS	Has sysplex scope provided all systems are using the same ARM couple data set.
DISPLAY XCF,CF	Has sysplex scope provided all systems in the sysplex are connected to the same coupling facilities.
DISPLAY XCF,COUPLE	Has sysplex scope as long as all systems are using the same types of couple data sets, as specified on the TYPE parameter (SYSPLEX, ARM, CFRM, SFM, LOGR, and WLM.) If you do not specify the TYPE parameter, only system-specific data is displayed.
DISPLAY XCF,GROUP	All
DISPLAY XCF,POLICY	Has sysplex scope as long as all systems are using the same types of couple data sets, as specified on the TYPE parameter (ARM, CFRM, SFM, and LOGR.)
DISPLAY XCF,STRUCTURE	Has sysplex scope provided all systems in the sysplex are connected to the same coupling facilities.
DISPLAY XCF,SYSPLEX	All
MONITOR	Has sysplex scope only when you specify L=.
MOUNT	Has sysplex scope only when you issue the command against an automatically switchable tape device.
REPLY	All
RESET CN	Issue the command from the system where the console was active to avoid inconsistent sysplex results.
SEND	Has sysplex scope only when sending to consoles; does not have sysplex scope when sending to TSO users.
SET CNGRP	Has sysplex scope provided all systems are sharing the same parmlib data set.
SET CON	Has sysplex scope when adding a sysplex accessible console (SMCS, subsystem), or when changing the value that is associated with a sysplex scope CONSOLxx keyword.
SET DAE	Has sysplex scope only when all systems are sharing the same DAE data set and the same parmlib data set.
SET GRSRNL	Has sysplex scope only when all systems are sharing the same parmlib data set.

Table 2. MVS System Commands With Sysplex Scope (continued)

Command	Conditions
SET SMS	Has sysplex scope when you are issuing the command to change the name of the ACDS or COMMDS. All systems in the sysplex must be in the same SMS complex, and using the same parmlib data set. If you are issuing the command to start or restart SMS on a system, only the system on which you issue the command is affected.
SETCON DELETE	All
SETCON MODE	All
SETLOGR FORCE	Has sysplex scope when you use DELETE,LSName options.
SETSMS	Has sysplex scope only if you are changing the SCDS, ACDS, or COMMDS, and only if all systems in the sysplex are in the same SMS complex.
SETXCF FORCE	Has sysplex scope only when all systems are connected to the same coupling facility.
SETXCF COUPLE	Has sysplex scope only when you specify PSWITCH, ACOUPLE, or PCOUPLE, and all systems have access to the specified couple data set.
SETXCF START STOP	Have sysplex scope only when you specify POLICY or REBUILD.
STOPMN	Has sysplex scope only when you specify L=.
UNLOAD	Has sysplex scope only when you issue the command against an automatically switchable tape device.
VARY CN	Has sysplex scope unless all of the following are true: <ul style="list-style-type: none"> You issue VARY CN(<i>conspec</i>),ONLINE without specifying SYSTEM=. You do not specify SYSTEM= in the CONSOLxx parmlib member that defines this console. The console has never been active in the sysplex.
VARY SMS, STORGRP VOLUME	Has sysplex scope under these conditions only: <ul style="list-style-type: none"> You specify (<i>storgrp volume,ALL</i>) and all systems in the sysplex are in the same SMS complex. You specify (<i>storgrp volume system</i>) where <i>system</i> is a system group, and the system group exactly matches the sysplex (that is, none of the systems in the sysplex is explicitly defined to SMS).
VARY SWITCH	Logical partition cluster scope -- see the "Intelligent Resource Director" chapter in <i>z/OS MVS Planning: Workload Management</i> for more information.
VARY XCF	All
VARY WLM	All

Sharing system commands

MVS allows two or more systems in a multisystem environment to share commands while retaining unique values in those commands. When two or more systems share commands, you can view a multisystem environment as a *single system image* from which you can perform operations for several different systems.

This section explains how to share system commands in a multisystem environment, using:

- **System symbols**, which represent unique values in shared commands
- **Wildcards**, which identify multiple resource names in commands.

Using system symbols in commands

System symbols represent the values in shared commands that are unique on different systems. Each system defines its own values to system symbols, and replaces the system symbols with those values when processing shared commands.

To use system symbols in system commands, first see the section that describes system symbols in *z/OS MVS Initialization and Tuning Reference* to understand the types of system symbols, the elements that comprise them, and the general rules for using them. Second, see the section on sharing system commands in *z/OS MVS Planning: Operations* for information about planning to share commands. Then read the rest of this section.

Display static system symbols: You can enter the DISPLAY SYMBOLS command to display the static system symbols and associated substitution texts that are in effect for a system. See “Displaying static system symbols” on page 454 for more information.

Know the rules for using system symbols: The system enforces the following rules when you use system symbols in system commands. They apply *in addition* to the general rules for system symbols that are described in *z/OS MVS Initialization and Tuning Reference*.

1. Substitution in a command begins after the command name. This means that you cannot use symbolic variables to resolve to a command prefix or to a command name. The command “&Asyspref &mycmd” would result in an error message, for example.
2. If the issuing console has command association (CMDSYS) to another system, the issuing system first transports the command to the associated system. Substitution of any symbolic variables takes place on the receiving system.
3. If a command has a prefix defined with the command prefix facility (CPF), the issuing system first transports the command to the system defined for that prefix. Substitution of any symbolic variables takes place on the receiving system.
4. After echoing and logging a command, the system examines the command name. Certain commands receive special treatment:
 - The system will not perform substitution for symbolics in a VARY CN(*),ACTIVATE command.
 - A DUMPDS command will not undergo substitution. The DUMPDS command processor handles its own substitutions, at the time when it actually takes a dump.
 - For security reasons, the LOGON command does not support symbolic substitution.
 - For a REPLY command, substitution of any symbolic variables in the reply text takes place on the system originally issuing the WTOR.

However, if the WTOR is synchronous (SYNCH = YES was specified, and the synchronous WTO/R service displays the WTOR), the system does not perform substitution of the reply text.

But, if the system issues the WTOR early during the initial program load (IPL), that is, while the nucleus initialization program (NIP) is still in use:

- The system performs substitution after it processes the requested symbolics it reads from the parmlib. This means that the system *will* substitute symbolic variables in replies to WTORs it issues **after** issuing the IEA347A SPECIFY MASTER CATALOG PARAMETER message.
- The system will not issue message IEE295I for NIP-time replies that are changed by symbolic substitution. Message IEE600I will reflect the changed text.
- For a ROUTE command, the system issuing the command performs the substitutions up through the specification of the destination system(s). Each destination system completes the substitution of the text for the command. For example, if you code the command

```
RO T=&T1,&SYSGRP1,F JOB&SYSCLONE,parms
```

the system issuing that ROUTE command will substitute the variables &T1 and &SYSGRP1

and each system in the system group that &SYSGRP1 names will issue the command

```
F JOB&SYSCLONE,parms
```

and each of those receiving systems will substitute its own value for &SYSCLONE. See "Using System Symbols in ROUTE Commands."

- You cannot use symbolic variables on an "L=" operand to aggregate the command response when sending a command to more than one system. The system will not substitute for the "L=" operand.
 - For commands other than REPLY and ROUTE, the system issuing the command performs the substitution for the text after the command name, including comments.
5. You cannot use system symbols in commands that control batch jobs. Consider converting batch jobs to started tasks, which *can* specify system symbols.
 6. If substitution results in changing any command text, the system logs the "new" text again and issues message IEE295I.

The system makes the original (pre-substitution) command text available to the command installation exits and the subsystem interface (SSI). However, current programs, if not modified, will see the substituted text.

When the system calls the command installation exits or SSI, if those exits make any change to the command text, the system logs them again and issues message IEE295I. However, it does not perform substitution again. It frees the original command text, which means that it is no longer available in the system.

Cautions in using system symbols: The preceding rules mean that some forms of command input will probably not produce the results you want:

1. Symbolic variables before or in a command name remain unsubstituted. The system will process the command with the "&variable;" in the text, and probably generate a "COMMAND INVALID" error message.
2. If a command exit changes the text and adds a new symbolic variable, the system executes the command before substituting for the variable.
3. The following considerations apply when a command affects systems other than the one issuing it:
 - Except for REPLY, the substitution will reflect the issuing system. For example, if

SYSVAR1 = (1,2)

on the system issuing the following VARY command, but

SYSVAR1 = (3,4)

on a system with the console "consname" attached, the command

VARY CN(consname),ROUT=&SYSVAR1

would result in the console "consname" receiving codes 1 and 2. If this (unlikely) command is what you want, you should ROUTE it to the system with consname attached.

- The same logic applies to commands that accept the "L=name-a" parameter, that is, where you want the command output messages directed to a console (and display area) other than the one issuing the commands. Substitution of symbolic variables in commands occur on the systems where the commands are issued, not where the "L=" console is attached.
- Do not use symbolic variables in the "L=" parameter on the ROUTE command. See the ROUTE command description in this manual.
- Understand the implications of using system symbols in commands that flow through several systems in a multisystem environment. See "Sharing Commands That Flow Through Multiple Systems" in *z/OS MVS Planning: Operations* for more information.

Determine where to use system symbols: System symbols offer the greatest advantage when two or more systems require different resources. This section provides examples of how to specify system symbols when naming resources in system commands.

Data sets:

Assume that you want to display, on all systems in a sysplex, the local page data sets that fit the following naming convention:

SY&SYSCLONE..PAGE.LOCAL

Instead of entering a different command to display the unique page data sets on each system, you could enter the following command to display all the data sets that fit the naming convention:

ROUTE *ALL,D ASM,PAGE=SY&SYSCLONE..PAGE.LOCAL

When each system processes the command, it substitutes the text that it has defined for the &SYSCLONE system symbol. For example, if a sysplex consists of two systems named SYS1 and SYS2, accepting the default value for &SYSCLONE produces the following data sets:

D ASM,PAGE=SYS1.PAGE.LOCAL on system SYS1

D ASM,PAGE=SYS2.PAGE.LOCAL on system SYS2

Jobs:

When specifying system symbols in the source JCL for job names, first determine if the jobs run as batch jobs or started tasks. If a job is a started task, you can specify system symbols in the source JCL. If a job runs in batch, you cannot specify system symbols in the source JCL; consider changing the job to run as a started task.

Then, if a started task is to have multiple instances, determine if you want the started task to have a different name for each instance. If each instance of a task has a different name, your installation can easily identify the system on which each instance runs.

For started tasks, you can also specify system symbols on the `JOBNAME` parameter on the `START` command that starts the task. For more information about using system symbols in `START` commands, see “`START` command” on page 881.

Using wildcards in commands

Wildcards allow you to use a single specification to indicate a number of resources whose names match the wildcard pattern.

System commands use three kinds of wildcards:

- **Multiple-character trailing asterisk (*)**: The * indicates zero, one, or more characters, up to the maximum length of the string. This * must be at the end and cannot appear alone. For example, `ABC*` matches `ABC` or `ABCVWXYZ` or `ABC1` or `ABCZZZ`. Use this wildcard in:

- `CANCEL`
- `DISPLAY`
- `MODIFY`
- `SETPROG`
- `SLIP` parameters, as indicated in their descriptions
- `STOP`

- **Multiple-character asterisk (*) within the value**: The * indicates zero, one, or more characters, up to the maximum length of the string. This * can be in any position and can appear alone to indicate all values. For example:

- `A*BC` matches `ABC` or `ACBC` or `AWXYZBC` or `A3BC`
- `*` matches all values
- `*BC` matches `BC` or `WXYZBC` or `ZZZBC`

Use this wildcard in the `JOBLIST` and `DSPNAME` parameters of the `SLIP` command.

- **Single-character question mark (?)**: The ? indicates any single character. The ? can be in any position. For example:

- `A?C` matches `ABC` or `A1C`
- `ABC?E??` matches `ABCXEYZ` or `ABC1E23`
- `?BC` matches `ABC` and `ZBC`

Use this wildcard in `SLIP` parameters, as indicated in their descriptions.

In some `SLIP` command parameters, you can use more than one type of wildcard. For example:

- `A?C*` matches `ABC` or `AXCYZ` or `A5CZ2`
- `A*C?` matches `ABCD` or `AZZZZC1` or `A123CZ` or `ACD`

You can use wild cards to reduce the number of system commands needed for a task. For example, you can enter one command to display information about all jobs and started tasks beginning with the characters `XYZ`:

```
DISPLAY A,XYZ*
```

Setting the time and changing the system parameters

Using the SET command, you can set the local time and date and change some system parameters. See “SET command” on page 620.

Using the system restart function

You can use the system restart function to:

- Restart the system after you have entered a QUIESCE command. (See “Quiescing the system” on page 55.)
- Restart the system from a restartable wait state that is specified in *z/OS MVS System Codes*.
- Restart the system when it behaves abnormally and you cannot terminate the suspected unit of work with the CANCEL or FORCE commands. A system behaving abnormally may be one that enters a nonvalid wait state or a disabled loop. A nonvalid wait state exists when the wait state code in the PSW (IC) is not listed in *z/OS MVS System Codes* and is not in the range of wait state codes (FF0-FFE) reserved for other authorized applications. Symptoms of a disabled loop are:
 - Nonproductive processing occurs and the PSW (IC) frequently displays the same addresses.
 - All I/O and external interrupts are masked off for the system.

System restart procedure

To initiate the system restart function press the RESTART key on the hardware operator's console or specify one of several restart actions on an operator frame. Refer to the hardware documentation for your system for more detailed information about your configuration. If the system has been quiesced or is in a valid restartable wait state, the system restarts and continues processing the interrupted unit of work. If the system had not been quiesced or is not in a valid restartable wait state then, depending upon your system configuration, the system displays either message IEA502A or BLW004A.

If the system does not recover as a result of your restart actions, follow your installation's procedures for recording system problems. When you have recorded the system information, consult with your system programmer before taking further action.

Responding to IEA502A

Reply reason code '0' when you suspect that a unit of work is causing a wait state that is not valid or a disabled loop and you cannot terminate the suspected unit of work by using the CANCEL or FORCE commands.

1. The system displays message IEA500A and waits for operator response. IEA500A supplies information about the unit of work in progress.
2. Reply ABEND to abnormally terminate the interrupted program and invoke the necessary recovery routines if the information describes the unit of work you suspect has a problem.
3. Reply RESUME to end further restart processing and allow the interrupted work to continue if the information does not describe the unit of work that you suspect has a problem.

Repeat this process of invoking restart with REASON 0 until you interrupt the work you suspect. Only then should you reply ABEND to abnormally terminate the current work.

Note: The system terminates the work in progress without displaying any information about it if you request the restart function with REASON 0 on a processor that cannot communicate with an operator.

Reply reason code '1' when you suspect a system problem that is not related to the work currently in progress. The system diagnoses and repairs some problems that might be causing it to behave abnormally. Among its actions, the system:

- Makes itself dispatchable.
- Checks the number of message buffers. The system notifies you if the maximum number of buffers has been exceeded.
- Checks system activity. The system notifies you if there are no batch jobs or time-sharing users.
- Restarts I/O on all channel paths.
- Checks and repairs critical data areas.

Note: Using reason code '1' might cause the system to immediately terminate some address spaces. Use reason code '1' only under the direction of a system programmer.

Normally, the system notifies you of anything it diagnoses or repairs when you request the restart function with reason code '1'. You only get this information on a processor that can communicate with an operator.

Responding to BLW004A

The system displays message BLW004A and waits for operator response. BLW004A supplies information about the unit of work in progress.

1. Reply ABEND to abnormally terminate the interrupted program and invoke the necessary recovery routines if the information describes the unit of work you suspect has a problem.

Repeat this process of invoking restart procedure replying to BLW004A until you interrupt the work that has the problem.

2. Reply RESUME to end further restart processing and allow the interrupted work to continue if the message indicates that there are no batch jobs or time-sharing users.
3. Reply RESUME to end further restart processing and allow the interrupted work to continue if the message indicates that the WTO buffer limit has been exceeded.
4. Reply REPAIR if you suspect a system problem that is not related to the work currently in progress. The system diagnoses and repairs some problems that might be causing the abnormal behavior.

Note: Replying REPAIR might cause the system to immediately terminate some address spaces. Reply REPAIR only at the direction of the system programmer.

Activating a workload management service policy

You can use the VARY WLM command to activate a named service policy for a sysplex. The service policy must be defined in the workload management service definition and must have been previously installed on the WLM couple data set.

You can also activate a workload management service policy by using the online ISPF administrative application. Refer to *z/OS MVS Planning: Workload Management* for more information or see your service administrator.

This command activates the named service policy on all systems in the sysplex.

For complete information on how to use the VARY command to activate a workload management service policy, see “Activating a service policy” on page 973.

Controlling time-sharing

Time-sharing allows programmers at remote terminals to develop, test, and execute programs without the turnaround delays that occur when they submit jobs to a computer center. With time-sharing, a large number of jobs can share the resources of a system concurrently, and remote terminal users can exercise primary control over the execution of their jobs. Therefore, we can define time-sharing as the shared, conversational, and concurrent use of a computing system by a number of users at remote terminals.

Time-sharing in z/OS is provided by TSO/E. For more information about TSO/E see *z/OS TSO/E User's Guide*.

You can display information about logged-on time-sharing users by using the DISPLAY command. You can keep track of terminal users logging on and off the system by using the MONITOR command. In response to the MONITOR command, the system displays the user id for each LOGON and LOGOFF. To stop the system's monitoring of terminal use, issue the STOPMN command.

To communicate with time-sharing users you can use the SEND command to:

- Send messages to specific users or all users who are receiving messages
- Send messages to specific users or to all users logging on to the system
- Save messages in the broadcast data set
- List messages in the broadcast data set
- Delete messages from the broadcast data set

The broadcast data set, SYS1.BROADCAST, has mail and notices sections.

Controlling jobs

A job is the basic unit of work for the system. Job control language (JCL) identifies a job to an operating system and describes the job's resource requirements. The JOB JCL statement identifies a job's beginning and contains such information as:

- Job name
- Job account number
- Job class
- Job priority.

Using job-related commands, you can start, stop, or cancel a job. You can also modify a job's parameters and restart a job that has failed. There are two kinds of jobs in the system: queued jobs and jobs that are selected on demand. Queued jobs are managed by JES. Jobs that are selected on demand (referred to as demand-selected) are created as the result of START, MOUNT, and LOGON commands.

Starting a job

Using the START command, you can start jobs from the console. You can also use the START command to cause the JES internal reader facility to read a job from a tape or direct access volume.

Stopping a job

Using the STOP command, you can stop a job if the programmer has coded a stop routine in the program.

Cancelling a job

Using the CANCEL and FORCE commands, you can cancel a job that is executing. If the job is not currently executing, use a subsystem command to cancel it.

Passing information to a job

Use the MODIFY command to pass information to a job. This information may be used by the currently running program. Note that you can only pass information that is already defined in the currently running program.

Note to Programmers: For more information, see the section on communicating with a program using EXTRACT or QEDIT in *z/OS MVS Programming: Authorized Assembler Services Guide*.

Restarting a job

Once a job is executing, it might end abnormally because of a hardware, programming, or system error. This might happen any time during program execution. Valuable machine time would be lost if an abnormal end occurred during one of the last job steps of a multistep program or in the middle of a long job step, and execution had to start again at the first job step. There are two ways of avoiding this problem: automatic restart and deferred restart.

For JES2 jobs and JES3 jobs, the checkpoint/restart feature of the system allows a job that ends abnormally to restart either at the beginning of a job step or at a checkpoint within the current step. The programmer submitting the job provides for an automatic restart or a deferred restart.

Automatic restart

If the programmer submitting the job has provided for an automatic restart and the job ends abnormally, you receive the following system message:

```
* id IEF225D SHOULD jobname.stepname.procedure checkid RESTART
```

This message allows you to prevent repeated restarts at the same checkpoint or job step.

When this message appears, use the REPLY command to respond YES, HOLD, or NO, as follows:

- Reply YES if the restart is to be performed at a specific checkpoint or job step for the first time. (If it is a job step restart and the step to be restarted used a card input data set that was not part of the SYSIN stream, you must return to the appropriate hoppers all cards read by the job step before it ended abnormally. If it is a checkpoint restart, follow the programmer's instructions for replacing the input cards.)
- Reply HOLD if you want to defer the restart: for example, to permit another job to run first. You must issue the appropriate subsystem command when you are

ready to restart the job. Also, if you want, you can cancel the job. However, cancelling the job can cause unrecoverable paging space or the failure of certain data sets to be deleted if the job was using virtual I/O.

- Reply NO if a restart at a specific checkpoint or job step has been requested repeatedly. When your reply is NO, and the programmer wants a restart to be performed, he must resubmit the job for a deferred restart.

If the programmer specifies VIRTUAL=REAL (V=R), the job is processed entirely in central storage; it is not paged out. For a V=R job, the restart might be delayed while the system waits for the allocation of storage. If another job is using the required storage, you get no message, only a delay. Enter the DISPLAY A,L command to see if a system task or another job is using the storage required by the job with a V=R region. You can then stop or cancel the conflicting task or job.

Note: Any operator commands in the input stream of the job step being restarted are not executed.

Deferred restart

If the programmer submitting the job has provided for a deferred restart and the job ends abnormally, the programmer must resubmit the job for the deferred restart. To restart the job, the programmer must provide a restart deck for submission to the system through the system input reader. The JCL statements to be included in the restart deck are described in detail in *z/OS MVS JCL User's Guide*.

If you change the device configuration of your system after a job ends abnormally, restart the job carefully. For example, enough devices must be available to satisfy the needs of the job step being restarted. The system under which a step restart is run need not be the same as it was for the job's original execution. However, a checkpoint restart should be run under the original system unless the alternate system can meet the following restrictions:

- The job entry subsystem is the same.
- The release number is the same.
- The link pack area modules in use at the checkpoint reside in the same storage locations.
- An area of storage identical to the original area is available to a V=R job.

If the required storage is not available, the system cancels the restart and you receive the following message:

```
IEF209I VIRTUAL STORAGE UNAVAILABLE FOR jobname.stepname.procedure
```

Required storage might not be available for one of the following reasons:

- The link pack area expands into the required storage. This expansion can occur if an IPL has been performed between the original execution of the job and the restart. If it does occur, contact your system programmer for a respecification of the system parameters and reIPL using the new values.
- The system storage area expands into the required storage. When this expansion occurs, contact your system programmer for a respecification of the SQA and CSA system parameter and reIPL using the new values.

When a job restarts correctly, you receive two messages: IEF006I JOB RESTARTING and IEF008I JOB RESTARTED. If, for V=R jobs, these messages do not appear, enter DISPLAY A,L to see if a system task or other job is using the required storage. You can then stop or cancel the conflicting job. The system might ask you

to mount data volumes other than those required at the beginning of the job. In addition, any card input data sets that have been used by the failing job step must again be made available to the system.

For more information on deferred restart, see *z/OS DFSMSdfp Checkpoint/Restart*.

Controlling started tasks

A started task, like a job, is a basic unit of work for the system. However, started tasks differ from jobs in that started tasks are always demand-selected; that is, the operator or a program must take action to initiate a started task.

There are several ways to initiate started tasks:

- With a START command, described in Chapter 4 of this book.
- Via TSO/E logons. For information on using TSO/E logons, refer to the TSO/E publications.
- With ASCRE (address space create) macros in programs. For information on how to use the ASCRE macro, refer to *z/OS MVS Programming: Extended Addressability Guide*.

Both the START command and the ASCRE macro create an address space. A START command and an ASCRE macro started via a START command each will look for a program that has a procedure in SYS1.PROCLIB; that program will be the first to run in the ASCRE-created address space. Essentially, using ASCRE is similar to a started task.

For a started task, the system:

- Locates the JCL that starts the task
- Defines the task's address space
- Processes the JCL.

For a started task, operators can do the following:

Task	For information, refer to:
Cancel the started task	"CANCEL command" on page 174
Display status about the started task	"DISPLAY command" on page 261
Force the started task	"FORCE command" on page 517
Modify the started task	"MODIFY command" on page 532
Name the started task	"START Command" "Starting a system task from a console" on page 882 (JOBNAME= parameter)
Start the started task	"START Command" "Starting a system task from a console" on page 882
Stop the started task	"STOP command" on page 899

Controlling system information recording

The system records information that is later used for billing, accounting, or diagnostics. Among the facilities that record system information are:

- System management facilities (SMF)
- System trace

- The generalized trace facility (GTF)
- Master trace
- Component trace
- The logrec recording medium

The system also records information in the system log and/or the operations log. See *z/OS MVS Planning: Operations* for more information.

In addition to these facilities, JES2 and JES3 have their own event trace facilities. These trace facilities are described in detail in *z/OS JES2 Commands* and *z/OS JES3 Commands*.

System management facilities

System management facilities (SMF) consists of system routines and optional user-written exit routines that collect, format, and record system and job-related information.

The information gathered by SMF and user-written exit routines is recorded on direct access volumes in one of the SMF data sets. These data sets, called primary and secondary data sets, must be online at system initialization. At that time, SMF uses the primary data set as the active recording data set unless it is full. If the primary data set is full, SMF checks each data set in the order it is listed until it finds one that is not full. SMF then uses this data set as the active recording data set and requests that the operator dump all data sets that are not empty.

When the active recording data set becomes full, SMF automatically switches recording from the active SMF data set to an empty secondary SMF data set, passes control to the SMF dump exit, IEFU29, and issues a message to indicate that the data set needs to be dumped. Use the SMF dump program, IFASMFDP, to dump the full SMF data set and to reset the status of the dumped data set to empty so that it can be used again for recording.

Error Recovery:

If an I/O error occurs while SMF is writing to one of the SMF data sets, you receive a message and SMF switches to one of the empty secondary data sets.

Switching the SMF Data Sets:

To prepare an SMF data set for dumping *before* it becomes full, the operator normally uses the SWITCH SMF command to switch from the current data set to another data set. For the switch to be successful, there must be an inactive data set that is empty. Therefore, use the DISPLAY SMF command to verify that there is at least one alternate data set before issuing the SWITCH or HALT command.

The HALT EOD command also prepares an SMF data set for dumping, but use it only when you intend to quiesce the system in preparation to shut down. Do not use HALT when you intend to keep the system running. HALT EOD will close the system log and stop SMF recording.

Restarting SMF:

Because SMF runs in its own address space, you can restart SMF with the SET SMF command. When you enter that command, this message appears:

```
IEE980I SMF IS BEING RESTARTED
```

When the restart is complete and recording starts, the following message appears:
IEE360I SMF NOW RECORDING ON SYS1.MANx

If the SET SMF command abends while updating the SMF parameters, it might be necessary to terminate the SMF address space and restart SMF. If the system programmer determines that it is necessary to terminate the address space, issue:
FORCE SMF,ARM

To restart SMF after the SMF address space terminates, issue the SET SMF command again, specifying a SMFPRMxx parmlib member containing different parameters.

System trace

System trace is a part of the operating system that records, for diagnostic purposes, events that occur during system initialization and operation. To record events, system trace provides three types of tracing: address space, branch, and explicit tracing. System trace can be used between subsystem initialization and the start of the generalized trace facility (GTF). For information on controlling system trace, see “TRACE command” on page 910.

The generalized trace facility

The generalized trace facility (GTF), like system trace, gathers information used to determine and diagnose problems that occur during system operation. Unlike system trace, however, GTF can be tailored to record very specific system and user program events. For information about starting and stopping GTF, see “START command” on page 881 and “STOP command” on page 899. For information about using GTF, see *z/OS MVS Diagnosis: Tools and Service Aids*.

Master trace

Master trace is a diagnostic aid that maintains a trace table of console messages in virtual storage. When master trace is active, the master trace table is embedded in dumps that have the TRT option or contain the master scheduler's private address space. Master trace can eliminate the need to submit a portion of the system log to IBM if there are problems in message processing. It also can ensure that the messages accompanying a dump are the ones that correspond to the problem. The TRACE command controls master trace. For a more detailed description of master trace, see *z/OS MVS Diagnosis: Tools and Service Aids*.

Component trace

Component trace is a diagnostic aid that system programmers can use to trace the action of certain system components. Component trace enables the programmer to use the TRACE command to start and stop component trace. The components that use the component trace command must first invoke the define component trace service and define the name of the component requesting the service and the name of the start/stop routine that will get control when the TRACE operator command is issued.

Logrec recording medium

| When an error occurs, the system records information about the error in either the
| logrec data set or a logrec log stream. The diagnostic information provides a
| history of all hardware failures, selected software errors, and selected system
| conditions.

Use the records in the logrec data set or the logrec log stream as a companion to dump data. The information in the records will point the system programmer in the right direction while supplying symptom data about the failure.

For more information about log streams, see *z/OS MVS Setting Up a Sysplex*. For more information about initializing a logrec data set or setting up a logrec log stream, see *z/OS MVS Diagnosis: Tools and Service Aids*.

Controlling automatic tape switching

In a sysplex, there are MVS operational considerations for two types of tape devices:

- A **dedicated tape device** is varied online to one system at a time. For a second system to use that same device, an operator issues VARY commands (first VARY OFFLINE, then VARY ONLINE) to make the device available to the second system.
- An **automatically switchable tape device** can be online to more than one system at a time. For one system to use an automatically switchable tape device, then another system to use the same device, an operator does not have to issue any VARY commands. In many ways, automatically switchable tape devices are similar to JES3-managed devices. They require that the systems in the sysplex communicate with each other.

Through system commands, the operations staff plays a key role in setting up and maintaining automatic tape switching (that is, using automatically switchable tape devices). For example, a device is automatically switchable after the following operational actions are taken:

1. The device is defined as automatically switchable.
The VARY AUTOSWITCH command, as described in “Defining automatically switchable devices,” turns the AUTOSWITCH attribute on and off.
2. The device is varied online through the VARY ONLINE command.
3. Before z/OS Release 2, the connection between participating systems and the coupling facility is active and an IEFAUTOS structure is defined in the active coupling facility resource management (CFRM) policy.

Systems in a sysplex store the status of online automatically switchable tape devices in IEFAUTOS.

With z/OS Release 2 and higher, the ATS STAR design improves the availability and system management characteristics of the previous automatic tape switching function. ATS STAR does not use the IEFAUTOS structure but instead uses global resource serialization and XCF services to maintain serialization when it allocates shared tape devices. To maximize the performance of the ATS STAR function, use the global resource serialization STAR configuration rather than the ring configuration.

Defining automatically switchable devices

To define a device as automatically switchable, the device must be in a varied-offline state. Use the following command:

```
VARY device,AUTOSWITCH,ON
```

The detailed description of this command is in “Defining a tape device as automatically switchable” on page 940.

The AUTOSWITCH definition lasts for the duration of the IPL. Only if the device has been defined through HCD does the definition persist longer than the duration of the IPL. If HCD turns the attribute on, and the VARY AS command turns the attribute off, the attribute will be on again at the next reIPL.

The ESCON manager and the IEEVARYD programmable interface can also set the AUTOSWITCH attribute on and off.

Displaying information about automatically switchable devices

The DISPLAY U,,AUTOSWITCH command summarizes the status of automatically switchable devices. The display includes the following information:

- The name of the system to which the device is allocated
- The name of the job
- Volume serial number, if one is mounted and the device is allocated.

If a device is offline to the issuing system, the display shows “OFFLINE” in the status field and the display provides no other information about the device.

The following example shows information that appears in response to DISPLAY U,,AUTOSWITCH. Ten devices are defined automatically switchable in the sysplex. Four of those devices (identified by “A” in STATUS column) are allocated to jobs running on SYS5 and SYS6; two of the devices (identified by “OFFLINE” in the STATUS column) are varied offline to the issuing system; and the status of the other four devices is not known.

```

- d u,,as
IEE343I 12.24.59 UNIT STATUS      FRAME LAST  F   *E  SYS=ALLOCS
UNIT  TYPE  STATUS  SYSTEM  JOBNAME  ASID  VOLSER  VOLSTATE
05A8  348S  A       SYS5    TAPE02   0012          PUB/REMOV
05A9  348S  A       SYS5    TAPE02   0012          PUB/REMOV
05AA  3480  OFFLINE
05AB  3480
05AC  3480          /REMOV
05B8  349S  A   -CA  SYS6    TAPE01   012E          PUB/REMOV
05B9  349S  A       SYS6    TAPE01   012E          PUB/REMOV
05BA  3490  OFFLINE
05BB  3490          /REMOV
05BC  3490          /REMOV

```

Figure 2. Example of a Successful Response to a DISPLAY AUTOSWITCH Command

The syntax of the DISPLAY U,,AUTOSWITCH command is in “Displaying device status and allocation” on page 460.

If you want to find out the status of a device that is assigned to a nonparticipating system, issue the DISPLAY U,,, command on each system that could have varied the device online, including the participating systems.

Interacting with system functions

Most resource allocation, error recovery, and system monitoring functions in MVS are automatic. Sometimes, however, the system requests your assistance, takes certain actions that you must understand and/or correct, or issues messages that make you aware of internal processing. So that you can plan your actions carefully and respond appropriately to system messages, you need to know how to interact with the following system functions:

- Device allocation

- Hot I/O detection
- Device boxing

Device allocation

Device allocation is the assignment of input/output devices and volumes to job steps. Requests for device allocation come from data definition (DD) statements and dynamic device allocation requests.

Data definition (DD) statements can be entered into the system by:

- Job input to the JES reader
- Jobs submitted through the TSO SUBMIT command
- Started tasks
- The MOUNT command
- TSO LOGONs
- APPC transactions

Dynamic device allocation/unallocation requests, in contrast, originate within executing programs.

While performing device allocations, the system might ask you to:

- Mount or dismount volumes
- Make decisions (for example, to bring a device online immediately or to wait)

To control the amount of work you have to do related to device allocation, you might want to restrict device allocation requests.

To control device allocation requests from data definition (DD) statements, you might restrict each of the forms of input for these statements (for example, by holding the reader, or by setting a maximum LOGON count). Because they originate within executing programs, however, you cannot control dynamic device allocation/unallocation requests.

Device assignment

Operationally, the assignment of devices is influenced by:

- The online/offline status of the device. Generally, to be allocated to job steps, devices must be online. Exceptions are (1) when the online test executive program (OLTEP) or a similar testing program is running and (2) when teleprocessing devices are allocated. You can bring offline devices online with the VARY command or in response to the allocation recovery message, IEF238D.
- The MOUNT attribute. The MOUNT attribute, which applies only to tape or DASD devices, is influenced by the MOUNT and UNLOAD system commands, and, during initialization, by entries in the VATLSTxx parmlib member. Allocation requests that can be satisfied by mounted devices are processed quickly and without your intervention.
- The USE attribute. A parameter of the MOUNT command, the USE attribute affects the type of data sets that can be allocated on a tape or DASD volume. The USE attribute can also be set during initialization by entries in the VATLSTxx member of parmlib. Having a proper mix of volumes with various USE attributes reduces the amount of volume mounting.

The information from data definition (DD) statements determines the input/output resources to assign to a job or job step and the volumes that are required. If a requested volume is not mounted, the system issues a mount message asking you

to mount a specific volume or scratch volume. If you mount the wrong volume, the system finds out as soon as it reads the volume label. The system unloads the volume and repeats the mount message.

When you know that several jobs are going to need a volume, use the MOUNT command to reserve that volume on a device. Allocation processing is faster when the required volume is reserved rather than removable. The system does not demount volumes reserved by a MOUNT command until you issue an UNLOAD command.

Note: Do not use the MOUNT command for devices managed by JES3. See *z/OS JES3 Commands*.

Never mount a blank tape volume unless specifically directed to do so because the system scans the entire volume for a tape label and this scanning wastes time. If an unlabeled tape is needed, write a tapemark to avoid unnecessary scanning. After you mount the tape volume and ready the drive, the system reads the volume label. If an incorrect volume is mounted, the system unloads the incorrect volume and repeats the mounting message.

Note:

1. Occasionally, you receive two mount messages for the same volume, one starting with IEF and the other with IEC. Treat the two messages as though they were one. The second is a reminder.
2. When referring to I/O devices in the *devnum* parameter of system commands, use the unique 3-digit or 4-digit device number for each device. You can precede the device number with a slash (/). The slash is optional on many commands, but required for 4-digit device numbers on some commands, such as MOUNT and START.
3. Your installation can define symbolic group names of one to eight characters to be used by programmers in data definition (DD) statements. The number of devices associated with a symbolic name can range from one to the total number of devices in your installation. The symbolic name allows the devices to be grouped according to the attributes your installation considers significant. Do not use these symbolic names in system commands.
4. Make sure there are sufficient work volumes available to satisfy requests for temporary data sets at peak loads. A shortage of work volumes can cause the system to request additional scratch volumes. Balance work volumes across channel paths to increase system efficiency.

Automatic volume recognition

Automatic volume recognition (AVR) allows you to mount labeled volumes on unused drives not managed by JES3. The system recognizes and remembers these volumes, and assigns the drives to later job steps as required.

Device allocation and system commands

Many system commands run in the master scheduler's address space. Some of these commands allocate data sets as part of their processing.

The TIOT size for the master scheduler address space is 12K, which allows for approximately 600 unit allocations. Data sets that reside on multiple volumes or that have a data class with a dynamic volume count greater than 1 use more TIOT space than single volume data sets, reducing the number of data sets that can be allocated.

| For more information about TIOT space calculations, see the description of the
| TIOT SIZE parameter for the ALLOCxx parmlib member in *z/OS MVS Initialization
| and Tuning Reference*.

Hot I/O detection

Hot I/O refers to the repeated I/O interruptions that result from hardware malfunctions. Because it can cause the system to loop or to fill the system queue area with I/O control blocks, hot I/O needs to be detected quickly and corrected.

When the number of repeated interruptions exceeds an installation-defined threshold value, the system assumes there is a hot I/O condition. If your installation has set up hot I/O recovery defaults that the system can use, the system issues message IOS109E and attempts to recover from the hot I/O condition. (See the IECIOSxx parmlib member in *z/OS MVS Initialization and Tuning Reference*.) If your installation has not set up hot I/O recovery defaults, the system issues one of the following messages, if possible, or loads one of the following restartable wait states and prompts you to take action:

```
IOS118A or IOS111D - HOT NON-RESERVED DIRECT ACCESS DEVICE  
(Wait state 111)  
IOS119A or IOS112D - HOT RESERVED DIRECT ACCESS DEVICE  
(Wait state 112)  
IOS117A or IOS110D - HOT NON-DIRECT ACCESS DEVICE  
(Wait state 110)
```

When you take action, try to solve the problem at the lowest possible level. That is, try to correct the problem at the device first and then at the control unit. You could power the device off and on. If that does not help, you could reset the control unit if the affected device is not a direct access device. If these actions do not correct the problem, you might have to physically disconnect the device or control unit.

Whatever action you take, tell the system what you are doing by responding to the prompting message or restartable wait state. See *z/OS MVS System Messages, Vol 9 (IGF-IWM)* for information about IOS messages, and *z/OS MVS System Codes* for a detailed explanation of the restartable wait states and your response to them.

“Hot I/O” on page 68 describes how z/OS handles a hot I/O condition.

Device boxing

In certain error recovery situations and in response to certain commands, the MVS system can “box” an I/O device. Once a device enters a boxed state, the system:

- Immediately terminates I/O in progress on the device
- Rejects future I/O requests (by a user or by the system) to the device as permanent I/O errors
- Rejects any attempts to allocate the device
- Puts the device in pending-offline status

The system boxes a device:

- When it detects hot I/O on the device and the device cannot be recovered
- When, because of a channel path error, it takes the last path to the device offline
- When, because of a channel path error, it releases a reserve or assign on the device
- When it releases an unconditional reserve for the device

- When you issue a VARY OFFLINE command with the FORCE option for the device
- When you issue a CONFIG OFFLINE command with the FORCE option for a channel path, and the command releases a hardware reserve or assign, or removes the last path to the device

Note:

1. Because you might release a reserve or assign on a device and cause a data integrity exposure, be sure to use the VARY OFFLINE and CONFIG OFFLINE commands with FORCE only in emergency situations.
2. When you fix whatever caused the system to box a device, you can take the device out of the boxed state at any time by issuing VARY device ONLINE. Once the VARY command takes effect, the device is again available for IOS and any subsequent allocations (i.e., an allocation done in another step or job, or another dynamic allocation). Note that after the VARY command takes effect, the device is not considered for the current allocation.

You can make a boxed alias unit control block (UCB) of a parallel access volume available using the DEVSERV, QPAVS command.

3. You cannot take a boxed device out of the boxed state by replying with the device name to the allocation recovery message, IEF238D.

Boxed device - operator actions

Device *boxing* is used by the MVS system during error recovery as a means of maintaining data integrity and preventing data corruption. A device is also boxed if the operator issues the VARY devnum,OFFLINE,FORCE command. When a device is boxed, all outstanding I/O operations for the device are ended with *permanent error* status, and no new allocations to the device are allowed.

It is very important to understand that in the case of shared DASD, the boxed device is boxed only to the system that originated the boxing. The device is still accessible from other systems. **This may lead to incorrect (or incomplete) data on the DASD volume.** Such a situation must be reported to the owner of the data on the boxed-DASD.

- If the data-files are shared with other systems, it is recommended to put the device in offline status on all the sharing systems. Use VARY OFFLINE or OFFLINE,FORCE commands.
- After the data sets are checked and recovered, the DASD volume may be put back online.

A device that is boxed *and offline* can be brought back online with the VARY devnum,ONLINE command. This will enable the UCW and perform online processing to the device. Assuming that the error condition has been resolved, the device will come online. If the error condition still exists, the device may remain in the boxed state.

A device that is *allocated boxed* may be brought back online with the VARY devnum,ONLINE,UNCOND command, if account procedures allow. Note that in this case, if the boxed device is DASD, volume verification (that is, VOLSER checking) is **not** performed. In this case, the VOLSER information can be obtained by entering a VARY devnum,ONLINE command to the DASD device or then entering a MOUNT command.

A DASD device that was offline (either boxed or not boxed) has the VOLSER details obtained from the device through the VARY devnum,ONLINE command.

The VOLSER information is placed in the UCB as part of the vary online operation, if the vary online is successful, that is, that no out-of-line situations exist, for example, it is not a duplicate volume.

Recovery for a failing alias unit control block (UCB)

For a parallel access volume, the status of a base UCB affects the status of its alias UCBs. The status of an alias UCB, however, might not affect the status of its base UCB. When the system detects a problem with an alias UCB, a recovery action applies to the base and its alias UCBs. If an alias UCB becomes boxed, you can unbox the alias with the following DEVSERV command:

```
DEVSERV QPAVS,devn,UNBOX
```

Error messages that display in the following situations are the only indication that an alias UCB is boxed:

- The device is varied online
- A hardware change is activated
- The system is in recovery

Boxed tapes under tape management system control

If a boxed tape drive is controlled by a tape management system, the drive will remain in the A-BOX state. Unless the tape management system is taken down, the VARY devnum,ONLINE,UNCOND command must be used to return the tape drive to the online state.

Tape boxed due to lost assign

If tape CHPIDs, control unit, switches, or ESCON connections are incorrectly handled, a tape ASSIGN may be reset (lost). When this occurs on the last path to the tape drive, the MVS system will box the device.

If an ASSIGN lost condition occurs while a tape was loaded, the MVS system may not be able to unload the tape. If this happens, as indicated by the cartridge remaining in the drive after the job has completed, perform the following actions at the tape unit:

- Place the READY/NOT READY switch to the NOT READY position.
- Toggle the UNLOAD switch, and the tape should unload.

Printer boxed due to lost assign

If printer CHPID, control unit, switch, or ESCON connections are incorrectly handled, a printer ASSIGN might be reset (lost). If this occurs on the last path to the printer, the MVS system will box the device.

1. Locate the device boxed message to determine one of the following causes of the BOX condition:
 - I/O Error
 - Lost Reserve or Lost Assign
 - Lost Last Path (No Paths)
 - UR Boxed
 - Subchannel Recovery
 - Vary Force
 - Hot I/O
2. Correct the cause of the BOX condition before proceeding, as described in Table 3.
3. Recover the boxed device:

Issue the 'D U,,,devnum,1' command to determine device status.

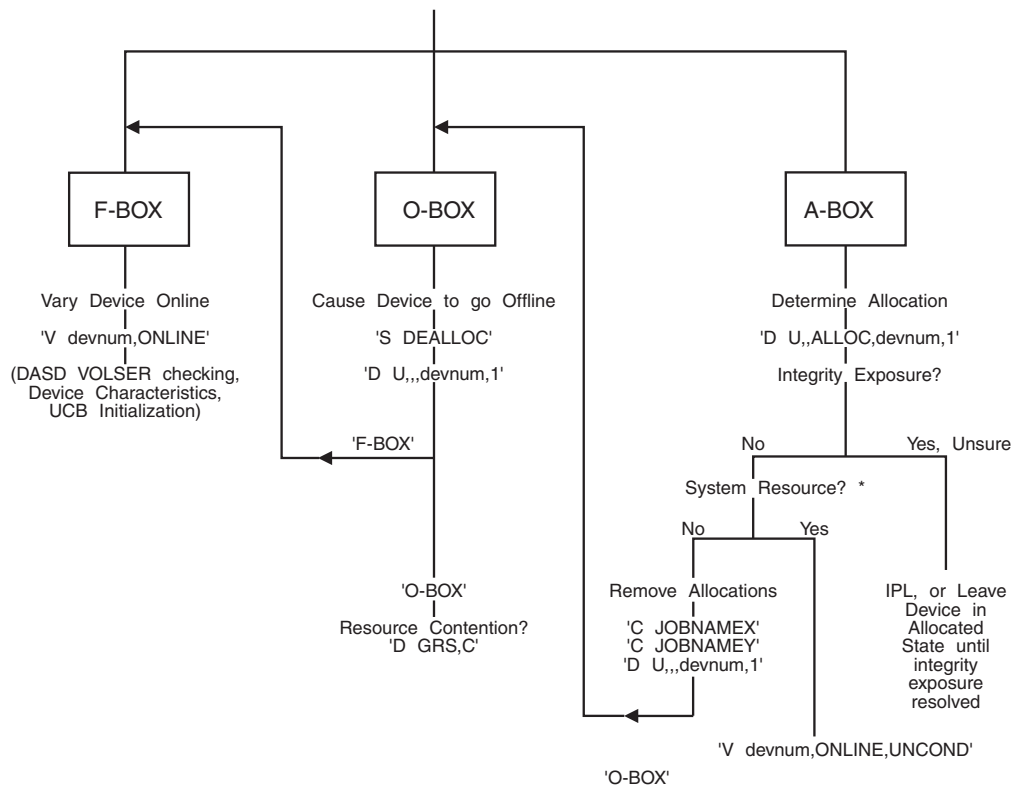

Note: * System Resource - Any System Address Space (D A,ALL = *) or Subsystem

Figure 3. Boxed device recovery procedure

The following procedures are recommended for use when a boxed condition is reported:

Table 3. Correcting boxed conditions

Cause	Operator Action
I/O Error	Correct the cause of the I/O error condition and then attempt to bring the device online

Table 3. Correcting boxed conditions (continued)

Cause	Operator Action
Lost Reserve or Assign	<p>For tape, if mount status=private, determine if any jobs were run or accesses made to the volume from any other system while it is in the boxed state.</p> <p>If yes, an integrity problem may exist and the device should not be varied online until the integrity of the volume can be assured.</p> <p>If no, you may attempt to un-BOX the device by varying it online.</p> <p>If the printer Assign was lost, it is possible the printer was assigned to another host. If so, first vary the printer offline from the other host and then vary online the printer to this host. Otherwise, attempt to vary the printer online to this host.</p>
Lost Last Path	Return the paths to an operational state and then vary the device online.
Subchannel Recovery	Identify and repair resource, then vary the device online
U/R 'Boxed'	Correct the cause of the I/O error condition and then attempt to bring the device online.
VARY FORCE command	Determine why the operator entered the VARY devnum,OFFLINE,FORCE command. Correct the condition on the system and vary the device back online.
Hot I/O	Identify and repair device, then vary the device back online.
Shared Tapes	Identify and repair device, then enter VARY devnum,ONLINE,UNCOND to unbox the device and bring it online

Command flooding

Commands that run in the *MASTER* or CONSOLE address space are divided into six command classes. In each class, only 50 commands can execute at one time. Any additional commands in that class must wait for execution.

To manage the number of commands that are awaiting execution, the system operator can issue the CMDS command to display the status of commands, remove selected commands that are awaiting execution, or cancel commands that are executing. When a command is removed before execution, the command issuer receives message IEE065I COMMAND NOT EXECUTED, CMD=*command* instead of the usual command response message. When a command is canceled, the command is terminated with an ABEND code 422, reason code 00010301.

Class M1 commands

Class M1 commands are commands that are attached in the *MASTER* address space, and are considered essential to clearing a backlog of other commands:

- DISPLAY AUTOR
- DISPLAY GRS
- DISPLAY MPF
- DISPLAY MSGFLD
- DISPLAY SLIP
- DISPLAY XCF
- DUMP
- DUMPDS

- QUIESCE
- SET
- SETMF
- SETXCF
- SLIP
- VARY XCF

Class M2 commands

Class M2 commands are ordinary attached commands that run in the *MASTER* address space:

- ACTIVATE
- CONFIG
- DEVSERV
- DISPLAY ALLOC
- DISPLAY APPC
- DISPLAY ASCH
- DISPLAY ASM
- DISPLAY CEE
- DISPLAY CF
- DISPLAY CNGRP
- DISPLAY DIAG
- DISPLAY DLF
- DISPLAY DUMP
- DISPLAY ETR
- DISPLAY GTZ
- DISPLAY HIS
- DISPLAY IEFOPZ
- DISPLAY IQP
- DISPLAY IOS
- DISPLAY IKJTSO
- DISPLAY IPLINFO
- DISPLAY LLA
- DISPLAY LOGGER
- DISPLAY LOGREC
- DISPLAY MATRIX
- DISPLAY MMS
- DISPLAY OMVS
- DISPLAY PCIE
- DISPLAY PARMLIB
- DISPLAY PPT
- DISPLAY PROD
- DISPLAY PROG
- DISPLAY RRS
- DISPLAY SMF
- DISPLAY SMFLIM

- DISPLAY SMS
- DISPLAY SSI
- DISPLAY SYMBOLS
- DISPLAY TCPIP
- DISPLAY TRACE
- DISPLAY U
- DISPLAY UNI
- DISPLAY VIRTSTOR
- DISPLAY WLM
- HALT EOD
- IOACTION
- LIBRARY
- LOGON (not MCS)
- MOUNT
- PAGEADD
- PAGEDEL
- RESET jobname
- SETALLOC
- SETAPPC
- SETCEE
- SETETR
- SETGRS
- SETGTZ
- SETIOS
- SETLOGR
- SETLOAD
- SETLOGRC
- SETOMVS
- SETPROG
- SETSMF
- SETSMS
- SETSSI
- SETUNI
- START
- SWAP
- SWITCH SMF
- TRACE
- UNLOAD
- VARY CU
- VARY GRS
- VARY ONLINE / OFFLINE
- VARY PATH
- VARY SMS
- VARY SWITCH
- VARY TCPIP

- VARY WLM

Class M3 commands

Class M3 commands are ordinary attached commands that run in the *MASTER* address space. These commands can take a long time to execute, thus they require a command class different from Class M2:

- SEND

Class C1 commands

Class C1 commands are commands that are attached in the CONSOLE address space, and are considered essential to clearing a backlog of other commands:

- DISPLAY CONSOLES
- DISPLAY EMCS
- DISPLAY R
- LOGOFF
- LOGON (MCS)
- REPLY
- SETAUTOR
- VARY CN
- VARY CONSOLE

Class C2 commands

Class C2 commands are ordinary attached commands that run in the CONSOLE address space:

- CHNGDUMP
- CONTROL M
- DISPLAY A
- DISPLAY C,K
- DISPLAY JOBS
- DISPLAY OPDATA
- DISPLAY PFK
- DISPLAY TS
- RESET CN
- SETCON

Class C3 commands

Class C3 commands are ordinary attached commands that run in the CONSOLE address space. These commands can take a long time to execute, thus they require a different command class than Class C2:

- ROUTE

Inline commands

Inline commands are not attached, but execute under the SVC 34 issuer's task. These are not subject to the limits, and cannot be displayed, removed, or canceled, using the CMDS command:

- CANCEL
- CMDS

- CONTROL (except K M)
- DISPLAY NET
- DISPLAY T
- DISPLAY TP
- FORCE
- HALT NET
- HOLD TP
- LOG
- MODE
- MODIFY
- MONITOR
- RELEASE TP
- STOP
- STOPMN
- VARY NET
- WRITELOG

Setting up hardware event data collection

Hardware instrumentation services (HIS) is a function that collects hardware event data for IBM System z10™ or later machines.

Before you start the HIS data collection, you may first need to authorize to the sampling facilities and counter set types you want to use through the support element (SE) console. For information about how to set up the authorization of the sampling facilities and counter sets, see *Support Element Operations Guide* for your machine type on the Resource Link home page (<http://www.ibm.com/servers/resourcelink>).

In addition, with the enhanced-monitor facility hardware released with z196 machines, the HIS function expands into a z/OS software event data collector that will be used by IBM for improved problem analysis. The z/OS event counters are viewed as an additional hardware counter set, and there is no authorization required to use the hardware.

The HIS function will not work if your z/OS operating system is running as a z/VM guest.

With HIS, you can either collect instrumentation data in z/OS UNIX files and SMF buffers through the HIS profiler, controlled through the `MODIFY hisproc,BEGIN` command, or you can collect instrumentation data dynamically through the HISSERV service. See “HISSERV service overview” on page 53. Both services require initialization of the HIS address space.

If you plan to collect sampling or load map files, you must have z/OS UNIX System Services active, and you must perform all of the steps in “Steps for starting the HIS address space” on page 41. If you only plan to collect hardware or software (or both) counter sets into SMF type 113 records (and not z/OS UNIX files), then you can perform only the required steps according to the following guidelines:

- Step 1 is always required (RACF definition).
- Step 2 is only required if creating z/OS UNIX output files.

- Step 3 is only required if creating z/OS UNIX output files.
- Step 4 is always required (SMF enablement), especially if not collecting z/OS UNIX output files, as this is the only alternative output.
- Step 5 is always required.

Steps for starting the HIS address space

Follow these steps to set up hardware event data collection:

1. Define the HIS-started task to RACF.

To set up the HIS-started task to RACF, you must define a profile for it to the RACF generic resource class called STARTED by using the **RDEFINE** command.

Note: If the STARTED class is not active, RACLISTed, and GENERIC profile checking is not activated, use the **RACF SETROPTS** command to activate (CLASSACT), RACLIST, and GENERIC the STARTED class first before you can define a new profile to it. In most environments, this might already have been done. Therefore, you might not have to include the **SETROPTS** command to CLASSACT, RACLIST, and GENERIC the STARTED class. In this example, these **SETROPTS** commands are shown for completeness. Running these commands when the STARTED class is already activated has no effect.

Example 1: RACF commands to define HIS-started task to RACF:

```
//DAEMONS EXEC PGM=IKJEFT01
//SYSTSPRT DD SYSOUT=*
//SYSTSIN DD *
  SETROPTS CLASSACT(STARTED)
  SETROPTS RACLIST(STARTED)
  SETROPTS GENERIC(STARTED)
  RDEFINE STARTED HIS.* STDATA(USER(HIS) TRUSTED(YES))
  SETROPTS RACLIST(STARTED) REFRESH
  SETROPTS GENERIC(STARTED) REFRESH
```

2. Define a user ID for the HIS started task with an OMVS segment that specifies:

- Any UID
- A default HOME directory

For example, you might define the user ID as follows:

```
adduser HIS omvs(uid(25) home('/HIS'))
```

where UID(25) is the OMVS uid and /HIS is the default home directory.

Note: While OMVS access is required, there is no special authorization needed. Also, any directory can be used for the HOME directory.

Example 2: Defining a HIS user ID for the HIS started task:

```
//DAEMONS EXEC PGM=IKJEFT01
//SYSTSPRT DD SYSOUT=*
//SYSTSIN DD *
  ADDUSER HIS OMVS(UID(12) HOME('/HIS'))
  SETROPTS NOCLASSACT(SECLABEL) NORACLIST(SECLABEL)
  ALTGROUP SYS1 OMVS(GID(0))
```

Example 3: RACF commands to perform steps 1 and 2 in one job:

```
//DAEMONS EXEC PGM=IKJEFT01
//SYSTSPRT DD SYSOUT=*
//SYSTSIN DD *
  SETROPTS CLASSACT(STARTED)
```

```

SETROPTS RACLIST(STARTED)
SETROPTS GENERIC(STARTED)
RDEFINE STARTED HIS.* STDATA(USER(HIS) TRUSTED(YES))
SETROPTS RACLIST(STARTED) REFRESH
SETROPTS GENERIC(STARTED) REFRESH
ADDUSER HIS OMVS(UID(12) HOME('/HIS'))
SETROPTS NOCLASSACT(SECLABEL) NORACLIST(SECLABEL)
ALTGROUP SYS1 OMVS(GID(0))

```

3. Create the HOME directory in a local z/OS UNIX file system by issuing the **mkdir** command under z/OS UNIX. Also assign read/write/exec authority (making a HIS data collection directory):

```

omvs
tso omvs
mkdir /HIS

```

In this example, /HIS will be the default directory where the HIS output file will be stored. IBM may request this data and the SMF records for problem diagnosis. This directory is used only for the HIS profiler.

Note: If you plan to capture lots of sample data, this output directory for HIS data needs to be large enough.

For sample data, a directory with 1 GB available is recommended. For more information about calculating the disk space for sampling output, see “Sampling function output in a .SMP file” on page 49.

4. If you would like SMF records also, enable SMF record type 113 using either the **SET SMF** or **SETSMF** command. For example, you might enable SMF record type 113 as follows:
 - a. Issue SET SMF=xx to select the SMFPRMxx parmlib member you want to update with information for SMF record type 113.
 - b. Reply to the message issued in response to the SET SMF=xx command to change any SMFPRMxx parameters. For example, you might reply with the following information:

```
nn,sys(type(113)),intval(01),maxdorm(0100)
```

Then, reply *nn,U* to continue.

This reply will prompt the system to collect type 113 records, give you one minute collection intervals, and the data will only stay in the buffers for one minute before being written to the MANA or MANB data set. You can change other SMFPRMxx parameters on the **SET SMF** command response or the **SETSMF** command. See *z/OS MVS Initialization and Tuning Reference*.

5. Start the HIS started task with the following command. A *hisproc* procedure is delivered in PROCLIB as member HIS.

```
START hisproc
```

This command does the following:

- Starts the hardware instrumentation services address space for the system
- Creates a new instrumentation started task, *hisproc* for the system
- Initializes the HISSERV service and allows profilers to request authorization and collect instrumentation data through the HISSERV interface.

See “Starting hardware instrumentation services (HIS)” on page 890 for complete information about the *START hisproc* command.

Note that it is important to assign a sufficiently high dispatch priority to the instrumentation started task *hisproc*, so that the task can write sampling data to the .SMP output files in a timely manner.

Steps to use the HIS profiler for hardware data collection

- To configure and start a run of data collection on a system, issue one of the following commands:

- If you want to collect sampling and counter counter-set data, issue the following command to configure and start a run of data collection on a system:

```
MODIFY hisproc,BEGIN
```

This data will be stored in the z/OS UNIX files and SMF data sets.

- If you want to collect counter-set data and only want the results to be output as SMF type 113 records (and not into a z/OS UNIX file), issue the following command to configure and start a run of data collection on a system:

```
MODIFY hisproc,BEGIN,CNTONLY,CNTFILE=NO
```

Note that you must explicitly start each run of hardware data collection.

You can specify in advance the duration of a run of data collection you want by using the **DURATION** parameter on the `MODIFY hisproc,BEGIN` command.

If you configure a new processor online in a system after you have already issued the `MODIFY hisproc,BEGIN` command to start a data collection run for that system, HIS will enable resources (counters/samplib) for that CPU. The system does not collect data on a processor that is configured offline.

Note that z/OS IRD processor management can configure processors offline or online automatically. A processor is online at the start of the instrumentation run, but it might be configured offline (and sometimes online again) during the run. The system does not collect data on the offline processor.

See “Starting, configuring, and stopping hardware event data collection” on page 561 for complete information about the `MODIFY hisproc` command.

- To explicitly stop a HIS profiler on a system, issue the following command:

```
MODIFY hisproc,END
```

Alternatively, you can use the **DURATION** parameter on the `MODIFY hisproc,BEGIN` command to specify when you want a data collection run to end.

The system writes all the collected data to the z/OS UNIX output files at the path specified and to the SMF data set that is set up by the installation, depending on the parameters provided on the `F hisproc,BEGIN` command.

You can also use the `STOP hisproc` command to stop a run of data collection.

Note that if you use the **STOP** command, you must restart the address space again with the **START** command before starting the next run of data collection.

However, use of the **STOP** command may result in a non-reusable address space; therefore, the **MODIFY** command is the preferred means for ending a run of data collection.

See “Starting, configuring, and stopping hardware event data collection” on page 561 for complete information about the `MODIFY hisproc` command.

Accessing the output from a hardware event data collection run

For authorized programs using the HISSERV interface, output from a collection run is delivered in storage. See *z/OS MVS Programming: Authorized Assembler Services Reference EDT-IXG* for details about the HISSERV interface. During a HIS Profiler run that requested counter-set data collection, the system writes the raw data to SMF record type 113, subtypes 1 and 2, at an interval defined by the

CNTINTVAL parameter on the MODIFY *hisproc*,BEGIN command. The HIS Profiler may also write data to one or more of the following z/OS UNIX System Services (z/OS UNIX) output files:

- Delta counter data file, which is optional. The system writes the delta data to the z/OS UNIX .CNT output file at the end of the run. The delta data is the data from the time when the instrumentation run was initiated until the end of the run, showing the delta incremental values of the instrumentation run on the specified processor. You can request that the system not create the .CNT file by specifying the CNTFILE=NO parameter on the MODIFY *hisproc*,BEGIN command.
- Load map file, which is optional. The system creates one .MAP file, if requested, at the end of the data collection run. This file contains the load module mapping information for the active system on which the data collection was done. The results will be more complete if the tracking of directed load modules is enabled with the SETPROG TRACKDIRLOAD command. See “Tracking directed load modules” on page 736.
- Sample data files, which are optional. The system creates one .SMP sample file for each active logical processor in the system. Sample data contains the addresses of the instructions being executed and the state information about a specific logical processor. Sample data is written out continuously when the data collection buffers become full.

For each data collection run, the system may generate one or more z/OS UNIX output files in the HOME directory or the user-specified directory that follow the naming conventions:

```
SYSHISyyyymmdd.hhmmss.xxx.CNT
SYSHISyyyymmdd.hhmmss.xxx.MAP
SYSHISyyyymmdd.hhmmss.xxx.SMP.cpu#
```

The files generated by your data collection run will depend on the MODIFY *hisproc* parameters you specify when you start the run.

yyyymmdd

The year, month, and day when the MODIFY *hisproc* command was processed.

hhmmss

The hour, minute, and second when the MODIFY *hisproc* command was processed.

xxx

The sequence number of the collection run interval. This starts at 000 and is incremented by one for every state change detected during a collection run when the action specified for a detected state change is SAVE. For more information about collection run intervals, see the STATECHANGE parameter in “Starting, configuring, and stopping hardware event data collection” on page 561.

CNT | MAP | SMP.cpu#

Identifies the file, as follows:

- CNT identifies a counter set data file.
- MAP identifies a load module mapping output file.
- SMP.*cpu#* identifies a sampling function data file. *cpu#* is the CPU number, in hexadecimal. There is one .SMP file for each active CPU.

Example: The system creates the following z/OS UNIX files for a system with three CPUs at 11:30:16 on 2015/05/18:

```

SYSHIS20150518.113016.000.CNT
SYSHIS20150518.113016.000.MAP
SYSHIS20150518.113016.000.SMP.0000 (for CPU 0)
SYSHIS20150518.113016.000.SMP.0001 (for CPU 1)
SYSHIS20150518.113016.000.SMP.0002 (for CPU 2)

```

Table 4 shows when the HIS Profiler generates the .CNT, .MAP, and .SMP files, based on the parameters you specify on the MODIFY *hisproc*,BEGIN command:

Table 4. z/OS UNIX files generated by the HIS Profiler

.CNT file	.MAP file	.SMP file
<p>By default, the HIS Profiler generates a .CNT file, unless you specify CNT=NO, CNTFILE=NO, or MAPONLY.</p> <p>Notes:</p> <ol style="list-style-type: none"> The HIS Profiler generates only the .CNT file, and does not generate .SMP and .MAP output files, if you specify CNTONLY. The HIS Profiler will not generate the .CNT, .SMP, and .MAP output files if you specify CNTONLY, CNTFILE=NO. 	<p>The HIS Profiler generates a .MAP file if you use any of the following parameters on the MODIFY <i>hisproc</i>,BEGIN command:</p> <ul style="list-style-type: none"> MAPASID MAPJOB MAPONLY <p>Note: The the HIS Profiler does not generate .SMP and .CNT output files if you specify MAPONLY.</p> <p>A .MAP file is only generated during the last collection run interval of a collection run.</p>	<p>By default, the HIS Profiler generates a .SMP file unless you specify SMP=NO, CNTONLY, or MAPONLY.</p>

To access the output generated by the HIS Profiler in your z/OS UNIX file system in your HOME directory or a user-specified directory, use the **OBROWSE** command on the file, or else use the **OGET** command to copy the files to MVS and access the output data there.

Note: When programmatically accessing the output generated by the HIS Profiler, the format of the file name may change.

Interpreting the z/OS UNIX system services output files

This information describes how to interpret the contents of the .CNT, .MAP, and .SMP output files.

Counter sets output in a .CNT file

The system may generate a .CNT output file after the data collection run. You can request the system to generate only the delta counter data information in your data collection run by specifying the CNTONLY parameter on the MODIFY *hisproc*,BEGIN command. Unless you have specified the CNTFILE=NO parameter on the MODIFY *hisproc*,BEGIN command, the HIS Profiler returns the delta data in a z/OS UNIX output file (SYSHISyyyymmdd.hhmmss.xxx.CNT) in your HOME directory or the user-specified directory.

The following counter sets can be collected in the .CNT output files:

- Basic counter set
- Problem state counter set
- Extended counter set
- Crypto activity counter set

- z/OS counter set
- MT-diagnostic counter set

See “Starting, configuring, and stopping hardware event data collection” on page 561 for more information about how to select the type of the counter data set on the MODIFY *hisproc* command.

The Basic, Problem, Extended, and Crypto activity counter sets require the CPU Measurement Facility to be installed on the machine and available for any authorized program. The z/OS counter set is used for IBM diagnostic purposes and requires the Enhanced Monitor Facility to be installed on the machine.

The MT-diagnostic counter set is available only when PROCVIEW CORE is specified in the LOADxx parmlib member and when running on hardware that supports multithreading (MT).

The following example shows a .CNT output file that is embedded in the message text of HIS019I. The output contains counter values for the BASIC, PROBLEM-STATE, CRYPTO-ACTIVITY, EXTENDED, and MT-DIAGNOSTIC counter sets on a system with two processors (one core). MT-diagnostic counter set data is reported from one CPU on each core.

```

HIS019I EVENT COUNTERS INFORMATION VERSION 3
FILE NAME: SYSHIS20100301.161406.000.CNT
COMMAND: MODIFY HIS,B,CNTONLY,CNTSET=ALL
STATE CHANGE: NO MODEL: 2097-710 SEQCODE: 1234567812345678
COUNTER VERSION NUMBER 1: 1 COUNTER VERSION NUMBER 2: 1

COUNTER SET= BASIC
COUNTER IDENTIFIERS:
  0: CYCLE COUNT
  1: INSTRUCTION COUNT
  2: L1 I-CACHE DIRECTORY-WRITE COUNT
  3: L1 I-CACHE PENALTY CYCLE COUNT
  4: L1 D-CACHE DIRECTORY-WRITE COUNT
  5: L1 D-CACHE PENALTY CYCLE COUNT

START TIME: 2010/03/01 16:14:06 START TOD: C59D40379C44268E
END TIME: 2010/03/01 16:16:41 END TOD: C59D40CB3551AAAB
COUNTER VALUES (HEXADECIMAL) FOR CPU 00 (CPU SPEED = 2455 CYCLES/MIC):
  0- 3 00000013CBAA4CD7 0000000333EA30C9 000000000A4BCF64 0000000157C1BB9E
  4- 7 00000000BF8AE6C 0000000A31F8354C -----

START TIME: 2010/03/01 16:14:06 START TOD: C59D40379C5A930E
END TIME: 2010/03/01 16:16:41 END TOD: C59D40CB3553932B
COUNTER VALUES (HEXADECIMAL) FOR CPU 01 (CPU SPEED = 2455 CYCLES/MIC):
  0- 3 0000004068D6004A 00000011F3F57DE5 000000000BB82A62 000000021A79D610
  4- 7 0000000012AFD068 0000001577743AC1 -----

COUNTER SET= PROBLEM-STATE
COUNTER IDENTIFIERS:
  32: PROBLEM-STATE CYCLE COUNT
  33: PROBLEM-STATE INSTRUCTION COUNT
  34: PROBLEM-STATE L1 I-CACHE DIRECTORY-WRITE COUNT
  35: PROBLEM-STATE L1 I-CACHE PENALTY CYCLE COUNT
  36: PROBLEM-STATE L1 D-CACHE DIRECTORY-WRITE COUNT
  37: PROBLEM-STATE L1 D-CACHE PENALTY CYCLE COUNT

START TIME: 2010/03/01 16:14:06 START TOD: C59D40379C44268E
END TIME: 2010/03/01 16:16:41 END TOD: C59D40CB3551AAAB
COUNTER VALUES (HEXADECIMAL) FOR CPU 00 (CPU SPEED = 2455 CYCLES/MIC):
  32- 35 00000000FAB630CB 0000000025556804 000000000082BA33 0000000022DC4926
  36- 39 0000000009BABE1 0000000074579FA8 -----

```

START TIME: 2010/03/01 16:14:06 START TOD: C59D40379C5A930E
END TIME: 2010/03/01 16:16:41 END TOD: C59D40CB3553932B
COUNTER VALUES (HEXADECIMAL) FOR CPU 01 (CPU SPEED = 2455 CYCLES/MIC):
32- 35 000000006F30CE68 00000000100B5233 00000000003D9C8B 00000000150917D0
36- 39 000000000432F96 0000000031EBD508 -----

COUNTER SET= CRYPTO-ACTIVITY
COUNTER IDENTIFIERS:
64: PRNG FUNCTION COUNT
65: PRNG CYCLE COUNT
66: PRNG BLOCKED FUNCTION COUNT
67: PRNG BLOCKED CYCLE COUNT
68: SHA FUNCTION COUNT
69: SHA CYCLE COUNT
70: SHA BLOCKED FUNCTION COUNT
71: SHA BLOCKED CYCLE COUNT
72: DEA FUNCTION COUNT
73: DEA CYCLE COUNT
74: DEA BLOCKED FUNCTION COUNT
75: DEA BLOCKED CYCLE COUNT
76: AES FUNCTION COUNT
77: AES CYCLE COUNT
78: AES BLOCKED FUNCTION COUNT
79: AES BLOCKED CYCLE COUNT

START TIME: 2010/03/01 16:14:06 START TOD: C59D40379C44268E
END TIME: 2010/03/01 16:16:41 END TOD: C59D40CB3551AAAB
COUNTER VALUES (HEXADECIMAL) FOR CPU 00 (CPU SPEED = 2455 CYCLES/MIC):
64- 67 0000000000000000 0000000000000000 0000000000000000 0000000000000000
68- 71 00000000005ABB5D 00000012EE9487DF 0000000000000000 0000000000000000
72- 75 0000000005E0C165 0000000632A0775E 0000000000000000 0000000000000000
76- 79 000000000ACF18D 0000002085B30F22 0000000000000000 0000000000000000

START TIME: 2010/03/01 16:14:06 START TOD: C59D40379C5A930E
END TIME: 2010/03/01 16:16:41 END TOD: C59D40CB3553932B
COUNTER VALUES (HEXADECIMAL) FOR CPU 01 (CPU SPEED = 2455 CYCLES/MIC):
64- 67 0000000000000000 0000000000000000 0000000000000000 0000000000000000
68- 71 00000000005F8B20 00000013F0CA4C6D 000000000001B7CA 0000000040FA5733
72- 75 000000000060F2989 00000007812E3E13 00000000000063797 000000011E3A6AFA
76- 79 0000000000B2557F 00000023091B160E 000000000005C644 00000000B63559A2

COUNTER SET= EXTENDED
COUNTER IDENTIFIERS:
MODEL DEPENDENT INFORMATION NOT AVAILABLE

START TIME: 2010/03/01 16:14:06 START TOD: C59D40379C44268E
END TIME: 2010/03/01 16:16:41 END TOD: C59D40CB3551AAAB
COUNTER VALUES (HEXADECIMAL) FOR CPU 00 (CPU SPEED = 2455 CYCLES/MIC):
128-131 0000000009EA3C93 00000000060172E5 0000000000592F82 00000000041C7A16
132-135 00000000000B0D4 0000000001E1B43 00000000004E23B8 00000000002A288
136-139 000000000096A725 00000000001F46C9 0000000000E71233 0000000002C1FCBF
140-143 000000000151A506 0000000000475EF6 00000000000339DD 0000000000000000
144-147 0000000000000000 00000000454D1FEF 000000025439A8B5 00000000981D8BD6
148-151 0000000000000000 0000000000000000 0000000000000000 0000000000000000

START TIME: 2010/03/01 16:14:06 START TOD: C59D40379C5A930E
END TIME: 2010/03/01 16:16:41 END TOD: C59D40CB3553932B
COUNTER VALUES (HEXADECIMAL) FOR CPU 01 (CPU SPEED = 2455 CYCLES/MIC):
128-131 000000000ABE9264 000000007A04424 0000000000DAA195 00000000069AE0F4
132-135 000000000003D1DD 00000000004C9BE6 0000000000BAFFD3 0000000000043A8F
136-139 00000000010E0561 000000000067A15E 0000000000FFF2A3 00000000054C2E8C
140-143 0000000002894CF7 00000000007DE480 000000000005BBAA 0000000000000000
144-147 0000000000000000 000000007015060C 000000008427EA97D 00000001C5B9F720
148-151 0000000000000000 0000000000000000 0000000000000000 0000000000000000

COUNTER SET= MT-DIAGNOSTIC
COUNTER IDENTIFIERS:

MODEL DEPENDENT INFORMATION NOT AVAILABLE

```
START TIME: 2010/03/01 16:14:06 START TOD: C59D40379C44268E
END TIME: 2010/03/01 16:16:41 END TOD: C59D40CB3551AAAB
COUNTER VALUES (HEXADECIMAL) FOR CPU 0000 (CPU SPEED = 2950 CYCLES/MIC):
 448- 451 000000000008CFDC 0000000000119FB8 0000000000000015 0000000000000015
 452- 455 000000000001720B 000000000003EC8E 0000000000000015 0000000000000015
 456- 459 0000000000000015 -----
```

Note: If programmatically parsing the .CNT file, the format of the output file is loosely structured. For example, a parser cannot rely on the number of spaces between text to determine the value of a certain field.

For significant changes, the version number of the .CNT file will be incremented. The first line of the .CNT file will always be HIS019I EVENT COUNTERS INFORMATION VERSION *x*, where *x* is the version number of the .CNT file. Any change to the version number will be an indication that the structure of the file has been altered and parsing rules for previous versions may no longer be applicable. An example of a significant change is the addition of an extra line.

Load module mapping output in a .MAP file

You can request load module mapping output information in your data collection run using any of the following parameters on the *F hisproc*,BEGIN command:

- MAPONLY
- MAPASID
- MAPJOB

HIS returns the load module mapping data in a z/OS UNIX System Services output file (SYSHISyyyymmdd.hhmmss.xxx.MAP) in your HOME directory or the user-specified directory.

This load module mapping data contains information about the virtual address ranges of various modules loaded on the system. You can request this module address information for one address space, for several address spaces, or for all active address spaces using the *F hisproc*,BEGIN MAPASID and MAPJOB parameters. The .MAP file also provides information about the virtual addresses of Nucleus CSECTs, and modules loaded into LPA. Modules may also be further divided into CSECTs.

When a module is directed to a specified storage address (called a *directed* load), the mapping information about the module includes the date and time of the directed load. This additional mapping information about directed loads is provided only when the TRACKDIRLOAD option is in effect either through the TRACKDIRLOAD statement of the PROGxx member of parmlib or the TRACKDIRLOAD parameter of the SETPROG system command. A module that is directed into common storage is mapped only for the address space in which the load occurred. Modules that are directed into 64-bit storage are not mapped. The size of the storage area used to store mapping information about directed loads is not configurable. If several directed loads occur in a single address space causing the mapping storage area to become full, information about earlier directed loads might be discarded and might not appear in the .MAP file.

The data in a .MAP file is useful for understanding the other information HIS returns in data collection runs. For example, the HIS Profiler generates .SMP files containing virtual addresses. The module map allows you to determine how many of these samples are associated with a specific module, which helps you estimate the relative amount of activity in the module. For example, assume that module A

is an LPA module that starts at X'00CC7000' and ends at X'00CC73FF'. When you look at the sample data provided by HIS, you may see that 50,000 of the 1,000,000 samples provided by HIS have virtual addresses between X'00CC7000' and X'00CC73FF'. Based on this, you can estimate that 5 percent of the CPU time is spent in module A during the time that HIS is capturing data.

The following example shows the important portions of a sample .MAP output file:

```

I SYS SY1
I SMFIIBM2
I OS z/OS
I FMIDHBB7790
I DATE13007
I TIME13245916
I MAP 02.01
I MODE64-BIT
I LPID00000000
I MACH00002817
B BDY PRIVATE 00000000000000000000000008FFFFFF
B BDY CSA      00000000090000000000000000B9CFFF

. . .
CNUC IECVPRNT000000000FD600000000000FD64F7
ENNUC PRDSE 000000000FD6006
ENNUC PRTSIO 000000000FD600C

. . .
MCCOMMIGE0001C000000000B9100000000000B913EF12004000150000000DZDR21
 0CSYS1.LINKLIB
CCCOMMIEC2540A000000000B9100000000000B913EF

. . .
MPPLPAIGG019K0000000000BD002000000000BD040F1200400090000000CLPALST
CPPLPAIGG019K0000000000BD002000000000BD02D7
CPPLPAIGG019LA0000000000BD02D80000000000BD0409

. . .
MMMLPAAIRMSRB 0000000059DF000000000059DF71F12004000180000000DBPXLK10
  FUSER.ID.LOADLIB
CMMLPAAIRMSRB 0000000059DF000000000059DF71F

. . .
AX0002PCAUTH
MX0002IEAVXMAS00000000257000000000002570204712004000150000000DZDR21
 0CSYS1.NUCLEUS
CX0002IEAVXMAS000000002570000000000025701147
CX0002IEAVXSEM00000000257011480000000025702047

. . .
AX0010RESOLVER
MC0010EZBRESRV0000000024D7B000000000024E18ECF120040001700570010DZDR21
 0ETCPIP.SEZALOADCABC72F11295D766
CC0010EZBRESMT0000000024D7B000000000024D7B397

. . .
AX0023USERSID5
MX0023*PATHNAM00000000257080000000002570AFF120040001C00000000P0017/
  gettesttest/gettest001
CX0023CEESTART00000000257080000000002570807B
CX0023EDCOEXTS00000000257098780000000025709883
CX0023      00000000257080800000000257085A70A0038000Cgettest001#C

```

See Appendix A, "HIS MAP format," on page 977 for an example .MAP file.

Sampling function output in a .SMP file

The system generates one .SMP file for each active logical processor. You can choose the sampling function type that the system performs during a data

collection run by specifying the SAMPTYPE parameter on the *F hisproc*,BEGIN command. The system can perform two types of sampling functions:

- Basic sampling
- Diagnostic sampling

See “Starting, configuring, and stopping hardware event data collection” on page 561 for more information about how to specify the sampling function type on the *MODIFY hisproc* command.

The HIS Profiler returns sampling data entries in a z/OS UNIX System Services output file (*SYSHISyyyymmdd.hhmmss.xxx.SMP.cpu#*) in the HOME directory or the user-specified directory. The .SMP files are not printable.

If collecting .SMP files, large amounts of space might be needed in the file system containing the .SMP files. You might need to specify the disk space needed for the file system that the sampling data is written in when you set up a hardware event data collection. Sampling buffers are 4KB in size. The last 64 bytes of each buffer are reserved for system use. A basic sample is 32 bytes in length. A diagnostic sample is 64 bytes in length. The required disk space depends on the amount of samples that need to be captured.

For basic sampling, the number of samples that fit in each 4KB buffer is $(4096 - 64) / 32 = 126$. If only the basic sampling is requested, the disk space can be calculated by the formula: $(\text{Number of basic samples} / 126) \times 4K$

If diagnostic sampling is requested, basic sampling is also automatically included. Hence a combined basic and diagnostic sampling takes three times as much disk space as basic sampling alone.

Basic sampling entry

The basic sampling function is the standard part of the CPU-measurement sampling facility and is the default sampling function type. If the system performs basic sampling function, HIS returns the basic sampling entry data in a .SMP output file. The following figure shows the data structure of a basic sampling entry.

0	Data entry format code	R	U	0	0	T	W	P	AS	I
4	Reserved	Primary ASN								
8	Instruction address (8 bytes)									
12										
16	Guest program parameter									
20										
24	Host program parameter (8 bytes)									
28										

Figure 4. Data structure of a basic sampling entry

In the basic sampling data entry:

Data entry format code

Bits 0 - 15 of the data entry contains the format code of the data entry.

Reserved (R)

Bits 16 - 19 of the data entry are reserved for programming use. Zeros are stored in this field.

Number of unique instructions (U)

Bits 20 - 23 of the data entry specify the number of unique, completed instructions that were executed simultaneously during the sampling cycle when the unique cycle indicator is on.

DAT mode (T)

Bit 26 of the data entry contains the DAT mode bit in the PSW of the CPU.

Wait state (W)

Bit 27 of the data entry contains the wait state bit in the PSW of the CPU.

Problem state (P)

Bit 28 of the data entry contains the problem state bit in the PSW of the CPU.

Address-space control (AS)

Bits 29 - 30 of the data entry contain the address-space control in the PSW of the CPU.

Invalid indication (I)

Bit 31 of the data entry indicates whether the entry is valid or not. When the bit is zero, the entry is valid; when the bit is one, the entry is not valid. An entry is set to not valid when sample data in the entry is not consistent.

Reserved

Byte offsets 4 - 5 of the data entry are reserved. Zeros are stored in this field.

Primary ASN

Byte offsets 6 - 7 of the data entry contains the primary ASN in bits 48-63 of control register

Instruction address

Byte offsets 8 - 15 of the data entry contains the instruction address of an instruction that the logical processor was executing during the sampling cycle.

Guest program parameter

Byte offsets 16 - 23 of the data entry contains the program parameter set by the most recent SET PROGRAM PARAMETER instruction executed by the processor running at the virtual-machine level.

Note that the program parameter of z/OS is always stored in the guest program parameter field.

Host program parameter

Byte offsets 24 - 31 of the data entry contains the program parameter set by the most recent SET PROGRAM PARAMETER instruction executed by the processor running under z/VM.

The z/OS dispatcher stores the 8-byte guest program parameter instruction at each dispatch to identify the currently executing address space or task to the hardware. This program parameter with the address space or task ID is included in the basic sampling output.

Note: The z/OS system only uses the guest program parameter. The key fields in the guest program parameter are: Wait (W), SRB mode (S), TCB address, WEB address, and HOME ASN. The Task ID token and Partial WEB Address fields provide additional information for identifying the dispatched work units (task or SRB).

If running under a TCB, the data structure of the guest program parameter is shown as follows:

0	W	Reserved	TCB address
4	S	Home ASN	Task ID token

Figure 5. Data structure of a guest program parameter under a TCB

If running under an SRB, the data structure of the guest program parameter is shown as follows:

0	WEB address		
4	S	Home ASN	Partial WEB address

Figure 6. Data structure of a guest program parameter under an SRB

In the structure of a guest program parameter:

W (1 bit)

Wait is dispatched. The processor is going into a waiting state.

TCB address (24 bits)

The address of the TCB for which the instruction address is being recorded in the sample entry.

S (1 bit)

SRB mode. If the value of S is one, the work is processed in SRB mode. This bit is always zero when running in task mode.

Home ASN (15 bits)

The HOME ASID of the task or SRB for which the instruction address is being sampled.

Task ID token (16 bits)

The Task ID token provides additional identify information on the task to differentiate it from other tasks within the same ASID.

WEB address (32 bits)

WEB address of the SRB for which the instruction address is being recorded in the sample entry.

Partial WEB address (16 bits)

Partial WEB address provides additional identify information on the SRB to better differentiate it from other SRBs within the same ASID.

Diagnostic sampling entry

The diagnostic sampling function is optional. The diagnostic sampling function provides details of the internal hardware design. If you want to use the diagnostic sampling function, you must first authorize to the diagnostic sampling function on the SE console. When diagnostic sampling is requested, basic sampling is also automatically selected. A basic

sampling entry is automatically written ahead of each diagnostic sampling entry. The HIS Profiler returns both the basic sampling entry data and the diagnostic sampling entry data in a .SMP output file. The data format of a diagnostic sampling entry varies on different models. The following figure shows the general data structure of a diagnostic sampling entry.

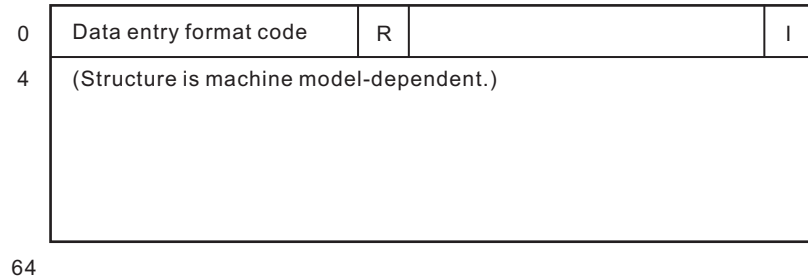

Figure 7. Data structure of a diagnostic sampling entry

In the diagnostic sampling entry:

Data entry format code

Bits 0 - 15 of the data entry contains the format code of the data entry.

Reserved (R)

Bits 16 - 19 of the data entry are reserved for programming use. Zeros are stored in this field.

Invalid indication (I)

Bit 31 of the data entry indicates whether the entry is valid or not valid. When the bit is zero, the entry is valid; when the bit is one, the entry is not valid. An entry is set to not valid when sample data in the entry is not consistent.

Structure

Byte offsets 4 - 64 of the data entry contains the various structures for the diagnostic sampling entries on different models.

HISSERV service overview

The HISSERV service can be used by authorized products to retrieve hardware instrumentation event and sampling data directly from storage.

Although individual products can query the service for any subset of event types they desire, the sampling parameters are global to every product that intends to collect sampling data. The global sampling parameters, or service parameters are set by the most recent MODIFY HIS,BEGIN or MODIFY HIS,SERVICE command. A profiler chooses how often to collect event type data and how much time is spent processing sampling data, but the frequency is global for all profiler's collecting sampling data. Any of these might cause a performance degradation to the system and should be carefully decided.

For details, see the HISSERV service interface in *z/OS MVS Programming: Authorized Assembler Services Reference EDT-IXG*, and for information on the MODIFY HIS,BEGIN or MODIFY HIS,SERVICE commands, see "Starting, configuring, and stopping hardware event data collection" on page 561.

Bypassing HIS to exploit the CPU Measurement Facility

HIS is designed to have exclusive access to the CPU Measurement Facility (CPU/MF). The HISSERV service interface is provided to allow authorized programs to collect instrumentation data using HIS functions and should be used by exploiters. There is no need to bypass HIS. See “HISSERV service overview” on page 53. Other programs which use instructions provided by the CPU/MF must be careful not to interfere with HIS processing. For example, if a system is running HIS and another program is executing CPU/MF instructions, HIS may believe the counters are enabled when the other program has disabled them. Also turning on the sampling facility will cause external interrupts as sampling buffers are filled, which might not be properly handled due to the illicit enablement. For these reasons, the HISSERV service interface should be used. If execution of the instructions by the CPU/MF is still desired, the following guidelines should be used.

Instructions that may be used:

These instructions are typically query instructions which do not change the state of the system. There will be no side effects if multiple programs issue these instructions.

- ECA (Extract Coprocessor Group Address)
- ECCTR (Extract CPU Counter)
- EPCTR (Extract Peripheral Counter)
- QCTRI (Query Counter Information)
- QSI (Query Sampling Information)

Instructions that should not be used:

These instructions change the state of the system, executing them will cause side effects to any other program using the CPU/MF. It is recommended these instructions not be executed.

- SCCTR (Set CPU Counter)
- SCCTL (Set CPU Counter Set Controls)
- SPCTR (Set Peripheral Counter)
- SPCTL (Set Peripheral Counter Controls)
- SSCTL (Set Sampling Controls)

Responding to failing devices

Whenever a device fails, you can use the SWAP command to invoke dynamic device reconfiguration (DDR), which allows you to move or swap a demountable volume from the device.

Using the SWAP command, you can also turn on or off system-initiated swapping requests. When DDR is on, the system dynamically performs the swapping function whenever the originally-allocated device encounters device errors. DDR tells you to mount the volume on another available device. When the swapping function is turned off, you can invoke operator-initiated DDR by issuing the SWAP command and specifying the “from” and “to” device numbers. (See the SWAP command in Chapter 4, “MVS system commands reference,” on page 153.)

When swapping tape devices, the “from” and “to” devices should have the same density whenever possible. Swapping devices of unlike but compatible densities (for example, 1600 and 1600/6250) can cause the failure of jobs that are in device allocation at the time of the swap.

On JES3 systems, DDR interfaces with JES3 to ensure that the “to” device has not been assigned to another job or function. When the swap is complete, DDR notifies JES3.

The following devices are supported by DDR:

- 3400 series tape drives.
- 2501, 2540, 3505, 3525, 1403, and 3211 unit record devices. These devices are not swapped by system-initiated DDR; you must issue the SWAP command to swap these devices.

The following devices are not supported by DDR:

- Graphic or teleprocessing devices.
- Shared DASD devices, unless the device is swapped to itself.
- Any device holding a permanently-resident volume, such as a system residence or page data set volume.

Quiescing the system

Issuing the QUIESCE command causes the system to suspend the processing of all active jobs and to prevent the starting of any new ones. The system enters the MANUAL state, the MANUAL indicator is on, and no processing is being done. Quiescing the system does not affect any job step timings (for accounting purposes). Issue the QUIESCE command from any console with MASTER authority. You can continue processing by performing the restart function.

Do not issue a SYSTEM RESET after quiescing the system if you intend to issue a RESTART after the quiesce. Issuing a SYSTEM RESET will cause the system to enter an enabled wait state.

Stopping the system

When all processing (including subsystem processing) has finished, use the HALT command to ensure that all system statistics and data records in storage are collected for system recording facilities.

Recovery from hardware problems

Recovery is the attempt by the hardware, operating system, operator, automation, or any combination of these, to correct system malfunctions and return the system to a state in which it can do productive work. Recovery from some hardware errors is automatic; that is, the hardware recovers without any actions from the operating system or intervention by the operator or automation. Recovery from other hardware errors requires overt actions from the operating system, operator, and/or automation. For example, to keep the system in operation, the operator or the system can configure offline a failing unit, such as a storage element, a processor, or a channel path. The system continues processing, possibly with some degradation.

The process of recovery includes the following:

- Hardware to operating system communication and corrective actions
- Operator to operating system communication and recovery actions

Hardware problems

This chapter describes the following categories of hardware malfunctions:

- Central processor (CPU) errors
- Service processor damage
- Storage errors
- Channel subsystem errors
- I/O device errors

For each of these categories, the discussion includes the effect on system operation and the recovery actions taken, if any. This chapter also presents some additional recovery actions.

Hardware to operating system recovery actions

When CPU errors, service processor damage, storage errors, or channel subsystem errors occur, except for some I/O errors, the hardware notifies the operating system with a machine check interruption. Machine check interruptions fall into one of three classes depending on the severity of the error. The classes are:

- **Soft (or repressible) errors:** Least severe type. Generally these errors do not affect the operation of the task currently in control. Soft errors can be disabled (repressed) so that they do not cause a machine check interruption.
- **Hard errors:** Malfunctions that affect the processing of the current instruction or make incorrect the contents of hardware areas, such as registers.
- **Terminating error**
- **s:** Malfunctions that affect the operation of a CPU.

Hard and terminating errors are also referred to as *exigent* errors.

Information provided with machine checks

When the hardware detects a failure, it stores the following information about the failure:

- The machine check interrupt code (MCIC), which contains:
 - Information about the severity of the error
 - The time of the error, in relation to the current instruction stream
 - An indication of whether the processor has successfully stored additional information about the error

The MCIC is the major interface between the hardware and the operating system, which uses the MCIC to determine what action to take.

- The save areas that contain the values of the general, floating point, control, and access registers, the CPU timer, and the clock comparator.
- The machine check old program status word (PSW), which contains the PSW at the time of error.
- The fixed logout area, which is implemented on only some processor complex models.

See the *Principles of Operation* for the format and content of the MCIC, register and timer save areas, extended interrupt information, machine check old PSW, and fixed logout area.

CPU errors

CPU errors result from a malfunction of a hardware element, such as a timing facility, instruction-processing hardware, or microcode. When a CPU error occurs, the recovery processing has, in general, two stages depending on the severity and type of error:

1. When possible, the hardware retries the failing operation a certain number of times. If the retry works, the hardware may issue a recovery machine check interruption, which is repressible, so that the operating system can record the error in the logrec data set. After recording, the operating system returns control to the interrupted task.
2. If the error is too severe for hardware retry or the retries fail, the hardware issues either a hard or ending machine check interruption. The system determines the severity of the error and takes the appropriate action, which may range from ending the interrupted task to ending the entire system.

The next topics describe the following CPU errors:

- Soft CPU errors
- Hard CPU errors
- Ending CPU errors

Then the recovery actions of alternate CPU recovery (ACR) are described.

Soft CPU errors

The CPU errors that can result in a soft machine check are:

- **System Recovery (SR):** A malfunction has occurred, but the hardware has successfully corrected or circumvented it.
- **Degradation (DG):** A continuous degradation of system performance has been detected.

The operating system does not inform the operator about the occurrence of soft machine checks until the threshold for a given type is reached. The default threshold set for an SR machine check is 50, and for a DG machine check it is 1. When a threshold for a type of machine check is reached, the system issues message IGF931E.

The MODE command allows the operator to change the threshold value for either SR or DG machine checks, and to specify what processing should be done when the threshold is reached.

- The operator can specify that at the threshold the CPU be disabled for that type of machine check, that is, be put in *quiet* mode.
- If the MODE command specifies RECORD=ALL for a particular type of machine check, the system does not enter quiet mode; it records all instances of the specified type of machine check in the logrec data set. The operating system issues message IGF931E when the number of machine checks reaches a multiple of the threshold. For example, if REPORT=3 is specified, message IGF931E appears after the third, sixth, ninth, twelfth machine checks, and so on.

Numerous IGF931E messages appearing on the console might indicate a performance degradation. In this case, the installation might want to configure offline the processor that is experiencing the errors. Hardware support personnel can repair the offline processor.

Hard CPU errors

A hard machine check indicates that the current instruction could not complete. The system records the error in the logrec data set. Then the system either abnormally ends the interrupted task or retries the interrupted task at a predefined retry point. Even though the task may be ended, the system usually continues to run.

The CPU errors that cause hard machine checks are:

- **System Damage (SD):** A malfunction has caused the processor to lose control over the operation it was performing to the extent that the cause of the error cannot be determined.
- **Instruction Processing Damage (PD):** A malfunction has occurred in the processing of an instruction.
- **Invalid PSW or Registers (IV):** The hardware was unable to store the PSW or registers at the time of error, as indicated by validity bits in the MCIC. Any error, even a soft machine check, associated with these validity bits is treated as a hard machine check because the operating system does not have a valid address to use to resume operation. The error goes through recovery processing.
- **Timing Facility Damage:** Damage to the following has been detected:
 - TOD clock (TC)
 - Processor timer (PT)
 - Clock comparator (CC)
 - External Time Reference (ETR)

The four types of ETR-related machine checks are: primary synchronization damage, ETR attachment damage, switch to local, and ETR synchronization check.

To overcome the effects of numerous hard machine checks, the MODE command allows the operator to define machine check thresholds for each type. When reached, the thresholds cause the failing processor to be configured offline by alternate CPU recovery (ACR). Thus, the operator can control whether, and to what extent, the system monitors the frequency of hard machine checks, and can define a separate threshold and time interval for each.

The default threshold value for most hard machine checks is 5. The default for PD machine checks is 16. The default for ETR machine checks is 5 in 300 seconds.

Terminating errors on CPUs

A terminating machine check occurs when the operating system or the hardware considers a failure severe enough that a processor cannot continue operation.

In a uniprocessor (UP), the operating system enters a disabled non-restartable wait state, such as X'A01' or X'A26', and issues the following message:

```
IGF910W UNRECOVERABLE MACHINE FAILURE, RE-IPL SYSTEM
```

In a multiprocessor (MP), the action taken is as follows:

- If the hardware determines that a processor cannot continue operation, it places the processor in a check-stop state and attempts to signal the other processor(s) by issuing a malfunction alert (MFA) external interruption. The hardware issues an MFA when:
 - It cannot store the machine check logout data about the error.
 - It cannot load the machine check new PSW.

- It is disabled for hard machine checks when a hard error is detected.
- If the operating system determines that a processor cannot continue operation, it attempts to signal the other processor(s) by issuing a Signal Processor (SIGP) instruction to cause an emergency-signal (EMS) external interruption. The operating system issues an SIGP instruction when:
 - The system is processing one machine check when another machine check occurs that cannot be handled.
 - A hard-machine-check threshold, which is an installation option established by entering the MODE command, has been reached.
 - Channel subsystem damage is detected.
 - The content of the MCIC is incorrect.

When a processor receives either an MFA or EMS external interruption for these conditions, the system receives control. The system, in turn, invokes ACR processing, which takes the malfunctioning processor offline and initiates recovery processing for that processor.

In a multiprocessor environment, an MFA or EMS is received by all the other online processors. On the first processor to receive the signal, the system tests and sets a flag before starting to process the error. When the other processors receive the interruption, the system sees that the error is already being processed and returns to the interrupted task.

Terminating errors on multiprocessors: In a multiprocessor, failure of some hardware elements may cause a terminating error on more than one CPU. It is possible that a terminating error may occur on a CPU while alternate CPU recovery (ACR) is still processing a terminating error on another CPU. In either case, the system puts the system into non-restartable wait state X'050'.

Alternate CPU recovery (ACR)

ACR is a function that is initiated on an operative CPU when that CPU receives a signal that another CPU has had an ending error. ACR has two major functions:

- To configure offline the malfunctioning CPU
- To initiate the release of system resources held on the malfunctioning CPU

If the failing CPU has an Integrated Cryptographic Feature (ICRF), the ICRF is also taken offline.

ACR initiates the release of any resources held on the failing CPU by causing control to pass to the recovery routines for the work on the failing CPU. ACR allows the operating system to continue its normal operation on the remaining CPU(s), although the task that was interrupted by the error on the failing CPU might be ended.

When ACR is complete, it issues message IEA858E stating that ACR is complete and identifying the CPU that was configured offline. At this point, the operator can try to configure the failing CPU back online using a CONFIG CPU(x),ONLINE command. The configuration online might, or might not, be successful depending on the error that caused the CPU to be configured offline.

Some hardware malfunctions might cause a subsequent CONFIG CPU(x),ONLINE command to that CPU to fail, or might cause the problem to recur when the CPU is brought back online. In these cases, hardware support personnel need to service the CPU before it can be successfully brought back into the system.

However, if a CPU was configured offline because a threshold was reached or because of an operating system problem, a subsequent request to configure the CPU back online might work.

Service processor damage

Permanent failure

When the system detects that the service processor is permanently, completely failing, the system receives a service processor damage machine check. The system also notifies subsystems about the damage.

For a permanent failure, the system issues the following message:

```
ISN000E THE PROCESSOR CONTROLLER HAS FAILED. SOME CRITICAL SYSTEM
        FUNCTIONS HAVE BEEN DISABLED. AN ORDERLY SHUTDOWN OF THE
        ENTIRE SYSTEM SHOULD IMMEDIATELY BE ATTEMPTED IN ORDER TO
        MINIMIZE THE IMPACT OF THIS FAILURE
```

After this message, the operator can optionally perform an orderly shutdown of the system. Processing can continue, but when a function of the service processor is required, the system may become inoperative. To recover, the operator then performs an initial microprogram load (IML).

Temporary failure

If a service processor fails temporarily or partially and is in I/O Support Processor (IOSP) concurrent maintenance mode, the system continues operating but cannot perform certain functions.

For a temporary failure, a message with the prefix ARRP is issued to the operator.

In IOSP concurrent maintenance mode, certain functions of the operating system will not work or will work incompletely.

Storage errors

The hardware detects and corrects storage errors where possible. The system is informed of the error by a machine check interrupt. The system invokes recovery routines.

If the storage error is detected during an I/O operation, however, the operation is ended with either a channel data check or a channel control check, depending on whether the error was encountered during data transfer or fetching of the channel control word (CCW) and indirect data address word (IDAW). No machine check interrupt is generated in this case. Error recovery procedures (ERPs) recover from this type of error.

Soft storage errors

The soft storage errors are system recovery (SR) errors with the **storage error corrected** flag set in the MCIC to indicate that the storage controller was able to repair the error.

When a **storage error corrected** (SC) condition occurs, along with **storage degradation** (DS), the system attempts to stop using the affected frame. This action eliminates performance degradation that would result from hardware correction of later occurrences of the same error. It also minimizes the chance that the same problem will later occur as a **storage error uncorrected**.

If the frame contains pageable data, the system moves that data to another frame, and the original frame is marked offline. If the data in the frame cannot be moved, the frame is marked **pending offline**, and is subsequently taken offline if the frame is released or if its contents are made pageable. Note that, before the system takes a frame offline, it tests the frame; if it has no errors, the frame is returned to available status.

The threshold for SR machine checks affects the ability of the system to deal with **storage error corrected** conditions. The default threshold is 50 SR machine checks. The operator can change the SR threshold with the MODE operator command. When the threshold is reached, the system disables SR machine checks. This action prevents a subsequent **storage error corrected** from being presented. The system then does not take any action to remove the affected frame.

Hard storage errors

This section deals with these types of hard storage errors:

- **Storage error uncorrected:** Indicates that the hardware could not repair a storage error.
- **Key in storage error uncorrected:** Indicates that the hardware could not repair a storage key that was in error.

When a hard storage error occurs, the operating system attempts recovery. For a storage key problem in a frame containing a virtual page, the operating system tries to reset the key. If the reset fails and the page is not fixed, the operating system moves the page to a new frame, setting the key in the new frame as required.

If recovery cannot repair the error, the operating system either takes the storage frame offline or marks it pending offline. *Pending offline* means that the operating system will take the frame offline when the frame becomes free.

A **storage error uncorrected** condition represents the potential loss of critical data. When this condition occurs with a PD machine check, the system in most cases ends the affected unit of work. If the recovery routines complete successfully so that the affected storage frame is freed, the frame is marked offline and system processing continues. The recovery processing, however, could try to refer to the storage that originally caused the machine check, thus causing further errors. Such action could result in the PD threshold for machine checks being reached, thus taking a CPU offline.

The default threshold for PD machine checks is 16 in 5 minutes. The operator can change this threshold by means of the MODE operator command.

Effects of storage errors

Errors in critical areas of storage may cause the hardware system or the operating system to become inoperative. Those areas of storage and the effect of an error are as follows:

- **Hardware storage area (HSA):** An uncorrectable storage error in the HSA causes the system to enter a check-stop state. The system can be recovered by two actions:
 1. Power-on reset (POR) or a SYSIML CLEAR service language command
 2. IPL
- **Nucleus:** A storage error in nucleus pages requires an IPL for recovery. If the IPL fails, recovery requires either a power-on reset or a SYSIML CLEAR, followed by an IPL.

- **Link pack area (LPA), system queue area (SQA), and local SQA (LSQA):** A storage error in SQA could have the same effects as a nucleus storage error. For a storage error in LPA, the operating system handles recovery. Normally, only the associated job is ended with the remainder of the system unaffected.

High speed buffer (Cache)

A processor cache error can result in the loss of the processor and possibly the system. The storage frame corresponding to any changed data in the cache is marked with an uncorrectable storage error. Because the cache might contain critical system data, recovery might require an IPL.

Channel subsystem errors

If the channel subsystem fails, the hardware generates a **channel subsystem damage** machine check interrupt. The resultant processing enters the entire system into non-restartable wait state X'A19' and issues message IOS019W.

Channel report words (CRWs)

When the channel subsystem detects an error, it does the following:

- Builds a CRW that describes the error
- Queues the CRW for retrieval by the operating system
- Generates a machine check interrupt with the **CRW pending** indicator set in the machine check interrupt code (MCIC)

The operating system records the CRW in a logrec data set error record. The CRW contains a code that indicates the source of the error: the channel path, the subchannel, channel configuration alert, or the monitoring facility.

See *Principles of Operation* for additional information on CRWs.

Channel path recovery

If the CRW indicates that a channel path caused the machine check, the system attempts to recover the channel path or route I/O down an alternate channel path. If multiple CRWs indicate errors on different channel paths, a failure in the hardware elements common to those channel paths may be indicated.

The channel path conditions fall into two categories:

- **Expected:** An expected channel path condition occurs as a result of a previous recovery action taken for an unexpected channel path error, and indicates the result of the action.
- **Unexpected:** An unexpected channel path error occurs with no warning.

The channel path conditions indicated in a CRW are:

- A terminating error condition on the channel path.
- A permanent error on the channel path; a system reset to the channel path has not been done.
- A permanent error on the channel path; a system reset to the channel path has been done.
- An initialized condition on a channel path, that is, an error recovered by the channel subsystem; a system reset to the channel path has been done.

Terminating error: A terminating error condition is unexpected only; it is never the result of a previous recovery action. A terminating error condition indicates that the channel path is not permanently lost, but cannot be used until the error

condition is reset. In this case, the system attempts to reset the channel path. The CRW that results from this reset is an expected CRW, and it will indicate whether the reset corrected the problem in the channel path.

For a failing channel path that has a device with an outstanding reserve, the system handles the condition in three different ways, depending on whether the device supports dynamic pathing, supports unconditional reserve, or does not support unconditional reserve. The system actions are:

- For a dynamic pathing device with multiple paths, no action is taken until the expected CRW is received.
- For a non-dynamic pathing device that supports unconditional reserve, such as a 3350 Direct Access Storage, the system issues an unconditional reserve command to the device to move the reserve to an alternate path.
- For a non-dynamic pathing device that does not support unconditional reserve, such as a 3330 Disk Storage, or for a reserved/assigned device with only one path, the system issues message IOS063E (or IOS062E) to request that the operator stop I/O to the shared devices (see Figure 8 on page 64 and the accompanying description). The system then tries to recover the channel path.

Note: Since stopping I/O to shared devices may require a certain level of multi-system disruption and coordination, users may wish to avoid this processing. Through the use of the `TERMINAL BOX_LP(device_class1,...device_classN)` statement in the `IECIOSxx` Parmlib member, users can cause devices in the specified device class to be `BOXED` rather than having to undergo multi-system disruption to recover the channel path to the device. For more information on the use of the `TERMINAL` statement in `IEAIOSxx`, see *z/OS MVS Initialization and Tuning Reference* .

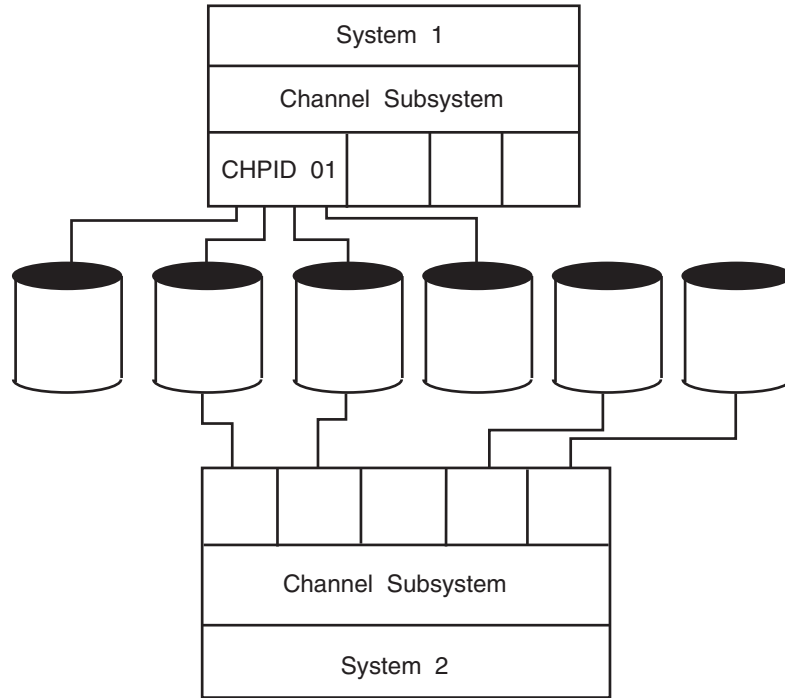

Figure 8. DASD Devices shared between two systems

Figure 8 shows two DASD devices that are shared between two systems. When system 1 encounters a channel path error on channel path 01, indicated by message IOS063E (or IOS62E), the operator should stop I/O to the shared devices from system 2 to maintain data integrity during recovery of the channel path.

Recovery actions for a channel path error with shared DASD or assignable devices:

1. Identify which devices on channel path 01 on system 1 are shared with system 2.
2. Enter the IOACTION STOP command on system 2 to stop I/O on the shared devices. The device numbers **may** not be the same on both systems.
3. Restart system 1.
4. Wait for the system to issue message IOS204E (or IOS201E), indicating that channel path recovery is complete.
5. Enter the IOACTION RESUME command on system 2 to allow I/O to resume to the shared devices.

Note:

1. Do not leave devices in the stopped state any longer than necessary to perform recovery. A shortage of SQA storage can result from stopping I/O for extended periods.
2. Before stopping a device, enter the D U,DASD,ALLOC,xxx command to determine which system resource's I/O will be affected. If any system oriented I/O will be stopped, the system could appear frozen. This situation will last until I/O resumes to the device.

Permanent error condition: A permanent error condition, whether expected following a Reset to a channel path in an ending condition or unexpected, results in the system taking that channel path offline. Any active I/O requests are retried on alternate paths if available. If the failing channel path was the last path to any devices, those devices are boxed. Boxing means:

- The operating system ends I/O to the device.
- Any new I/O request for the device causes a permanent I/O error.
- The operating system does not allocate the device.
- If the device was online, the operating system marks it pending offline. A pending offline device goes offline when the following occur, in this order:
 1. The device becomes no longer allocated to any job.
 2. The operating system allocates any device.

If the device was offline, it remains offline.

Initialized condition: An initialized condition means that a previous recovery action has successfully recovered the channel path and the channel path is available for use. This condition can be expected only. The initialized condition indicates that the channel subsystem has been successful in recovering the channel path to a state where it is again usable.

For devices that support the Dynamic Path Selection (DPS) feature, such as the 3380 Direct Access Storage and 3480 Magnetic Tape Subsystem, DPS validation is called to restore dynamic pathing arrays for each DPS device attached to that channel path. For each non-dynamic pathing device that does not support unconditional reserve and that had an outstanding reserve on the failing channel path, a reserve command is issued to the device. Any previously active I/O requests are restarted.

Channel path alert conditions

The operating system communicates with the operator when two other indicators are set in a CRW: **channel path temporary** and **configuration alert temporary**. In either case, the operating system performs no recovery processing.

- **Channel path temporary:** The operating system issues message IOS162A to inform the operator that the channel subsystem could not identify the device requesting service.
- **Configuration alert temporary:** The operating system issues message IOS163A to inform the operator that the channel subsystem could not associate a valid subchannel with the device requesting service.

Subchannel recovery

If the CRW indicates that a subchannel caused the machine check, the operating system examines the error recovery code in the CRW. If the CRW indicates that the subchannel is available, the channel subsystem has recovered from a previous malfunction. I/O functions in progress and presentation of status by the device have not been affected. No program action is required.

If the CRW indicates that the subchannel is **installed parameter initialized**, the operating system determines if the device associated with the subchannel is still valid. If it is, the operating system enables the subchannel again. If, however, the device related to the subchannel is not valid, the operating system marks the device as unusable and issues message IOS151I.

Monitoring facility recovery

For a channel monitoring error, the operating system schedules a recovery routine.

I/O device errors

An error can occur in an I/O device. The following topics are covered:

- “I/O errors”
- “Missing interrupts”
- “Hot I/O” on page 68
- “Recovery for hung devices” on page 69
- “Recovery for failing devices” on page 69
- “Shared device recovery” on page 73
- “DASD maintenance and recovery” on page 75
- “Recovery for a failing alias unit control block (UCB)” on page 34

I/O errors

Errors that are related to an I/O request are usually indicated in the status data provided with the I/O interrupt. These errors are:

- Device not operational on any path
- Device status errors, such as a unit check
- Subchannel status errors: interface control check, channel control check, and channel data check

The operating system processing of the interrupt may include:

- Invoking a driver exit
- Interfacing with attention routines and volume verification processing
- Invoking a device-dependent ERP for error recovery
- Processing an unconditional reserve
- Redriving the I/O request on a channel path other than the one that generated the interrupt
- Requesting an operator action by message IOS115A or by restartable wait state X'115'
- Issuing message IOS050I to inform the operator that a subchannel status error occurred

Missing interrupts

At predefined intervals, the operating system checks devices of a specific type to determine if expected I/O interrupts have occurred. If an expected interrupt has not occurred across two of these checks, that interrupt is considered missing. The operating system then issues message IOS071I or IOS076E, writes a logrec data set error record, and tries to correct the problem. For recurring missing interrupts, the operating system issues message IOS075E together with message IOS076E or IOS077E to indicate the recurring condition on a particular device.

A feature of the IBM 3990-6 and 9340 attached devices allows MVS/ESA to automatically identify a system in a multisystem environment that is holding a reserve. After every start pending MIH condition, the system attempts to determine whether the device is not responding because of a reserve to another system. If the device is reserved to another system, message IOS431I is issued to identify the system by its central processor serial number. If the system holding the

reserve is a member of the same sysplex as the system detecting the MIH condition, message IOS431I includes the system name and the LPAR ID, if there is one.

For JES2 systems, when the reserve is held by a system in the same sysplex, the system attempts to obtain information about the job causing the reserve by routing a D GRS,DEV=devnum command to that system. JES2 systems which have JES3 installed must have JES2 started with the NOJES3 option (CON=(xx,NOJES3) in order to identify the job holding the reserve. Message ISG020I identifies the jobs holding the reserve on the failing system. The installation can use this information to determine what to do.

Some causes of missing interrupts are:

- An idle unit control block (UCB) with I/O requests queued to it
- An outstanding I/O operation that should have completed
- An outstanding mount for a tape or disk

The intervals used by the operating system to determine whether an expected interrupt is missing varies from 15 seconds for DASD to 12 minutes for 3330 Disk Storage. An installation can define in the IECIOSxx parmlib member the time intervals for all devices in the I/O configuration. These intervals override the IBM-supplied defaults.

Note:

1. During IOS recovery processing, the system will override your time interval specification and may issue MIH messages and MIH logrec error records at this IOS determined interval.
2. During IPL (if the device is defined to be ONLINE) or during the VARY ONLINE process, some devices may present their own MIH timeout values, via the primary/secondary MIH timing enhancement, contained in the self-describing data for the device. The primary MIH timeout value is used for most I/O commands; however, the secondary MIH timeout value may be used for special operations such as long-busy conditions for long running I/O operations. Any time a user specifically sets a device or device class to have an MIH timeout value that is different from the IBM-supplied default for the device class, the value will override the device-established primary MIH time value. This implies that if an MIH time value that is equal to the MIH default for the device class is explicitly requested, IOS will **not** override the device-established primary MIH time value. To override the device-established primary MIH time value, you must explicitly set a time value that is not equal to the MIH default for the device class.

Note that overriding the device-supplied primary MIH timeout value may adversely affect MIH recovery processing for the device or device class.

Please refer to the specific device's reference documentation to determine if the device supports self-describing MIH time values.

Note: If there are missing interrupts on the devices that contain the system residence (SYSRES) or the page volumes, the operator may not receive any message, because the needed operating system routines are pageable. The operator can learn about the missing interrupts by initiating restart reason 1.

See *z/OS MVS Initialization and Tuning Reference* for the IECIOSxx member.

Hot I/O

A hot I/O condition occurs when a device, control unit, or channel path causes continuous unsolicited I/O interrupts. The operating system attempts to recover from a hot I/O condition so that a reIPL is not required. For diagnostic purposes, the operating system indicates all hot I/O incidents in logrec data set error records.

The operating system first tries recovery at the device level by issuing the Clear Subchannel (CSCH) instruction in an attempt to clear the hot I/O condition. If the condition is cleared, processing continues normally. If the condition persists, the next recovery action is determined by one of the following:

- The parameters the installation defined in the IECIOSxx parmlib member for hot I/O recovery
- Operator response to the appropriate hot I/O message or restartable wait state for the class of device:
 - Message IOS117A, (IOS110D, or wait state X'110')
 - Message IOS118A, (IOS111D, or wait state X'111')
 - Message IOS119A, (IOS112D, or wait state X'112')

Because IPLs related to hot I/O are generally caused by incorrect operator actions, an installation should use the IECIOSxx parmlib member to make hot I/O recovery more automatic and reduce the need for immediate operator intervention. The following example parameters, when defined in the IECIOSxx parmlib member, tell the operating system how to handle automatic recovery from hot I/O.

Reference information: See *z/OS MVS Initialization and Tuning Reference* for the IECIOSxx parmlib member.

Example IECIOSxx parameters for hot I/O recovery: The following examples show how to specify the hot I/O recovery parameters in the IECIOSxx parmlib member. The values shown are also the IBM default values.

HOTIO DVTHRS=100

- Specifies 100 repeated interrupts as the threshold for the operating system recognizing the condition.

HOTIO DFLT110=(BOX,)

- For a non-DASD, non-dynamic pathing device. Box the device on the first occurrence of this condition. On recursion, prompt the operator.

HOTIO DFLT111=(CHPK,BOX)

- For a DASD or dynamic pathing device that is not reserved. Attempt channel path recovery for the device on first occurrence of this condition. On recursion, box the device.

HOTIO DFLT112=(CHPK,OPER)

- For a DASD or dynamic pathing device that is reserved. Attempt channel path recovery for the device on first occurrence of this condition. On recursion, prompt the operator.

Hot I/O recommendations: Although it does require more operator intervention, additional experience has shown that a higher level of availability can be achieved by specifying hot I/O recovery options (CHPK,OPER) for all three classes of devices: DFLT110, DFLT111, and DFLT112. These options will allow the possibility of automatic recovery before the system requests operator involvement.

Operator involvement might require that the message be issued using the Disabled Console Communication Facility (DCCF). This will occur when a DASD device is attached on the channel path that is undergoing Hot I/O recovery. Unless the installation is prepared to deal with messages issued in DCCF mode, IBM recommends that operator involvement not be requested by the Hot I/O actions.

For non-DASD devices (DFLT110), CHPK,OPER would allow one automated recovery attempt and then request direction from the operator, depending on how critical the device is. If the device is non-critical to the operation of the system, such as a printer, the operator could then reply **BOX**. If the device is critical, such as a 3705 Communication Controller, and is properly equipped with multiple paths, such as through a type three channel adapter on the 3705, the operator could reply **CHPF**. Note that the operator should ensure that all critical devices on the same channel path (CHP) have multiple paths before replying **CHPF**.

You can choose recovery options other than the defaults or the general recommendations, because of considerations unique to the installation. For example, if all DASDs are configured with multiple paths, each through a different CHP, you might consider specifying **CHPK,CHPF** for both DFLT111 and DFLT112. This will allow one attempt to recover without loss of resources, then an attempt to recover by removing the CHP attached to the failing device or control unit, but without losing a critical device. If the installation contains DASD devices with only one path, the considerations are the same as for non-DASD.

Note: Since CHPK processing may require a certain level of multi-system disruption and coordination (to stop sharing processors), the CHPK option may not be suitable for all device classes in a particular Hot I/O device grouping. For instance, CHPK processing may be suitable for reserved DASD devices, but may not be suitable for assigned single-path tape devices. CHPK can be avoided on a device class basis by using the **HOTIO BOX_LP(device_class1,...device_classN)** parameter in the **IECIOSxx parmlib** member. Using the **BOX_LP** parameter forces a device to be **BOXED** for Hot I/O conditions that cause CHPK processing to occur.

Recovery for hung devices

When a device appears to be hung, an operator can consider varying the device offline to try releasing the hang condition at the device. However, the **VARY OFFLINE** command may obtain resources critical to the system and may attempt to issue I/O. Depending on the condition that caused the device to hang in the first place, this may cause the **VARY OFFLINE** command to also hang.

To avoid this problem, the operator can choose to use the **VARY OFFLINE** command with the **FORCE** parameter to mark the device offline and boxed. The **FORCE** parameter will not obtain resources or issue I/O, so it will complete regardless of any hardware problems with the device. Since the device is boxed, all I/O will be posted back to the I/O issuer in permanent error, which should cause all system resources previously held to be released.

See “Boxed device - operator actions” on page 33 for more information on boxing devices. See “VARY command” on page 921 for more information on the **FORCE** option.

Recovery for failing devices

When a device fails, operators can enter the **SWAP** command to perform dynamic device reconfiguration (DDR). DDR allows the operator to move or swap a demountable volume from a device. When DDR is active, the system dynamically

requests the swapping whenever a device encounters device errors. DDR tells the operator to mount the volume on another available device.

Operators can invoke DDR by issuing the SWAP command and specifying the *from* and *to* device numbers. See “SWAP command” on page 907 for more details.

See *z/OS MVS System Commands* for the SWAP command.

When swapping tape devices, the *from* and *to* devices should have the same density, whenever possible. Swapping devices of unlike but compatible densities can fail the jobs in device allocation at the time of the swap.

On JES3 systems, DDR checks with JES3 to ensure that the *to* device has not been assigned to another job or function. When the swap is complete, DDR notifies JES3.

When a data check occurs in an IBM 3495 Tape Library Dataserver, the system cleans the tape device and retries the failing operation. If the error persists, the system initiates a swap to another eligible system-managed tape library device without involving the operator. The system will try to swap to up to five other devices. If these efforts fail, it issues an error message to the operator and fails the job.

The following devices are supported by DDR:

- 3400 series Magnetic Tape Units.
- Unit record devices. These devices are not swapped by system-initiated DDR; the operator must enter the SWAP command to swap these devices.
 - 1403 Printer
 - 2501 Card Reader
 - 2540
 - 3211 Printer
 - 3505 Card Reader
 - 3525 Card Punch
- Direct access devices. When using a 3348 Model 70F Data Module, operators must ensure that the *to* 3340 has the fixed-head feature installed. When swapping a 3340/3344 with the fixed-head feature, be sure that the *to* device also has the fixed-head feature installed.
 - 3330 Disk Storage
 - 3333 Disk Storage and Control
 - 3340 Direct Access Storage
 - 3344 Direct Access Storage

The following devices are not supported by DDR:

- 3344 and 3350 Direct Access Storage with fixed-head are not supported by system-requested DDR.
- 3375 Direct Access Storage.
- 3380 Direct Access Storage.
- Shared DASD devices, unless the device is swapped to itself.
- Any device holding a permanently-resident volume, such as a system residence or page data set volume.
- Graphic or teleprocessing devices.

Recovery for channel path errors

When you define your I/O configuration, many devices share common hardware components (such as channels, channel cards, switches, control unit ports, control unit adapter cards, and fiber-optic links). For example, all devices for a specific control unit definition share the same hardware components since they share the same channels and control unit ports. Therefore, when a hardware-related error occurs on a channel path, multiple devices are affected.

When an error occurs on a channel path, the system performs path recovery which consists of issuing one or more recovery-related I/Os to test the channel path to see if it is still usable. If path recovery determines that the channel path is no longer usable, the path is removed (varied offline) from the affected device. Otherwise, the channel path remains online to the device.

Path recovery is typically performed one device at a time. This means that when an error occurs on one device, only that device is processed. Errors on other devices are processed independently, even if they share common hardware components. This may affect application performance since the application is delayed while the system performs path recovery and then retries the original I/O request. If the application uses multiple devices that share a failing or malfunctioning hardware component, additional errors are encountered and further delays occur.

Additionally, certain types of path errors can be intermittent. That is, an error occurs, but path recovery is successful, so the path is not removed from the device. This also affects performance because applications may encounter errors multiple times. If this occurs, you may need to manually remove the bad path or paths from the affected devices to stop the errors from occurring.

The `PATH_SCOPE` option on the `RECOVERY` statement in the `IECIOSxx` parmlib member and the `SETIOS RECOVERY` command, along with the `PATH_THRESHOLD` and `PATH_INTERVAL` options, allows you to reduce the elapsed time it takes for the system to recover from channel path-related errors, and helps prevent system performance problems that can occur when a significant amount of time is spent in repetitive channel path error recovery. For more information on the syntax of the `RECOVERY` statement in `IECIOSxx`, see *z/OS MVS Initialization and Tuning Reference*. For more information on the syntax of the `SETIOS RECOVERY` command, see “`SETIOS` command” on page 674.

Specify a `PATH_SCOPE` of either `CU` or `DEVICE` to enable path recovery either for all devices attached to the control unit (`CU`) or on a device-by-device basis (`DEVICE`). The default is `PATH_SCOPE=DEVICE`.

If `PATH_SCOPE=DEVICE` is specified, then path recovery is on a device-by-device basis and no monitoring of intermittent errors is performed. The `PATH_INTERVAL` and `PATH_THRESHOLD` keywords may not be specified with `PATH_SCOPE=DEVICE`.

If `PATH_SCOPE=CU` is specified and path recovery determines that a channel path needs to be removed from a device, the path is removed from all devices defined to the control unit. Additionally, for intermittent channel path errors, the system collects error statistics over a period of time, and if the number of errors reaches or exceeds a threshold value, the channel path is removed from all devices defined to the control unit. The time period and threshold are controlled by the `PATH_INTERVAL` and `PATH_THRESHOLD` parameters as follows:

- `PATH_INTERVAL` specifies the length of time to monitor for errors (for example, 10 minutes).
- `PATH_THRESHOLD` specifies the minimum number of path-related errors that must occur every minute for the specified period of time (`PATH_INTERVAL`) before the path from the failing hardware component is removed from all the affected devices.

For example, specifying a `PATH_INTERVAL` of 10 (minutes) and a `PATH_THRESHOLD` of 20 (errors per minute) means that at least 20 errors must occur every minute for 10 consecutive minutes before the path from the failing hardware component is removed from all the affected devices.

Note: Do not set the `PATH_INTERVAL` and `PATH_THRESHOLD` values to a very low value (for example, setting the `PATH_INTERVAL` to 1 minute or setting the `PATH_THRESHOLD` to 1 error) because this may interfere with normal system recovery and cause the system to remove channel paths unnecessarily. When a channel path becomes not operational, the system takes the path offline to the affected devices. Later, when the path becomes operational, the channel subsystem notifies the system so that it can bring the path back online. If there are I/Os that are active when the channel path becomes not operational, these I/Os are terminated with an interface control check. If `PATH_SCOPE=CU` is specified, these interface control checks are counted towards the `PATH_THRESHOLD` value and may cause the system to internally remove the path from all devices on the control unit if the `PATH_THRESHOLD` and `PATH_INTERVAL` values are too small. Later, when the channel subsystem notifies the system that the channel path is now available, the system does not automatically bring the channel path online; the channel path must be brought online manually.

When `PATH_SCOPE=CU` is specified and the system internally varies the path offline to all devices on a control unit, the system does not remove the last path to a device if the device is online, allocated, reserved, or in use by a system component. However, if the path becomes not operational because of a link threshold condition, then the last path is taken offline. A link threshold condition, also known as a flapping links condition, occurs when a channel path transitions between not operational and operational multiple times within a short period of time. This is usually a sign of some type of hardware problem. These transitions cause the system to perform path-related recovery, which delays applications until the recovery completes. If the channel path transitions too many times within a short period of time, the channel subsystem keeps the channel path offline to prevent further path recovery.

When `PATH_SCOPE=CU` is specified, channel paths that are internally varied offline by the system are not varied back online automatically. You must use one of the following commands to bring the path back online after ensuring that the problem that caused the path errors has been resolved:

- `VARY CU` to vary the path online to all devices for a particular control unit.
- `VARY PATH` to vary the path online to one or more individual or ranges of devices.
- `CONFIG CHP` to configure the CHPID online (if it is offline) and to vary the path online to all devices using that CHPID.

Note: You should bring the path online to a single device first and then wait a short period of time (minutes) to allow I/Os to be issued to the device before bringing the path online to the remaining devices. This ensures that the problem has been resolved and no further errors will occur.

Shared device recovery

When a system, for example system A, is sharing devices with other systems, events on any one system can affect the ability of any or all the systems to access the shared devices. For example, if one of the sharing systems has an allegiance to a shared device, an I/O operation from system A to that device will receive a **device busy** condition. In this case, the I/O operation is held in system A's channel subsystem until the other system ends its allegiance. At that time, system A's I/O to that device can then be processed normally.

However, a problem either on the system that has the allegiance or in the I/O hardware could result in the allegiance not being freed. This could prevent the processing of any pending I/O operations from any of the sharing systems to the device(s) affected by the allegiance. The indication to any sharing systems that had an I/O operation hung by such a condition would normally be message IOS071I, indicating a **start pending** to the device.

There are a number of other conditions that can cause message IOS071I for a shared device:

- Poor performance of programs using the device
- Contention for the device
- Long reserves
- Application errors
- Operator errors

Operator actions: If message IOS071I occurs for a shared device, the operator should check the operating condition of the sharing systems. If any system is not operational, it could be the cause of the start-pending because the system could still hold an allegiance that it had when it became non-operational. Operator action depends on the condition of the non-operational system:

- If the system is in the check-stop state or in a non-restartable wait state, the operator should immediately initiate an interface reset to that device from the system console of the non-operational system. If the interface reset fails to release the device, the operator should issue a system reset from the system console of the non-operational system.

These actions should be taken before trying to recover the non-operational system, to allow the other operational systems that are sharing I/O with the non-operational system to continue with as little disruption as possible.

- If the system is in the stopped state, the operator should try to determine why it is stopped and, if appropriate, start it again.
- If the system issued message IOS431I, take the actions described in the operator response for that message.

Unconditional reserve/alternate path recovery: Alternate path recovery permits recovery from control unit or channel-path failures that cause a DASD or string of DASDs to be no longer accessible to the system. Alternate path recovery is performed only after the operating system guarantees ownership of the device by ensuring that the device is reserved to this system.

When the operating system can guarantee ownership of the device, alternate path recovery is performed. This consists of issuing an unconditional reserve (UR) CCW on a non-failing, online path to the device. If the UR CCW is successful, the operating system issues message IOS428I. If the UR CCW fails or if there are no alternate paths to the device, the operating system issues message IOS429I and boxes the device.

If ownership of the device cannot be established, the operating system issues message IOS427A to determine which recovery action is to be performed.

To maintain volume data integrity during a shared DASD recovery process, the operator must stop I/O from the sharing systems until the recovery process is complete.

The operator should use the IOACTION STOP command to stop I/O to the device with less disruption to system processing than cancelling jobs or stopping processors.

See Figure 9 on page 75 for an illustration of three systems sharing a device. Use the following recovery scenario when system 1 issues message IOS427A, indicating a device failure.

1. Determine the device number on each sharing system.
2. To stop I/O requests for the device, enter IOACTION STOP,DEV=devnum on system 2 and system 3.
If the IOACTION STOP command fails because the device is reserved or reserve pending, and repeated attempts to stop the I/O using the command continue to fail, then end the reserving task or stop the system.
3. Reply UR to message IOS427A and wait for recovery completion messages on system 1.
4. After the recovery completion messages, enter IOACTION RESUME,DEV=devnum or IOACTION RESUME,ALL on system 2 and system 3 to return I/O processing to normal.

Note:

1. Do not leave devices in the stopped state any longer than necessary to perform recovery. A shortage of SQA storage can result from stopping I/O for extended periods.
2. Before stopping a device, enter the D U,DASD,ALLOC,devnum command to determine which system resource's I/O will be affected. If any system oriented I/O will be stopped, the system could appear frozen. This situation will last until I/O resumes to the device.

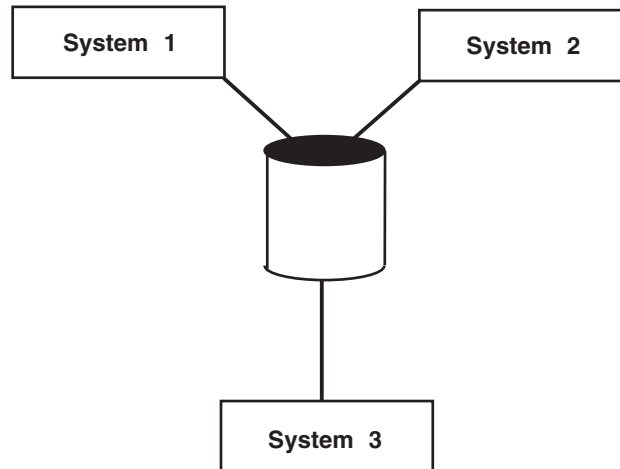

Figure 9. DASD device shared by three systems

DASD maintenance and recovery

DASD can experience failures such as defective disk surfaces, drives, and actuators. When these failures occur, data becomes inaccessible to the operating system and could be lost. To prevent the loss of the data, an installation should consider using the following to monitor possible error conditions and correct any before they cause outages.

- The Environmental Record Editing and Printing (EREP) System Exception Report
- Device Support Facilities (ICKDSF)

When a DASD error does occur, such as a defective track, an installation can use z/OS DFSMSdss to retrieve the data from the defective areas and copy it to a backup DASD.

See the following:

- *IBM Disk Storage Management Guide: Error Handling*
- *ICKDSF User's Guide*
- *EREP User's Guide*
- *z/OS DFSMSdss Storage Administration*

Diagnosing problems in a switched fabric

Devices can be connected to processors via a switched fabric, which consists of one or more FICON® directors in the path from the processor (channels) to the device (control unit). The directors may be a long distance from each other and connected via one or more inter-switch links (ISLs). Switch vendors support a number of different fabric topologies and routing algorithms. The path an I/O request takes through the fabric will vary depending upon the fabric topology and routing algorithm. Therefore, when a problem occurs it can be difficult to determine the cause.

Switched fabric topology terminology

Fibre channel is a networking technology primarily used for storage area networking. FICON itself is a protocol layer created by IBM which builds upon the

fibre channel transport protocol. A switched fabric is a fibre channel topology in which individual node ports are interconnected and managed by switches.

The following terms can be used to describe IBM z Systems hardware and z/OS I/O configuration, along with the equivalent terminology used in a switched fabric:

Director

An I/O router that can connect any input port to any output port, which may be referred to as a *switch*.

Central processor complex (CPC)

A collection of z Systems hardware which is contained in a mainframe (main storage, one or more central processors, and channels), and which may be referred to as a *host system*, or simply a *host*.

Channel (CHPID or PCHID)

A FICON port on a CPC, which may be referred to as a *host port*.

Control unit (CU)

A storage unit, which may be referred to as a *storage system*, or simply *storage*.

Channel path (path)

A series of point-to-point connections that form a route through the network between two communicating nodes, which may be referred to as a *data link*, or simply a *link*.

Exchange

An I/O operation routed through the fabric over a data link.

Figure 10 on page 77 shows an example of a switched fabric.

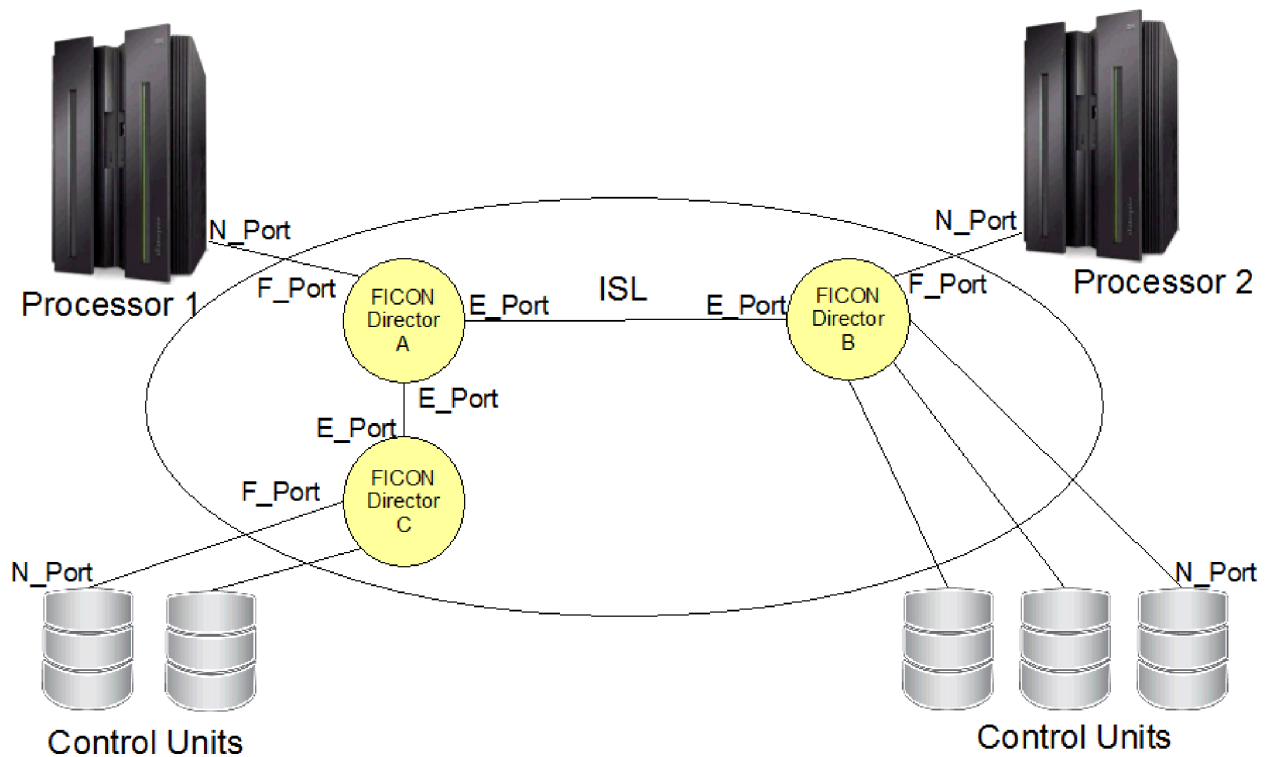

Figure 10. Example of a switched fabric

In Figure 10, fibre channel connection types are labeled using the convention `_Port`, prefixed by one or more letters to signify the type of connectivity they provide in the fabric infrastructure. The hardware components have one or more of the following ports:

N_Ports

Node ports, which are on a host or storage system.

F_Ports

Fabric ports, which are on a switch and provide connections between a node and the network.

E_Ports

Expansion ports, which are on a switch and connect to other switches, sometimes by means of inter-switch links (ISLs).

Fabric login is the process by which an N_Port (control unit or channel) registers its presence and establishes the route through the fabric. This occurs during initialization of the channel and the control unit.

An entry port is the F_Port or E_Port where the I/O enters the switch, and an exit port is the F_Port or E_Port where the I/O leaves the switch. Entry and exit ports are relative to the direction of the route (channel to control unit, or control unit to channel) and location within the route. The switch type is also determined by the route through the fabric. If there is only one switch, then the switch type is the *only director*. If more than one switch, the first entry port is attached to the *source director* and the last exit port is attached to the *destination director*. The switches between the source director and the destination director are known as *intermediate directors*.

Figure 11 shows two switches, each acting as a source director and destination director depending on the direction of the I/O flow.

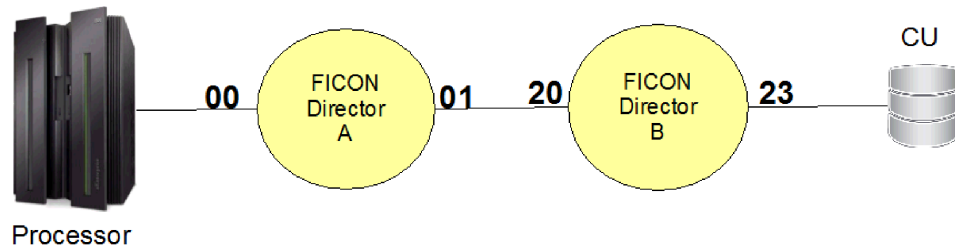

Figure 11. Example of source and destination directors

If the direction of the I/O is from the processor (source) to the CU (destination), port 00 is the entry port to Director A (Source Director), port 01 is the exit port. Port 20 is the entry port to Director B (destination Director) and port 23 is the exit port.

If the direction of the I/O is from the CU (source) to the processor (destination), port 23 is the entry port to Director B and port 20 is the exit port. Port 01 is the entry port to Director A and port 00 is the exit port.

Routing and grouping methods: Fibre channel infrastructure can further be described by the methods used to route I/O requests through the fabric, as well as how multiple links are grouped to form a logical link. The names of the routing and grouping methods described here are vendor-neutral. Different switch vendors have different names for their routing methods (for example, OXID and exchanged based routing) and grouping methods (for example, trunking).

Static routing: When static routing is in effect, a route through the fabric is assigned at fabric login time. If there is a link failure on the assigned route, one of the alternate routes is used. Figure 12 shows an example of static routing.

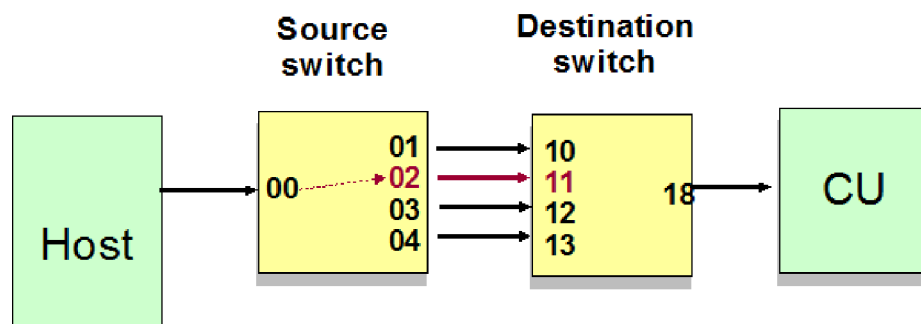

Figure 12. Example of static routing in a switched fabric

Figure 12 shows a static path from port 00 to port 02 with three alternate paths. If the link between port 02 and port 11 fails, one of the alternate ports (01, 03, or 04) will be used.

Dynamic routing: When dynamic routing is in effect, each I/O request (exchange) can take a different path through the fabric. If a link failure occurs, any eligible path will be used. The algorithm used to determine how I/O requests are routed through the fabric, as well as how eligible paths are determined, is specific to each

implementation and vendor. For example, I/O requests may be distributed across the different paths according to the available bandwidth. Additionally, the set of eligible paths may be determined at fabric build or fabric login time.

Figure 13 shows an example of dynamic routing.

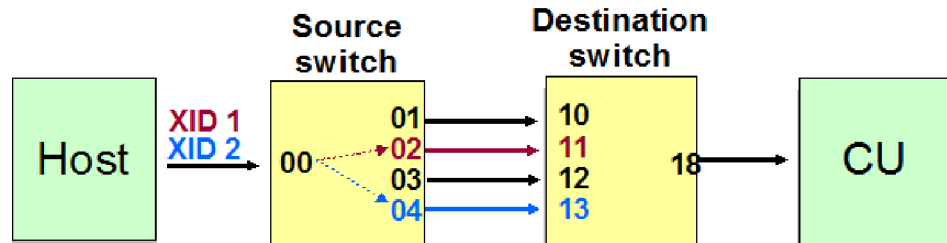

Figure 13. Example of dynamic routing in a switched fabric

I/O requests, or exchanges, from port 00 can use either port 01, 02, 03, or 04. Exchange 1 (XID 1) uses port 02; exchange 2 (XID 2) uses port 04.

Link aggregation: Aggregation means that multiple ISLs are logically grouped to act as a single, higher bandwidth ISL. If there is a link failure, the affected link is removed. The path is intact as long as one link in the aggregation is active. Aggregation can be used with either static or dynamic routing. The formation of aggregate links and how traffic is distributed between the eligible links is vendor-specific.

Figure 14 shows an example of link aggregation.

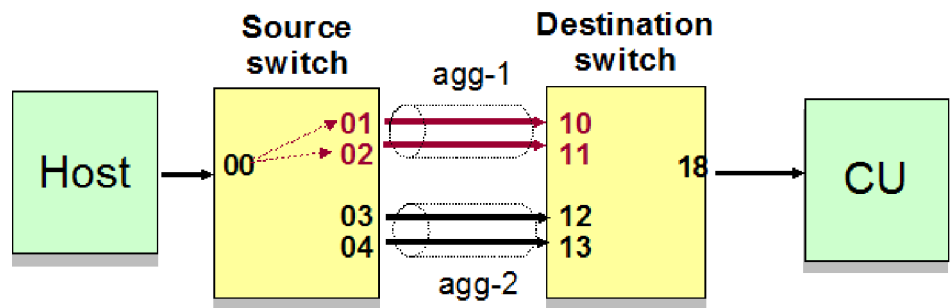

Figure 14. Example of link aggregation

In Figure 14, I/O requests are routed to the aggregate consisting of ports 01 and 02 (agg-1). This aggregate acts as a single logical link and frames can be routed through either ISL. If one link in agg-1 fails, agg-1 will still be used since there is a second functioning link. If both links through agg-1 fail, then the second aggregate consisting of ports 03 and 04 (agg-2) may be used. This example shows an aggregate link used with static routing. However, this is applicable to dynamic routing as well.

Control unit port function

The control unit port (CUP) function allows a z/OS system to communicate with the FICON Director through channel programs. This includes control functions like blocking and unblocking ports, performance monitoring, and error reporting functions.

The CUP device is simulated as a special firmware load on the switch that allows a z/OS system to issue channel programs to it. The CUP device is defined in the I/O configuration as a switch device and is brought online to z/OS. The control unit definition for the CUP device consists of one or more channel paths attached to the switch with the reserved port address destination of 0xFE, which is defined by the FICON architecture as the address of the control unit port (CUP). Therefore, I/O requests routed to this destination port are directed to the CUP.

Symptoms and causes of fabric problems

Problems within a switched fabric may be surfaced in different ways. This topic describes some common issues within a fabric and their possible causes.

Symptoms of problems within the fabric: Symptoms of a fabric problem can be externalized through console messages or information within displays or reports. Some common symptoms that may develop and examples of message IDs that may be displayed as a result of a problem within the fabric are:

- Path is not available (IOS001E, IOS002A)
- Errors on channel (IOS050I)
- Missing interrupts (IOS071I)
- Time out errors (IOS051I)
- Long command response time one or more channel paths (for example, RMF™ I/O Queuing report)
- Alert messages from the switch indicating problems within the fabric
- Fenced port
- High port error counts
- High port utilization

Causes of fabric problems: Errors within the fabric can be caused by either software or hardware problems. Some of the potential issues that can cause problems in the fabric are:

- Defective cables or optics
- Congestion within the fabric
- I/O or switch configuration problems, such as incorrect cabling or routing
- Channel or control unit hardware or firmware issues
- I/O configuration definition errors

Detection and reporting of fabric problems

There are several tools that can be used to assist in the detection and analysis of fabric problems. This topic briefly describes some of these tools.

RMF reports: RMF provides online, interactive performance monitoring and long-term overview reporting with post-processor reports. Some RMF reports that can assist in analysis of fabric problems are:

- Channel path activity report
- Device activity report
- I/O queueing activity report
- FICON Director activity report
- Enterprise Disk Systems (ESS) report

See *z/OS RMF Report Analysis* for more information about these reports.

DISPLAY M=DEV command: The **DISPLAY M=DEV** command allows you to display the route through the storage area network (SAN) fabric for a specific device and channel path by specifying the **ROUTE** keyword. The routing information includes all of the switches and ports that are in the path from the channel to the device. If the **HEALTH** keyword is specified, health information such as the utilization, optical signal strength, and the state of each port ID is also displayed. Reporting of routing and health information will only be performed when the channel is connected to a switch and the control unit definition for the channel path is defined in the I/O configuration with a two-byte link address. See the description of the **D M=DEV** command in “Displaying system configuration information” on page 368 for more information about the syntax for this command.

In the routing portion of the display output, information for each switch in the path is displayed, which includes its domain and switch type. The definition of the switch type depends upon the number of switches in the path between the channel and device, and the position of the switch within the path. If there is only one switch, the switch type is shown as **Only Director**. If there is more than one switch, the first switch is known as the **Source Director** and the last switch is known as the **Destination Director**. If there are any switches between the source director and the destination director, each of those switches is known as an **Intermediate Director**.

For each entry and exit port, information about what is physically and logically connected to that port is displayed under the **From** and **To** columns. A physical connection means that the port is connected via a fibre optic link to a channel, control unit, or another switch. That is, there is a physical link between the port and the other end of the link. A logical connection means that frames from this port are routed to one or more ports on the same switch. However, there is no physical link between these ports.

- For entry ports, the physical connection appears under the **From** column and represents either a channel, control unit, or a single port on another switch. The logical connection appears under the **To** column and represents a single port or a group of ports on the same switch, depending on the routing and grouping methods.
- For exit ports, the logical connection appears under the **From** column and always represents a single entry port on the same switch. The physical connection appears under the **To** column and represents either a channel, control unit, or a single port on another switch.

For example, the entry port on the first switch (source director) is physically connected to a channel but logically connected to one or more exit ports on the same switch. The exit ports on the first switch are logically connected to the entry port on that switch, but are physically connected via ISLs to entry ports on the next switch.

Note that the definition of what is considered an entry port or exit port depends on the direction of the display request: channel to device (**TODEV**) or device to channel (**FROMDEV**). For example, when **TODEV** is specified, the port that is connected to the channel is considered an entry port and the port connected to the control unit is considered an exit port. However, if **FROMDEV** is specified, the roles are reversed.

When a port is connected to a channel, Chan appears under the **From** or **To** columns of the display, depending on which direction was specified. Likewise, when a port is connected to a control unit, CU appears in the display.

When an entry or exit port is connected to a single switch port, the domain and port number are displayed as a four-digit number under the **From** or **To** columns.

When an entry port is connected to multiple ports on the current switch, a dynamic or aggregate group number is displayed under the **To** column, depending on the routing and grouping methods used. This is described in more detail later.

When an entry port uses static routing, the exit port or aggregate group number assigned to the port and the number of alternate paths are displayed. Detailed information about the alternate paths is not displayed.

When an entry port uses dynamic routing, the set of eligible exit ports is assigned a dynamic group number. This group number appears in two places. First, it appears under the **Dyn** column for the exit port to show which ports make up the dynamic group. Second, it appears under the **To** column for the entry port to show that it is associated with this dynamic group of ports. The value that is assigned for the dynamic group number is switch vendor-specific.

When a set of entry or exit ports are part of an aggregate group of ports, those ports are assigned an aggregate group number. This group number appears in two places. First, it appears under the **Agg** column to show which ports make up the aggregate group. Second, if I/O requests are being statically routed from an entry port to this aggregate set of ports, then the aggregate group number appears under the **To** column of the entry port. The value that is assigned for the aggregate group number is switch vendor-specific.

For the health portion of the display, a description of the health of the fabric, each switch, and each port is displayed, as well as the following information for each port:

- The % transmit/receive utilization indicates the percent utilization of the total transmit or receive bandwidth available at the port.
- The % transmit delay is the percent of time that the frame transmission was delayed because no buffer credits were available on the port. The % receive delay is the percent of time that the port was unable to receive frames because all receive frames were utilized.
- The error count is the number of errors detected on the port affecting the transmission or receipt of frames on the port. This is a sum of the errors counted over the fabric diagnostic interval, which is set to 30 seconds by z/OS.
- The optical signal column indicates the signal strength of the fibre optic signal being transmitted/received by this port, in units of dBm.

Example 1: Static routing with aggregate links: Figure 15 on page 83 shows an example of static routing, where frames for the I/O exchange go to one assigned port.

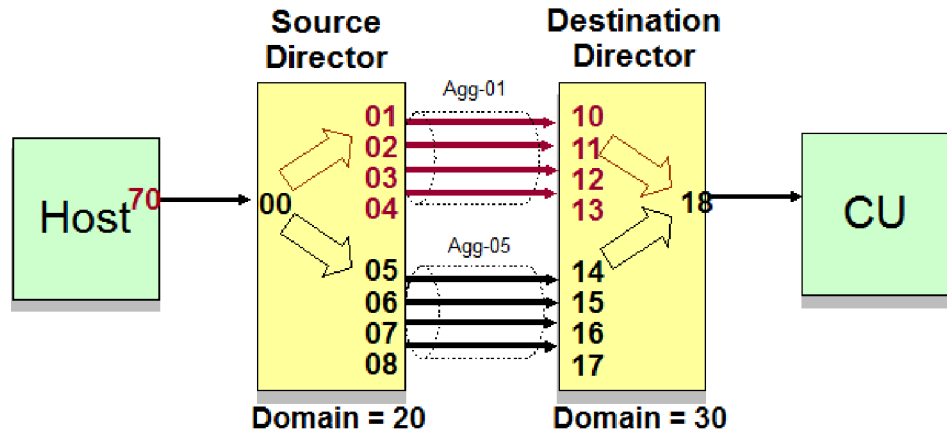

Figure 15. Example of static routing with aggregate links

D M=DEV command output for Example 1

The **DISPLAY** command in this example is requesting the routing and fabric health information for a specific path, from the channel port 70 to the port for device 2000 (**TODEV**). The output shown here includes only the routing and health portions of the message. Other information from the **D M=DEV** command that precedes this information is not shown.

D M=DEV(2000, (70)),ROUTE=TODEV,HEALTH

```
IEE583I hh.mm.ss DISPLAY M 058
DEVICE sddd STATUS=ONLINE
```

Source to destination routing information follows:

Switch Domain=20, Type=Source Director

Port	Type	From	To	Group	Agg	Dyn	Speed	Misc
00	Entry	Chan	Agg-01	8G	Static Alt=1
01	Exit	2000	3010	01	8G	
02	Exit	2000	3011	01	8G	
03	Exit	2000	3012	01	8G	
04	Exit	2000	3013	01	8G	

Switch Domain=30, Type=Destination Director

Port	Type	From	To	Group	Agg	Dyn	Speed	Misc
10	Entry	2001	3018	01	8G	Static Alt=1
11	Entry	2002	3018	01	8G	Static Alt=1
12	Entry	2003	3018	01	8G	Static Alt=1
13	Entry	2004	3018	01	8G	Static Alt=1
18	Exit	Mult	CU	8G

From the example output, you can see that the route from the channel to the device travels through two switches, domains 20 and 30, with domain 20 being the source director and domain 30 being the destination director. The channel is connected to entry port 00 on switch domain 20, as indicated by the **From** column for that port. The **To** column for the same port indicates that I/O requests originating from this port are routed to aggregate 01. From the **Group Agg** column, you can also determine that aggregate 01 consists of exit ports 01, 02, 03, and 04 on the switch. Each of these exit ports is connected to a different port on switch domain 30, as shown in the **To** column for the ports. For example, port 03 routes I/O to port 12 on domain 30. The speed listed is the negotiated speed, in gigabits per second.

The information for the destination director 30 can be interpreted in a similar manner. Entry ports 10,11,12, and 13 are all within aggregate group 01 and route the I/O requests to port 18 on the same switch. Notice that port 18 will have data routed to it from multiple entry ports on the switch. Since there is not a single originating port to identify, the **From** column contains Mult. Port 18 is not part of an aggregate group and therefore contains .. in that column. The control unit is connected to port 18.

Note that, in this static routing example, the data for aggregate 05 is not displayed; however, the information in the **Misc** column indicates that I/Os are statically routed and there is one alternate route defined.

Health display for Example 1

The following output shows the health display for Example 1:

Health information follows:

Fabric Health=Port Error

Switch Domain=20, Health=No health issues

Port	Health	%Util	%Delay	Error Count	Opt Signal
		Trn/Rcv	Trn/Rcv	Trn/Recv	Trn/Recv
00	Port Normal	0/0	0/0	0/0	-4.8/-6.6
01	Port Normal	0/0	0/0	0/0	-2.4/-2.0
02	Port Normal	0/0	0/0	0/0	-2.4/-2.1
03	Port Normal	0/0	0/0	0/0	-4.9/-6.6
04	Port Normal	0/0	0/0	0/0	-2.1/-2.3

Switch Domain=30, Health=Port Error

Port	Health	%Util	%Delay	Error Count	Opt Signal
		Trn/Rcv	Trn/Rcv	Trn/Recv	Trn/Recv
10	Port Fenced	0/0	0/0	0/0	../-6.7
11	Port Normal	0/0	0/0	0/0	-2.4/-2.7
12	Port Normal	0/0	0/0	0/0	-2.1/-2.4
13	Port Normal	0/0	0/0	0/0	-2.4/-2.1
18	Port Normal	0/0	0/0	0/0	-2.4/-2.1

This example of the health data shows that there is a health problem within the fabric, on switch domain 30, as shown by the fabric and switch text Port Error. Switch domain 20 shows no health problems, but port 10 on switch domain 30 shows that the port has been fenced. The text provided in the fabric health, switch health, and port health is switch vendor-specific. If any data is not valid, .. is displayed in the appropriate column.

Example 2: Dynamic routing: Figure 16 on page 85 shows an example of dynamic routing, where frames for the I/O exchange may be routed to any of the eligible ports. Each of the dynamic paths consists of two aggregate groups. Aggregate group 01 (Agg-01) consists of ports 01 and 02 and aggregate group 03 (Agg-03) consists of ports 03 and 04.

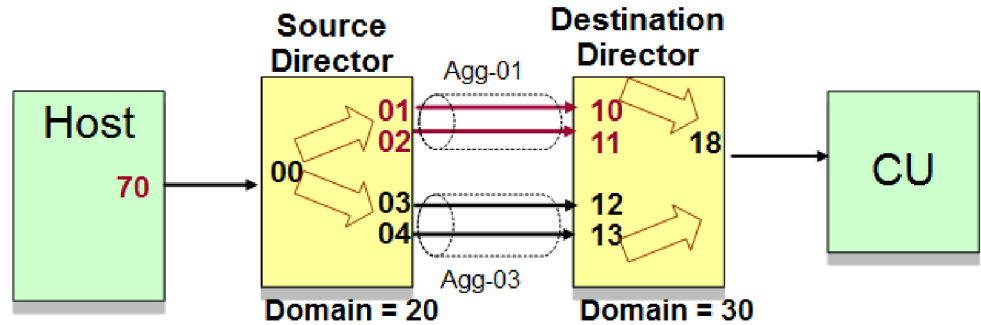

Figure 16. Example of dynamic routing

D M=DEV command output for Example 2

The **DISPLAY** command in this example is requesting the routing information for a specific path from the channel port 70 to the port for device 2000 (**TODEV**):

```
D M=DEV(2000, (70) ),ROUTE=TODEV
IEE583I hh.mm.ss DISPLAY M 058
DEVICE sddd STATUS=ONLINE
```

Source to destination routing information follows:

```
Switch Domain=70, Type=Source Director
      Group
Port Type From To Agg Dyn Speed Misc
00 Entry Chan Dyn-01 .. .. 8G Dynamic
01 Exit 2000 3010 01 01 8G
02 Exit 2000 3011 01 01 8G
03 Exit 2000 3012 03 01 8G
04 Exit 2000 3013 03 01 8G
```

```
Switch Domain=30, Type=Destination Director
      Group
Port Type From To Agg Dyn Speed Misc
10 Entry 2001 3018 01 .. 8G
11 Entry 2002 3018 01 .. 8G
12 Entry 2003 3018 03 .. 8G
13 Entry 2004 3018 03 .. 8G
18 Exit Mult CU .. .. 8G
```

You can interpret the output in this example in a similar manner as in “D M=DEV command output for Example 1” on page 83. It shows that the route direction is from the channel to the device and travels through two switches. The entry and exit ports for each switch in this route are identified, along with the entity to which the port is connected on both ends. Notice that dynamic routing is being used, as noted by the **Misc** column. I/O requests for device 2000 originating from CHPID 70 are dynamically routed to dynamic group 01. The **Group Dyn** column shows that exit ports 01, 02, 03, and 04 are all in dynamic group 01, and the **Group Agg** column shows that these exit ports are in two distinct aggregate groups, 01 and 03. Dynamic routing does not apply to the ports on switch domain 30 for I/O requests in this direction; therefore, those ports contain .. in the **Group Dyn** column. In the dynamic routing scenario, all ports are displayed.

Health checks: This topic describes some of the health checks that can help detect and analyze fabric problems.

Command response time monitoring and reporting: The command response (CMR) time monitor detects any abnormally high command response time that could indicate a SAN problem. CMR time is a component of response time and measures

the round trip delay of the fabric, along with minimal channel and control unit involvement. By monitoring this measurement and comparing it among the paths to a control unit, fabric problems, such as hardware errors, misconfiguration, and congestion, can be more easily detected. In addition, inconsistent command response times will trigger fabric monitoring which is described in “Fabric monitoring and reporting” on page 87.

The CMR health check (IOS_CMRTIME_MONITOR) reports on any exceptions detected by the monitor. The check issues an exception if at least one control unit in the system has a path with an average CMR time that is significantly higher than the other paths to the control unit. See *IBM Health Checker for z/OS User's Guide* for more information about this health check.

The following example shows the command response time health check report output. In this example, the threshold value is 3, and the ratio value is 5. This means that, for an exception to be reported, the average command response time must be greater than three milliseconds, and the CHPID with the highest average CMR time must be at least five times greater than the CMR time for the CHPID with the lowest average response time.

```
CHECK(IBMIOS,IOS_CMRTIME_MONITOR)
SYSPLX: LOCAL SYSTEM: SY1
START TIME: 04/23/2013 15:29:05.310858
CHECK DATE: 20100501 CHECK SEVERITY: MEDIUM
CHECK PARM: THRESHOLD(3),RATIO(5),XTYPE(),XCU()
```

IOSHC113I Command Response Time Report

The following control units show inconsistent average command response (CMR) time based on these parameters:
 THRESHOLD = 3
 RATIO = 5

```
CMR TIME EXCEPTION DETECTED AT: 04/23/2013 15:25:08.971846
CONTROL UNIT = 0500
ND = 002107.000.IBM.PK.000000000002
```

CHPID	ENTRY LINK	EXIT LINK	CU INTF	I/O RATE	AVG CMR
14	B153	B177	0001	16.486	2.560
44	B353	B375	0012	13.245	5.592
16	B055	B277	0013	13.245	25.60
46	B154	B376	0104	13.112	4.941
47	B155	B377	0105	0	***

* Medium Severity Exception *

```
IOSHC112E Analysis of command response (CMR) time detected one or more control units with an exception.
```

In the example output, you can see that the CMR time for CHPID 16 is the highest, and is greater than five times that of CHPID 14, which reports the lowest average response time. Also, note that CHPID 47 does not indicate an average response time, which means it is offline or has no significant data to report.

I/O rate monitoring and reporting: The I/O rate monitor detects any control units in the system that are reporting inconsistent I/O rates for their attached channel paths. I/O rate is the number of I/O requests started down the channel path, per second. The system typically distributes I/O requests equally across all paths for a control unit. When the system determines that there is a performance problem with a path, it will direct I/O requests away from that path, resulting in inconsistent I/O rates across the paths. Therefore, a lower than average I/O rate

can be a symptom of potential problems in the fabric. By monitoring this measurement and comparing it among the paths to a control unit, fabric problems similar to those detected by the CMR monitor can be surfaced. In addition, an inconsistent I/O rate will trigger fabric monitoring, which is described in “Fabric monitoring and reporting.”

The I/O rate health check (IOS_IORATE_MONITOR) reports exceptions detected by the I/O rate monitor. The check issues an exception if at least one control unit in the system has a total I/O rate across all of its channel paths that exceeds a user-specified threshold value, and at least one path with an I/O rate significantly lower than that of the channel path with the highest I/O rate for the control unit. The I/O rate health check runs on a zEnterprise® EC12 (zEC12) or later processor. See *IBM Health Checker for z/OS User's Guide* for more information about this health check.

The following example shows the I/O rate health check report. In this example, the threshold value of 100 indicates that the total I/O rate across all of the CHPIDs must exceed 100 I/Os per second, which it does. The ratio value of 2 means that any CHPID that has an I/O rate of less than a factor of 2 (that is, one-half) of the CHPID with the highest I/O rate would be flagged.

```
CHECK(IBMIOS,IOS_IORATE_MONITOR)
SYSPLEX: LOCAL SYSTEM: SY1
START TIME: 04/22/2013 08:44:14.271360
CHECK DATE: 20120430 CHECK SEVERITY: MEDIUM
CHECK PARM: THRESHOLD(100),RATIO(2),XTYPE(),XCU()
```

IOSHC133I I/O Rate Report

The following control units show inconsistent I/O rates based on these parameters:
 THRESHOLD = 100
 RATIO = 2

I/O RATE EXCEPTION DETECTED AT: 04/22/2013 08:44:14.254730
 CONTROL UNIT = 0500
 ND = 002107.000.IBM.PK.000000000002

CHPID	ENTRY LINK	EXIT LINK	CU INTF	I/O RATE	AVG CMR	IOR EXC
14	B153	B177	0001	39.603	2.560	*
44	B353	B375	0012	101.38	2.112	
16	B055	B277	0013	98.019	2.134	
46	B154	B376	0104	50.693	2.048	
47	B155	B377	0105	***	***	

* Medium Severity Exception *

IOSHC132E Analysis of I/O rates detected one or more control units with an exception.

Notice that the I/O rate for CHPID 14 is less than half that of CHPID 44 and, therefore, is marked with an asterisk in the **IOR EXC** column. If there are multiple paths that were significantly below the threshold, all such CHPIDs would be marked as having an exception. Also note that CHPID 47 is likely offline, as indicated by the *** for the I/O rate.

Fabric monitoring and reporting: The fabric monitor begins collecting routing and health information from the switch periodically after it is triggered by one of the following unusual conditions:

- Command response time monitoring or I/O rate time monitoring detected a discrepancy.
- The switch presents an alert message indicating a problem within the fabric.
- An IFCC or interface time out occurs due to errors that occurred between the channel and source port or the CU and the destination port.

Fabric monitoring and reporting can only occur when the channel is connected to a switch device and the control unit definition for the path is defined in the IODF with a two-byte link address.

Until the route is healthy (no unusual conditions are detected for an extended period of time), diagnostic information about the affected source or destination route will be obtained from the switch by the monitor at an internally defined interval. Many routes can be monitored simultaneously.

The fabric monitor health check (IOS_FABRIC_MONITOR) exposes possible issues by generating exceptions and reports for the routes being monitored. The routing and health data obtained by the monitor is reproduced in the report for analysis. The content and format of this data is similar to the output of the **D M=DEV** command (described in “DISPLAY M=DEV command” on page 81) with the ROUTE=BOTH, HEALTH options. See *IBM Health Checker for z/OS User's Guide* for more information about this health check.

The following example shows the output for the fabric monitor health check report. In this example, an exception is being reported because port 81 on switch C3 is fenced. The complete routing and health information for the path is provided for diagnostic purposes.

```
CHECK(IBMIO5,IOS_FABRIC_MONITOR)
START TIME: 04/29/2013 17:34:09.652404
CHECK DATE: 20130329 CHECK SEVERITY: MEDIUM
CHECK PARM: LOG(YES),SHOW(LATEST)
```

IOSHC120I Fabric Health Report

The following channel paths show fabric health issues:

```
FABRIC HEALTH EXCEPTION DETECTED AT: 04/29/2013 17:31:18.301627
CHPID=00, Entry link=C181, Exit link=C310, Suspect port=**
```

Source to destination routing information follows:

```
Switch Domain=C1, Type=Source Director
      Group
Port Type From To Agg Dyn Speed Misc
00 Entry Chan Dyn-01 .. .. 8G Dynamic
81 Exit C100 C381 .. 01 8G
82 Exit C100 C382 .. 01 8G
```

```
Switch Domain=C3, Type=Destination Director
      Group
Port Type From To Agg Dyn Speed Misc
81 Entry C181 C310 .. .. 8G
82 Entry C182 C310 .. .. 8G
10 Exit Mult CU .. .. 8G
```

Health information follows:

Fabric Health=Port Error

Switch Domain=C1, Health=No health issues

Port Health	%Util Trn/Rcv	%Delay Trn/Rcv	Error Count Trn/Recv	Opt Signal Trn/Recv
-------------	---------------	----------------	----------------------	---------------------

00	Port Normal	0/0	0/0	0/0	-4.5/-7.4
81	Port Normal	0/0	0/0	0/0	-2.4/-2.9
82	Port Normal	0/0	0/0	0/0	-4.5/-7.4

Switch Domain=C3, Health=Port error

Port Health	%Util Trn/Rcv	%Delay Trn/Rcv	Error Count Trn/Recv	Opt Signal Trn/Recv
81 Port Fenced	0/0	0/0	0/0	./-6.7
82 Port Normal	0/0	0/0	0/0	-2.4/-2.1
10 Port Normal	0/0	0/0	0/0	-4.5/-7.4

Destination to source routing information follows:

Switch Domain=C3, Type=Source Director

Port	Type	From	To	Group	Agg	Dyn	Speed	Misc
10	Entry	CU	Dyn-02		8G	Dynamic
81	Exit	C310	C181	..	02		8G	
82	Exit	C310	C182	..	02		8G	

Switch Domain=C1, Type=Destination Director

Port	Type	From	To	Group	Agg	Dyn	Speed	Misc
81	Entry	C381	C100		8G	
82	Entry	C382	C100		8G	
00	Exit	Mult	Chan		8G	

Health information follows:

Fabric Health=Port Error

Switch Domain=C3, Health=Port Error

Port Health	%Util Trn/Rcv	%Delay Trn/Rcv	Error Count Trn/Recv	Opt Signal Trn/Recv
10 Port Normal	0/0	0/0	0/0	-2.4/-7.4
81 Port Fenced	0/0	0/0	0/0	./-7.4
82 Port Normal	0/0	0/0	0/0	-2.4/-7.4

Switch Domain=C1, Health=No health issues

Port Health	%Util Trn/Rcv	%Delay Trn/Rcv	Error Count Trn/Recv	Opt Signal Trn/Recv
81 Port Normal	0/0	0/0	0/0	-2.4/-7.4
82 Port Normal	0/0	0/0	0/0	-2.4/-7.4
00 Port Normal	0/0	0/0	0/0	-2.4/-7.4

* Medium Severity Exception *

IOSHC119E Fabric health issues have been detected

Dynamic routing consistency reporting: The dynamic routing health check (IOS_DYNAMIC_ROUTING) identifies any inconsistencies in the dynamic routing support within the SAN. In order for dynamic routing to function properly, dynamic routing must be supported at all endpoints, the channel and connected devices, communicating through the switches. When dynamic routing is enabled in the SAN, the health check will verify that the processor and attached DASD, tape, and non-IBM devices defined as type CTC support dynamic routing and will identify those endpoints that do not. See *IBM Health Checker for z/OS User's Guide* for more information about this health check.

The following example shows the output for the dynamic routing health check report. In this example, dynamic routing is enabled in the SAN; however, there are two storage controllers that do not support dynamic routing.

```
CHECK(IBMIO,IOS_DYNAMIC_ROUTING)
SYSPLEX: LOCAL SYSTEM: SY1
START TIME: 06/26/2013 12:31:18.246880
CHECK DATE: 20130601 CHECK SEVERITY: MEDIUM
```

IOSHC144I Dynamic routing is enabled in the SAN but not supported by the following controllers:

```
NODE DESCRIPTOR
002107.932.IBM.75.000000000002
002107.951.IBM.75.000000004F01
```

* Medium Severity Exception *

IOSHC142E Dynamic routing inconsistencies were detected
...

Additional recovery actions

This section includes these topics:

- Recovery by CPU restart

Recovery by CPU restart

The operator can initiate recovery from some system incidents, such as loops and uncod ed wait states, by issuing a restart to the processor that has the problem. The restart reason that is entered as part of the restart process directs the system to perform one of two recovery actions:

Restart reason 0

The system tries to display message IEA500A on the first two consoles defined as master or alternate and locally attached to the system issuing the message. The message identifies the current unit of work on the target processor. The operator can reply either:

- RESUME to allow the current unit of work to continue
- ABEND to end that unit of work with an abend X'071'

If the operating system cannot communicate with the either console to issue message IEA500A, it ends the current unit of work with an abend X'071'.

Restart reason 1

The operating system:

- Interrupts the current unit of work on the target processor
- Detects and attempts to repair errors in critical system areas
- Writes a logrec data set error record for completion code X'071' with reason code 4 when repair actions were taken
- Reports the results of some of the actions taken in message IEA501I
- Returns control to the interrupted unit of work

Note: Restart of the CPU in a restartable wait state ignores the restart reason.

See Chapter 4, "MVS system commands reference," on page 153 for information about restart.

Chapter 2. System Reconfiguration

Reconfiguration is the process of adding hardware units to, or removing hardware units from, a configuration. Units can be either:

- **Online:** Units in use by a system are called *online*. When both physically and logically online, a unit is available to be used by the system.
- **Offline:** Units not in use by a system are called *offline*. When either physically or logically offline, a unit is not available to be used by the system.

An installation can use reconfiguration to:

- Adapt a system to changing work loads by configuring units online or offline as required.
- Perform maintenance on a part of a complex while the other part continues normal operation.
- Possibly recover system operation by configuring failing units offline.

Hardware unit or units may be put offline before initialization of the system or systems. To do this, an operator can deselect through the system console such units as central processors (CPU), storage elements, or channel paths. Note that an operator should never deselect a unit during system operation, because the operating system is not notified of the removal.

During system operation, the operating system configures failing units offline with or without any intervention. When intervention is needed, the operator:

- Can enter a CONFIG command that identifies the CONFIGxx member of Parmlib that specifies the reconfiguration. (See *z/OS MVS Initialization and Tuning Reference*.)
- Can enter a CONFIG or VARY command that directly configures units online or offline. (See Chapter 4, “MVS system commands reference,” on page 153.)

For maintenance of hardware, prepare reconfiguration actions to configure hardware units offline for repair and back online so the system can use them. Also, hardware units and channel paths are reconfigured offline then online during reconfiguration of partitionable systems.

Dynamic I/O configuration

Dynamic I/O configuration lets you change your I/O configuration without causing a system outage. In other words, you can select a new I/O configuration definition without performing a power-on-reset (POR) of the hardware or an initial program load (IPL) of the z/OS system. Using I/O definition files (IODFs) created through hardware configuration definition (HCD), dynamic I/O configuration allows you to add, delete, or modify the definitions of channel paths, control units, and I/O devices to the software and hardware I/O configurations. You can change the I/O configuration definitions to both software and hardware or software only. (See *z/OS HCD Planning*.)

Dynamic I/O configuration has the following benefits:

- Increases system availability by allowing you to change the I/O configuration while z/OS is running, thus eliminating the POR and IPL for selecting a new or changed I/O configuration definition.

- Allows you to make I/O configuration changes when your installation needs them rather than wait for a scheduled outage to make the changes.
- Minimizes the need to over-define an I/O configuration by logically defining hardware devices that do not physically exist.

Logical and physical reconfiguration

Logical reconfiguration allows or prevents use of a resource by the operating system. Physical reconfiguration allows or prevents use of a resource by the hardware. An operator can enter a CONFIG command on the console with master authority to logically and physically reconfigure the following hardware units, if applicable for the particular processor complex:

- CPUs
- Central storage elements
- Central storage increments
- Channel paths
- I/O devices

Also, when an operator issues a CONFIG CPU command to reconfigure a processor, the system logically reconfigures any Integrated Cryptographic Feature (ICRF) attached to the processor.

Note: Physical reconfiguration may not be supported for all hardware units by all processor models. (See *Functional Characteristics*).

Reconfiguration support according to processor types

The reconfiguration functions supported by z/OS depend on the configuration of the processor complex, as follows.

Uniprocessor (UP)

Depending on the processor type, an installation can configure offline some or all of the following:

- Central storage elements
- Central storage increments
- Channel paths
- I/O devices

In a UP system, the purpose of reconfiguration is to configure offline failing units to allow the system to continue operation.

Multiprocessor (MP)

Depending on the processor type, an installation can configure offline some or all of the following:

- Central processors, including any associated ICRFs
- Central storage elements
- Central storage increments
- Channel paths
- I/O devices

Reconfiguring a central processor

When configuring a central processor offline, the operating system stops dispatching work to the processor and takes it logically offline. Then the system stops the processor removes it physically from the configuration, if physical central processor reconfiguration is supported by the machine.

Actions to reconfigure a central processor offline

1. Enter a CONFIG CPU(x),OFFLINE command on a console with master authority. The system responds on the console on which the command was entered.
The operating system rejects a CONFIG CPU(x),OFFLINE command when:
 - The target processor is the only online processor.
 - The target processor is the only processor with an operative timer.
 - Alternate CPU recovery (ACR) occurs during OFFLINE processing.
 - Any active jobs have processor (CPU) affinity with the target processor.
2. If you enter a CONFIG command for a central processor and currently scheduled jobs have CPU affinity for that processor, the system issues message IEE718I to list the jobs. Do the following:
 - a. Prevent the operating system from scheduling any additional jobs, by replying YES to message IEE718D.
 - b. Either wait for the active jobs to complete or cancel them.
Note that replying YES to message IEE718D leaves the target central processor unavailable for affinity job scheduling. If you want to restore the central processor to its original state, enter CONFIG CPU(x),ONLINE to restore the original central processor status and make the target central processor available for affinity job scheduling.
 - c. Reenter the CONFIG CPU(x),OFFLINE command.

Reconfiguring a central processor with an ICRF

The operator cannot directly reconfigure an ICRF. When the operator uses the CONFIG command to reconfigure a central processor with an associated ICRF, the system changes the online/offline status of both the central processor and the associated ICRF as follows:

- When the operator enters a CONFIG CPU(x), ONLINE and Integrated Cryptographic Service Facility/MVS (ICSF/MVS) is active in the processor complex, the system brings the ICRF online.
- When the operator enters a CONFIG CPU(x), OFFLINE command the system takes the ICRF offline.
- When the operator enters a CONFIG CPU(x), ONLINE and ICSF/MVS is not active, the ICRF is not brought online until ICSF/MVS is started.

Actions to bring online a central processor and its ICRF

Central processor x (CPU x) is to be brought online. The processor has an associated ICRF and ICSF/MVS is installed and active in the processor complex.

Enter one of the following commands on a console with master authority; the system responds on the console on which the command was entered:

```
CONFIG CPU(x)
```

```
CONFIG CPU(x), ONLINE
```

When the command completes, the system issues the following messages:

```
IEE504I CPU(x), ONLINE  
IEE504I CRYPTO(x), ONLINE
```

Removing the last ICRF

When a CONFIG command is entered to remove a central processor associated with the last online ICRF, the system issues the following messages:

```
IEE109I CONFIG CPU(x), OFFLINE COMMAND WOULD REMOVE LAST CRYPTO  
IEE325D REPLY U TO CONTINUE CONFIG COMMAND. REPLY C TO CANCEL
```

After *U* is replied to message IEE325D, the system takes the central processor and the ICRF offline.

From that point on, the system abnormally ends any jobs that request cryptographic services using ICSF/MVS. This applies to new jobs and to jobs running in the processor complex at the time the system took the ICRF offline.

Actions to take offline a central processor and its ICRF

Central processor x is to be taken offline. The processor has an associated ICRF.

Enter the following command on a console with master authority; the system responds on the console on which the command was entered:

```
CONFIG CPU(x), OFFLINE
```

When the command completes, the system issues the following messages:

```
IEE505I CPU(x), OFFLINE  
IEE505I CRYPTO(x), OFFLINE
```

Reconfiguring central storage

To place storage offline and then bring it online to be used again, commands can reconfigure central storage increments and central storage elements.

Under PR/SM[™], storage may be reconfigured between logical partitions. See *PR/SM Planning Guide* for a description of storage reconfiguration between logical partitions.

Physical view of central storage

Central storage is physically divided into storage elements (SE). The central storage elements are composed of storage increments. Each storage increment may be composed of two sub-increments:

- One sub-increments contains the even-numbered frames of the increment, such as, 0-kilobyte, 8-kilobyte, 16-kilobyte, and so on.
- The other contains the odd-numbered frames, such as, 4-kilobyte, 12-kilobyte, 20-kilobyte and so on.

The sub-increments of an increment may reside in different storage elements, as follows:

SE0	SE2	SE1	SE3
30-32M Even Frames Reconfigurable	30-32M Odd Frames Reconfigurable	62-64M Even Frames HSA and Preferred	62-64M Odd Frames HSA and Preferred
28-30M Even Frames Preferred	28-30M Odd Frames Preferred	60-62M Even Frames Reconfigurable	60-62M Odd Frames Reconfigurable
26-28M Even Frames Preferred	26-28M Odd Frames Preferred	58-60M Even Frames Reconfigurable	58-60M Odd Frames Reconfigurable
24-26M Even Frames Preferred	24-26M Odd Frames Preferred	56-58M Even Frames Reconfigurable	56-58M Odd Frames Reconfigurable
⋮	⋮	⋮	⋮
⋮	⋮	⋮	⋮
⋮	⋮	⋮	⋮
6-8M Even Frames SQA and Preferred	6-8M Odd Frames Preferred	38-40M Even Frames Reconfigurable	38-40M Odd Frames Reconfigurable
4-6M Even Frames Preferred	4-6M Odd Frames Preferred	36-38M Even Frames Reconfigurable	36-38M Odd Frames Reconfigurable
2-4M Even Frames Preferred	2-4M Odd Frames Preferred	34-36M Even Frames Reconfigurable	34-36M Odd Frames Reconfigurable
0-2M Even Frames V=R and Preferred	0-2M Odd Frames V=R and Preferred	32-34M Even Frames Reconfigurable	32-34M Odd Frames Reconfigurable

Specifying the RSU parameter

To prepare for reconfiguration of central storage, specify an RSU parameter in the IEASYSxx parmlib member or as a parameter during system initialization. The RSU parameter specifies the number of storage units in central storage that the operating system should keep available for reconfiguration.

The RSU storage increments are *reconfigurable* or *non-preferred*. The remaining central storage increments are *non-reconfigurable* or *preferred*.

The default RSU value is 0. If the installation does not specify an RSU value, the default means that the operating system designates ALL installed central storage as preferred. With RSU=0, the system cannot be reconfigured.

However, if you specify an RSU value that is greater than the total amount of real storage available on the system, message IAR026I will be issued by the system during IPL indicating an RSU over-specification condition, and showing the amount of real storage available on the system. This message will be followed by an IAR006A message prompting for a valid RSU value. You must select the right RSU value for the system, otherwise; a large RSU value can ultimately cause system performance problems and degradation. For information about how to choose the correct RSU value, see *z/OS MVS Initialization and Tuning Reference*.

Reference information: See *z/OS MVS Initialization and Tuning Reference* for more information about the RSU parameter.

Reconfigurable storage increments

The central storage that is shared by all processors in a configuration is logically divided into storage increments. For the following example, the installation specified RSU=8 to make half of the storage increments reconfigurable.

Increment	Type
60M	Hardware storage area (HSA) and preferred
56M	Reconfigurable
52M	Reconfigurable
48M	Reconfigurable
44M	Reconfigurable
40M	Reconfigurable
36M	Reconfigurable
32M	Reconfigurable
28M	Reconfigurable
24M	Preferred
20M	Preferred
16M	Preferred
12M	System queue area (SQA) and Preferred
8M	Preferred
4M	Preferred
0M	V=R and Preferred

The HSA cannot be in a storage increment that will be reconfigured. The HSA resides in the five highest megabytes of central storage.

RSU example

Assume that a processor complex has 128 megabytes of central storage and that the storage increment size is 4 megabytes. Such a system has 32 storage increments.

If the system initializes one side with RSU=16, the operating system allocates as reconfigurable the 16 storage increments (64 megabytes) of the offline side.

RSU parameter specification

The RSU values recommended for the least system overhead and maximum capability for reconfiguration are as follows:

Processor	Recommended RSU Value
Uniprocessor	RSU=0
Non-partitionable multiprocessor	RSU=0
Partitionable processor in single-image mode	$\text{RSU} = \frac{\text{Total megabytes of installed central storage}}{2 * \text{Central storage increment size in megabytes}}$
Partitionable processor in physically partitioned mode	$\text{RSU} = \frac{\text{Total megabytes of installed central storage}}{2 * \text{Central storage increment size in megabytes}}$

Assignment of storage frames

Storage containing fixed pages cannot be reconfigured. The operating system assigns storage frames as follows:

Storage	Assignment
Non-preferred and preferred	Normal page allocation requests
Non-preferred and preferred	Short-term page fixes
Preferred	Long-term page fixes for non-swappable jobs

However, if a long-term page fix for a non-swappable job requires storage but the preferred storage units are full, the operating system may convert some non-preferred storage to preferred storage. If so, the amount of storage available for reconfiguration will be less than that specified in the RSU parameter. The operating system issues message IAR005I to notify the operator.

If the operator then tries to configure storage offline in preparation for partitioning, the system tries to free enough central storage to support the request. Central storage and the address ranges assigned to that storage cannot be configured offline either logically or physically until the required amount of storage is available.

The operating system normally tries to assign requests for long-term fixed pages to preferred storage frames when the requesting job was initiated as non-swappable. However, an authorized job can be initiated as swappable and, while running, issue a SYSEVENT macro to make itself non-swappable for a short period of time. The job may request long-term fixed pages that are assigned to non-preferred storage. Usually this request is not a problem because the job shortly makes itself swappable again. The system can free the storage that backs the long-term fixed pages when the job is swapped out when the storage is required for storage reconfiguration.

However, a long-running job may make itself non-swappable for long times and also request short-term fixed pages that cannot be freed until the job ends normally. Some of these requests may be satisfied from non-preferred storage.

Because the frames cannot be freed by paging them out or by swapping out the job, storage reconfiguration may not be possible.

To resolve this problem, specify such jobs in the program properties table (PPT) in the SCHEDxx parmlib member.

Reference information: See *z/OS MVS Initialization and Tuning Reference* for the SCHEDxx member.

Actions to reconfigure central storage

Enter at the console with master authority or in a CONFIGxx parmlib member:

1. CONFIG STOR(E=id),OFFLINE command to configure a central storage element offline
2. CONFIG STOR(E=id),ONLINE command to configure a central storage element online

The system responds on the console on which the command was entered or on the master console for the system processing the CONFIGxx member.

When configuring a central storage element offline, the system may issue message IEE575A to indicate that central storage configuration is waiting to complete. The system may cancel the message in less than a minute. The system may issue and cancel the message several times.

If the message remains on the display for a long time, it indicates that the operating system cannot find sufficient reconfigurable central storage to satisfy the configuration request.

If the system displays message IEE575A for a long time:

1. Enter a DISPLAY M=STOR command to identify the job using the central storage that cannot be freed.
2. Do one of the following:
 - a. Cancel any jobs that are using the storage to allow the storage configuration to complete.
 - b. Reply C to end the storage configuration process.

Any central storage already configured offline remains offline. If desired, bring this central storage element back online by entering a CONFIG STOR(E=x),ONLINE command.

Reconfiguring channel paths

Channel paths may be reconfigured for partitioning and merging. Under PR/SM, channel paths may be reconfigured to move a channel path from one logical partition to another.

Reconfigure channel paths carefully. Reconfiguration can remove connections to DASDs or MCS consoles that are critical to the operation of z/OS. If this occurs, system operation will fail.

Actions to reconfigure channel paths

To configure channel paths, enter the following:

- To configure channel paths individually offline or online:

```
CONFIG CHP(x),OFFLINE  
CONFIG CHP(x),ONLINE
```

- To configure all channel paths owned by a side of a partitionable processor complex:

```
CONFIG CHP(ALL,x),OFFLINE  
CONFIG CHP(ALL,x),ONLINE
```

These commands are particularly useful when partitioning or merging the complex.

- To configure a range of channel paths:

```
CONFIG CHP(x-y),OFFLINE  
CONFIG CHP(x-y),ONLINE
```

The system determines which devices are connected to a channel path and if that path is the last path to a device. To configure offline the last path to a device, enter a CONFIG command with one of the following operands:

- UNCOND operand: To configure offline the last path to an unallocated, online device
- FORCE operand: To configure offline the last path to a device regardless of the state of the device.

To make sure that FORCE is intended, the operating system issues message IEE800D to ask whether to continue or stop the CONFIG command processing.

Enter all the CONFIG commands at a console with master authority. The system responds on the console on which the command was entered.

Reconfiguring I/O devices

To reconfigure I/O devices, enter a VARY ONLINE/OFFLINE command at the console with master authority. For a VARY OFFLINE command for a device that is currently in use, the operating system marks the device 'pending offline'. The operating system makes no further allocations to the device unless the volume mounted on the device is specifically requested.

Because vary offline processing cannot complete until a device is unallocated, either wait until the jobs using the device complete or cancel them.

Before reconfiguring a complex from single-image mode to physically-partitioned mode, complete or cancel any tape volume mounts for devices to be reconfigured. Then enter a CONFIG CHP(ALL,n),OFFLINE,UNCOND command.

If a tape mount is pending when the CONFIG command is entered, the tape drive(s) might not start after they are mounted and the system has been partitioned. Another way to avoid this problem is to enter a VARY device online command for the tape drive(s).

Reconfiguring a coupling facility

A coupling facility can be reconfigured to perform maintenance or to upgrade its level of control code. Before reconfiguring a coupling facility, you should have a plan in place for its orderly shutdown, during which time structures that are in the coupling facility can be either relocated to another coupling facility or deallocated (with a possible data loss). Applications using the coupling facility for its structure(s) should have documented procedures for how to relocate or deallocate them.

Refer to *Parallel Sysplex® Configuration Assistant* at <http://www.ibm.com/s390/psopso/psotool> for help with the configuration of a coupling facility.

Chapter 3. z/OS operator console operations

The tasks of starting, running, and stopping an MVS system involve:

1. Operating the system itself—that is, controlling the system software and most installation hardware (including processors, channel paths, and I/O devices)
2. Operating the MCS (multiple-console support), HMCS and SMCS (SNA multiple-console support) consoles.

“Console characteristics and operations” describes the physical characteristics and techniques for operating the various consoles that MVS supports as operators' consoles. It describes the characteristics and operations that you **cannot** control, including those operations that are common to all operator's consoles.

“Defining and changing console characteristics” on page 120 continues the console descriptions of “Console characteristics and operations” by describing the console characteristics that you **can** control. It describes the commands that operators and system programmers can use to tailor the consoles and console operations to the installation's requirements.

Console characteristics and operations

Before choosing consoles for your system environment, review the information on the supported consoles types.

General characteristics of display consoles

Many different input and output (I/O) devices can function as consoles in an MVS system. Logical conditions determine how or if the devices function:

1. Online: If allocated, the system assigns functions with these two limitations:
 - The device must be capable of performing the function.
 - The device cannot be assigned as a console because it is allocated to some other function.

If unallocated, the device can be assigned as a console.

2. Offline: The device is generally unavailable for the system to use.
3. Console: The system can use the device to send messages to you, and you can use the device to issue system commands (if the device has input capability), but you cannot use the device for other input/output purposes.
4. Standby:
 - Supported on the HMCS and MCS consoles only.
 - I/O to the HMCS console is disabled.
 - The VARY CN(name),ONLINE command is supported on the MCS, but not on the HMCS.
 - To enter Standby mode, deactivate the HMCS session or issue the VARY CN(name),STANDBY command.

You can use a device for multiple console support (MCS) if the device number for the console on a CONSOLE statement, in the CONSOLxx parmlib member, is the same as the device number specified in the IODF. SMCS consoles are also defined in CONSOLxx, but are not specified in HCD.

Subsystem use of consoles

Many different devices can function as consoles in an MVS system if they are specified as consoles in a CONSOLxx parmlib member. If the console is allocated to a subsystem — `CONSOLE DEVNUM(SUBSYSTEM)` — there is no corresponding device definition in the IODF. You should familiarize yourself with subsystem consoles if your configuration includes them; some of them can affect MVS operations in important ways. It is called a subsystem-allocatable console and is defined to the subsystem.

For a subsystem-allocatable console, the definition

```
CONSOLE DEVNUM(SUBSYSTEM)
```

must appear in the CONSOLxx parmlib member.

Multiple-console configuration

You can divide the functions and message traffic of the system among a number of consoles. These consoles make up a **multiple-console configuration** controlled and serviced by MCS.

In distributed mode, a multiple-console configuration for a system or sysplex consists of up to 99 active consoles per system; in shared mode the constraint is 99 consoles per sysplex. These consoles can have different levels of authority. For more information, see *z/OS MVS Planning: Operations*.

Any console with master console authority allows you to:

- Enter all operator commands
- Change the definition of the hardcopy message set or assign the hardcopy medium

Other MCS and SMCS consoles are used for specific types of operator-system communication when it is more convenient to have a console located away from the processor. An MCS or SMCS console might, for example, be located close to tape or remote teleprocessing devices to make it easier for the operator in that area to see the magnetic tapes. An MCS or SMCS console without master authority cannot enter all commands (see “System commands grouped according to system command authority” on page 124), and can receive only those messages that are specifically routed to that console.

Your installation might further limit how you can use a console by assigning an operating use that prevents the console from accepting commands.

A console you use both to issue commands and receive messages is in **full-capability** operating mode. A console that only receives status displays is in **status display** mode. A console that only monitors system activities and assists in system security is in **message stream** mode. Both message stream and status display consoles do not accept commands.

The different console modes help limit the number of consoles that operators can use to issue commands, and yet provide operators the information that they need to do their work.

At IPL, the system looks to the CONSOLxx member of parmlib to determine the operating modes of the consoles. It also looks for the following attributes:

- System command groups — the categories of commands that the system accepts from that console

- Message routing codes — the messages the console receives, determined by routing code
- Message levels — the messages the console receives, determined by message level
- Hardcopy medium — the system log (SYSLOG) or operations log (OPERLOG) that receives the hardcopy message set
- PFK definitions — the commands that console's PFKs issue

Features on display consoles

MCS display consoles can operate in full-capability, status display, or message stream mode. HMCS and SMCS consoles only operate in full-capability mode. Each one has a keyboard to enter commands and responses to messages and to signal the system that you are entering information. Each one also has a cursor, which appears on the screen as a movable point of light (either an underscore, a horizontal bar, or a vertical bar). The cursor points out the position on the screen that the system will examine for your next action. This action might be positioning a typed character, entering a command, requesting message deletion, or requesting a display. Special keys located on the console keyboard control cursor movement.

A display console can also have some or all of the following features:

Selector pen

The selector pen is a light-sensitive device that is available on some display consoles. When you put the pen over specific areas of the display console screen, it senses the light from the screen and signals the system. The system then determines the screen location over which you have put the pen and takes appropriate action. The action the system takes might involve entering operator commands, deleting messages from the screen, cancelling processes, or presenting displays.

Audible alarm

An audible alarm is available on display consoles. The system sounds this alarm when certain changes in conditions occur, such as when you enter an invalid CONTROL command. WTO macros with descriptor codes of 1, 2, or 11, and all WTOR macros will cause the audible alarm to sound on operator consoles so-equipped.

Program function keyboard

The program function keyboard is an input device that is available on some display consoles. You can define each key on the program function keyboard to enter one or more operator commands; you can enter a command or a group of commands by pressing one key.

Extended highlighting

Extended highlighting refers to blinking, reverse video, and underscored presentation of messages that require operator action.

Color Four or more colors are available on some devices, with certain colors identifying certain kinds of messages that require action.

Intensity

Some messages that require operator action appear brighter.

Display screen areas

The operating mode of the console controls the appearance of a display screen. Figure 17 on page 105 illustrates the differences among the different kinds of consoles. The display screens can have these functional areas:

Message area

This area contains system and problem program messages and copies of certain operator commands. The size of the message area depends on the console.

Display areas

These areas contain formatted, multiple-line displays of information about some part of the system. The displays are written to the console in response to certain commands, such as the DISPLAY command. The default on consoles in full-capability mode is one display area, the default on consoles in status display mode is two display areas. For consoles operating in full-capability mode, unless a status display is requested, the display area is used for general messages.

PFK display line

This line contains a display of program function key (PFK) numbers that you use when entering commands with the selector pen. This line is available on a 3277 model 2.

Instruction line

This line contains console control messages. For example, if you make an error entering a CONTROL command, an error message appears in the instruction line.

Entry area

This area contains one or two lines that you use to enter commands and reply to messages.

Warning line

This line warns you of conditions that could require action. For example, a warning message appears in this line when the message area is full and one or more messages are waiting to appear. The warning line is not available on output-only consoles in status display operating mode.

Operator information area

This line, the bottom-most line on the screen, is separated from the rest of the screen by a horizontal line. The operator information area, which is not controlled by z/OS, contains messages and symbols that keep you informed of the operational status of the terminal. It is not available on some terminals.

Figure 17 on page 105 shows the screens on consoles in the three different operating modes. You can change the display areas on the consoles in full-capability mode and status display mode. The screen on the console in message stream mode always appears as in the figure.

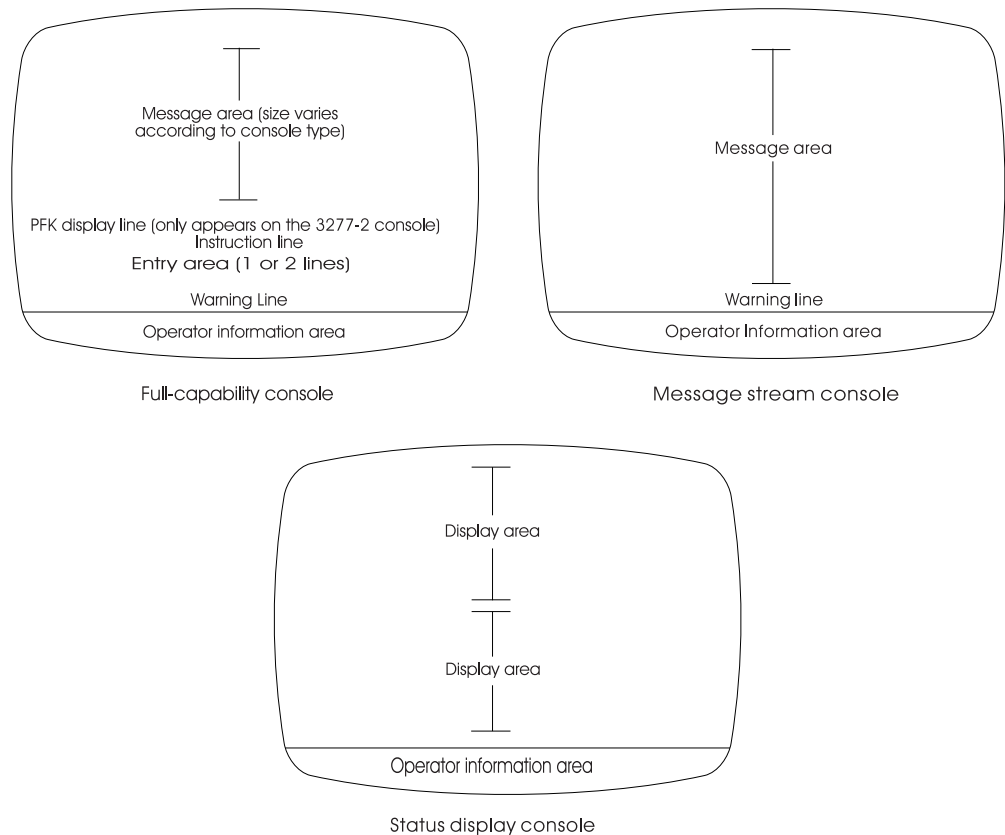

Figure 17. Comparison of the display screens of full-capability and output-only display consoles

L= Operand

Commands that manage consoles and console traffic use the L= operand to modify the screen area. For example, use the L= operand to delete messages or to delete lines from the screen area.

Commands that direct output use the L= operand to direct the output to an out-of-line area that is defined to the console. If there is no out-of-line area defined to the console, or if the area ID specified is **z**, the message is displayed inline.

For more information on the syntax and use of the L= operand for specific commands, see the description of the specific command in this book.

For a discussion of the L= operand in a sysplex, see *z/OS MVS Planning: Operations*.

Special screen characters

The system uses five special screen characters to indicate the status of certain screen messages. These special characters appear in position three, four, or five of the lines in the message area:

- A vertical line (|) in position three indicates that required action has been taken for the message and the system has deleted the message.
- A horizontal bar (-) in position three indicates that the message is for information only and requires no action from you.

- An asterisk (*) in position four indicates that the message is a system message that requires action from you.
- An at sign (@) in position four indicates that the message is a problem program message that requires action from you.
- A plus sign (+) in position five indicates that the message is a problem program message that requires no action from you.

Messages sent to display consoles

The MVS system and any program running under the MVS system can issue messages. A displayed message can appear by itself or with information about the message. Each message consists of:

- An identifier, which is a three-letter prefix to identify the system component that produced the message and a message serial number to identify the individual message. The identifier may contain other information.
- A message text to provide information, describe an error, or request an operator action.

Messages sent to your consoles can appear in one of the following formats:

```
f message
```

or

```
hh.mm.ss sysname jobident f message
```

Fields that are always present in a message are:

- f** A blank, which means that no action is required, or a special screen character. See “Special screen characters” on page 105.

message

Message identifier and text

Fields that you might chose to add to a message are:

jobident

Job name or job id for the task that issued the message.

sysname

Name of the system that issued the message

hh.mm.ss

Time stamp, given as the hour (00-23), minute (00-59), second (00-59)

To add any combination of job identification, system name, and time stamp to all console messages, see “Controlling the format of messages” on page 141. For more information about console messages, see *MVS System Messages*.

Operations on display consoles in full-capability mode

Although some of the procedures for operating and controlling display consoles involve special functions and conditions, most console procedures are quite general. These general procedures are described in this topic and include:

- How to perform basic keyboard actions
- How to enter commands with the keyboard

- How to enter commands with program function keyboard
- How to enter commands with the selector pen
- How to change information in the entry area

Performing basic keyboard actions

While the basic operating procedures are similar for all types of display consoles, the physical characteristics of each console require you to perform certain actions (such as, the ENTER, CANCEL, cursor detect, and selector pen detect actions) in different ways. The descriptions of operating procedures later in this section refer to these actions.

To perform the ENTER action, press the ENTER key.

To perform the CANCEL action, on a 3278 or 3279 display console, hold down the ALT key and press the PA2 key. On all other display consoles, press the CANCEL (PA2) key.

The cancel action:

- Erases the entry area
- Moves the cursor to the first position in the entry area
- Rewrites the message area and the instruction line
- Removes deletable-message indicators (if any are displayed)
- Removes message line numbers (if line numbers are displayed)

To perform a CURSOR DETECT action, position the cursor under the desired character and press the ENTER key.

To perform a SELECTOR PEN DETECT action, on 3277, 3278, or 3279 display consoles, any of which has a selector pen, place the selector pen over the desired indicator. Then, press the pen against the screen.

To retrieve the previous command, press the PA1 key.

How to enter commands

You can enter commands with the keyboard, the program function keys, or the selector pen (together with the PFK display line).

Entering commands with the keyboard

To enter commands with the keyboard through display consoles, use the following procedures. Use the same procedures to reply to WTOR messages:

1. Move the cursor to the first position in the entry area.
2. Type in the command.
3. Enter the command by performing the ENTER action.

Moving the cursor: Move the cursor to the first position in the entry area by one of the following methods:

- Press the cursor control keys.
- Press the tab key, the back-tab key, or the new line key.
- Press the ENTER key when the cursor is in the entry area or under the ENTER indicator in the instruction line. Pressing the ENTER key passes any data in the entry area to the system.
- Perform a cancel action. This action might also change the display.

Typing the command: Type in the command. As you type each character, the corresponding character appears in the entry area, and the cursor advances to the next character position. When you reach the end of the first line of a two-line entry area, the cursor advances automatically to the first character position of the next line, so that you can continue the command. The maximum number of characters that you can enter is 126.

You have the option of entering one command or several commands. To enter more than one command, use the MVS command delimiter. The MVS command delimiter is defined during system initialization in the CONSOLxx parmlib member. To set the command delimiter after system initialization, use the SET CON=xx command.

Most commands can be entered in either lowercase or uppercase. The system converts the commands to uppercase, if required. However, information within a command that is contained within single quotation marks (for example, a reply to a WTOR message) is not converted to uppercase by the system. If the system requires the information within the single quotation marks in uppercase, be sure to type it in uppercase when you enter the command. When an MVS command delimiter has been defined during system initialization, you cannot use the defined delimiter within single quotation marks.

Entering the command: When you enter the command, the cursor must be in the entry area or under the ENTER indicator in the instruction line, but it need not be at the end of the command. Pressing the ENTER key or selecting the ENTER indicator causes the command to be read and processed by the system. Commands other than the CONTROL command disappear from the entry area and reappear in the message area. If the message area is full, the command may not appear immediately; to have it displayed, you may have to delete some messages.

The PA1 Key: Each time you press the PA1 key, you see a command that you entered previously. The maximum number of times you can press the PA1 key to see previous commands is specified by your installation with the RBUF option on the CONSOLxx parmlib member. If you exceed this maximum, you see the same commands again.

Correcting command entry errors: If you make errors entering a CONTROL command, the audible alarm sounds, and the command appears in the entry area. The location of the cursor indicates the error:

- If the error is an invalid operand, the cursor appears under the invalid operand:
CONTROL X,N
- If the error is an invalid erase request, the cursor appears under the first invalid request.
CONTROL E,31,19
- If the CONTROL command exceeds 126 characters, the cursor appears at location 127 in the entry area.

To correct any of these errors, use the procedures described under “Changing information in the entry area” on page 113.

If the system detects an error in a command other than a CONTROL command, it writes the command in the message area with an error message. Follow the procedures indicated for the error message in the *MVS System Messages* books.

Entering commands with program function keys

The program function keyboard is a group of keys called PFKs. They are located on or near the operator console keyboard. PFKs are used as a shortcut for entering commands. Some PFKs have commands defined for them at IPL. The definitions might be those in a PFK table that your system programmer assigned to the console, or the PFKs might have the defaults assigned by IBM. You can redefine the PFK commands; see “Defining PFKs using PFK Tables” and “Defining PFKs using the CONTROL command” on page 146 in “Defining and changing console characteristics” on page 120.

Each PFK can be either **conversational** or **nonconversational**. The commands associated with a conversational PFK appear in the entry area one at a time when you press the key. You can change them before entering them. Commands associated with a nonconversational PFK are entered immediately when you press the key.

If your system programmer does not define and activate a PFK table for your PFKs, IBM supplies the following definitions (in nonconversational mode):

Table 5. IBM Defaults for PFKs

PFK	Command Comment	Definition
1	CONTROL E,1	Erase one line from screen
2	CONTROL E	Erase one segment from screen
3	CONTROL E,D	Erase status display from screen
4	CONTROL D,F	Frame display forward in area
5	CONTROL S,DEL=N	Hold in-line output
6	CONTROL S,DEL=RD	Resume in-line output
7	DISPLAY A,L	List active jobs and TSO users
8	DISPLAY R,L	List all outstanding operator action requests
9 and up		No definition provided

Note: The IBM-supplied sample IEESPFK illustrates the sequence and syntax of the statements that can be specified in a PFKTABxx member of SYS1.PARMLIB.

Identifying PFK definition errors: When the system tries to execute an invalid CONTROL N,PFK command, the audible alarm sounds, and the command appears in the entry area. The location of the cursor indicates the error:

- If the cursor is positioned under the first letter of a keyword (CMD, KEY, PFK, or CON), that keyword or its trailing equal sign is incorrect.
- If the cursor is positioned under the number of the PFK being defined, that number is either not a numeric character or not the number of a PFK that was designated for command entry in the PFK table, or it is the number of a PFK you are trying to associate with a list of key numbers when it is already part of a list of key numbers.
- If the cursor is positioned under a number following the KEY operand, the key number indicated is either a non-numeric character, the number of the PFK that is being defined, the number of a PFK that has already been defined as a list of key numbers, or the number of a PFK that has no command associated with it in a PFK table.

To correct these errors, follow the procedures described under “Changing information in the entry area” on page 113.

Checking the commands defined for each PFK: Use the DISPLAY PFK command to determine the commands defined for a console's PFKs, the PFK definitions in a specific PFK table, or the PFKs in effect for a specific console. The display can appear in the message area or can be routed to a display area or to another console. Unless you specify another console, the definitions always refer to the console on which you issue the command.

Table 6. Checking the Commands Defined for Each PFK

If you want to know	Use this command
The names of all available PFK tables	DISPLAY PFK,TABLE
The PFKs in effect at your console	DISPLAY PFK
The definitions in a specific PFK table	DISPLAY PFK,TABLE=nnnnnnnn, where nnnnnnnn is the name of the table
The PFK definitions in effect for a specific console	DISPLAY PFK,CN=name, where name is the console name

“Summary of the PFK Definitions for the Cluster” later in this chapter shows the complete output of the DISPLAY PFK,TABLE=nnnnnnnn command.

Example 1:

To display the commands associated with the PFKs on the console on which you issue the command, enter:

```
DISPLAY PFK
```

In response to this command, the following message usually appears in the message area:

```
IEE235I hh.mm.ss PFK DISPLAY
PFK DEFINITIONS FOR CONSOLE nnnnnnnn TABLE - MASTCMDS IN PFKTAB02
KEY# CON -----DEFINITION-----
```

The definitions for each key appear under the headings; *nnnnnnnn* identifies the console on which the command is issued.

If no PFKs are defined for the console named *CON04*, the following message appears in the message area instead:

```
IEE235I hh:mm:ss PFK DISPLAY
NO PFK DEFINITIONS FOR CON04
```

Example 2:

To determine the definitions in effect for the PFKs on *CON04*, enter:

```
DISPLAY PFK,CN=CON04
```

In response to this command, a message such as the following might appear in the message area:

```
IEE235I hh:mm:ss PFK DISPLAY
PFK DEFINITIONS FOR CON04 TABLE - MASTCMDS IN PFKTABJC
```

where the PFK table in effect for console *CON04* is *MASTCMDS* in the *PFKTABJC* parmlib member.

The definition for each key appears under the headings. If, however, no PFKs are defined for the console, the following message appears:

IEE235I hh:mm:ss PFK DISPLAY
NO PFK DEFINITIONS FOR CONSOLE CON04

Entering commands assigned to PFKs in conversational mode: In conversational mode, the system causes commands assigned to PFKs to appear in the entry area. You can change and then enter them, enter them unchanged, or cancel them. The cursor appears under the third character of the command or where designated with an underscore when the PFK was assigned a command. You can change or complete the command by positioning the cursor under the first character you want to change, typing in the change, and performing an ENTER action.

To enter commands in conversational mode,

1. Press the PFK associated with the command that you want to enter, causing the first command associated with the key to appear in the entry area.
2. According to your requirements:
 - Enter the command by performing an ENTER action. The next command associated with the PFK (if any) then appears in the entry area.
 - Change the command from the keyboard, then enter the command. (See “Changing information in the entry area” on page 113.)
 - Cancel the command that appears in the entry area by performing a CANCEL action. The next command associated with the PFK (if any) then appears in the entry area.
 - Cancel the request initiated by the first press of the PFK by pressing any PFK while the command is still in the entry area.

The result of cancelling a request in this way is shown in the following example. In the example, PFK 1 is assigned the commands START PGM1 and START PGM2.

PFK pressed	Result
PFK 1	START PGM1 command is displayed
Any PFK	START PGM1 command is canceled, and a blank line is displayed
PFK1	START PGM2 command is displayed

Altering a command in the entry area works only for the command entry in progress; the system retains the original definition for future use of the PFK. To redefine a PFK, use the procedures described in “Defining and changing console characteristics” on page 120 under “Defining Commands Using the CONTROL Command.”

Entering commands assigned to PFKs in nonconversational mode: Press the PFK associated with the commands that you want to enter. All of the commands are entered in the order in which they were associated with the key, just as if you had typed each command and performed the ENTER action.

Note:

1. PFKs that are defined as conversational function in the conversational mode even though the console is in nonconversational mode. Use these keys as if you were in conversational mode, as described earlier under “Entering commands assigned to PFKs in conversational mode.”
2. Although the commands are entered in order, their execution may overlap. Therefore, assign commands requiring sequential execution in conversational mode.

Responses to PFK errors: If you press a PFK that is not designated for command entry, the following message appears in the instruction line:

```
IEE721I PFK nn NOT SUPPORTED
```

If you press a PFK that has been designated for command entry but for which no command has been defined, the following message appears in the instruction line:

```
IEE722I PFK nn NOT DEFINED
```

Displaying the PFK numbers on 3277 model 2 consoles: You can display the PFK numbers on 3277-2 consoles and then point to them with the selector pen. Pointing to a number has the same effect as pressing that key. To display the PFK numbers, use the CONTROL D,PFK command. To erase the numbers in the PFK line, use the CONTROL E,PFK command.

Example:

To request a display in the PFK display line (this line is located immediately above the instruction line), enter:

```
CONTROL D,PFK
```

In response to this command, a display similar to the following appears in the PFK display line:

```
1 2 3 4 5 6 7 8 9 10 11 12
```

Only those numbers that have been designated for PFK command entry appear in the display. Once you have requested this display, you can leave it on the screen; the PFK display line is not used for any other purpose, even when the key numbers are not displayed. To erase the display, enter:

```
CONTROL E,PFK
```

Entering commands with the selector pen

Use the selector pen to enter commands that appear in the entry area. The commands can be in the entry area either because you typed them there or because you pressed a PFK that is in conversational mode. The PFK numbers available for selector pen command entry are defined in the active PFK table or are IBM defaults.

On a 3277 model 2, the selector pen can be used with the PFK display line to enter commands. The numbers appearing in the display line represent PFK numbers, and selecting a number with the selector pen has the same effect as pressing a PFK.

In **nonconversational mode**, all of the commands associated with a PFK are entered in the order in which they were associated with the key number. All commands (except CONTROL commands) appear in the message area when screen space is available. No commands appear in the entry area.

To enter commands on the 3277 model 2 in nonconversational mode:

1. Display the PFK numbers in the PFK display line by entering the CONTROL D,PFK command.
2. Select the PFK number associated with the command(s) you want to enter.
3. Press the selector pen against the screen over the selected number. The command is automatically entered.

To select commands on the 3277 model 2 in conversational mode, follow the same three steps. The system does not automatically enter the command; rather, the first command associated with the PFK number appears in the entry area. To enter the command, follow the steps described in the next section "Entering Commands with the selector Pen in Conversational mode".

Entering commands with the selector pen in conversational mode: In conversational mode, each command associated with a PFK number is presented in the entry area, one command at a time, where you can enter it as is, change it and enter it, or cancel it. Changing a command in the entry area works only for the command entry in progress; the system retains the original definition for that PFK.

To enter commands with the selector pen in conversational mode:

1. Enter the command by performing the ENTER action or by selecting ENTER. The next command associated with the PFK (if any) then appears in the entry area.
2. Change the command from the keyboard before entering it as described later in this chapter under "Changing information in the entry area."
3. Cancel the command in the entry area by performing a CANCEL action. The next command (if any) then appears in the entry area.
4. Cancel the request initiated by the first selection of the PFK number by pressing the selector pen against the screen over any other PFK number while a command associated with the first key number is still in the entry area.

Changing information in the entry area

You can change information in the entry area to correct a typing error or to change a command during conversational command entry or message deletion. You might not need to completely retype a command to correct or change it. (Both conversational command entry and message deletion are described in this section.) You can blank out the entry area without entering a command to the system.

Pressing the PA1 key displays a command that you entered previously. When you see that command, you can make corrections or changes (as described in this section) and press the Enter key to issue the command.

Substituting characters: If you make a mistake when typing in the entry area move the cursor to the first character you want to change and type the correct characters.

Example:

If you type in the following reply to a WTOR message:

```
R 22, 'DISLAY REQUESTED' _
```

and then note (before performing the enter action) that you have typed the word DISPLAY incorrectly, you can move the cursor under the L, and type PL. The reply then reads:

```
R 22, 'DISPLAY REQUESTED'
```

In the same example, if you decide that the correct response is NO, moving the cursor under the D in DISPLAY and typing NO leaves the following in the entry area:

```
R 22, 'NO'PLAY REQUESTED'
```

To correct this situation, move the cursor under the P and press the ERASE EOF key. This key erases the remainder of the entry area (from the cursor to the last character position), leaving the following in the entry area:

```
R 22, 'NO' _
```

Inserting characters: To insert one or more characters within data in the entry area:

1. Position the cursor at the character position following the point where the missing data should appear.
2. Press the INS MODE key (the insert mode marker appears on the console).
3. Type in the missing data.
4. On some consoles, you must press the RESET key to return the keyboard to its normal input mode.

Example:

To insert the console identifier 10 in the following command:

```
DISPLAY JOBS, L=CONSC
```

Move the cursor back to the C, press the INS MODE key, type in 10, and press the RESET key. The command then reads:

```
DISPLAY JOBS, L=CONS10C
```

Note that the characters to the right of the inserted characters shift to make room for the inserted characters. If required, characters shift to the second line of the entry area.

Deleting characters: To delete a character, position the cursor at the character to be deleted and press the DEL key.

All characters that follow the deleted one shift to the left to fill the space formerly occupied by the deleted character. Delete one character at a time.

Example:

To delete the extra S from the following command:

```
DISPLAY JOBS, L=CONSSOLEC
```

Position the cursor at either S and press the DEL key. The command then reads:

```
DISPLAY JOBS, L=CONSOLEC
```

Blanking the entry area

The ERASE INPUT key:

To remove all of the data that you have typed in the entry area without causing it to be passed to the system, press the ERASE INPUT key. This key erases the entry area and moves the cursor to the first position in the entry area.

Note: Do not use the ERASE INPUT key on the 3279 models 2A, 2C, and 3A. On these devices, the ERASE INPUT key blanks out the entry areas and all fields with data displayed in red.

The PA2(CANCEL) key:

To clear the entry area and restore the screen, press the PA2 key.

Handling consoles in error conditions

Several types of errors can occur that directly affect the operation of display consoles. In some cases, the error becomes apparent by a sudden screen failure, the appearance of error messages, or the locking of the keyboard. In other cases, the error might not be immediately apparent. Errors can be caused by a programming problem (system error), a console malfunction (hardware error), or a hardware error not related to the console.

System errors

When a system error occurs, one or more of the following can happen:

- The screen is blanked out, and then an error message appears in the message area
- An error message appears in the WARNING line.
- There is an abnormal lack of console activity.

Responding to an error message in the message area: An error message at the bottom of the message area indicates that a recoverable system error has occurred. Perform the action specified by the error message, and then perform a CANCEL action. This should restore the screen. It is good practice to review the messages at this time to make sure that no messages were lost during error recovery.

Responding to an error message in the WARNING line: An error message in the WARNING line might indicate that an unrecoverable system error has occurred and that the system needs to be loaded again. If so, follow normal procedures for IPL, and notify your system programmer.

Responding to an inactive console: An inactive console condition is characterized by a lack of message traffic or a lack of system response to commands. The inactivity could be caused simply by a low level of system activity, or it could be the result of a problem in the message handling portion of the control program.

If an MCS, HMCS or SMCS console appears inactive, check the system response by requesting a display of the time:

```
DISPLAY T
```

The system should respond within a few seconds with the time and date. If it does not, perform one of the following actions:

- Issue the CONTROL C,D command to cancel any status displays being presented on the inactive console.

If neither of these procedures returns the console to normal activity, assume that there is some other problem related to the console. Check for a console hardware error. If the system must be loaded again, follow normal procedures for IPL. Report the occurrence of this problem to your system programmer.

Console hardware errors

When a console hardware error occurs, one or more of the following can happen:

- Error messages are centered on the screen (the remainder of the screen is blank).
- The screen is blank (and no error message appears).
- The screen appears normal, but the keyboard is locked and you cannot enter commands.

Responding to error messages centered on the screen: If a console hardware error occurs, one of the following sets of messages can appear centered on the screen:

```
IEE170E RETRYABLE ERROR. RECENT ACTION MAY NEED TO BE REPEATED
IEE170E PRESS THE CANCEL KEY TO RESTORE THE SCREEN
-- or --
IEE171E CONDITIONAL ERROR. RECENT ACTION MAY NEED TO BE REPEATED
IEE171E PRESS CANCEL TO CONTINUE
```

Perform a CANCEL action. The CANCEL action should restore most of the screen, including messages displayed inline in the message area, the instruction line, and the warning line. The entry area and the PFK line, however, are blanked out, any out-of-line displays are erased, and the cursor is positioned to the first data entry position. Also, message numbering (if active) is terminated.

Note: If you do not perform a CANCEL action, the system rewrites the screen (same effect as CANCEL) after about 30 seconds. If a console hardware error results from keyboard input when you perform the CANCEL action, the system sees the error as a permanent I/O error.

Responding to a blank screen: If the console screen goes blank, the console has failed.

Note: It is normal for the screen of a 3277 to go blank for a few seconds if the back-tab key is pressed when the cursor is not in the entry area.

Responding to a locked keyboard: Sometimes the system is unable to blank out the screen. If you find that you cannot enter commands through a console that otherwise appears normal, try to restore the screen by performing a CANCEL action.

Note: Inhibited input, with or without keyboard locking, can also occur when the system abends or goes into a wait state, or when a problem occurs in the message handling portion of the control program. See the procedures described for an inactive console under "System errors" on page 115.

Responding to Console Message Backups

The MVS system keeps some WTO and WTOR messages in buffers in virtual storage. The WTO buffers hold the messages that the system has not yet displayed at the eligible consoles; the WTOR buffers each hold one WTOR message that the system has already displayed but that an operator has not responded to. The maximum number of WTO and WTOR buffers are determined by the MLIM and RLIM parameters on the INIT statement in the CONSOLxx parmlib member. If these parameters are not coded, the system defaults (as described in *z/OS MVS Initialization and Tuning Reference*) are in effect.

To avoid WTO message buffer shortages, you can raise your WTO buffer limit (MLIM) and adjust message deletion specifications on your consoles. To avoid WTOR message buffer shortage, raise your WTOR buffer limit (RLIM) and reply to WTORs more frequently. Procedures for responding to WTO and WTOR buffers shortages follow in this section.

Responding to WTO buffer shortages: When WTO message buffer use reaches 80 percent of the limit specified at IPL, the system issues the following message:

```
IEA405E WTO BUFFER SHORTAGE - 80% FULL
```

The system also issues a DISPLAY CONSOLES,BACKLOG (D C,B) command to provide information helpful in determining the cause of the buffer shortage.

If the problem continues and WTO buffer use reaches its limit, the system issues the following action message:

```
IEA404A SEVERE WTO BUFFER SHORTAGE - 100% FULL
```

When storage for the WTO buffers is exhausted, the system issues the following message:

```
IEA652A WTO STORAGE EXHAUSTED - WTOS WILL BE DISCARDED
```

At this point, any new WTOs will be thrown away.

When the system notifies you that the WTO buffers are 80% full, determine the reason for the buffer shortage and correct the problem. Possible reasons are:

- A console is not ready and WTO messages are filling the console message buffers because:
 - An intervention required condition exists.
 - The console has been powered off.
 - Some part of the path to the device is not working; for example, an I/O interface is disabled.
 - One or more consoles may have their displays held.
- A console is not in roll mode, and messages are filling the console message buffers.
- A console is in roll or wrap mode but the update time is too long, and messages are filling the console message buffers.
- A buffer limit specified at IPL is too low to handle the message traffic in the system. (Either the value on the MLIM parameter in the CONSOLxx member is too low, or the system default for RLIM is too low.)
- A program is issuing messages at too rapid a rate and might be in a loop. When a job uses a high percentage of the WTO buffers, the system issues message CNZ3011I which identifies the jobname and the address space.

To determine the extent of the problem and the responsible console or consoles, examine the output from the DISPLAY CONSOLES,BACKLOG (D C,B) command. When messages are backed up for a console, it might be necessary to delete the queue of messages for the console using a CONTROL Q command. You might need to issue CONTROL Q several times to clear the console completely.

When there are too many messages from one job/address space, consider cancelling the job or jobs specified in message CNZ3011I. If cancelling a job would cause a serious impact, look at the messages the job is issuing. If the job seems to be in a loop, then activate an MPF member to suppress or delete the repeating message. Another option is to temporarily remove the message's routing code from all the consoles.

When a high number of buffers is in use for messages from another system in the sysplex, you can route a D C,B command to the other system to determine if a job on the other system is generating too many messages. You can protect your system from a runaway job on another system in the sysplex by using the V CN,DMSCOPE= command.

Figure 18 shows an example of the DISPLAY CONSOLES,BACKLOG output. The system displays information about all consoles, on this system only, that have any outstanding WTO messages. The output in the figure includes the following line:

```
MSG: CURR=1356 LIM=1500 RPLY:CURR=1 LIM=10 SYS=1 PFK=NONE
```

In this line, MSG: CURR=1356 LIM=1500 tells you the current use of WTO buffers and the specified limit. RPLY: CURR=1 LIM=1500 tells you the number of WTO messages that have been displayed and are awaiting operator reply, and the specified limit. The line confirms that more than 80% of the specified WTO buffer limit is reached; 1356 WTO buffers are full and the specified limit is 1500. The display in Figure 18 indicates, through NBUF, the number of buffers queued to each console. In this example, DAVE, with 1217 message buffers filled, is the source of the problem. The buffer limit of 1500 seems adequate, so DAVE is probably failing and causing undisplayed messages to fill the message buffers.

```

CNZ4100I 17.08.05 CONSOLE DISPLAY FRAME 1 F E SYS=SY1
CONSOLES MATCHING COMMAND: D C,BACKLOG
MSG:CURR=1356 LIM=1500 RPLY:CURR=1 LIM=10 SYS=SY1 PFK=NONE
DAVE TYPE=MCS STATUS=ACT-SY1
      DEFINED=(SY1)
      MATCHED=(N/A)
ATTRIBUTES ON SY1
  AUTH=(MASTER) CMDSYS=* NBUF=1217 SUPSBY=Y
  DEV=03E0 LOGON=OPTIONAL USERID=N/A TIMEOUT=10
  MFORM=(S) AREA=(Z,A) PFKTAB=01
  USE=FC DEL=RD RTME=1/4 RNUM=25 SEG=19 CON=N
  LEVEL=(ALL)
  MONITOR=(NONE) INTIDS=N UNKNIDS=N
  ROUT=(ALL)
  MSCOPE=(*ALL)
ADDRESS SPACE WTO BUFFER USAGE
ASID - 0019 JOBNAME = FLOODNUM NBUF = 520
MESSAGES COMING FROM OTHER SYSTEMS - WTO BUFFER USAGE
SYSTEM = 2 NBUF= 4

```

Figure 18. Example of DISPLAY CONSOLES,BACKLOG command output

If the buffer limit is not adequate, issue the CONTROL M,MLIM= command to increase the WTO buffer limit for the duration of the IPL. Your system programmer might code the MLIM parameter on the INIT statement in the CONSOLxx member to raise the WTO buffer limit for the next IPL.

When the number of buffers in use drops below 60% of the limit specified at IPL time, the system issues the following message:

```
IEA406I WTO BUFFER SHORTAGE RELIEVED
```

Note:

1. All lines of an out-of-line multi-line status display that have not been presented occupy message buffers. Therefore, you should erase these displays when they are no longer needed.
2. The current buffer count can be larger than the specified limit. Even though the buffer count is greater than or equal to the limit, the system always gives a privileged task a buffer unless the storage available for buffers is exhausted.
3. The system does not use the MLIM and RLIM parameter values specified in the CONSOLxx parmlib member until either the hardcopy medium (SYSLOG or OPERLOG) becomes active or NIP processing is complete. After NIP processing, multiple consoles become active and buffer space becomes important.

Responding to WTOR buffer shortages: When WTOR message buffer use reaches 80 percent of the limit specified at IPL, the system issues the following message:

```
IEA230E WTOR BUFFER SHORTAGE - 80% FULL
```

If the problem continues and WTO buffer use reaches its limit, the system issues the following action message:

```
IEA231A WTOR BUFFER SHORTAGE CRITICAL - 100% FULL
```

When the system notifies you that the WTOR buffers are 80% full, you should reply to the WTOR messages that are outstanding. If any of the WTORs have rolled off the screen (console roll mode is DEL=R), use the DISPLAY R,R command to retrieve the text of the outstanding requests.

To raise the limit of WTOR buffers for the duration of the IPL, issue the CONTROL M,RLIM command. If WTOR buffer use often reaches 80 percent of the limit, the limit for WTOR messages specified at IPL might be too low to handle the WTOR message traffic in the system. Your system programmer should code the RLIM parameter on the INIT statement in the CONSOLxx member to raise the WTOR buffer limit for the next IPL.

Processing MVS messages at the system console during system recovery

During system recovery, MVS might try to communicate with you. Your installation might have defined the system console, or any other MCS or HMCS console as members of a console group in CNGRPxx to receive synchronous messages. Synchronous messages are WTO or WTOR messages that can be issued during initialization or recovery situations. The operator must respond to the WTOR messages before the system will continue. In a sysplex, a console can display synchronous messages only if it is attached to the system that issues the message. If your installation has not specified a console group or a console is not active, the system issues the message to the system console.

The MVS message on the system console does not time out; the message remains on the screen until you enter a reply. See *z/OS MVS Planning: Operations* for more information about consoles and console recovery.

Placing a console in offline status

When an MCS, HMCS or SMCS console or the system log must be bypassed for any reason, you must enter a VARY command to place the console offline. Command activity from the console is immediately suspended. If the console is a printer, messages continue to be displayed until all waiting messages have been issued.

The VARY command does not cause the functions of the bypassed console to be assigned to another console.

Interchanging your consoles on a control unit

If a device has been specified as a 3270 model X to hardware configuration definition (HCD), you can replace it with another device and redefine it through the HCD panels. For information about using HCD, see *z/OS HCD User's Guide*.

Defining and changing console characteristics

When your system comes up, the definitions in certain members of SYS1.PARMLIB are in effect. After IPL, you can use CONTROL, MONITOR, SET, and VARY commands to change the definitions; however, the effect of the command lasts only for the duration of the IPL. To have an effect during the next IPL, the appropriate Parmlib member used for initialization has to be updated.

This topic describes:

- “Using operator commands to change CONSOLxx statements”
- “Changing console characteristics” on page 124
- “Controlling system messages and commands” on page 139
- “Defining program function keys (PFKs)” on page 145
- “Processing hardcopy” on page 148

Using operator commands to change CONSOLxx statements

Several operator commands are available to modify the statements in the CONSOLxx parmlib member.

The CONSOLE statement of CONSOLxx

A CONSOLE statement in the CONSOLxx parmlib member establishes the device as an MCS, HMCS or SMCS console and defines certain console values or attributes. These values are specified by system programmers or are IBM defaults. After IPL, operators can use certain commands to change these attributes. *z/OS MVS Planning: Operations* lists the values that can be changed by operator command, the sysplex or system scope of the values, and if these values will or will not be restored to CONSOLxx parmlib member settings or IBM defaults, by a single system IPL or by a sysplex reinitialization.

CONSOLxx contains console definitions for the system or sysplex.

Table 7. Comparison of system commands and CONSOLE parameters in CONSOLxx

System commands	CONSOLE parameters with default value	Characteristic that the parameter affects
CONTROL A	AREA	Size of the out-of-line display areas
CONTROL N,PFK	PFKTAB	PFK table
CONTROL S,CON	CON(N)	Conversational or nonconversational mode
CONTROL S,DEL	DEL(RD)	Message deletion mode
CONTROL S,MFORM	MFORM(M)	Format in which the messages appear
CONTROL S,RNUM	RNUM(5)	Number of message lines included in one message roll
CONTROL S,RTME	RTME(2)	Number of seconds between message roll/wrap
CONTROL S,SEG	SEG	Number of lines in the message area that can be deleted by a CONTROL E,SEG command
CONTROL V,CMDSYS	CMDSYS	Systems where commands on a console can be directed for processing
CONTROL V,LEVEL	LEVEL	Message levels for the console

Table 7. Comparison of system commands and CONSOLE parameters in CONSOLxx (continued)

System commands	CONSOLE parameters with default value	Characteristic that the parameter affects
CONTROL V,USE	USE(FC)	Console operating mode
MONITOR	MONITOR	Monitoring of certain events
VARY CN,AMSCOPE VARY CN,DMSCOPE VARY CN,MSCOPE	MSCOPE	Systems that direct messages to a console
VARY CN,AUTOACT	AUTOACT	Automatic Activate group for the system console
VARY CN,AUTH	AUTH(INFO)	Command groups
VARY CN,LOGON	LOGON	Defines the LOGON attribute
VARY CN,LU	LU	Defines the predefined LU for an SMCS console only
VARY CN,ROUT VARY CN,AROUT VARY CN,DROUT	ROUTCODE	Routing codes for the console
VARY CN,INTIDS	INTIDS	Whether to receive messages directed to console ID zero
VARY CN,SUPSBY	SUPSBY	Supports standby mode
VARY CN,TIMEOUT	TIMEOUT	The system will automatically issue a LOGOFF command for this console after the number of minutes specified by TIMEOUT has elapsed without any console input activity (pressing an attention-generating key, such as Enter, PA1, PA2, or a PFK).
VARY CN,UNKNIDS	UNKNIDS	Whether to receive messages directed to unknown console IDs (such as 1-byte console IDs)

The INIT statement in the CONSOLxx member

The INIT statement contains initialization values for the system. You code only one INIT statement in the CONSOLxx member.

Table 8 describes each MVS command that has a corresponding parameter on the INIT statement in CONSOLxx, the parameter, and the characteristic that the command and parameter affect. The value in parentheses indicates the default. All values can be changed using the SET CON= command.

Table 8. Comparison of system commands and INIT statements in CONSOLxx

System command	Parameter on INIT statement with default value	Characteristic that the parameter affects
CONTROL M,AMRF	AMRF(Y)	Establishes whether the action message retention facility is to be active
CONTROL M,APPLID	APPLID	Sets the APPLID used by SMCS on this system

Table 8. Comparison of system commands and INIT statements in CONSOLxx (continued)

System command	Parameter on INIT statement with default value	Characteristic that the parameter affects
CONTROL M,GENERIC	GENERIC	Sets the GENERIC used by SMCS for the entire sysplex
CONTROL M,MLIM	MLIM(1500)	Limits the number of buffers for WTO messages that the system has not yet displayed
CONTROL M,LOGLIM	LOGLIM(1000)	Limits the number of buffers for messages that the system sends to the system log
CONTROL M,RLIM	RLIM(10)	Limits the number of WTOR messages that the system has displayed but that the operator has not replied to
CONTROL M,UEXIT	UEXIT(Y)	Establishes whether the installation exit IEAVMXIT is to be active
K M,ROUETIME	ROUETIME(30)	Specifies the maximum number of seconds that a multisystem ROUTE command waits for a response
MONITOR	MONITOR	Establishes how the system displays mount and demount messages in response to the MONITOR command
SET CNGRP	CNGRP(NO)	Specifies the CNGRPxx parmlib members that the system is to use
SET MMS	MMS(NO)	Specifies the MMSLSTxx parmlib member that holds the translation tables that are available for your system
SET MPF	MPF(NO)	Specifies the MPFLSTxx parmlib members that the system is to use
SET MSGFLD=xx	MSGFLD	Specifies the MSGFLDxx parmlib member that the system is to use
SET PFK	PFK(NONE)	Specifies the PFKTABxx parmlib member that holds the PFK tables that are available for your consoles
TRACE CT,PARM=	CTRACE(CTIOPS00)	Specifies the CTnOPSxx parmlib member that contains tracing options for the operations services (OPS) component

The HARDCOPY statement in the CONSOLxx member

Table 9 on page 123 describes each VARY HARDCPY command operand, the corresponding parameter in CONSOLxx parmlib member, and the task the command and parameter performs. The value in parentheses indicates the default. All HARDCOPY parameters can be changed using the SET CON= command.

Table 9. Comparison of VARY HARDCPY commands and HARDCOPY statements in CONSOLxx

VARY HARDCPY command parameters	Parameters on HARDCOPY statement	Description
SYSLOG or OPERLOG	DEVNUM	Establishes whether the hardcopy medium is SYSLOG or OPERLOG
ROUT	ROUTCODE	Establishes the routing codes for messages included in the hardcopy message set
NOCMDS, INCMDS, STCMDS, or CMDS	CMDLEVEL	Establishes whether the hardcopy message set includes operator commands, responses, or status displays

The HARDCOPY statement is optional; CONSOLxx contains only one statement for each system. If the HARDCOPY default is used, the system uses the following defaults:

- The hardcopy medium is SYSLOG.
- The system uses a minimum set of routing codes (1, 2, 3, 4, 7, 8, 10, and 42) to select messages for the hardcopy message set.
- CMDLEVEL(CMDS) is used to select the level of commands included in the hardcopy message set.

The DEFAULT statement in CONSOLxx: The system programmer uses the DEFAULT statement to control certain default values for MCS, HMCS and SMCS consoles in the configuration. DEFAULT lets the system programmer specify console attributes that control the following for console configuration:

- Console security by specifying operator logon options
- Certain console screen functions for all consoles (ability for operators to hold moving or wrapping messages on the screen)
- Routing for messages without routing codes or other message queuing information, and routing for synchronous messages that bypass normal message queuing
- Determining the maximum value for operator REPLY IDs.
- Specify a group of consoles that are eligible to receive synchronous messages.

Parameters can be changed using the SET CON= command.

Displaying information about console characteristics

To learn the current characteristics of the console, use the DISPLAY CONSOLES command. The output is message CNZ4100I, which contains information about the system's use of consoles as well as information about each console's characteristics. Figure 19 on page 124 shows the output of the command.

```

CNZ4100I 15.03.36 CONSOLE DISPLAY FRAME 1 F E SYS=SY1
CONSOLES MATCHING COMMAND: D C,ROUT=5
MSG:CURR=1356 LIM=1500 RPLY:CURR=1 LIM=10 SYS=1 PFK=NONE
FRED TYPE=MCS STATUS=ACT-SY2
      DEFINED=(*ALL)
      MATCHED=(*ALL)
ATTRIBUTES ON SY2
  AUTH=(MASTER) CMDSYS=* NBUF=0 SUPSBY=N
  DEV=03E0 LOGON=OPTIONAL USERID=N/A TIMEOUT=N/A
  MFORM=(S) AREA=(Z,A) PFKTAB=*DEFAULT
  USE=FC DEL=RD RTME=2 RNUM=05 SEG=10 CON=N
  LEVEL=(ALL)
  MONITOR=(JOBNAMES) INTIDS=Y UNKNIDS=Y
  ROUT=(ALL)
  MSCOPE=(*ALL)
WILMA TYPE=MCS STATUS=ACT-SY2
      DEFINED=(*ALL)
      MATCHED=(*ALL)
ATTRIBUTES ON SY2
  AUTH=(MASTER) CMDSYS=* NBUF=0 SUPSBY=Y
  DEV=03E1 LOGON=OPTIONAL USERID=N/A TIMEOUT=30
  MFORM=(S) AREA=(Z,A) PFKTAB=*DEFAULT
  USE=FC DEL=RD RTME=2 RNUM=05 SEG=10 CON=N
  LEVEL=(ALL)
  MONITOR=(JOBNAMES) INTIDS=Y UNKNIDS=Y
  ROUT=(ALL)
  MSCOPE=(*ALL)
NAME TYPE STATUS DEFINED MATCHED
BARNEY MCS INACT *ALL *ALL
BETTY MCS ACT-SY1 *ALL SY2,SY3

```

Figure 19. Example of DISPLAY CONSOLES,ROUT=5 command output

In the example, the command is to display all consoles that accept messages with a routing code of 5. FRED and WILMA are active consoles on SY2 that match the specified criteria. Their console information is displayed in the command output. BARNEY is a console that is not active, but it does accept messages with a routing code of 5 on all systems. Therefore, the command output only displays BARNEY's type, status, all systems on which it is defined, and all systems where it matched the specified criteria. BETTY is active on SY1 and does not accept messages with a routing code of 5 on SY1, but it does accept them on other systems where it is not active. Therefore, the command output only displays the same summarized information as BARNEY.

Note: To display the console information associated with BARNEY for each system where he accepts messages with a routing code of 5, include the FULL keyword.

Changing console characteristics

You can change the characteristics of MCS, HMCS and SMCS consoles dynamically through MVS commands.

Note that using VARY command can only change the console characteristics when the console is active. The exceptions to this are LU and LOGON characteristics, which can be changed for inactive SMCS consoles. See "VARY command" on page 921 for more information.

System commands grouped according to system command authority

If an MVS operator command is not RACF-protected (for example, if the RACF OPERCMDS class is not active, or if no OPERCMDS profile covers the command), the authority to issue the MVS command is granted based on the command group. There are five command groups:

- Informational commands (INFO)
- System control commands (SYS)
- I/O control commands (IO)
- Console control commands (CONS)
- Master level authority commands (MASTER)

If RACF is used to control who can issue commands, the RACF OPERCMDS settings override the command group (AUTH) settings. For example, if the user has access to the correct OPERCMDS profile, a job submitted in a class with AUTH(INFO) will issue a MODIFY command. Similarly, if the user does not have access to the proper OPERCMDS profile, a job submitted in an AUTH(ALL) jobclass will be unable to issue a MODIFY command.

The commands in each group are shown in Table 10. The command groups are ordered from the lowest to the highest JES authority level, as described in *z/OS JES2 Commands* or *z/OS JES3 Commands*.

You can enter informational commands from any full-capability console. However, to enter system control, I/O control, or console control commands from a secondary console, that particular command group must be assigned to that console. If you enter a command at a console where it is not authorized, MVS rejects the command and sends an error message to the issuing console.

At a master authority console, you can enter all operator commands. Any console with AUTH(MASTER) in the CONSOLxx parmlib member has master authority.

Using RACF, the installation can allow the operators to log on to any MCS, HMCS or SMCS console. IBM recommends logon for SMCS. The operator's RACF profile and group authority determines what commands can be issued from the console. For a list of MVS commands and their profile names, see "MVS commands, RACF access authorities, and resource names" on page 127.

Table 10. Command groups used to determine command authority

Command group	Command	Command
INFO	CMDS DISPLAY CMDS SHOW CONTROL (See Notes) DEVSERV DISPLAY (See Notes) LOG LOGOFF LOGON MONITOR	REPLY (See Notes) ROUTE SEND STOPMN

Table 10. Command groups used to determine command authority (continued)

Command group	Command	Command
SYS (system control)	ACTIVATE CANCEL CHNGDUMP DUMPDS HALT (See Note 2 on page 127) HOLD LIBRARY MODE MODIFY PAGEADD PAGEDEL RELEASE RESET SET	SETAPPC SETAUTOR SETCEE SETETR SETGTZ SETIOS SETLOAD SETMF SETOMVS SETPROG SETRRS ARCHIVELOGGING SETRRS CANCEL SETRRS SHUTDOWN SETSMF SETSMS SETUNI SLIP START STOP SWITCH SMF TRACE (with CT, ST, or STATUS) WRITELOG
IO (I/O control)	ASSIGN MOUNT SETHS SWAP UNLOAD	VARY {NET } (See Note 2 on page 127) {OFFLINE} (See Note 5 on page 127) {ONLINE} (See Note 5 on page 127) {PATH } {SMS } {name or [/]devnum}
CONS (console control)	CONTROL (See Note 3 on page 127)	VARY CN(...)[OFFLINE ONLINE] (See Note 5 on page 127) VARY {TCPIP} VARY {WLM} VARY CN(...),STANDBY
MASTER (master control)	CMDS ABEND CMDS DUMP CMDS FORCE CMDS REMOVE CONFIG CONTROL (See Note 3 on page 127) DUMP FORCE IOACTION QUIESCE RESET CN SETCON SETGRS SETLOGR SETLOGRC SETSSI SETXCF	TRACE (with MT) VARY {CN(...)[,AUTH=...]} {CN(...)[,LOGON=...]} {CN(...)[,LU=...]} {CONSOLE[,AUTH=...]} {CU } {GRS } {HARDCPY } {OFFLINE,FORCE } {XCF }

Table 10. Command groups used to determine command authority (continued)

Command group	Command	Command
Note:		
1. CONS command group when message routing is specified.		
2. HALT NET and VARY NET are related to the Virtual Telecommunications Access Method (VTAM®)		
3. CONTROL is in the INFO command group except when		
<ul style="list-style-type: none"> • Purging the message queues of any other full-capability MCS, HMCS or SMCS console — MASTER. • Message routing is specified — CONS. • Changing or displaying the status of the action message retention facility — MASTER. • Changing or displaying the number of allowed message buffers — MASTER. • Changing or displaying the status of WTO user exit IEAVMXIT — MASTER. • In a sysplex, changing the maximum time to wait for aggregated command responses — MASTER. • Increasing the number of reply IDs — MASTER. 		
4. An operator can reply to any message that the console is eligible to receive. Any console with master authority can reply to any message.		
5. VARY CN,OFFLINE and VARY CN,ONLINE require CONS. Without the CN keyword, VARY OFFLINE and VARY ONLINE require IO authority.		

MVS commands, RACF access authorities, and resource names

This section lists all MVS commands, the RACF access authority associated with them, the RACF resource name for the profile and any explanatory notes:

Table 11. MVS Commands, RACF Access Authorities, and Resource Names

Command/Keyword	Authority	Resource-Name
ACTIVATE	UPDATE	MVS.ACTIVATE
CANCEL device	UPDATE	MVS.CANCEL.DEV.device
CANCEL jobname	UPDATE	MVS.CANCEL.JOB.jobname
The previous command is for a job that is not a started task.		
CANCEL jobname.id CANCEL id	UPDATE	MVS.CANCEL.STC.mbrname.id
The previous command is for a started task for which an identifier is provided.		
CANCEL jobname	UPDATE	MVS.CANCEL.STC.mbrname.jobname
The previous command is for a started task for which an identifier was not provided. <i>mbrname</i> is the name of the member containing the JCL source.		
CANCEL jobname	UPDATE	MVS.CANCEL.ATX.jobname
The previous command is for APPC transaction programs.		
CANCEL U=userid	UPDATE	MVS.CANCEL.TSU.userid
CHNGDUMP	UPDATE	MVS.CHNGDUMP
CMDS DISPLAY	READ	MVS.CMDS.DISPLAY
CMDS DUMP	CONTROL	MVS.CMDS.DUMP
CMDS FORCE	CONTROL	MVS.CMDS.FORCE
CMDS SHOW	READ	MVS.CMDS.SHOW
CMDS REMOVE	CONTROL	MVS.CMDS.REMOVE
CMDS ABEND	CONTROL	MVS.CMDS.ABEND
CONFIG	CONTROL	MVS.CONFIG
CONTROL A	READ	MVS.CONTROL.A

Table 11. MVS Commands, RACF Access Authorities, and Resource Names (continued)

Command/Keyword	Authority	Resource-Name
<p>Note: The access authority for all CONTROL commands except CONTROL M is normally READ, but the <i>L=name</i> (console name) operand can change the access level. When <i>L=name</i> specifies a console that is not full-capability and is not the issuing console, the access authority is UPDATE. When <i>L=name</i> specifies a console that is full-capability and is not the issuing console, the access authority is CONTROL.</p>		
CONTROL C Note: See the note for the CONTROL A command for exceptions.	READ	MVS.CONTROL.C
CONTROL D Note: See the note for the CONTROL A command for exceptions.	READ	MVS.CONTROL.D
CONTROL E Note: See the note for the CONTROL A command for exceptions.	READ	MVS.CONTROL.E
CONTROL M	CONTROL	MVS.CONTROL.M
CONTROL N Note: See the note for the CONTROL A command for exceptions.	READ	MVS.CONTROL.N
CONTROL Q Note: See the note for the CONTROL A command for exceptions.	READ	MVS.CONTROL.Q
CONTROL S Note: See the note for the CONTROL A command for exceptions.	READ	MVS.CONTROL.S
CONTROL V Note: See the note for the CONTROL A command for exceptions.	READ	MVS.CONTROL.V
DEVSERV	READ	MVS.DEVSERV
DISPLAY A	READ	MVS.DISPLAY.JOB
DISPLAY ALLOC,GRPLOCKS	READ	MVS.DISPLAY.ALLOC
DISPLAY ALLOC,OPTIONS	READ	MVS.DISPLAY.ALLOC
DISPLAY APPC	READ	MVS.DISPLAY.APPC
DISPLAY ASCH	READ	MVS.DISPLAY.ASCH
DISPLAY ASM	READ	MVS.DISPLAY.ASM
DISPLAY AUTOR	READ	MVS.DISPLAY.AUTOR
DISPLAY CEE	READ	MVS.DISPLAY.CEE
DISPLAY CF	READ	MVS.DISPLAY.CF
DISPLAY CNGRP	READ	MVS.DISPLAY.CNGRP
DISPLAY CONSOLES	READ	MVS.DISPLAY.CONSOLES
DISPLAY DIAG	READ	MVS.DISPLAY.DIAG
DISPLAY DLF	READ	MVS.DISPLAY.DLF
DISPLAY DUMP	READ	MVS.DISPLAY.DUMP
DISPLAY EMCS	READ	MVS.DISPLAY.EMCS
DISPLAY ETR	READ	MVS.DISPLAY.ETR
DISPLAY GRS	READ	MVS.DISPLAY.GRS
DISPLAY GTZ	READ	MVS.DISPLAY.GTZ

Table 11. MVS Commands, RACF Access Authorities, and Resource Names (continued)

Command/Keyword	Authority	Resource-Name
DISPLAY HIS	READ	MVS.DISPLAY.HIS
DISPLAY HS	READ	MVS.DISPLAY.HS
DISPLAY IEFOPZ	READ	MVS.DISPLAY.IEFOPZ
DISPLAY IOS	READ	MVS.DISPLAY.IOS
DISPLAY IPLINFO	READ	MVS.DISPLAY.IPLINFO
DISPLAY IQP	READ	MVS.DISPLAY.IQP
DISPLAY JOBS	READ	MVS.DISPLAY.JOB
DISPLAY LOGGER	READ	MVS.DISPLAY.LOGGER
DISPLAY LOGREC	READ	MVS.DISPLAY.LOGREC
DISPLAY M	READ	MVS.DISPLAY.M
DISPLAY MMS	READ	MVS.DISPLAY.MMS
DISPLAY MPF	READ	MVS.DISPLAY.MPF
DISPLAY MSGFLD	READ	MVS.DISPLAY.MSGFLD
DISPLAY NET	READ	MVS.DISPLAY.NET
DISPLAY OMVS	READ	MVS.DISPLAY.OMVS
DISPLAY OPDATA	READ	MVS.DISPLAY.OPDATA
DISPLAY PARMLIB	READ	MVS.DISPLAY.PARMLIB
DISPLAY PCIE	READ	MVS.DISPLAY.PCIE
DISPLAY PFK	READ	MVS.DISPLAY.PFK
DISPLAY PPT	READ	MVS.DISPLAY.PPT
DISPLAY PROD	READ	MVS.DISPLAY.PROD
DISPLAY PROG	READ	MVS.DISPLAY.PROG
For DISPLAY PROG,EXIT, if resource CSVDYNEX.LIST exists in the FACILITY class, READ authorization to CSVDYNEX.LIST is required.		
DISPLAY R	READ	MVS.DISPLAY.R
DISPLAY RRS	READ	MVS.DISPLAY.RRS
DISPLAY SLIP	READ	MVS.DISPLAY.SLIP
DISPLAY SMF	READ	MVS.DISPLAY.SMF
DISPLAY SMFLIM	READ	MVS.DISPLAY.SMFLIM
DISPLAY SMS	READ	MVS.DISPLAY.SMS
DISPLAY SSI	READ	MVS.DISPLAY.SSI
DISPLAY SYMBOLS	READ	MVS.DISPLAY.SYMBOLS
DISPLAY T	READ	MVS.DISPLAY.TIMEDATE
DISPLAY TCPIP	READ	MVS.DISPLAY.TCPIP
Note: See <i>z/OS Communications Server: IP System Administrator's Commands</i> for more information about DISPLAY TCPIP.		
DISPLAY TRACE	READ	MVS.DISPLAY.TRACE
DISPLAY TS	READ	MVS.DISPLAY.JOB
DISPLAY U	READ	MVS.DISPLAY.U
DISPLAY WLM	READ	MVS.DISPLAY.WLM

Table 11. MVS Commands, RACF Access Authorities, and Resource Names (continued)

Command/Keyword	Authority	Resource-Name
DISPLAY XCF	READ	MVS.DISPLAY.XCF
DUMP	CONTROL	MVS.DUMP
DUMPDS	UPDATE	MVS.DUMPDS
FORCE device	CONTROL	MVS.FORCE.DEV.device
FORCE jobname	CONTROL	MVS.FORCE.JOB.jobname
The previous command is for a job that is not a started task.		
FORCE jobname.id FORCE id	CONTROL	MVS.FORCE.STC.mbrname.id
The previous command is for a started task for which an identifier was provided.		
FORCE jobname	CONTROL	MVS.FORCE.STC.mbrname.jobname
The previous command is for a started task for which an identifier was not provided. <i>mbrname</i> is the name of the member containing the JCL source.		
FORCE U=userid	CONTROL	MVS.FORCE.TSU.userid
FORCE device,ARM	CONTROL	MVS.FORCEARM.DEV.device
FORCE jobname,ARM	CONTROL	MVS.FORCEARM.JOB.jobname
The previous command is for a job that is not a started task.		
FORCE [jobname.]identifier,ARM	CONTROL	MVS.FORCEARM.STC.mbrname.id
The previous command is for a started task for which an identifier was provided.		
FORCE jobname,ARM	CONTROL	MVS.FORCEARM.STC.mbrname.jobname
The previous command is for a started task for which an identifier was not provided. <i>mbrname</i> is the name of the member containing the JCL source.		
FORCE U=userid,ARM	CONTROL	MVS.FORCEARM.TSU.userid
FORCE device,TCB=tcbaddr	CONTROL	MVS.FORCETCB.DEV.device
FORCE jobname,TCB=tcbaddr	CONTROL	MVS.FORCETCB.JOB.jobname
The previous command is for a job that is not a started task.		
FORCE [jobname.]identifier.TCB=tcbaddr	CONTROL	MVS.FORCETCB.STC.mbrname.id
The previous command is for a started task for which an identifier was provided.		
FORCE jobname,TCB=tcbaddr	CONTROL	MVS.FORCETCB.STC.mbrname.jobname
The previous command is for a started task for which an identifier was not provided. <i>mbrname</i> is the name of the member containing the JCL source.		
FORCE U=userid.TCB=tcbaddr	CONTROL	MVS.FORCETCB.TSU.userid
HALT EOD	UPDATE	MVS.HALT.EOD
HALT NET	UPDATE	MVS.HALT.NET
IOACTION	CONTROL	MVS.IOACTION
LIBRARY	UPDATE	MVS.LIBRARY
LOG	READ	MVS.LOG
MODE	UPDATE	MVS.MODE
MODIFY jobname	UPDATE	MVS.MODIFY.JOB.jobname
The previous command is for a job that is not a started task.		
MODIFY userid	UPDATE	MVS.MODIFY.JOB.userid

Table 11. MVS Commands, RACF Access Authorities, and Resource Names (continued)

Command/Keyword	Authority	Resource-Name
MODIFY jobname MODIFY jobname.id MODIFY id	UPDATE	MVS.MODIFY.STC.mbrname.id
The previous command is for a started task for which an identifier was provided.		
MODIFY jobname	UPDATE	MVS.MODIFY.STC.mbrname.jobname
The previous command is for a started task for which an identifier was not provided. <i>mbrname</i> is the name of the member containing the JCL source. Note: MODIFY might actually affect more than one job. For example: <ul style="list-style-type: none"> • If START ABC.DEF and START ABC.GHI are issued, MODIFY ABC.* affects both jobs, and one authorization request is issued for each. • If the START ABC command is issued twice, two started tasks named ABC start running on the system. MODIFY ABC affects both jobs, and one authorization request is issued for each. Note: The target of the MODIFY command may allow or require additional authorizations. Please be sure to examine all documentation regarding the target of the command to insure that the proper security is in place.		
MONITOR	READ	MVS.MONITOR
MOUNT	UPDATE	MVS.MOUNT
PAGEADD	UPDATE	MVS.PAGEADD
PAGEDEL	UPDATE	MVS.PAGEDEL
QUIESCE	CONTROL	MVS.QUIESCE
REPLY	READ	MVS.REPLY
RESET	UPDATE	MVS.RESET
RESET CN	CONTROL	MVS.RESET.CN
ROUTE system	READ	MVS.ROUTE.CMD.system
Note: <ol style="list-style-type: none"> 1. When a system name is specified on the ROUTE command, <i>system</i> is the name of the system that is the target of the command. 2. When the security profile MVS.CPF.ROUTE.CHECK is defined in the OPERCMDS class, the resource-name MVS.ROUTE.CMD.system is used to validate access authority to using the command prefix facility (CPF) to transport a command to a different system in the sysplex. 		
ROUTE *ALL	READ	MVS.ROUTE.CMD.ALLSYSTEMS
ROUTE *OTHER	READ	MVS.ROUTE.CMD.OTHERSYSTEMS
ROUTE sysgrpname	READ	MVS.ROUTE.CMD.sysgrpname
ROUTE (sys1,...,sysN)	READ	MVS.ROUTE.CMD.sys1 : : MVS.ROUTE.CMD.sysN
ROUTE (group1,...,groupN)	READ	MVS.ROUTE.CMD.group1 : : MVS.ROUTE.CMD.groupN
SEND	READ	MVS.SEND
SET APPC	UPDATE	MVS.SET.APPC
SET ASCH	UPDATE	MVS.SET.ASCH

Table 11. MVS Commands, RACF Access Authorities, and Resource Names (continued)

Command/Keyword	Authority	Resource-Name
SET AUTOR	UPDATE	MVS.SET.AUTOR
SET CEE	UPDATE	MVS.SET.CEE
SET CLOCK	UPDATE	MVS.SET.TIMEDATE
SET CNGRP	UPDATE	MVS.SET.CNGRP
SET CON	UPDATE	MVS.SET.CON
SET DAE	UPDATE	MVS.SET.DAE
SET DATE	UPDATE	MVS.SET.TIMEDATE
SET DEVSUP	UPDATE	MVS.SET.DEVSUP
SET GRSRNL	UPDATE	MVS.SET.GRSRNL
SET GTZ	UPDATE	MVS.SET.GTZ
SET IEFOPZ	UPDATE	MVS.SET.IEFOPZ
SET IOS	UPDATE	MVS.SET.IOS
SET IQP	UPDATE	MVS.SET.IQP
SET IXGCNF	UPDATE	MVS.SET.IXGCNF
As part of the SET command, system logger may issue a TRACE CT or a DISPLAY LOGGER command. See z/OS MVS <i>Setting Up a Sysplex</i> for further information about determining message buffer space. for additional required SAF authority.		
SET MMS	UPDATE	MVS.SET.MMS
SET MPF	UPDATE	MVS.SET.MPF
SET MSGFLD	UPDATE	MVS.SET.MSGFLD
SET OPT	UPDATE	MVS.SET.OPT
SET PFK	UPDATE	MVS.SET.PFK
SET PROG	UPDATE	MVS.SET.PROG
Note: For examples of how to define RACF profiles for SET PROG, SETPROG APF, SETPROG EXIT, SETPROG LNKLST and SETPROG LPA, see Examples and MVS Planning Aids for Operations in z/OS <i>MVS Planning: Operations</i> .		
SET RESET	UPDATE	MVS.SET.TIMEDATE
SET SCH	UPDATE	MVS.SET.SCH
SET SLIP	UPDATE	MVS.SET.SLIP
SET SMF	UPDATE	MVS.SET.SMF
SET SMFLIM	UPDATE	MVS.SET.SMFLIM
SET SMS	UPDATE	MVS.SET.SMS
SETALLOC	UPDATE	MVS.SETALLOC.ALLOC
SETAPPC	UPDATE	MVS.SETAPPC.APPC
SETAUTOR	UPDATE	MVS.SETAUTOR.AUTOR
SETCEE	UPDATE	MVS.SETCEE.CEE
SETCON DELETE	UPDATE	MVS.SETCON.DELETE
SETCON MODE	CONTROL	MVS.SETCON.MODE
SETCON MONITOR (MN)	CONTROL	MVS.SETCON.MONITOR
SETETR	UPDATE	MVS.SETETR.ETR
SETGRS	UPDATE	MVS.SETGRS.AUTHQLVL

Table 11. MVS Commands, RACF Access Authorities, and Resource Names (continued)

Command/Keyword	Authority	Resource-Name
SETGRS CNS	CONTROL	MVS.SETGRS.GRS
SETGRS MODE=STAR ENQMAXA ENQMAXU CNS MONITOR	UPDATE	MVS.SETGRS.TOLINT MVS.SETGRS.RESMIL MVS.SETGRS.MODE.STAR MVS.SETGRS.SYNCHRES MVS.SETGRS.GRSQ MVS.SETGRS.ENQMAXA MVS.SETGRS.ENQMAXU MVS.SETGRS.CNS MVS.SETGRS.MONITOR
SETGTZ	UPDATE	MVS.SETGTZ.GTZ
SETIOS	UPDATE	MVS.SETIOS.IOS
SETHS	UPDATE	MVS.SETHS
SETLOAD xx,IEASYM	UPDATE	MVS.SETLOAD.IEASYM
SETLOAD xx,PARMLIB	UPDATE	MVS.SETLOAD.LOAD
SETLOGR	UPDATE	MVS.SETLOGR.LOGR
As part of the SETLOGR command, system logger may issue a TRACE CT or a DISPLAY LOGGER command. See <i>z/OS MVS Setting Up a Sysplex</i> for additional required SAF authority.		
SETLOGRC	CONTROL	MVS.SETLOGRC.LOGRC
SETMF	UPDATE	MVS.SETMF.MF
SETOMVS	UPDATE	MVS.SETOMVS.OMVS
SETPROG	UPDATE	MVS.SETPROG
Note: For examples of how to define RACF profiles for SETPROG, SETPROG APF, SETPROG EXIT, SETPROG LNKLST and SETPROG LPA, see Examples and MVS Planning Aids for Operations in <i>z/OS MVS Planning: Operations</i> .		
SETRRS ARCHIVELOGGING	UPDATE	MVS.SETRRS.ARCHIVELOGGING
SETRRS CANCEL	UPDATE	MVS.SETRRS.CANCEL
SETRRS SHUTDOWN	UPDATE	MVS.SETRRS.SHUTDOWN
SETSMF	UPDATE	MVS.SETSMF.SMF
SETSMS	UPDATE	MVS.SETSMS.SMS
SETSSI ACTIVATE	CONTROL	MVS.SETSSI.ACTIVATE.subname
SETSSI ADD	CONTROL	MVS.SETSSI.ADD.subname
SETSSI DEACTIVATE	CONTROL	MVS.SETSSI.DEACTIVATE.subname
SETSSI DELETE	CONTROL	MVS.SETSSI.DELETE.subname
Note: The following rules apply to the subsystem name (subname) value in the SETSSI commands: <ul style="list-style-type: none"> • Lower case characters in the subsystem name will be translated to upper case in the resource-name. • The characters *, &, or % in the subsystem name will be translated to the _ character in the resource-name. • Embedded blanks in the subsystem name will be translated to the _ character in the resource-name. • Trailing blanks will not be translated. • No other characters are translated. IBM recommends defining generic profiles to match subsystem names with characters that cannot be specified using the RACF command interface. 		
SETUNI	UPDATE	MVS.SETUNI.UNI
SETXCF	UPDATE	MVS.SETXCF.XCF
SLIP	UPDATE	MVS.SLIP

Table 11. MVS Commands, RACF Access Authorities, and Resource Names (continued)

Command/Keyword	Authority	Resource-Name
Note: When the IEASLIP.REFRESH FACILITY class profile is defined, the SLIP command issuer must have UPDATE access to that profile to use the REFAFTER and REFBEFOR keywords.		
START mbrname[.identifier]	UPDATE	MVS.START.STC.mbrname[.id]
The previous command is for a started task for which an identifier was provided. <i>mbrname</i> is the name of the member containing the JCL source.		
START mbrname,JOBNAME=jobname	UPDATE	MVS.START.STC.mbrname.jobname
The previous command is for a started task for which an identifier was not provided. <i>mbrname</i> is the name of the member containing the JCL source.		
START commands that use one or more of the following keywords: • DSN or DSNAME • DISP • PROTECT	UPDATE	The resource name substitutes DDALERT for one or more of the keywords. MVS.START.jobname.qualifier.DDALERT
An example of the previous MVS START command is as follows: START jobname.qualifier,DSN=dsname.qualifier,DISP=SHR		
STOP jobname	UPDATE	MVS.STOP.JOB.jobname
The previous command is for a job that is not a started task.		
STOP userid	UPDATE	MVS.STOP.JOB.userid
STOP jobname STOP jobname.id STOP id	UPDATE	MVS.STOP.STC.mbrname.id
The previous command is for a started task for which an identifier was provided. <i>mbrname</i> is the name of the member containing the JCL source.		
STOP jobname	UPDATE	MVS.STOP.STC.mbrname.jobname
The previous command is for a started task for which an identifier was not provided. <i>mbrname</i> is the name of the member containing the JCL source. Note: STOP might actually affect more than one started task if more than one unit of work with the same name is active at the same time. If so, there is one call to RACF for command authorization for each unit of work.		
STOPMN	READ	MVS.STOPMN
SWAP	UPDATE	MVS.SWAP
SWITCH SMF	UPDATE	MVS.SWITCH.SMF
TRACE CT	UPDATE	MVS.TRACE.CT
TRACE MT	CONTROL	MVS.TRACE.MT
TRACE ST	UPDATE	MVS.TRACE.ST
TRACE STATUS	UPDATE	MVS.TRACE.STATUS
UNLOAD	UPDATE	MVS.UNLOAD
VARY CN	UPDATE	MVS.VARY.CN
VARY CN,ACTIVATE	READ	MVS.VARY.CN
Note: Issue VARY CN,ACTIVATE only from the system console.		
VARY CN,AUTH	UPDATE CONTROL	MVS.VARY.CN MVS.VARYAUTH.CN
Note: VARY CN,AUTH requires both profiles.		
VARY CN,DEACTIVATE	READ UPDATE	MVS.VARY.CN

Table 11. MVS Commands, RACF Access Authorities, and Resource Names (continued)

Command/Keyword	Authority	Resource-Name
Note: For the VARY CN,DEACTIVATE command, READ applies only when that command is issued from the system console; otherwise, UPDATE applies.		
VARY CN,LOGON	UPDATE CONTROL	MVS.VARY.CN MVS.VARYLOGON.CN
Note: VARY CN,LOGON requires both profiles.		
VARY CN,LU	UPDATE CONTROL	MVS.VARY.CN MVS.VARYLU.CN
Note: VARY CN,LU requires both profiles.		
VARY CN,OFFLINE,FORCE	CONTROL	MVS.VARYFORCE.CN
VARY CN(...),STANDBY	CONTROL	MVS.VARYSTANDBY.CN
VARY CONSOLE	UPDATE	MVS.VARY.CONSOLE
VARY CONSOLE,AUTH	UPDATE CONTROL	MVS.VARY.CONSOLE MVS.VARYAUTH.CONSOLE
Note: VARY CONSOLE,AUTH requires both profiles.		
VARY CU	CONTROL	MVS.VARY.CU
VARY CU,FORCE	CONTROL	MVS.VARYFORCE.CU
VARY GRS	CONTROL	MVS.VARY.GRS
VARY HARDCPY	CONTROL	MVS.VARY.HARDCPY
VARY NET	UPDATE	MVS.VARY.NET
VARY OFFLINE	UPDATE	MVS.VARY.DEV
Note: If VARY CN,OFFLINE is specified, the rules for VARY CN apply (the system checks for UPDATE access to MVS.VARY.CN, not MVS.VARY.DEV).		
VARY OFFLINE,FORCE	CONTROL	MVS.VARYFORCE.DEV
VARY ONLINE	UPDATE	MVS.VARY.DEV
Note: If VARY CN,ONLINE is specified, the rules for VARY CN apply (the system checks for UPDATE access to MVS.VARY.CN, not MVS.VARY.DEV).		
VARY PATH	UPDATE	MVS.VARY.PATH
VARY SMS	UPDATE	MVS.VARY.SMS
VARY TCPIP	UPDATE	MVS.VARY.TCPIP
Note: See <i>z/OS Communications Server: IP System Administrator's Commands</i> for more details and information on necessary profiles for MVS.VARY.TCPIP command.		
VARY WLM	CONTROL	MVS.VARY.WLM
VARY XCF	CONTROL	MVS.VARY.XCF
WRITELOG	READ	MVS.WRITELOG

Changing the authorization of a console

You can change the system command groups that a console is authorized to enter.

You change the authorization of consoles by:

- **Using the VARY Command:**

The VARY CN,AUTH= command defines which system command groups may be entered through the consoles specified on the AUTH= keyword.

Example:

To assign master level authority to a console named REMOTE, enter:

```
VARY CN(REMOTE),AUTH=MASTER
```

Enter this command through any console that has master authority. If you try to enter this command from a console without master authority, the command is rejected and a message appears to indicate that the switch did not take place.

In console services shared mode, the effect of this command lasts for the duration of the IPL; in distributed mode, the effect of the command lasts only for the duration of the console being active.

Defining console use

MCS consoles can operate in one of the following ways:

- Status Display Console
- Message Stream Console
- Full-capability Console

Note: In this book, the term output-only mode refers to status display mode and message stream mode.

Note: HMCS and SMCS consoles are not permitted to be status display or message stream consoles. HMCS and SMCS consoles can only be full-capability consoles.

Using a status display console: A status display console has output capability only; it cannot be used to enter commands. The system uses the screen to receive status displays.

A console in status display mode provides a convenient area for displaying system status information and frees a full capacity console for use by other system messages.

You can divide the screen of the status display console into display areas, according to your needs.

Controlling displays on status display consoles: Because a status display console has no input capability, you must enter each request concerning the console on a separate full-capability console. Use the routing location operand with each command to designate the console and display area at which an action is to take place.

The routing location operand can be entered only from a console with CONS (console control) command group authority. Command group authority is described under "System commands grouped according to system command authority" on page 124.

Using a message stream console: A message stream console has output capability only; it cannot be used to enter commands. The system uses the screen to present general messages.

A console in message stream mode provides an area for presentation of messages. The messages sent to a message stream console depend on the routing codes or message levels assigned to that console. Message stream consoles can provide system monitoring capabilities in tape or disk libraries, or can assist in system security.

Deleting messages from message stream consoles: When a console enters message stream mode, roll-deletable message deletion goes into effect automatically. (See

“Defining Automatic Message Deletion” later in this section.) All messages except action messages are automatically removed from the screen.

Using a full-capability console

A full-capability console has both input and output capability; the console can be used both to enter commands and to receive status displays and messages. There can be many full-capability consoles in the system or sysplex.

You can divide the screen on a full-capability console so that part of the screen receives general messages and the other part receives status displays. When a status display is not on the screen, MCS uses the status display area for general messages.

Changing full-capability to message stream or status display mode: The screens of the message stream console and the status display console appear identical; they do not have any entry area. However, the screens of the consoles in message stream mode receive general messages and the screens of the status display consoles receive formatted status displays.

When you change a full-capability console to message stream or status display mode, the PFK display line, the instruction line, and the entry area are incorporated into the message area or the display area. Figure 20 shows the 3277 model 2, in message stream mode. Once a display console enters message stream or status display mode, it can accept no more input; you must use another console to enter commands. Examples at the end of this section illustrate how the display on a full-capability console changes to the display on a status display or message stream console.

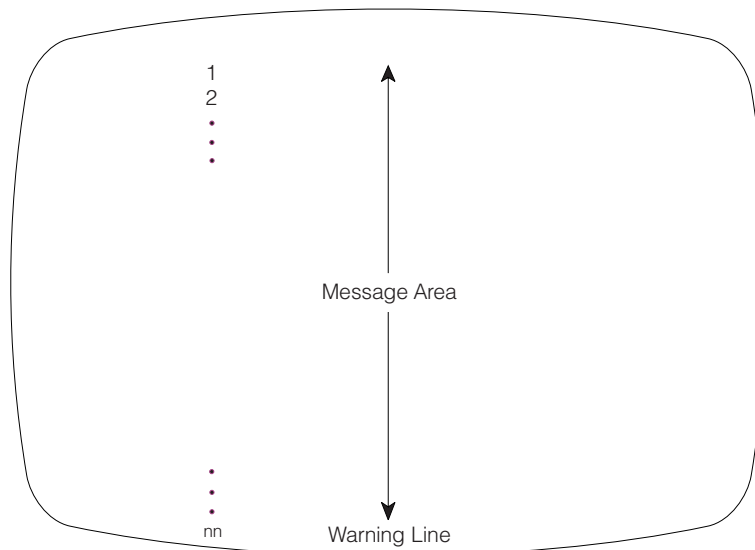

Figure 20. Format of a console screen in message stream mode

The system gives you the following choices for operating mode for MCS consoles:

- FC Full-capability
- MS Message stream
- SD Status display

HMCS and SMCS consoles can only be FC (full-capability) mode consoles. The operating mode of an HMCS or SMCS console cannot be changed.

If a console is an input/output device, the default operating mode is full-capability mode.

You can check the console operating mode by entering the CONTROL V,REF command. In response to this command, the specifications appear in the entry area. You can change the specifications using the procedures described under “Changing information in the entry area” on page 113.

You define the operating mode of a console by:

- **Using the CONTROL Command:**

Use the USE operand on the CONTROL V command to change the operating mode of a console.

Example 1:

To define the console with a console name of CON8 as a full-capability console, enter:

```
CONTROL V,USE=FC,L=CON8
```

In console services shared mode, the effect of this command lasts for the duration of the IPL; in distributed mode, the effect of the command lasts only for the duration of the console being active.

Note: When you use the CONTROL command to change the console operating mode, you might also have to change other console characteristics. If the new definition for the console operating mode is incompatible with other characteristics, the system rejects the CONTROL command.

Example 2:

To change the console in Example 1 from full-capability mode to status display mode, enter:

```
CONTROL V,USE=SD,L=CON8
```

In response to this command, any information on the screen disappears, and the system reestablishes the display area specifications that were defined in the CONSOLxx parmlib member. If you were changing the console from full-capability mode to message stream mode, information on the screen would disappear and the message area would expand, as in Figure 20 on page 137.

Example 3:

To return CON8 to full-capability mode, enter the following command from a full-capability console:

```
CONTROL V,USE=FC,L=CON8
```

In response to this command, the message area of the console with a console name of CON8 returns to its full-capability size, and the console specifications return to those established the last time the console was in full-capability mode for this IPL or those established in the CONSOLxx member.

The display area specifications also return to the specifications established the last time the console was in full-capability mode.

Controlling system messages and commands

Messages are the system's chief means of communication with you. Messages range from **informational**, which are important but do not require a response, to **immediate action**, which are not only important but require that you perform the requested action at once. The action might be required because the message issuer waits until the action is performed, or because taking the action as soon as possible can improve system performance. Less urgent, but still important, are the **eventual action** and **critical eventual action** messages. The message issuer is not waiting for you to perform the action, but a number of unanswered requests might degrade system performance.

The size of the screen's message area varies, depending on the type of display console. When the message area becomes full, you need to delete messages to make room for new ones. You can delete messages, or have the system do it for you automatically. (See "Deleting Messages from the Console Screen" later in this chapter.) Once an action message is deleted from the screen, you cannot see the entire message again unless the action message retention facility is active and you have issued a DISPLAY R command.

So that you do not have to delete messages too often, make sure that you manage message traffic carefully on all consoles. For example, if you find that a console screen often fills with action messages, think about:

- Adjusting routing codes and assigning message levels. Any console should receive only messages for which the operator of that console is directly responsible.
- Activating the action message retention facility so you can put the console in roll mode without losing action messages.

Defining routing codes for a console

Most messages have one or more routing codes. The system uses these codes, decimal numbers from 1 to 128, to determine which console or consoles should receive a message. The system programmer assigns routing codes to the consoles attached to your system so that a specific message type is routed to the proper console. Table 12 lists the routing codes.

Routing codes do not appear with a message at a console; routing codes 1 through 28 do, however, appear on the system log. To determine the routing codes each console receives, use the DISPLAY CONSOLES,A command. Figure 19 on page 124 shows the display that appears in response to this command.

Table 12. Message Routing Codes

Code	Definition
1	Primary operator action
2	Primary operator information
3	Tape pool
4	Direct access pool
5	Tape library
6	Disk library
7	Unit record pool
8	Teleprocessing control
9	System security

Table 12. Message Routing Codes (continued)

Code	Definition
10	System error/maintenance/system programmer information
11	Programmer information
12	Emulators
13-20	Reserved for customer use
21-28	Reserved for subsystem use
29	Disaster Recovery
30-40	Reserved for IBM
41	Information about JES3 job status
42	General information about JES2 or JES3
43-64	Reserved for JES2 or JES3
65-96	Messages associated with particular processors
97-128	Messages associated with particular devices

One way to limit the messages that arrive at a console is to assign a routing code or codes to a console. The console then receives only the messages that are appropriate.

To learn what the routing codes for a console are, enter the DISPLAY CONSOLES command. Figure 19 on page 124 shows the display that appears in response to this command.

You define routing codes for a console by:

- **Using the VARY command:**

Use operands on the VARY command to add to the existing set (AROUT operand), subtract from the existing set (DROUT), or redefine the set (ROUT).

Example:

To assign the routing codes 1, 2, 9, and 10 for a console named CON81D, enter:
VARY CN(CON81D),ROUT=(1,2,9,10)

In console services shared mode, the effect of this command lasts for the duration of the IPL; in distributed mode, the effect of the command lasts only for the duration of the console being active.

Defining message levels for a console

Assigning routing codes is one way to limit message traffic to a console. You can further reduce the number of messages that appear on a console by directing certain messages to consoles by message levels. The system differentiates among these kinds of message levels:

- Write-to-operator with reply (WTOR) messages, which demand an immediate reply.
- System failure and immediate action messages (descriptor codes 1 and 2), which indicate that a task is awaiting your action.
- Critical eventual action messages (descriptor code 11), which indicate a potential system problem.
- Eventual action messages (descriptor code 3), which do not require immediate attention.
- Broadcast messages, which are normally sent to every active console regardless of the routing code you assigned to the console.

- Informational messages, which generally indicate system status. (Most messages are informational.)

Assignment by message level means that a console can accept combinations of action, broadcast, and informational messages that the system sends to a console. You can choose among the following message level options:

- R** Write to operator (WTOR) messages are to appear
- I** Immediate action messages (descriptor codes 1 and 2) are to appear
- CE** Critical eventual action messages (descriptor code 11) are to appear
- E** Eventual action messages (descriptor code 3) are to appear
- IN** Informational messages are to appear
- NB** Broadcast messages are **not** to appear
- ALL** All messages, including broadcast messages, are to appear.

If the LEVEL parameter in the CONSOLxx member is not coded, the system sends all messages, including broadcast messages, to the console.

To display the routing codes and message levels for a console, issue the DISPLAY CONSOLES command. Figure 19 on page 124 shows the display that appears in response to this command.

To display the routing codes and message levels that appear only on the system log **and not on any console**, issue the DISPLAY CONSOLES,HC command.

You define the level of messages for a console by:

- **Using the CONTROL Command:**

Use the LEVEL operand on the CONTROL V command to assign message levels to a console.

Example 1:

To direct only WTOR messages and immediate action messages to the console with console name CON06, enter:

```
CONTROL V,LEVEL=(R,I),L=CON06
```

Example 2:

To assign to the console with console name CON12 (and device number 81D) the informational messages directed to the tape libraries (routing code 5) and disk libraries (routing code 6), enter:

```
VARY 81D,CONSOLE,ROUT=(5,6)
CONTROL V,LEVEL=IN,L=CON12
```

Controlling the format of messages

On a display console, a message can appear by itself or with information about the message, such as job and system identification and the time the message was issued. "Messages sent to display consoles" on page 106 describes the format of messages and describes the optional information that the system can include with each message:

- J** The jobname/job id of its issuer
- S** The name of the system that issued the message
- T** A time stamp
- M** Only the message text displays

X Suppress system and job name of its issuer when S and/or J are specified

You request that additional information precede each message the system sends a console by:

- **Using the CONTROL command:**

Use the MFORM operand on the CONTROL S command to change the format of messages.

Example:

To request that the system add to all messages that appear at console CON2 a time stamp, the name of the system that issued the message, and the jobname or ID of its issuer, enter:

```
CONTROL S,MFORM=(J,T,S),L=CON2
```

In console services shared mode, the effect of this command lasts for the duration of the IPL; in distributed mode, the effect of the command lasts only for the duration of the console being active.

Controlling the message processing facility (MPF)

The message processing facility (MPF) controls message processing. It controls the suppression and retention of messages, the installation exits that gain control when certain messages and commands are issued, and message presentation (that is, the color, intensity and highlighting of messages) at certain consoles. It also controls the foreign messages and DOMs that are seen by subsystems and whether verbose messages are to be produced.

The operator can:

- See what MPF member or members are active with the DISPLAY command
- Change the active MPF member or members with the SET command.

For MPF to suppress messages, hardcopy processing must be active. The suppressed messages do not appear on any console; they do appear on the hardcopy log, and any extended MCS consoles that are receiving the hardcopy message set.

Message presentation:

Message presentation refers to the way the system uses color, intensity, and highlighting (including blinking, reverse-video, and underscoring) to identify messages that require action. The presentation depends on the type of device you are using.

Using the SET command:

Enter the SET MPF command to change the MPFLSTxx member or members that the system is to use.

Example:

To specify MPFLST03 and MPFLST06 as the MPF members for the system to use, enter:

```
SET MPF=(03,06)
```

The effect of this command lasts only for the duration of the IPL.

Displaying information about messages awaiting action: Many systems now handle so much work so quickly that you cannot always keep up with the messages that demand operator response. These messages roll off the screen before you can respond. The action message retention facility keeps these messages, including the WTORs and JES3 messages, so that you can see them at a later time. (While you are examining the messages that you missed, you might, of course, miss more messages. Experience with your system will help you determine how frequently you need to check for retained action messages.)

The DISPLAY R command allows you to display all outstanding action messages or a subset of these messages. For example, to display all outstanding action messages at your console, enter DISPLAY R,M. To display all the outstanding critical eventual-action messages (descriptor code 11), enter DISPLAY R,CE. See *z/OS MVS Planning: Operations* for use of the DISPLAY R command.

Controlling the action message retention facility

During its initialization, the system can start the action message retention facility (AMRF). When active, the facility retains in a buffer area all action messages (those messages with descriptor codes 1, 2, 3, and 11) except those specified by the installation in the active MPFLSTxx member.

If the first system IPLs and AMRF is active, then AMRF is active on every system that you subsequently IPL into the sysplex.

When you have performed the action required by a message displayed on the screen, the system deletes the message; or you can use the CONTROL C command to delete the message. You can remove action messages from the screen that require later action, then retrieve them in their entirety later by using the DISPLAY R command. Periodically, you should display the retained messages and delete the ones for which action has been taken so that the action message retention buffer does not fill up.

To change the messages that the action message retention facility is to retain, activate an MPFLSTxx member that contains the message retention options you want. The system default is to have the action message retention facility on.

To learn the status of the action message retention facility, issue the CONTROL M,REF command.

You change the status of the action message retention facility by:

- **Using the CONTROL command**

Use the CONTROL M,AMRF command to turn the action message retention facility on or off.

Example:

To deactivate the action message retention facility, enter:

```
CONTROL M,AMRF=N
```

Controlling message flood automation

Message flood automation detects and handles message floods caused by device or software failures. It uses policy created by the installation to decide when a message flooding situation is happening and what actions to take.

The operator can:

- Change the active MSGFLDxx parmlib member with the SET command

- See the status of Message Flood Automation and the MSGFLDxx member that is active with the DISPLAY command
- Turn Message Flood Automation on and off and alter the active Message Flood Automation policy with the SETMF command

Using the SET command: Enter the SET MSGFLD command to change the MSGFLDxx member that the system is to use.

Example:

To specify MSGFLD03 as the Message Flood Automation member for the system to use, enter:

```
SET MSGFLD=03
```

The effect of this command lasts only for the duration of the IPL.

Using the DISPLAY command: Enter the DISPLAY MSGFLD command to obtain information about Message Flood Automation.

Example:

To determine the status of Message Flood Automation, enter:

```
DISPLAY MSGFLD,STATUS
```

Using the SETMF command: Enter the SETMF command to alter the state or policy of Message Flood Automation.

Example:

To enable Message Flood Automation processing, enter:

```
SETMF ON
```

Activating WTO and WTOR installation exit routines

The system programmer at your installation codes installation exit routines that gain control when the system issues certain messages. A WTO installation exit can change routing codes, descriptor codes, and message texts, as well as perform other message processing; it can override MPF processing. Information about coding these installation exits appears in *z/OS MVS Installation Exits*.

The most effective message control involves coding and installing the installation exit IEAVMXIT, which can gain control when any WTO or WTOR message is issued.

To learn whether IEAVMXIT is active or not, issue the CONTROL M,REF command. The system displays (in the entry area) the status of the action message retention facility, the status of installation exit IEAVMXIT, and the limit of the number of WTO and WTOR buffers.

Your installation might have other exit routines to process messages. MPFLSTxx parmlib members contain the IDs of messages and the installation exits that process these messages. To activate processing by these installation exits, see "Controlling the message processing facility (MPF)" on page 142.

You can activate the installation exit IEAVMXIT, if it is installed, by:

- Using the CONTROL command:

Use the UEXIT operand on the CONTROL command to control whether the installation exit IEAVMXIT is active.

Example:

To deactivate IEAVMXIT, enter:

```
CONTROL M,UEXIT=N
```

The effect of the command lasts only for the duration of the IPL.

Checking message processing, retention, and presentation options

Issue the DISPLAY MPF,MSG command to view the following information:

- Which messages are being suppressed by MPF
- Which action messages are not being retained by the action message retention facility
- Which installation exits receive control for selected messages
- The status of the general WTO installation exit IEAVMXIT
- Whether this message is automated by MPF
- The MPFLSTxx member that identifies the message ID, color attribute, or command installation exit definition
- A list of the subsystems receiving foreign messages and DOMs
- Whether verbose messages are to be produced or not.

Issue the DISPLAY MPF,COLOR command to view the following information:

- What color, intensity, and highlighting capabilities are in effect.

Issue the DISPLAY MPF command to see all of this information for the messages that are defined in the MPFLSTxx parmlib member.

Defining program function keys (PFKs)

You can define program function keys for a console by activating a PFK table or by using the CONTROL N,PFK= command.

Defining PFKs using PFK tables

You define a console's PFKs by activating a PFK table — a table that your installation has defined. The PFK table resides, optionally with other PFK tables, in a PFKTABxx parmlib member. The entries in this table:

- Assign one or more commands to a PFK
The text of one or more commands are to be associated with a PFK. Later, when you press this PFK, the commands are entered into the system.
- Assign one or more other PFKs to a PFK
The commands associated with other PFKs are to be associated with one PFK.

Entries in the PFK table also determine whether conversational or nonconversational mode is to be in effect for a command defined to a PFK. In nonconversational mode, the commands associated with a key are entered immediately when you press the key. In conversational mode, pressing a PFK causes the command to appear in the entry area, but no enter action takes place. You can change, enter, or cancel the command according to your requirements.

In conversational mode, the cursor normally appears under the third non-blank character when the command is in the entry area. If you want the cursor to appear in a different location, when you define the command, type an underscore before

the character under which the cursor is to appear. The system deletes the space occupied by the underscore in the actual command. For example, if you add the following entry to a PFK table:

```
PFK(5) CMD('D U,L=_XXX') CON(Y)
```

pressing PFK 5 causes the following to appear in the entry area:

```
D U,L=XXX
```

If you want an underscore to appear in the command, code two consecutive underscores. The system will treat them as a single underscore, and will not use them for cursor placement. Example:

If the PRKTAB table contains:

```
PFK(17) CMD('E _XXXXXXXX,SRVCLASS=BAT__HI'),CON(Y)
```

when you press PFK17, the entry area will contain:

```
E _XXXXXXXX,SRVCLASS=BAT_HI
```

with the cursor under the first X.

Selector pens also use the definitions in PFK tables.

You can use some MVS commands to display information about the PFKs at your console, or to change the PFKs that are available for your consoles. The following commands relate to the previous example:

- Display the PFK definitions in the PFK table named MVSCMDS.
DISPLAY PFK,TABLE=MVSCMDS
- List the names of all PFK tables in the active PFKTABxx member.
DISPLAY PFK,TABLE
- Assign the commands in the PFK table named JES2CMDS to the PFKs on your console.
CONTROL N,PFK=JES2CMDS
- Activate another PFKTABxx member, in this case PFKTAB02.
SET PFK=02

This command assumes that you have a PFK table in PFKTAB02 and that you want to replace MVSCMDS with another PFK table. (Other consoles might be using tables in the former PFKTABxx member. PFK definitions for these consoles are not affected by the action of this SET command.)

Defining PFKs using the CONTROL command

Use the CONTROL N,PFK= command to change the definition for PFKs. This command performs three tasks:

- Assigns one or more commands to a PFK
- Assigns one or more other PFKs to a PFK
- Assigns a PFK table to your console.

With the CONTROL N,PFK= command you can also determine whether conversational or nonconversational mode is to be in effect for the commands defined to the PFK. Nonconversational mode is the default. For example, if you define PFK 5 as follows:

```
CONTROL N,PFK=(5,CMD='D U,L=CON9A'),CON=N
```

pressing PFK 5 has the same effect as typing DISPLAY U,L=CON9A and pressing the ENTER key.

On the other hand, if you specify conversational mode by entering:

```
CONTROL N,PFK=(5,CMD='D U,L=CON9A'),CON=Y
```

pressing PFK 5 causes the command D U,L=CON9A to appear in the entry area but no enter action takes place. You can change, enter, or cancel the command according to your requirements.

The system does not accept PFK assignments that may result in an endless loop. Examples of commands that the system will not accept are:

- You **cannot** assign a PFK to itself. For example, the system does not accept CONTROL N,PFK=(9,KEY=9).
- If a PFK is being assigned a list of PFKs (that is, a key list), that PFK **cannot** appear in the key list for another PFK. For example, if PFK 5 is already associated with keys 3 and 4, the system does not accept CONTROL N,PFK=(6,KEY=5,8).
- If a PFK is already in a key list, you **cannot** assign a key list to that PFK. For example, if key 4 is associated with keys 5 and 6, the system does not accept CONTROL N,PFK=(5,KEY=7,8).

Remember that the assignment of the command to the PFK through the CONTROL command lasts only for the duration of the IPL.

Example 1:

If PFK 3 is associated with commands SET OPT=PM and SEND 14,BRDCST, and PFK 4 is associated with the command START GTF,MODE=INT,BUF=387,TIME=YES,DEBUG=YES, you can associate all three of these commands with PFK 5 by entering:

```
CONTROL N,PFK=(5,KEY=3,4),CON=Y
```

The commands associated with PFK 5 are now:

```
SET OPT=PM
SEND 14,BRDCST
START GTF,MODE=INT,BUF=387,TIME=YES,DEBUG=YES
```

The system schedules the commands in that order, but might not execute them in that order.

Example 2:

To remove a definition previously set for PFK 5, leaving PFK 5 undefined, enter:

```
CONTROL N,PFK=(5,CMD='')
```

The PFKTABxx and PFKs

The PFKTABxx parmlib members contain the **PFK tables** that have the definitions your installation has assigned to PFKs. To associate your console's PFKs with the definitions in a particular PFK table:

- The PFK parameter on the INIT statement in the active CONSOLxx member must identify the PFKTABxx member that contains the table.
- The PFKTAB parameter on the CONSOLE statement in CONSOLxx must identify the name of the PFK table.

- The particular table must contain entries; each entry supplies a command or commands associated with a PFK.

You use CONSOLxx and PFKTABxx members to set the PFK definitions at IPL. You can also change the PFK definitions for the duration of the IPL:

To change a PFK table:

1. Enter SET PFK=xx, if necessary, to change the PFKTABxx member in effect for the console. Other consoles using the former PFKTABxx member are not affected by the SET command you issue for your console.
2. Enter CONTROL N,PFK=nnnnnnnn to assign the PFK table that contains the PFK definitions you want to use for the console.

To change a PFK key:

- Enter CONTROL N,PFK=(nn1,CMD='...') to change a specific PFK key definition for the console where the command is entered.

During IPL, the system looks for the PFK parameter in CONSOLxx member. If the system does not find the PFK parameter, it issues the message:

```
IEA180I USING IBM DEFAULT DEFINITIONS. NO PFK TABLES REQUESTED
```

In this case, PFKs 1 through 8 have the defaults that IBM supplies. These defaults are shipped in sample IEESPFK.

To define PFKs for your consoles, see “Defining PFKs using PFK tables” on page 145.

Processing hardcopy

Logging provides a permanent record of system activity. Your installation can record system messages and, optionally, commands and command responses, by using the system log (SYSLOG), the operations log (OPERLOG), or both. Your installation can also allow an extended MCS console to receive the same set of messages as SYSLOG and OPERLOG. The log that receives messages is called the hardcopy medium. The group of messages that is recorded is called the hardcopy message set.

The hardcopy message set is defined at system initialization and persists for the life of the system. See *z/OS MVS Planning: Operations* for the characteristics of the hardcopy message set.

The hardcopy message set

Unless you specify otherwise, the hardcopy message set includes all messages, except those that are explicitly omitted through the WTO macro or installation exits. You can request that the hardcopy message set not include messages with certain routing codes. The minimum set of routing codes is 1, 2, 3, 4, 7, 8, 10, and 42. If you attempt to eliminate any of these, the system includes messages with these routing codes in the hardcopy message set anyway.

To see information about the kinds of messages that the system includes in the hardcopy message set, but does not send to any console, issue the DISPLAY CONSOLES,HC command.

Selecting messages for the hardcopy message set: You control which messages are included in the hardcopy message set by:

- **Using the VARY command:**

Use the VARY ,HARDCPY command to specify the routing codes of messages that are included in the hardcopy message set. You can add to the existing set (AROUT operand), subtract from the existing set (DROUT), or redefine the set (ROUT).

Example:

To stop including all routing codes except the minimum set, enter:

```
VARY ,HARDCPY,DROUT=(5,6,9,11-41,43-128)
```

The system would give the same response if you entered the VARY ,HARDCPY,ROUT=NONE command.

The effect of this command lasts only for the duration of the IPL.

Selecting commands and command responses for the hardcopy message set:

Unless you specify otherwise, the system includes all operator and system commands, responses, and status displays in the hardcopy message set. To request that some commands and command responses not be included in the hardcopy message set, the system gives you the following choices on the VARY ,HARDCPY command:

NOCMDS

The system does not include operator commands or their responses in the hardcopy message set.

INCMDS

The system includes all operator commands and their responses, excluding any status displays, in the hardcopy message set.

STCMDS or CMDS

The system includes all operator and system commands, their responses, and status displays in the hardcopy message set. As of z/OS V1R8, STCMDS and CMDS are equivalent.

To see which commands and command responses the system includes in the hardcopy message set, issue the DISPLAY CONSOLES command. Figure 19 on page 124 shows the display that appears in response to this command.

Note:

You control which commands and command responses are included in the hardcopy message set by:

- **Using the VARY command:**

Use the VARY ,HARDCPY command to change the commands or the command responses that are included in the hardcopy message set.

Example:

To request that the hardcopy message set include all operator commands and responses except status displays, enter:

```
VARY ,HARDCPY,INCMDS
```

The effect of this command lasts only for the duration of the IPL.

The hardcopy medium

You can specify whether the hardcopy medium is the system log (SYSLOG) or the operations log (OPERLOG). If you use SYSLOG as the hardcopy medium, start a writer that includes the system log message class (A for MVS, unless otherwise

specified in your installation). The SYSLOG spool file is managed by JES and can be viewed using the spool display and search facility (SDSF). The external writer will write it to an SMF-managed file.

The system log: The system log (SYSLOG) is a direct access data set that stores messages and commands. It resides in the primary job entry subsystem's spool space. It can be used by application and system programmers (through the WTL macro) to record communications about programs and system functions. You can use the LOG command to add an entry to the system log.

Several kinds of information can appear in the system log:

- Job time, step time, and data from the JOB and EXEC statements of completed jobs entered by user-written routines
- Operating data entered by programs using a write to log (WTL) macro instruction
- Descriptions of unusual events that you enter using the LOG command
- The hardcopy message set

When MVS has JES3 as its job entry subsystem, the system log can record console activity. If used to record console activity, the system log is referred to in JES3 messages as DLOG.

In CONSOLxx, you can use the HCFORMAT keyword on the HARDCOPY statement to specify whether hardcopy records should have a 2-digit or 4-digit year.

The system log is queued for printing when the number of messages recorded reaches a threshold specified at system initialization. You can force the system log data set to be queued for printing before the threshold is reached by issuing the WRITELOG command.

If the system log is defined as the only hardcopy medium and SYSLOG fails, hardcopy is suspended and the system issues message CNZ4201E. To avoid the loss of hardcopy, IBM recommends both SYSLOG and OPERLOG be defined as hardcopy.

The operations log: The operations log (OPERLOG) is an MVS system logger application that records and merges the hardcopy message set from each system in a sysplex that activates OPERLOG. Use OPERLOG as your hardcopy medium when you need a permanent log about operating conditions and maintenance for all systems in a sysplex.

For more information on OPERLOG, see *z/OS MVS Setting Up a Sysplex*.

Assigning the hardcopy medium: Assign the hardcopy medium by using the VARY command.

Use the HARDCPY operand on the VARY command to assign SYSLOG or OPERLOG as the hardcopy medium. You can assign both SYSLOG and OPERLOG as the hardcopy medium by issuing the command separately.

Example:

To specify the hardcopy medium as SYSLOG, issue:
VARY SYSLOG,HARDCPY

The effect of this command lasts only for the duration of the IPL.

To display information about the hardcopy medium, enter:

```
DISPLAY CONSOLES,HARDCOPY
```

The resulting display tells you the following information:

- Whether the hardcopy medium is SYSLOG, OPERLOG, or both
- The criteria that have been defined by the installation for selecting messages for the hardcopy message set
- The number of messages waiting to be placed on the hardcopy medium

Chapter 4. MVS system commands reference

This topic describes the functions, syntax, and parameters of all the MVS base control program (BCP) system commands. You can use these commands to control both the system itself and multiple console support (MCS), HMC multiple console support (HMCS) or SNA multiple console support (SMCS) consoles.

Table 13 on page 154 summarizes the MVS BCP system commands and their functions. The table shows the operator command groups for each command and tells whether you can enter the command from the job stream, an MCS, HMCS or SMCS console, or an extended MCS console session. An extended MCS console session is established either by the TSO/E CONSOLE command as an interactive TSO/E session or by a program issuing the MCSOPER macro so the program can receive messages and issue commands. See *z/OS TSO/E System Programming Command Reference* for information about the TSO/E CONSOLE command. See *z/OS MVS Programming: Authorized Assembler Services Reference LLA-SDU* for information about the MCSOPER macro.

An installation can use RACF to control which consoles and commands operators can use. For more information, see *z/OS MVS Planning: Operations*.

Operator commands may contain the following characters:

- A to Z
- 0 to 9
- ' # \$ & () * + , - . / ¢ < | ! ; ~ % _ > ? : @ " =

The system translates characters that are not valid into null characters (X'00').

You can enter operator commands in uppercase or lowercase. Unless enclosed in apostrophes, lowercase letters are converted to uppercase. Therefore, when a lowercase response is required, you must enclose the text in apostrophes. Also, when an apostrophe appears in the text of a command and the text is enclosed in apostrophes, you must enter two apostrophes in the text. For example, you would enter:

```
SEND 'Your job''s done'
```

You can enter system commands through a multiple console support (MCS) console, HMC multiple console support (HMCS) console, SNA multiple console support (SMCS) console, extended MCS (EMCS) console or through the input stream (submitted JCL). Table 13 on page 154 indicates from which types of consoles a command is accepted. Superscripts denote footnotes that can be found at the end of the table. All examples show the format for MCS, HMCS and SMCS console entry.

Note:

1. If you enter a system command through a submitted JCL in a JES2 system, enter \$VS,'system command' when you enter the command between jobs, and enter //b system command when you enter the command within a job.
2. Do not use the JES backspace character within a system command.

Following Table 13 on page 154 is a topic on command syntax and format. The syntax rules are shown in "How to read syntax conventions" on page 167.

MVS system commands reference

The rest of this topic consists of a description of each command in more detail. The descriptions are in alphabetical order by command name. Each description lists the functions that the command performs followed by the command's syntax and parameters. The syntax and parameters of complex commands follow subsets of the listed functions. Descriptions of the parameters and keywords appear in the order in which they appear in the syntax.

Table 13. System command summary

Command (abbreviation)	Function	Acceptable from	Command group
ACTIVATE	Build the interface to and invoke the hardware configuration definition (HCD) application program interface.	MCS, HMCS, SMCS or extended MCS console ²	SYS
CANCEL (C)	Cancel a MOUNT command Cancel a time-sharing user Cancel a cataloged procedure Cancel a job in execution Cancel a started catalog procedure Cancel an external writer allocation Cancel the writing of a SYSOUT data set by an external writer session Cancel a running APPC/MVS transaction program Cancel a z/OS UNIX System Services process	MCS, HMCS, SMCS or extended MCS consoles or job stream ²	SYS
CHNGDUMP (CD)	Override dump options specified in parmlib, on the ABEND, CALLRTM, and SETRP macros, and in the SDUMP parameter list	MCS, HMCS, SMCS or extended MCS consoles or job stream ²	SYS
CMDS	DISPLAY or SHOW information about commands that are executing or waiting for execution ABEND, FORCE or REMOVE executing commands or commands waiting for execution DUMP the address space where commands typically run (Master and Console)	MCS, HMCS, SMCS or extended MCS consoles or job stream ²	INFO MASTER
CONFIG (CF)	Place processors online or offline Place central storage elements online or offline Place amounts of central storage online or offline Place ranges of central storage online or offline Place channel paths online or offline Place Vector Facilities online or offline	MCS, HMCS, SMCS or extended MCS consoles ²	MASTER

Table 13. System command summary (continued)

Command (abbreviation)	Function	Acceptable from	Command group
CONTROL (K)	Change display area specifications	MCS, HMCS and SMCS consoles	INFO
	Delete certain messages		INFO
	Halt printing of a status display		INFO
	Control area displays		INFO
	Remove information from the screens		INFO
	Activate, deactivate, or display the status of the action message retention facility		MASTER
	Change or display the number of allowed message and reply buffers		MASTER
	Change or display message deletion or format specifications		INFO
	Change or display the status of WTO user exit IEAVMXIT		MASTER
	Define commands for PFKs		INFO or MASTER
	Purge message queue of a console.		INFO or MASTER
	Change operating mode of console		INFO
	Select the message levels for a console		INFO
Increase the RMAX value	INFO		
In a sysplex, change the maximum time MVS waits before aggregating messages from routed commands	MASTER		
DEVSERV (DS)	Display current status of devices and corresponding channel paths	MCS, HMCS, SMCS or extended MCS consoles or job stream ²	INFO

MVS system commands reference

Table 13. System command summary (continued)

Command (abbreviation)	Function	Acceptable from	Command group
DISPLAY (D)	<p>Display information about MVS device allocation group locks</p> <p>Display information about MVS device allocation settings</p> <p>Display IDGE device allocation information</p> <p>Display APPC/MVS configuration information</p> <p>Display ASCH configuration information</p> <p>Display auxiliary storage information</p> <p>Display information about the current auto-reply policy and the WTORs being monitored by auto-reply processing</p> <p>Display the current system level Language Environment® run-time options</p> <p>Display CONTROL command functions</p> <p>Display storage and attachment information about coupling facilities</p> <p>Display console configuration information</p> <p>Display system information requests</p> <p>Display the current options that have been set with DIAGxx</p> <p>Displaying data lookaside facility (DLF) information</p> <p>Display the status or contents of SYS1.DUMP data sets, captured data sets, and dump options in effect</p> <p>Display extended MCS information</p> <p>Display status of external time reference (ETR) ports</p> <p>Display information about Global resource serialization. Including configuration and usage information, as well as ENQ and Latch contention and dependency analysis</p> <p>Display Generic Tracker information</p> <p>Display status of hardware instrumentation services (HIS)</p> <p>Display status of HyperSwap® function and device pairs in the PPRC configuration</p> <p>Display ICSF information</p> <p>Display the data set optimization configuration</p> <p>Display TSO/E parmlib information</p> <p>Display IOS configuration</p> <p>Display captured UCB information</p> <p>Display encryption key manager (EKM) status</p>	MCS, HMCS, SMCS or extended MCS consoles or job stream ²	INFO

Table 13. System command summary (continued)

Command (abbreviation)	Function	Acceptable from	Command group
DISPLAY (D) (continued)	<p>Display zHPF facility status</p> <p>Display FICON switch data information</p> <p>Display the IBM zHyperWrite data replication status</p> <p>Display MIDAW facility status</p> <p>Display current MIH time intervals for individual devices, or for device classes</p> <p>Display current system status</p> <p>Display information about started tasks</p> <p>Display information about LLA</p> <p>Display information about system logger and log stream resources</p> <p>Display the current logrec error recording medium</p> <p>Display configuration information</p> <p>Display information about message flood automation</p> <p>Display MVS message service and current available languages</p> <p>Display the messages MPF is processing and color, intensity, and highlighting display options in effect</p> <p>Display z/OS UNIX System Services information</p> <p>Display information about operation information (OPDATA) in a sysplex, or display the settings made by the SETCON MONITOR command</p> <p>Display PCIE information</p> <p>Display parmlib information</p> <p>Display commands defined for PFKs</p> <p>Displays the contents of the Program Properties Table (PPT)</p> <p>Display information about registered products and the product enablement policy</p> <p>Display entries in the list of APF-authorized program libraries</p> <p>Display PROG defaults</p> <p>Display dynamic exits</p> <p>Display information about the LNKLST set</p> <p>Display information about modules dynamically added to the LPA</p>	MCS, HMCS, SMCS or extended MCS consoles or job stream ²	INFO

MVS system commands reference

Table 13. System command summary (continued)

Command (abbreviation)	Function	Acceptable from	Command group
DISPLAY (D) (continued)	<p>Display the status of the REFRPROT option</p> <p>Display the status of the TRACKDIRLOAD option</p> <p>Display system requests and status of the AMRF</p> <p>Display status information about RRS coordinated transactions</p> <p>Display SLIP trap information</p> <p>Display SMF options in effect or SMF data sets</p> <p>Display the in-storage copy of the SMF limits</p> <p>Display information about the SMS configuration or the status of SMS volumes or storage groups or SMS trace options</p> <p>Display information about all subsystems defined to MVS</p> <p>Display the current static system symbols</p> <p>Display local and Greenwich mean time and date</p> <p>Display information about component or transaction trace status</p> <p>Display device status and allocation</p> <p>Display Unicode services</p> <p>Display virtual storage information</p> <p>Display the status of the active workload management service policy for systems or application environments</p> <p>Display information about the cross system coupling facility (XCF)</p>	MCS, HMCS, SMCS or extended MCS consoles or job stream ²	INFO
DUMP	Request a dump of virtual storage to be stored in a SYS1.DUMP data set	MCS, HMCS, SMCS or extended MCS console ²	MASTER
DUMPDS (DD)	<p>Change the system's list of SYS1.DUMP data sets</p> <p>Clear full SYS1.DUMP data sets and make them available for dumps</p>	MCS, HMCS, SMCS or extended MCS console ²	SYS
FORCE	<p>Force termination of:</p> <ul style="list-style-type: none"> • A MOUNT command • A job in execution • An external writer allocation • The writing of a SYSOUT data set by an external writer • A non-cancellable job, time-sharing user, or started task • A running APPC/MVS transaction program • Or a task within one of the above 	MCS, HMCS, SMCS or extended MCS console ²	MASTER

Table 13. System command summary (continued)

Command (abbreviation)	Function	Acceptable from	Command group
HALT (Z)	Record statistics before stopping the system (Must first stop subsystem processing with a subsystem command)	MCS, HMCS, SMCS or extended MCS console ²	SYS
IOACTION (IO)	Stop or resume I/O activity to DASD	MCS, HMCS, SMCS or extended MCS console ²	MASTER
LIBRARY (LI)	Eject a volume from a library of removable storage media. Reactivate processing for certain installation exits without stopping or restarting the object access method (OAM). Set or display the media type of scratch volumes that the system places into the cartridge loader of a device within a tape library. Display tape drive status.	MCS, HMCS and SMCS consoles	SYS
LOG (L)	Enter comments in the system log	MCS, HMCS, SMCS or extended MCS consoles or job stream ²	INFO
LOGOFF	To log off MCS, HMCS and SMCS consoles	MCS, HMCS and SMCS consoles	INFO
LOGON	To access the MCS, HMCS and SMCS consoles	MCS, HMCS and SMCS console	INFO
MODE	Control recording of or suppress system recovery and degradation machine check interruptions on the logrec data set Control the monitoring of hard machine check interruptions	MCS, HMCS, SMCS or extended MCS console ²	SYS

MVS system commands reference

Table 13. System command summary (continued)

Command (abbreviation)	Function	Acceptable from	Command group
MODIFY (F)	<p>Change characteristics of a job by modifying the job parameters</p> <p>Specify criteria an external writer uses to select data sets for processing</p> <p>Cause an external writer to pause for operator intervention</p> <p>Manage the data collection in hardware instrumentation services (HIS)</p> <p>Build a new LLA directory</p> <p>Display information about the catalog address space or request the catalog address space to perform a specified service.</p> <p>Modify TSO/VTAM time-sharing Rebuild a new LNKLST directory</p> <p>Display the status of the DLF, or change DLF parameters or processing mode</p>	MCS, HMCS, SMCS or extended MCS consoles or job stream ²	SYS
MONITOR (MN)	<p>Continuously display data set status</p> <p>Continuously display job status</p> <p>Monitor time-sharing users logging on and off the system</p>	MCS, HMCS, SMCS or extended MCS consoles or job stream ²	INFO
MOUNT (M)	Mount volumes	MCS, HMCS, SMCS or extended MCS consoles or job stream ²	I/O
PAGEADD (PA)	<p>Add local page data sets</p> <p>Specify data sets as non-VIO page data sets</p>	MCS, HMCS, SMCS or extended MCS console ²	SYS
PAGEDEL (PD)	<p>Delete, replace, or drain a local page data set</p> <p>(PLPA, common page data sets, and the last local page data set cannot be deleted, replaced or drained)</p>	MCS, HMCS, SMCS or extended MCS console ²	SYS
QUIESCE	Put system in MANUAL state without affecting step timing.	MCS, HMCS, SMCS or extended MCS console ²	MASTER

Table 13. System command summary (continued)

Command (abbreviation)	Function	Acceptable from	Command group
REPLY (R)	<p>Reply to system information requests.</p> <p>Reply to system requests during recovery processing.</p> <p>Specify component trace options after issuing TRACE CT.</p> <p>Specify system parameters.</p> <p>Set the time-of-day clock.</p> <p>Specify SMF options.</p> <p>Specify DUMP options.</p>	MCS, HMCS, SMCS or extended MCS consoles or job stream ²	INFO
RESET (E)	<p>Assign work to a new workload management service class. Also, quiesce and resume executing work.</p> <p>Force a hung console device offline.</p>	MCS, HMCS, SMCS or extended MCS consoles or job stream ²	SYS MASTER
ROUTE (RO)	<p>Direct a command to another system, to all systems, or to a subset of systems in the sysplex.</p>	MCS, HMCS, SMCS or extended MCS consoles or job stream ²	INFO
SEND (SE)	<p>Communicate with other operators.</p> <p>Communicate with specific time-sharing users.</p> <p>Communicate with all time-sharing users.</p> <p>Save messages in the broadcast data set for issuance at TSO LOGON time or when requested.</p> <p>List messages accumulated in the notices section of the broadcast data set.</p> <p>Delete a message from the notices section of the broadcast data set.</p>	MCS, HMCS, SMCS or extended MCS consoles or job stream ²	INFO

MVS system commands reference

Table 13. System command summary (continued)

Command (abbreviation)	Function	Acceptable from	Command group
SET (T)	<p>Add modules to, or delete modules from, the LPA dynamically.</p> <p>Change:</p> <ul style="list-style-type: none"> • the local time and date • the system resources manager (SRM) parameters • the MPF parameters • the dump analysis and elimination (DAE) parameters • SLIP processing by changing the active IEASLPxx parmlib member • SMS parameters by selecting member IGDSMSxx in , start SMS if not started at IPL, or restart SMS if it cannot be restarted automatically • available PFK tables • MIH time intervals by changing the active IECSIOSxx parmlib member • excessive spin-loop timeout interval recovery actions • RNLs by selecting new GRSRNLxx parmlib members • the APPC/MVS address space information • the APPC/MVS transaction scheduler information • the PPT information • the active console group definitions in the sysplex • the MMS parameters • the command installation exits the system is to use • the product enablement policy the system is to use • the Generic Tracker parameters (GTZ). <p>Restart SMF or change SMF parameters by changing the active SMFPRMxx parmlib member.</p> <p>Start or stop the common storage and tracking functions.</p> <p>Start, refresh, or stop MMS.</p> <p>Update:</p> <ul style="list-style-type: none"> • the APF list and dynamic exits • the format or contents of the APF list • the LNKLKST set for LNKLST concatenation • the system logger (IXGLOGR) address space information by changing the active IXGCNFxx parmlib member. <p>Specify the MSGFLDxx parmlib member for the system to use.</p>	MCS, HMCS, SMCS or extended MCS consoles or job stream ²	SYS
	<p>Activate auto-reply processing on a system by specifying the AUTORxx parmlib member that the system is to use.</p> <p>Add additional MCS console definitions without an IPL.</p>		
SETALLOC	Modify a Device Allocation parameter that was set at IPL by an ALLOCxx parmlib member or after IPL by a previous SETALLOC command.	MCS, HMCS, SMCS or extended MCS console ²	SYS

Table 13. System command summary (continued)

Command (abbreviation)	Function	Acceptable from	Command group
SETAPPC	Dynamically define or modify the APPC/MVS configuration.	MCS, HMCS, SMCS or extended MCS console ²	SYS
SETAUTOR	Deactivate auto-reply processing on a system or have auto-reply stop monitoring an outstanding WTOR.	MCS, HMCS, SMCS or extended MCS console ²	SYS
SETCEE	Override system-level Language Environment options.	MCS, HMCS, SMCS or extended MCS console ²	SYS
SETCON	Set console services mode of operations, control enablement of monitor messages and delete extraneous consoles.	MCS, HMCS, SMCS or extended MCS console ²	MASTER
SETETR	Enable external time reference (ETR) ports that have been disabled	MCS, HMCS, SMCS or extended MCS console ²	SYS
SETGRS	<ul style="list-style-type: none"> • Migrate a currently active global resource serialization ring complex to a global resource serialization star complex • Modify the current RESMIL or TOLINT values • Set the system values for <ul style="list-style-type: none"> – GRSQ – SYNCHRES – ENQMAXA – ENQMAXU • Change the contention notifying system (CNS) in a global resource serialization complex 	MCS, HMCS, SMCS or extended MCS console ²	MASTER
SETGTZ	Control the Generic Tracker	MCS, HMCS, SMCS or extended MCS console ²	SYS
SETHS	Manage HyperSwap.	MCS, HMCS, SMCS or extended MCS console ²	I/O
SETIOS	Respecify, add, or delete MIH time intervals, update DCM, enable/disable FICON statistics, and enable/disable the MIDAW facility, all without changing the active IECIOSxx parmlib member	MCS, HMCS, SMCS or extended MCS console ²	SYS
SETLOAD	Switch dynamically from one parmlib concatenation to another without having to initiate an IPL, or dynamically update the system symbols on your local system without an IPL.	MCS, HMCS, SMCS or extended MCS console ²	SYS
SETLOGR	Take action on system logger log stream resources.	MCS, HMCS, SMCS or extended MVS console ²	MASTER

MVS system commands reference

Table 13. System command summary (continued)

Command (abbreviation)	Function	Acceptable from	Command group
SETLOGRC	Change the logrec recording medium.	MCS, HMCS, SMCS or extended MCS console ²	MASTER
SETMF	Change the message flood automation state or parameters.	MCS, HMCS, SMCS or extended MCS console ²	SYS
SETOMVS	Change the options that z/OS UNIX System Services uses.	MCS, HMCS, SMCS or extended MCS console ²	SYS
SETPROG	Update APF list Update dynamic exits Update the LNKLST set Dynamically add modules to, or delete modules from, the LPA.	MCS, HMCS, SMCS or extended MCS console ²	SYS
SETRRS	Control RRS processing: <ul style="list-style-type: none"> SETRRS ARCHIVELOGGING will disable or enable archive logging on a given system SETRRS CANCEL will end RRS processing SETRRS SHUTDOWN will end RRS without resulting in a X'058' abend 	MCS, HMCS, SMCS or extended MCS console ²	SYS
SETSMF (SS)	Change SMF parameters without changing the active SMFPRMxx parmlib member	MCS, HMCS, SMCS or extended MCS consoles or job stream ²	SYS
SETSMS	Change SMS parameters without changing the active IGDSMSxx parmlib member	MCS, HMCS, SMCS or extended MCS console ²	SYS
SETSSI	Dynamically add, activate or deactivate a subsystem.	MCS, HMCS, SMCS or extended MCS console ²	MASTER
SETUNI	Control the Unicode environment.	MCS, HMCS, SMCS or extended MCS console. ²	SYS
SETXCF	Control the cross-system coupling facility (XCF)	MCS, HMCS, SMCS or extended MCS console ²	MASTER
SLIP (SL)	Set SLIP traps Modify SLIP traps Delete SLIP traps	MCS, HMCS, SMCS or extended MCS consoles or job stream ²	SYS

Table 13. System command summary (continued)

Command (abbreviation)	Function	Acceptable from	Command group
START (S)	<p>Start a job from a console</p> <p>Start the advanced program-to-program communication (APPC/MVS) address space</p> <p>Start the APPC/MVS scheduler (ASCH) address space</p> <p>Start the data facility storage management subsystem (DFSMS/MVS) license compliance facility</p> <p>Start the generalized trace facility (GTF)</p> <p>Start hardware instrumentation services (HIS)</p> <p>Start the library lookaside (LLA) address space</p> <p>Start the object access method (OAM)</p> <p>Start resource recovery services (RRS)</p> <p>Start the system object model (SOM)</p> <p>Start TSO/VTAM time-sharing</p> <p>Start the virtual lookaside facility (VLF) or the data lookaside facility (DLF)</p> <p>Start an external writer</p>	MCS, HMCS, SMCS or extended MCS consoles or job stream ²	SYS
STOP (P)	<p>Stop a job in execution</p> <p>Stop an address space</p> <p>Stop an ASCH initiator</p> <p>Stop an initiator</p> <p>Stop the data lookaside facility (DLF)</p> <p>Stop the generalized trace facility (GTF)</p> <p>Stop hardware instrumentation services (HIS)</p> <p>Stop the library lookaside (LLA) address space</p> <p>Stop the object access method (OAM)</p> <p>Stop the system object model (SOM)</p> <p>Stop TSO/VTAM time-sharing</p> <p>Stop the virtual lookaside facility (VLF)</p> <p>Stop an external writer</p>	MCS, HMCS, SMCS or extended MCS consoles or job stream ²	SYS
STOPMN (PM)	<p>Stop continual display of data set status</p> <p>Stop continual display of job status</p> <p>Stop monitoring the activity of time-sharing users.</p>	MCS, HMCS, SMCS or extended MCS consoles or job stream ²	INFO

MVS system commands reference

Table 13. System command summary (continued)

Command (abbreviation)	Function	Acceptable from	Command group
SWAP (G)	Move a volume from one device to another	MCS, HMCS, SMCS or extended MCS consoles ²	I/O
SWITCH (I)	Manually switch recording of SMF data from one data set to another	MCS, HMCS, SMCS or extended MCS console ²	SYS
TRACE	Start, stop, or modify system trace Start, stop, or modify master trace Start, stop, or modify component trace Display the status of system trace, master trace, or component trace	MCS, HMCS, SMCS or extended MCS console ²	SYS MASTER MASTER SYS
UNLOAD (U)	Remove a volume from system use	MCS, HMCS, SMCS or extended MCS consoles or job stream ²	I/O
VARY (V)	Control the hardcopy message set and the hardcopy medium. Change the status of a console Change the SMS status of a storage group or volume for one or more MVS systems in the SMS complex Place I/O devices online or offline Assign and control consoles Place I/O paths online or offline Remove a system from a sysplex Place I/O paths online after C.U.I.R service Change a system's participation in a global resource serialization complex Change routing codes for a console Activate a workload management service policy for a sysplex Control an application environment Process devices or a path to devices attached to a control unit	MCS, HMCS, SMCS or extended MCS consoles or job stream	MASTER, I/O, or CONS ¹
WRITELOG (W)	Schedule printing of system log Change system log output class Close the system log and discontinue the log function Restart system log after closing	MCS, HMCS, SMCS or extended MCS consoles or job stream ²	SYS

Table 13. System command summary (continued)

Command (abbreviation)	Function	Acceptable from	Command group
Note:			
1. This command is in a different command authority group depending on the parameters specified on the command. See Table 10 on page 125 for more information.			
2. An extended MCS console can be either an interactive TSO/E session or a program that issues the MCSOPER macro.			

Command syntax notation

You must follow certain syntactical rules when you code the MVS commands described in this chapter. Use “How to read syntax conventions” to help you with the syntax.

How to read syntax conventions

This topic describes how to read syntax conventions. It defines syntax notations and provides syntax examples that contain these items.

Note: When running a command, specify command parameters in the order in which they are shown in the command syntax diagram.

Table 14. Syntax conventions

Notation	Meaning	Syntax example	Sample entry
Apostrophes	Apostrophes indicate a parameter string and must be entered as shown.	SEND 'message',NOW	SEND 'listings ready',NOW
Comma	Commas must be entered as shown.	DISPLAY C,K	DISPLAY C,K
Ellipsis ...	Ellipsis indicates that the preceding item or group of items can be repeated one or more times. Do not enter the ellipsis.	VARY (devspec[,devspec]...),ONLINE	VARY (282,283,287),ONLINE
Parentheses and special characters	Parentheses and special characters must be entered as shown.	DUMP COMM=(text)	DUMP COMM=(PAYROLL)
Underline	Underline indicates a default option. If you select an underlined alternative, you do not have to specify it when you enter the command.	K M[,AMRF={Y N}] , <u>REF</u>	K M
Lowercase parameter	Lowercase indicates a variable term. Substitute your own value for the item.	MOUNT devnum	MOUNT A30 or mount a30
Uppercase parameter	Uppercase indicates the item must be entered using the characters shown. Enter the item in either upper or lowercase.	DISPLAY SMF	DISPLAY SMF or display smf

Command syntax notation

Table 14. Syntax conventions (continued)

Notation	Meaning	Syntax example	Sample entry
Single brackets	Single brackets represent single or group-related items that are optional. Enter one or none of these items.	DISPLAY SLIP[=xxxx]	DISPLAY SLIP=W292
Stacked brackets	Stacked brackets represent group-related items that are optional. Enter one or none of these items.	[TERMINAL] [NOTERMINAL]	NOTERMINAL
Single braces	Single braces represent group-related items that are alternatives. You must enter one of the items. You cannot enter more than one.	{COMCHECK COMK}	COMK
Stacked braces	Stacked braces represent group related items that are alternatives. You must enter one of the items. You cannot enter more than one.	MN {DSNAME} {SPACE} {STATUS}	MN SPACE
Or-bar ()	An or-bar indicates a mutually exclusive choice. When used with brackets, enter one or none of the items. When used with braces, you must enter one of the items.	ACTIVATE RECOVER=SOURCE TARGET	ACTIVATE RECOVER=SOURCE
Stacked items with or-bars () and brackets	Stacked items with or-bars indicates a mutually-exclusive choice. Enter one or none of these items.	CD RESET [,SDUMP ,SYSABEND ,SYSUDUMP ,SYSMDUMP ,ALL]	CD RESET,SYSUDUMP

System command formats

Two system command formats are defined.

Typical format

Most system commands can use the format shown in Figure 21.

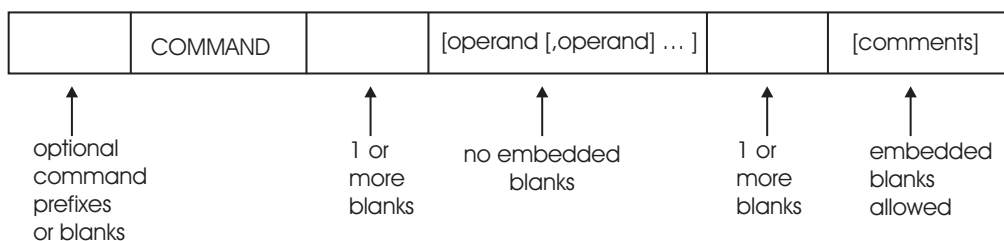

Figure 21. Typical system command format

The following command format is depicted in Figure 21 on page 168:

1. Optional command prefixes or blanks
2. Command
3. One or more blanks
4. Optional operands with no embedded blanks: *[operand[,operand]...]*
5. One or more blanks
6. Optional comments with optional embedded blanks: *[comments]*

The following restrictions apply to commands using this format:

1. Enter only one command per line. Use a maximum of 126 characters from a console, or 80 characters through a submitted JCL.
2. To include a comment on a command when you have specified no operands, insert the following after the command: a blank, then a comma, then another blank, and then the comment. The comment may contain embedded blanks.

A second format

Figure 22 shows a format required by some system commands including DISPLAY PROD, DISPLAY PROG, and SETPROG.

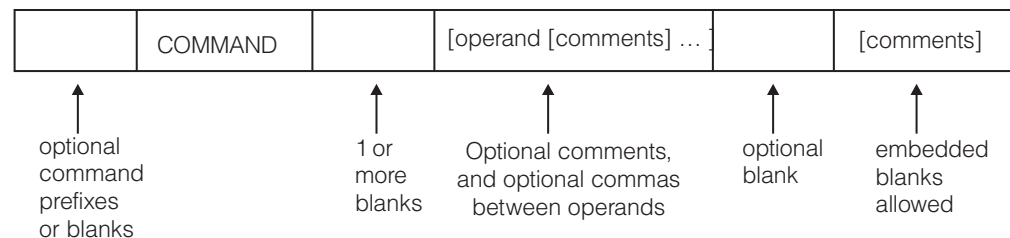

Figure 22. System command format required for some commands

The following command format is depicted in Figure 22:

1. Optional command prefixes or blanks
2. Command
3. One or more blanks
4. Optional comments, and optional commas between operands:
[operand[comments]...]
5. One optional blank
6. Optional comments with optional embedded blanks: *[comments]*

This second format provides the opportunity to include a comment after the command and each operand within the command. These restrictions apply:

1. You may, but do not have to use a comma between operands. Examples:

```
D PROG APF
D PROG,APF
```
2. This format requires that each comment be contained between a slash-asterisk and asterisk-slash pair. Comments may contain embedded blanks. Examples:

```
D PROG APF /* comments */
D PROG /*comment */ APF /* comment */
```

ACTIVATE command

Use the ACTIVATE command to activate or test a new I/O configuration definition dynamically.

Restrictions

For a list of restrictions on the ACTIVATE command, see *z/OS HCD Planning*.

Attention: An ACTIVATE command may still be active as a task in IOSAS after the command task has been abended with a CMDS ABEND.

Syntax

The complete syntax for the ACTIVATE command is:

```
ACTIVATE { [,IODF=xx] [,EDT=xx] [,PROC=procname] [,CFID=id] [,ACTIOCD=xx] }
          |,RECOVER={SOURCE|TARGET}

          { [ ,SOFT[=VALIDATE|=NOVALIDATE] ]           }
          |,TEST
          |,FORCE
          |,FORCE={DEVICE           }
                  {CANDIDATE       }
                  {(DEVICE,CANDIDATE)}
                  {(CANDIDATE,DEVICE)}
```

Note: Do not specify a comma before the first parameter following ACTIVATE.

Parameters

IODF=xx

Specifies the two-character suffix of the target IODF data set name (IODFxx) that contains the configuration definition the system is to activate. When this keyword is omitted, the system defaults to the active IODF data set name.

EDT=xx

Specifies the eligible devices table (EDT) that the system is to construct from the target IODF. If you omit this keyword, the system uses the active EDT identifier.

PROC=procname

Indicates the eight-byte name of the processor definition in the target IODF. If you omit this keyword, the system will use the active processor name.

CFID=id

Specifies the eight-byte configuration identifier that indicates the operating system definition in the target IODF. If you omit this keyword, the system defaults the configuration identifier as follows:

- When the target IODF has only one configuration identifier, it becomes the default, otherwise, the current configuration identifier is the default.

RECOVER=

Allows the installation to continue a dynamic change that did not complete due to a hardware, software, or PR/SM failure. RECOVER cannot be specified with any other parameters. You can specify:

- SOURCE to retry the original I/O configuration
- TARGET to retry the new I/O configuration

- default:
 - Retry TARGET IODF if ACTIVATE failed during advance
 - Retry SOURCE IODF if ACTIVATE failed while backing out.

ACTIOCDs=xx

Specifies the two-character IOCDS name that the system is to activate. Upon successful completion of the ACTIVATE command, the default IOCDS for the next power-on-reset will be *xx*. It does not make the I/O configuration definition stored in the IOCDS the active one.

For the IOCDS activate process to be successful, the processor token in the target IOCDS must match the current processor token in the Hardware System Area (HSA). This means that the IOCDS that is being activated has an I/O configuration definition that matches the I/O configuration currently active in the channel subsystem.

When you specify ACTIOCDs, you cannot specify TEST.

SOFT

Specifies a dynamic change to the software I/O configuration, which updates the I/O configuration only to the operating system. To change a software and hardware I/O configuration dynamically, omit the SOFT keyword.

When you specify SOFT, you cannot specify FORCE.

When you specify SOFT without any parameters, it is the same as specifying SOFT=VALIDATE.

=VALIDATE or =NOVALIDATE

Allows you to specify whether or not the system is to validate that any specified hardware elements to be deleted are offline and available, and that there is sufficient HSA space available to accommodate the hardware changes.

When a dynamic change is made to the I/O configuration for a processor complex running in LPAR mode, a change to the software I/O configuration is performed for the first N-1 logical partitions, followed by a hardware and software change for the Nth logical partition. By specifying the SOFT keyword (or SOFT=VALIDATE) when changing the I/O configuration on the N-1 logical partitions, you can determine early on whether there will be sufficient HSA space available for the subsequent software and hardware I/O configuration changes on the Nth logical partition.

Specifying SOFT=VALIDATE also ensures that the required processing for changes to coupling facility elements (CF control units or CF channel paths) will be executed. SOFT=VALIDATE is a requirement in all N-1 partitions when you make changes to coupling facility elements.

TEST

Specifies test mode to check, but not to change, the configuration. The system checks include whether:

- The dynamic change will fit into the current HSA
- The target IODF exists
- The target IODF contains the target EDT
- The target IOCDS is a valid data set
- The device support code supports devices being dynamically added or deleted
- The devices to be deleted are offline
- The paths to be deleted are offline

ACTIVATE command

- The devices and paths to be deleted are pinned

If you are performing a full dynamic activate, the system provides a list showing which channels and devices will be added, deleted, or changed during activation.

Warning

If you run the ACTIVATE command with the TEST option and the system detects no errors, there is still no guarantee that ACTIVATE will work without TEST.

Although pinned devices/paths are detected during ACTIVATE with the TEST option, some products and functions such as Geographically Dispersed Parallel Sysplex (GDPS) and z/OS Basic Hyperswap rely on signals done during real (non-TEST) activates in order to prevent deletion of those devices/paths. Therefore, activates with the TEST option may not alert you to the potential of a real activate failure that may occur due to pinned devices/paths as the messages indicating this condition will not be issued.

Devices/paths may become pinned or unpinned if a real activate request is performed at a separate time from the test activate.

When you specify TEST, you cannot specify ACTIOCDs or FORCE.

FORCE

Specify that the system makes it possible to delete hardware resources that might offset other partitions.

You must specify FORCE if your processor complex is running in LPAR mode, and you want to activate a target IODF to delete one or more I/O components. You can also specify FORCE to activate a target IODF to delete a logical partition from a device candidate list. These deletions may be explicit or implicit due to changes in the definitions for some I/O components. When you specify FORCE, you cannot specify SOFT or TEST.

If your processor complex has Enterprise Systems Connection (ESCON) Multiple Image Facility (EMIF) capability, you can specify FORCE to get the results described in Table 15.

For information about ESCON Multiple Image Facility (EMIF), see *z/OS HCD Planning*. For information about access lists and candidate lists, see *z/OS HCD User's Guide*.

Table 15. Specifying FORCE with EMIF

To do the following:	Specify FORCE as follows:
Delete no I/O components, and do either of the following: <ul style="list-style-type: none">• Delete no logical partitions from the access or candidate list of a channel path or PCIe function.• Delete one or more logical partitions from the access or candidate list of a channel path or PCIe function offline to all of those logical partitions. IBM recommends that you take the channel path or PCIe function offline before issuing the command.	Do not specify FORCE.

Table 15. Specifying FORCE with EMIF (continued)

To do the following:	Specify FORCE as follows:
Delete no I/O components, and delete one or more logical partitions from the access or candidate list of a channel path or PCIe function online to any of those logical partitions. IBM does not recommend this action.	FORCE=CANDIDATE
Delete one or more I/O components, and do either of the following: <ul style="list-style-type: none"> • Delete no logical partitions from the access or candidate list of a channel path or PCIe function. • Delete one or more logical partitions from the access or candidate list of a channel path or PCIe function offline to all of those logical partitions. IBM recommends that you take the channel path or PCIe function offline before issuing the command. 	FORCE or FORCE=DEVICE
Delete one or more I/O components, and delete one or more logical partitions from the access or candidate list of a channel path or PCIe function online to any of those logical partitions. IBM does not recommend this action.	FORCE=(DEVICE,CANDIDATE) or FORCE=(CANDIDATE,DEVICE)
Delete one or more logical partitions from the device candidate list and delete no other I/O components.	FORCE or FORCE=DEVICE

Note: Before activating the new configuration, you may have to configure offline affected channel paths or vary offline affected devices. See *z/OS HCD Planning* for details about avoiding disruptions to I/O operations during dynamic changes.

Example 1:

To ACTIVATE the A0 IOCDS, enter:

```
ACTIVATE ACTIOCDS=A0
```

Example 2:

To ACTIVATE the configuration definition COMPUT22, contained in the IODF with suffix 03, enter:

```
ACTIVATE IODF=03,CFID=COMPUT22
```

Example 3:

To perform a test ACTIVATE to processor definition PROC1001 contained in the currently active IODF, enter:

```
ACTIVATE PROC=PROC1001,TEST
```

Example 4:

To ACTIVATE an IODF with suffix 04, which deletes one or more I/O components from the I/O configuration, enter:

ACTIVATE command

```
ACTIVATE IODF=04, FORCE
or
ACTIVATE IODF=04, FORCE=DEVICE
```

CANCEL command

Use the CANCEL command to end an active job, started task, or time-sharing user immediately. The table that follows summarizes the tasks that the CANCEL command can perform. Following the table are usage notes, the complete command syntax, definition of parameters, and examples of use.

If the program that supports the job or started task was designed to recognize the STOP command, use the STOP command before using the CANCEL command. If the CANCEL command fails several times, consider using the FORCE command.

Table 16. CANCEL Command Tasks

Task - Immediately Terminate:	Syntax
<ul style="list-style-type: none">• A job in execution• A running Advanced Program-to-Program Communication/MVS (APPC/MVS) transaction program• A started task	CANCEL jobname
<ul style="list-style-type: none">• A address space identifier of the work unit you want to cancel	CANCEL ASID=asid
<ul style="list-style-type: none">• A time-sharing user	CANCEL U=userid
<ul style="list-style-type: none">• A started task• A MOUNT command• An external writer allocation• The output processing for a job• A z/OS UNIX process	CANCEL identifier

Note:

1. If your system was part of a global resource serialization ring (GRS=START, GRS=JOIN or GRS=TRYJOIN was specified at IPL) and the system is either inactive or quiesced (by entering the VARY GRS(system name), QUIESCE command), the CANCEL command might not work for jobs that own any global resources. Use DISPLAY GRS to determine GRS status.
2. If a job is running, you can end it using either the CANCEL system command or the appropriate subsystem command. However, if the job is not running, you must CANCEL the job using the subsystem command.
3. The CANCEL command issues an ABEND with either code 122 or 222 to abnormally end a job step or time-sharing user. The ABEND is asynchronous and might result in additional errors, depending on which programs were active at the time of the request. You might need to issue additional CANCEL commands to completely end the job.
4. Entering the CANCEL command during device allocation terminates the external writer as well as the unit of work. Entering this command when the external writer is processing output for a job terminates the output processing but leaves the external writer to process other data sets.
5. When you cancel a MOUNT command for a tape unit, the MOUNT command can end before the volume has been mounted. If the MOUNT command has ended and the mount request is not satisfied, issue the UNLOAD command to free the tape unit.

Syntax

The complete syntax for the CANCEL command is:

```
C {jobname          }[,DUMP][,A=asid][,ARMRESTART]
  {U=userid        }
  {[jobname.]identifier}
```

Parameters

jobname

The name of the batch job, started task, or APPC/MVS transaction program to be canceled.

The job name for a given started task can be assigned based on a variety of inputs. These inputs are examined in the following order, so that if item #1 is not specified, item #2 is used. If neither #1 nor #2 is specified, then #3 is used, and so on.

1. The jobname specified in the JOBNAME= parameter of the START command

or

The identifier specified on the START command.

2. The jobname specified on the JOB JCL statement within the member.

3. The device number specified on the START command, or the device number associated with the device type specified on the START command

or

The device number associated with the device type specified on the START command.

4. The device number associated with the IEFRDER DD statement within the member.

5. The member name.

U=userid

The user ID of the time-sharing user you want to cancel.

If the user is just logging on and does not yet have a unique name, you must find out the address space identifier for the user (see the explanation under *A=asid*) and use the following version of the command:

- CANCEL U=*LOGON*,A=*asid*

[jobname.]identifier

The identifier for the unit of work that you want to cancel, optionally preceded by the job name.

The following types of identifiers can be used:

- The identifier that was specified on the START command.
- *[/devnum]*, the device number specified when the START or MOUNT command was entered. The device number is 3 or 4 hexadecimal digits, optionally preceded by a slash (/). You can precede the device number with a slash to prevent ambiguity between the device number and a device type or identifier.
- *devicetype*, the type of device specified when the START or MOUNT command was issued.

CANCEL command

If no identifier was specified on the START command, the system assigns temporary identifier "STARTING" to the unit of work, until the system can assign an identifier according to the following order of precedence:

1. If an identifier was not specified on the START command, the identifier is the device type (for example, 3410) or device number (for example, X'0000') specified on the START or MOUNT command.
2. If an identifier, a device type, or a device number was not specified on the START or MOUNT command, the identifier is the device type specified on an IEFORDER DD statement (invoking a cataloged procedure) in the JCL.
3. If none of these was specified, the identifier defaults to the job name.

When you specify *jobname.identifier*, then *identifier* can be represented by any of the following:

- An asterisk
- One or more characters from the beginning of the identifier, followed by an asterisk
- The entire identifier

When you specify an asterisk, the system responds with message IEE422I.

Attention: When you use the asterisk format, the command affects *all* started tasks that begin with the specified characters. Device numbers are assumed to be four-digit numbers; for example, */13** would match on **1301**, **1302**, and so on, but would not match on **13C**, because **13C** is interpreted as **013C**.

Specifying both the job name and the entire identifier causes the command to take effect if **one and only one** work unit with that combination of job name and identifier is running. For the case where more than one work units with the same combination of job name and identifier are running, see the description of the *A=asid* parameter.

DUMP

A dump is to be taken. The type of dump (SYSABEND, SYSUDUMP, or SYSMDUMP) depends on the JCL for the job. A dump request is only valid when made while the job is running. Dumps are not taken during job allocation or deallocation.

Note: You can use DUMP with any of the other CANCEL parameters.

A=asid

The hexadecimal address space identifier of the work unit you want to cancel.

If more than one work unit is running with the same job name, identifier, combination of job name and identifier, or user ID that you specified on the CANCEL command, the system rejects the command because it does not know which work unit to cancel. To avoid this, you must add the parameter *A=asid* to your original CANCEL command in order to specify the address space identifier of the work unit.

Note: If the asterisk format is used, you will not be prompted for *A=asid*. Rather, all work units meeting the specified criteria will be canceled.

You can use the CANCEL operator command to cancel z/OS UNIX address spaces. Each address space is equivalent to a z/OS UNIX process.

To find out the address space identifier for a unit of work, you can use the DISPLAY command as follows:

DISPLAY JOBS,ALL

Lists the address space identifiers for all batch jobs and started tasks.

DISPLAY ASCH,ALL

Lists the address space identifiers for all APPC/MVS transaction programs.

DISPLAY TS,ALL

Lists the address space identifiers for all logged-on time-sharing users.

DISPLAY OMVS,ASID=ALL or DISPLAY OMVS,A=ALL

Lists the address space identifiers for all z/OS UNIX processes.

Note: *A=asid* can be used with any of the other CANCEL parameters *except* if you specify *jobname.identifier* with an asterisk (for example, CANCEL aor2.t1*).

ARMRESTART

Indicates that the batch job or started task should be automatically restarted after the cancel completes, if it is registered as an element of the automatic restart manager. If the job or task is not registered or if you do not specify this parameter, MVS will not automatically restart the job or task.

Example 1:

Cancel the job named EXAMPLE and take a dump.

```
c example,dump
```

Example 2:

Cancel the job named EXAMPLE. Whether you get a dump or not depends on the system routine in control when you enter the command.

```
c example
```

Example 3:

Of all jobs named EXAMPLE in the system, cancel only the one whose address space identifier is 7F.

```
c example,a=7F
```

Example 4:

Log off the system the user just logging on who has an address space identifier of 3D but does not yet have a unique user identifier.

```
c u=*logon*,a=3d
```

Example 5:

Log user A237 off the system.

```
c u=a237
```

Example 6:

Log user A237 off the system and take a dump.

```
c u=a237,dump
```

Example 7:

Cancel the MOUNT command that requests a volume to be mounted on device number 232, enter:

```
c 232
```

CANCEL command

Example 8:

Cancel the MOUNT command that requests a volume to be mounted on a 3330 device type.

```
c 3330
```

Example 9:

End the device allocation for a writer with device number 00E.

```
c 00e
```

Example 10:

End the output processing being done for device number 00E and cause another output data set to be processed.

```
c 00e
```

Example 11:

End the output processing being done for device number 3480 and cause another output data set to be processed.

```
c /3480
```

Example 12:

Of all the transaction programs running with the job name MAIL, end only the one whose address space identifier is 2C, which is the APPC/MVS scheduler (ASCH) initiator ASID.

```
C mail,a=2c
```

Example 13:

End the device allocation for a writer on device number F00E.

```
c /f00e
```

Example 14:

There are several tasks running with jobname AOR2. End all of those tasks.

```
c aor2.*
```

Example 15:

There are several tasks running with jobname AOR2. Some of those tasks have *identifiers* beginning T1. End only those specific tasks.

```
c aor2.t1*
```

Example 16:

The following example shows an operator session that cancels a process that is running the shell command **sleep 6000** for the TSO/E user CHAD.

```
DISPLAY OMVS,U=CHAD
```

```
BPX0001I 17.12.23 DISPLAY OMVS 700 C
OMVS    ACTIVE
USER    JOBNAME  ASID      PID      PPID  STATE  START  CT_SECS
BPXPRMHF
```

```

CHAD  CHAD  001D  262147      1  RI  17.00.10  1.203
CHAD  CHAD  001B  131076      5  SI  17.00.10  .111
    LATCHWAITPID=  0  CMD=sleep 6000
CHAD  CHAD  0041      5  262147  IW  17.00.10  .596
    LATCHWAITPID=  0  CMD=-sh
CHAD  CHAD3  001B  131076      5  SI  17.00.10  .111
    LATCHWAITPID=  0  CMD=sleep 6000

```

If you want to cancel only the process that is running the shell command **sleep 6000**, enter:

```
CANCEL CHAD3
```

If you want to cancel the TSO/E user CHAD altogether, enter:

```
CANCEL U=CHAD
```

CHNGDUMP command

Use the CHNGDUMP command to change the mode and system dump options list for any dump type, or to request structures to be dumped when one or more systems connected to a coupling facility fail. The dump types are SDUMP, SYSABEND, SYSUDUMP, and SYSMDUMP. If you issue multiple CHNGDUMP commands, the changes to the system dump options are cumulative. Table 17 summarizes the information that the CHNGDUMP command provides. Use it to access the pages on which you can find details about a particular use of the CHNGDUMP command.

Table 17. Summary of the CHNGDUMP Command

Command	Topic
CHNGDUMP DEL	"Removing options from or resetting the system dump options lists" on page 180
CHNGDUMP RESET	"Resetting dump mode to add and the dump options to initial values" on page 188
CHNGDUMP SET	"Setting the dump modes and options" on page 190

Dump options and modes

The system checks the dump mode and dump options each time the system or a user requests a dump. The dump mode determines whether the system accepts either a dump request or the options a dump request specifies. The starting dump mode for all four dump types is ADD.

The dump options, whether taken from a system dump options list or from a dump request, specify, for each dump type, the data areas to dump. MVS sets up system dump options lists each time you initialize the system. These lists specify the dump mode and dump options in effect for each dump type. The system finds the starting dump options lists for the SYSABEND, SYSUDUMP, and SYSMDUMP dump types in parmlib members IEAABD00, IEADMP00, and IEADMR00 respectively. Because the SDUMP dump type has no corresponding parmlib member, it starts with an empty dump options list.

Dump modes

In addition to ADD, other possible dump modes are NODUMP and OVER. The meaning of each mode is:

ADD When a dump is requested for a dump type that is in ADD mode, the system merges the options specified on the dump request with the options

CHNGDUMP command

specified in the system dump options list for that dump type. The merged options determine the data areas to dump. If an option specified on the dump request conflicts with an option in the options list, the system uses the option in the options list.

NODUMP

When a dump is requested for a dump type that is in NODUMP mode, the system ignores the request and does not take a dump.

OVER When a dump is requested for a dump type that is in OVER (override) mode, the system ignores the options specified on the dump request and uses only the options specified in the system dump options list for that dump type combined with the override options to determine the data areas to dump.

Changing the dump mode and options

You can change the dump mode or options for a dump type. Before making a change, however, issue `DISPLAY DUMP,OPTIONS` to see the current mode and options.

Changing the mode of a dump type can also affect its system dump options list as follows:

- If you change the mode for a dump type from OVER to ADD, the system adds the dump type's parmlib options to the dump type's system dump options list. The dump type's system dump options list then contains both the dump type's parmlib options *and* any options set by previous CHNGDUMP commands.
- If you change the mode for a dump type from ADD to OVER, the system removes the dump type's parmlib options from the dump type's system dump options list. The dump type's system dump options list then contains only the options set by previous CHNGDUMP commands.
- If you change the mode for a dump type to NODUMP, the system empties the dump type's system dump options list.

If you make an error entering a CHNGDUMP command, the system rejects the entire command and issues an error message.

Scope in a sysplex

The CHNGDUMP command has sysplex scope only when all systems are connected to the same coupling facilities, and you specify `,SDUMP,SYSFAIL,STRLIST=`. See "Using commands that have sysplex scope" on page 12 for an explanation of sysplex scope.

Syntax

The syntax for each variation of the CHNGDUMP command (CD DEL, CD RESET, and CD SET) is shown immediately preceding its respective parameter list.

CHNGDUMP or CD

Removing options from or resetting the system dump options lists

Use the CHNGDUMP DEL command to remove specified options from a dump options list or to reset all dump options lists to values specified at system initialization.

```

CD DEL[,SDUMP=(option[,option]...)]
      [,Q={YES|NO}]
      [,TYPE={XMEM|XMEME}]
      [,ALL]
      [,SYSFAIL,STRLIST={ALL|(STRNAME=strname[,STRNAME=strname]...)}]
[,{,SYSABEND}[,SDATA=(option[,option]...)]
[,{,SYSUDUMP} |,PDATA=(option[,option]...)]
      |,ALL
[,SYSDUMP=(option[,option]...)]
      |,ALL
[,ALL]

```

Parameters

DEL

Set the dump mode for each dump type to ADD and reset all system dump options lists to the values established during system initialization. (The system gets the initial dump options for SYSABEND, SYSUDUMP, and SYSDUMP from parmlib members IEAABD00, IEADMP00, and IEADMR00 respectively. The system empties the SDUMP dump options list.)

SDUMP

Set the dump mode for the SDUMP dump type to ADD, and empty the SDUMP system dump options list.

SDUMP,SYSFAIL,STRLIST={ALL or STRNAME=strname,...}

To delete STRNAME specifications from the dump options list. You can delete any or all structure name specifications from the dump options list. For a complete description of the keyword specifications refer to “Setting the dump modes and options” on page 190.

SDUMP=(options)

Remove the specified options from the SDUMP system dump options list. If the SDUMP dump mode is OVER, and previous CHNGDUMP commands have removed all dump options from the SDUMP dump options list, this command has no effect and leaves the SDUMP dump options list empty. See “Options for SDUMP, SYSABEND, SYSUDUMP, and SYSDUMP” on page 183 for SDUMP options you can specify.

SDUMP,Q=YES or NO

Specifies whether or not SDUMP is to quiesce the system—set it to nondispatchable (Q=YES) or leave the system dispatchable (Q=NO)—while dumping the contents of the SQA or CSA. For further information, see “Setting the dump modes and options” on page 190.

SDUMP,TYPE=XMEM

Turn off “cross memory” in the SDUMP system dump options list.

SDUMP,TYPE=XMEME

Turn off “cross memory at the time of the error” in the SDUMP system dump options list.

SDUMP,ALL

Same as DEL,SDUMP.

SYSABEND

Set the dump mode for the SYSABEND dump type to ADD, and reset the

CHNGDUMP command

SYSABEND system dump options list to the values established during system initialization. (The system gets the initial dump options for SYSABEND from the IEAABD00 parmlib member.)

SYSABEND,SDATA=(options)

Remove any of the specified SDATA options that previous CHNGDUMP commands put in the SYSABEND system dump options list. Parmlib options do not change. If the SYSABEND dump mode is OVER and previous CHNGDUMP commands have removed all SDATA and PDATA dump options from the SYSABEND dump options list, reset the list to the parmlib options. See "Options for SDUMP, SYSABEND, SYSUDUMP, and SYSMDUMP" on page 183 for SYSABEND options you can specify.

SYSABEND,PDATA=(options)

Remove any of the specified PDATA options that previous CHNGDUMP commands put in the SYSABEND system dump options list. Parmlib options do not change. If the SYSABEND dump mode is OVER and previous CHNGDUMP commands have removed all SDATA and PDATA dump options from the SYSABEND dump options list, reset the list to the parmlib options. See "Options for SDUMP, SYSABEND, SYSUDUMP, and SYSMDUMP" on page 183 for SYSABEND options you can specify.

SYSABEND,ALL

Same as DEL,SYSABEND.

SYSUDUMP

Set the dump mode for the SYSUDUMP dump type to ADD, and reset the SYSUDUMP system dump options list to the values established during system initialization. (The system gets the initial dump options for SYSUDUMP from the IEADMP00 parmlib member.)

SYSUDUMP,SDATA=(options)

Remove any of the specified SDATA options that previous CHNGDUMP commands put in the SYSUDUMP system dump options list. Parmlib options do not change. If the SYSUDUMP dump mode is OVER and previous CHNGDUMP commands have removed all SDATA and PDATA dump options from the SYSUDUMP dump options list, reset the list to the parmlib options. See "Options for SDUMP, SYSABEND, SYSUDUMP, and SYSMDUMP" on page 183 for SYSUDUMP options you can specify.

SYSUDUMP,PDATA=(options)

Remove any of the specified PDATA options that previous CHNGDUMP commands put in the SYSUDUMP system dump options list. Parmlib options do not change. If the SYSUDUMP dump mode is OVER and previous CHNGDUMP commands have removed all SDATA and PDATA dump options from the SYSUDUMP dump options list, reset the list to the parmlib options. See "Options for SDUMP, SYSABEND, SYSUDUMP, and SYSMDUMP" on page 183 for SYSUDUMP options you can specify.

SYSUDUMP,ALL

Same as DEL,SYSUDUMP.

SYSMDUMP

Set the dump mode for the SYSMDUMP dump type to ADD, and reset the SYSMDUMP system dump options list to the values established during system initialization. (The system gets the initial dump options for SYSMDUMP from the IEADMR00 parmlib member.)

SYSMDUMP=(options)

Remove any of the specified options that previous CHNGDUMP

commands put in the SYSMDUMP system dump options list. Parmlib options do not change. If the SYSMDUMP dump mode is OVER and previous CHNGDUMP commands have removed all dump options from the SYSMDUMP dump options list, reset the list to the parmlib options. See "Options for SDUMP, SYSABEND, SYSUDUMP, and SYSMDUMP" for SYSMDUMP options you can specify.

SYSMDUMP,ALL

Same as DEL,SYSMDUMP.

ALL

Same as DEL.

Options for SDUMP, SYSABEND, SYSUDUMP, and SYSMDUMP

The options that you can specify on the CHNGDUMP command follow. The default options for the IEAABD00, IEADMP00, and IEADMR00 parmlib members are: CB, DM, ENQ, ERR, IO, JPA, LPA, LSQA, NUC, PSW, REGS, RGN, SA, SPLS, SQA, SUM, SWA, and TRT.

SDUMP options

ALLNUC All of the DAT-on nucleus, including page-protected areas, and all of the DAT-off nucleus.

ALLPSA or NOALLPSA or NOALL

Prefix storage area for all processors. NOALLPSA or NOALL specifies that these areas are not to be dumped.

COUPLE XCF related information in the sysplex.

CSA Entire Common storage area including the high virtual CSA storage and virtual storage for 64-bit addressable memory objects created using one of the following services:

- IARV64 REQUEST=GETCOMMON,DUMP=LIKECSA
- IARCP64 COMMON=YES,DUMP=LIKECSA
- IARST64 COMMON=YES,TYPE=PAGEABLE

GRSQ Global resource serialization (ENQ/DEQ/RESERVE) queues.

Notes:

1. When the GRS is running in STAR mode, the output of the GRSDATA subcommand is dependent on the GRSQ option setting of the parmlib member GRSCNFxx. For more information about the GRSCNFxx GRSQ setting, see the *z/OS MVS Planning: Global Resource Serialization*.
2. GRSQ is used for cases where ENQ resources need to be collected. See the "Formatting global resource serialization dump data" section in *z/OS MVS Diagnosis: Reference* for more information about problems related to GRS itself.

HCSABYASID

High virtual CSA storage that is owned by the ASIDs for which SDUMP captures data. See the ASID parameter for details about the ASIDs that are dumped. The HCSABYASID option was introduced to provide a control that limits the amount of DUMP=LIKECSA dumpable attribute data that is captured; you can elect to capture the data for one subsystem and not another subsystem.

Attention: When this option is specified alone, it might result in the inclusion of none of the above the bar CSA storage in the dump.

CHNGDUMP command

This and the other HCSAxxxx options are filters that are introduced as CHNGDUMP options. They assist during installation by controlling the amount of storage that is captured for an SVC dump.

The following table describes how HCSAByASID, HCSANoOwner, and HCSASysOwner affect the CSA storage that is captured in an SVC dump:

Table 18. Affects on the CSA storage captured in an SVC dump

Specified SDATA option or options	CSA storage that is included in the dump
CSA	All above the bar and below the bar CSA storage
CSA, HCSAByASID, HCSANoOwner, HCSASysOwner	All below the bar CSA storage, high virtual CSA storage that is owned by the ASIDs that are included in the dump, high virtual CSA storage for which the owner has ended, and high virtual CSA storage that belongs to the SYSTEM. The dump does not include high virtual CSA storage that is owned by the ASIDs that are excluded from the dump.
HCSAByASID, HCSANoOwner, HCSASysOwner	All high virtual CSA storage that is owned by the ASIDs that are included in the dump, high virtual CSA storage for which the owner has ended, and high virtual CSA storage that belongs to the SYSTEM No below the bar CSA storage is included in the dump.
(Neither CSA nor any of the HCSAxxxx options)	None of the CSA storage is included in the dump.

HCSANoOwner

High virtual CSA storage for which the owner has ended.

Attention: When this option is specified alone, it might result in the inclusion of none of the above the bar CSA storage in the dump.

HCSASysOwner

High virtual CSA storage that belongs to the SYSTEM.

Attention: When this option is specified alone, it might result in the inclusion of none of the above the bar CSA storage in the dump.

LPA Link pack area.

LSQA Local system queue area and virtual storage for 64-bit addressable memory objects created using one of the following services:

- IARV64 REQUEST=GETSTOR,DUMP=LIKELSQA
- IARCP64 COMMON=NO,DUMP=LIKELSQA
- IARST64 COMMON=NO

NUC Non-page-protected areas of the DAT-on nucleus.

PSA Prefix storage area of the dumping processor.

RGN Entire private area and virtual storage for 64-bit addressable memory objects created using one of the following services:

- IARV64 REQUEST=GETSTOR,DUMP=LIKERGN
- IARV64 REQUEST=GETSTOR,SVCDUMPRGN=YES

- IARCP64 COMMON=NO,DUMP=LIKERGN
- IARST64 COMMON=NO

SERVERS

Requests that the registered IEASDUMP.SERVER dynamic exits receive control.

Be warned, however, this setting also causes all synchronous dumps to be converted into asynchronous dumps, which can result in unexpected behavior if the dump requestor was expecting the dump to complete before control was returned to the program. The use of this option is therefore not recommended for general use, so IBM has defaulted the SERVERS option for all operator initiated and SLIP trap SVC dumps.

SQA or NOSQA

System queue area and virtual storage for 64-bit addressable memory objects created using one of the following services:

- IARV64 REQUEST=GETCOMMON,DUMP=LIKESQA
- IARCP64 COMMON=YES,DUMP=LIKESQA
- IARST64 COMMON=YES,TYPE=FIXED
- IARST64 COMMON=YES,TYPE=DREF

NOSQA specifies that this data not be dumped.

SUMDUMP or SUM

Requests the summary dump function. For a description of NOSUM the summary dump function, see *z/OS MVS Programming: Authorized Assembler Services Reference LLA-SDU*.

NOSUM or NOSUMDUMP

Requests that the function not be performed.

SWA Scheduler work area.

TRT GTF, system trace, and master trace data.

WLM Workload management related information in the sysplex.

XESDATA

XES-Related information in the sysplex.

SDATA options for SYSABEND dump type

The SDATA options for the SYSABEND dump type request application related system storage, including key 0 areas, that the application program or programmer can see.

ALLSDATA

Sets all of the other SDATA options except NOSYM and ALLVNUC.

ALLVNUC

All of the DAT-on nucleus, including page-protected areas.

CB Format of task-related control blocks.

DM Data management control blocks.

ENQ Global resource serialization control blocks for the current task.

ERR RTM control blocks.

IO I/O supervisor control blocks.

LSQA Local system queue area.

CHNGDUMP command

- NOSYM** Symptom dump is not to be produced.
- NUC** Non-page-protected areas of the DAT-on nucleus.
- PCDATA** Program call data for the current task.
- SQA** System queue area.
- SUM** Summary dump data.
- SWA** Scheduler work area.
- TRT** GTF and system trace data. (For an authorized user, system trace data is for all address spaces in the system. For an unauthorized user, system trace data is for the user's address space only. The GTF data is for the user's address space only.)

SDATA options for SYSUDUMP dump type

The SDATA options for the SYSUDUMP dump type request application related system storage, including key 0 areas, that the application program or programmer can see.

ALLSDATA

Sets all of the other SDATA options except NOSYM and ALLVNUC.

ALLVNUC

All of the DAT-on nucleus, including page-protected areas.

- CB** Format of task-related control blocks.
- DM** Data management control blocks.
- ENQ** Global resource serialization control blocks for the current task.
- ERR** RTM control blocks.
- IO** I/O supervisor control blocks.
- LSQA** Local system queue area.
- NOSYM** Symptom dump is not to be produced.
- NUC** Non-page-protected areas of the DAT-on nucleus.
- PCDATA** Program call data for the current task.
- SQA** System queue area.
- SUM** Summary dump data.
- SWA** Scheduler work area.
- TRT** GTF and system trace data. (For an authorized user, system trace data is for all address spaces in the system. For an unauthorized user, system trace data is for the user's address space only. The GTF data is for the user's address space only.)

PDATA options for SYSABEND dump type

The PDATA options for the SYSABEND dump type request areas of application storage that are accessible using problem program keys.

ALLPDATA

Sets all of the PDATA options.

- ALLPA** Sets both the LPA and JPA options.

<u>JPA</u>	job pack area.
<u>LPA</u>	Link pack area for this job.
<u>PSW</u>	Program status word.
<u>REGS</u>	General registers.
<u>SA</u>	Save area trace (long form).
<u>SAH</u>	Save area trace (short form).
<u>SPLS</u>	Allocated storage subpools.

SUBTASKS

Program data for the main task and all subtasks of this job. (SUBTASKS is always included for abends with a system completion code of X'22'.)

PDATA options for SYSUDUMP dump type

The PDATA options for the SYSUDUMP dump type request areas of application storage that are accessible using problem program keys.

ALLPDATA

Sets all of the PDATA options.

ALLPA Sets both the LPA and JPA options.

JPA	Job pack area.
LPA	Link pack area for this job.
PSW	Program status word.
REGS	General registers.
SA	Save area trace (long form).
SAH	Save area trace (short form).
SPLS	Allocated storage subpools.

SUBTASKS

Program data for the main task and all subtasks of this job. (SUBTASKS is always included for abends with a system completion code of X'22'.)

SYSMDUMP options

ALL	Sets all of the other SYSMDUMP options except NOSYM and ALLNUC.
ALLNUC	All of DAT-on nucleus, including page-protected areas, and all of the DAT-off nucleus.
CSA	The portions of the common storage area that are not fetch-protected.
GRSQ	Global resource serialization (ENQ/DEQ/RESERVE) queues.

Notes:

1. when the GRS is running in STAR mode, the output of the GRSDATA subcommand is dependent on the GRSQ option setting of the parmlib member GRSCNFxx. For more information about the GRSCNFxx GRSQ setting, see the *z/OS MVS Planning: Global Resource Serialization*.
2. GRSQ is used for cases where ENQ resources need to be collected. Problems related to GRS itself requires more information. See the "Formatting global resource serialization dump data" topic in *z/OS MVS Diagnosis: Reference* for more information.

CHNGDUMP command

<u>LPA</u>	Link pack area for this job.
<u>LSQA</u>	Local system queue area.
<u>NOSYM</u>	Symptom dump is not to be produced.
<u>NUC</u>	Non-page-protected areas of the DAT-on nucleus.
<u>RGN</u>	Entire private area.
<u>SQA</u>	System queue area.
<u>SUM</u>	Requests the summary dump function. For a description of the summary dump function, see <i>z/OS MVS Programming: Authorized Assembler Services Reference LLA-SDU</i> .
<u>SWA</u>	Scheduler work area.
<u>TRT</u>	System trace data. (For an authorized user, system trace data is for all address spaces in the system. For an unauthorized user, system trace data is for the user's address space only.)

Resetting dump mode to add and the dump options to initial values

Use the CHNGDUMP RESET command to reset the dump mode to ADD and the dump options list to values established during system initialization.

```
CD RESET[,SDUMP ]
          |,SYSABEND
          |,SYSUDUMP
          |,SYSMDUMP
          |,ALL
```

RESET

Set the dump mode for each dump type to ADD, and reset the system dump options list for each type to the values established during system initialization. (The system gets the initial dump options for SYSABEND, SYSUDUMP, and SYSMDUMP from parmlib members IEAABD00, IEADMP00, and IEADMR00 respectively. The system empties the SDUMP dump options list.)

RESET,SDUMP or SYSABEND or SYSUDUMP or SYSMDUMP

Set the dump mode for the specified dump type to ADD, and reset the dump type's system dump options list to the values established during system initialization. (The system gets the initial dump options for SYSABEND, SYSUDUMP, and SYSMDUMP from parmlib members IEAABD00, IEADMP00, and IEADMR00 respectively. The system empties the SDUMP dump options list.)

RESET,ALL

Same as RESET.

Example: how CHNGDUMP commands affect dump modes and options

Table 19 on page 189 (using SYSABEND) shows how dump modes and system dump options are set during system initialization and then changed by CHNGDUMP commands or options specified on ABEND macro dump requests. The figure assumes that parmlib member IEAABD00 specifies dump options CB, DM, ENQ, ERR, IO, LSQA, SUM, and TRT. The figure lists system and operator actions and explains each action the system takes.

- The FUNCTION column lists the IPL process, CHNGDUMP commands, and dump requests (from the ABEND macro instruction) as they occur.
- The OPTIONS column identifies the SYSABEND dump options in effect at each point in the example.
- The MODE column identifies the dump mode in effect at each point in the example.

Table 19. Example of How CHNGDUMP Commands Affect Dump Modes and Options

FUNCTION (* indicates operator commands/actions)	OPTIONS	MODE
* IPL During IPL, parmlib options are set on, and mode is set to ADD.	CB IO DM LSQA ENQ SUM ERR TRT	ADD
ABEND SDATA=(NUC,SWA) Because mode is ADD, options specified on dump request are added to options set on in options list to determine areas to dump.	CB LSQA DM NUC ENQ SUM ERR SWA IO TRT	ADD
* CD SET,SYSABEND,SDATA=PCDATA An additional option is set on in options list.	CB LSQA DM PCDATA ENQ SUM ERR TRT IO	ADD
ABEND Because dump request specified no additional options, only options set on in options list determine areas to dump.	CB LSQA DM PCDATA ENQ SUM ERR TRT IO	ADD
ABEND SDATA=(NUC,SWA) Because mode is ADD, options specified on dump request are added to options set on in options list to determine areas to dump.	CB NUC DM PCDATA ENQ SUM ERR SWA IO TRT LSQA	ADD
* CD SET,SYSABEND,OVER,SDATA=(CB,IO) Mode is changed to OVER and parmlib options are deleted from options lists. Only options set by previous CD commands remain on in options list; CD commands are cumulative. Options in options list are combined with override options to determine areas to dump.	CB IO PCDATA	OVER
ABEND SDATA=(SWA,TRT) Because mode is OVER, options specified on dump request are ignored. Options set on in options list determine areas to dump.	CB IO PCDATA	OVER
* CD SET,SYSABEND,SDATA=(ENQ, LSQA),OVER Two more options are set on in options list, and mode is unchanged.	CB LSQA ENQ PCDATA IO	OVER
* CD SET,SYSABEND,SDATA=NUC Mode is changed to ADD (the default) for SYSABEND, parmlib options are set on, and CD command options are set on. Previous CD command options remain on.	CB LSQA DM NUC ENQ PCDATA ERR SUM IO TRT	ADD

CHNGDUMP command

Table 19. Example of How CHNGDUMP Commands Affect Dump Modes and Options (continued)

FUNCTION (* indicates operator commands/actions)	OPTIONS	MODE
ABEND SDATA=(CB,SWA,NUC) Because mode is ADD, options specified on dump request are added to options set on in options list to determine areas to dump.	CB NUC DM PCDATA ENQ SUM ERR SWA IO TRT LSQA	ADD
* CD SET,SYSABEND,NODUMP Mode is changed to NODUMP. All options in options list are set off.		NODUMP
ABEND SDATA=(CB,SWA,NUC) Because mode is NODUMP, request is ignored.		NODUMP
* CD SET,SYSABEND,SDATA=SQA Mode is changed to ADD. Parmlib options on this CD command are set.	CB LSQA DM SQA ENQ SUM ERR TRT IO	ADD
* CD DEL,SYSABEND,SDATA=(DM,IO) Because DEL is specified, specified options in options list are set off.	CB SQA ENQ SUM ERR TRT LSQA	ADD
* CD DEL,SYSABEND,SDATA=(SQA, LSQA,TRT, CB,ENQ,ERR,SUM) Specified options are set off in options list.		ADD
ABEND SDATA=(SQA) The option specified in the dump request determines the area to dump. There are no options on in the options list.	SQA	ADD
* CD RESET,SYSABEND Mode and options list are reset to values established at system initialization.	CB IO DM LSQA ENQ SUM ERR TRT	ADD

Setting the dump modes and options

Use the following form of the CHNGDUMP command to set the dump modes and put specified options in the dump options lists.

```

CD SET,{NODUMP                                     }
      {OVER                                         }
      {ADD                                          }
      {SDUMP[=(option[,option]...)]                }
        [,Q={YES|NO}]
        [,TYPE={XMEM|XMEME}]
        [,BUFFERS={nnnnK|nnnM}]
        [,AUXMGMT={ON|OFF}]
        [,MAXSNDSP=sss]
        [,MAXSPACE=xxxxxxxxM]
        [,MSGTIME=yyyyy]
  
```

```

[,DEFERTND={YES|NO}]
[,SYSFAIL,STRLIST=(s-option[,s-option]...)]
[,NODUMP|OVER|ADD]

{{SYSABEND}[,SDATA=(option[,option]...)][,NODUMP] }
{{SYSUDUMP} |,PDATA=(option[,option]...)} |,OVER }
|,ADD }
{{SYSMDUMP[(option[,option]...)][,NODUMP] }
|,OVER }
|,ADD }
{ABDUMP,TIMENQ=yyyy}

```

Where **s-option** represents:

```

STRNAME=strname
[,CONNAME=conname ]
[,ACCESSTIME={ENFORCE|NOLIMIT|NOLIM} ]
[,LOCKENTRIES ]
[,USERCNTLS ]
[,EVENTQS ]
[, (EMCONTROLS={ALL|(list)}) ]
[, ({COCLASS|STGCLASS|LISTNUM)={ALL|(list)} ]
[ {[,ADJUNCT={CAPTURE|DIRECTIO}][,ENTRYDATA={UNSERIALIZE|SERIALIZE}]} ]
[ {[,SUMMARY]} ) ]

```

SET

Set the dump mode and put specified options in the system dump options list.

NODUMP

Set the SDUMP, SYSABEND, SYSUDUMP, and SYSMDUMP dump modes to NODUMP, and remove all options from the system dump options lists for these dump types.

ADD

Set the SDUMP, SYSABEND, SYSUDUMP, and SYSMDUMP dump modes to ADD. If any of these dump types were previously in OVER mode, add its parmlib dump options to its system dump options list.

OVER

Set the SDUMP, SYSABEND, SYSUDUMP, and SYSMDUMP dump modes to OVER. If any of these dump types were previously in ADD mode, remove its parmlib options from its system dump options list.

SDUMP

Set the SDUMP dump mode to ADD.

SDUMP, NODUMP

Set the SDUMP dump mode to NODUMP.

You cannot specify other parameters when specifying NODUMP. For example, you can specify CD SDUMP,NODUMP, but not CD SDUMP,Q=YES,NODUMP.

SDUMP, OVER or ADD

Set the SDUMP dump mode to the specified mode.

CHNGDUMP command

SDUMP,SYSFAIL,STRLIST=(structure names and options)

Set structures to be dumped when a single system fails or when all the systems connected to a coupling facility fail. SYSFAIL may not be specified with other dump options, and must be specified with STRLIST. The syntax for the STRLIST specification is identical to the DUMP command. SYSFAIL and STRLIST may be specified in ADD or OVER mode. In either mode, the STRLIST parameter list is saved and when a system fails or when all the systems fail, a dump is requested that includes the specified structures.

SDUMP=(options)

Put the specified options in the SDUMP system dump options list. See “Options for SDUMP, SYSABEND, SYSUDUMP, and SYSMDUMP” on page 183 for SDUMP options you can specify.

SDUMP,TYPE=XMEM

Set the SDUMP system dump options list to “cross memory.” Specifying TYPE=XMEM causes SVC dump to dump the cross memory address spaces that the caller has when SVC dump gets control.

SDUMP,TYPE=XMEME

Set the SDUMP system dump options list to “cross memory at the time of the error.” Specifying TYPE=XMEME causes SVC dump to dump cross memory address spaces that the caller has when the error causing the dump occurs.

SDUMP, Q=YES or NO

Specifies whether or not SDUMP is to quiesce the system—set it to nondispatchable (Q=YES) or leave the system dispatchable (Q=NO)—while dumping the contents of the SQA, CSA or collecting Global Exit data.

By quiescing most system activity during SVC dump global storage capture, the dump will contain a more consistent image of the state of the system. However, when collecting large amounts of data, the system can appear to be hung or sluggish. Using Q=NO reduces the impact to system availability, but may impact serviceability.

The CHNGDUMP quiesce (Q=YES|NO) setting overrides any QUIESCE specification made on the SDUMP or SDUMPX macro invocation.

However, if no Q= setting was specified for the CHNGDUMP command during the IPL, the QUIESCE specification on the SDUMP or SDUMPX macro invocation prevails. Note that if the QUIESCE option is omitted on the macro invocation, then the default is QUIESCE=YES.

SDUMP,BUFFERS=nnnnK or nnnM

Provides a **target value** of real storage frames to be reserved for the exclusive use of SVC dump processing. The value can be expressed in kilobytes (0K to 9999K) or in megabytes (0M to 999M). The default is 0K. Depending on real storage utilization, the target value might be different from the actual number of frames available by the time an SVC dump occurs. The value is limited to 25% of the real storage frames available on the system. Check the value established using the DISPLAY DUMP,OPTIONS operator command.

A large BUFFERS value can improve the performance of collecting SVC dump data; however, it tends to negatively impact the general system performance, because it might reduce the number of real storage frames available to other applications.

SDUMP,AUXMGMT=ON or OFF

Specifies when SDUMP data captures should stop.

ON No new dumps are allowed when auxiliary storage usage reaches 50%. New dumps are allowed again only after the auxiliary storage usage drops below 35%. Current SDUMP data capture stops when auxiliary storage usage exceeds 68%, generating a partial dump.

For systems where large SVC dumps are typically generated, it is suggested to set MAXSPACE as 8000 megabytes.

OFF

SVC dump virtual storage management is under control of the MAXSPACE limitations. Dumps in progress are stopped when MAXSPACE is exceeded, or when auxiliary storage utilization exceeds 85%. See the "Obtaining SVC dumps" topic in *z/OS MVS Diagnosis: Tools and Service Aids* for more discussion about using the AUXMGMT and MAXSPACE keywords.

Note:

1. The system always IPLs with the default of AUXMGMT=ON. This increases the availability prospects of a system. To change this default, the installation must use the CHNGDUMP SET,SDUMP,AUXMGMT=OFF command after the system IPLs (for example, using a COMMNDxx parmlib member).
2. Once SVC dump processing has detected a shortage, the auxiliary storage utilization must drop below 35% before new SVC dump requests will be honored. The condition cannot be removed by simply changing the setting of AUXMGMT from ON to OFF.

SDUMP,MAXSNDSP=sss

Specifies the maximum time interval that an SVC dump keeps a system non-dispatchable, where *sss* is the number of seconds. The default value is 15 seconds.

If the system is reset to be dispatchable because the system has been kept non-dispatchable longer than *sss* seconds, a SNAPTRC is issued. You can use the WORKSHEET option in IPCS to view this SNAPTRC.

SDUMP,MAXSPACE=xxxxxxxxM

Specifies the maximum amount of virtual storage that SVC dump can use to capture volatile virtual storage data, summary dump data, and component-specific data before writing the dump to DASD. The default value is 500 megabytes. The value that can be specified may range from 1 to 99999999 (with, or without, an M suffix). The new value takes effect immediately. If the value specified is lower than the space used, SVC dump will not continue to capture data.

The CHNGDUMP command only provides two ways to change the MAXSPACE value: by using the SET,SDUMP invocation as described here; or by using the RESET,SDUMP invocation that resets all initial SDUMP parameters, including setting the MAXSPACE value to 500M.

SDUMP,MSGTIME=yyyyy

Specifies how long message IEA793A appears on the console, where *yyyyy* is a number of minutes from 0 — 99999. The default is 99999. When the system deletes the message, it also deletes the captured dump.

You cannot delete this option with CHNGDUMP DEL. To change the value of MSGTIME, issue the CHNGDUMP command in the SET mode with a new value. If you change the MSGTIME value after the message IEA793A

CHNGDUMP command

appears, the new value will be in affect immediately. If you set the MSGTIME value to 0, the system will not issue the message and it deletes the captured dump.

SDUMP, DEFERTND=YES or NO

Specifies whether SDUMP processing should defer setting the tasks of the address space non-dispatchable until the capture of global storage is completed. The default is NO.

The installation can use CHNGDUMP command to set DEFERTND to Yes or No. This setting can be overridden by the DEFERTND setting by DUMP command REPLY or parmlib member IEADMCxx. The following table shows the rule which SDUMP uses to determine whether it will defer the setting of tasks non-dispatchable:

DEFERTND is specified in DUMP reply or in IEADMCxx	DEFERTND= is specified in DUMP reply or in IEADMCxx as:	DEFERTND= is specified by CHNGDUMP command as:	Result of DEFERTND is:
Used	Yes	Yes	Yes
Used	Yes	No	Yes
Used	No	Yes	No
Used	No	No	No
Not used	-	No	No
Not used	-	Yes	Yes

Note: Support of deferring the setting of tasks non-dispatchable is only applied to console initiated dumps.

STRLIST= or STL=(STRNAME=strname...)

Used to include in the dump a list of coupling facility structures. Following are the structure-related keywords:

STRNAME= or STRNM=strname

Designates a particular coupling facility list or cache structure. *strname* is the name of the coupling facility structure to be included in the dump. Any dump options for this structure are replaced when you issue this command. If *strname* does not begin with a letter or is longer than 16 characters the system issues syntax error message IEE866I. If a structure does not exist, or the update fails for any reason, the system issues message IEE816I. You may include more than one STRNAME=strname within the parentheses, separated by commas.

CONNAME= or CONNM=conname

When specified for a coupling facility cache structure, requests the user registry information for this user be included in the dump. *conname* is the name of a connected user. If the connected user represented by the conname does not exist, the dump will not contain user registry information.

ACCESSTIME= or ACC={ENFORCE or ENF or NOLIMIT or NOLIM}

Indicates whether the dump time limit specified on the ACCESSTIME parameter of the IXLCONN macro is in effect. When ACCESSTIME=ENFORCE is specified, the system holds structure dump serialization no longer than the time interval specified on the IXLCONN macro. This is the default. If ACCESSTIME=0 is specified on

the IXLCONN macro and ACCESSTIME=ENFORCE is specified on the dump request, the structure will not be included in the dump.

When ACCESSTIME=NOLIMIT is specified, the dump time limit is not in effect and the system will hold structure dump serialization until processing is completed.

LOCKENTRIES or LOCKE

When specified for a coupling facility list structure, the system includes in the dump the lock table entries for the requested structure. Since lock table entries do not exist for coupling facility cache structures, this keyword is ignored when specified for a coupling facility cache structure.

USERCNTLS or UC

Requests that the user attach controls be included in the dump.

(list)

Represents a list of values, ranges of values, or values and ranges of values.

(start1-end1,value2,start3-end3, ...)

COCLASS= or COC=ALL or (list)

Specifies which cast-out classes are included in the dump. For each cast-out class, the cast-out class controls are dumped and the directory information for each of the entries within the requested cast-out classes are dumped (if SUMMARY is not specified).

COCLASS is valid only for a coupling facility cache structure. If specified for a coupling facility list structure, the structure is not included in the dump.

When COCLASS=ALL is specified, the cast-out class controls for all cast-out classes are dumped along with the directory information for all entries within the classes (if SUMMARY is not specified).

When COCLASS=(list) is specified, the cast-out class controls for (list) are dumped along with the directory information for the entries in the requested cast-out classes (if SUMMARY is not specified). The values specified in a range are the decimal cast-out class values in the range 0–65535. When a requested class does not exist, it is not dumped.

STGCLASS= or SC=ALL or (list)

Specifies which storage classes are included in the dump. For each storage class, the storage class controls are dumped and the directory information for each of the entries within the requested storage classes are dumped (if SUMMARY was not specified).

STGCLASS is valid only for a coupling facility cache structure. If specified for a coupling facility list structure, the structure will not be included in the dump.

When STGCLASS=ALL is specified, the storage class controls for all storage classes are dumped along with the directory information for all entries within the classes (if SUMMARY is not specified).

When STGCLASS=(list) is specified, the storage class controls for (list) are dumped along with the directory information for the entries in the requested storage classes (if SUMMARY is not specified). The values specified are the decimal storage class values, 0–255. When a requested class does not exist, it is not dumped.

CHNGDUMP command

LISTNUM= or **LNUM=ALL** or (*list*)

Specifies which lists are included in the dump. The list controls are dumped along with the entry controls for the entries on each requested list (if SUMMARY is not specified).

LISTNUM is only valid for a coupling facility list structure. If specified for a coupling facility cache structure, the structure is not included in the dump.

When LISTNUM=ALL is specified, the list controls for all lists in the coupling facility list structure are dumped along with the entry controls (if SUMMARY is not specified).

When LISTNUM=(*list*) is specified, the list controls for (*list*) are included in the dump along with the entry controls for those lists. The values specified are the decimal list values, 0–4294967295. The system ignores a zero in the case of LISTNUM. No error results. When a requested list does not exist, it is not dumped.

You may use the following keyword to further modify the STGCLASS, COCLASS and LISTNUM keywords:

ADJUNCT= or **ADJ={CAPTURE or CAP or DIRECTIO or DIO}**

Indicates that the adjunct data for each entry specified by the range is included in the dump. When you do not specify this keyword, or when adjunct data does not exist for this structure, the dump does not include the adjunct data.

ADJUNCT may not be specified with SUMMARY. If they are both specified, a syntax error is issued.

When ADJUNCT=CAPTURE is specified, the adjunct data is captured in the facility dump space along with the directory information while dumping serialization is held.

When ADJUNCT=DIRECTIO is specified, the adjunct data is written directly to the dump data set after the directory information is captured. The adjunct data is not captured in the structure dump table. The adjunct data may be changing as dumping proceeds.

ENTRYDATA= or **EDATA={UNSERIALIZE or UNSER or SERIALIZE or SER}**

Indicates that the entry data for each entry within the requested range is included in the dump. When this keyword is not specified or when entry data does not exist for the structure, entry data is not included in the dump.

ENTRYDATA may not be specified with SUMMARY. If they are both specified, a syntax error is issued.

When ENTRYDATA=UNSERIALIZE is specified, the entry data is dumped after structure dump serialization is released. The entry data may be changing relative to the entry controls that were captured while structure dump serialization was held.

When ENTRYDATA=SERIALIZE is specified, the entry data is dumped while serialization is held. If ACCESSTIME=ENFORCE is specified and the dump time limit expires before the entry data is written to the dump data set, the system continues to write the entry data to the dump data set even though serialization is not held.

SUMMARY or SUM

Indicates that a summary of the range of classes or lists is dumped. The directory information for the entries is excluded from the dump.

SUMMARY may not be specified with ADJUNCT or ENTRYDATA. If it is specified with either of these keywords, a syntax error is issued.

Note:

1. A syntax error is issued if STRNAME is not the first keyword.
2. If CONNAME and ACCESSTIME are specified more than one time for a structure, the first CONNAME and the last ACCESSTIME are used.
3. When a list number, a storage class, a cast-out class, or an entry is specified in the STRLIST more than once, it will be dumped more than once. An example of this is when STGCLASS=ALL is specified with COCLASS=ALL. All entries in the coupling facility cache structure are dumped twice. Once grouped by storage class and again grouped by cast-out class.
4. When neither LISTNUM, STGCLASS, or COCLASS is specified, no list or class controls are dumped and no entries are dumped.
5. If you request a large amount of dump data, the system may not be able completely to dump all the data. You can expect to successfully dump up to a maximum of 47 structures if you specify no more than a total of 6 ranges. If you must specify more than 6 ranges, you must specify fewer structures. For each structure less than 47 that you specify, you can specify another 10 ranges, as follows:

Number of Structures	Number of Ranges
47	6
46	16
45	26
44	36
⋮	⋮
⋮	⋮

If the system cannot dump all the data you requested, it prioritizes the data according to your specifications on the command in the following manner:

- a. The system will attempt to dump the first requested structure first.
 - 1) Within that structure, the system processes the LOCKENTRIES, USERCNTLS, COCLASS, STGCLASS, and LISTNUM parameters in the order that they are specified. COCLASS, STGCLASS, and LISTNUM may be specified more than once for a single structure.
 - 2) The system dumps requested serialized data before requested unserialized data starting with the first requested data in the structure and proceeding through the last data that was requested as *serialized*.
- b. The system then dumps the next-requested structure data starting with the first requested data in the structure and proceeding through the last data that was requested as *serialized*.
- c. The system continues in this manner until all *serialized* data in all requested structures has been prioritized for dumping.

CHNGDUMP command

- d. The system then dumps any remaining data that was requested as *unserialized* that may not have been dumped beginning with the first-requested structure.

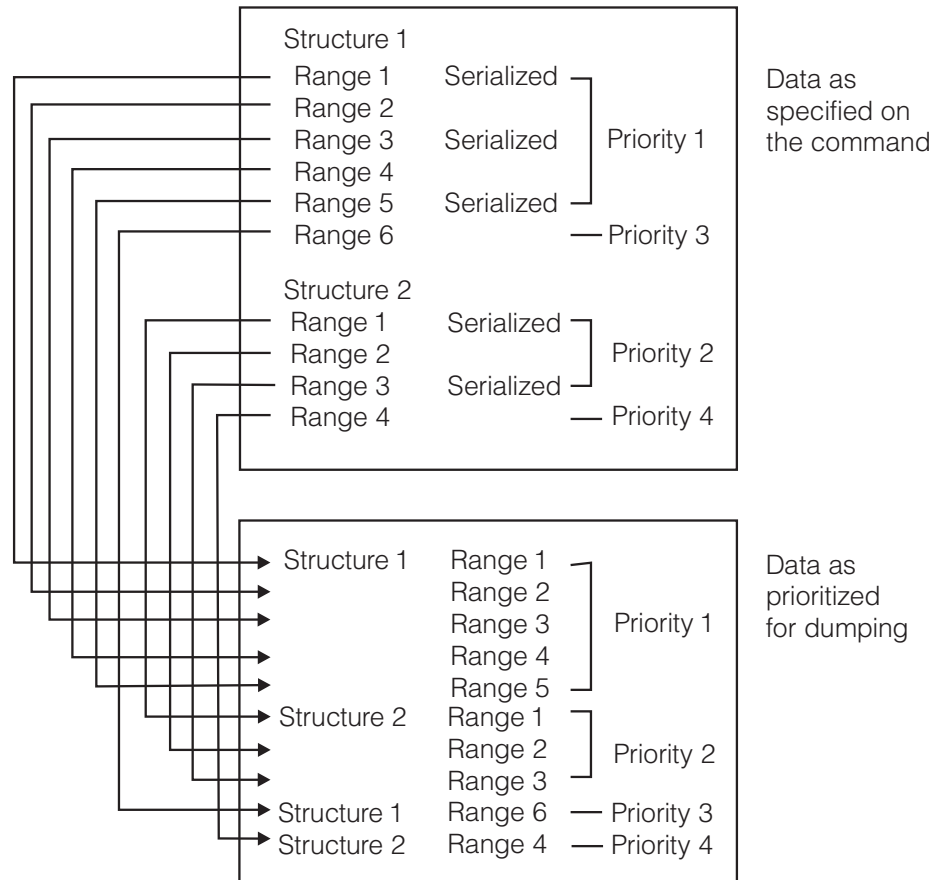

6. The CONT parameter allows the operator to provide input to the CHNGDUMP command that spans more than one line of input. You can specify the CONT parameter after any comma within the STRLIST parameter list. If a line of input ends with a comma and any closing parentheses are missing, the system assumes the CONT parameter.

SYSABEND

Set the SYSABEND dump mode to ADD.

SYSABEND,NODUMP

Set the SYSABEND dump mode to NODUMP.

You cannot specify other parameters when specifying NODUMP. For example, you can specify CD SYSABEND,NODUMP, but not CD SYSABEND,PDATA=*option*,NODUMP.

SYSABEND,OVER or ADD

Set the SYSABEND dump mode to the specified mode.

SYSABEND,SDATA=(*option*[,*option*]...)

Put the specified SDATA options in the SYSABEND system dump options list. See "Options for SDUMP, SYSABEND, SYSUDUMP, and SYSMDUMP" on page 183 for SYSABEND options you can specify.

SYSABEND, PDATA=(option[,option]...)

Put the specified PDATA options in the SYSABEND system dump options list. See “Options for SDUMP, SYSABEND, SYSUDUMP, and SYSMDUMP” on page 183 for SYSABEND options you can specify.

SYSUDUMP

Set the SYSUDUMP dump mode to ADD.

SYSUDUMP, NODUMP

Set the SYSUDUMP dump mode to NODUMP.

You cannot specify other parameters when specifying NODUMP. For example, you can specify CD SYSUDUMP,NODUMP, but not CD SYSUDUMP,PDATA=option,NODUMP.

SYSUDUMP, OVER or ADD

Set the SYSUDUMP dump mode to the specified mode.

SYSUDUMP, SDATA=(option[,option]...)

Put the specified SDATA options in the SYSUDUMP system dump options list. See “Options for SDUMP, SYSABEND, SYSUDUMP, and SYSMDUMP” on page 183 for SYSUDUMP options you can specify.

SYSUDUMP, PDATA=(option[,option]...)

Put the specified PDATA options in the SYSUDUMP system dump options list. See “Options for SDUMP, SYSABEND, SYSUDUMP, and SYSMDUMP” on page 183 for SYSUDUMP options you can specify.

SYSMDUMP

Set the SYSMDUMP dump mode to ADD.

SYSMDUMP, NODUMP

Set the SYSMDUMP dump mode to NODUMP.

You cannot specify other parameters when specifying NODUMP. For example, you can specify CD SYSMDUMP,NODUMP, but not CD SYSMDUMP=option,NODUMP.

SYSMDUMP, OVER or ADD

Set the SYSMDUMP dump mode to the specified mode.

SYSMDUMP=(option[,option]...)

Put the specified options in the SYSMDUMP system dump options list. See “Options for SDUMP, SYSABEND, SYSUDUMP, and SYSMDUMP” on page 183 for SYSMDUMP options you can specify.

ABDUMP, TIMEENQ=yyyy

Sets the approximate number of seconds that ABDUMP processing waits for obtaining required resources. The value may be changed up to the maximum of 9999. If this command is used to change the value from the IBM default interval of 240 seconds, place the command into a COMMNDxx member of PARMLIB. That establishes the setting as the installation default when the system is IPLed. See *z/OS MVS System Messages, Vol 6 (GOS-IEA)* for the discussion in message IEA848I, DEADLOCK AVOIDED to find more information.

Whenever the TIMEENQ value is changed, the new value takes effect immediately. A value of 0 does not force an SVC dump to occur, because the resources required might be immediately available. You can not use CHNGDUMP DEL to delete this option.

CMDS command

Use the CMDS command to display executing and waiting MVS commands, to delete commands that are waiting for execution, or to cancel commands that are executing.

Syntax

The complete syntax for the CMDS command is:

```
CMDS {ABEND,CMD=ccccccc,ID=nnnn[,CLASS=classname][,JOB=jobname]}
      {DISPLAY|D[,CLASS=classname][,CMD=ccccccc][,ID=nnnn][,JOB=jobname]}
      {DUMP}
      {FORCE,CMD=ccccccc,ID=nnnn[,CLASS=classname][,JOB=jobname]}
      {REMOVE|R[,CLASS=classname][,CMD=ccccccc][,ID=nnnn][,JOB=jobname]}
      {SHOW|S[,CLASS=classname][,CMD=ccccccc][,ID=nnnn][,JOB=jobname]}
```

Note:

1. The ABEND and FORCE parameters require that you specify the CMD= and ID= subparameters.
2. The REMOVE parameter requires that you specify at least one subparameter.
3. You may specify the optional subparameters of the default (DISPLAY) or specified parameter in any order.
4. WARNING: Never use the FORCE parameter without understanding that:
 - After issuing CMDS FORCE, you might have to re-IPL the system or depending on the command being terminated, a sysplex-wide IPL may be required.
 - You should ensure that the target command is hung and not just needing a long time to complete.
5. If you need a dump, you may issue a CMDS DUMP command before you issue CMDS ABEND or CMDS FORCE. Note that CMDS DUMP will dump only Master's and Console's address space. If you believe the target command may have functions running in another address space, use the DUMP command instead, specifying the address space along with Master's and Console's.

Parameters

CMDS:

- **ABEND** — abnormally end a command that is currently executing.
 This parameter requires subparameters CMD= and ID=.
 The system terminates, with ABEND code 422, reason code 00010301, the command that CMD=ccccccc and ID=nnnn identifies.
 Use the ABEND option with extreme caution, being careful to avoid leaving the system in an inconsistent state.
 The system issues message IEE064I in response to this command. It does not send any response message to the console that issued the abended command.
Attention: The ABEND request will be rejected with message CNZ6002I if the command is in a non-abendable state.
- **DISPLAY | D** — display the numbers and brief information about the commands that are currently executing and those that are waiting for execution.
 The system issues message IEE062I in response to this command.

- **DUMP** — schedule a dump for the master and console address space.
- **FORCE** — abnormally end a command that is currently executing.
 This parameter requires subparameters **CMD=** and **ID=**.
 The system terminates, with ABEND code 422, reason code 00010302, the command that **CMD=ccccccc** and **ID=nnnn** identifies.
 Use the **FORCE** option with extreme caution because you are terminating a command that may be updating critical system data. Use this parameter only as a last resort, such as when a re-IPL is needed if the command is not terminated.
 The system issues message IEE064I in response to this command. It does not send any response message to the console that issued the abended command.
Attention: If the command is considered non-abendable, **FORCE** will still terminate the command and message CNZ6002I will be issued indicating that **FORCE** overrode the abendable setting.
- **REMOVE | R** — remove commands that are waiting for execution, as specified by the subparameters. You cannot use this option to cancel any commands that are executing.
 The **REMOVE** parameter requires you specify at least one of the keyword subparameters **CLASS=**, **CMD=**, **ID=**, or **JOB=**.
 The system issues message IEE064I in response to this command, and sends message IEE065I to the console that issued the removed command.
- **SHOW | S** — display full information about the specific command(s) specified by the subparameters.
 The system issues message IEE063I in response to this command.

The **CMDS** command uses the following keyword subparameters to limit the number of commands to show or remove:

- **CLASS=** classname
 The command class in which the commands belong.
 If you do not specify this parameter, commands in all classes will be displayed or removed.
 The classes are:
 1. Class M1 commands may be essential to clearing a backlog of Class M2 commands.
 2. Class M2 commands are ordinary attached commands that run in the MASTER address space.
 3. Class M3 is only for SEND commands executed in the MASTER address space.
 4. Class C1 commands might be needed to clear a backlog of Class C2 commands.
 5. Class C2 commands are ordinary attached commands that run in the CONSOLE address space.
 6. Class C3 is only for the ROUTE command executed in the CONSOLE address space.

For a list of the commands by class, see “Command flooding” on page 36.

- **CMD=** command verb
 The name of the command, as displayed by the **SHOW** option. For example,
`CMDS REMOVE,CMD=CONFIG`
 will delete all **CONFIG** commands that are waiting for execution.

CMDS command

You can use command abbreviations instead of full command names.

- **ID=** number
 - The command's sequence number, which appears in the output from a CMDS DISPLAY or CMDS SHOW command (messages IEE062I or IEE063I).

- **JOB=** jobname of the command issuer, as displayed by the SHOW option. For example,

```
CMDS REMOVE,JOB=JOB1111
```

will remove all commands issued by JOB1111.

If you specify more than one of the keyword parameters, the command must meet all specified criteria. For example,

```
CMDS REMOVE,CMD=VARY,JOB=JOB1111
```

will remove waiting VARY commands that job JOB1111 issued.

Note: Some commands remain active indefinitely, so the system will display them whenever CMDS is issued. For example, if any SLIP commands have been issued and SLIP traps are in effect, one SLIP command will be “executing” until all traps are deleted. This is also true for many SET commands, such as SET SLIP and SET MPF.

CONFIG command

Use the CONFIG command to change or check the configuration of the system. You can use the CONFIG command to change the online or offline status of available processors, storage amounts, storage ranges, central storage elements, PCIE function identifiers (PFIDs), storage-class memory (SCM), and channel paths:

1. Directly
2. In response to a configuration display
3. With the options in a CONFIGxx parmlib member that you specify

Table 20 summarizes the information that the CONFIG command provides. Use it to access the pages on which you can find details about a particular use of the CONFIG command.

Table 20. Summary of the CONFIG Command

Command:	Topic:
CONFIG CHP CONFIG CORE CONFIG CPUAD CONFIG PFID CONFIG SCM CONFIG STORAGE	“Reconfiguring the system directly” on page 203
CONFIG MEMBER	“Reconfiguring the system with a CONFIGxx parmlib member” on page 215
CONFIG OFFLINE CONFIG ONLINE	“Reconfiguring the system in response to a configuration display” on page 216

The CONFIG command reconfigures (both logically and physically) available processors, central storage ranges, amounts, elements, PCIE function identifiers (PFIDs), and channel paths.

Note: To configure an Integrated Cryptographic Facility (ICRF) online or offline, you have to configure online or offline the processor to which the ICRF is attached, and when configuring an ICRF online, Integrated Cryptographic Service Facility/MVS (ICSF/MVS) must be active. You can enter the CONFIG command only from a console with master authority.

Syntax

The syntax for each variation of the CONFIG command is shown immediately preceding its respective parameter list.

```
CONFIG or CF
```

Reconfiguring the system directly

Use the CONFIG command to change the online or offline status of any of the following, directly, that is, without invoking a configuration display or a CONFIGxx parmlib member: available processors, Integrated Cryptographic Facilities (ICRFs), attached to online processors, storage amounts, storage ranges, central storage elements, logical partitions, PCIE function identifiers (PFIDs), or channel paths.

See Chapter 2, “System Reconfiguration,” on page 91 for more information about how to reconfigure the resources associated with a processor or a processor complex. See *PR/SM Planning Guide* for more information about logical partitions.

```
CF {{CPUAD|CPU}(x[,x]...)[,{ONLINE|ON} [,,{STANDARD | ZAAP | ZIIP | ANY}} ] }
    [,,{OFFLINE|OFF} [,,{STANDARD | ZAAP | ZIIP | ANY}} ] }

|
|   {CORE (x[,x]...)[,{ONLINE|ON} [,,{STANDARD | ZAAP | ZIIP | ANY}} ] }
|   [,,{OFFLINE|OFF} [,,{STANDARD | ZAAP | ZIIP | ANY}} ] }

|
|   {CHP{(xx) }[,,{ONLINE|ON}[,NOVARY][,FORCE] ] }
|   {(aa-bb) }[,,{OFFLINE|OFF}[,UNCOND][,FORCE] ] }
|   {(list) }
|   {(ALL,id)}

|
|   {PFID{(xxxx) }[,ONLINE|ON ] }
|   {(aaaa-bbbb) }[,,{OFFLINE|OFF}[,FORCE]] }
|   {(list) }

|
|   {SCM{(ddddddd{M|G|T})[,ONLINE|ON|OFFLINE|OFF]} }
|   {(scm_ranges),{OFFLINE|OFF} }

|
|   {{STORAGE|STOR}{(dddddddM) }[,,{ONLINE|ON} |,{OFFLINE|OFF}] }
|   {(dddddddM-ddddddM)}
|   {(E=id) }
```

The parameters are:

CPUAD or CPU

The system is to reconfigure one or more CPUs. The system is also to reconfigure one or more ICRFs attached to specified online CPUs.

(x[,x]...)

One or more CPU identifiers. The CPU identifier is a one-to-two-digit hexadecimal value.

ONLINE or ON

The system is to bring the specified processor(s) online. If necessary, the

CONFIG command

system synchronizes the processor's TOD clocks. If Integrated Cryptographic Service Facility/MVS (ICSF/MVS) is active, the system brings online any ICRF attached to each processor.

STANDARD or ZAAP or ZIIP or ANY

The system validates that the processor requested to be brought online is the expected processor type. If the processor being configured is not of the specified type, the command is rejected and the system issues message IEE241I with 'PROCESSOR TYPE MISMATCH'.

STANDARD

Standard (general purpose) processor.

ZAAP

IBM zEnterprise Application Assist Processor (zAAP).

ZIIP

IBM z Integrated Information Processor (zIIP).

ANY

Any type of processor. ANY is the default if no processor type is specified.

Note: CONFIG ONLINE command variants that do not specify CPU(*nn*) will not accept this processor type specification. For example, CONFIG ONLINE,ZAAP is not accepted.

OFFLINE or OFF

The system is to take offline the specified processor(s) and any ICRF attached to the processor(s).

STANDARD or ZAAP or ZIIP or ANY

The system validates that the processor requested to be brought offline is the expected processor type. If the processor being configured is not of the specified type, the command is rejected and the system issues message IEE241I with 'PROCESSOR TYPE MISMATCH'.

STANDARD

Standard (general purpose) processor.

ZAAP

IBM zEnterprise Application Assist Processor (zAAP).

ZIIP

IBM z Integrated Information Processor (zIIP).

ANY

Any type of processor. ANY is the default if no processor type is specified.

Note: CONFIG OFFLINE command variants that do not specify CPU(*nn*) will not accept this processor type specification. For example, CONFIG OFFLINE,ZAAP is not accepted.

CORE

The system is to configure a core online or offline.

(*x[,x]...*)

One or more core identifiers. The core identifier is a one-to-two-digit hexadecimal value.

ONLINE or ON

The system is to bring the specified core online according to the

MultiThreading Mode of the core type. For example, if zIIPs are exploiting a MultiThreading Mode of 2, two threads on the zIIP core are brought online. For more information, see IEAOPTxx MT_CP_MODE and MT_ZIIP_MODE in *z/OS MVS Initialization and Tuning Reference*.

STANDARD or ZAAP or ZIIP or ANY

The system validates that the core requested to be brought online is the expected core type. If the core being configured is not of the specified type, the command is rejected and the system issues message IEE241I with 'PROCESSOR TYPE MISMATCH'.

STANDARD

Standard (general purpose) core.

ZAAP

IBM zEnterprise Application Assist Processor (zAAP).

ZIIP

IBM z Integrated Information Processor (zIIP).

ANY

Any type of core. ANY is the default if no core type is specified.

Note: CONFIG ONLINE command variants that do not specify CPU(*nn*) will not accept this core type specification. For example, CONFIG ONLINE,ZAAP is not accepted.

OFFLINE or OFF

The system is to take offline all threads on the specified core.

STANDARD or ZAAP or ZIIP or ANY

The system validates that the core requested to be brought offline is the expected core type. If the core being configured is not of the specified type, the command is rejected and the system issues message IEE241I with 'PROCESSOR TYPE MISMATCH'.

STANDARD

Standard (general purpose) core.

ZAAP

IBM zEnterprise Application Assist Processor (zAAP).

ZIIP

IBM z Integrated Information Processor (zIIP).

ANY

Any type of core. ANY is the default if no core type is specified.

Note: CONFIG OFFLINE command variants that do not specify CPU(*nn*) will not accept this core type specification. For example, CONFIG OFFLINE,ZAAP is not accepted.

Note: When running a machine that supports multiple threads per core, configuring a core means multiple threads will be configured.

STORAGE or STOR

The system is to reconfigure central storage, both logically and physically. Note that storage reconfiguration is not supported on all processors and that central storage reconfiguration in a PR/SM environment without enhanced dynamic storage reconfiguration must be specified by storage element ID. The starting and ending addresses of the central storage for which you want the status display.

CONFIG command

dddddddX

The amount of central storage to be reconfigured. Specify up to eight decimal digits followed by a multiplier (M-megabytes, G-gigabytes, T-terabytes, P-petabytes) for this amount. Check the configuration of your processor to see which size storage increments are supported. The value for *ddddddd* must be a multiple of the storage increment size (usually 2, 4, or 8), and cannot exceed 16383P.

Instead of specifying a decimal amount, you may specify a hexadecimal amount, with or without a multiplier, in the format *X'xxxxxx'*. For example:

- *X'123456789A00000'*
- *X'123'M*

You may use underscores in any hexadecimal specification for better clarity. Underscores in the specification are ignored during processing.

dddddddX-ddddddX

The starting and ending addresses of the central storage section to be reconfigured. Specify up to eight decimal digits followed by a multiplier (M-megabytes, G-gigabytes, T-terabytes, P-petabytes) for each address. The value for each *ddddddd* must be a multiple of the storage increment size (usually 2, 4, or 8), and cannot exceed 16383P. The starting and ending addresses must not be the same.

Instead of specifying the range using decimal numbers, you may specify it in hexadecimal, with or without a multiplier, in the format *X'xxxxxx'-X'xxxxxx'*. For example:

- *X'123456789A00000'-X'123456789B00000'*
- *X'123'M-X'124'M*

You may use underscores in any hexadecimal specification for better clarity. Underscores in the specification are ignored during processing.

E=id

The storage element to be reconfigured, identified by the storage element *id*. Use this parameter only under the direction of a system programmer to take a storage element offline or online.

ONLINE or ON

The system is to bring the specified storage range or storage element online. The system rejects the command if you specify:

- An address higher than the storage limit set at system initialization
- An address or an element id for storage that is not available to the system

OFFLINE or OFF

The system is to take the specified storage range or storage element offline.

Note:

1. There can be a delay between the time you enter CONFIG STOR ... OFFLINE and the time the system issues a message indicating the storage is offline. This delay occurs when there is activity in the specified storage; all activity in the storage must stop before the command can take effect. If the storage does not go offline within a short time, a message appears that lets you cancel the command.
2. When you issue CONFIG STOR ... OFFLINE without *E=id*, the system rejects the command if you specify storage that is either part of the hardware system area (HSA) or assigned permanently to the system.

Generally, you can take non-preferred (reconfigurable) storage offline, but, you cannot take preferred (non-reconfigurable) storage offline.

3. When you issue CONFIG STOR ... OFFLINE with *E=id*, the system moves any storage associated with the HSA or permanently assigned to the system to another storage element. The system saves the addresses of the former storage and displays their address ranges.
4. In order to configure a range of storage online through the CONFIG STOR(*xx-xx*),**ONLINE** command, the subject storage must be in a storage element that is online. If a storage element is offline, the only way to bring online any storage within that element is to configure the entire element online, through CONFIG STOR(*E=id*),**ONLINE**.

SCM(*ddddddd*{**M**|**G**|**T**}),**ONLINE**|**ON**
SCM(*ddddddd*{**M**|**G**|**T**}),**OFFLINE**|**OFF**
SCM(*scm_ranges*),**OFFLINE**|**OFF**

The system reconfigures storage-class memory (SCM), both logically and physically. To bring SCM online, an amount must be specified. To take SCM offline, a range of starting and ending addresses of the SCM blocks must be specified.

ddddddd{**M**|**G**|**T**}

The amount of storage-class memory (SCM) to be reconfigured. Specify up to eight decimal digits followed by a multiplier (M-megabytes, G-gigabytes, T-terabytes) for this amount. Check your processor configuration for the supported SCM increment sizes. The value for *ddddddd* must be a multiple of the SCM increment size (usually 2, 4, or 8), and cannot exceed 16T.

Instead of specifying a decimal amount, you can alternatively specify a hexadecimal amount, with or without a multiplier, in the format *X'xxxxxx'*. For example:

- *X'123456789A00000'*
- *X'123'M*

You can use underscore characters in any hexadecimal specification for additional clarity. Underscore characters in the specification are ignored during processing.

Attention: If you are taking SCM offline and you do not specify one or more *scm_ranges*, the system will select which SCM increments to take offline.

ONLINE or **ON**

The system brings the specified amount of SCM online. **ONLINE** is the default value if only CONFIG SCM is specified. The system rejects the command under any of the following conditions:

- You specify a value that is not a multiple of the SCM increment size.
- You specify a value that exceeds the total amount of SCM that is defined to this partition.
- You specify a value that is not a valid amount of SCM (0, for example).
- SCM is not supported or not defined on the system.

OFFLINE or **OFF**

The system takes the specified amount or specified ranges of SCM offline.

CONFIG command

Attention: Taking SCM offline can impact data reliability and performance. Consider the following implications before taking SCM offline:

- Your system must have enough auxiliary storage, which can include SCM and must include page data sets, to back critical system data. The CONFIG SCM OFFLINE command will fail if taking the specified amount of SCM offline would leave auxiliary storage more than 50% full.
- SCM is used for paging critical address spaces and common address spaces. An insufficient amount of SCM causes those address spaces to page to page data sets, which could lead to a loss of critical data during a DASD HDD HyperSwap scenario.
- SCM is used for paging large pages. If there is an insufficient amount of SCM, 1M large pages are demoted to 256 4K pages and paged to page data sets, which could have a negative impact on system performance.

scm_ranges

Specifies a range of SCM or a list of ranges separated by commas identified by *ddd{M|G|T}-ddd{M|G|T}* (for example: 0G-16G,32G-64G). The starting and ending addresses for each range of SCM must be multiples of the increment size.

CHP

The system is to reconfigure one or more channel paths.

Note that if you have systems running on a processor at the z990 level or higher, you can automatically reconfigure channel paths on and offline using the hardware management console (HMC) instead of issuing the CONFIG command. On a z990, you may have multiple logical channel subsystems, which means that if an ESCON card fails, you need to reconfigure 15 channels being used across 30 different partitions in each logical channel subsystem. Automatic CHPID reconfiguration lets you issue a reconfiguration request centrally from HMC, which in turn triggers the z/OS systems in each partition to issue the CONFIG command. Then only those partitions that cannot process the request or are not running on a z990 level processor or higher need to be individually reconfigured with the CONFIG command.

(xx)

A single channel path identified by *xx*. The channel path identifier may have a value from 0 to FF.

(aa-bb)

A range of channel paths. The starting and ending channel path identifiers may have values from 0 to FF.

(list)

One or more single channel paths, ranges of channel paths, or a combination of single channel paths and ranges of channel paths. ALL,*id* cannot be included in the list.

(ALL, id)

All of the channel paths associated with one side of a partitioned processor complex are to be placed online or offline, where *id* is the identifier (0 or 1) of the side. Use ALL,*id* only when your processor complex is one that can be partitioned (such as a 3090 Model 400 Processor Complex). Message IEE172I indicates that all channel paths on a side have been brought online or taken offline.

Note: If you configure a partitionable processor from single image to partitioned mode, and a tape mount is pending, the tape drive(s) might not start after you mount them. You can avoid the problem by mounting the tape before you issue the CONFIG CHP(ALL,id),OFFLINE command to perform the partitioning or, after partitioning, you can issue the VARY device,ONLINE command to start the tape drive(s).

ONLINE or ON

The system is to bring the specified channel path(s) online.

ONLINE,NOVARY

The system is to bring the specified channel paths online without bringing online the paths to the associated devices. Use this command when you want to configure online a channel path that does not currently have a device connected. Example 10 shows the operator commands and system responses.

ONLINE, FORCE

Indicates that if the resource being configured online is a channel path, the system attempts to bring the channel path online even if it is offline due to switch port decommissioning or HMC repair and verify reasons. The attempt will fail if the switch port is offline for other reasons (for example, blocked, in maintenance mode, or service required).

OFFLINE or OFF

The system is to take the specified channel path(s) offline. The system rejects this command if it would remove the last path to a device that is:

- In use by a system function
- Online
- Allocated
- A TP device
- The only active console in the system
- A coupling facility.

To remove the last path to all other devices, use the CONFIG command without the UNCOND or FORCE parameters.

OFFLINE,UNCOND

The system is to take the specified channel path(s) offline, even if it is the last path to a device. The system rejects this command if it would remove the last path to a device that is:

- In use by a system function
- Allocated
- A TP device
- The only active console in the system
- A coupling facility in use by an active XES connection on the system from which the CONFIG command is issued. (Structures in the coupling facility can be in use, persistent, or have failed-persistent connectors.)

Use OFFLINE,UNCOND to remove the last path to an unallocated online device. You cannot do this by specifying OFFLINE alone.

OFFLINE, FORCE

Attention: FORCE is a very powerful option. Never specify FORCE unless you understand all its consequences for your system.

CONFIG command

| The system is to take the specified channel path or paths offline, even if a
| prior CONFIG CHP or VARY PATH command or a dynamic I/O process
| has not completed.

The system is to take the specified channel path or paths offline, even if it is the last path to a device. The system rejects this command if it would remove the last path to a device that is:

- The only active console in the system

The last path to all other devices listed in the OFFLINE,UNCOND option can be removed by the OFFLINE,FORCE option

| For coupling facility CHPIDs, the OFFLINE,FORCE option should only be
| used when configuring the last path to the coupling facility offline for the
| purpose of removing the coupling facility from the current configuration.

Responding to the FORCE option for non-coupling facility channel paths:

| Note that some of the messages described here might not appear if a
| CONFIG CHP(xx),OFFLINE,FORCE command executes concurrently with
| another command or process that takes paths offline.

| If last-path considerations do not apply to any devices, message IEE080D
| asks whether to continue with offline processing for the channel path.

| Reply NO to leave the channel path online.

| Reply YES to take the channel path offline.

| If last-path considerations do apply, message IEE100E lists any devices that
| are affected by the OFFLINE,FORCE options. The following message then
| asks you to confirm the FORCE option:

```
IEE131D REPLY 'CANCEL' OR 'CONTINUE'
```

Reply CANCEL to leave the channel path and devices online. Reply CONTINUE if you want to remove the channel path. After you reply CONTINUE, the following message appears:

```
IEE507D SHOULD ACTIVE DEVICES HAVE I/O TERMINATED?  
      REPLY NO OR YES
```

Reply NO to leave the affected devices online and allocated.

If you specify NO to message IEE507D, the channel path will NOT be configured offline.

Reply YES to have the system stop all I/O in progress on the affected devices, permanently reject all future I/O requests to the devices, and mark the affected devices pending-offline.

If you specify YES to message IEE507D, further system action depends on whether or not there are reserved devices on the channel path you want to take offline:

- If there are no reserved devices on the channel path, the system takes the channel path offline when it stops I/O on the devices.

- If there are reserved devices on the channel path for which there are no alternate paths, you get the following messages after you reply YES to message IEE507D:

```
IEE508E NO ALTERNATE PATHS TO RESERVED
                DEVICES ddd [,ddd]...
IEE131D REPLY 'CANCEL' OR 'CONTINUE'
```

If you do not want to lose I/O on reserved devices, reply CANCEL to terminate the CONFIG command and leave the channel path and devices online. Reply CONTINUE to have the system continue to remove the channel path. After you reply CONTINUE, message IOS062E is issued. All the processors for this image enter a restartable disabled wait (WAIT062) state.

The IOS062E message asks you to stop all systems sharing the reserved devices so the system can reserve the devices again, if possible, through alternate paths. If the system cannot find alternate paths, it stops I/O in progress on the devices, rejects any future I/O requests to the devices as permanent I/O errors, and marks the devices pending-offline.

Once the system has been restarted from the wait state, recovery for the channel path will be started and completed. Then, message IOS201E will inform you to start the processors stopped when message IOS062E was issued.

Generally, when CONFIG CHP OFFLINE,FORCE causes the system to take a device offline, you can bring the device back online by bringing online a channel path that provides a path to the device. Once it is back online, the device is again available for allocation. However, if the device was reserved when the system took it offline with the channel path, to bring the device back online and make it again available for allocation, you must provide a path to the device with a CONFIG CHP command and issue a VARY device ONLINE command.

Responding to the FORCE option for a coupling facility:

Note that messages IXL126I and IXL127I might not appear if a CONFIG CHP OFFLINE,FORCE is issued for a coupling facility CHPID while another CONFIG CHP or dynamic activate is still processing coupling facility CHPIDs and has not completed.

Message IXL126I identifies the coupling facility that is affected by the OFFLINE,FORCE option. The following message then asks you to confirm the FORCE option:

```
IXL127A REPLY CANCEL OR
CONTINUE
```

Reply CANCEL to leave the coupling facility online. Reply CONTINUE if you want to remove the coupling facility.

PFID

The system is to configure the specified list of PCIE function identifiers (PFID) online or offline.

(xxxx)

A single PFID identified by xxxx. The PFID may have a hexadecimal value from 0 to X'FFFF'.

CONFIG command

(aaaa-bbbb)

A range of PFIDs. The starting and ending PFIDs may have values from 0 to X'FFFF'.

(list)

One or more single PFIDs, ranges of PFIDs, or a combination of single PFIDs and ranges of PFIDs.

ONLINE or ON

The system is to bring the specified PFID or PFIDs online.

OFFLINE or OFF

The system is to take the specified PFID or PFIDs offline. If a PFID is currently in-use, the CF PFID OFFLINE command for that device fails.

OFFLINE, FORCE

Attention: FORCE is a very powerful option. Never specify FORCE unless you understand all its consequences for your system.

The system is to take the specified PFID or PFIDs offline. If a PFID is currently in-use, the CF PFID OFFLINE command for that device fails. If OFFLINE, FORCE is specified, the PFID is reconfigured offline unconditionally.

Examples

Example 1:

To take processor 2 offline, enter:

```
cf cpu(2),offline
```

Example 2:

To bring online a storage range from real addresses four to eight megabytes, enter:

```
cf stor(4m-8m),on
```

Example 3:

To take storage element 0 offline, enter:

```
cf stor(e=0),offline
```

Example 4:

To bring channel paths 4-9 and 12 online, enter:

```
cf chp(4-9,12),online
```

Example 5:

To take channel paths 0-6 offline, even though one might be the last path to an unallocated online device, enter:

```
cf chp(00-06),offline,uncond
```

Example 6:

To bring all channel paths associated with side 1 online, enter:

```
cf chp(all,1),online
```

Example 7:

CHP(01) is associated with devices 223 and 224. To correct an error condition, CHP(01) was configured offline to the system. Problem analysis determined that device 224 has a hardware problem that cannot be immediately corrected. This example shows how to configure CHP(01) online without bringing the path to device 224 online.

To display status for devices 223 and 224 before configuring CHP(01) online, issue the following commands:

```
d m=dev(223)
d m=dev(224)
```

The output, which shows that the paths to the devices are not online and not operational, appears as follows:

```
IEE174I 09.05.00 DISPLAY M 197
DEVICE 0223 STATUS=OFFLINE
CHP      01
PATH ONLINE      N
CHP PHYSICALLY ONLINE N
PATH OPERATIONAL  N

IEE174I 09.05.30 DISPLAY M 200
DEVICE 0224 STATUS=OFFLINE
CHP      01
PATH ONLINE      N
CHP PHYSICALLY ONLINE N
PATH OPERATIONAL  N
```

To configure channel path 01 online without bringing online the paths to devices 223 and 224, issue the following command:

```
cf chp(1),online,novary
```

The system issues the following messages to indicate that not all paths were brought online:

```
IEE754I NOT ALL PATHS BROUGHT ONLINE WITH CHP(01)
IEE502I CHP(1),ONLINE
IEE712I CONFIG PROCESSING COMPLETE
```

To display the status of each device after configuring the channel path online, issue the following commands:

```
d m=dev(223)
d m=dev(224)
```

The output, which shows that the paths to the devices are not online but are operational, appears as follows:

```
IEE174I 09.05.40 DISPLAY M 200
DEVICE 0223 STATUS=OFFLINE
CHP      01
PATH ONLINE      N
CHP PHYSICALLY ONLINE Y
PATH OPERATIONAL  Y

IEE174I 09.05.50 DISPLAY M 200
DEVICE 0224 STATUS=OFFLINE
CHP      01
PATH ONLINE      N
CHP PHYSICALLY ONLINE Y
PATH OPERATIONAL  Y
```

CONFIG command

To vary the path online for device 223, issue the following command:

```
vary path(223,01),online
```

To display the status of devices 223 and 224 after varying the channel path online, issue the following commands:

```
d m=dev(223)
```

```
d m=dev(224)
```

The output, which shows that only the path to device 223 is online and operational, appears as follows:

```
IEE174I 09.05.55 DISPLAY M 200
DEVICE 0223 STATUS=ONLINE
CHP          01
PATH ONLINE  Y
CHP PHYSICALLY ONLINE Y
PATH OPERATIONAL Y

IEE174I 09.05.59 DISPLAY M 200
DEVICE 0224 STATUS=OFFLINE
CHP          01
PATH ONLINE  N
CHP PHYSICALLY ONLINE Y
PATH OPERATIONAL Y
```

Example 8:

To reconfigure PFID 99 online, issue the following command:

```
cf pfid(99),online
```

The resulting messages are:

```
I
IQP034I PCIE FUNCTION 00000099 ONLINE.
PCIE DEVICE TYPE NAME = (10GbE RoCE          ).
IEE504I PFID(99),ONLINE
IEE712I CONFIG PROCESSING COMPLETE
```

Confirmation message IEE504I is displayed. If PFID 99 was initially offline, message IQP034I is also written to the system console (which may not be the same console as the operator console that issued the CF command). If PFID 99 was initially online, message IQP034I is not written.

Example 9:

To reconfigure PFIDs 14 - 15 and 9A offline, issue the following command:

```
cf pfid(14-15,9A),offline
```

The resulting messages are:

```
I
IQP034I PCIE FUNCTION 0000009A OFFLINE.
PCIE DEVICE TYPE NAME = (10GbE RoCE          ).
IEE148I PFID(14) NOT RECONFIGURED - PCI FUNCTION CURRENTLY IN-USE
IEE148I PFID(15) NOT RECONFIGURED - ITEM NOT AVAILABLE
IEE505I PFID(9A),OFFLINE
IEE712I CONFIG PROCESSING COMPLETE
```

Notice that PFID 14 was not reconfigured offline because it is currently in-use. PFID 15 was not reconfigured offline because it is not an available resource to the system. Only PFID 9A was reconfigured offline because it had been currently

online and not in-use. Message IQP034I is also written to the system console (which may not be the same console as the operator console that issued the CF command).

Example 10:

To reconfigure PFID 14 offline option FORCE, issue the following command:

```
cf pfid(14),offline,force
```

The resulting messages are:

```
I IQP034I PCIE FUNCTION 00000014 NOT AVAILABLE FOR USE.
  PCIE DEVICE TYPE NAME = (Hardware Accelerator).
I IQP034I PCIE FUNCTION 00000014 AVAILABLE FOR CONFIGURATION.
  PCIE DEVICE TYPE NAME = (Hardware Accelerator).
IEE505I PFID(14),OFFLINE
IEE712I CONFIG PROCESSING COMPLETE
```

Because PFID 14 is currently in-use, the OFFLINE,FORCE option must be used to deconfigure it. Two IQP034I messages are then issued. The first IQP034I message indicates the termination of the current in-use instance of the PFID, and the second IQP034I message indicates that the PFID is now available in the STANDBY (or OFFLINE) status and ready to be configured online.

Reconfiguring the system with a CONFIGxx parmlib member

Use the CONFIG MEMBER command when you want the system to use options in a CONFIGxx parmlib member to change the online or offline status of available processors, storage sections, PCIE function identifiers (PFIDs), and channel paths. See *z/OS MVS Initialization and Tuning Reference* for detailed information on the syntax and contents of the CONFIGxx parmlib member.

```
CF MEMBER[={member-id|(member-id)}]
```

The parameters are:

MEMBER

The system is to use a CONFIGxx parmlib member to reconfigure available processors, storage sections, PCIE function identifiers (PFIDs), and channel paths.

member-id

The identifier *xx* of the CONFIGxx member you want the system to use to reconfigure the available processors, storage sections, PCIE function identifiers (PFIDs), and channel paths. This identifier may be any two alphanumeric characters. If you do not specify *=member-id* or *(member-id)*, the default member is CONFIG00.

Example:

To reconfigure available processors, central storage, PCIE function identifiers (PFIDs), and channel paths in the system to match the options in the CONFIGT3 parmlib member, enter:

```
cf member(t3)
```

Reconfiguring the system in response to a configuration display

Use the following form of the CONFIG command before making any changes to the system configuration, or to display the processors, Integrated Cryptographic Features (ICRFs) attached to the processors, total amount of storage, channel paths available to the system, PCIE function identifiers (PFIDs) available, and the online or offline status of each channel path. (To obtain more information on storage, use the DISPLAY M command.)

In response to this command, the system issues messages IEE521I and IEE522D. Message IEE521I displays the reconfigurable resources available to the system, including processors, ICRFs attached to the processors, total amount of central storage, central storage elements, PCIE function identifiers (PFIDs), and channel paths. If your processor complex is partitioned, message IEE521I contains this information for one side. Respond to message IEE522D with the processors, total amount of central storage, PCIE function identifiers (PFIDs), as well as channel paths you want to bring online or take offline.

If the system is unable to display the resources available to the system, message IEE521I indicates that the command was unsuccessful.

```
CF {ONLINE|ON } [,L={a|name|name-a}]
   {OFFLINE|OFF}
```

ONLINE or ON

The system is to display the system configuration so that you can decide which processors, ICRFs attached to the processors, central storage elements, PCIE function identifiers (PFIDs), and channel paths you want to bring online. The system brings online the processors, ICRFs attached to the processors, storage elements, PCIE function identifiers (PFIDs), and channel paths you specify in response to message IEE522D. If an ICRF is attached to a processor that is being brought online and the Integrated Cryptographic Service Facility/MVS (ICSF/MVS) is active, the system brings the ICRF online.

OFFLINE or OFF

The system is to display the system configuration so that you can decide which processors, ICRFs attached to the processors, central storage elements, PCIE function identifiers (PFIDs), and channel paths you want to take offline. The system takes offline the processors, ICRFs attached to the processors, storage elements, PCIE function identifiers (PFIDs), and channel paths you specify in response to message IEE522D. If an ICRF is attached to a processor that is being taken offline and the ICSF/MVS is active, the system takes the ICRF offline.

L=a, name or name-a

The display area where the system is to display the system configuration. You can specify the display area (*a*), console name (*name*), or both (*name-a*). If you do not specify this option, the system displays the system configuration in the first available display or message area of the console on which you entered the command.

Example 1:

To check the channel paths available to the system before bringing any online, enter:

```
cf online
```

When message IEE522D appears after the configuration display message, IEE521I, reply with the channel paths you want to bring online.

Example 2:

To check the available processors, central storage elements, PCIE function identifiers (PFIDs), and channel paths in the system and the online or offline status of each, enter:

```
cf offline      or      cf online
```

When message IEE522D appears after the configuration display message IEE521I, reply with NONE.

CONTROL command

Use the CONTROL command to control the screen display of MCS, HMCS and SMCS consoles. Table 21 summarizes the information that the CONTROL command provides. Use it to access the pages on which you can find details about a particular use of the CONTROL command.

Table 21. Summary of the CONTROL Command

Command:	Topic:
CONTROL A	"Changing out of line display area specifications" on page 219
CONTROL C	"Deleting retained action messages" on page 219
CONTROL C,D	"Halting the printing or the display of a status display" on page 221
CONTROL D	"Controlling displays in areas" on page 221
CONTROL E	"Removing information from the screen" on page 222
CONTROL M,AMRF	"Activating, deactivating, or displaying the status of the action message retention facility" on page 224
CONTROL M,APPLID	"Setting the APPLID of the system" on page 229
CONTROL M,GENERIC	"Setting or turning off the VTAM generic resource name for SMCS" on page 229
CONTROL M,LOGLIM	"Changing or displaying the number of allowed WTL SYSLOG buffers" on page 224
CONTROL M,MLIM	"Changing or displaying the number of allowed WTO and WTOR message buffers" on page 225
CONTROL M,ROUETIME	"Changing the time the system waits for ROUTE command responses" on page 226
CONTROL M,RMAX	"Increasing the maximum number of reply IDs" on page 227
CONTROL M,UEXIT	"Changing or displaying the status of WTO installation exit IEAVMXIT" on page 227
CONTROL N,PFK	"Changing a PFK definition" on page 230
CONTROL Q	"Deleting message queues" on page 232
CONTROL S	"Changing or displaying message deletion and format specifications" on page 233
CONTROL V	"Changing the operating mode of a console" on page 237

CONTROL command

The following CONTROL commands have no effect on extended MCS consoles or on system consoles, and are not valid for managing these consoles:

- K A
- K C,D
- K D
- K E
- K N,PFK
- K Q
- K S
 - CON=
 - SEG=
 - DEL=
 - RNUM=
 - RTME=
- K V,USE

Many of the functions of the CONTROL command are controlled at IPL by parameters in the CONSOLxx parmlib member. Accompanying the descriptions of some operands on the CONTROL command are the corresponding parameters in CONSOLxx. If you need more information about the parameters in CONSOLxx, see *z/OS MVS Planning: Operations* and *z/OS MVS Initialization and Tuning Reference*. See “Defining and changing console characteristics” on page 120 for more information about using the CONTROL command.

Scope in a sysplex

The following table describes the conditions under which the CONTROL command has sysplex scope. See “Using commands that have sysplex scope” on page 12 for an explanation of sysplex scope. If a command has *All* under “Conditions”, then the command has sysplex scope under all circumstances and for all variations.

Table 22. Sysplex Scope for CONTROL Command

Command	Conditions
CONTROL C,A	All
CONTROL C,D	Has sysplex scope only when you specify L=.
CONTROL M	Has sysplex scope only when you do not specify MLIM, UEXIT, LOGLIM, or APPLID.
CONTROL <i>other</i>	Other parameters of CONTROL have sysplex scope only when you specify L=.

Syntax

The syntax for each of the many variations of the CONTROL command is shown immediately preceding its respective parameter list.

CONTROL or K

Changing out of line display area specifications

Use the CONTROL A command to change, remove, or examine out of line display area specifications for any MCS, HMCS or SMCS console in the system.

The AREA parameter on the CONSOLE statement in the CONSOLxx parmlib member controls the display area specifications at IPL. *z/OS MVS Planning: Operations* shows the maximum message area sizes for all devices that MVS supports as consoles and the defaults for the AREA parameter.

```
K A[,nn[,nn]...] [,L={name  }]
      |,NONE
      |,REF
```

A The display area specifications are to be altered or referenced.

nn[,nn]...

The number of message lines in each display area. The first number (*nn*) defines the bottom area of the screen; additional numbers (*,nn*) define areas working toward the top of the screen. The minimum number of lines in one display area is 4, the maximum is 99. The total number of all specified lines cannot exceed the number of lines in the message area of the screen. The maximum number of display areas that you can define is 11.

NONE

All out-of-line display area specifications will be removed for the specified console.

REF

Displays, in the command input area, the size of out-of-line display areas for the specified console. For example, if you enter K A,REF in the command input area, and the size of the display area is 14, the system displays K A,14 in the command input area.

L= name

The MCS, HMCS or SMCS console whose display area is to be changed or referenced. If this operand is omitted, the console on which K A is entered is assumed.

Example:

To define two display areas of 4 and 6 lines respectively, enter:

```
K A,4,6
```

Note: The CONTROL A command has no effect on extended MCS consoles or on system consoles and is not valid for managing these consoles.

Deleting retained action messages

Use the CONTROL C command to delete the outstanding action messages that the action message retention facility (AMRF) has retained.

```
K C,{A|I|E|CE},{id|id-id[,id|id-id]...}
```

The parameters are:

C The system is to delete one or more action messages that AMRF has retained.

CONTROL command

- A** The system is to delete one or more outstanding retained action messages in any of the following categories:
- immediate action (descriptor code 1 or 2)
 - eventual action (descriptor code 3)
 - critical eventual action (descriptor code 11).

These messages are identified by number in response to the DISPLAY R,LIST command.

- I** The system is to delete one or more outstanding immediate action messages (descriptor code 1 or 2). These messages are identified by number in response to the DISPLAY R,I command.
- E** The system is to delete one or more outstanding eventual action messages (descriptor code 3). These messages are identified by number in response to the DISPLAY R,E command.
- CE** The system is to delete one or more outstanding critical eventual action messages (descriptor code 11). These messages are identified by number in response to the DISPLAY R,CE command.
- id** The one-to-ten-digit decimal message identification number of the message to be deleted. This number is listed in response to the DISPLAY R command (message IEE112I).

id-id

The one-to-ten-digit decimal message identification numbers of the beginning and end of a range of messages to be deleted. The ending number must be greater than or equal to the beginning number.

When a range of numbers is specified, all retained immediate action, eventual action and/or critical eventual action messages with identification numbers in the specified range are deleted.

Example 1:

To delete a range of immediate action, eventual action, and critical eventual action messages that have been retained with identification numbers from 0 to 110, enter:

```
CONTROL C,A,0-110
```

Example 2:

Assume you have completed the requested action for three eventual action messages, but the messages remain marked as outstanding. Use the DISPLAY R,E command to get the identification numbers of the three messages (id1, id2, and id3) and then use K C,E to delete the three messages.

```
DISPLAY R,E  
K C,E,id1,id2,id3
```

Example 3:

Assume you have performed the requested immediate action, but the message is still marked as outstanding. Use the DISPLAY R,I command to obtain the message identification number and then issue CONTROL C,I to delete the message.

```
DISPLAY R,I  
CONTROL C,I,id
```

Note:

1. Specifying a large range of message identification numbers (more than 1000) can result in system resources being held and performance being impaired.
2. When you delete retained messages, the requests relating to them may still be outstanding.
3. When you specify a range, certain conditions are not flagged as errors that would be errors if individual identification numbers were specified. For example, nonexistent message identification numbers that fall within the range do not cause an error message. If you specify a nonexistent identification number by itself, you receive an error message.

Halting the printing or the display of a status display

Use the CONTROL C,D command to halt the printing or display of the status:

- On a printer console that is not the hardcopy medium
- On a display console that does not have display areas

The CONTROL C,D command must be entered while the system is displaying or printing the display.

```
K C,D,id[,L={a|name|name-a}]
```

The parameters are:

C,D

The inline display, indicated by the *id* operand, is to be stopped. This command is only valid on an MCS, HMCS or SMCS console.

id The three-digit identification number of the status display you want to stop. The identification number appears in the first line of the display.

L=a, name, or name-a

The name of the active MCS, HMCS or SMCS console where the status display is to be stopped. If you do not specify the L= operand, then the K C,D,id command applies to the console from which the command is issued.

Example 1:

To stop the status display, identification number 121, which is in progress in the general message area of console CON21, enter:

```
k c,d,121,L=CON21
```

Note: The CONTROL C,D command has no effect on extended MCS consoles or on system consoles and is not valid for managing these consoles.

Controlling displays in areas

Use the CONTROL D command to control displays, message numbering, and the PFK display line.

```
K D[,N[,HOLD] ]
  |F[,L={a|name-a}]
  |,PFK
```

The parameters are:

CONTROL command

- D** Control what or how information is to be displayed on the screen. This command is only valid for MCS, HMCS and SMCS display consoles.
- N** Messages on the screen are to be consecutively numbered. The operator uses these numbers as references to delete messages from the screen using the K E,nn command. (For very large screen sizes the K D,N command will only number the first 99 rows on the screen. All subsequent lines will contain AA in the number field.) The numbers are removed from the screen when the operator deletes a message or performs a cancel action. (The K E,nn command cannot delete messages after line 99 on the screen.) This option is not valid when:

- The console is in wrap mode; the system issues message IEE290I.
- The console is in roll or roll-deletable mode; the system issues message IEE158I.

HOLD

In conjunction with the N operand, HOLD specifies that the system display consecutive numbers for each message on the screen and renumber messages after each message deletion that the operator performs.

- F** The next frame of a status display is to be displayed. When you do not specify an area, the oldest area on the screen is scrolled. This option is not valid when there is no status display on the console; the system issues message IEE158I.

L=*a* or *name-a*

Specifies the display area (*a*), console name (*name*), or both (*name-a*) where the display will appear.

PFK

Specifies that the numbers of the program function keys (PFKs) designated for command entry are to be displayed in the PFK display line. This operand applies only to display consoles that have the PFK function and support the PFK display line (for example, 3277-2).

Example:

To display the next frame of a status display, enter:

```
k d,f
```

Note: The CONTROL D command has no effect on extended MCS consoles or on system consoles and is not valid for managing these consoles.

Removing information from the screen

Use the CONTROL E command to remove various types of messages from the screen or to cause message numbers to be deleted.

```
K E[ ,nn          ]
    | ,nn,nn
    | ,SEG
    | ,F
    | ,N
    | ,PFK
    | ,D[ ,L={a|name|name-a}]
```

The parameters are:

E Messages are to be removed from the screen.

nn The system is to remove a single (*nn*) message or a range (*nn,nn*) of deletable messages from the screen. The value of *nn* must be a decimal number from 01 to 99. The **K E,nn** command cannot delete messages after line 99 on very large screen sizes. A deletable message is any message that is either a **WTOR** or a **WTO** message issued without descriptor code 1, 2, 3, or 11.

Note: Do not use this command to try to remove a range of non-deletable messages; you can remove only one non-deletable message at a time.

SEG

Deletable messages in the predefined message segment are to be removed from the screen. A deletable message is any message that is either a **WTOR** or a **WTO** message issued with descriptor code 1,2,3, or 11.

F All flagged messages (messages marked with a vertical or horizontal bar in position 3) are to be removed from the screen.

N Removes the numbers preceding the messages displayed on the screen. The messages on the screen were consecutively numbered by the **K D** command.

D Specifies that a status display is to be deleted.

L=*a*, *name*, or *name-a*

For the **D** operand, specifies where the specified action is to take place. You can specify the display area by area (*a*), console name (*name*), or both (*name-a*). When this keyword is not specified, the oldest area on the screen is deleted.

PFK

Specifies that the numbers are to be erased from the program function key (PFK) display line. This operand applies only to display consoles that have the PFK function and support the PFK display line (for example, 3277-2); the system issues message IEE158I for all other consoles.

Example 1:

To delete the message at line 10, which appears on the screen as follows:

```
10 IEE334I HALT EOD SUCCESSFUL
```

enter:

```
K E,10
```

Example 2:

To delete the non-action messages from a segment of messages, enter:

```
K E,SEG or K E
```

Example 3:

To delete the non-action messages on lines 4-10, enter:

```
K E,4,10
```

Example 4:

CONTROL command

To delete all flagged messages (messages marked with a vertical or horizontal bar in position 3), enter:

```
K E,F
```

Note: The CONTROL E command has no effect on extended MCS consoles or on system consoles and is not valid for managing these consoles.

Activating, deactivating, or displaying the status of the action message retention facility

Use the CONTROL M,AMRF command to change or display the status of the action message retention facility. You can enter the command from a console with master authority.

The AMRF parameter on the INIT statement in the CONSOLxx parmlib member controls whether or not the system starts the action message retention facility at IPL. If the AMRF parameter is not coded, the action message retention facility is active. Use the CONTROL M command to stop or restart the facility once the system is active.

The syntax of the command is as follows:

```
K M[,AMRF={Y|N}]  
|,REF
```

The parameters are:

M Indicates message processing by the message retention facility.

AMRF=

The status of the action message retention facility is to be modified for all systems in the sysplex.

Y The action message retention facility is to become active.

N The action message retention facility is to be deactivated.

REF

Displays the current values of all the operands on the K M command.

Example:

To activate the action message retention facility, enter:

```
K M,AMRF=Y
```

Changing or displaying the number of allowed WTL SYSLOG buffers

Use the CONTROL M,LOGLIM command to change or display the number of allowed WTL (write-to-log) SYSLOG buffers. You can enter the command from consoles with master authority.

The LOGLIM parameter on the INIT statement in the CONSOLxx parmlib member controls the number of WTL buffers. If the LOGLIM parameter is not coded, the number of WTL buffers is 1000.

The syntax for the command is:

```
K M[,LOGLIM={nnnnn|0}]
|,REF
```

The parameters are:

M Indicates message processing by the message retention facility.

LOGLIM=nnnnnn

The maximum number of outstanding WTL requests that the system can hold in buffers on the system, where *nnnnnn* can be a decimal number from 1000 to 999999. The WTL buffers hold messages that the system has not yet presented to SYSLOG.

Note: When you set LOGLIM=999999, you allocate over 100 megabytes of ECSA storage for WTL SYSLOG buffer storage. Be careful that WTL SYSLOG buffer storage does not hamper your system's performance.

LOGLIM=0

All outstanding WTL buffer storage is freed by the system log task.

Note: Use this command value only at the direction of the system programmer. It results in the potential loss of messages sent to hard-copy.

REF

Displays the current values of all the operands on the K M command. Unless you specifically change it, the LOGLIM value that the system displays is the value that was specified on the INIT statement in CONSOLxx parmlib member.

Example:

To allow 4000 WTL message buffers, enter:

```
K M,LOGLIM=4000
```

Changing or displaying the number of allowed WTO and WTOR message buffers

Use the CONTROL M,MLIM command to change or display the number of allowed WTO (write-to-operator) or WTOR (write-to-operator-with-reply) message buffers. You can enter the command from consoles with master authority.

The MLIM and RLIM parameters on the INIT statement in the CONSOLxx parmlib member control the number of WTO and WTOR buffers. If the MLIM or RLIM parameters are not coded, the number of WTO buffers is 1500, and the number of WTOR buffers is 10.

The syntax for the command is:

```
K M[,REF|[,MLIM=nnnn][,RLIM=mmmm]]
```

The parameters are:

M Indicates message processing by the message retention facility.

MLIM=nnnn

The maximum number of WTO message buffers to be allowed in the system,

CONTROL command

where *nnnn* can be a decimal number from 20 to 9999. The WTO buffers hold the WTO messages that the system has not yet displayed at the eligible MCS, HMCS, and SMCS consoles in the sysplex.

RLIM=nnnn

The maximum number of outstanding WTOR messages that the system or sysplex can hold in buffers, where *nnnn* can be a decimal number from 5 to 9999. Each WTOR buffer holds a WTOR message that the system or sysplex has displayed and has not received a response to. The maximum upper limit is set by the RMAX keyword on the DEFAULT statement in CONSOLExx.

REF

Displays the current values of all the operands on the K M command.

Example:

Assuming RMAX is set to 9999: To allow the maximum number of WTO message buffers and WTOR message buffers, enter:

```
K M,MLIM=9999,RLIM=9999
```

Changing the time the system waits for ROUTE command responses

Use the CONTROL M,ROUTTIME command to display or change the maximum amount of time the ROUTE *ALL, ROUTE *systemgroupname*, or ROUTE *OTHER command waits for a response from each system in the sysplex before aggregating the responses. ROUTIME applies to any ROUTE command with the *ALL or *systemgroupname* operand when issued from any system in a sysplex.

The syntax of the command is as follows:

```
K M[,ROUTIME=nnn ]  
  |,REF
```

The parameters are:

ROUTIME=nnn

Dynamically changes the maximum number of seconds the ROUTE *ALL or ROUTE *systemgroupname* command waits for command responses from each system before aggregating the responses. (If not specified in CONSOLxx, the IBM-supplied default value is 30 seconds.) The *nnn* value is a decimal number from 0-999.

If *nnn* is zero, command responses are not aggregated. The change applies across the sysplex, and affects ROUTE commands issued after the CONTROL command is processed.

If the timeout value (T= operand) is specified on a ROUTE *ALL or ROUTE *systemgroupname* command, the value of the T= operand overrides the value then in effect on the system.

REF

Displays the current values of all the operands on the K M command.

Example 1:

To change the maximum amount of time ROUTE *ALL or ROUTE *systemgroupname* waits for command responses to 45 seconds, enter:

```
K M,ROUETIME=45
```

Example 2:

To display the maximum amount of time ROUTE *ALL or ROUTE *systemgroupname* waits for command responses, enter:

```
K M
```

Increasing the maximum number of reply IDs

Use the CONTROL M,RMAX command to display or dynamically increase the maximum number of reply IDs.

The syntax of the command is as follows:

```
K M[,RMAX=nnnn ]
    |,REF
```

The parameter is:

RMAX=nnnn

Dynamically increase the maximum number of reply IDs, where *nnnn* is a decimal number from 99 to 9999.

Note: The value for RMAX also determines the size of the reply ID displayed in the message text. For example, specifying an RMAX of 999 means that all WTOR messages have a 3-character reply ID.

You can increase the value of RMAX only in a system running in local mode or in a sysplex whose couple data set supports more than eight systems.

The new value of RMAX must be greater than the previous value of RMAX.

REF

Displays the current values of all the operands on the K M command.

Example:

To increase the maximum number of reply IDs to 200, enter:

```
K M,RMAX=200
```

Changing or displaying the status of WTO installation exit IEAVMXIT

Use the CONTROL M,UEXIT command to change or display the status of the WTO installation exit IEAVMXIT. This exit receives control when the system issues a WTO message unless your installation names another WTO installation exit routine for the message. To learn what messages are currently processed by IEAVMXIT, issue the DISPLAY MPF command.

The UEXIT parameter on the INIT statement in the CONSOLxx parmlib member controls whether IEAVMXIT is active at IPL. If the UEXIT parameter is not coded, IEAVMXIT will be activated, if it is installed. If IEAVMXIT is not installed, the system will IPL with UEXIT=N.

The syntax of the command is:

CONTROL command

```
K M[,UEXIT={Y|N}]  
    |,REF
```

The parameters are:

UEXIT=

The status of the general WTO installation exit IEAVMXIT is to be changed.

Y The general user exit routine IEAVMXIT is to become active. If IEAVMXIT is already active and you want a new copy, deactivate IEAVMXIT, refresh the library lookaside (LLA), and then reactivate IEAVMXIT.

N The general user exit routine IEAVMXIT is to become inactive.

REF

Displays the current values of all the operands on the K M command.

Example 1:

To activate the general WTO installation exit routine IEAVMXIT, enter:

```
K M,UEXIT=Y
```

Example 2:

To load a new copy of the general WTO installation-exit routine IEAVMXIT, first enter:

```
K M,UEXIT=N
```

to deactivate the current copy. Then enter:

```
MODIFY LLA,REFRESH
```

After you receive notification that the library lookaside (LLA) is refreshed, enter:

```
K M,UEXIT=Y
```

to activate the new copy.

Displaying the SMCS APPLID of the current system and VTAM generic resource name for SMCS

Use the CONTROL M,REF command to display the SMCS APPLID of the current system and VTAM generic resource name for SMCS.

If either of these values has been changed by a prior CONTROL M command, but SMCS has not yet been recycled using the VARY NET,INACT and VARY NET,ACT commands to deactivate and restart the SMCS application, CONTROL M will show the new APPLID and GENERIC, even though SMCS will be using the old APPLID and GENERIC. The DISPLAY CONSOLES,SMCS command can be used to display the APPLID and GENERIC in use on each system in the sysplex, as well as the APPLID and GENERIC set by the CONTROL M command.

If the system is in XCFLOCAL or MONOPLEX mode, the GENERIC keyword will not be displayed. If the system does not have an APPLID in effect, the APPLID keyword will not be displayed.

The syntax of the command is:

```
K M[,REF]
```

The parameters are:

REF

Displays the current values of all the operands on the K M command.

Setting the APPLID of the system

Use the CONTROL M,APPLID command to set the APPLID of the system where it is issued. If there is not an APPLID in effect on the system, either because an APPLID was not specified in CONSOLxx, or because the APPLID was invalid or in use by another system during this system's IPL, this command is rejected.

For the new APPLID to take effect, after issuing the CONTROL M command to change it, the VARY NET,INACT,ID=oldapplid[,I or ,F] command must be issued to deactivate SMCS, followed by the VARY NET,ACT,ID=newapplid command to activate SMCS using the new APPLID. This is sometimes referred to as "recycling the APPLID" or "recycling SMCS". Until SMCS is recycled, the old APPLID value is still in use. Message IEE821E is issued to reflect the need to recycle SMCS.

The syntax of the command is:

```
K M,APPLID=aaaaaaaa
```

The parameters are:

APPLID=aaaaaaaa

Sets the APPLID of the system where it is issued.

Value Range: Is from 2 to 8 characters. The first character must begin with the letters A through Z or with a #, \$, or @; the remaining characters can be A through Z, 0 through 9, or #, \$, or @.

Example:

Systems SY1 and SY2 are in a sysplex. System SY1 is using APPLID SMCS1, and SY2 is using APPLID SMCS2. To change SY1's APPLID to SMCSA, enter:

```
K M,APPLID=SMCSA
```

to change the APPLID. However, SY1 will continue to use SMCS1 as its APPLID until SMCS is recycled with the following commands:

```
VARY NET,INACT,ID=SMCS1,I
VARY NET,ACT,ID=SMCSA
```

Setting or turning off the VTAM generic resource name for SMCS

Use the CONTROL M,GENERIC command to set or turn off the VTAM generic resource name for SMCS in the sysplex.

If the system is in XCFLOCAL or MONOPLEX mode, this command is rejected.

For the updated GENERIC value to take effect, after issuing the CONTROL M command to change it, the VARY NET,INACT,ID=applid[,I or ,F] command must

CONTROL command

be issued to deactivate SMCS, followed by the VARY NET,ACT,ID=applid command to reactivate SMCS using the new GENERIC value. This is sometimes referred to as "recycling the APPLID" or "recycling SMCS". Each SMCS application in the sysplex will continue to use the old GENERIC value until it is recycled. It is not necessary to recycle all of the SMCS applications at the same time, however, this may result in some systems using the old value of GENERIC and others using the new value of GENERIC until all SMCS applications in the sysplex are recycled.

The syntax of the command is:

```
K M[,GENERIC={aaaaaaaa}]
      |{*NONE*}
```

The parameters are:

GENERIC=

aaaaaaaa

Sets the VTAM generic resource name for SMCS in the sysplex.

NONE

Turns off the VTAM generic resource name for SMCS in the sysplex.

Example:

Systems SY1 and SY2 are in a sysplex. System SY1 is using APPLID SMCS1, and SY2 is using APPLID SMCS2, and the current GENERIC is SMCSX. To change the GENERIC to ANYSMCS, on either SY1 or SY2, enter:

```
K M,GENERIC=ANYSMCS
```

SY1 and SY2 will continue to use SMCSX as the GENERIC until SMCS is recycled on each system. To recycle SMCS on SY1, issue the following commands:

```
VARY NET,INACT,ID=SMCS1,I
VARY NET,ACT,ID=SMCS1
```

To recycle SMCS on SY2, issue the following commands:

```
VARY NET,INACT,ID=SMCS2,I
VARY NET,ACT,ID=SMCS2
```

Changing a PFK definition

Use the CONTROL N,PFK command to change the definition of a PFK on a particular console or to assign a PFK table to a particular console. The set of commands associated with the PFKs on your console resides in a PFK table in a PFKTABxx parmlib member.

A PFK command that you assign to a PFK by using the CONTROL N,PFK command is not associated with the PFK when you bring the console online again. To have a command associated with a PFK when you bring a console online, it must be defined in the appropriate PFK table in PFKTABxx. See "Defining PFKs using the CONTROL command" on page 146.

Use the following form of the CONTROL command to define commands for program function keys (PFKs) or assign a PFK table.

```

K N,PFK={{(nn1{,CMD='text[;text]...'})[,CON={Y|N}] }
        { {,KEY=nn2[,nn2]... } }
        { }
        {nnnnnnnn[,L=name] }

```

The parameters are:

N,PFK

A PFK command definition is to be altered.

nn1

The number of the PFK being defined. The *nn1* value must be the number of a PFK designated for command entry at system installation

CMD

The text of one or more commands is to be associated with PFK *nn1*.

'text[;text]...'

The text of the operator's commands to be associated with PFK *nn1*. Up to 110 characters can be included within the quotation marks. If more than one command is to be associated with a PFK, the commands must be separated by a semicolon. Do not put a semicolon after the last command. Text characters can be entered in upper or lower case; the system converts all characters to uppercase. A command that must be entered lowercase, such as a reply to a WTOR, cannot be entered using the PFK command entry function.

Note: Text characters should not contain sensitive or secure data (such as passwords).

KEY

The commands associated with other PFKs are to be associated with *nn1*.

nn2[,nn2]...

The number(s) of the PFK whose commands are to be associated with PFK *nn1*. Up to 54 key numbers (numbers can be repeated) can be included in the list. Separate key numbers with a comma.

Note: You cannot nest the lists of keys. That is, a PFK defined as a list of PFKs cannot be included in a list of keys assigned to another PFK. For example, if PFK 5 is associated with a list of keys (such as KEY=3,4), and you attempt to associate PFK 6 with a list of keys that includes PFK 5 (such as KEY=1,2,5), the system rejects the request.

CON

Specifies whether conversational mode of command entry is in effect.

Y Conversational mode of command entry is to be in effect.

N Conversational mode of command entry is not to be in effect (non-conversational mode of command entry is to be in effect). If CON is not specified, CON=N is assumed.

nnnnnnnn

The name of the PFK table that contains the commands that define the PFKs for a console.

L=name

The console whose PFKs are to be defined by the PFK table you specify. The issuing console is the default.

CONTROL command

Example 1:

To associate a START GTF command with PFK 5, enter:

```
K N,PFK=(5,CMD='S GTF,285'),CON=N
```

Example 2:

To associate a START READER and a START WRITER command with PFK 5, enter:

```
K N,PFK=(5,CMD='S RDR,001;S XWTR,292'),CON=N
```

Example 3:

If PFK 3 is associated with commands S RDR,001 and S XWTR,292, and PFK 4 is associated with the command S GTF,MODE=INT,BUF=387,TIME=YES,DEBUG=YES, you can associate all three of these commands with PFK 5 by entering:

```
K N,PFK=(5,KEY=3,4),CON=Y
```

The commands associated with PFK 5 are now S RDR,001; S XWTR,292, and S GTF,MODE=INT,BUF=387,TIME=YES,DEBUG=YES, *in that order*.

Example 4:

To remove a definition previously set for PFK 5, leaving PFK 5 undefined, enter:

```
K N,PFK=(5,CMD='')
```

Example 5:

To assign the commands in the table PFK22 to cons8, enter:

```
K N,PFK=PFK22,L=CONS8
```

Note: The CONTROL N,PFK command has no effect on extended MCS consoles or on system consoles and is not valid for managing these consoles.

Deleting message queues

Use this command to delete messages that are queued to an MCS, HMCS or SMCS console. It affects only messages currently on the console's queue. Subsequent messages are queued as usual. This command is generally, though not exclusively, for use in error situations.

The command gives you more control over MCS, HMCS and SMCS console message queues. If there is a WTO buffer shortage, you can delete the messages to speed up console processing or alleviate storage problems. You might need to issue the command several times to clear the console of messages.

Note: This CONTROL command is not valid for extended MCS consoles or extended MCS console message queues.

The kinds of messages that are deleted are:

- Action messages.
- All in-line messages queued for a particular console.
- WTOR messages and unconditional messages.

The kinds of messages that are not deleted are:

- Out-of-line messages. You can delete these with K E,D.
- Messages queued to hardcopy (SYSLOG and/or OPERLOG).

The syntax is:

```
K Q[,L=name]
```

Q The CONTROL command is to delete a console's message queue.

L=name

The name of the console whose message queue is to be deleted. If this operand is omitted, the message queue of the console from which the K Q command is entered is deleted.

Example 1:

To delete any messages on the issuing full-capability console's queue, enter:

```
K Q
```

Example 2:

To delete messages queued on console CON2, enter:

```
K Q,L=CON2
```

Changing or displaying message deletion and format specifications

Use the CONTROL S command to change console specifications or to display the console specifications currently in effect. Any changes you make with the CONTROL S command do not exist when you IPL the system the next time.

The following parameters on the CONSOLE statement in the CONSOLxx parmlib member control, at IPL, the same console specifications as the CONTROL S command. The system defaults are:

CON(N)

Conversational or nonconversational mode

DEL(RD)

Message deletion mode

MFORM(M)

Format of messages

RNUM(5)

Maximum number of messages included in one message roll

RTME(2)

Number of seconds between message rolls

SEG Number of lines in the message area that the CONTROL E,SEG command deletes.

The complete syntax for the CONTROL S command is:

CONTROL command

```
K S[,REF] ]
    |
    | [,CON={Y|N}] [,SEG=nn] [,DEL={Y|N|R|RD|W}]
    | [,RNUM=nn] [,RTME=nnn] [,MFORM=(option[,option]...)]
    |
    | [,L=name]
```

S The current console specifications are to be temporarily altered or referenced.

CON=

Conversational message deletion is requested or canceled.

Y Requests conversational message deletion.

N Cancels conversational message deletion. (non-conversational message deletion is to go into effect).

Note: The CONTROL S,CON= command has no effect on extended MCS consoles or on system consoles and is not valid for managing these consoles.

REF

The current console specification values are to be displayed in the entry area in CONTROL command form.

SEG=nn

The size of the message segment is to be altered, where *nn* specifies the number of lines to include in the segment of messages deleted when a CONTROL E,SEG command is entered. The CONTROL S,SEG= command can accept a maximum value of 99 or the number of lines on the screen, whichever is smaller.

Note: The CONTROL S,SEG= command has no effect on extended MCS consoles or on system consoles and is not valid for managing these consoles.

DEL=

The message deletion mode is to be changed.

Y Automatic mode of message deletion is to go into effect. That is, all flagged messages are removed from the screen whenever the screen becomes full.

N Automatic mode of message deletion is canceled. Messages must be removed manually.

R Roll mode is to go into effect. That is, a specified number of messages (determined by *RNUM*) roll off the screen each specified interval (determined by *RTME*).

RD Roll-deletable mode of message deletion is to go into effect. That is, messages roll off as with roll mode, except that the action messages accumulate at the top of the screen.

W Wrap mode is to go into effect. When the screen is full, the next message overlays the message at the top of the screen and subsequent messages continue overlaying older messages down the screen. The separator line, with the same highlighting attribute as the warning line, moves with the new messages and includes the count of the undisplayed messages. WTORs and action messages are also overlaid.

Note: The CONTROL S,DEL= command has no effect on extended MCS consoles or on system consoles and is not valid for managing these consoles.

RNUM=nn

The number of lines in the message roll. The CONTROL S,RNUM=nn command can accept a value of *nn* from 1 to 99 (decimal) or the number of lines on the screen, whichever is smaller, as the number of lines in the message area.

Note: The CONTROL S,RNUM=nn command has no effect on extended MCS consoles or on system consoles and is not valid for managing these consoles.

RTME=nnn

The time interval in seconds between message rolls. The *nnn* value can be any decimal number from 1 to 999, 1/2, or 1/4. This time interval sets the MCS, HMCS and SMCS screen refresh rate. Messages will be displayed each *nnn* seconds in R, RD, and W modes.

Note:

1. The value for 3290 consoles should be 1 or higher.
2. The CONTROL S,RTME=nnn command has no effect on, and is not valid for managing, extended MCS consoles or system consoles.

MFORM=(option[,option]...)

The format of messages sent to a console is to be changed. You can control whether the text of each message (including those from JES2 and JES3) is accompanied by:

- a time stamp
- the name of the system that issues the message
- the jobname or job id of the issuer of the message

The format of a message that includes all MFORM options is:

Time stamp System name Jobname/id Message text

You can enter more than one of the options. If you do, place parentheses around the list of options and separate them with commas. The system displays the information that accompanies the message text in the order described, regardless of the order of the options you specify on the MFORM operand. *option* can be any of the following:

- T** Requests that each message appear with a time stamp.
- S** Requests that each message appear with the name of the system that sent the message.
- J** Requests that each message appear with the job name or job ID associated with this message.

Note: This value is initially the job name or ID of the issuer of the message, but either the issuer or subsystem code can change the value. For example, messages that JES issues often change the initial value from the JES name/id to that of the job the message is describing.

- M** Requests that the text of each message appear without a time stamp, the job name/job ID of its issuer, or the name of the system that sent the message. The text of the message is displayed whether or not you use this operand. At IPL, if the MFORM operand in the CONSOLxx parmlib member is not coded, the system displays the message text without time stamp, system name, or job name/ job id.

Note: **M** is the default MFORM option for extended MCS consoles. To change the default value for the extended MCS consoles use the RACF

CONTROL command

command, ALTUSER userid OPERPARM(MFORM(T,S,J,M,X)). See *z/OS Security Server RACF Command Language Reference* for more information. The default for MCS, HMCS and SMCS consoles can be changed with the CONTROL command.

- X Requests not to prefix messages flagged as exempt from sysname and jobname formatting with a sysname and jobname field when the S and/or J operands are specified. X does not affect the T operand.

L= name

The console this command is to affect. Before using the L operand, realize:

- You can specify this operand to change the specifications of another console only from a console with at least CONS command group authority.
- For *name*, you can specify the name of a full-capability console only from a console with master authority.
- For *name*, You cannot specify the name of a status display console.
- If you specify the name of a message stream console, you cannot specify DEL=Y or DEL=N, CON=N; if the name is for a non-display console, you cannot specify any operand other than MFORM.

Example 1:

To set SEG equal to 10 lines, enter:

```
K S,SEG=10
```

Example 2:

To cancel roll mode on console CON4, enter:

```
CONTROL S,DEL=N,L=CON4
```

In this case, you must delete messages manually.

Example 3:

To determine the current value of SEG, enter:

```
K S,REF or K S
```

Example 4:

To place a console in wrap mode, enter:

```
K S,DEL=W
```

Example 5:

To display all messages on the full-capability console named CON5 with time stamps and the job names/job IDs of their issuers, enter the following command from the console with master authority:

```
K S,MFORM=(M,T,J),L=CON5
```

Note:

1. The system displays the time stamps and the job names/job IDs in the order described earlier.
2. Whether or not you specify the option **M**, the system displays the text of the message.

Changing the operating mode of a console

Use the CONTROL V,USE command to change the operating mode of a console.

The USE parameter on the CONSOLE statement in the CONSOLxx parmlib member controls the operating mode of a console at IPL. If the USE parameter is not coded and the console is a display console, the console's operating mode is full-capability. Use the K V,USE command to change the operating mode for MCS consoles. You cannot change the operating mode for HMCS, SMCS or extended MCS consoles.

The syntax for the CONTROL V command is:

```
K V[,REF                               ],L=name ]
    |,USE={FC|SD|MS}[,CMDSYS={sysname|*}]
```

The parameters are:

USE=

The operating mode of a console is to be changed.

FC The console is to be changed to full-capability mode (input/output capability).

SD The console is to be changed to output-only for presentation of status displays.

MS The console is to be changed to output-only for presentation of messages other than status displays.

Note:

1. If you issue the VARY command to take the console offline and then bring the console online, the console will resume the operating mode in effect when the console was taken offline.
2. K V USE=SD and K V USE=MS operating modes are not valid for HMCS or SMCS consoles.

REF

Displays the current value of the CONTROL V,USE operand.

CMDSYS

Indicates the system where all commands will be sent for processing.

sysname

The system where all commands are to be sent. If this keyword is not specified or is incorrect, the commands are processed on the system where you issue the command.

- * The system where you issue the command.

L= *name*

The name of the console where the specified action is to take place.

Note: The CONTROL V,USE command has no effect on extended MCS consoles or on system consoles and is not valid for managing these consoles.

Example:

CONTROL command

To direct all commands issued from this console to processor SY2, enter:

```
K V,CMDSYS=SY2
```

Selecting the message levels for a console

Use the CONTROL V,LEVEL command to specify the message levels for messages that are to be displayed at a console.

The LEVEL parameter on the CONSOLE statement in the CONSOLxx parmlib member controls the message levels for the console at IPL. If the LEVEL parameter is not coded, the system sends all messages, including broadcast messages, to the console.

The syntax for the command is:

```
K V[,REF                ][,L=name  ]  
    |,LEVEL=(type[,type]...)
```

The parameters are:

LEVEL=(type[, type]...)

The message levels for a console are to be changed. The following operands specify which messages are to be displayed at the console. You can enter more than one of the following operands. If you do, place parentheses around the list of operands and separate them with commas. *type* can be any of the following:

ALL The system is to display all messages routed to the console, including broadcast messages.

ALL,NB

The system is to display all messages routed to the console, except for broadcast messages.

CE Critical eventual action messages (descriptor code 11) are to be displayed

E Eventual action messages (descriptor code 3) are to be displayed

I Immediate action messages (descriptor codes 1 and 2) are to be displayed

IN Informational messages are to be displayed

NB Broadcast messages are **not** to be displayed.

R Write-to-operator with reply (WTOR) messages are to be displayed.

UNCOND

The system is to execute this command even though it means broadcast and informational messages with certain routing codes will not be assigned to any console. Use this operand if you want broadcast and certain informational messages to be sent only to the hardcopy medium.

Note:

1. If you don't specify NB, your console receives broadcast messages.

2. If a WTOR or action message is not directed to any console, the message is logged. It can be retrieved and displayed at a console using the DISPLAY REQUESTS command.
3. If a message is directed to a specific console, it appears there regardless of the message level of the console.
4. If you specify a second K V,LEVEL command, the K V,LEVEL command in effect is canceled.
5. If you specify only one message type on the LEVEL operand, you can omit the parentheses.

REF

Displays the current value of the CONTROL V,LEVEL operand.

L= name

The name of the console where the specified action is to take place. The issuing console is the default.

Example 1:

To route only informational and broadcast messages to console CON20, enter:

```
K V,LEVEL=IN,L=CON20
```

Example 2:

To route WTOR, immediate action, and broadcast messages to the issuing console, enter:

```
K V,LEVEL=(R,I)
```

Example 3:

To route all messages except broadcast messages to the issuing console, enter:

```
K V,LEVEL=(ALL,NB)
```

DEVSERV command

Use the DEVSERV command to request a display of the status of DASD and tape devices. The response is a display of basic status information about a device, a group of devices, or storage control units, and optionally can include a broad range of additional information. You can display:

- Device number
- Device type
- Logical mode of the device
- Number of data sets allocated on the volume
- Volume serial label
- Channel path ID
- Status of the path
- Status of an SMS-managed device
 - Volume status
 - Storage group name
 - Storage group status
- Control unit type and model
- Control unit serial number

DEVSERV command

- Device capacity, in cylinders
- Device extended function status
- Unit control block (UCB) device type information
- Help text, when you request it
- The following, if the device belongs to the DASD storage subsystem:
 - Real device type (if what is shown is an emulated device type)
 - Control unit type and model (or emulated control unit type and model if the real and emulated control units are not the same)
 - Subsystem ID for this storage subsystem
 - Cache fast write state
 - Track caching state
 - DASD fast write state
 - State of pinned data
 - State of dual copy, PPRC, or SPARing -- if there is any
 - Address of the other device in a dual copy pair
 - Channel subsystem device address
 - Subsystem internal logical device address
 - An indication if the device extended function status information is inconsistent between MVS control blocks and the storage subsystem
 - An indication if the defined (UCB) device type is inconsistent with the real device type
 - Optionally, the total number of cylinders for each unique track format (3380 and 3390) for all of the devices within the scope of the request
- The following, if the device belongs to a tape library:
 - Device type equivalent to DTYPE from the DS P command
 - Device status indicating online / offline and ready / not ready
 - Device type and model
 - Device serial number
 - Library identification number
 - An indication if the defined (UCB) device type is inconsistent with the real device type

You can also use several options of the DEVSERV command:

- You can compare the DEVSERV PATHS command with the DISPLAY U and DISPLAY M commands by referring to “Displaying the status of devices and availability of paths” on page 11.
- “Using the DEVSERV QDASD option”
- “Using the DEVSERV QTAPE option” on page 241
- “Using the DEVSERV QPAVS option” on page 241
- “Using the DEVSERV QLIB option” on page 241

Using the DEVSERV QDASD option

Use the QDASD option of the DEVSERV command to validate MVS storage resident control blocks for extended function status with data acquired directly from the storage subsystem. Optionally, you can obtain a hexadecimal display of:

- The following device-related MVS system control blocks:
 - Unit control block (UCB), UCB prefix, and UCB common extension
 - Device class extension (DCE)

- Storage subsystem control block (SSSCB)
- Device performance characteristics table (DPCT)
- The following data buffers acquired directly from the device:
 - Read device characteristics (RDC) data
 - Read configuration data (RCD) data
 - Sense subsystem status (SNSS) data

Using the DEVSERV QTAPE option

Use the QTAPE option of the DEVSERV command to request a hexadecimal display of:

- The following device-related MVS system control blocks:
 - Unit control block (UCB), UCB prefix, and UCB common extension
 - Device class extension (DCE)
- The following data buffers acquired directly from the device:
 - Read device characteristics (RDC) data
 - Read configuration data (RCD) data

Using the DEVSERV QPAVS option

Use the QPAVS option of the DEVSERV command to validate MVS storage resident control blocks with data acquired directly from the storage subsystem. If devices are in a PAV or HYPERPAV relationship, the output shows the relationship between the PAV base and alias devices.

Optionally, you can obtain a hexadecimal display of related MVS system control blocks:

- Unit control block (UCB), UCB prefix, and UCB common extension
- Device class extension (DCE)

Using the DEVSERV QLIB option

Use the QLIB option of the DEVSERV command to:

- Request a list of tape library subsystems that are defined to the host. Libraries are listed by serial number (library-id). If the specified library is a composite library, its distributed library names are also displayed.
- Request a list of devices within a library. Devices are listed by device number and displays the library port for each device.
- Validate the connection status of devices in a library, for example, devices that are connected to the host.
- Delete an improperly defined library control block in preparation for an IODF activate.
- Issue a diagnostic state save order to a library when requested by the IBM Support Center.

Syntax

The syntax for the DEVSERV command is:

```

DS {PATHS | P} ,[/[s][d]ddd[,nnn][,NOSYM|,NOS][,DUMP]+
    [,ONLINE] [,ON] [,OFF] [,OFFLINE] [,L={name-a}]
                                {name }
                                {a }

{SMS | S} ,[ddd[,nn] [ ,ONLINE ] [,L={name-a}]
            |,ON {name }
            |,OFFLINE {a }
            |,OFF

{QDASD},{? }
{QD } {{[s]ddd[,1]|,VOL=volser}{,NOIO{[,UCB][,DCE][,SSSCB][,DPCT]}} }
            |[,UCB][,DCE][,SSSCB][,DPCT]+
            [,RDC][,RCD][,SNSS][,RDFEATS]
            {[s]ddd,nnn [ ,MACH={mmp-sssss|XXXX-sssss} }
            |,SSID={ssid | ALL}
            |,TYPE={type | ALL}
            |,CHPID=chpid
            {MACH={mmp-sssss|XXXX-sssss} }
            {SSID={ssid | ALL} }
            {TYPE={type | ALL} }
            {VOL=volser [,ddd[,nnn]] }
            [,ONLINE] [,OFFLINE] [,DEFINED] [,CHKFAIL] [,VALIDATE] [,TOTALCYL] [,ATTRIBUTE]

{QTAPE | QT}{,? |
    [ [ [,ccuu [,1] ] [ [,UCB] [,DCE][ [,NOIO] | [,RDC]
    [,RCD] ] ] ] | ,ccuu,nnn |
    [,ccuu,nnn] ,LIB=libid | ALL |
    ,MACH=[mmp-sssss | XXXX-sssss] |
    ,TYPE=[type | ALL] ]
    [,ONLINE] [,OFFLINE] [,DEFINED]

{QPAVS | QP}
{,?}
{,sddd[,1] [ ,VOLUME] }
            |,UNBOX
            [ [ [,HPAV] [,UCB] [,DCE] ]
{,sddd[,nnn] [,SSID=ssid |,UNBOX] }

[QLIB | QL],
    [LIST] {ACTIVE|INACTIVE|QUEUE}
    [LISTALL] {ACTIVE|INACTIVE}
    [LIBID] {ACTIVE|INACTIVE|VALIDATE|QUEUE|DELETE}
    [DDDD] {SS}
    [DDR]
    [CATS | CATS(xxx*)]
    [IEA438I]
    [?]
    
```

Parameters

The basic status parameters are:

PATHS or P

Displays (in message IEE459I) the status of specified devices.

DEVSERV accepts a 3, 4 or 5-digit device number.

When a 3 or 4-digit device number is specified, DEVSERV returns information about the device that is in the active subchannel set.

For PPRC devices, this is the "primary" device, including failover scenarios.

When a 5-digit device number is specified, DEVSERV returns information about the device that is physically configured to the subchannel set *s* identified by the first digit in the 5-digit device number.

This allows DEVSERV commands to a PPRC secondary devices, including when these are configured in alternate subchannel sets.

SMS or **S**

Displays (in message IGD001I) the volume and storage group status for *nn* devices that SMS manages, starting with the specified device number.

- s** The subchannel set number. If a subchannel set number is specified, those devices in the subchannel set number are displayed.

[/][d]ddd

The device number for which the system is to display information. The number consists of three or four hexadecimal digits, optionally preceded by a slash (/). If a subchannel set number is specified, a slash (/) cannot be specified as an input. If the subchannel set number is not 0 and the device number is 3 digits, the 3 digits device number must be preceded by a 0, for example 10800.

You can specify any device number that the operating system supports. When the subchannel set number in 's' is omitted, the device number specified in *[d]ddd* represents the device that is in the active subchannel set.

nn\nnn

The number of devices for which the system is to display the information, in ascending order beginning with the device you specify. For SMS, the number in *nn* is from 1 to 32. For PATHS, the number in *nnn* is from 1 to 256. If you do not code *nn* or *nnn*, the default is 1, and the system displays information only about the device you specify.

ONLINE or **ON**

Directs the system to display information about only those specified devices that are online to this MVS host. If you do not specify **ONLINE** or **OFFLINE**, the system displays information about both online and offline devices.

OFFLINE or **OFF**

Directs the system to display information about only those specified devices that are offline to this MVS host. If you do not specify **ONLINE** or **OFFLINE**, the system displays information about both online and offline devices.

NOSYM or **NOS**

Directs the system *not* to display (with message IEE459I) the definitions of symbols. If you omit NOSYM, the system displays the definition of all the symbols. You may use this parameter with PATHS, but not with SMS.

DUMP

Requests an SVC dump after execution of the **DEVSERV PATHS** command. If you specify both **DUMP** and a value for *nnn*, the system ignores the value for *nnn*. The SVC dump will cause an '0C1'X abend. You may use this parameter with **PATHS**, but not with **SMS**.

L=a , name, or name-a

The display area (*a*), console name (*name*), or both (*name-a*) where the display will appear. If you omit this operand, the display appears in the first available display area or in the message area of the console at which you entered the command.

QDASD or QD

Displays (in message IEE459I) diagnostic information about the status of direct access storage devices and storage control units. You use two classes of **QDASD** parameters to control the scope of the display: *unit selection parameters* and *dump selection parameters*.

- Use *unit selection parameters* to identify the units whose information you want to see. These parameters include [s][d]ddd and nnn, VOL, MACH, SSID, TYPE, ONLINE, OFFLINE, DEFINED, and CHKFAIL.

DEVSERV returns information about the device that is in the active subchannel set:

- When a 3- or 4-digit device number is specified
- When the VOL unit selection parameter is specified

For PPRC devices, this is the *primary* device, including failover scenarios.

DEVSERV returns information about the device that is physically configured to the subchannel set *s* identified by the first digit in the 5-digit device number:

- When a 5-digit device number is specified for the unit selection
- When the MACH, SSID or TYPE unit selection parameter is specified

This allows DEVSERV commands to PPRC secondary devices, including when these are configured in alternate subchannel sets.

- Use the *dump selection parameters* to define the contents of the display. Beyond the basic status information, you can specify which of the following MVS system control blocks and/or what information acquired directly from the following device information buffers, to display in hexadecimal format.

- The system control blocks are UCB, DCE, SSSCB, DPCT and RDFEATS. (The RDFEATS control block is displayed when NOIO is specified. If RDFEATS is specified without NOIO, the feature codes acquired from the device buffer are displayed.)

If you specify the NOIO parameter, the display shows only the storage-resident information in the MVS control blocks; the command will not issue any I/O to the selected devices.

- The device information buffers are RDC, RCD, SNSS and RDFEATS.

Any hexadecimal information you request appears following the basic status information.

In addition, there is one action parameter, *VALIDATE*, and one display request parameter, *TOTALCYL*.

QDASD unit selection parameters

The QDASD-specific unit selection parameters are:

- ? Enter the following command to view online help text:
DEVSERV QDASD,?

sddd

The device number for which the system is to display information.

s Indicates the requested subchannel set.

[d]ddd

The 3- or 4-digit device number.

If the subchannel set number is not 0 and the device number is 3-digit, the 3-digit device number must be preceded by a 0, for example 10800. You can specify any device number that the operating system supports.

When the subchannel set number in *s* is omitted and neither the MACH, SSID nor TYPE unit selection parameters is specified, the device number specified in [*d*]*ddd* represents the device that is in the active subchannel set.

When the subchannel set number in *s* is explicitly specified, the device number specified in *ddd* represents the device that is physically configured to the subchannel set number in *s*. This allows DEVSERV commands to a PPRC secondary devices, including when these are configured in alternate subchannel sets.

nnn

The number of DASD devices or units to query. Valid values are from 1 to 256. The default is 1.

VOL=*volser*

The serial number of the volume whose information DEVSERV will display. The volume must be online to the system where you issue the DEVSERV command.

MACH=*mmpp-sssss* | *XXXX-sssss*

A ten-character serial number specifying either the storage control unit or DASD device about which DEVSERV will display information. If you specify *XXXX-sssss*, the search will be done only on the *sssss* portion of the number. MACH will cause an I/O operation for each DASD in the system. To limit the number of I/O operations, specify *sdddd* and *nnn*.

SSID=*ssid* | ALL

Specifies the identification number of the subsystem whose information DEVSERV will display. Valid *ssid* numbers are from 1 to FFFF.

SSID=*ssid* will cause an I/O operation for each DASD in the system. To limit the number of I/O operations, specify *sdddd* and *nnn*. The only devices displayed are in the same control unit and the same subchannel set if the control unit has multiple subchannel sets defined and *sdddd,nnn* is specified.

SSID=ALL requests a display of information for all DASD devices that support the RCD (Read Configuration Data) command.

CHPID=*chpid*

Specifies CHPID to access DASD. This allows DEVSERV to obtain DASD information through specific I/O path. If there is miscabling, DEVSERV might see different information from different CHPID's.

TYPE=*type* | ALL

Specifies the type of DASD or storage control unit about which DEVSERV will display information. Valid *type* values are 3380 and 3390. TYPE=ALL causes the system to display information for all DASD devices that meet all other selection criteria. TYPE will cause an I/O operation for each DASD in the system. To limit the number of I/O operations, specify *sdddd* and *nnn*.

ONLINE (or ON) and OFFLINE (or OFF)

See the basic status parameters described previously under "Parameters" on page 242.

DEFINED

Displays information about all DASD units defined in the current I/O configuration that meet all other selection criteria. The display contains information based on the existence of unit addresses (UCBs) for DASD type devices, and not on the existence of physical devices. Therefore, the display

DEVSERV command

may contain information even for unit addresses that have no accessible physical devices, or for which an accessible physical device type is inconsistent with the defined device type.

CHKFAIL

Directs the system to display information about a device with a status that is inconsistent between the MVS control blocks and the device. This parameter requires a unit address with a physical device attached to it. CHKFAIL will cause an I/O operation for each DASD in the system. To limit the number of I/O operations, specify *sdddd* and *nnn*.

VALIDATE

Uses status information acquired directly from a device to correct inconsistent extended function status information maintained in host processor storage. VALIDATE has no effect if the unit address has no physical device attached.

TOTALCYL

Accumulates device capacities during the scan. Valid track formats are 3380, 3390, and 9345. For each valid track format, the total capacity for all accessible devices will appear at the end of the DEVSERV QDASD display.

RDFEATS

Displays (via message IEE459I) the data in the MVS software control block. If there is an inconsistency between the software and hardware, RDF appears in the EFC result line of the message IEE459I. The DS QD,*sdddd*,VALIDATE command can correct the inconsistency. If a LIC (microcode) upgrade has occurred, the feature table might be inconsistent with the software control block. Issue the VALIDATE parameter to refresh the control block.

ATTRIBUTE or ATTR

Displays the device attributes.

QDASD dump selection parameters

Parameters that are only valid when specifying *sdddd*, and *nnn* has a value of 1, or when specifying the VOL=*volser* parameter. Dump selection parameter information appears in hexadecimal format.

The QDASD dump selection parameters are:

UCB

Unit control block.

DCE

Device class extension block (of the UCB).

SSSCB

Storage subsystem control block.

RDFEATS

Feature table control block.

DPCT

Device performance characteristics table.

RDC

Read device characteristics.

RCD

Read configuration data.

SNSS

Sense subsystem status.

NOIO

No input/output requests. NOIO prevents I/O requests and allows a display only of storage resident information. All other dump selection parameters cause I/O operations.

QTAPE or QT

Displays identification, status, and diagnostic information about tape devices. You can request information about a specific tape device or multiple tape devices. The DEVSERV QTAPE command can obtain information from any tape device that is responsive to the SENSEID command. You use two classes of QTAPE parameters to control the scope of the display: *unit selection parameters* and *diagnostic information selection parameters*.

- Use *unit selection parameters* to identify the units whose information you want to see. These parameters include *ccuu* and *nnn*, LIB, MACH, TYPE, ONLINE, OFFLINE, and DEFINED.
- Use *diagnostic information selection parameters* to define the contents of the display. Beyond the basic status information, you can select which of the following MVS system control blocks, and/or what information acquired directly from the following device information buffers, to display in hexadecimal format.
 - The system control blocks are UCB and DCE.
 - If you specify the NOIO parameter, the display will show only the storage resident information in the requested MVS control blocks; the system will not issue an I/O to the selected device.
 - The device information buffers are RDC and RCD.

Any hexadecimal information you request appears in the display following the basic status information.

QTAPE-specific unit selection parameters

The QTAPE-specific unit selection parameters are:

? Enter the following command to view online help text:

```
DEVSERV QTAPE,?
```

ccuu

The number of the starting, or only, tape device you are querying.

nnn

A decimal value indicating the number of sequential device numbers, starting with *ccuu*, for which to display information.

Valid values for *nnn* are from 1 to 256. The default is 1. The value must be defaulted (unspecified), or specified with a value of 1, if you are specifying any diagnostic information selection parameters. *nnn* is valid only when you also specify *ccuu*.

nnn has a different meaning for DEVSERV QTAPE than for DEVSERV PATHS or DISPLAY UNITS. For those commands, *nnn* indicates the number of device numbers to display, ignoring gaps in the device number sequence. For the DEVSERV QTAPE command, if gaps exist in the sequence of tape device numbers defined to the operating system, and DEFINED is not specified, the missing tape device numbers are listed in the form '*...nnn(01)...*' where *nnnn* is the device number and 01 is the reason code indicating that no unit

DEVSERV command

control block was found for that device number. If *DEFINED* is specified, the display contains no information for missing device numbers.

LIB=libid | ALL

Requests information about the devices having the specified *libid*. If you specify **LIB=ALL**, the display will show information for all library tape devices. **LIB=** is mutually exclusive with **MACH=** and **TYPE=**.

MACH=mmpp-sssss

A ten-character serial number of either a tape control unit or a tape device. The display will show information for the specific device, or for all devices on the tape control unit having the serial number *mmpp-sssss*. If you specify the *mmpp* portion as *XXXX*, the command processor will ignore the manufacturer and plant of manufacture fields of the serial number, and will search only on *sssss*, the sequence number portion. **MACH** is mutually exclusive with **LIB** and **TYPE**.

TYPE=type | ALL

Specifies the type of tape device or control unit about which DEVSERV will display information. Valid values for *type* include any valid four-character tape device or tape control unit number.

TYPE=ALL causes the system to display information for all tape devices that meet all other selection criteria, such as **ONLINE**, **OFFLINE**, and **DEFINED**.

TYPE is mutually exclusive with **LIB** and **MACH**.

ONLINE (or ON) and OFFLINE (or OFF)

See the basic status parameters described previously under "Parameters" on page 242.

DEFINED

Displays information about all tape units defined in the current I/O configuration that meet all other selection criteria.

The display contains information based on the existence of unit addresses (UCBs) for tape type devices and not on the existence of physical devices. Therefore, the display may contain information even for unit addresses that have no accessible physical devices, or for which an accessible physical device type is inconsistent with the defined device type.

The system ignores **DEFINED** if you also specify **LIB** or **MACH**, as these options require the existence of a physical device.

If you specify both **DEFINED** and **TYPE=ALL**, the display will include information for all tape units defined in the configuration.

If you specify both **DEFINED** and **TYPE=type**, where *type* is other than **ALL**, the display will include information only for units of the *type* type. Valid *type* values are 3400, 3480, 3490, and 3590.

For the 3400 device type, **QTAPE** supports only the devices that are responsive to the **SENSEID** command. For other tape devices, **QTAPE** annotates the display with reason code 9: **QTAPE** is not supported.

QTAPE diagnostic information selection parameters

Parameters that are only valid when you specify *ccuu* and *nnn*, with *nnn* having a value of 1. The data appears in hexadecimal format. The parameters are:

UCB

Unit control block.

DCE
Device class extension block.

RDC
Read device characteristics block.

RCD
Read configuration data block.

NOIO
No input/output requests.

NOIO calls for a display of processor storage resident information only. The command processor issues no I/O requests to the devices. The display will contain only unit numbers and device types defined in MVS. NOIO is valid only when specified in combination with UCB and DCE. NOIO is mutually exclusive with RDC and RCD, because those parameters can be acquired only via an I/O operation with the device.

QPAVS or QP

Displays the logical subsystem configuration as defined to the host software, and highlights any inconsistencies between the host configuration definition and the subsystem configuration for parallel access volumes (PAVs).

sdddd

Specifies the device or devices to be displayed. Device can be specified in either of the following formats:

sdddd *s* is either 0 or 1 to indicate the desired subchannel and ***dddd*** specifies a 4 hex digit device number (3-digit device numbers must be padded with a leading zero).

dddd Specifies just the device number. In this case, the active subchannel set is used to return information about the device.

nnn

Specifies the number of devices, a decimal number from 1 to 256.

SSID=*ssid*

Specifies the subsystem identification number (SSID) of the subsystem whose information **DEVSERV** displays. Valid *ssid* numbers are from 1 to FFFF.

SSID=*ssid* causes an I/O operation for each DASD in the system. To limit the number of I/O operations, specify ***sdddd*** and ***nnn***. This command displays PAV bases and aliases that are in the same control unit and the same subchannel set if the control unit has multiple subchannel sets defined.

VOLUME

Displays the parallel access volume (PAV) relationship information for the logical volume, including the PAV base device number and all PAV alias device numbers bound to that base.

UCB

Displays the unit control block (UCB) information associated with the device.

DCE

Displays the device class extension block (DCE) of the BASE UCB.

UNBOX

Causes QPAVS to unbox the unbound alias device if it is in a BOX state.

UNBOX can be issued to more than 1 device in a string in a single command.

HPAV

Displays the number of alias pool devices or the alias pool device numbers

DEVSERV command

associated with a base device number *sdddd* that is the target of the QPAV command. If the *sdddd* number is issued to a HyperPAV alias device, only the alias device will be in the output.

QPAVS output formats: When UNBOX *is not* specified (see Example 13) the format can be any of the following outputs depending on the hardware and software configuration:

HOST CONFIGURATION				SUBSYSTEM CONFIGURATION		
UNIT NUM.	UA	TYPE	STATUS	SSID	UNIT ADDR.	UA TYPE
<i>sdddd</i>	<i>aa</i>	BASE	INV-ALIAS	<i>ssss</i>	<i>uu</i>	BASE
<i>sdddd</i>	<i>aa</i>	ALIAS- <i>bbbb</i>	NOT-BASE	<i>ssss</i>	<i>uu</i>	ALIAS- <i>aa</i>
<i>sdddd</i>	<i>aa</i>	NON-PAV	NOT-ALIAS	<i>ssss</i>	<i>uu</i>	NC
<i>sdddd</i>	<i>aa</i>	NON-PAV	NON-NPAV	<i>ssss</i>	<i>uu</i>	ALIAS- <i>aa</i>
<i>sdddd</i>	<i>aa</i>	ALIAS	UNBOUND	<i>ssss</i>	<i>uu</i>	ALIAS- <i>aa</i>
<i>sdddd</i>	<i>aa</i>	BASE-H		<i>ssss</i>	<i>uu</i>	BASE
<i>sdddd</i>	<i>bb</i>	ALIAS-H		<i>ssss</i>	<i>uu</i>	ALIAS-H

Dump selection parameter formats examples
 aaaaaaaa
 bbbbbbbb

In response to a DEVSERV QPAV command, this message displays the following requested information:

hh.mm.ss

The time in hours, minutes, and seconds.

where:

- Host Configuration
 - *sdddd* = the device number
 - *aa* = the unit address from the host configuration
 - BASE = *sdddd* is a BASE device
 - ALIAS-*bbbb* = *sdddd* is an ALIAS device, the BASE is at address *bbbb*
 - NON-PAV = the unit is neither a BASE nor an ALIAS
 - ALIAS = *sdddd* is an ALIAS device and is not bound to a BASE
 - ALIAS-H = *sdddd* is a HyperPAV ALIAS device
- Status
 - INV-ALIAS = on the host side, the unit is defined as an ALIAS whose BASE is different from the one on the subsystem side
 - NOT-BASE = on the host side, the unit is a BASE, while on the subsystem side it is not
 - NOT-ALIAS = on the host side, the unit is an ALIAS, while on the subsystem side it is not
 - NON-NPAV = on the host side, the unit is not a BASE nor an ALIAS, while on the subsystem side it is an ALIAS
 - UNBOUND = at host side, unit is an ALIAS but is unbound, while at sub-system side, it is assigned to this BASE(*aa*)
- Subsystem Configuration
 - *ssss* = the SSID of the subsystem where device *sdddd* belongs
 - *uu* = the unit address from the subsystem configuration
 - BASE = the unit is a BASE

- ALIAS-*bb* = the unit is an ALIAS device and the BASE is at unit address *bb*
- NC = the unit is neither a BASE nor an ALIAS
- ALIAS-H = the unit is a HyperPAV ALIAS device

aaaaaaaa:

The following text might appear within the display associated with a specific unit number when keyword *UCB* is specified with *sddd*:

UCB AT Vxxxxxxx

UCB contents at location xxxxxxxx in virtual storage

UCB PREFIX AT Vxxxxxxx

UCB PREFIX contents at location xxxxxxxx in virtual storage

UCB COMMON EXTENSION AT Vxxxxxxx

UCB COMMON EXTENSION contents at location xxxxxxxx in virtual storage

The following text might appear within the display associated with a specific unit number when keyword *DCE* is specified with *sddd*:

DCE AT Vxxxxxxx

DCE contents at location xxxxxxxx in virtual storage.

bbbbbbbb:

requested dump details in HEX digits.

UCB AT Vxxxxxxx

UCB contents at location xxxxxxxx in virtual storage

UCB PREFIX AT Vxxxxxxx

UCB PREFIX contents at location xxxxxxxx in virtual storage

UCB COMMON EXTENSION AT Vxxxxxxx

UCB COMMON EXTENSION contents at location xxxxxxxx in virtual storage

The following text might appear within the display associated with a specific unit number when keyword *DCE* is specified with *sddd*:

DCE AT Vxxxxxxx

DCE contents at location xxxxxxxx in virtual storage.

The following text might appear within the display associated with a specific unit number:

```
NO VALID DCE EXISTS FOR THIS DEVICE.
UNLISTED DEVICES AND REASON CODES
sddd(rc) sddd(rc) sddd(rc) ...
```

where:

sddd Subchannel set number and device number

rc One of the following values:

- 01** Device not configured; UCB not found.
- 02** UCB not connected.
- 03** Device unavailable; SCP routine in control.
- 04** Subchannel error.
- 05** Device is boxed.
- 06** UCB is not a DASD.
- 07** Device I/O error.

DEVSERV command

- 08 Device is not a DASD.
- 09 DSE-1 CCW build failed.
- 0A Device is an unbound PAV-ALIAS.
- 0B Device is a secondary of a PPRC pair.
- 0C The specified subchannel set value is not valid.
- 0D UCB not found in the specified subchannel set.
- 0E Device is a HyperPAV ALIAS.
- 0F Device is not a HyperPAV BASE or ALIAS.

When UNBOX *is* specified (see Example 14), the format is:

```
IEE459I hh:mm:ss DEVSERV QPAVS [ID]  
e.....
```

where:

e.....

One of the following explanations:

sdddd HAS BEEN SUCCESSFULLY UNBOXED.

THE DEVSERV QPAV UNBOX COMMAND HAS BEEN EXECUTED WITH
A RETURN CODE OF YY AND A REASON CODE OF ZZ.

sdddd IS NOT AN UNBOUND PAV-ALIAS DEVICE. THE DEVSERV QPAV
UNBOX COMMAND IS NOT EXECUTED.

sdddd IS NOT IN BOX STATE. THE DEVSERV QPAV UNBOX COMMAND
IS NOT EXECUTED.

QLIB or QL

Displays (in message IEE459I) the requested DEVSERV library information. You use two classes of QLIB parameters to control the scope of the display: *parameters* and *sub-parameters*.

QLIB parameters

LIST

Indicates that QLIB should display a list of the ACTIVE library-ids (the default). You can optionally generate a list of INACTIVE library-ids or QUEUE'd library orders. LIST uses the sub-parameters ACTIVE, INACTIVE, and QUEUE.

LISTALL

Produces a detailed list of all libraries, including the devices and port-ids within each library. LISTALL uses the sub-parameters ACTIVE and INACTIVE.

LIBID

Indicates that the request is for a specific library. LIBID uses the sub-parameters ACTIVE, INACTIVE, VALIDATE, QUEUE, and DELETE.

DDDD

Indicates that the request is either for the library that contains device *dddd*, or is for the device *dddd* itself. A sub-parameter is required when DDDD is specified. DDDD uses the sub-parameter SS.

DDR

Displays the limit on storage usage for tape DDR swap.

SS Indicates that QLIB should issue a diagnostic state save to the library containing device DDDD. This command is intended to be used at the request of IBM Support Center. For example, SS can be used to diagnose a hardware

error that results in a mount failure message. Automated Operator code can extract the failing device number from the failure message, then insert the device in a QLIB SS command.

CATS | CATS(xxx*)

Displays or updates the library partitioning category codes. For a request to change the library partitioning category codes, the first 3 digits of the category can be modified with the last digit being fixed and representing the media type. If the library partitioning category codes are modified using the DS QL,CATS command, the corresponding changes must also be reflected in the DEVSUPxx PARMLIB member. If not, an IPL reverts the category codes to what is specified in DEVSUPxx.

Example:

```
DS QL,CATS
IEE459I 10.31.30 DEVSERV QLIB
0001 0002 0003 0004 0005 0006 0007 0008 0009 000A 000E 000F
```

The following command will change the first three characters of ALL the categories:

```
DS QL,CATS(003*)
IEE459I 10.32.12 DEVSERV QLIB
0031 0032 0033 0034 0035 0036 0037 0038 0039 003A 003E 003F
```

IEA438I

Displays the device number and error code of any devices that fail device initialization during IPL.

? Causes QLIB to display the command syntax.

QLIB sub-parameters

ACTIVE

Displays information about the library configuration that is currently in use by the system.

INACTIVE

Displays information about the library configuration that becomes active following the next IODF activate. The INACTIVE configuration is similar to ACTIVE, but may contain additional devices or libraries.

VALIDATE

Displays the same information as the INACTIVE configuration. However, before the configuration is displayed, I/O is issued to each device in the configuration to validate connectivity to the host.

DELETE

Indicates that QLIB should delete the INACTIVE control blocks for library LIBID and not affect the existing ACTIVE library definition. The DELETE command is used to remove incorrectly defined library control blocks so that they can be rebuilt. DEVSERV DELETE provides an alternative to the method described in information APAR II09065, which requires two IODF activates.

The DEVSERV QLIB method is as follows:

1. Use QLIB DELETE to delete all of the devices from the incorrect control blocks.
2. Choose one action depending on whether you have LIBID and LIBPORT coded in the IODF:
 - If LIBID and LIBPORT are coded, use QLIB LIST to display that the INACTIVE control blocks have been deleted.

DEVSERV command

- If LIBID and LIBPORT are not coded, use the VARY command to vary online the devices in the library. This will create control blocks. The system issues message IEA437I, for example:

```
IEA437I TAPE LIBRARY DEVICE(dev), ACTIVATE IODF=XX, IS REQUIRED
```

3. Use ACTIVATE IODF to redefine the devices.
4. Use QLIB LIST to display that the ACTIVE control blocks are properly defined.

QUEUE

Lists the library orders that are waiting to be completed. Such orders include:

- MOUNT
- DEMOUNT
- EJECT
- AUDIT

When an order completes, the library notifies the host and the order is removed from the queue. This QLIB display can list orders for all libraries, or be limited for a single library.

Examples

Example 1:

To display the status of a DASD with device number 380, enter:

```
DS P,380
```

Example 2:

To display the status of a DASD with device number 3480, enter:

```
DS P,/3480
```

Example 3:

To display the status of all online devices with device numbers 380 through 38F, enter:

```
DS P,380,16,0N
```

Example 4:

To display the status of SMS-controlled device 430 and the seven devices whose addresses follow it, enter:

```
ds s,430,8
```

This command would produce the following display:

```
IGD001I 11:49:20 DEVSERV SMS 455
UNIT,TYPE ,M,VOLUME,VOLSTAT STORGRP, SGSTAT
430 ,3380 ,0,XP0101,ENABLED SXP01 ,ENABLED
431 ,3380 ,A,XP0201,ENABLED SXP02 ,ENABLED
432 ,3380 ,A,XP0202,ENABLED SXP02 ,ENABLED
433 ,3380 ,0,XP0301,ENABLED SXP03 ,ENABLED
434 ,3380 ,0,XP0302,ENABLED SXP03 ,ENABLED
435 ,3380 ,0,XP0303,ENABLED SXP03 ,ENABLED
436 ,3380 ,0,338001,STRG/RSDNT, VOLUME NOT MANAGED BY SMS
437 ,3380 ,A,SMSPCK,STRG/RSDNT, VOLUME NOT MANAGED BY SMS
```

Note: Indications in the M column are: O=online, A=allocated, F=offline.

Example 5:

The following two sample displays compare the response to DEVSERV P with the response to DEVSERV S. Note that DEVSERV P provides volser and CHPID information, while DEVSERV S provides SMS volume and storage group status.

Issuing **DEVSERV P,F4A** produces this display:

```
ds p,f4a
IEE459I 15.30.14 DEVSERV PATHS 728
  UNIT DTYPE M CNT VOLSER  CHPID=PATH STATUS
      RTYPE SSID CFW TC   DFW PIN DC-STATE CCA DDC      CYL CU-TYPE
00F4A,33909 ,O,000,EV9LIA,00=+ 04=+
      2105 201F Y YY. YY. N SIMPLEX  3A 3A      10017 2105
***** SYMBOL DEFINITIONS *****
O = ONLINE                + = PATH AVAILABLE
```

Issuing **DEVSERV S,430** produces this display:

```
devserv s,430
IGD001I 16:24:26 DEVSERV SMS 569
UNIT,      TYPE      ,M, VOLUME,  VOLSTAT      STORGRP, SGSTAT
430, 3380      ,O, XP0101,  ENABLED      SXP01,  QUIESCED
***** SYMBOL DEFINITIONS *****
O = ONLINE                + = PATH AVAILABLE
```

Note: Tape device type is not supported by DEVSERV SMS.

Example 6:

The extra header line and data line appear in the response only when there are 3990 Model 3 Storage Controls in the system. If record caching has not been installed, the RC column in the third header line is left blank.

Issuing **DEVSERV P,430,2** produces this display:

```
devserv p,430,2
IEE459I 16.24.41 DEVSERV PATHS 572

UNIT DTYPE M CNT VOLSER  CHPID=PATH STATUS
      RTYPE SSID CFW TC   DFW PIN DC-STATE CCA DDC      CYL CU-TYPE
00430,3380D, O,000,XP0101,25=+ 2E=+
      IE YY  NN  N SIMPLEX  C0 01      885 3990-3
00431,3380E, O,000,XP0101,25=+ 2E=+
      IE YY  NN  N SIMPLEX  C1 01      1770 3990-3
***** SYMBOL DEFINITIONS *****
O = ONLINE                + = PATH AVAILABLE
```

Example 7:

This example shows the dual copy status.

Issuing **DS P,D2A,2** produces this display:

```
IEE459I 10.06.45 DEVSERV PATHS 297

UNIT DTYPE M CNT VOLSER  CHPID=PATH STATUS
      RTYPE SSID CFW TC   DFW PIN DC-STATE CCA DDC      CYL CU-TYPE
00D2A,3380D ,O,000,DSFXA0,1B=+ 9B=+ 1C=+ 9C=+
      00AB Y NY. NY. N PRIMARY  20 20  ALT 0D2B 3990-3
00D2B,3380D ,F,000,      ,1B=+ 9B=+ 1C=+ 9C=+
```

DEVSERV command

```
00AB Y NY. NY. N SECONDARY 21 21 ALT 0D2A 3990-3
***** SYMBOL DEFINITIONS *****
F = OFFLINE O = ONLINE          + = PATH AVAILABLE
```

Example 8:

This example shows the sparing status.

Issuing **DS P,F7E** produces this display:

```
IEE459I 16.02.11 DEVSERV PATHS 389

UNIT DTYPE M CNT VOLSER CHPID=PATH STATUS
RTYPE SSID CFW TC DFW PIN DC-STATE CCA DDC CYL CU-TYPE
00F7E,33903 ,F,000, ,B5=X B6=X B9=X BA=X
9392-2 00FD Y NY. NN. N SPARE 2E 00 3339 3990-3
***** SYMBOL DEFINITIONS *****
F = OFFLINE X = INDETERMINATE FAILING UNIT
```

Example 9:

This example shows the PPRC status.

Issuing **DS P,D300,2** produces this display:

```
ds p,d300,2
IEE459I 15.55.04 DEVSERV PATHS 596
UNIT DTYPE M CNT VOLSER CHPID=PATH STATUS
RTYPE SSID CFW TC DFW PIN DC-STATE CCA DDC CYL CU-TYPE
0D300,33909 ,O,000,TK9085,4B=< 4F=+ 5B=< 5F=<
2107 2401 Y YY. YY. N PPRIMARY 05 05 10017 2107
0D301,33909 ,O,000,TK3083,14=+ 18=+
PATH ATTRIBUTES NP PF
3390 1601 Y YY. YY. N PSECONDRY 03 03 10017 2107
***** SYMBOL DEFINITIONS *****
O = ONLINE + = PATH AVAILABLE
< = PHYSICALLY UNAVAILABLE PF = PREFERRED
NP = NON-PREFERRED
```

Example 10:

This example uses the DEVSERV QTAPE command to diagnose an error, namely an inconsistent device definition.

a. VARY ONLINE fails.

V 931,ONLINE

```
IEE103I UNIT 0931 NOT BROUGHT ONLINE
IEE763I NAME- IECINIT CODE= 0000000800000000
IEA435I PHYSICAL DEVICE INCONSISTENT WITH LOGICAL DEFINITION
IEE764I END OF IEE103I RELATED MESSAGES
```

b. DEVSERV QTAPE shows inconsistent device definition.

DS QT,931,1

```
IEE459I 15.28.22 DEVSERV QTAPE
UNIT DTYPE DSTATUS CUTYPE DEVTYPE CU-SERIAL DEV-SERIAL ACL LIBID
0931 3480X OFFLINE 3490A20 3490B40? 0113-97231 0113-97231 I
**** 1 DEVICE(S) MET THE SELECTION CRITERIA
```

Example 11:

This example illustrates the help text provided when you issue the command:

DS QT,?

```
IEE459I 15.27.49 DEVSERV QTAPE
DEVSERV QTAPE COMMAND SYNTAX:
DS QT,ccuu,n,filter1,filter2,diagnostic info
ccuu -- device number, n -- number of devices (1-256)
filter1 -- LIB=ALL or library id, or
           MACH=ALL or cu or device serial, or
           TYPE=ALL or device type or defined device type
filter2 -- DEFINED, ONLINE, OFFLINE
           DEFINED is valid only if TYPE= is selected
diagnostic info -- UCB, DCE, RDC, RCD, NOIO
                  valid only if n=1 is specified
DS QT,LIB=libid,filter
libid -- ALL or library id
filter -- ONLINE, OFFLINE
DS QT,MACH=serialnubr,filter
serialnubr -- control unit or device serial
filter -- ONLINE, OFFLINE
DS QT,TYPE=type,filter
type -- ALL or defined device type
filter -- DEFINED, ONLINE, OFFLINE
```

Example 12:

This example illustrates the basic DEVSERV QTAPE display without hexadecimal data.

DS QT,TYPE=ALL

```
IEE459I 12.57.36 DEVSERV QTAPE
UNIT DTYPE DSTATUS CUTYPE DEVTYPE CU-SERIAL DEV-SERIAL ACL LIBID
0930 3480SX ON-NRD 3490A02 3490B04 0112-47671 0112-47671 I
093F 3480SX OFFLINE 3490A02 3490B04 0112-47671 0112-47671 I
0990 3490 ON-RDY 3490A20 3490B40 0113-97231 0113-97231 I-A
09A0 3490 OFFLINE 3490C2A 3490C2A 0113-55565 0113-55565 I 10382
**** UNLISTED DEVICE(S) AND REASON CODES :
      093E(05) 093F(05)
****          4 DEVICE(S) MET THE SELECTION CRITERIA
**** (05) - DEVICE BOXED
```

Example 13:

These six variations illustrate the DEVSERV QPAVS command when the UNBOX parameter is not specified.

DS QP,D3FF,VOLUME

```
ds qp,d3ff,volume
IEE459I 20.45.15 DEVSERV QPAVS 721
      HOST                      SUBSYSTEM
      CONFIGURATION              CONFIGURATION
-----
UNIT          UNIT  UA
NUM. UA  TYPE          STATUS  SSID  ADDR.  TYPE
-----
0D300 05  BASE          2401  05    BASE
0D3FE 1B  ALIAS-D300     2401  1B    ALIAS-05
0D3FF 1C  ALIAS-D300     2401  1C    ALIAS-05
****          3 DEVICE(S) MET THE SELECTION CRITERIA
```

DS QP,D3FE,UCB

```
ds qp,d3fe,ucb
IEE459I 20.48.43 DEVSERV QPAVS 724
```

DEVSERV command

HOST CONFIGURATION				SUBSYSTEM CONFIGURATION		
UNIT NUM.	UA	TYPE	STATUS	SSID	UNIT ADDR.	UA TYPE
0D3FE	1B	ALIAS-D300		2401	1B	ALIAS-05
UCB AT V022E1E68						
0088FF04D3FE0000 0000000008E4C3C2 3010200F002E1E41 0000000000000000						
0000000000100000 022DF590022E1CC8 0580000000000000						
UCB PREFIX AT V02407020						
000400400000000000 000000000010035 289C2BB2400040F0 4B4F5B5F00000000						
01490000000000001						
UCB COMMON EXTENSION AT V022E1E40						
00000900202A0008 0240702000000000 0000000000FD6A74 022DF72000001800						
**** 1 DEVICE(S) MET THE SELECTION CRITERIA						

DS QP,D3AD,2

ds qp,d3ad,2
IEE459I 21.04.01 DEVSERV QPAVS 800

HOST CONFIGURATION				SUBSYSTEM CONFIGURATION		
UNIT NUM.	UA	TYPE	STATUS	SSID	UNIT ADDR.	UA TYPE
0D3AD	2A	ALIAS-D301		1601	2A	ALIAS-03
**** UNLISTED DEVICE(S) AND REASON CODES :						
0D3AE(0A)						
**** (0A) - DEVICE IS AN UNBOUND PAV-ALIAS						
**** 1 DEVICE(S) MET THE SELECTION CRITERIA						

DS QP,0D3FF,VOLUME

ds qp,0d3ff,volume
IEE459I 20.44.23 DEVSERV QPAVS 718

HOST CONFIGURATION				SUBSYSTEM CONFIGURATION		
UNIT NUM.	UA	TYPE	STATUS	SSID	UNIT ADDR.	UA TYPE
0D300	05	BASE		2401	05	BASE
0D3FE	1B	ALIAS-D300		2401	1B	ALIAS-05
0D3FF	1C	ALIAS-D300		2401	1C	ALIAS-05
**** 3 DEVICE(S) MET THE SELECTION CRITERIA						

DS QP,2D3FF,VOLUME

ds qp,2d3ff,volume
IEE459I 20.44.08 DEVSERV QPAVS 715

HOST CONFIGURATION				SUBSYSTEM CONFIGURATION		
UNIT NUM.	UA	TYPE	STATUS	SSID	UNIT ADDR.	UA TYPE
**** UNLISTED DEVICE(S) AND REASON CODES :						
2D3FF(0C)						
**** (0C) - SUBCHANNEL SET VALUE SPECIFIED IS NOT VALID						

DS QP,SSID=1601

DS QP,SSID=1601
IEE459I 21.11.32 DEVSERV QPAVS 803

HOST CONFIGURATION				SUBSYSTEM CONFIGURATION		
UNIT NUM.	UA	TYPE	STATUS	SSID	UNIT ADDR.	UA TYPE

UNIT NUM.	UA	TYPE	STATUS	SSID	UNIT ADDR.	UA TYPE
-----	--	----	-----	----	----	-----
0D301	03	BASE		1601	03	BASE
0D3AC	29	ALIAS-D301		1601	29	ALIAS-03
0D3AD	2A	ALIAS-D301		1601	2A	ALIAS-03
**** 3 DEVICE(S) MET THE SELECTION CRITERIA						

Example 14:

This command illustrates the DEVSERV QPAVS command when the UNBOX parameter IS specified.

DS QP,D300,UNBOX

```
IEE459I 08.12.53 DEVSERV QPAVS 935
0D300 IS NOT AN UNBOUND PAV-ALIAS DEVICE.
THE DEVSERV QPAV UNBOX COMMAND IS NOT EXECUTED.
```

Example 15:

This example illustrates the use of DEVSERV QLIB to delete the INACTIVE control blocks for library 10382.

DS QL,10382,DELETE

```
*04 Reply 'YES' to delete the INACTIVE configuration for library 10382,
any other reply to quit.
R 4, YES
```

```
IEE459I 10.27.54 DEVSERV QLIB 432
Inactive configuration for library 10382 successfully deleted
```

Example 16:

This example illustrates the use of DEVSERV QLIB to list all of the queued requests.

DS QL,LIST,QUEUE

```
IEE459I 10.19.40 DEVSERV QLIB 421
LIBID DEVICE REQUEST VOLSER CATEGORY TIME ON QUEUE
10382 F018 MOUNT VOL001 000F 3 MINUTE(S)
10382 F020 MOUNT VOL002 000F 1 MINUTE(S)
10382 F031 EJECT VOL003 000F 8 MINUTE(S)
10382 F021 DEMOUNT VOL005 0001 3 MINUTE(S)
```

Example 17:

This example illustrates the use of DEVSERV QLIB to list all of the libraries that are defined to the system and then list all of the devices for library 10382. An * indicates that at least one device in library 10382 has been initialized. It also indicates that library 15393 is logically defined to the system, but has never gone through device initialization. Initialization occurs during IPL or IODF activate for any library devices that are connected to the system. For devices that are connected after IPL or IODF activate, initialization occurs when the device is varied online. For library 10382, devices on ports 03, 02, and 01 have never been initialized.

DS QL,LIST

```
IEE459I 09.48.44 DEVSERV QLIB 391
The following libids are defined in the ACTIVE configuration:
*10382 15393
DS QL,10382
```

DEVSERV command

```
IEE459I 09.49.03 DEVSERV QLIB 394
LIBID PORTID      DEVICES
10382 04          0940* 0941* 0942* 0943* 0944* 0945* 0946* 0947*
          0948* 0949* 094A* 094B* 094C* 094D* 094E* 094F*
          03          09A0 09A1 09A2 09A3 09A4 09A5 09A6 09A7
          09A8 09A9 09AA 09AB 09AC 09AD 09AE 09AF
          0DB0 0DB1 0DB2 0DB3 0DB4 0DB5 0DB6 0DB7
          0DB8 0DB9 0DBA 0DBB 0DBC 0DBD 0DBE 0DBF
          02          09D0 09D1 09D2 09D3 09D4 09D5 09D6 09D7
          09D8 09D9 09DA 09DB 09DC 09DD 09DE 09DF
          01          F990 F991 F992 F993 F994 F995 F996 F997
```

Example 18:

This example illustrates the use of DEVSERV QLIB to verify the connectivity of devices in library 15393.

This display indicates that devices DC8 and DC9 were connected to the system at some point and were initialized.

```
ds ql,15393,INACTIVE
IEE459I 11.55.47 DEVSERV QLIB 471
The following are defined in the INACTIVE configuration:
LIBID PORTID      DEVICES
15393 03          0DC8* 0DC9* 0DC0 0DC1 0DC2 0DC3 0DC4 0DC5
          0DC6 0DC7 0DCA 0DCB 0DCC 0DCD 0DCE 0DCF
```

This display uses VALIDATE to determine the current state of device connectivity:

- DC8 is no longer connected to the system
- DC9 is still connected
- DC5 has now become connected

```
ds ql,15393,validate
IEE459I 11.56.15 DEVSERV QLIB 476
The following are defined in the INACTIVE configuration:
LIBID PORTID      DEVICES
15393 03          0DC8 0DC9* 0DC0 0DC1 0DC2 0DC3 0DC4 0DC5*
          0DC6 0DC7 0DCA 0DCB 0DCC 0DCD 0DCE 0DCF
```

Example 19:

This example illustrates the use of DEVSERV QLIB command to display and interpret any device initialization errors that occurred during IPL.

```
DS QL,IEA438I
IEE459I 11.58.04 DEVSERV QLIB 620
Device initialization errors detected during IPL
 9AFA-09 9A1A-09 9ABA-09 9ADA-09 9A9A-09 9A5A-09 9A3A-09 9A7A-09
 9A1B-09 9A3B-09 9A5B-09 9A7B-09 9A9B-09 9ABB-09 9ADB-09 9AFB-09
 9A1C-09 9A3C-09 9A5C-09 9A7C-09 9A9C-09 9ABC-09 9ADC-09 9AFC-09
 9A1D-09 9A3D-09 9A7D-09 9A5D-09 9A9D-09 9ADD-09 9ABD-09 9AFD-09
```

The number following the dash identifies the error that was detected during IPL. The failures that can be reported are:

- 2 The library interface is offline.
- 4 The device returned a library ID of all zeros (in Read Device Characteristics).
- 6 The device is unavailable to the library manager.
- 9 The HCD defined library ID and pool ID do not match the hardware ID.
- 12 The device type (EPI) is different from other devices in the same pool.

15 An I/O error occurred trying to read distributed library data.

DISPLAY command

Use the DISPLAY system command to display information about the operating system, the jobs and application programs that are running, the processor, devices that are online and offline, central storage, workload management service policy status, and the time of day. Use Table 23 to access the pages on which you can find details about a particular use of the DISPLAY command.

Table 23. Summary of the DISPLAY command

Topic	Command
"Displaying system activity" on page 344	DISPLAY A
"Displaying MVS device allocation group locks information" on page 265	DISPLAY ALLOC,GRPLOCKS
"Displaying MVS device allocation settings information" on page 266	DISPLAY ALLOC,OPTIONS
"Displaying APPC/MVS information" on page 267	DISPLAY APPC
"Displaying ASCH configuration information" on page 273	DISPLAY ASCH
"Displaying auxiliary storage information" on page 275	DISPLAY ASM
"Displaying auto-reply policy and WTORS information" on page 277	DISPLAY AUTOR
"Displaying the current system level language environment run-time options" on page 278	DISPLAY CEE
"Displaying CONTROL command functions" on page 280	DISPLAY C,K
"Displaying attached coupling facility information" on page 280	DISPLAY CF
"Displaying console group definitions" on page 281	DISPLAY CNGRP
"Displaying console status information" on page 282	DISPLAY CONSOLES
"Displaying DIAG parmlib information" on page 287	DISPLAY DIAG
"Displaying data lookaside facility information" on page 287	DISPLAY DLF
"Displaying dump options or dump data set status" on page 290	DISPLAY DUMP
"Displaying extended MCS information" on page 293	DISPLAY EMCS
"Displaying the timer synchronization mode and ETR ports" on page 298	DISPLAY ETR
"Displaying global resource serialization information" on page 299	DISPLAY GRS
"Displaying Generic Tracker information" on page 314	DISPLAY GTZ
"Displaying hardware event data collection status" on page 322	DISPLAY HIS
"Displaying Basic HyperSwap information" on page 325	DISPLAY HS
"Displaying ICSF information" on page 326	DISPLAY ICSF
"Displaying the data set optimization configuration" on page 326	DISPLAY IEFOPZ
"Displaying TSO/E parmlib information" on page 330	DISPLAY IKJTZO
"Displaying I/O configuration information" on page 331	DISPLAY IOS,CONFIG
"Displaying captured UCB information" on page 332	DISPLAY IOS,CAPTUCB
"Displaying IOS control unit group information" on page 332	DISPLAY IOS,CUGRP
"Displaying dynamic channel path management information" on page 334	DISPLAY IOS,DCM
"Displaying encryption key manager (EKM) status" on page 334	DISPLAY IOS,EKM
"Displaying zHPF facility status" on page 335	DISPLAY IOS,zHPF

DISPLAY command

Table 23. Summary of the DISPLAY command (continued)

Topic	Command
"Displaying FICON switch data information" on page 336	DISPLAY IOS,FICON
"Displaying IOS group information" on page 336	DISPLAY IOS,GROUP
"Displaying IOS HYPERPAV information" on page 336	DISPLAY IOS,HYPERPAV
"Displaying MIDAW facility status" on page 337	DISPLAY IOS,MIDAW
"Displaying MIH and I/O timing limits" on page 337	DISPLAY IOS,MIH
"Displaying IOS recovery options" on page 341	DISPLAY IOS,RECOVERY
"Displaying IOS storage residency information" on page 341	DISPLAY IOS,STORAGE
"Displaying the devices stopped by the IOACTION command" on page 342	DISPLAY IOS,STOP
"Displaying IPL information" on page 342	DISPLAY IPLINFO
"Displaying PCIE-related parameters" on page 344	DISPLAY IQP
"Displaying system activity" on page 344	DISPLAY JOBS or DISPLAY J or DISPLAY A or DISPLAY TS
"Displaying library lookaside information" on page 355	DISPLAY LLA
"Displaying the system logger and its log streams" on page 356	DISPLAY LOGGER
"Displaying the logrec recording medium" on page 367	DISPLAY LOGREC
"Displaying system configuration information" on page 368	DISPLAY M
"Displaying message flood automation information" on page 376	DISPLAY MSGFLD
"Displaying MVS message service status and languages" on page 378	DISPLAY MMS
"Displaying message suppression, retention, color, intensity, and highlighting options" on page 378	DISPLAY MPF
"Displaying status of z/OS UNIX System Services" on page 380	DISPLAY OMVS
"Displaying operator information (OPDATA)" on page 401	DISPLAY OPDATA
"Displaying PARMLIB information" on page 403	DISPLAY PARMLIB
"Displaying PCIE information" on page 402	DISPLAY PCIE
"Displaying commands defined for PFKs" on page 406	DISPLAY PFK
"Displaying PPTs" on page 407	DISPLAY PPT
"Displaying registered products" on page 409	DISPLAY PROD
"Displaying entries in the list of APF-authorized libraries" on page 411	DISPLAY PROG,APF
"Displaying PROG defaults" on page 412	DISPLAY PROG,DEFAULTS
"Displaying dynamic exits" on page 412	DISPLAY PROG,EXIT
"Displaying LNKLST information" on page 415	DISPLAY PROG,LNKLST
"Displaying LPA information" on page 416	DISPLAY PROG,LPA
"Displaying the status of the REFRPROT option" on page 417	DISPLAY PROG,REFRPROT
"Displaying the status of the TRACKDIRLOAD option" on page 417	DISPLAY PROG,TRACKDIRLOAD
"Displaying system requests" on page 418	DISPLAY R
"Displaying resource recovery services (RRS) information" on page 424	DISPLAY RRS
"Displaying SLIP trap information" on page 427	DISPLAY SLIP

Table 23. Summary of the DISPLAY command (continued)

Topic	Command
"Displaying SMF data" on page 428	DISPLAY SMF
"Displaying the in-storage copy of the SMF limits" on page 429	DISPLAY SMFLIM
"Displaying storage management subsystem information" on page 432	DISPLAY SMS
"Displaying information about all subsystems" on page 452	DISPLAY SSI
"Displaying static system symbols" on page 454	DISPLAY SYMBOLS
"Displaying the local and coordinated universal time and date" on page 455	DISPLAY T
"Displaying component or transaction trace status" on page 456	DISPLAY TRACE
"Displaying system activity" on page 344	DISPLAY TS
"Displaying device status and allocation" on page 460	DISPLAY U
"Displaying Unicode services" on page 463	DISPLAY UNI
"Displaying virtual storage information" on page 465	DISPLAY VIRTSTOR,HVSHARE or DISPLAY VIRTSTOR,HVCOMMON or DISPLAY VIRTSTOR,LFAREA
"Displaying workload manager information" on page 467	DISPLAY WLM
"Displaying cross system coupling facility (XCF) information" on page 473	DISPLAY XCF

Some uses of the DISPLAY command are described in other books. They are:

- TCPIP activity and functions. See *z/OS Communications Server: IP System Administrator's Commands*.
- VTAM network activity and functions. See *z/OS Communications Server: SNA Operation*.

Scope in a sysplex

Table 24 describes the conditions under which the DISPLAY command has sysplex scope. See "Using commands that have sysplex scope" on page 12 for an explanation of sysplex scope. If a command has **All** under "Conditions," then the command has sysplex scope under all circumstances and for all variations.

Table 24. Sysplex Scope for DISPLAY Command

Command	Conditions
DISPLAY CF	Has sysplex scope only when displaying information about the coupling facility and only for those systems connected to the coupling facility. Does not have sysplex scope when displaying an individual system's coupling facility configuration information (coupling facility channels and paths).
DISPLAY CNGRP	All
DISPLAY CONSOLES	Has sysplex scope unless you specify DISPLAY C,B or DISPLAY C,U=.
DISPLAY DUMP	Has sysplex scope only when you issue the OPTIONS parameter to display the results of a CHNGDUMP,SDUMPSYSFAIL,STRLIST= command.

DISPLAY command

Table 24. Sysplex Scope for DISPLAY Command (continued)

Command	Conditions
DISPLAY EMCS	Has sysplex scope, except when you specify STATUS=B or STATUS=ERR. When you specify STATUS=FULL, consoles from all systems will be displayed (for consoles that are not active on the system where this command is processed, some information will not be displayed).
DISPLAY GRS	Has sysplex scope unless you specify SUSPEND. Also, note the following about DISPLAY GRS,C and DISPLAY GRS,RES: the output generated by these commands includes both system-specific information (S=SYSTEM) and sysplex information (S=SYSTEMS). The S=SYSTEM information is valid only for the system on which you issue the command. The S=SYSTEMS information is identical regardless of the system on which you issue the command.
DISPLAY GRS,ANALYZE	Has sysplex scope for Enqs, but can be limited to a system. Also, the addition of D GRS,ANALYZE,LATCH to the command only returns latch analyze information for the system the command is running in.
DISPLAY LOGGER	Has sysplex scope when using the L, C,SYSPLEX or STR option.
DISPLAY OPDATA	Has sysplex scope.
DISPLAY PFK	Has sysplex scope only when you specify CN=.
DISPLAY R	Has sysplex scope, but the output might be different on different consoles, because the output of DISPLAY R is dependent on the routing criteria for the console specified by CN=. If you do not specify CN=, the routing criteria of the console issuing the command is used. If you issue the command in a program (by using the MGCRC macro) the console you specify in the macro is used. If you specify a console ID of 0, all retained messages are included in the command response.
DISPLAY WLM	All
DISPLAY XCF,ARMSTATUS	Has sysplex scope provided all systems are using the same ARM couple data set.
DISPLAY XCF,CF	Has sysplex scope provided all systems in the sysplex are connected to the same coupling facilities.
DISPLAY XCF,COUPLE	Has sysplex scope as long as all systems are using the same types of couple data sets, as specified on the TYPE parameter (SYSPLEX, ARM, CFRM, SFM, LOGR, and WLM.) If you do not specify the TYPE parameter, only system-specific data is displayed.
DISPLAY XCF,GROUP	All
DISPLAY XCF,NOTEPAD	Has sysplex scope as long as all systems in the sysplex are connected to the coupling facilities that host the XCF note pad catalog structure (SYSXCF_NPCATALOG) and the various structures used to host note pads (for example, structures with names that begin with IXCNP_").
DISPLAY XCF,SERVER	ALL
DISPLAY XCF,POLICY	Has sysplex scope as long as all systems are using the same types of couple data sets, as specified on the TYPE parameter (ARM, CFRM, SFM, and LOGR.)

Table 24. Sysplex Scope for DISPLAY Command (continued)

Command	Conditions
DISPLAY XCF,STRUCTURE	Has sysplex scope provided all systems in the sysplex are connected to the same coupling facilities.
DISPLAY XCF,SYSPLEX	All

Syntax

The syntax for each of the many variations of the DISPLAY command is shown immediately preceding its respective parameter list.

DISPLAY or D

Notes:

1. You must supply all commas between DISPLAY U or DISPLAY R and a specified positional operand. For example, DISPLAY U,,ONLINE.
2. You must enclose any comments on the commands DISPLAY PROD and DISPLAY PROG in slash-asterisk — asterisk-slash pairs. See “System command formats” on page 168 for further information.

Displaying MVS device allocation group locks information

Use the DISPLAY ALLOC,GRPLOCKS command to display information about the current Device Allocation group locks that are being held. The operator can specify one of the four different options:

- specify all group locks
- group locks for which contention exists
- group locks associated with a particular device
- group locks associated with a particular jobname

D ALLOC,GRPLOCKS

<pre>D ALLOC,GRPLOCKS { ,ALL } { ,CONTENTION C } { ,DEVICE D = d } { ,JOBNAME J = j } [,L={a name name-a}]</pre>

The parameters are:

ALL

Indicates that in all groups in which Device Allocation group locks are either being held or waited on, the group number, the device(s), the jobname(s), the asid(s), and the status of the job(s) are to be displayed.

CONTENTION or **C**

Indicates that in all groups that are in Device Allocation group lock contention (groups that have both owners and waiters on their group locks), the group number, the device(s), the jobname(s), the asid(s), and the status of the job(s) are to be displayed.

DISPLAY ALLOC,GRPLOCKS command

DEVICE or D = d

Indicates that for all groups that are either holding or waiting on Device Allocation group locks for a particular named device, the group number, the device(s), the jobname(s), the asid(s), and the status of the job(s) are to be displayed.

JOBNAME or J = j

Indicates that for all groups in which Device Allocation group locks are either held or waited on by the specified job, the group number, the device(s), the jobname(s), the asid(s), and the status of the job(s) are to be displayed.

L=a, name, or name-a

Specifies the display area (*a*), console name (*name*), or both (*name-a*) where the display is to appear.

If you omit this operand, the display is presented in the first available display area or the message area of the console through which you enter the command.

Note: For the output of the DISPLAY ALLOC,GRPLOCKS command, see the description of message IEFA001I in *z/OS MVS System Messages, Vol 8 (IEF-IGD)*.

Displaying MVS device allocation settings information

Use the DISPLAY ALLOC,OPTIONS command to display either of the following:

- The current MVS Device Allocation settings that are in use, as set by the ALLOCxx parmlib member at IPL, or modified by the SETALLOC operator command.
- The system defaults, if no ALLOCxx member has been specified or no SETALLOC command has been processed.

D ALLOC,OPTIONS
D ALLOC,OPTIONS
[,L={a name name-a}]

ALLOC,OPTIONS

Indicates the categories and Allocation settings that are currently being used. Certain options are displayed only when they are applicable to the settings that the system is using.

L=a, name, or name-a

Specifies the display area (*a*), console name (*name*), or both (*name-a*) where the display is to appear.

If you omit this operand, the display is presented in the first available display area or the message area of the console through which you enter the command.

Note: For the output of the DISPLAY ALLOC,OPTIONS command, see the description of message IEFA003I in *z/OS MVS System Messages, Vol 8 (IEF-IGD)*.

Example:

If you enter D ALLOC,OPTIONS,L=Z, the output appears in the following format:

DISPLAY ALLOC,OPTIONS command

```
IEFA003I 12.58.57 ALLOC OPTIONS
SPACE      PRIMARY:      4
           SECONDARY:   24
           DIRECTORY:   0
           MEASURE:     AVEBLK
           BLKLNTH:     8192
           ROUND:       NOROUND
           PRIM_ORG:    NONCONTIG
           RLSE:        RLSE
UNIT       NAME:         SYSALLDA
           UNITAFF:     SYSTEM DEFAULT
           REDIRECTED_TAPE: TAPE
TIOT       SIZE:         32 (MAX DDS: 1635)
SDSN_WAIT  WAITALLOC:   NO
VOLUME_ENQ POLICY:       WTOR
VOLUME_MNT POLICY:       WTOR
SPEC_WAIT  POLICY:       WTOR
ALLC_OFFLN POLICY:       WTOR
CATLG_ERR  FAILJOB:     NO
           ERRORMSG:    NO
2DGT_EXPDT POLICY:       ALLOW
VERIFY_VOL POLICY:       YES
SYSTEM     IEFBR14_DELMIGDS: LEGACY
           TAPELIB_PREF: EQUAL
           REMIND_INTV:  90
           VERIFY_UNCAT: FAIL
           TEMPDSFORMAT: INCLUDELABEL
           MEMDSENQMGMT: DISABLE
           BATCH_RCLMIGDS: SERIAL
           OPTCDB_SPLIT: EXPLICIT
```

Displaying MVS device allocation IGDE information

Use the DISPLAY ALLOC,IGDEINFO command to display internal information about a given tape device to be provided to IBM Technical Support.

DISPLAY ALLOC,IGDEINFO
D ALLOC,IGDEINFO,DEVICE D = d
[,L={a name name-a}]

DEVICE or D = d

Indicates to display internal information about the specified device.

L=a, name, or name-a

Specifies the display area (*a*), console name (*name*), or both (*name-a*) where the display is to appear.

If you omit this operand, the display is presented in the first available display area or the message area of the console through which you enter the command.

Note: For the output of the DISPLAY ALLOC,IGDEINFO command, see the description of message IEFA004I in *z/OS MVS System Messages, Vol 8 (IEF-IGD)*.

Displaying APPC/MVS information

Use the DISPLAY APPC command to display information about the APPC/MVS configuration.

DISPLAY APPC command

```

D APPC, {TP[ ,SUMMARY|SUM|S] [, {ASID|A}=asid]           }
      |,LIST|,L           [,ASNAME=asname]
      |,ALL|,A           [,DIR=IN|OUT]
                        [,IT=sssss[.ttt]]
                        [,LLUN=lluname]
                        [,LTPN=ltpname]
                        [,PNET=pnetid]
                        [,PLUN=pluname]
                        [,PTPN=ptpname]
                        [,SCHED={schedname}]
                        { *NONE* }
                        [,STPN=stpname]
                        [,USERID=userid]

{UR[ ,SUMMARY|SUM|S] [,URID=urid]           }
  |,LIST|,L           [,LUWID=luid]
  |,ALL|,A           [,PNET=pnetid]
                  [,PLUN=pluname]
                  [,LLUN=lluname]

{SERVER[ ,SUMMARY|SUM|S] [, {ASID|A}=asid]           }
  |,LIST|,L           [,ASNAME=asname]
  |,ALL|,A           [,LLUN=lluname]
                  [,STPN=stpname]

{LU[ ,SUMMARY|SUM|S] [,LLUN=lluname]           }
  |,LIST|L           [,PNET=pnetid]
                  [,PLUN=pluname]
  |,ALL|A           [,SCHED={schedname}]
                  { *NONE* }

[,L={a|name|name-a}]

```

The parameters are:

TP Indicates that the system is to display information (message ATB102I) about local transaction programs (TPs) and their conversations.

SUMMARY or SUM or S

Indicates that the system is to use the SUMMARY form of output. The resulting message contains the number of local transaction programs and the number of inbound and outbound conversations.

LIST or L

Indicates that the system is to use the LIST form of output. This output is the same as the SUMMARY display, followed by a list of the transaction programs that are running or that were selected through optional keyword filter parameters. Each entry in the list contains the name of a local transaction program, along with related information.

ALL or A

Indicates that the system is to use the ALL form of output. This output is the same as the LIST output, except that the system inserts a sublist after each entry in the list of transaction programs. The sublist contains information about each conversation associated with the particular local transaction program.

Note: For the output of the DISPLAY APPC,TP command, see the description of message ATB102I.

SERVER

Indicates that the system is to display information (message ATB103I) about APPC/MVS servers and the allocate queues they are serving.

SUMMARY or SUM or S

Indicates that the system is to use the SUMMARY form of output. The resulting display contains the number of servers, the number of allocate queues, and the total number of queued allocate requests in the system.

LIST or L

Indicates that the system is to use the LIST form of output. This output is the same as the SUMMARY display, followed by a list of allocate queues. Each entry in the list contains the name of the served transaction program associated with the allocate queue, along with related information.

ALL or A

Indicates that the system is to use the ALL form of output. This output is the same as the LIST output, except that the system inserts a sublist after each entry in the list. The sublist contains information about each server for a particular allocate queue.

Note: For the output of the DISPLAY APPC,SERVER command, see the description of message ATB103I.

LU Indicates that the system is to display information (message ATB101I) about logical units (LUs).

SUMMARY or SUM or S

Indicates that the system is to use the SUMMARY format of output. The resulting display contains the number of active, outbound, pending, and terminating logical units.

LIST or L

Indicates that the system is to use the LIST form of output. This output is the same as the SUMMARY display, followed by a list of logical units. Each entry in the list contains the name of a local logical unit, and related information.

ALL or A

Indicates that the system is to use the ALL form of output. This output is the same as the LIST output, except that the system inserts a sublist after each entry in the list. The sublist contains the names of the partner logical units that have sessions established with the local logical unit.

Note: For the output of the DISPLAY APPC,LU command, see the description of message ATB101I.

The following is a list of keywords that filter the displays. When you specify a filter keyword, the system displays only the data that meet the keyword's criteria.

Note:

1. The same keyword cannot be used twice with a single command.
2. A command line cannot exceed 126 characters in length.

ASID or A=asid

The address space identifier of the transaction program (with DISPLAY APPC,TP) or server (with DISPLAY APPC,SERVER). Specify a one- to four-digit hexadecimal value.

DISPLAY APPC command

ASNAME=*asname*

The address space name of the transaction program (with DISPLAY APPC,TP) or server (with DISPLAY APPC,SERVER). The address space name is one to eight alphanumeric (a-z, 0-9) or special (@, #, \$) characters, but the first character **cannot** be numeric (0-9).

DIR=IN or OUT

The direction of the conversation. DIR can have the values: IN (for INBOUND), or OUT (for OUTBOUND). These values specify INBOUND conversations, which the partner transaction program allocated, and OUTBOUND conversations, which the local transaction program allocated.

IT=*sssss* [*.ttt*]

The idle time for a conversation. Idle time is the amount of time that the local transaction program waits for data or for a confirmation from the partner transaction program. *sssss* specifies the number of seconds, from 0 - 99999; *ttt* specifies the number of thousandths of a second, from .0 - .999. When you specify this keyword, the system displays only conversations with an idle time greater than or equal to the value you specify.

LLUN=*lluname*

The local logical unit name. This name is one to eight alphanumeric (a-z, 0-9) or special (@, #, \$) characters, but the first character **cannot** be numeric (0-9).

LTPN=*ltpname*

The local transaction program name. This name is one to 64 alphanumeric (a-z, 0-9) or special (@, #, \$) characters. The name may also contain the characters in character set 00640, except for the following:

- comma(,) - used as a parameter delimiter and means that the preceding character is interpreted as the end of the transaction program name
- blank() - used as a parameter delimiter and means that the preceding character is interpreted as the end of the transaction program name
- asterisk(*) - used to filter the name of the transaction program. It can only be used as the last character of the name. An asterisk causes the LTPN keyword filter to match every transaction program name that begins with the characters preceding the asterisk.

You abbreviate the name of the local transaction program by entering the first part of the name, followed by an asterisk. For example, PROCESS* matches every local transaction program name that begins with the letters PROCESS.

To list all the local, non-served TPs on the system (and filter out served TPs), enter LTPN=*

You can also specify the asterisk as the last character of the displayable format of a SNA service transaction program name.

The displayable format of the SNA service transaction program name is in the form:

```
-X'hh'ccc
```

Where *hh* is the hexadecimal value for the first non-displayable character and *ccc* is a character string (one to three characters) from character set Type A. You can abbreviate the name of the SNA transaction program by entering the first part of the name, followed by an asterisk.

Character sets 00640 and Type A are listed in *z/OS MVS Planning: APPC/MVS Management*.

PNET=*pnetid*

The network ID where the partner LU resides. This ID is one to eight

alphanumeric (a-z, 0-9) or special (@, #, \$) characters, and is equivalent to the network-ID portion of a network-qualified LU name. Together with the PLUN parameter, PNET filters the information to be displayed.

PLUN=*pluname*

The partner logical unit name. This name is one to eight alphanumeric (a-z, 0-9) or special (@, #, \$) characters, and is equivalent to the network-LU-name portion of a network-qualified LU name. The first character **cannot** be numeric (0-9).

Together with the PNET parameter, PLUN filters the partner LU information to be displayed, as follows:

- PNET=*pnetid*, without a value for PLUN, results in a display of all partner LUs in only the specified network.
- PLUN=*pluname*, without a value for PNET, results in a display of all the partner LUs that share the same specified network LU name in all the networks in the installation.
- PNET=*pnetid* with PLUN=*pluname* results in a display of only the partner LU that has a network-qualified name that matches the specified network ID and network LU name.
- A DISPLAY command without specified values for PNET and PLUN results in a display of information for all partner LUs in all networks.

PTPN=*ptpname*

The partner transaction program name. This name is one to 64 alphanumeric (a-z, 0-9) or special (@, #, \$) characters. The name may also contain the characters in character set 00640, except for the following:

- comma(,) - used as a keyword delimiter and means that the preceding character is interpreted as the end of the transaction program name
- blank() - interpreted as the end of the command and means that the preceding character is interpreted as the end of the transaction program name
- asterisk(*) - used to filter the partner transaction program name, it can only be used as the last character of the name. It causes the PTPN keyword filter to match every transaction program name which begins with the characters preceding the asterisk.

You can abbreviate the name of the partner transaction program by entering the first part of the name, followed by an asterisk. For example, PROCESS* matches every partner transaction program name that begins with the letters PROCESS.

You can also specify the asterisk as the last character of the displayable format of a SNA service transaction program name.

The displayable format of the SNA service transaction program name is in the form:

```
-X'hh'ccc
```

Where *hh* is the hexadecimal value for the first non-displayable character and *ccc* is a character string (one to three characters) from character set Type A. You can abbreviate the name of the SNA transaction program by entering the first part of the name, followed by an asterisk.

Character sets 00640 and Type A are listed in *z/OS MVS Planning: APPC/MVS Management*.

DISPLAY APPC command

SCHED=*schedname* or ***NONE***

The transaction scheduler name or ***NONE***. The scheduler name is one to eight alphanumeric (a-z, 0-9) characters. Special characters (@, #, \$) are not permitted.

For the DISPLAY APPC,TP command, the system displays only the transaction programs scheduled for the transaction scheduler you specify. If you specify ***NONE*** instead of the name of a transaction scheduler, the system displays only those transaction programs that are not associated with a transaction scheduler (such as transaction programs engaged in an outbound conversation, or transaction programs that are served by an APPC/MVS server).

For the DISPLAY APPC,LU command, the system displays only the logical units controlled by the transaction scheduler you specify. If you specify ***NONE*** instead of the name of a transaction scheduler, the system displays only those logical units that are not associated with a transaction scheduler. These logical units are known as NOSCHED logical units.

Note: The installation defines the names of the transaction schedulers on the SCHED keyword in the APPCPMxx parmlib member. Although lower-case alphabetic characters are not permitted for scheduler names specified in parmlib, you can use lower-case on the SCHED keyword name. The system translates lower-case characters to their upper-case equivalent before it processes the DISPLAY APPC command.

STPN=*stpname*

The name of the served transaction program (TP). For DISPLAY APPC,TP, this is the name of a TP that was served by an APPC/MVS server on this system. For DISPLAY APPC,SERVER, this is the TP name for which the server registered.

The name of the served transaction program is one to 64 alphanumeric (a-z, 0-9) or special (@, #, \$) characters. This name may also contain the characters in character set 00640, except for the following:

- comma(,) - used as a keyword delimiter and means that the preceding character is interpreted as the end of the transaction program name
- blank() - interpreted as the end of the command and means that the preceding character is interpreted as the end of the transaction program name
- asterisk(*) - used to filter the served transaction program name, it can only be used as the last character of the name. It causes the STPN keyword filter to match every transaction program name that begins with the characters preceding the asterisk.

You abbreviate the name of the served transaction program by entering the first part of the name, followed by an asterisk. For example, SERV* matches every served transaction program name that begins with the letters SERV.

To list all the served TPs on the system (and filter out non-served TPs), enter STPN=*

You can also specify the asterisk as the last character of the displayable format of a SNA service transaction program name.

The displayable format of the SNA service transaction program name is in the form:

```
-X'hh'ccc
```

Where *hh* is the hexadecimal value for the first non-displayable character and *ccc* is a character string (one to three characters) from character set Type A. You

can abbreviate the name of the SNA transaction program by entering the first part of the name, followed by an asterisk.

Character sets 00640 and Type A are listed in *z/OS MVS Planning: APPC/MVS Management*.

USERID=userid

The userid of the transaction program that is running because of an allocate request. For an inbound conversation, this is the userid of the local MVS transaction program. For an outbound conversation, this is the userid of the partner transaction program. If you specify this keyword with the TP parameter, the system only displays conversations in which the userid of the allocated transaction program matches the userid you specify. The userid is one to ten alphanumeric (a-z,0-9) or special (@, #, \$) characters.

L=a, name, or name-a

Specifies the display area (*a*), console name (*name*), or both (*name-a*) where the display is to appear.

If you omit this operand, the display is presented in the first available display area or the message area of the console through which you enter the command.

Displaying ASCH configuration information

Use the DISPLAY ASCH command to display information about the APPC/MVS scheduler configuration (message ASB101I).

```

D ASCH
D ASCH{[,SUMMARY|,SUM|,S ][, {ASID|A}=asid] }
  { |,LIST|,L           [, {CLASS|C}=classname] }
  { |,ALL|,A           [,LTPN=ltpname] }
  {                   [,QT=sssss[.ttt]] }
  {                   [,TPST=schedtype] }
  {                   [,USERID=userid] }

[,L={a|name|name-a}]
    
```

The parameters are:

SUMMARY or SUM or S

Indicates that the system is to use the SUMMARY format of output. The resulting message contains the number of classes, active and queued transactions, idle initiators, and total number of initiators. It also shows the global settings for the IBM-supplied APPC/MVS transaction scheduler, which are specified in ASCHPMxx parmlib member on the TPDEFAULT and SUBSYS keywords.

LIST or L

Indicates that the system is to use the LIST form of output. This output is the same as the SUMMARY output, followed by a list of APPC/MVS transaction scheduler classes. Each entry in the list contains the name of a class, along with related information.

ALL or A

Indicates that the system is to use the ALL form of output. This output is the same as the LIST output, except that the system inserts a sublist after each

DISPLAY ASCH command

entry in the list. The sublist contains information about each transaction program assigned to the APPC/MVS transaction scheduler class.

Note: For the output of the DISPLAY ASCH command, see the description of message ASB101I.

The following is a list of keywords that filter the displays. When you specify a filter keyword, the system displays only the data that meets the keyword's criteria.

Note:

1. The same keyword cannot be used twice with a single command.
2. A command line cannot exceed 126 characters in length.

ASID or **A=asid**

The address space identifier of the transaction program. The identifier is a one- to four-digit hexadecimal value.

CLASS or **C=classname**

The name of the APPC/MVS transaction scheduler class. The class name is one to eight alphanumeric (a-z, 0-9) or special (@,#,\$) characters.

LTPN=ltpname

The local transaction program name. This name is one to 64 alphanumeric (a-z, 0-9) or special (@,#,\$) characters. The name may also contain the characters in character set 00640, except for the following:

- comma(,) - used as a keyword delimiter and means that the preceding character is interpreted as the end of the transaction program name
- blank() - interpreted as the end of the command and means that the preceding character is interpreted as the end of the transaction program name
- asterisk(*) - used to filter the local transaction program name, it can only be used as the last character of the name. It causes the LTPN keyword filter to match every transaction program name which begins with the characters preceding the asterisk.

You can abbreviate the name of the local transaction program by entering the first part of the name, followed by an asterisk. For example, PROCESS* matches every local transaction program name that begins with the letters PROCESS.

You can also specify the asterisk as the last character of the displayable format of a SNA service transaction program name.

The displayable format of a SNA service transaction program name is in the form:

```
-X'hh'ccc
```

Where *hh* is the hexadecimal value for the first non-displayable character and *ccc* is a character string (one to three characters) from character set Type A. You can abbreviate the name of the SNA transaction program by entering the first part of the name, followed by an asterisk.

Character sets 00640 and Type A are listed in *z/OS MVS Planning: APPC/MVS Management*.

QT=sssss[.ttt]

The queue time, in seconds, of a local transaction program waiting for initiation. *sssss* specifies the number of seconds, from 0 - 99999; *ttt* specifies the number of thousandths of a second, from .0 - .999. When you specify this

keyword, the system displays only transaction programs that have been queued for an amount of time greater than or equal to the value you specify.

TPST=*schedtype*

The scheduling type of the transaction program. This keyword can have values of: STD, STANDARD, MT, or MULTITRANS.

USERID=*userid*

The userid of the transaction program that is running because of an allocate request. The system displays only initiators that are running programs on behalf of the userid you specify. The userid is one to ten alphanumeric (a-z,0-9) or special (@,#,\$) characters.

L=*a*, *name*, or *name-a*

Specifies the display area (*a*), console name (*name*), or both (*name-a*) where the display is to appear.

If you omit this operand, the display is presented in the first available display area or the message area of the console through which you enter the command.

Displaying auxiliary storage information

Use the DISPLAY ASM command to identify the page data sets and storage-class memory (SCM) blocks that the system is currently using. You can request this information for each data set of a given type, or for a specific data set.

If you request information by data set type, the following information is displayed in message IEE200I for each data set of the specified type that the system is currently using:

- Type of data set
- Percent full
- Status
- Device number
- Data set name

If you request information about the PLPA or common data set, or about a specific page data set, you receive all the preceding information, plus:

- Volume serial number
- Device type
- Data set size (in slots)
- Number of slots that are currently in use
- Number of slots that are currently available
- Number of permanent I/O errors that have occurred on the specified data set

D ASM	
D ASM[,PLPA][,L={a name}name-a]
,COMMON	
,LOCAL	
,SCM	
,ALL	
,PAGE=[dsname ALL]	
,PAGEDEL	

DISPLAY ASM command

ASM

The system is to display information about the page data sets and storage-class memory (SCM) the system is currently using. If you specify DISPLAY ASM with no operands, the system displays information about all page data sets and SCM that it is currently using and the status of the PAGEDEL command.

PLPA

Requests information about the PLPA page data set.

COMMON

Requests information about the common page data set.

LOCAL

Requests information about all local page data sets.

SCM

Requests information about storage-class memory (SCM) that is used for paging.

ALL

Requests information about all page data sets, storage-class memory (SCM) and the status of the PAGEDEL command.

PAGE

Requests information about page data sets.

ALL

Requests information about all page data sets.

dsname

Requests information about the page data set named *dsname*.

PAGEDEL

Requests information about the PAGEDEL command, active or inactive.

L=a, name, or name-a

Specifies the display area (*a*), console name (*name*), or both (*name-a*) where the display is to appear.

If you omit this operand, the display is presented in the first available display area or the message area of the console through which you enter the command.

Example 1:

To display summary information about all page data sets, storage-class memory (SCM) and the PAGEDEL command status, enter:

```
DISPLAY ASM,ALL or D ASM
```

Output is similar to:

```
TYPE      FULL STAT  DEV  DATASET NAME
PLPA      100% FULL  02E6 SYS1.PLPA.PAGCOM
COMMON    71%  OK   02E6 SYS1.COMMON.PAGCOM
LOCAL     1%   OK   098E SYS1.LOCAL.PAGEP2
LOCAL     1%   OK   0981 SYS1.COMMON
LOCAL     0%   OK   0484 PAGE2
SCM       5%   OK   N/A   N/A
PAGEDEL COMMAND IS NOT ACTIVE
```

Example 2:

To display detailed information about storage-class memory (SCM), enter:

D ASM,SCM

Output is similar to:

STATUS	FULL	SIZE	USED	IN-ERROR
IN-USE	xxx%	xx,xxx,xxx,xxx	xx,xxx,xxx,xxx	xx,xxx,xxx,xxx

Note: If the D ASM,SCM command is issued and storage-class memory (SCM) is not being used for paging, message IEE207I is issued with a status value of NOT-USED, even if SCM is defined to the partition.

To display detailed information about the PLPA data set, enter:

D ASM,PLPA

Example 3:

To display only paging data set information, enter:

D ASM,PAGE or D ASM,PAGE=ALL

D ASM,PAGE output is similar to:

TYPE	FULL	STAT	DEV	DATASET NAME
PLPA	100%	FULL	02E6	SYS1.PLPA.PAGCOM
COMMON	69%	OK	02E6	SYS1.COMMON.PAGCOM
LOCAL	0%	OK	098E	SYS1.LOCAL.PAGEP2
LOCAL	0%	OK	0981	SYS1.COMMON
LOCAL	0%	OK	0484	PAGE2

D ASM,PAGE=ALL output is similar to:

TYPE	FULL	STAT	DEV	DATASET NAME
PLPA	100%	FULL	02E6	SYS1.PLPA.PAGCOM
COMMON	69%	OK	02E6	SYS1.COMMON.PAGCOM
LOCAL	0%	OK	098E	SYS1.LOCAL.PAGEP2
LOCAL	0%	OK	0981	SYS1.COMMON
LOCAL	0%	OK	0484	PAGE2

Displaying auto-reply policy and WTORs information

Use the DISPLAY AUTOR command to display the current auto-reply policy and the current WTORs being monitored by auto-reply processing.

The complete syntax for the DISPLAY AUTOR command is:

D AUTOR
D AUTOR[,POLICY ,P] [,WTORS ,W] [,L={a name name-a}]

The parameters are:

POLICY or P

Requests that the auto-reply policy active on the system be displayed in message CNZ2603I.

WTORS or W

Requests that the current outstanding WTORs being monitored by auto-reply processing be displayed in message CNZ2604I.

DISPLAY AUTOR command

L=a, name, or name-a

Specifies the display area (*a*), console name (*name*), or both (*name-a*) where the display is to appear.

If you omit this operand, the display is presented in the first available display area or the message area of the console through which you enter the command.

Note: For a complete description of messages CNZ2603I and CNZ2604I, see *z/OS MVS System Messages, Vol 4 (CBD-DMO)*.

Examples:

Assume that the AUTOR00 member contains the following:

```
/*-----\
| IXC371D CONFIRM REQUEST TO VARY SYSTEM xxx OFFLINE.
| REPLY SYSNAME=xxx TO REMOVE xxx OR C TO CANCEL.
|-----*/
Msgid(IXC371D) Delay(1m) Reply(C)

/*-----\
| IEE800D CONFIRM VARY FORCE FOR xxx - REPLY NO OR YES
|-----*/
Msgid(IEE800D) Delay(1m) Reply(NO)
```

If the auto-reply policy is displayed, the output of the D AUTOR,P command is:

```
D AUTOR,P
CNZ2603I 06.46.34 AUTOR POLICY
POLICY ACTIVATED AT 06.45.32 ON 12/25/2008 NOTIFYMSG(S)(HC)
FROM PARMLIB MEMBERS 00
--MSG ID-- DELAY MEM ----REPLY TEXT---
IEE800D      1M 00 NO
IXC371D      1M 00 C
```

If WTORs IEE800D and IXC371D are issued and are waiting to be replied to by auto-reply processing, the output of the D AUTOR,W command is:

```
D AUTOR,W
CNZ2604I 06.47.02 AUTOR WTOR(S)
0009 STATUS=06.47.58 SYS=SY1
      MSG=IEE800D CONFIRM VARY FORCE FOR 3D0 - REPLY NO OR YES
      REPLY=NO
0008 STATUS=06.47.46 SYS=SY1
      MSG=IXC371D CONFIRM REQUEST TO VARY SYSTEM SY1 OFFLINE. REPLY
      SYSNAME=SY1 TO REMOVE SY1 OR C TO CANCEL.
      REPLY=C
```

Displaying the current system level language environment run-time options

Use the DISPLAY CEE command to list one or more parmlib members that can create the current system level Language Environment run-time options. The DISPLAY CEE command can also be used to display the contents of the table.

D CEE
D CEE[,CEEOPT] [,L={a name name-a}]
,CEEDOPT
,CELQDOPT
,CEEROPT
,CELQROPT
,ALL

CEEOPT

Displays the options to be used in a CICS® environment.

CEEDOPT

Displays the options to be used in a 31-bit run-time.

CELQDOPT

Displays the options to be used in a 64-bit run-time.

CEEROPT

Displays whether region-specific run-time options are used in a non-CICS or non-LRR environment.

CELQROPT

Displays whether region-specific run-time options are used in AMODE 64.

ALL

Displays all keywords with their respective options.

L=a, name, or name-a

Specifies the display area (*a*), console name (*name*), or both (*name-a*) where the display is to appear.

Example 1:

```
D CEE
CEE3744I hh.mm.ss DISPLAY
CEE=(xx)
```

Where *xx* is the CEEPRM member suffix specified at IPL or with the SET CEE command.

Example 2:

```
D CEE,CEEDOPT
CEE3745I hh.mm.ss DISPLAY CEEOPT
CEE=(xx)
LAST WHERE SET          OPTION
-----
PARMLIB(CEEPRMxx)      ABPERC(NONE)
SETCEE command         ALL31(ON)
...
PARMLIB(CEEPRMxx)      XUFLOW(AUTO)
```

The option listed are only those specified in the SET CEE or SETCEE command.

Example 3:

Assume that a SET CEE=(mc) command has been issued. To display the CEEROPT setting, enter:

```
D CEE,CEEROPT
```

The output looks like:

DISPLAY CEE command

```
CEE3745I 16.17.23 DISPLAY CEEROPT
CEE=(MC)
PARMLIB(CEEPRMMC) CEEROPT (COMPAT)
```

Example 4:

Assume that a SETCEE CELQROPT,ALL command has been issued. To display the CELQROPT setting, enter:

```
D CEE,CELQROPT
```

The output looks like:

```
CEE3745I 16.14.52 DISPLAY CELQROPT
CEE=(MC)
SETCEE COMMAND CELQROPT(ALL)
```

Displaying CONTROL command functions

Use the DISPLAY C,K command to request a summary (message IEE162I) of the CONTROL command operands and the functions they perform.

D C,K
D C,K[,L={a name name-a}]

C,K

A summary of CONTROL command operands is to be displayed.

L=*a*, *name*, or *name-a*

Specifies the display area (*a*), console name (*name*), or both (*name-a*) where the display is to appear.

If you omit this operand, the display is presented in the first available display area or the message area of the console through which you enter the command.

Example 1:

To display the CONTROL command operands and their functions in display area A of console named CON5, enter:

```
D C,K,L=CON5-A
```

Example 2:

To display a summary of CONTROL command operands in display area A of console named CON10, enter:

```
D C,K,L=CON10-A
```

Displaying attached coupling facility information

Use the DISPLAY CF command to display storage and attachment information about coupling facilities attached to the system on which the command is processed.

D CF
D CF[,CFNAME={(cfname[,cfname]...)}][,L={a name name-a}]

CF Requests the system to display information about the coupling facilities that are attached to the system. If specified without further qualification, the system displays information about all coupling facilities that are attached.

CFNAME= or CFNM= *cfname*

Requests that information for one or more named coupling facilities be displayed.

cfname specifies the logical name of a coupling facility for which information is requested.

L=*a*, *name*, or *name-a*

Specifies the display area (*a*), console name (*name*), or both (*name-a*) where the display is to appear.

If you omit this operand, the display is presented in the first available display area or the message area of the console through which you enter the command.

Displaying console group definitions

Use the DISPLAY CNGRP command to display the console group definitions in effect for the sysplex. The definitions, activated via a SET CNGRP command or the INIT statement in CONSOLxx, are obtained from the currently active CNGRPxx parmlib members. There are three options for this command:

- Display all active console groups with their names.
- Display all console names associated with input group names.
- Display only console group names active in the sysplex.

D CNGRP

```
D CNGRP[, {GROUP|G} [= (name[, name] ...)] [, L={a|name|name-a}]
```

CNGRP

The system is to display information (message IEE679I) about the console groups currently defined to the system or sysplex. If you specify this keyword alone, the system displays all the group names and the console names associated with each group.

GROUP or G

The system is to display information on specific console groups. If GROUP is the last keyword in the command, then only the names of all active groups are displayed.

name [, *name*]

The system is to display all console names associated with each input group name. Valid group names are a maximum of 8 characters long.

L=*a*, *name*, or *name-a*

Specifies the display area (*a*), console name (*name*), or both (*name-a*) where the display is to appear.

If you omit this operand, the display is presented in the first available display area or the message area of the console through which you enter the command.

Example 1:

DISPLAY CNGRP command

To DISPLAY all active console group definitions with their names, enter:

```
DISPLAY CNGRP
```

Example 2:

To DISPLAY the names of all active console groups, enter:

```
DISPLAY CNGRP, GROUP
```

or

```
DISPLAY CNGRP, G
```

Example 3:

To DISPLAY the console names associated with the console groups NEWYORK and PHILLY, enter:

```
DISPLAY CNGRP, G=(NEWYORK, PHILLY)
```

Displaying console status information

Use the DISPLAY CONSOLES command to display the status of all consoles or specified consoles in the sysplex, including HMCS and SMCS. If you need information about extended MCS (EMCS) consoles, use the DISPLAY EMCS command to display information for extended MCS consoles.

See Figure 19 on page 124 and Figure 18 on page 118 for examples of the resulting display of the DISPLAY CONSOLES and DISPLAY CONSOLES, BACKLOG commands. The syntax of the command is:

```

D {CONSOLES|C}, {ACTIVE|A} [,CA={name          }] [,SYS=system-name]
  {NACTIVE|N}      {(name[,name]...)}

      [,CN={name          }] [,ROUT={NONE|ALL|rr }] [,SYS=system-name] [, {SUMMARY|S}] ]
      {(name[,name]...)}   {(rr-ss)          }   {FULL|F   }
                          {(rr[,ss]...)}

      [,MSTR[,ROUT={NONE|ALL|rr }] [,SYS=system-name] [, {SUMMARY|S}] ]
      {(rr-ss)          }   {FULL|F   }
      {(rr[,ss]...)}

      [,U={[/]dev          }] [,ROUT={NONE|ALL|rr}] [, {SUMMARY|S}] ]
      {[[/]dev1[,[/]dev2]...]}   {(rr[,ss]...)}   {FULL,F   }
      {[[/]dev1[-[/]dev2]...]}   {(rr-ss)          }

{SS      } [,CN={name          }] [,ROUT={NONE|ALL|rr }] [,SYS=system-name] [, {SUMMARY|S}] ]
      {(name[,name]...)}   {(rr-ss)          }   {FULL|F   }
                          {(rr[,ss]...)}

      [,MSTR[,ROUT={NONE|ALL|rr }] [,SYS=system-name] [, {SUMMARY|S}] ]
      {(rr-ss)          }   {FULL|F   }
      {(rr[,ss]...)}

{BACKLOG|B }

{HARDCOPY|HC}

{KEY      } [=key[,SYS=system-name]]

{LIST|L   } [,SYS=system-name] [, {SUMMARY|S}]
      {FULL|F   }

{MASTER|M } [,SYS=system-name] [, {SUMMARY|S}]
      {FULL|F   }

{SHAREDMODE } [, {SUMMARY|S}]
      {FULL|F   }

{SMCS      }

{*      }
[,L={a|name|name-a}]

```

The parameters are:

CONSOLES or C

Displays console information in message CNZ4100I.

ACTIVE or A

Displays the status of all active MCS, HMCS, SMCS and subsystem consoles. Consoles in standby mode are also displayed.

Note: The ACTIVE parameter only works for extended MCS or system consoles when issued with the CN or MSTR parameter. Use the D EMCS command for these consoles.

NACTIVE or N

Displays the status of all MCS, HMCS, SMCS and subsystem consoles that are not active or in STANDBY mode..

DISPLAY CONSOLES command

Note: The NACTIVE parameter only works for extended MCS and system consoles when issued with the CN or MSTR parameter; use the D EMCS command for these consoles.

SS Displays the status of all allocatable subsystem consoles.

CA Displays, for a sysplex, the console/system association list to match the specified keyword, ACTIVE or NACTIVE.

CA=[name]

Displays the specified console name(s) in the sysplex to match the specified keyword, ACTIVE or NACTIVE. A console name can be 2 to 8 characters in length. You can specify wildcard characters (* and ?) in the console name.

CN=name

Displays the status of a console or consoles identified by console name. A console name can be 2 to 8 characters in length. You can specify wildcard characters (* and ?) in the console name.

MSTR

The system displays the status of the operators with master authority that match the specified keyword of ACTIVE, NACTIVE, or SS. MSTR is mutually exclusive with CA and U. MSTR can be issued with ROUT.

U= Displays the status of one or more consoles, identified by device numbers. A device number consists of 3 or 4 hexadecimal digits, optionally preceded by a slash (/).

[/]devnum

Displays the status of the console identified by device number *devnum*.

([/]devnum1[, [/]devnum2]...)

Displays the status of consoles identified by device numbers *devnum1*, *devnum2*, and so on.

([/]lowdevnum-[/]highdevnum)

Displays the status of the consoles identified by device numbers in the range of *lowdevnum-highdevnum*.

SYS=system-name

Displays the status of consoles that are active or eligible to be activated on the system you specify, and that match the other specified parameters.

SYS is mutually exclusive with BACKLOG (B), HARDCOPY (HC), KEY, *, and U=.

ROUT

Displays the status of consoles that receive messages identified by the routing code you specify.

NONE

Displays the status of consoles to which no messages are routed by routing code.

rr Displays the status of consoles that accept messages with a routing code of *rr*.

(rr[,ss]...)

Displays the status of consoles that accept messages with routing codes listed as *rr,ss*, and so forth.

(rr-ss)

Displays the status of consoles that accept messages with routing codes in the range of *rr* to *ss*.

ALL

Displays the status of consoles that accept messages by routing codes.

FULL or F

Displays the console attributes as they are defined on each system that matches the specified parameters.

If neither FULL (F) nor SUMMARY (S) is specified, the output depends on the status of the console that matches the specified parameters:

- If the console is active, Displays the console attributes as it is defined on the system where it is active.
- If the console is active and does not match the specified parameters on the system where it is active (but it does match the specified parameters on one or more systems where it is not active), Displays only the name, type, and status of the consoles that match the specified parameters. In addition, the name of each system where the consoles are defined and where they match the specified parameters are displayed.
- If the console is not active, Displays only the name, type, and status of the consoles that match the specified parameters. In addition, the name of each system where the consoles are defined and where they match the specified parameters are displayed.

SUMMARY or S

Displays only the name, type, and status of the consoles that match the specified parameters. In addition, the name of each system where the consoles is defined and where they match the specified parameters are displayed.

BACKLOG or B

Displays the status of all local consoles with a message backlog. It will list the information in descending order by quantity of backlogged messages.

HARDCOPY or HC

Displays the following information about the hardcopy message set or the hardcopy medium:

- Whether the hardcopy medium is SYSLOG or OPERLOG
- Whether the hardcopy message set is to include operator commands, responses, and status displays
- The routing codes for messages the system is to include in the hardcopy message set
- The number of messages waiting to be sent to the hardcopy medium.

The DISPLAY CONSOLES command response (CNZ4100I) will display SYSLOG and OPERLOG status.

KEY

Displays a list of available class names of extended MCS consoles.

KEY[=key]

Displays the list of active operators in the specified console class, where 'key' is a specific class name. See *z/OS MVS Planning: Operations* for more information.

DISPLAY CONSOLES command

LIST or L

Displays the status of consoles defined to the sysplex in CONSOLxx but not for extended MCS consoles.

MASTER or M

Displays the status of all consoles with master authority.

SHAREDMODE

Displays the status of all MCS, HMCS, SMCS and subsystem consoles that are available in console services shared mode. Use SHAREDMODE to display which consoles will continue to exist in console services shared mode.

Note: EMCS consoles are unaffected by a fallback from console services distributed mode to shared mode.

SMCS

Displays the status of the SMCS applications in the sysplex. The SMCS keyword is mutually exclusive with all other DISPLAY CONSOLES keywords.

* Displays the status of the console that issues the DISPLAY command.

L=*a*, *name*, or *name-a*

Specifies the display area (*a*), console name (*name*), or both (*name-a*) where the display is to appear.

If you omit this operand, the display is presented in the first available display area or the message area of the console through which you enter the command.

Example 1:

To display information about consoles named CON24 and TAPE, enter:

```
D C,CN=(CON24,TAPE)
```

Example 2:

To display information about all active consoles that receive messages with routing code 3, enter:

```
D C,A,ROUT=3
```

Example 3:

To display information about all subsystem consoles that receive routing code 15, enter:

```
D C,SS,ROUT=15
```

Example 4:

To display information about the console device number 81B, enter:

```
D C,U=81B
```

Example 5:

To display information about the console device number 3480, enter:

```
D C,U=/3480
```

Example 6:

To display the list of available class names (keys), enter:

D C,KEY

Example 7:

To display information about all consoles that are inactive or in STANDBY mode and have the output go to area A on the console named CON5, enter:

D C,N,L=CON5-A

Example 8:

To display information about hardcopy processing on console CON13, area B, enter:

D C,HC,L=CON13-B

Example 9:

To display only the names of all consoles that begin with the letters, SYS1, enter:

D C,CN=(SYS1*),S

Example 10:

To display information about the console named DAVE for every system where DAVE is defined, enter:

D C,CN=DAVE,F

Displaying DIAG parmlib information

Use the DISPLAY DIAG command to display the current options that have been set through DIAGxx parmlib members.

D DIAG
D DIAG[,L={a name name-a}]

DIAG

The system displays information about the current options set in DIAGxx. (Message IGV0071)

L=a, name, or name-a

Specifies the display area (*a*), console name (*name*), or both (*name-a*) where the display is to appear.

Example 1:

To display DIAGxx parmlib information, enter:

D DIAG

Displaying data lookaside facility information

Use the DISPLAY DLF command to display the names of the data sets that are currently being processed as DLF objects (message ISG343I). The ISG343I message

DISPLAY DLF command

output could include allocated Enq/Reserve resources that are not actually DLF objects. See *z/OS MVS System Messages, Vol 9 (IGF-IWM)*.

The complete syntax for the DISPLAY DLF command is:

D DLF
D DLF[,RES={{qname *}[,rname ,*]}}[,HEX][,L={a name name-a}]

The parameters are:

RES=(qname[,rname])

A list of major names or resource information for the specified resource(s). Only resources that have at least one requestor are displayed.

Note:

1. The recommended DISPLAY DLF syntax is:
DISPLAY DLF,RES=(SYSZSD0,*)
2. The parentheses around the resource name(s) in RES=(qname[,rname]) are required.

A resource name must consist of a qname (major name) and can include an rname (minor name). If you specify an asterisk (*) as the last character in the resource name, then the system treats the name as a generic name; the display includes all resources with names that match the portion of the name specified before the asterisk. For example, SYSV* indicates that set of resources whose names begin with SYSV. If you specify major name without a minor name, the system displays just a list of the specified major names of those resources that have requestors. You can specify a generic qname with a specific rname, and conversely, a specific qname with a generic rname.

Specify the HEX operand if you want the resource names to be displayed in EBCDIC and hexadecimal. Use it when you have resource names that contain characters that will not appear on your console (that is, those characters that are not defined in the figure, “;English (U.S) I/O Interface Code for 3277”, which appears in *IBM 3270 Information Display System*.)

How you specify qname (the major name) depends on the characters in the name.

qname

If qname only contains characters that are alphanumeric (A–Z and 0–9), national (#, @, and \$), and a period (.), specify either:

- 1–8 alphanumeric characters (a specific major name)
- 1–7 alphanumeric characters followed by an asterisk (*) (a generic major name)

'qname'

If qname consists of characters that can be displayed other than alphanumeric, national, or a period (excluding a single quotation mark), use the form 'qname'. The single quotation marks are required but do not count as part of the length specification for qname. For qname, specify either:

- 1–8 characters (a specific major name)
- 1–7 characters followed by an asterisk (*) after the closing single quotation mark (a generic major name)

X'qname'

If qname contains hexadecimal values or a single quotation mark, specify the name in hexadecimal in the form X'qname'. The prefix X and the single quotation marks enclosing qname are required but do not count as part of the length specification for qname. For qname, specify either:

- 2–16 hexadecimal digits (a specific major name)
 - 2–14 hexadecimal digits followed by an asterisk (*) after the closing single quotation mark (a generic major name)
- * If you want a list of the major names of all resources that have requestors, specify '*' to indicate a generic major name.

How you specify rname (the minor name) depends on the characters in the name.

rname

If rname contains characters that are alphanumeric (A–Z and 0–9), national (#, @, and \$), and/or a period (.), specify either:

- 1–52 alphanumeric characters (a specific minor name)
- 1–51 alphanumeric characters followed by an asterisk (*) (a generic minor name)

'rname'

If rname consists of characters that can be displayed other than alphanumeric, national, or a period (excluding a single quotation mark), use the form 'rname'. The single quotation marks are required but do not count as part of the length specification for rname. For rname, specify either:

- 1–52 characters (a specific minor name)
- 1–51 characters followed by an asterisk (*) after the closing single quotation mark (a generic minor name)

X'rname'

If rname contains hexadecimal values or a single quotation mark, specify the name in hexadecimal in the form X'rname'. The prefix X and the single quotation marks enclosing rname are required but do not count as part of the length specification for rname. For rname, specify either:

- 2–104 hexadecimal digits (a specific minor name)
 - 2–102 hexadecimal digits followed by an asterisk (*) after the closing single quotation mark (a generic minor name)
- * If you want information on all resources, specify '*' to indicate a generic minor name.

HEX

Resource information is to be displayed in hexadecimal as well as EBCDIC.

L=a, name, or name-a

Specifies the display area (a), console name (name), or both (name-a) where the display is to appear.

If you omit this operand, the display is presented in the first available display area or the message area of the console through which you enter the command.

Example 1:

To display resource information about all resources that have requestors, enter:

DISPLAY DLF command

```
D DLF,RES=(*,*)
```

Performance implication: This command gives you data about every allocated ENQ/RESERVE resource (including ones that may not actually be DLF objects, see *z/OS MVS System Messages, Vol 9 (IGF-IWM)*); therefore, there might be a very large display. If this command produces a large amount of output, the command output might fill WTO buffers, and degrade system response time. If the display exceeds the current supply of WTO buffers, an ABEND 09A with reason code 46FA will occur.

Example 2:

To display resource information about all resources whose major name is SYSDSN, enter:

```
D DLF,RES=(SYSDSN,*)
```

Example 3:

To display in EBCDIC and hexadecimal the outstanding ENQ/RESERVES that have a qname of SYSCTLG, enter:

```
D DLF,RES=(SYSCTLG,*),HEX
```

The display includes the hexadecimal representation of the resource name, SYSCTLG, with the hexadecimal representation under it:

```
SYSCTLG  
EEEEEDC  
2823337
```

Displaying dump options or dump data set status

Use the DISPLAY DUMP command to determine:

- Status and availability of pre- and automatically allocated dump data sets
- What dump mode and options are currently in effect
- The title and error-related data for pre- and automatically allocated dump data sets

D {DUMP}
D {DUMP},{ {STATUS ST S} }
{D } { {OPTIONS O} }
{ {TITLE T } },AUTODSN={aaa ALL} }
{ {ERRDATA ER E} { }
{,DSN={ALL (ALL) } }
{nn (nn[,nn]...) }
{nn-nn (nn-nn[,nn-nn]...) }
{(nn[,nn]...[,nn-nn[,nn-nn]...)} }
{,DUMPID={xxx (yyy[,zzz]...) } }
{aaa-bbb (aaa-bbb[,ccc-ddd]...) }
{(yyy[,zzz]...[,aaa-bbb[,ccc-ddd]...)} }
[,L={a name name-a}]

DUMP or D

The system is to display dump information.

STATUS or ST or S

The system is to display (message IEE852I) a summary of:

- Which SYS1.DUMP data sets are available and which are full
- How many dumps are captured in virtual storage and how much storage they occupy
- How much virtual storage is available for capturing additional dumps
- The status of automatic dump data set allocation
- What resources are defined for automatic dump data set allocation
- The naming convention currently in effect for automatically allocated dump data sets

OPTIONS or O

The system is to display:

- Coupling facility system failure dumping options
- Dump mode and options in effect for dump types:
 - SDUMP
 - SYSUDUMP
 - SYSMDUMP
 - SYSABEND

TITLE or T

The system is to display (message IEE853I) the dump data set name, title, and time of the dump for the captured dumps or dumps written to pre- or automatically allocated dump data sets as requested by the AUTODSN=, DSN=, and DUMPID parameters.

ERRDATA or ER or E

The system is to display (message IEE854I) error data for:

- Full direct access dump data sets that you specify in DSN=
- Automatically allocated dump data sets specified in AUTODSN=
- Captured dumps that you specify on the DUMPID parameter.

The error data for each full data set includes:

- Dump title
- Data set names for automatically allocated dump data sets
- Time of dump
- Error id, which includes the sequence number, the processor id, the ASID of the failing task, and the time stamp
- Abend code
- Reason code
- Module name
- Failing CSECT name
- Error PSW
- Translation exception address
- Abending program address
- Recovery routine address
- Registers at time of error

DISPLAY DUMP command

The SDWA furnishes most of the data that appears in the display caused by the DISPLAY DUMP,ERRDATA command. This means that if MVS/ESA is not in recovery mode, the display contains only the data set name, title, and time of the dump.

AUTODSN={*aaa* or ALL}

The system is to display the requested dump information about the dump data sets that were most recently allocated automatically. Only those dump data sets allocated since the last IPL will be presented. Dump data sets created in a previous IPL will not be displayed by this command.

aaa

Specifies the number of data sets for which information is displayed. *aaa* must have a value from 1 to 100.

ALL

The system displays information for all dump data sets that were automatically allocated to a maximum of one hundred.

AUTODSN=, DSN=, and DUMPID= are mutually exclusive.

DSN={ALL or *nn*}

The system is to display dump information about all direct access dump data sets or specific pre-allocated direct access dump data sets. For DSN= you can specify:

- All data sets
- One or more single data sets
- One or more ranges of data sets

For specific data sets or ranges, **nn** must have a value from 00 to 99. When you specify a range of data sets, the first **nn** in the range must be less than or equal to the second **nn**.

If you specify **DSN=ALL**, then the system also displays information about the one dump data set that was most recently allocated automatically.

DSN=, AUTODSN=, and DUMPID= are mutually exclusive.

DUMPID=*xxx* or *aaa- ddd*

The system is to display the dump information about specific captured dumps waiting to be written to dump data sets, as denoted by the three decimal digit DUMPID. You can specify for DUMPID= one or more single captured dump identifiers and/or one or more ranges of captured dump identifiers. For any of these specifications, the value must be in the range of 000 to 999. When you specify a range of captured dump identifiers, the first identifier must be less than the second identifier. Multiple identifiers or ranges must be enclosed in parentheses and separated by commas.

DSN=, AUTODSN=, and DUMPID= are mutually exclusive.

L=*a*, *name*, or *name-a*

Specifies the display area (*a*), console name (*name*), or both (*name-a*) where the display is to appear.

If you omit this operand, the display is presented in the first available display area or the message area of the console through which you enter the command.

Example 1:

To check the full or available status of all defined SYS1.DUMP data sets on both direct access and tape devices, enter:

```
D DUMP
```

Example 2:

To display the dump title for direct access dump data sets 1, 5, 6, 7, 8, 9, 10, and 90, enter:

```
D D,T,DSN=(01,05-10,90)
```

If any of these data sets are empty or undefined, the system tells you that dump data is not available for them.

Example 3:

To display error data for all full direct access dump data sets *and* the most recent automatically allocated dump data set, enter:

```
D D,ER,DSN=ALL
```

Example 4:

To display error data, if any, for direct access dump data sets 1-21, enter:

```
D D,ER,DSN=(01-21)
```

If any of these data sets are empty or undefined, the system tells you that dump data is not available for them.

Example 5:

To see the dump modes and dump options in effect for each dump type, enter:

```
D D,0
```

Example 6:

To DISPLAY the error data for captured dump 123, enter:

```
D D,ER,DUMPID=123
```

Example 7:

To DISPLAY the titles of captured dumps 123 and 456, enter:

```
D D,T,DUMPID=123,456
```

Example 8:

To DISPLAY the titles of all, or the one hundred most recent, automatically allocated dump data sets, enter:

```
D D,T,AUTODSN=ALL
```

Displaying extended MCS information

Use the DISPLAY EMCS command (instead of the DISPLAY CONSOLES command) to display information about extended MCS (EMCS) consoles.

When the system searches for any consoles you specify, it allows wildcard matching. CN, SYS, and KEY can include wildcard characters (* and ?) that allow a

DISPLAY EMCS command

single parameter to match many different actual conditions. For example, CN=AD? matches console names like AD1 or AD2 but not ADD1. CN=A* matches A1 or AD1 or ADD1.

The syntax for the DISPLAY EMCS command is:

D EMCS	
D EMCS, {SUMMARY S	} [,L={a name name-a}]
{INFO I	}
{FULL F	}
{STATUS=A N L B[{}] ERR	}
{ST	}
{CN=consname *	}
{SYS=sysname *	}
{KEY=keyname *	}
{AUTH={ANY}	}
{MASTER}	
{SYS}	
{IO}	
{CONS}	
{ALL}	
{INFO}	
{SYSONLY}	
{IOONLY}	
{CONSONLY}	
{ALLOONLY}	
{INFOONLY}	
{ATTR={ANY}	}
{YES}	
{ROUT}	
{HC}	
{AUTO(YES NO)}	
{MN}	
{NONE}	
{INTIDS}	
{UNKNIDS}	
{DOM={ANY}	}
{NORMAL}	
{ALL}	
{NONE}	
{YES}	

The parameters are:

EMCS

The system is to display console information about extended MCS (EMCS) consoles.

SUMMARY or S

The system is to display only the numbers and names for the consoles that meet the criteria.

INFO or I

The system is to display all console information, except statistics on the console's message data space, for the consoles that meet the criteria.

FULL or F

The system is to display all available information about the consoles that meet the criteria. Message data space statistics can only be displayed for consoles that are active on the system where the command is processed.

The following keyword parameters define the criteria used to limit the number of consoles displayed.

STATUS|ST=A|N|L|B[(nn)]|ERR

The system is to display information about extended MCS consoles according to console status:

A All extended MCS consoles that are active.

N All extended MCS consoles that are not active.

L Both active and inactive extended MCS consoles.

B[(nn)]

All consoles with a backlog of more than *nn* unretrieved delivered messages, where *nn* is a number from 1 to 999999. If you omit *nn*, the default is 10 unretrieved messages. Backlog information can only be displayed for consoles attached to the system that processes the command.

ERR

All consoles in an error state, such as consoles with queueing suspended. Error state information can only be displayed for consoles attached to the system that processes the command.

Note: Specifying B or ERR on STATUS forces the amount of information to be FULL.

CN=consname

The system is to display information according to console name. A console name can be from 1 to 8 characters. You can specify wildcard characters (* and ?) in the console name.

CN=* is a special case because * is not a wildcard character. CN=* means that the system is to display information about this console, the console you are using to enter the command.

Note: Specifying CN=*, or a console name with no wildcard characters, automatically forces STATUS=L.

SYS=sysname

The system is to display information about any consoles that are active or eligible to be activated on the system you specify, and that match the other specified parameters. A system name can be from 1 to 8 characters. You can specify wildcard characters (* and ?). The default is SYS=*, which matches all system names.

KEY=keyname

The system is to display information according to console key name, where *keyname* is the name your installation has assigned to a console group. (See *z/OS MVS Planning: Operations* for more information.) The name can be from 1 to 8 characters. You can specify wildcard characters (* and ?). The default is KEY=*, which matches all console class names.

AUTH=

The system is to display information about consoles with a specific console command authority, which may be one of the following:

DISPLAY EMCS command

ANY

Consoles with any authority.

MASTER

Consoles with MASTER authority.

SYS

Consoles with at least SYS authority (meaning MASTER authority, SYS authority alone, or SYS combined with IO or CONS or both).

IO Consoles with at least IO authority.

CONS

Consoles with at least CONS authority.

ALL

Consoles with at least ALL authority (SYS, IO, and CONS).

INFO

Consoles with at least INFO authority.

SYSONLY

Consoles with SYS authority only (not MASTER, CONS, or IO).

IOONLY

Consoles with IO authority only.

CONSONLY

Consoles with CONS authority only.

ALLONLY

Consoles with ALL authority only (meaning consoles with SYS, IO, and CONS authority, but not MASTER authority).

INFOONLY

Consoles with INFO authority only.

ATTR=

The system is to display information about extended MCS consoles that receive messages with a specific routing attribute, which may be one of the following:

ANY

Any consoles, regardless of routing attributes.

YES

Consoles that receive some type of unsolicited messages (either routing codes, hardcopy messages, AUTO(YES) messages, or MONITOR messages.)

ROUT

Consoles that receive any routing codes.

HC Consoles receiving the hardcopy message set.

AUTO[(YES|NO)]

Consoles that are or are not receiving AUTO(YES) messages. The default is YES.

MN Consoles receiving any type of MONITOR messages.

NONE

Consoles with no routing attributes.

INTIDS

Consoles receiving messages directed to console ID zero. If you do not specify, the system displays consoles with either Y or N value of INTIDS.

UNKNIDS

Consoles receiving messages directed to the old 1-byte format of console IDs. If you do not specify, the system displays consoles with either Y or N value of UNKNIDS.

DOM=

The system is to display information about extended MCS consoles according to specific DOM attributes.

ANY

Any consoles, regardless of DOM attributes.

NORMAL

Only consoles defined with DOM(NORMAL).

ALL

Only consoles defined with DOM(ALL).

NONE

Only consoles defined with DOM(NONE).

YES

Consoles defined with either DOM(ALL) or DOM(NORMAL).

L=*a*, *name*, or *name-a*

Specifies the display area (*a*), console name (*name*), or both (*name-a*) where the display is to appear.

If you omit this operand, the display is presented in the first available display area or the message area of the console through which you enter the command.

Example:

Assume a single system where the system console is named SYS01, and there are two two additional extended MCS consoles, named EMCS1 and EMCS2. If you issue the following command:

```
DISPLAY EMCS
```

The display includes only the console names (because SUMMARY is the default) of active extended MCS consoles (because STATUS=A is the default). The output of the command appears as follows:

```
IEE129I 13.35.15
DISPLAY EMCS DISPLAY EMCS
NUMBER OF CONSOLES MATCHING CRITERIA: 6
*DICNSY3 EMCS1 SY3 *ROUTEY3 EMCS2 *SYSLGY3
DISPLAY EMCS,INFO
```

The display includes all information except dataspace information (because you specified INFO) but will only include active consoles (because STATUS=A is the default). The output of the command looks like:

```
CNZ4101I 13.31.07 DISPLAY EMCS
DISPLAY EMCS,INFO
NUMBER OF CONSOLES MATCHING CRITERIA: 6
CN=*DICNSY3 STATUS=A CNID=01000001 KEY=NONE
SYS=SY3 ASID=0009 JOBNAME=----- JOBID=-----
HC=N AUTO=N DOM=ALL TERMNAME=*DICNSY3
MONITOR=-----
CMDSYS=SY3
LEVEL=ALL AUTH= INFO
MSCOPE=*ALL
```

DISPLAY EMCS command

```
ROUTCDE=ALL
INTIDS=N UNKNIDS=N
CN=EMCS1 STATUS=A CNID=01000002 KEY=EXAMPLE
SYS=SY3 ASID=0018 JOBNAME=EXTMCS JOBID=STC00029
HC=N AUTO=N DOM=NORMAL TERMNAME=EMCS1
MONITOR=-----
CMDSYS=SY3
LEVEL=ALL AUTH= MASTER
MSCOPE=*ALL
ROUTCDE=ALL
INTIDS=N UNKNIDS=N
CN=SY3 STATUS=A CNID=02000001 KEY=SYSCONS
SYS=SY3 ASID=0009 JOBNAME=----- JOBID=-----
HC=N AUTO=N DOM=NORMAL TERMNAME=SY3
MONITOR=-----
CMDSYS=SY3
LEVEL=ALL,NB AUTH= MASTER
MSCOPE=*ALL
ROUTCDE=NONE
AUTOACT=-----
INTIDS=N UNKNIDS=N
CN=*ROUTEY3 STATUS=A CNID=02000002 KEY=MVSRUTE
SYS=SY3 ASID=0009 JOBNAME=----- JOBID=-----
HC=N AUTO=N DOM=NONE TERMNAME=ROUTEALL
MONITOR=-----
CMDSYS=SY3
LEVEL=R,NB AUTH= CONS
MSCOPE=*ALL
ROUTCDE=NONE
INTIDS=N UNKNIDS=N
CN=EMCS2 STATUS=A CNID=02000003 KEY=EXAMPLE
SYS=SY3 ASID=0029 JOBNAME=EXTMCS JOBID=STC00030
HC=N AUTO=N DOM=NORMAL TERMNAME=EMCS2
MONITOR=-----
CMDSYS=SY3
LEVEL=ALL AUTH= MASTER
MSCOPE=*ALL
ROUTCDE=ALL
INTIDS=N UNKNIDS=N
CN=*SYSLGY3 STATUS=A CNID=03000001 KEY=SYSLOG
SYS=SY3 ASID=0009 JOBNAME=----- JOBID=-----
HC=N AUTO=N DOM=NONE TERMNAME=*SYSLGY3
MONITOR=-----
CMDSYS=SY3
LEVEL=ALL AUTH= MASTER
MSCOPE=SY3
ROUTCDE=NONE
INTIDS=N UNKNIDS=N
```

Displaying the timer synchronization mode and ETR ports

Use the DISPLAY ETR command to display the current timer synchronization mode and the status of the ETR ports as seen by MVS.

The DISPLAY ETR command issues the following information when the sysplex is running in STP mode:

- Timing mode
- CTN ID
- Time
- Node that is the source of the time, if applicable
- Redundant available timing links, if applicable
- Stratum level of the server

See message IEA386I for additional details.

The complete syntax for the DISPLAY ETR command is:

D ETR
D ETR[, <u>DATA</u>] [,L={a name name-a}]

ETR

Displays the current ETR (external time reference) synchronization and the status of the ETR ports.

DATA

Displays the status, in detail, of each ETR port, giving the ETR network ID, ETR port number, and the ETR ID.

L=a, name, or name-a

Specifies the display area (*a*), console name (*name*), or both (*name-a*) where the display is to appear.

If you omit this operand, the display is presented in the first available display area or the message area of the console through which you enter the command.

Example

To display the current timer synchronization mode status and the ETR ports, enter:
D ETR

The status is shown in this display:

```
IEA282I
hh.mm.ss ETR STATUS SYNCHRONIZATION MODE=mode CPC SIDE=id

CPC PORT 0      CPC PORT 1
   op           op
   enb          enb
```

where the fields in the message are:

hh.mm.ss

is the current time in hours(hh), minutes(mm), seconds(ss).

MODE=mode

is the current synchronization mode, ETR or LOCAL.

CPC SIDE=id

is the current CPC side id, 0 or 1.

op is the status of the port, operational or nonoperational.

enb

is the status of the port, enabled or disabled.

Displaying global resource serialization information

Use the DISPLAY GRS command to display information that helps you control the global resource serialization complex. The information includes:

- Configuration information:

The status of each system associated with the current global resource serialization complex is displayed. Some of the information displayed depends

DISPLAY GRS command

on whether you are running a global resource serialization ring or star complex. For instance, the status of the systems in the complex and the manner in which the systems are connected are different for a ring and a star complex.

- RNL information:
The contents of the RESERVE conversion, SYSTEMS exclusion, and SYSTEM inclusion resource name lists (RNLs).
- Resource information:
Information on resources for which there is contention or information about a specific resource.
- Information on resources that are delaying or suspending RNL changes.
If you do not code any keywords on the DISPLAY GRS command:
 - The information displayed for a star complex is the same as if you entered DISPLAY GRS,SYSTEM.
 - The information displayed for a ring complex is the same as if you entered DISPLAY GRS,SYSTEM, plus the configuration is displayed.
- Contention information:
A list of the units of work involved in contention for GRS-managed resources (both ENQ and Latch). This display can focus on the units of work that are waiting for the resources or those blocking the resources. In addition, the installation can display dependencies between requestors of GRS-managed resources. The display command provides both generic Contention and Analyze Contention functions. The Analyze function is recommended because it detects dependencies (including deadlock) between requestors, provides a complex wide view of System and Systems ENQ resources, and takes time into consideration to highlight the possible root cause of the contention. The Contention function only provides an alphabetical list of the resources that are in contention. The Contention function is not like the Analyze function in that a sysplex wide view of SYSTEM level ENQs is not provided in the former one. In addition to the SYSTEMS level ENQs, only the SYSTEM level ENQs that were requested from the issuing system are displayed. Also, time and dependencies are not considered. The Contention function is not like the Analyze function in that the former displays only System level ENQs that were requested from the issuing system and does not consider both time and dependencies.
- Information about the authorized qname level. The authorized qname level indicates the level of protection that exists for the system in the GRS complex through the use of different lists of qnames that are considered authorized.

When the keywords CONTENTION, RES=, RNL=, or any combination of them are specified together, the system will display a separate section for each keyword specified. Specifying the ALL keyword will override any parameters specified on the RNL= keyword.

The complete syntax for the DISPLAY GRS command is:

```

D GRS
  [,SYSTEM|,LINK|,ALL|,A|,DELAY|,D|,SUSPEND|S]
    [,CONTENTION|,C]
    [,RES=(qname *[,rname|,*])]
    [,HEX]
    [,DEV=[/]devnum][, {SUSPEND|S}]
    [,RNL={CONVERSION|CON|C}
      {ALL|A}
      {EXCLUSION|EXCL|E}
      {INCLUSION|INCL|I}

  {[,CONTENTION|C][,ENQ|,E][, {LATCH|L}[, {JOBNAME|JOB}=jobname][,LATCHID|LID][,HEX]}

  {[,LATCH|L][, {JOBNAME|JOB}=jobname][,CONTENTION|,C][,LATCHID|LID][,HEX]
    {CONTENTION|C}}

  {[,ANALYZE|,ANALYSE|,AN[,ENQ,]
    {BLOCKER|BLOCK}
    {WAITER|WAIT[,SYSTEM|,SYS=sysname|*]
      [,ASID|,AS=asid]
      [,JOBNAME|,JOB=jobname]
      [,XJOBNAME|,XJOB=(jobname1,jobname2,...,jobname25)]
      [,XQNAME|,XQN=(qname1,qname2,...,qname25)]
    }

    {DEPENDENCY|DEP|DEP[,SYSTEM|,SYS=sysname|*]
      [,ASID|,AS=asid][TCB=tcbaddr]
      [,JOBNAME|JOB=jobname]
      [,XJOBNAME|,XJOB=(jobname1,jobname2,...,jobname25)]
      [,XQNAME|,XQN=(qname1,qname2,...,qname25)]

      [,RES=(qname,rname)
        {SCOPE|SCO=SYSTEM[S]|SYS[S]}
        {SYSTEM|SYS=sysname|*}}

      [,COUNT|,CNT=nn][,DETAIL|,DET]

  [,L={a|name|name-a}]

  {{[,ANALYZE|,ANALYSE|,AN], LATCH, WAITER}
    {[,CASID=cr-asid][,CJOBNAME=cr-jobname]
      [,ASID=asid][,JOBNAME=jobname][,XJOBNAME=(xjobnamelist)]
      [,XLSETNM=(xlsetnamelist)]
      [,COUNT=nn]
      [,DETAIL]
    }

  {ANALYSE, LATCH, BLOCKER}
    {[,CASID=cr-asid][,CJOBNAME=cr-jobname]
      [,ASID=asid][,JOBNAME=jobname][,XJOBNAME=(xjobnamelist)]
      [,XLSETNM=(xlsetnamelist)]
      [,COUNT=nn]
      [,DETAIL]
    }

  {ANALYSE, LATCH, DEPENDENCY}
    {[,ASID=asid][,JOBNAME=jobname][,XJOBNAME=(xjobnamelist)]
      [,TCB|WEB=workunitaddr]
      [,XLSETNM=(xlsetnamelist)]
      [,CASID=cr-asid][,CJOBNAME=cr-jobname]}
      [,LAT=(lsetname,latchnum)]
      [,COUNT|CNT=nn]
      [,DETAIL|DET]
    }

  [,L={a|name|name-a}]

```

SYSTEM

System information is to be displayed. The SYSTEM operand produces a display only when a global resource serialization complex is active.

The display of system information includes:

DISPLAY GRS command

- The system name (the name specified on the SYSNAME system parameter) of each system in the global resource serialization complex.
- The state of each system in the global resource serialization star complex:
 - Connecting: The system is processing the GRS=STAR parameter. It is not yet a member of the global resource serialization star complex.
 - Connected: The system is a member of the global resource serialization star complex.
 - Rebuilding: The system is a member of the global resource serialization star complex, but is currently rebuilding the global resource serialization lock structure, ISGLOCK. The system suspends any tasks that try to obtain any global resources.
- The state of each system in the global resource serialization ring complex:
 - Active: The system is presently serializing global resources. It is a member of the global resource serialization ring. If ACTIVE and WAIT appear, a global resource serialization command was issued but is waiting because another global resource serialization command is executing. If ACTIVE and VARY appear, the system is executing an internally-issued or operator-issued global resource serialization command.
 - Inactive: This system is not presently sending or receiving global requests in the global resource serialization ring. Any requests already held remain held, and any new requests remain pending until this system restarts back into the ring. The system suspends tasks that request global resources. The system can be used to restart the ring.
 - Quiesced: This system is not presently sending or receiving global requests in the global resource serialization ring. Any requests that are held remain held, and any new requests remain pending until this system restarts back into the ring. The system suspends tasks that request global resources. The system must restart back into an already active ring to resume global request processing, or it can be reactivated to restart a new ring if no other active systems exist.
 - Joining: This system is in the process of joining the global resource serialization complex.
 - Restarting: This system was an inactive or quiesced system and is now in the process of rejoining the global resource serialization ring.
 - Migrating: The system is participating in the process of migrating from a global resource serialization ring complex to a global resource serialization star complex.
- The communication status of each system in the global resource serialization ring or star complex:
 - The display for a ring complex shows the current settings for the following parameters:
 - The minimum RSA-message residency time in milliseconds.
 - The maximum tolerance time interval allowed for RSA-message to return to the system.
 - Whether synchronous reserve processing is activated for the current system.
 - The display for a star complex shows the current settings for the following parameters:
 - The number of locks for the global resource serialization lock structure (ISGLOCK).
 - Which system is the contention notifying system.

- Whether synchronous reserve processing is activated for the current system.
- AUTHQLVL value that is in effect. This value indicates the level of protection provided through different lists of qnames that are considered to be authorized by the system.

LINK

CTC link information is to be displayed. The LINK operand produces a display only when a global resource serialization complex is active.

When the global resource serialization ring complex is using XCF signalling, the display shows that XCF paths are used.

The display of global resource serialization CTC link information includes:

- The device number of each CTC link assigned to global resource serialization on this system
- The status of each global resource serialization CTC link, which can be any one of the following:
 - In use: This system is using this link to send messages to and receive RSA messages from the system at the other end of the CTC link.
 - Alternate: This system is not presently using this link to send or receive RSA messages, but it has the ability to do so. If your installation uses ring acceleration, global resource serialization might be using the link to send the ring acceleration signal.
 - Disabled: This system cannot use this link to send or receive messages.
 - Quiet: The system at the opposite end of the link does not respond.
- The system name (the name specified on the SYSNAME system parameter) of the system that last responded from the opposite end of the link.

ALL or A

The following information is to be displayed:

- System information
- CTC link information
- Resource contention information
- RNL change information
- The contents of all RNLs
- AUTHQLVL value that is in effect. This value indicates whether authorized qnames are enabled for the default list of IBM product qnames (AUTHQLVL=1) or enabled for the default list and a second list of qnames for HSM (AUTHQLVL=2). You can change this value by using the SETGRS AUTHQLVL command.

Specify HEX if you want the resource names displayed in EBCDIC and in hexadecimal. If the global resource serialization complex is inactive, the display does not contain system information, CTC link information, or the contents of RNLs. If the system did not start or join an active global resource serialization ring at IPL, the display does not contain system, link, and RNL information. When an RNL change is in progress, the display shows DELAY and SUSPEND information.

CONTENTION or C

Resource contention information for the current global resource serialization complex is to be displayed. If a DISPLAY GRS,CONTENTION command is entered without the LATCH or ENQ operands, the system displays both ENQ and LATCH contention information.

DISPLAY GRS command

Specify LATCHID or LID when you want to identify latch id information (displayed with the latch number in the output message ISG343I). The latch id can help with problem diagnosis when the latch creator has provided each latch number a name.

Specify HEX if you want resource names displayed in EBCDIC and in hexadecimal.

DELAY or D

Displays the jobs that are delaying an RNL change. The following information is displayed:

- Jobname
- ASID
- Resources held or waiting for

DEV=[/]devnum

Displays a list of non-converted RESERVE requests for the device identified by *devnum*. The device number consists of 3 or 4 hexadecimal digits, optionally preceded by a slash (/).

You can use this command to:

- Determine which jobs have RESERVE requests for a particular device.
- Whether this system has reserved the device.
- Help resolve reserve contention problems.

ENQ or E

Resource contention information for ENQs and RESERVEs is to be displayed. If you specify ENQ, you must also specify CONTENTION.

JOBNAME or JOB

Latch information for a particular job is to be displayed. Specify the name of a job that you suspect either owns a latch or has a pending request to obtain a latch. If JOBNAME is specified, LATCH must also be specified.

LATCH or L

Latch information is to be displayed. If you specify LATCH, you must also specify CONTENTION or JOBNAME or both:

- Specify LATCH,CONTENTION if you suspect that tasks or SRB routines are contending for a latch that is held by another task or SRB routine. The system displays information about latches that have contention (if any exist).
- Specify LATCH,JOBNAME to display information about latches that a specified job owns or is waiting for, regardless of whether contention for those latches exists.
- Specify LATCH,CONTENTION,JOBNAME to display information about latches that a specified job owns or is waiting for *and* for which contention exists.
- Specify the keyword LATCHID to the command to display the specified latch identity string (if any) by the latch set creator (for example, LATCH,CONTENTION,LATCHID or LATCH,JOBNAME,LATCHID).

The following are the various combinations of the CONTENTION, ENQ, JOBNAME, and LATCH parameters, and the information each produces:

CONTENTION

ENQ, LATCH, CONTENTION

Both ENQ and latch contention information.

ENQ,CONTENTION

ENQ contention information.

LATCH,CONTENTION

Latch contention information.

LATCH,JOBNAME

Latch information for a particular job name, if the job owns or waits for a latch

LATCH,CONTENTION,JOBNAME

Latch information for a particular job name, if the job owns or waits for a latch, and contention exists for the latch.

ENQ,LATCH,CONTENTION,JOBNAME

ENQ and latch contention information for a particular job name.

ENQ,LATCH,CONTENTION,LATCHID

LATCH ID information about the contention displayed in message ISG343I.

ENQ,LATCH,JOBNAME,LATCHID

LATCH ID information for the job that owns the latch displayed in message ISG343I.

LATCHID or LID

When used in combination with LATCH,JOBNAME or LATCH,CONTENTION, the latch id number associated with the jobname or contention.

SUSPEND or S

Displays the jobs that are suspended, waiting for resources that are affected by the RNL change. The following information is displayed:

- Jobname
- ASID
- Resources the job is waiting for

Note: DELAY and SUSPEND do not support the HEX operand.

RNL=

The contents of one or all resource name lists (RNLs) in the current global resource serialization complex are to be displayed. The RNL operand produces a display only when a global resource serialization complex is active. Specify HEX if you want resource names displayed in EBCDIC and in hexadecimal. When the GR SRNL=EXCLUDE option is in effect, the display shows this option is being used.

CONVERSION or CON or C

The contents of the RESERVE conversion RNL are to be displayed.

EXCLUSION or EXCL or E

The contents of the SYSTEMS exclusion RNL are to be displayed.

INCLUSION or INCL or I

The contents of the SYSTEM inclusion RNL are to be displayed.

ALL or A

The contents of all RNLs are to be displayed.

RES=(qname[,rname])

A list of major names or resource information for the specified resource(s). Only resources that have at least one requestor are displayed.

DISPLAY GRS command

A resource name must consist of a qname (major name) and can include an rname (minor name). If you specify an asterisk (*) as the last character in the resource name, then the system treats the name as a generic name; the display includes all resources with names that match the portion of the name specified before the asterisk. For example, SYSV* indicates that set of resources whose names begin with SYSV. If you specify major name without a minor name, the system displays just a list of the specified major names of those resources that have requestors. You can specify a generic qname with a specific rname, and conversely, a specific qname with a generic rname.

Specify the HEX operand if you want the resource names to be displayed in EBCDIC and hexadecimal. Use it when you have resource names that contain characters that will not appear on your console (that is, those characters that are not defined in the figure, “;English (U.S) I/O Interface Code for 3277,” which appears in *IBM 3270 Information Display System*).

Note: The parentheses around the resource name(s) in RES=(qname[,rname]) are required.

How you specify qname (the major name) depends on the characters in the name.

qname

If qname contains only characters that are alphanumeric (A-Z and 0-9), national (#, @, and \$), and a period (.), specify either:

- 1-8 alphanumeric characters (a specific major name)
- 1-7 alphanumeric characters followed by an asterisk (*) (a generic major name)

'qname'

If qname consists of characters that can be displayed other than alphanumeric, national, or a period (excluding a single quotation mark), use the form 'qname'. The single quotation marks are required but do not count as part of the length specification for qname. For qname, specify either:

- 1-8 characters (a specific major name)
- 1-7 characters followed by an asterisk (*) after the closing single quotation mark (a generic major name)

X'qname'

If qname contains hexadecimal values or a single quotation mark, specify the name in hexadecimal in the form X'qname'. The prefix X and the single quotation marks enclosing qname are required but do not count as part of the length specification for qname. For qname, specify either:

- 2-16 hexadecimal digits (a specific major name)
- 2-14 hexadecimal digits followed by an asterisk (*) after the closing single quotation mark (a generic major name)

* If you want a list of the major names of all resources that have requestors, specify '*' to indicate a generic major name.

How you specify rname (the minor name) depends on the characters in the name.

rname

If rname contains characters that are alphanumeric (A-Z and 0-9), national (#, @, and \$), and/or a period (.), specify either:

- 1-52 alphanumeric characters (a specific minor name)

- 1-51 alphanumeric characters followed by an asterisk (*) (a generic minor name)

'rname'

If rname consists of characters that can be displayed other than alphanumeric, national, or a period (excluding a single quotation mark), use the form 'rname'. The single quotation marks are required but do not count as part of the length specification for rname. For rname, specify either:

- 1-52 characters (a specific minor name)
- 1-51 characters followed by an asterisk (*) after the closing single quotation mark (a generic minor name)

X'rname'

If rname contains hexadecimal values or a single quotation mark, specify the name in hexadecimal in the form X'rname'. The prefix X and the single quotation marks enclosing rname are required but do not count as part of the length specification for rname. For rname, specify either:

- 2-104 hexadecimal digits (a specific minor name)
- 2-102 hexadecimal digits followed by an asterisk (*) after the closing single quotation mark (a generic minor name)

- * If you want information on all resources, specify (*) to indicate a generic minor name.

HEX

Resource information is to be displayed in hexadecimal as well as EBCDIC. The HEX operand does not affect the SYSTEM or LINK operands.

ANALYZE or ANALYSE or AN

Displays an analysis of system contention. The scope of the analysis is based on the input specified by the command issuer, and can be:

- the entire sysplex
- one system
- one address space
- one task.

The default scope for the analysis is the entire sysplex.

ANALYZE, LATCH

Displays information about GRS latch contention. Choose either BLOCKER, WAITER, or DEPENDENCY analysis for all latch sets and latches. The optional parameters are:

cr-asid

Specifies the ASID of the latch set creator space to analyze.

cr-jobname

Specifies the JOBNAME of the latch set creator space to analyze.

xlsetnamelist

Specifies the list of latch sets to be excluded from the display. Latch set names can be long, so wildcarding (*,?) is encouraged, where ? matches any single character, and * matches any string of zero or more characters. You can enter one to five latch set names.

xjobnamelist

Specifies the list of job names to be excluded from the display. You can

DISPLAY GRS command

enter generic job names by placing a (*) at the end of the job name. You can enter one to twenty-five job names.

workunitaddr

Specifies the address of the work unit of the latch requestor (TCB or WEB for an SRB) to analyze. The *workunitaddr* parameter is only valid with DEPENDENCY and ASID or JOBNAME.

lsetname

Specifies the name of the latch set to analyze. Either CASID or CJOBNAME must also be specified. Latch set names can be long, so wildcarding (*,?) is encouraged, where ? matches any single character, and (*) matches any string of zero or more characters. If no (*) characters are specified, the latch set name is padded with blanks. The *Lsetname* parameter is only valid with DEPENDENCY and CASID or CJOBNAME. Do not specify Lsetname with XLSetNM.

latchnum

Specifies the latch number to analyze. Either CASID or CJOBNAME must also be specified. This number is to be specified by one to eight decimal digits. The *Lsetname* parameter is only valid with DEPENDENCY and CASID or CJOBNAME. Do not specify latchnum with XLSetNM.

jobname

Specifies the JOBNAME of the latch requestor to analyze.

xjobname

Specifies the list of latch requestor JOBNAMEs to exclude from the display.

asid

Specifies the ASID of the latch requestor to analyze.

The default scope for the analysis is the entire system.

BLOCKER or BLOCKE or BLOCK

Displays an ordered list of the units of work blocking GRS-managed resources.

WAITER or WAITE or WAIT

Displays an ordered list of the units of work waiting for ownership of GRS-managed resources.

DEPENDENCY or DEPENDENC or DEPENDEN or DEPEND or DEPEN or DEPE or DEP

Displays the dependencies between the units of work and resources that are in contention.

SYSTEM or SYS = *sysname* or *

The scope of the analysis, where *sysname* is a valid system name in the sysplex, 1–8 characters, following *sysname* rules. Use of an asterisk (*) for *SYSNAME* will be the equivalent of specifying the name of the system from which the display command is entered.

ASID or AS = *asid*

A valid hexadecimal address space id, 1–4 hexadecimal digits. ASID requires specification of a valid *sysname*; you may NOT specify ASID with JOBNAME or XJOBNAME..

JOBNAME or JOB = *jobname*

A valid JOBNAME, 1–8 characters, following *jobname* rules. JOBNAME requires specification of a valid *sysname*; you may NOT specify JOBNAME with ASID or XJOBNAME.

XJOBNAME or XJOB = (jobname1,jobname2,...jobname25)

Jobname(s) to exclude from the analysis. You may specify up to 25 jobnames, and may enter an asterisk as a wildcard indicator as the last character of a jobname. You may NOT specify XJOBNAME with JOBNAME or ASID. If you specify XJOBNAME with XQNAME, exclusion will occur if either the jobnames or qnames match.

XQNAME or XQN = (qname1,qname2,...qname25)

Qname(s) (major names) to exclude from the analysis. You may specify up to 25 qnames, and may enter an asterisk (*) as a wildcard indicator as the last character of a qname. You may not specify XQNAME with RES. If you specify XQNAME with XJOBNAME, exclusion will occur if either the qnames or jobnames match.

TCB=*tcbaddr*

A valid TCB address, 1–8 hexadecimal digits. TCB is only valid with DEPENDENCY, SYSTEM, and ASID or JOBNAME, and requires specification of a valid ASID or jobname.

RES=(*qname,rname*)

The resource name with which to begin a dependency analysis. A resource name consists of a *qname* (major name) and an *rname* (minor name) of the '*nn*' (see COUNT=) longest owners of the resource. If you omit the RES= keyword, the dependency analysis will display the *nn* longest waiters without regard to resource. You may not specify RES with XQNAME.

Note: When the ANALYZE keyword is specified, the HEX operand is not available for this keyword. *qname* indicates the resource major name and *rname* indicates the resource minor name with which to begin analysis. The valid characters are \$, ., @, and #.

SCOPE or SCO = SYSTEM(S) or SYS(S)

Indicates the scope of the resource that begins the dependency analysis. If you specify SCOPE=SYSTEM, then you must also specify with which system to associate the ENQ. You do this by using the SYSTEM keyword.

COUNT or CNT = *nn*

The maximum number of blockers or waiters (in decimal) to display. Valid values are from 1 to 99. The default value is 10. COUNT is valid with any combination of keywords.

DETAIL or DET

Specifies the more detailed form of message ISG374I. Not specifying DETAIL gives the shorter form of the output.

L=*a*, *name*, or *name-a*

Specifies the display area (*a*), console name (*name*), or both (*name-a*) where the displays to appear.

If you omit this operand, the display is presented in the first available display area or the message area of the console through which you enter the command.

Example 1:

To display resource information about all resources that have requestors, enter:

D GRS,RES=(*,*)

Performance implication: This command gives you data about every allocated ENQ/RESERVE resource on all systems in the global resource serialization

DISPLAY GRS command

complex; therefore, there might be a very large display. If this command produces a large amount of output, the command output might fill WTO buffers, and degrade system response time. If the display exceeds the current supply of WTO buffers, an ABEND 09A with reason code 46FA will occur.

Global resource serialization might also truncate information that is displayed with ISG343I:

```
ISG343I 15.08.31 GRS STATUS
NOT ENOUGH STORAGE TO COMPLETE THE REQUEST
```

Example 2:

To display resource information about all resources whose major name is SYSDSN, enter:

```
D GRS,RES=(SYSDSN,*)
```

Example 3:

To display the jobs delaying an RNL change, enter:

```
D GRS,DELAY
```

The system displays the following message:

```
ISG343I 01:32:21 GRS STATUS
      DELAY REASONS ON SYSTEM SYSA
JOBNAME      ASID  QNAME  RNAME
USERJB1      0044  SYSDSN  SYS1.XYZ
CATALOG      0007  SYSDSN  SYS1.CHANGING.RESOURCE2
```

Example 4:

To display the jobs suspended waiting for resources affected by an RNL change, enter:

```
D GRS,SUSPEND
```

The system displays the following message:

```
ISG343I 01:32:21 GRS STATUS
JOBS BEING SUSPENDED DUE TO RNL CHANGE ON SYSTEM SYSA
JOBNAME      ASID  QNAME  RNAME
USERNM3      0089  SYSDSN  SYS1.DATASET.CHANGING
USERNM4      0245  SYSDSN  SYS1.XYZ.ABC
```

Example 5:

To display in EBCDIC and hexadecimal the outstanding ENQ/RESERVES that have a qname of SYSCTLG, enter:

```
D GRS,RES=(SYSCTLG,*),HEX
```

The display includes the hexadecimal representation of the resource name, SYSCTLG, with the hexadecimal representation under it:

```
SYSCTLG
EEECEDC
2823337
```

To display in EBCDIC and hexadecimal the outstanding ENQ/RESERVES of a resource with a minor name, enter:

```
D GRS,RES=(GRJGQE07,*),HEX
```

The hexadecimal representation of the resource, GRJGQE07, would look like the following:

```
ISG343I 15.17.06 GRS STATUS
S=SYSTEMS GRJGQE07 TESTCASE#SERIALIZATION#ENQ
          CDDCDCFF ECEECCEC7ECDCCDCECECDD7CDD
          79178507 35233125B2599139913965B558
SYSNAME   JOBNAME      ASID    TCBADDR  EXC/SHR  STATUS
S1        MAINAS11     001F    007DEB90 EXCLUSIVE OWN
```

Example 6:

To display latch contention information for all latches that currently exist, enter the following:

```
D GRS,LATCH,CONTENTION
```

If latch contention exists, the system displays the following message:

```
ISG343I 23.00.04 GRS LATCH STATUS 886
LATCH SET NAME: MY.FIRST.LATCHSET
CREATOR JOBNAME: APPINITJ CREATOR ASID: 0011
LATCH NUMBER: 1
  REQUESTOR ASID  EXC/SHR  OWN/WAIT WORKUNIT  TCB  ELAPSED TIME
  MYJOB1    0011  EXCLUSIVE OWN     006E6CF0  Y   00:00:40.003
  DATAHG   0019  EXCLUSIVE WAIT    006E6B58  Y   00:00:28.001
  DBREC     0019  SHARED   WAIT    006E6CF0  Y   00:00:27.003
LATCH NUMBER: 2
  REQUESTOR ASID  EXC/SHR  OWN/WAIT WORKUNIT  TCB  ELAPSED TIME
  PEEKDAT1  0011  SHARED   OWN     007E6CF0  Y   00:01:00.002
  PEEKDAT2  0019  SHARED   OWN     007F6CF0  Y   00:00:32.040
  CHGDAT    0019  EXCLUSIVE WAIT    007D6CF0  Y   00:00:07.020
LATCH SET NAME: SYS1.FIRST.LATCHSET
CREATOR JOBNAME: INITJOB2 CREATOR ASID: 0019
LATCH NUMBER: 1
  REQUESTOR ASID  EXC/SHR  OWN/WAIT WORKUNIT  TCB  ELAPSED TIME
  MYJOB2    0019  SHARED   OWN     006E6CF0  Y   00:01:59.030
LATCH NUMBER: 2
  REQUESTOR ASID  EXC/SHR  OWN/WAIT WORKUNIT  TCB  ELAPSED TIME
  TRANJOB1  0019  SHARED   OWN     006E7B58  Y   01:05:06.020
  TRANJOB2  0019  EXCLUSIVE WAIT    006E9B58  Y   00:01:05.003
```

If no latch contention exists, the system displays the following message:

```
ISG343I 23.00.04 GRS LATCH STATUS 886
NO LATCH CONTENTION EXISTS
```

Example 7:

To display latch information for job LISTCHK, enter:

```
D GRS,L,JOB=LISTCHK or D GRS,LATCH,JOBNAME=LISTCHK
```

If job LISTCHK owns or waits for a latch, the system displays the following message:

```
ISG343I 23.00.04 GRS LATCH STATUS 886
LATCH DISPLAY FOR JOB LISTCHK
LATCH SET NAME: SYS2.PAYROLLAPP.LATCHSET
CREATOR JOBNAME: INITJOB1 CREATOR ASID: 0011
LATCH NUMBER: 1
  REQUESTOR ASID  EXC/SHR  OWN/WAIT WORKUNIT  TCB  ELAPSED TIME
  GETDAT1   0011  EXCLUSIVE OWN     007E6CF0  Y   00:01:07.030
  GETDAT2   0019  EXCLUSIVE WAIT    007A6CF0  Y   00:00:31.050
  SHOWDAT   0019  SHARED   WAIT    007E6CF0  Y   00:00:25.010
LATCH NUMBER: 2
  REQUESTOR ASID  EXC/SHR  OWN/WAIT WORKUNIT  TCB  ELAPSED TIME
```

DISPLAY GRS command

```
LISTREC    0011  SHARED    OWN      007B6CF0  Y  00:03:07.040
FINDBLK    0019  SHARED    OWN      007C6CF0  Y  00:02:07.030
CHNGBLK    0019  EXCLUSIVE WAIT    007F6CF0  Y  00:02:03.002
```

Example 8:

To display information for all latches with contention involving job FINDREC, enter:

```
D GRS,L,C,JOB=FINDREC or
D GRS,LATCH,CONTENTION,JOBNAME=FINDREC
```

Example 9:

To display contention information for ENQs and RESERVEs, enter:

```
D GRS,E,C or D GRS,ENQ,CONTENTION
```

Example 10:

To display the contents of all resource name lists (RNLs) in the current global resource serialization complex, enter:

```
D GRS,RNL=ALL
```

The system displays the following message:

```
ISG343I 18.10.38 GRS STATUS
LIST TYPE QNAME  RNAME
INCL GEN SYSDSN
INCLPATT SYSDSN SYS1.*.*
EXCL SPEC SYSDSN PASSWORD
EXCL PATT SYSDSN SYS?.*.*LIB
EXCL PATT SYSDSN SYS?.TEST
EXCL PATT SYSDSN SYS1.*.LOGREC
EXCL PATT SYSDSN SYS1.*.MANX
EXCL SPEC SYSDSN SYS1.BROADCAST
CON PATT*      *
```

Note the use of wildcard characters in this example.

DISPLAY GRS,ANALYZE,LATCH outputs

The following samples are the outputs when you issue the DISPLAY GRS,ANALYZE,LATCH command with different parameters. For detailed definitions of the parameters in these samples, see “Displaying global resource serialization information” on page 299.

If no data returns for the DISPLAY GRS,ANALYZE,LATCH command, the following output is displayed:

```
LONG BLOCKER ANALYSIS: request specification
      THERE ARE NO BLOCKING WORK UNITS MATCHING THE INPUT SPECIFICATION
```

Note: This message will only be returned if a DISPLAY GRS,ANALYZE,LATCH,BLOCKER command is issued. The message text will be different if either WAITER or DEPENDENCY is specified instead.

DISPLAY GRS,ANALYZE,LATCH,BLOCKER output:

The system displays the following lines when a DISPLAY GRS,ANALYZE,LATCH,BLOCKER command is entered:

```
LONG BLOCKER ANALYSIS: request specification
  OWNTIME  JOBNAME  E/S  CASID  LSETNAME/LATCHID
  hh:mm:ss jobname  *r*  casid  lsetname
                               latchId
  OTHER BLOCKERS: nn WAITERS: nn2
```

The first line displays the input specified in the command. The second line defines the format of the table. For each blocker that matches the input specifications on the command, the information identified by the header is displayed.

DISPLAY GRS,ANALYZE,LATCH,WAITER output:

The system displays the following lines when a DISPLAY GRS,ANALYZE,LATCH,WAITER command is entered:

```
LONG WAITER ANALYSIS: request specification
  WAITTIME  JOBNAME  E/S  CASID  LSETNAME/LATCHID
  hh:mm:ss  jobname  *r*  casid  lsetname
                               latchId
  BLOCKER   jobname2  r2      OTHER BLOCKERS: nn WAITERS: nn2
```

The first line displays the input specified in the command. The second line defines the format of the table. For each waiter that matches the input specifications on the command, the information identified by the header is displayed.

DISPLAY GRS,ANALYZE,LATCH,DEPENDENCY output:

The system displays the following lines when a DISPLAY GRS,ANALYZE,LATCH,DEPENDENCY command is entered:

```
DEPENDENCY ANALYSIS: request specification
  descriptor
  WAITTIME  JOBNAME  E/S  CASID  LSETNAME/LATCHID
  hh:mm:ss  jobname  *r*  casid  lsetname
                               latchId
  BLOCKER   jobname2  r2
  ANALYSIS ENDED: analysis outcome
```

The first line displays the input specified in the command. The second line identifies the element of the analysis that is being displayed. The third line defines the format of the table. For each element, each waiting unit of work is reflected by the fourth and fifth lines. The sixth line indicates the top blocker of the latch resource. The fourth, fifth, and sixth lines are repeated until the analysis is completed. The analysis displays the deadlocks first; then the elements are sorted by wait time in an descending order.

DISPLAY GRS, ANALYZE,LATCH,BLOCKER,DETAIL output:

The system displays the following lines when a DISPLAY GRS, ANALYZE,LATCH,BLOCKER,DETAIL command is entered:

```
LONG BLOCKER ANALYSIS: request specification
  BLOCKER JOBNAME: jobname (ASID=asid, TCB|WEB=wuaddr)
  REQUEST: reqtype [(WITH nn OTHERS)] LT:latchtoken
  BLOCKING hh:mm:ss RESOURCE (CREATOR ASID= casid)
  lsetname LST:lsettoken
  latchId
```

The first line displays the input specified in the command. For each blocker that matches the input specifications on the command, the information identified by the header is displayed. In this detail output, the ASID and TCB information is displayed.

DISPLAY GRS command

DISPLAY GRS,ANALYZE,LATCH,WAITER,DETAIL output:

The system displays the following lines when a DISPLAY GRS,ANALYZE,LATCH,WAITER,DETAIL command is entered:

```
LONG WAITER ANALYSIS: request specification
descriptor
WAITER JOBNAME: jobname (ASID=asid, TCB|WEB=wuaddr)
REQUEST: reqtype LT:latchtoken
WAITING hh:mm:ss FOR RESOURCE (CREATOR ASID= casid)
lsetname LST:lsettoken
latchId
BLOCKER JOBNAME: jobname2 (ASID=asid2, TCB|WEB=wuaddr2)
REQUEST: reqtype2 [(WITH nn2 OTHERS)] LT:latchtoken
```

The first line displays the input specified in the command. For each blocker that matches the input specifications on the command, the information identified by the header is displayed. In this detail output, the ASID and TCB information is displayed.

DISPLAY GRS,ANALYZE,LATCH,DEPEND,DETAIL output:

The system displays the following lines when a DISPLAY GRS,ANALYZE,LATCH,DEPEND,DETAIL command is entered:

```
DEPENDENCY ANALYSIS: request specification
descriptor
JOBNAME: jobname (ASID=asid, TCB|WEB=wuaddr)
REQUEST: reqtype [(WITH nn OTHERS)] LT:latchtoken
state hh:mm:ss FOR RESOURCE (CREATOR ASID= casid)
lsetname LST:lsettoken
latchId latchtoken
ANALYSIS ENDED: analysis outcome
```

The first line displays the input specified in the command. The second line identifies the long waiter number or latch resource owner number. For each subsequent latch resource request, the third through seventh lines are repeated. Each latch resource request is dependent on the latch resource request identified by the next five lines. In this detail output, the ASID and TCB information is displayed.

DISPLAY GRS,ANALYZE,LATCH error output:

The system displays the following lines when a DISPLAY GRS,ANALYZE,LATCH command is entered and the system encounters an error:

```
PROCESSING ENDED:
error_reason
```

Displaying Generic Tracker information

Use the DISPLAY GTZ command to display various information about the Generic Tracker via a set of subcommands. Additional references and an overview for the tracking facility can be found in the *z/OS MVS Diagnosis: Tools and Service Aids*.

Table 25. Summary of the Display GTZ Command

Command:	Topic:
DISPLAY GTZ,STATUS	"DISPLAY GTZ,STATUS Command" on page 315
DISPLAY GTZ,TRACKDATA	"DISPLAY GTZ,TRACKDATA command" on page 315

Table 25. Summary of the Display GTZ Command (continued)

Command:	Topic:
DISPLAY GTZ,EXCLUDE	"DISPLAY GTZ,EXCLUDE command" on page 321
DISPLAY GTZ,DEBUG	"DISPLAY GTZ,DEBUG command" on page 321

The TRACKDATA subcommand has the potential to report large amounts of information. IBM recommends to use the DISPLAY GTZ,STATUS command first to view the overall statistics, then use appropriate filters on the other sub-commands to limit the amount of information being displayed.

DISPLAY GTZ,STATUS Command

Use DISPLAY GTZ,STATUS to display an overview of the Generic Tracker's current status, currently recorded tracking data, and configuration settings.

Syntax:

```
{DISPLAY|D} GTZ[,STATUS] [,L={a|name|name-a}]
```

Note: The DISPLAY GTZ command follows the conventions for the second command format described in "System command formats" on page 168 and, in particular, requires explicit comment start and end sequences: a forward slash directly followed by an asterisk (/*), and an asterisk directly followed by a forward slash (*/).

Parameters: The parameters for DISPLAY GTZ,STATUS are:

L={a|name|name-a}

Specifies the display area (*a*), console name (*name*), or both (*name-a*) where the display is to appear.

If you omit this operand, the display is presented in the first available display area or the message area of the console through which you enter the command.

Note: For the output of the DISPLAY GTZ,STATUS command, see the description of message GTZ1001I in *z/OS MVS System Messages, Vol 6 (GOS-IEA)*.

Example:

```
GTZ1001I 14.59.57 GTZ STATUS          FRAME LAST  F      E  SYS=SY40
TRACKING:  ENABLED                2013-03-04 21:33:44
TRACKED:   UNIQUE=0                TOTAL=0
EXCLUDE:   DEFINED=47              APPLIED=253
DEBUG:     DEFINED=0                APPLIED=0
GTZPRMXX: 00,01,02,03
MEMORY:    99% AVAILABLE
```

DISPLAY GTZ,TRACKDATA command

Use DISPLAY GTZ,TRACKDATA to display details for all or a subset of currently recorded track data from previous GTZTRACK requests.

DISPLAY GTZ command

Syntax:

```
{DISPLAY|D} GTZ,TRACKDATA[[=] (filter)] [,L={a|name|name-a}]  
with filter:  
  ALL  
  | [OWNER={owner-filter-text|*}]  
  | { [,SOURCETYPE=ALL  
  | [,SOURCETYPE=NOPATH[,SOURCE={source-filter-text|*}]]  
  | [,SOURCETYPE=PATH[,SOURCEPATH={sourcepath-filter-text|*}]]}  
  | [,EVENTDESC={event-description-filter-text|*}]  
  | [,EVENTDATA={event-data-filter-value|*}]  
  | [,EVENTJOB={event-job-filter-text|*}]  
  | [,EVENTASID={event-ASID-filter-value|*}]  
  | { [,PROGRAMTYPE=ALL  
  | [,PROGRAMTYPE=NOPATH[,PROGRAM={program-filter-text|*}]  
  | [,PROGRAMTYPE=PATH[,PROGRAMPATH={programpath-filter-text|*}]]}  
  | [,PROGRAMOFFSET={program-offset-filter-value|*}]  
  | [,HOMEJOB={home-job-filter-text|*}]  
  | [,HOMEASID={home-ASID-filter-value|*}]
```

Note: The DISPLAY GTZ command follows the conventions for the second command format described in “System command formats” on page 168 and, in particular, requires explicit comment start and end sequences: a forward slash directly followed by an asterisk (/*), and an asterisk directly followed by a forward slash (*).

Parameters: The parameters for DISPLAY GTZ,TRACKDATA are:

filter

If a filter is specified, only matching tracked instances will be displayed. The filter fields correspond to fields as recorded for a tracked instance via the GTZTRACK macro service.

ALL

All tracked instances are displayed.

OWNER=owner

To be compared to the OWNER value of a tracked instance (as specified on its GTZTRACK request).

If OWNER is specified, the *owner* value

- has to be a 1-16 character string.
- can contain wildcard characters anywhere in the string
 - an asterisk (*) will match any character sequence of zero or more characters and a question mark (?) will match a single arbitrary character.
- can only contain alphabetic characters (A-Z,a-z), numerics (0-9), national characters (@,\$,#), an underscore ('_'), a period (.), a dash (-), a slash (/), or wildcard characters.
- can be surrounded by quotes ('), which do not count toward the maximum length.
- will have all lower-case characters (a-z) folded to uppercase (A-Z).

If OWNER is not specified, a default value of * (match all) is assumed.

SOURCE=source

To be compared to the SOURCE value of a tracked instance (as specified on its GTZTRACK request). SOURCE can only be specified for SOURCETYPE=NOPATH.

If SOURCE is specified, the *source* value

- has to be a 1-8 character string.
- can contain wildcard characters anywhere in the string
 - an asterisk (*) will match any character sequence of zero or more characters and a question mark (?) will match a single arbitrary character.
- can only contain alphabetic characters (A-Z,a-z), numerics (0-9), national characters (@,\$,#), or wildcard characters.
- will have all lower-case characters (a-z) folded to uppercase (A-Z).

If SOURCE is not specified, a default value of * (match all) is assumed.

SOURCETYPE

SOURCETYPE is optional with default ALL.

ALL

Any tracked instances with either a SOURCE or SOURCEPATH value that will be matched. No further filtering on the SOURCE or SOURCEPATH value is provided.

PATH

Only tracked instances with a SOURCEPATH will be matched. Optionally a specific SOURCEPATH filter value can be specified. Tracked instances with a SOURCE value will not be matched.

NOPATH

Only tracked instances with a SOURCE will be matched. Optionally a specific SOURCE filter value can be specified. Tracked instances with a SOURCEPATH value will not be matched.

SOURCEPATH=*sourcepath*

To be compared to the SOURCEPATH value of a tracked instance (as specified on its GTZTRACK request). SOURCEPATH can only be specified for SOURCETYPE=PATH.

If SOURCEPATH is specified, the *sourcepath* value

- has to be a 1-1024 character string.
- has to be surrounded by quotes ('), which do not count toward the maximum length, if it contains any other characters than 'A-Z,a-z,0-9,#,\$,@,,"',,*,?,-,/,-,%'.
- can contain wildcard characters anywhere in the string
 - an asterisk (*) will match any character sequence of zero or more characters and a question mark (?) will match a single arbitrary character.
 - a single asterisk (*) can be specified without any quotes.
- can contain any EBCDIC character, but not just blanks or X'00'. IBM recommends to use printable characters.
- is case sensitive. If quotes are used, it will *not* have its alphabetic characters folded to upper-case. If quotes are not used, will have its alphabetic characters folded to upper-case.

Note: The pathnames are case sensitive, so IBM recommends to use quotes when specifying this value.

- will *not* have its trailing blanks removed when quotes are used.

If SOURCEPATH is not specified, a default value of * (match all) is assumed.

EVENTDESC=*eventdescription*

To be compared to the EVENTDESC value of a tracked instance (as specified on its GTZTRACK request).

DISPLAY GTZ command

If EVENTDESC is specified, the *eventdesc* value

- has to be a 1-64 character string.
- has to be surrounded by quotes ('), which do not count toward the maximum length, if it contains any other characters than 'A-Z,a-z,0-9,#,\$,@,,"',,*,?,-,/,-%'.
- can contain wildcard characters anywhere in the string. An asterisk (*) will match any character sequence of zero or more characters and a question mark (?) will match a single arbitrary character.
- can contain any EBCDIC character, but not just blanks or X'00'. IBM recommends to use printable characters.
- if unquoted:
 - will *not* have its alphabetic characters folded to upper-case and will be compared case-sensitive.
 - will *not* have its trailing blanks removed.

If EVENTDESC is not specified, a default value of * (match all) is assumed.

EVENTDATA=eventdata

To be compared to the EVENTDATA value of a tracked instance (as specified on its GTZTRACK request).

If EVENTDATA is specified, the *eventdata* value

- is interpreted as a 16 byte binary value.
- can be specified in hexadecimal format: One of X'hh' or hhx or 'hh'X or xhh, where h is a hexadecimal digit, one of 'A-F,a-f,0-9'.
- can be specified in decimal format.

If EVENTDATA is not specified, a default value of * (match all) is assumed.

EVENTJOB=eventjob

To be compared to the event address space job name, as derived from the EVENTASID value of a tracked instance (as specified on its GTZTRACK request).

If EVENTJOB is specified, the *eventjob* value

- has to be a 1-8 character string.
- can contain wildcard characters anywhere in the string. An asterisk (*) will match any character sequence of zero or more characters and a question mark (?) will match a single arbitrary character.
- can only contain alphabetic characters (A-Za-z), numerics (0-9), national characters (@,\$,#), or wildcard characters.
- will have all lower-case characters (a-z) folded to uppercase (A-Z).

If EVENTJOB is not specified, a default value of * (match all) is assumed.

EVENTASID=eventASID

To be compared to the EVENTASID value of a tracked instance (as specified on its GTZTRACK request).

If EVENTASID is specified, the *eventASID* value

- is interpreted as a 16 bit binary value.
- can be specified in hexadecimal format, for example as X'82C1' or 082C1x or '82C1'X or x82C1.
- can be specified in decimal format, for example as 33473.

If EVENTASID is not specified, a default value of * (match all) is assumed.

PROGRAM=program

To be compared to the program name, as derived from the EVENTADDR value of a tracked instance (as specified on its GTZTRACK request). PROGRAM can only be specified for PROGRAMTYPE=NOPATH.

If PROGRAM is specified, the *program* value

- is interpreted as a 1-8 character string.
- can contain wildcard characters anywhere in the string:
 - an asterisk (*) will match any character sequence of zero or more characters and a question mark (?) will match a single arbitrary character.
- can only contain alphabetic characters (A-Z,a-z), numerics (0-9), national characters (@,\$,#), or wildcard characters.
- will have all lower-case characters (a-z) folded to uppercase (A-Z).

If PROGRAM is not specified, a default value of * (match all) is assumed.

PROGRAMTYPE=programtype

PROGRAMTYPE is optional with default ALL.

ALL

Any tracked instances with either a PROGRAM or PROGRAMPATH value will be matched. No further filtering on the PROGRAM or PROGRAMPATH value is provided.

PATH

Only tracked instances with a PROGRAMPATH will be matched. Optionally a specific PROGRAMPATH filter value can be specified. Tracked instances with a PROGRAM value will not be matched.

NOPATH

Only tracked instances with a PROGRAM will be matched. Optionally a specific PROGRAM filter value can be specified. Tracked instances with a PROGRAMPATH value will not be matched.

PROGRAMPATH=programpath

To be compared to the program path name, as derived from the EVENTADDR value of a tracked instance (as specified on its GTZTRACK request). PROGRAMPATH can only be specified for PROGRAMTYPE=PATH.

If PROGRAMPATH is specified, the *programpath* value

- has to be a 1-1024 character string.
- has to be surrounded by quotes ('), which do not count toward the maximum length, if it contains any other characters than 'A-Z,a-z,0-9,#,\$,@,"',*,?,-,/,_,%'.
 - can contain wildcard characters anywhere in the string. An asterisk (*) will match any character sequence of zero or more characters and a question mark (?) will match a single arbitrary character.
- can contain any EBCDIC character, but not just blanks or binary zeros. IBM recommends to use printable characters.
- is case sensitive. If quotes are used, it will *not* have its alphabetic characters folded to upper-case. If quotes are not used, will have its alphabetic characters folded to upper-case.

Note: The pathnames are case sensitive, so IBM recommends to use quotes when specifying this value.

- will *not* have its trailing blanks removed when quotes are used.

If PROGRAMPATH is not specified, a default value of * (match all) is assumed.

DISPLAY GTZ command

PROGRAMOFFSET=programoffset

To be compared to the program offset, as derived from the EVENTADDR value of a tracked instance (as specified on its GTZTRACK request).

If PROGRAMOFFSET is specified, the *programoffset* value

- is interpreted as an 8 byte binary value.
- can be specified in hexadecimal format, for example as X'C1' or C1x or 'C1'X or xC1.
- can be specified in decimal format, for example as 193.

If PROGRAMOFFSET is not specified, a default value of * (match all) is assumed.

HOMEJOB=homejob

To be compared to the home address space job name as derived from the dispatchable unit under which a tracked instance's GTZTRACK request was executed.

If HOMEJOB is specified, the *homejob* value

- has to be a 1-8 character string.
- can contain wildcard characters anywhere in the string
 - an asterisk (*) will match any character sequence of zero or more characters and a question mark (?) will match a single arbitrary character.
- can only contain alphabetic characters (A-Za-z), numerics (0-9), national characters (@,\$,#), or wildcard characters.
- will have all lower-case characters (a-z) folded to uppercase (A-Z).

HOMEASID=homeASID

To be compared to the ID of the home address space as derived from the dispatchable unit under which a tracked instance's GTZTRACK request was executed.

If HOMEASID is specified, the *homeASID* value

- is interpreted as a 16 bit binary value.
- can be specified in hexadecimal format, for example X'82C1' or 082C1x or '82C1'X or x82C1.
- can be specified in decimal format, for example as 33473.

If HOMEASID is not specified, a default value of * (match all) is assumed.

L={a|name|name-a}

Specifies the display area (*a*), console name (*name*), or both (*name-a*) where the display is to appear.

If you omit this operand, the display is presented in the first available display area or the message area of the console through which you enter the command.

ALL

No comparisons are performed. All entries match the ALL filter. This is the same result as using default (*) values for all filter parameters.

Note: For the output of the DISPLAY GTZ,TRACKDATA command, see the description of message GTZ1002I in *z/OS MVS System Messages, Vol 6 (GOS-IEA)*.

Example:

```
GTZ1002I 23.18.28 GTZ TRACKDATA FRAME LAST F E SYS=SY39
FOUND 1 MATCHING TRACKED INSTANCE(S)
```

```
-----
INSTANCE:      1          COUNT:      1
EVENTDESC:    'EXCLUDE_ME'
OWNER:        IBM_GTZ_FCT      SOURCE:      MYSOURCE
EVENTDATA:    xC7E3E9C6C3E3C2C5  xC5C6F1F5C6F0F0C4
PROGRAM:      GTZINLPA      PROGRAMOFFSET: x0000000000000000
HOMEJOB:      MAINASID      HOMEASID:    x0027
EVENTJOB:     MAINASID      EVENTASID:   x0027
AUTHORIZED:   YES          FIRST TIME:  2013-01-18 23:10:11
```

DISPLAY GTZ,EXCLUDE command

Use DISPLAY GTZ,EXCLUDE to display details for all currently active EXCLUDE statements that have been specified by the SETGTZ EXCLUDE command or by corresponding GTZPRMxx parmlib member statements.

Syntax:

```
{DISPLAY|D} GTZ,EXCLUDE[,L={a|name|name-a}]
```

Note: The DISPLAY GTZ command follows the conventions for the second command format described in “System command formats” on page 168 and, in particular, requires explicit comment start and end sequences: a forward slash directly followed by an asterisk (/*), and an asterisk directly followed by a forward slash (*/).

Parameters: The parameters for DISPLAY GTZ,EXCLUDE are:

L={a|name|name-a}

Specifies the display area (a), console name (name), or both (name-a) where the display is to appear.

If you omit this operand, the display is presented in the first available display area or the message area of the console through which you enter the command.

Note: For the output of the DISPLAY GTZ,EXCLUDE command, see the description of message GTZ1003I in *z/OS MVS System Messages, Vol 6 (GOS-IEA)*.

Example:

```
GTZ1003I 23.25.51 GTZ EXCLUDE FRAME 1 F E SYS=SY39
FOUND 47 MATCHING EXCLUDE STATEMENT(S)
```

```
-----
STATEMENT:    1          ORIGIN:      GTZPRM00
EVENTDESC:   'CONVCON'
PROGRAMTYPE: NOPATH      PROGRAM:    ITPENTER
-----
STATEMENT:    2          ORIGIN:      GTZPRM00
EVENTDESC:   'MCSOPER: *'
PROGRAMTYPE: NOPATH      PROGRAM:    AULOAD
```

DISPLAY GTZ,DEBUG command

Use DISPLAY GTZ,DEBUG to display details for all currently active DEBUG statements that have been specified by the SETGTZ DEBUG command or corresponding GTZPRMxx parmlib member statements.

Syntax:

```
{DISPLAY|D} GTZ,DEBUG[,L={a|name|name-a}]
```

DISPLAY GTZ command

Note: The DISPLAY GTZ command follows the conventions for the second command format described in “System command formats” on page 168 and, in particular, requires explicit comment start and end sequences: a forward slash directly followed by an asterisk (/*), and an asterisk directly followed by a forward slash (*/).

Parameters: The parameters for DISPLAY GTZ,DEBUG are:

L={*a*|*name*|*name-a*}

Specifies the display area (*a*), console name (*name*), or both (*name-a*) where the display is to appear.

If you omit this operand, the display is presented in the first available display area or the message area of the console through which you enter the command.

Note: For the output of the DISPLAY GTZ,DEBUG command, see the description of message GTZ1004I in *z/OS MVS System Messages, Vol 6 (GOS-IEA)*.

Example:

```
GTZ1004I 23.27.46 GTZ DEBUG          FRAME LAST  F      E  SYS=SY39
FOUND 1 MATCHING DEBUG STATEMENT(S)
-----
STATEMENT:      1                      ORIGIN:      COMMAND
ACTION:         ABEND                   REASON:      x0064
ACTION COUNT:   2                      LIMIT:       NOLIMIT
OWNER:          IBM_GTZ_FCT
```

Displaying hardware event data collection status

Use the DISPLAY HIS command to display the results of the latest HIS Profiler run initiated by an F *hisproc*,BEGIN command. Hardware event data collection is performed by hardware instrumentation services (HIS), which collects hardware event data for processors in SMF records type 113 and some of the z/OS UNIX System Services output files.

The DISPLAY HIS command is also used to display statistics on the exploiters of the HISSERV service. The HISSERV service allows authorized programs to collect hardware instrumentation data. The amount of time each exploiter takes to collect the data is recorded by the service, and displayed here to aid in problem determination should a performance degradation occur.

Note that the results displayed by the D HIS command in system message HIS015I message will only be as current as the last time you initiated a hardware event data collection run with the F *hisproc*,BEGIN command. The displaying of statistical information, as well as any service parameters, are displayed as long as the HISSERV service is active.

```
D HIS[,L=a|name|name-a]
```

The parameters are:

HIS

The system displays HIS information in message HIS015I. For more information about HIS015I, see *z/OS MVS System Messages, Vol 6 (GOS-IEA)*.

L=a |name |name-a

This operand specifies the display area (a), console name (name), or both (name-a) where the output is to be displayed.

If you omit this operand, the display is presented in the first available display area or the message area of the console through which you enter command.

You can start a run of hardware event data collection using the MODIFY *hisproc*,BEGIN command. See "Starting, configuring, and stopping hardware event data collection" on page 561.

Examples

Example 1: If you issue the D HIS command to display the results of the latest hardware event data collection run while the collection is still in progress, the data displayed might be incomplete. The following example shows output from a D HIS command issued while data collection is still running. SYSHIS20071108.184129 is the file name prefix for all the output files for the data collection run. The PATH= /user is the USS directory where all the output files are created. The COMPLETION STATUS indicates if the instrumentation run was successful or not. LOST SAMPLES shows the total count of lost samples on all the processors if sampling is active.

The HIS profiler (the collection started by F *hisproc*,BEGIN) is the only HISSERV exploiter. It queries for counters data every 15 minutes, and takes almost .2 seconds to process each sampling data event callback.

The data collection was not complete when the D HIS command was issued, so the system had not yet converted the MAPJOB job names to MAPASID values at the time when DISPLAY command was issued, which results in the MAPASID values not being displayed in the output:

```
|
| HIS015I 10.19.12 DISPLAY HIS 241
| HIS      001E ACTIVE
| COMMAND: MODIFY HIS,B,TT='Sampling',BUF=25,PATH='/user',MJOB=(OMVS,J*,GRS)
| START TIME: 2014/10/27 10:19:08
| END TIME:   ----/--/-- --:--:--
| COMPLETION STATUS: -----
| FILE PREFIX: SYSHIS20141027.101908.
| LOST SAMPLES: 0
| COUNTER VERSION NUMBER 1: 1   COUNTER VERSION NUMBER 2: 3
| COMMAND PARAMETER VALUES USED:
|   TITLE= Sampling
|   PATH= /user
|   DURATION= 10 (MINUTES)
|   DATALOSS= IGNORE
|   STATECHANGE= SAVE
|   SMP= YES
|   BUFCNT= 25 (PAGES/PROCESSOR)
|   SAMPTYPE= DEFAULT
|   SAMPFREQ= DEFAULT
|   CNT= YES
|   COUNTER SET= BASIC,PROBLEM-STATE
|   CNTINTVAL= 15 (MINUTES)
|   CNTFILE= YES
|   MAP= YES
|   MAPJOB= OMVS   J*       GRS
| HISSERV STATUS: ACTIVE
```

DISPLAY HIS command

```
|
|          EVENT
|          AUTHORIZED= BASIC,PROBLEM-STATE,CRYPTO-ACTIVITY,EXTENDED,ZOS
|          ENABLED= BASIC,PROBLEM-STATE
|          SAMPLE
|          AUTHORIZED= BASIC
|          ENABLED= BASIC
|          BUFCNT= 25 (PAGES/PROCESSOR)
|          SAMPFREQ= 800000 (SAMPLES/MINUTE)
|          PROFILER
|          NAME      START          QUERY          SAMPLE  S F
|          HISPROF  2014/10/27 10:19:08  00:00:00.000017  ----- S
```

Example 2: In the second example, the DISPLAY command was issued after a hardware event data collection run that specified MAPONLY as well as MAPASID and MAPJOB. There are no HISSERV exploiters at the time the DISPLAY command was issued.

```
|
| HIS015I 10.40.43 DISPLAY HIS 381
| HIS      0030 IDLE
| COMMAND: MODIFY HIS,B,TT='map-only',MAPONLY,MAS=(1,EC),MJOB=(J*,GRS)
| START TIME: 2014/10/27 10:40:38
| END TIME:   ----/--/-- --:--:--
| COMPLETION STATUS: -----
| FILE PREFIX: SYSHIS20141027.104038.
| COMMAND PARAMETER VALUES USED:
| TITLE= map-only
| PATH= .
| DURATION= NOLIMIT
| DATALOSS= IGNORE
| STATECHANGE= SAVE
| SMP= NO
| CNT= NO
| MAP= YES
| MAPASID= 1 EC 12 14 1D 2A 7
| MAPJOB= J* GRS
| HISSERV STATUS: INACTIVE
|          EVENT
|          AUTHORIZED= BASIC,PROBLEM-STATE,CRYPTO-ACTIVITY,EXTENDED,ZOS
|          ENABLED= NONE
|          SAMPLE
|          AUTHORIZED= BASIC
|          ENABLED= NONE
|          BUFCNT= 9 (PAGES/PROCESSOR)
|          SAMPFREQ= 800000 (SAMPLES/MINUTE)
```

Example 3: The following D HIS command output shows a counters-only run, to collect only event counter set data, specifying all the counter sets. Note that the DISPLAY command was issued while the data collection was still ongoing.

The HIS Profiler (the collection started by F hisproc,BEGIN) and BADEXP are currently exploiting the HISSERV service. Notice how the BADEXP exploiter queries for counter data every .5 seconds, and handles sample data in an untimely manner. If hardware event data collection is degrading system performance, BADEXP might be the reason.

```
|
| HIS015I 10.42.54 DISPLAY HIS 394
| HIS      0030 ACTIVE
| COMMAND: MODIFY HIS,B,CNTSET=ALL,TITLE='Counters only',CNTONLY
| START TIME: 2014/10/27 10:42:50
| END TIME:   ----/--/-- --:--:--
| COMPLETION STATUS: -----
| FILE PREFIX: SYSHIS20141027.104250.
| COUNTER VERSION NUMBER 1: 1 COUNTER VERSION NUMBER 2: 3
| COMMAND PARAMETER VALUES USED:
| TITLE= Counters only
```

```

|          PATH= .
|          DURATION= NOLIMIT
|          DATALOSS= IGNORE
|          STATECHANGE= SAVE
|          SMP= NO
|          CNT= YES
|             COUNTER SET= BASIC,PROBLEM-STATE,CRYPTO-ACTIVITY,EXTENDED
|             CNTINTVAL= 15 (MINUTES)
|             CNTFILE= YES
|          MAP= NO
|          HISSERV STATUS: ACTIVE
|          EVENT
|             AUTHORIZED= BASIC,PROBLEM-STATE,CRYPTO-ACTIVITY,EXTENDED,ZOS
|             ENABLED= BASIC,PROBLEM-STATE,CRYPTO-ACTIVITY,EXTENDED
|          SAMPLE
|             AUTHORIZED= BASIC
|             ENABLED= NONE
|             BUFCNT= 9 (PAGES/PROCESSOR)
|             SAMPFREQ= 800000 (SAMPLES/MINUTE)
|          PROFILER
|             NAME      START          QUERY          SAMPLE  S F
|             HISPROF  2014/10/27 10:42:50  00:00:00.000016  -----
|             BADEXP   2014/10/27 06:00:00  00:00:00:538521  +999999 S

```

For more information about HIS015I, see *z/OS MVS System Messages, Vol 6 (GOS-IEA)*.

Displaying Basic HyperSwap information

Use the DISPLAY HS command to display information about the Basic HyperSwap function and the status of device pairs in the PPRC configuration. The issuing operator must have at least RACF READ authority for the DISPLAY HS command or console INFO authority. See Table 10 on page 125 and Table 11 on page 127 for additional information. The DISPLAY HS command will fail if the Basic HyperSwap Management address space is not started.

Note: Basic HyperSwap (BHS) command handling is performed by the BHS Subsystem Interface (SSI) exit processing. Therefore, this command requires the BHS management address space to be active in order to recognize and process this command. If this command is issued when the BHS management address space is not active, then message IEE305I will be issued indicating that the command is not valid at this time.

```

D HS,{STATUS}
   {CONFIG[(DETAIL[,ALL]|EXCEPTION[,ALL])][,NAME(session_name)]}

```

STATUS

Displays the current status of the Basic HyperSwap function for all systems in the sysplex (for example, enabled, disabled, HyperSwap in progress).

Message IOSHM0303I is issued in response to the D HS,STATUS command and the output is routed to the issuing console. See *z/OS MVS System Messages, Vol 9 (IGF-IWM)* for more information about the IOSHM0303I message.

CONFIG

A list of configurations (session names and session types) being maintained by Basic HyperSwap is displayed. When CONFIG is issued with either the DETAIL or EXCEPTION parameter, the current state of device pairs in the PPRC configuration (for example, Duplex, PPRC suspended, No Secondary Access) is displayed. The optional NAME parameter can be specified to

DISPLAY HS command

display a specific configuration. If NAME is not specified, the information for the configuration currently preferred for HyperSwap is displayed.

One of the following forms of the IOSHM0304I message is issued in response to this command:

- The first Active Configurations form of the IOSHM0304I message is issued in response to the DISPLAY HS,CONFIG command only and displays both HyperSwap and MetroMirror configurations.
- The HyperSwap Configuration form of the IOSHM0304I message is issued in response to the DISPLAY HS,CONFIG(*option*) or DISPLAY HS,CONFIG(*option*,ALL) command and only applies to a HyperSwap configuration.
- The second Active Configurations form of the IOSHM0304I message is issued in response to the DISPLAY HS,CONFIG command with the NAME parameter.

See *z/OS MVS System Messages, Vol 9 (IGF-IWM)* for more information about the IOSHM0304I message.

DETAIL

Lists devices with any exception in the rightmost Status column.

EXCEPTION

Displays the exception reason followed by a list of devices.

ALL

Displays all devices.

When ALL is not specified (the default), 32 devices are displayed, followed by *nnnn* Devices not Displayed.

NAME(*session_name*)

Specifies the name of the HyperSwap configuration from which the device pairs are to be displayed. When NAME is not specified, the device pairs in the current HyperSwap viable configuration are displayed.

Displaying ICSF information

On systems running ICSF FMID HCR77B1 or later, and running z/OS V1R13 (with the PTF for APAR OA47380 installed) or later, use the Display ICSF command to:

- Display the status for available cryptographic devices.
- Display certain ICSF options.
- Display information about network-attached open cryptographic servers (remote devices).
- Display information pertaining to active key data sets (KDS).
- Display the status of the master key registers for the available cryptographic devices.
- List the systems that are available to participate in commands with a SYSPLEX scope.

For a description of the Display ICSF command, see *z/OS Cryptographic Services ICSF System Programmer's Guide*.

Displaying the data set optimization configuration

Use the DISPLAY IEFOPZ command to display the data set optimization configuration defined by IEFOPZxx parmlib members.

D IEFOPZ
<pre> D IEFOPZ {,DDNAME=ddname[,JOBNAME=jobname]} {,JOBNAME=jobname} {,NEW=news[,OWNER=owner][,STATE={ACTIVE ALL}]} {,OLD=oldds[,ARCH={MAXARCH nn ALL}][,MEMBERS=members][,OWNER=owner] [,STATE={ACTIVE ALL}]} {,OWNER=owner} {,STATUS} [,L={a name name-a}] </pre>

DDNAME=ddname [,JOBNAME=jobname]

Displays each matching DDNAME/JOBNAME pair in the IEFOPZxx definition. If *jobname* is not provided, only *ddname* must match. *ddname* may be no longer than 8 characters. *jobname* may be no longer than 8 characters. The output of DISPLAY IEFOPZ, DDNAME is in the order described for the IEFOPZQ macro REQUEST=BY_DDJOBNAME.

Both *ddname* and *jobname* can have wildcard characters.

- If *ddname* has no wildcard characters and either *jobname* is not specified or *jobname* has no wildcard characters, wildcard matching is done by treating the IEFOPZxx data as the wildcard pattern and *ddname* (and, if provided, *jobname*) as the string.
- If *ddname* has wildcard characters or *jobname* has wildcard characters, wildcard matching is done by treating *ddname* (and, if provided, *jobname*) as the wildcard pattern and the IEFOPZxx data as the string. Within the string, wildcard characters are treated no differently than any other character.

For example:

- for DDNAME=AB* in the command, IEFOPZxx data with a DD of AB or ABC or AB* would match.
- for DDNAME=AB in the command, IEFOPZxx data with a DD of AB or AB* would match, but IEFOPZxx data with a DD of ABC or AB? would not.

Note: If you want to see all of the definitions that apply to a specific DDNAME, it is best to omit JOBNAME, rather than specifying JOBNAME=*, because of the rule about what is to be used as the wildcard pattern and what is to be used as the wildcard string

DDNAME can be abbreviated as DD or DDN. JOBNAME can be abbreviated as JOB.

ddname and *jobname* values will be translated to uppercase.

Do not use embedded blanks within a quoted *ddname* or a quoted *jobname*.

JOBNAME=jobname

Displays each matching DDNAME/JOBNAME pair in the IEFOPZxx definition. The output of DISPLAY IEFOPZ, JOBNAME is in the order described for the IEFOPZQ macro REQUEST=BY_DDJOBNAME.

jobname can have wildcard characters. If *jobname* has no wildcard characters, wildcard matching is done by treating the IEFOPZxx data as the wildcard pattern and *jobname* as the string; If *jobname* has wildcard characters, wildcard matching is done by treating *jobname* as the wildcard pattern and the IEFOPZxx data as the string. Within the string, wildcard characters are treated no differently than any other character. For example, for JOBNAME=AB* in the command, IEFOPZxx data with a JOBNAME of AB or ABC or AB* would

DISPLAY IEFOPZ command

match. For JOBNAME=AB in the command, IEFOPZxx data with a Jobname of AB or AB* would match, but IEFOPZxx data with a JOBNAME of ABC or AB? would not.

JOBNAME can be abbreviated as JOB.

jobname values will be translated to uppercase.

Do not use embedded blanks within a quoted *jobname*.

NEW=newds [,OWNER=owner] [,STATE={ACTIVE|ALL}]

Displays, for each matching IEFOPZ-New data set, the IEFOPZ-Old data sets associated with it. *newds* can have wildcard characters and must be no longer than 44 characters. The output of DISPLAY IEFOPZ, NEW is in the order described for the IEFOPZQ macro REQUEST=BY_NEW.

OWNER=*owner* displays data only for OLD/NEW definitions with a matching owner. OWNER=*, which is the default, displays information for all owners. *owner* must be no longer than 16 characters and can contain wildcard characters.

STATE=ACTIVE, which is the default, displays data from active definitions only. STATE=ALL displays data from all definitions. STATE=ALL can be specified as STATE=ANY.

OWNER can be abbreviated as OWN.

Do not use embedded blanks within a quoted *newds* value.

If specified within quotes, *owner* can have embedded blanks.

newds and *owner* values will be translated to uppercase.

OLD=oldds [,ARCH={MAXARCH|nn|ALL}] [,MEMBERS] [,OWNER=owner] [,STATE={ACTIVE|ALL}]

Displays, for each matching IEFOPZ-Old data set, information about the IEFOPZ-New data sets associated with it. *oldds* can have wildcard characters and must be no longer than 44 characters. The output of DISPLAY IEFOPZ, OLD is in the order described for the IEFOPZQ macro REQUEST=BY_OLD.

ARCH is specified as one of:

ARCH=MAXARCH

Displays the data set that is to be used for this IPL (as specified by the MAXARCH value). ARCH=MAXARCH is the default.

ARCH=nn

Displays the data set that will be used if the machine is ARCH=*nn*. *nn* must be 1-2 decimal digits with a value in the range from the minimum MAXARCH to 99.

ARCH=ALL

Displays all the associated data sets and their ARCH value. ARCH=ALL can be specified as ARCH=ANY.

MEMBERS indicates to also show the INCLUDE and EXCLUDE members.

OWNER=*owner* displays data only for OLD/NEW definitions with a matching owner. OWNER=*, which is the default, displays information for all owners. *owner* must be no longer than 16 characters and can contain wildcard characters. OWNER can be abbreviated as OWN.

STATE=ACTIVE, which is the default, displays data from active definitions only. STATE=ALL displays data from all definitions. STATE=ALL can be specified as STATE=ANY.

oldds and *owner* values will be translated to uppercase.

Do not use embedded blanks within a quoted *oldds* value.

If specified within quotes, *owner* can have embedded blanks.

OWNER=owner

Displays information from the IEFOPZxx OWNER statement about each matching owner in the IEFOPZxx definition. *owner* must be no longer than 16 characters and can contain wildcard characters. *owner* will always be used as the pattern in wildcard matching. Thus, for example, DISPLAY with OWNER=DENISE will not find a match with a parmlib specification of OWNER(DENIS*). Conversely, DISPLAY with OWNER=DENIS* will find a match with a parmlib specification of OWNER(DENISE). The output from DISPLAY IEFOPZ, OWNER is in the order described for the IEFOPZQ macro REQUEST=BY_OWNER

OWNER can be abbreviated as OWN.

owner values will be translated to uppercase.

If specified within quotes, *owner* can have embedded blanks.

STATUS

Displays the following information:

- The MAXARCH value
- The IEFOPZ LNKLST and LLA options that are in effect
- PARMLIB member suffixes from the IEFOPZ system parameter (if no SET IEFOPZ system command has been issued) or from the most recent SET IEFOPZ system command.

L=a, name, or name-a

Specifies the display area (a), console name (name), or both (name-a) where the display is to appear.

Examples

To display the IEFOPZ DDNAME/JOBNAME pairs that match DDNAME DD1:

```
DISPLAY IEFOPZ,DDNAME=DD1
IEFA163I 13.00.34 IEFOPZ DD/Job
DDName Jobname
DD1 J1
DD1 FRED
```

To display the IEFOPZ DDNAME/JOBNAME pairs that match job FRED:

```
DISPLAY IEFOPZ,JOB=FRED
IEFA163I 13.01.24 IEFOPZ DD/Job
DDName Jobname
DD1 FRED
DD2 FRED
```

To display the IEFOPZ IEFOPZ-New data sets for OWNER=IBM:

```
D IEFOPZ,NEW=*,OWNER=IBM
IEFA162I 12.58.38 IEFOPZ New
New: SYS2.TESTNEW1
01d: CTDSD3 SYS1.TESTOLD1
New: SYS3.TESTNEW2
01d: CTDSD3 SYS1.TESTOLD2
```

DISPLAY IEFOPZ command

| To display the IEFOPZ IEFOPZ-Old data sets that begin with SYS1, for
| OWNER=IBM that are active with ARCH that correlates to MAXARCH:

```
| DISPLAY IEFOPZ,OLD=SYS1*,OWNER=IBM  
| IEFA161I 12.56.02 IEFOPZ 01d  
| 01d:      SYS1.TESTOLD1  
|   Arch Volume DSName  
|       10      SYS2.TESTNEW1  
| 01d:      SYS1.TESTOLD2  
|   Arch Volume DSName  
|       10      SYS3.TESTNEW2
```

| To display the IEFOPZ MINARCH values for all owners:

```
| DISPLAY IEFOPZ,OWNER=*  
| IEFA166I 12.57.42 IEFOPZ Owner  
| Owner      MinArch  
| IBM        10  
| ISV2       9
```

| To display IEFOPZ status information:

```
| DISPLAY IEFOPZ,STATUS  
| IEFA160I 12.53.45 IEFOPZ Status  
| MAXARCH: 10  
| LNKLST: Yes LLA: Yes  
| IEFOPZ(s): 02
```

Displaying TSO/E parmlib information

Use the DISPLAY IKJTSO command to display the specifications in the active IKJTSOxx parmlib member.

D IKJTSO
D IKJTSO[,statement-name] [,L={a name name-a}]

IKJTSO

The system displays information from the active IKJTSOxx parmlib member.

statement-name

Displays only the specifications from an individual statement in the active IKJTSOxx parmlib member. If specified, *statement-name* can be one of the following:

ALL list of all the specifications in the active IKJTSOxx member of SYS1.PARMLIB

ALLOCATE

ALLOCATE command default data set status

AUTHCMD

list of authorized commands

AUTHPGM

list of programs that are authorized when invoked via the CALL command

AUTHTSF

list of programs that are authorized when invoked through the TSO/E service facility

CONSOLE

message processing defaults for the CONSOLE command and its services

HELP list of help data sets for different languages

LOGON

LOGON command options

NOTBKGND

list of commands not supported in the background

PLATCMD

list of commands that can run on the TSO/E command invocation platform

PLATPGM

list of programs that can run on the TSO/E command invocation platform when invoked through TSO/E service facility

SEND SEND, OPERATOR SEND, LISTBC, and BROADCAST command defaults

TEST list of additional commands and subcommands valid under TEST and TESTAUTH

TRANSREC

TRANSMIT/RECEIVE command options and defaults

L=*a*, *name*, or *name-a*

Specifies the display area (*a*), console name (*name*), or both (*name-a*) where the display is to appear.

If you omit this operand, the display is presented in the first available display area or the message area of the console through which you enter the command.

Example 1:

To display the current specifications of the LOGON statement in the active IKJTSOxx parmlib member, enter:

```
D IKJTSO,LOGON
```

The following is a sample of the information that the system displays.

```
IKJ738I TSO/E PARMLIB SETTINGS : 397
SYS1.PARMLIB(IKJTSOYY) on volume TSOSHR
Activated by **SET** on 2008-10-02 at 17:03:28 from system ZOS110
Applies to : ZOS110
CURRENT PARMLIB SETTINGS FOR LOGON:
PASSPHRASE(OFF)
VERIFYAPPL(OFF)
LOGONHERE(ON)
```

Displaying I/O configuration information

Use the DISPLAY IOS,CONFIG command to display IOS-related configuration information.

D IOS,CONFIG
D IOS,CONFIG[(EDT) (HSA) (ALL)][,L={a name name-a}]

DISPLAY IOS,CONFIG command

IOS,CONFIG

The system displays information about the I/O configuration through message IOS506I.

EDT

Displays (message IOS506I) the jobs with outstanding binds on the primary Eligible Device Table (EDT), and, if applicable, on the secondary EDT.

HSA

Displays (message IOS506I) the amount of the hardware system area (HSA) that is available to perform configuration changes and the amount of space for each subchannel set within each channel subsystem.

ALL

Displays information (message IOS506I) about the I/O configuration and the amount of the hardware system area (HSA) that is available to perform configuration changes.

L=*a*, *name*, or *name-a*

Specifies the display area (*a*), console name (*name*), or both (*name-a*) where the display is to appear.

If you omit this operand, the display is presented in the first available display area or the message area of the console through which you enter the command.

Displaying captured UCB information

Use the DISPLAY IOS,CAPTUCB command to display the current captured UCB protection status.

D IOS,CAPTUCB
D IOS,CAPTUCB[,L={ <i>a</i> <i>name</i> <i>name-a</i> }]

IOS,CAPTUCB

The system displays information about the current captured UCB protection status.

L=*a*, *name*, or *name-a*

Specifies the display area (*a*), console name (*name*), or both (*name-a*) where the display is to appear.

If you omit this operand, the display is presented in the first available display area or the message area of the console through which you enter the command.

The following example shows the message that is displayed in response to the command.

```
D IOS,CAPTUCB
IOS088I hh.mm.ss CAPTURED UCB DATA
CAPTURED UCB PROTECTION IS ENABLED|DISABLED
```

Displaying IOS control unit group information

Use the DISPLAY IOS,CUGRP command to display the information about one or more IOS control unit groups. A control unit group consists of one or more control units that share the same set of static CHPIDs. Each control unit group is assigned a group identifier that is the same as the lowest numbered control unit in the

group. When dynamic channel-path management (DCM) makes a change, it makes a change to all managed control units in a control unit group at the same time.

```
D IOS,CUGRP[,ID=groupid      ]
              [,DETAIL        ]
              [,L={a|name|name-a}]
```

IOS,CUGRP

Displays information about one or more IOS control unit groups.

ID=groupid

Displays information about a specific control unit group. *groupid* specifies the control unit group identifier, which consists of three or four hexadecimal digits. If ID=*groupid* is not specified, information about all control unit groups is displayed.

DETAIL

Displays detailed information about the control unit group, which includes the list of control units.

L=a, name, or name-a

Specifies the display area (*a*), console name (*name*), or both (*name-a*) where the display is to appear.

If you omit this operand, the display is presented in the first available display area or the message area of the console through which you enter the command.

Example 1:

To display a summary of the control unit groups, enter:

```
D IOS,CUGRP
```

The system displays the following message:

```
IOS632I 21.33.53 CU GROUP DATA
GROUP STATIC CHPIDS          MAX #CUS DCM
1000 81 A1 A5 A8             3  10  Y
3000 C4 D4                   3   8  Y
3100 B4                       3   7  Y
6200 A1 C1 D1                3   2  Y
B000 82 83 CD                5  15  Y
E000 30 31 8A 8B             0   9  N
EB00 82 83 9E 9F             3  16  N
```

Example 2:

To display detailed information for control unit group 1000,, enter one of the following commands:

```
D IOS,CUGRP,ID=1000,DETAIL
D IOS,CUGRP,DETAIL,ID=1000
```

The system displays the following message:

```
IOS632I 12.23.01 CU GROUP DATA 059
GROUP STATIC CHPIDS          MAX #CUS DCM
1000 81 A1 A5 A8             3  10  Y
```

DISPLAY IOS,CUGRP command

```
PCU ID=1000 ND=002107.922.IBM.75.000000002471 MGD=N
CONTROL UNITS: 1000 1C00 1D00 1E00 1F00 7A00 7B00
PCU ID=1100 ND=002107.922.IBM.75.000000002471 MGD=Y
CONTROL UNITS: 1100 1200 1300
```

Displaying dynamic channel path management information

Use the DISPLAY IOS,DCM command to display the current status of dynamic channel path management and to display the list of devices that do not have measurement blocks assigned.

D IOS,DCM
D IOS,DCM[,L={a name name-a}]

IOS,DCM

The system displays information about dynamic channel path management.

L=*a*, *name*, or *name-a*

Specifies the display area (*a*), console name (*name*), or both (*name-a*) where the display is to appear.

If you omit this operand, the display is presented in the first available display area or the message area of the console through which you enter the command.

Displaying encryption key manager (EKM) status

Use the DISPLAY IOS,EKM command to display the current hostnames and connection numbers of encryption key management.

Use the DISPLAY IOS,EKM,VERIFY={PRIMARY|SECONDARY|ALL} to verify the connection of encryption key manager. Note that the initial IOS099I message that is issued immediately in response to this command does not show the actual validity of the encryption key manager's connections. An IOS631I message indicating that the encryption key manager was successfully connected, or an IOS627E message indicating that there was a failure is to be issued as well and might appear several minutes after the IOS099I message is displayed.

D IOS,EKM[,VERIFY={PRIMARY SECONDARY ALL}] [,L={a name name-a}]
--

IOS,EKM

Displays the host names of the primary and secondary encryption key managers, the maximum number of connections and the maximum number of permanent connections that can be used for encryption key management.

VERIFY=PRIMARY

Initiates an asynchronous test exchange with the primary encryption key manager to verify its usability.

VERIFY=SECONDARY

Initiates an asynchronous test exchange with the secondary encryption key manager to verify its usability.

VERIFY=ALL

Initiates an asynchronous test exchange with both the primary and secondary encryption key managers to verify their usability.

L=*a*, *name*, or *name-a*

Specifies the display area (*a*), console name (*name*), or both (*name-a*) where the display is to appear.

If you omit this operand, the display is presented in the first available display area or the message area of the console through which you enter the command.

Example 1:

To display the current encryption key manager settings, enter:

```
D IOS,EKM
```

The system displays the following message:

```
SY1 IOS099I 17.04.49 EKM HOSTS 833
PRIMARY HOSTNAME=text1
SECONDARY HOSTNAME=text2
MAX CONNECTIONS = dd1 PERMANENT CONNECTIONS = dd2
```

Example 2:

To test the connectivity of the primary encryption key manager, enter:

```
D IOS,EKM,VERIFY=PRIMARY
```

The system first displays the following message:

```
SY1 IOS099I 17.04.49 EKM HOSTS 833
PRIMARY HOSTNAME=text1
SECONDARY HOSTNAME=text2
MAX CONNECTIONS = dd1 PERMANENT CONNECTIONS = dd2
```

The system then displays one of the following two messages:

- If the encryption key manager connection is successfully verified, the system displays the following message:

```
IOS631I PRIMARY ENCRYPTION KEY MANAGER WAS SUCCESSFULLY CONNECTED
```

- If the encryption key manager connection is not successfully verified and has failed, the system displays the following message:

```
IOS627E PRIMARY INTERFACE WITH ENCRYPTION KEY MANAGER CANNOT BE CONNECTED DUE TO reason
```

Displaying zHPF facility status

Use the DISPLAY IOS,ZHPF command to display the current status (enabled or disabled) of the High Performance FICON for z Systems (zHPF) facility.

```
D IOS,ZHPF
```

```
D IOS,ZHPF[,L={a|name|name-a}]
```

IOS,ZHPF

The system displays the current zHPF enablement status.

DISPLAY IOS,zHPF command

L=a, name, or name-a

Specifies the display area (*a*), console name (*name*), or both (*name-a*) where the display is to appear.

If you omit this operand, the display is presented in the first available display area or the message area of the console through which you enter the command.

Displaying FICON switch data information

Use the DISPLAY IOS,FICON command to display the current status (ENABLED or DISABLED) of FICON switch statistics gathering and fabric I/O priority.

D IOS,FICON
D IOS,FICON[,L={a name name-a}]

IOS, FICON

The system displays information about FICON switches.

L=a, name, or name-a

Specifies the display area (*a*), console name (*name*), or both (*name-a*) where the display is to appear.

If you omit this operand, the display is presented in the first available display area or the message area of the console through which you enter the command.

Displaying IOS group information

Use the DISPLAY IOS,GROUP command to display a list of system names that all belong to the same IOS group.

D IOS,GROUP
D IOS,GROUP[,L={a name name-a}]

IOS, GROUP

The system displays information about systems in an IOS group.

L=a, name, or name-a

Specifies the display area (*a*), console name (*name*), or both (*name-a*) where the display is to appear.

If you omit this operand, the display is presented in the first available display area or the message area of the console through which you enter the command.

Displaying IOS HYPERPAV information

Use the DISPLAY IOS,HYPERPAV command to display the current HyperPAV enablement status.

D IOS,HYPERPAV[,L={a name name-a}]

IOS,HYPERPAV

The system displays information about the current HyperPAV enablement status.

L=*a*, *name*, or *name-a*

Specifies the display area (*a*), console name (*name*), or both (*name-a*) where the display is to appear.

If you omit this operand, the display is presented in the first available display area or the message area of the console through which you enter the command.

Displaying the IBM zHyperWrite data replication status

Use the DISPLAY IOS,HYPERWRITE command to display the current IBM zHyperWrite data replication enablement status.

```
D IOS,HYPERWRITE[,L={a|name|name-a}]
```

IOS,HYPERWRITE

The system displays whether IBM zHyperWrite data replication is enabled or disabled on a system-wide basis.

Note: Certain exploiting applications, such as DB2®, may also provide their own controls to enable or disable the use of this function.

L=*a*, *name*, or *name-a*

Specifies the display area (*a*), console name (*name*), or both (*name-a*) where the display is to appear.

If you omit this operand, the display is presented in the first available display area or the message area of the console through which you enter the command.

Displaying MIDAW facility status

Use the DISPLAY IOS,MIDAW command to display the current status (enabled or disabled) of the modified indirect addressing word (MIDAW) facility.

```
D IOS,MIDAW[,L={a|name|name-a}]
```

IOS,MIDAW

The system displays status information about the MIDAW facility.

L=*a*, *name*, or *name-a*

Specifies the display area (*a*), console name (*name*), or both (*name-a*) where the display is to appear.

If you omit this operand, the display is presented in the first available display area or the message area of the console through which you enter the command.

Displaying MIH and I/O timing limits

Use the DISPLAY IOS,MIH command to request a display of the current time intervals for the missing interrupt handler (MIH) or I/O timing (IOT) limits.

DISPLAY IOS,MIH command

You can display the MIH time interval for all device classes, a specific device class, or one or more specific devices.

You can display the I/O timing limits for a device class or for one or more specific devices. You can request that the display be either formatted or unformatted.

The display, which is delivered by the WTO facility, is limited to 255 lines of output. If the limit is reached, the display is truncated. In this case, the last line of output is "... MAXIMUM DISPLAY OF 255 LINES EXCEEDED". Use the TIME, DEV, or DEVX parameter to request a selective display, to avoid missing data that meets the search criteria.

D IOS,MIH	
D IOS,MIH[,TIME={ <u>ALL</u> option}]
[]
[,{DEV }={{[/]devnum[,[/]devnum1]...}]
[{DEVX } {{[/]devnum-[/]devnum1[,[/]devnum2-[/]devnum3]...}]
[{TDEV }]
[{TDEVX}]
[,IOTHSWAP]
[,L={a name name-a}]

The parameters are:

IOS,MIH

The MIH detects missing interrupt conditions. The I/O timing facility detects I/O requests that have exceeded the specified time limit. This command allows you to display the I/O timing limits or MIH time intervals established for the different devices on the system.

TIME=ALL

Displays the IOT and MIH time intervals established for all device classes and all individual devices.

TIME=option

Displays one of the following time intervals:

UREC

Displays the MIH time interval for the unit record device class.

TAPE

Displays the MIH time interval for the tape drive device class.

CTC

Displays the MIH time interval for the channel-to-channel device class.

COMM

Displays the MIH time interval for the communications device class.

CHAR

Displays the MIH time interval for the character reader device class.

GRAF

Displays the MIH time interval for the graphics device class.

DASD

Displays the MIH time interval for the DASD device class.

IOTDASD

Displays the I/O timing (IOT) time interval for the DASD device class.

USnn

Displays the MIH or IOT time interval for a user-specified class, where nn can be any two-digit number from 01 through 99 that matches a device group created by MIH or IOT processing. A user-specified device group is a set of devices associated with a specific time interval. The system creates this type of group and assigns the user class number (USnn) when either of the following is true:

- The MIH time interval is not equal to the time interval of its device class
Note: Some devices present their own MIH timeout values, via the primary/secondary MIH timing enhancement contained in the self-describing data for the device. If the primary MIH timeout value for the device does not equal the timeout value for the device class, and the device's timeout value has not been altered by the user, the system will create a user-specified class to contain the timeout value for the device. The user-specified class for these devices will be created at IPL (if the device is defined to be ONLINE), or at VARY ONLINE time.
- The IOT time interval is not equal to the time interval of its device class.

HALT

Displays the MIH time interval for monitoring halt (HSCH) and clear (CSCH) subchannel operations. This keyword is device independent; setting it affects all devices on the system.

MNTS

Displays the MIH time interval for monitoring *mount pending* conditions for DASD and TAPE devices. This keyword is device independent; setting it affects all devices on the system.

DEV= { ([/]devnum[, [/]devnum1]...) }
 { ([/]devnum- [/]devnum1[, [/]devnum2- [/]devnum3]...) }

Displays the MIH time interval for a specific device number or for a range of device numbers. You can specify one or more single device numbers, one or more ranges of device numbers, or all device numbers. When you specify a range of device numbers, the first device number in the range must be less than or equal to the second device number. If you specify only one device number, you can omit the parentheses.

The display is formatted.

A device number consists of 3 or 4 hexadecimal digits, optionally preceded by a slash (/).

DEVX= { ([/]devnum[, [/]devnum1]...) }
 { ([/]devnum- [/]devnum1[, [/]devnum2- [/]devnum3]...) }

Displays the MIH time interval for the specific defined device number or for a range of device numbers. You can specify one or more single device numbers, one or more ranges of device numbers, or all device numbers. When you specify a range of device numbers, the second device number in the range must be more than or equal to the first device number. If you specify only one device number, you can omit the parentheses.

The display is unformatted.

A device number consists of 3 or 4 hexadecimal digits, optionally preceded by a slash (/).

TDEV= { ([/]devnum[, [/]devnum1]...) }

DISPLAY IOS,MIH command

{([/]dev vnum-[/]devnum1[, [/]devnum2-[/]devnum3]...) }

Displays the I/O timing limit for the specific defined device number or for a range of device numbers. You can specify one or more single device numbers, one or more ranges of device numbers, or all device numbers. When you specify a range of device numbers, the second device number in the range must be more than or equal to the first device number. If you specify only one device number, you can omit the parentheses.

The display is formatted.

A device number consists of 3 or 4 hexadecimal digits, optionally preceded by a slash (/).

TDEVX= {[/]devnum[, [/]devnum1]...)&tab;}

{([/]devnum-[/]devnum1[, [/]devnum2-[/]devnum3]...) }

Displays the I/O timing limit for the specific defined device number or for a range of device numbers. You can specify one or more single device numbers, one or more ranges of device numbers, or all device numbers. When you specify a range of device numbers, the first device number in the range must be less than or equal to the second device number. If you specify only one device number, you can omit the parentheses.

The display is unformatted.

A device number consists of 3 or 4 hexadecimal digits, optionally preceded by a slash (/).

L=a, name, or name-a

Specifies the display area (*a*), console name (*name*), or both (*name-a*) where the display is to appear.

If you omit this operand, the display is presented in the first available display area or the message area of the console through which you enter the command.

Example 1:

To display the MIH and IOT intervals for all device classes and all individual devices, enter:

```
D IOS,MIH
```

Example 2:

To display the MIH interval for the devices in address range 000 through 01A, enter:

```
D IOS,MIH,DEV=(000-01A)
```

The display is formatted:

```
IOS086I 14.34.51 MIH DEVICE TIMES
0000=03:00, 0002=03:00, 0003=03:00, 0004=03:00, 0005=03:00,
0006=03:00, 0007=03:00, 0008=03:00, 000A=03:00, 000B=03:00,
000C=03:00, 000D=03:00, 000E=03:00, 000F=03:00, 0011=03:00,
0012=03:00, 0013=03:00, 0014=03:00, 0015=03:00, 0016=03:00,
0017=03:00, 0018=03:00, 0019=03:00, 001A=03:00.
```

Example 3:

To display the MIH interval for the devices in address range 000 through 0D9, enter:

```
D IOS,MIH,DEVX=(000-0D9)
```

The display will be unformatted.

```
IOS086I 14.43.28 MIH DEVICE TIMES
(0000,0002-0008,000A-000F,0011-001D)=03:00, (001E-009D)=00:00,
(009E-009F)=03:00, (00A0-00A1)=00:15, (00BA-00BF)=00:00, (00C0-00C1)=
00:15, (00CA-00CF)=00:00.
```

Example 4:

To display the MIH interval for the devices in address range ABC0 through ABCD, enter:

```
D IOS,MIH,DEV=(/ABC0-/ABCD)
```

Example 5:

To display the I/O timing limit for the devices in address range 000-010, enter:

```
DISPLAY IOS,MIH,TDEVX=(000-010)
```

The system might display the following:

```
IOS086I 14.44.50 IOT DEVICE TIMES
0002=00:10, (0003-0008,000A-000F)=00:00, 0010=00:15.
```

In this example, devices 000, 001, and 009 do not exist. The I/O timing limit for device 002 is 0 minutes and 10 seconds. The I/O timing limit for device 003-008 and 00A-00F is 0 minutes and 0 seconds. For device 010, the I/O timing limit is 0 minutes and 15 seconds.

Displaying IOS recovery options

Use the D IOS,RECOVERY command to display the current IOS recovery options.

```
D IOS,RECOVERY[,L={a|name|name-a}]
```

IOS,RECOVERY

The system displays status information about the IOS recovery function.

L=a, name, or name-a

Specifies the display area (*a*), console name (*name*), or both (*name-a*) where the display is to appear.

If you omit this operand, the display is presented in the first available display area or the message area of the console through which you enter the command.

Displaying IOS storage residency information

Use the DISPLAY IOS,STORAGE command to display the storage residency of where IOS blocks are to be obtained (24 or 31 bit).

```
D IOS,STORAGE[,L={a|name|name-a}]
```

IOS,STORAGE

The system displays information about IOS storage residency.

DISPLAY IOS,STORAGE command

L=a, name, or name-a

Specifies the display area (*a*), console name (*name*), or both (*name-a*) where the display is to appear.

If you omit this operand, the display is presented in the first available display area or the message area of the console through which you enter the command.

Displaying the devices stopped by the IOACTION command

Use the DISPLAY IOS,STOP command to identify the shared DASD that is currently stopped as result of the IOACTION STOP command.

D IOS,STOP
D IOS,STOP[,L={a name name-a}]

IOS,STOP

The system displays information (message IOS610I) about the devices affected by the IOACTION STOP command. For example:

IOS610I IOACTION – THE FOLLOWING DEVICE(S) ARE IN THE STOPPED STATE:

420- 42F, 440- 44F, 470- 48F, 4A0- 4AF, 4C0- 4E7

L=a, name, or name-a

Specifies the display area (*a*), console name (*name*), or both (*name-a*) where the display is to appear.

If you omit this operand, the display is presented in the first available display area or the message area of the console through which you enter the command.

Displaying IPL information

Use the DISPLAY IPLINFO command to display the following information. The output is message IEE254I.

- The date and time of the IPL
- The release level of the system
- The license value for the system
- The contents of parmlib members IEASYSxx and IEASYMxx
- LOADxx information used for the IPL
- The architecture level of the IPL
- The IODF (input/output definition file) device
- The IPL device and volume serial number from which the system was IPLed
- The status of MTL (manual tape library) tape devices

Use the DISPLAY IPLINFO,*sysparm* command to display the value specified or defaulted for any system parameter that is allowed within IEASYSxx. The output is message IEE255I.

Use the DISPLAY IPLINFO,*sysparm*,STATE command to display the state (active or inactive) associated with a system parameter that is allowed within IEASYSxx. The command is supported only for the ZAAPZIIP system parameter and its alias ZZ. The output is message IEE256I.

DISPLAY IPLINFO command

Use the DISPLAY IPLINFO,LOADXX,MACHMIG command to display the MACHMIG statement(s) from the LOADxx parmlib member. The output is message IEE580I.

```
D IPLINFO [,sysparm[,STATE]] | [LOADXX,MACHMIG] [,L={a|name|name-a}]
```

sysparm

Any system parameter that is allowed within IEASYSxx.

LOADXX,MACHMIG

Displays the MACHMIG statement(s) from the LOADXX parmlib member.

L=a, name, or name-a

Specifies the display area (*a*), console name (*name*), or both (*name-a*) where the display is to appear.

If you omit this operand, the display is presented in the first available display area or the message area of the console through which you enter the command.

Example 1:

Assume a system has the following characteristics:

- IPL occurred on December 1, 2006 at 1:15 a.m.
- The release level is z/OS 1.8.0.
- The license type is z/OS.
- Parmlib member LOAD08 in SYS0.IPLPARM, which resides on device ACB2, was used to IPL.
- The system treats MTL tape devices as MTL resident drives.
- The system used system symbols definitions in IEASYMX6, IEASYMU6, IEASYM0L, and IEASYMR8.
- The operator entered IEASYSST and IEASYSLN in reply to the system parameters prompt.
- The IODF device resides on ACB2.
- The IPL device is 3C2A and its volume serial is D83EL8.

Issue the following command:

```
D IPLINFO
```

The system returns the following display, slightly modified to improve readability:

```
IEE254I 11.14.07 IPLINFO DISPLAY 350
SYSTEM IPLED AT 01.15.39 ON 12/01/2006
RELEASE z/OS 01.08.00 LICENSE = z/OS
USED LOAD08 IN SYS0.IPLPARM ON ACB2
ARCHLVL = 2 MTLSHARE = N
IEASYM LIST = (X6,U6,0L,R8)
IEASYS LIST = (ST,LN) (0P)
IODF DEVICE ACB2
IPL DEVICE 3C2A VOLUME D83EL8
```

Example 2:

Assume that you specified (or defaulted to) ZAAPZIIP=YES. Issue the following command:

DISPLAY IPLINFO command

```
D IPLINFO,ZAAPZIIP
```

The system returns the following display:

```
IEE255I SYSTEM PARAMETER 'ZAAPZIIP': YES
```

Example 3:

Assume that you specified (or defaulted to) ZAAPZIIP=YES but ZAAPs are assigned to this LPAR. Issue the following command:

```
D IPLINFO,ZAAPZIIP,STATE
```

The system returns the following display:

```
IEE256I ZAAPZIIP STATE: INACTIVE - ZAAP(S) DEFINED TO THIS LPAR
```

Displaying PCIE-related parameters

Use the DISPLAY IQP command to display parameters that are used for managing PCIE-related features, such as the zEDC Express[®] feature.

```
D IQP[,L={a|name|name-a}]
```

IQP

The system issues the IQP066I message to display the IQP parameters. The IQP parameters are defined in the IQPPRMxx parmlib member. For more information about the IQPPRMxx member, see *z/OS MVS Initialization and Tuning Reference*.

L=a, name, or name-a

Specifies the display area (a), console name (name), or both (name-a) where the display is to appear.

If you omit this operand, the display is presented in the first available display area or the message area of the console through which you enter the command.

Displaying system activity

Use the DISPLAY JOBS (or J or A or TS) command to display information about current system activity. The descriptions of messages IEE114I and IEE115I show the resulting display. The syntax of this command is:

```
D {JOBS|J|A}[, {LIST|L}], [USERID=userid]
or
D {TS}[, {LIST|L}]
           |, {ALL|A}
           |, {jobname[.identifier]}|(jobname)}

[,L={a|name|name-a}]
```

The parameters are:

JOBS or J or A or TS

The system is to display the following overview information about system activity:

- Number of active batch jobs

DISPLAY JOBS or J or A or TS command

- Number of started tasks (MOUNT commands in execution are treated as started tasks)
- Number of logged-on time-sharing users
- Number of logged-on time-sharing users running under TSO/VTAM
- The maximum number of time-sharing users allowed to be logged on under TSO/VTAM
- Number of active system address spaces
- Number of active initiators including Advanced Program-to-Program Communication/MVS (APPC/MVS) transaction initiators
- Number of z/OS UNIX System Services address spaces

LIST or L

The system is to display detailed information for active jobs and started tasks (JOBS or J), logged-on time-sharing users (TS), active APPC/MVS transaction programs, or all three (A).

ALL or A

The system is to display more detailed information for active jobs and started tasks, logged-on time-sharing users, active APPC/MVS transaction programs, active initiators, and active system address spaces than that supplied by LIST.

jobname[.identifier] or (*jobname*)

The system is to display detailed information for active jobs, started tasks, logged-on time-sharing users, active APPC/MVS transaction programs, active initiators, and active system address spaces with the specified name. This information includes the data space names associated with the address space. If the specified name is the same as a valid secondary operand, you must enclose it in parentheses. (See Example 7.)

The specified name can be the name of a job, started task, APPC/MVS transaction program, APPC/MVS scheduler initiator, time-sharing user, or system address space. For a job, started task, APPC/MVS transaction program, APPC/MVS scheduler initiator, or system address space, the name can be 1 to 8 alphanumeric or national characters or 1 to 7 alphanumeric or national characters followed by an asterisk. For a time-sharing user, the name can be 1 to 7 alphanumeric or national characters or 1 to 6 alphanumeric or national characters you use the asterisk format, all jobs, APPC/MVS transaction programs, APPC/MVS scheduler initiators, started tasks, or time-sharing users with names that begin with the specified characters are displayed. See Example 5.

Note:

1. You can use asterisk notation to display information about more than one job or started task. See “Using wildcards to display system activity” on page 349 for more information.
2. The only time you may use an asterisk in the first position of a name is to specify the master scheduler address space: *MASTER*. For *MASTER*, the name must be the complete address space name.
3. Started task names can come from a variety of sources. The name of a started task depends on whether the JOBNAM keyword was specified on the START command.

If JOBNAM was specified, *jobname* is the name assigned to the started task.

DISPLAY JOBS or J or A or TS command

If JOBNAME was not specified and the source JCL for the started task is:

- A *job*, the system uses the jobname provided with the JCL JOB statement.
- A *procedure*, the system uses the member name as the jobname.

Refer to “Displaying started task status” on page 353 for information on determining the jobname and identifier of currently active started tasks.

identifier

The started task identifier. You can use asterisk notation to display information about more than one job or started task. See “Using wildcards to display system activity” on page 349 for more information.

USERID=userid

A filter to display only the work executing on behalf of *userid*. This userid may be specified on the *USER=* keyword in JCL, or the userid that requested that a transaction occur.

L=a, name, or name-a

Specifies the display area (*a*), console name (*name*), or both (*name-a*) where the display is to appear.

If you omit this operand, the display is presented in the first available display area or the message area of the console through which you enter the command.

Information for the LIST operand

The system displays detailed information when you specify LIST or L. The detailed information is displayed after the overview information. Table 26 shows the operands that you can combine with LIST or L and the detailed information that results from each combination.

Table 26. Displaying System Activity: Information for the LIST Operand

Primary Operand	Information for the LIST Operand
JOBS or J	List of active jobs, including, for each job: <ul style="list-style-type: none">• Jobname, APPC/MVS transaction program, started task• Stepname• Procedure stepname or requesting userid• Type of job• Address space status• Central (real) address range (V=R only)
TS	List of logged-on time-sharing users, including, for each user: <ul style="list-style-type: none">• Userid• Address space status
A	List of all active units of work, including: <ul style="list-style-type: none">• For active jobs, started tasks, and APPC/MVS transaction programs all of the information listed for JOBS or J• For logged-on time-sharing users, all of the information listed for TS

The system displays more detailed information when you specify ALL or A than when you specify LIST or L. The detailed information is displayed after the

DISPLAY JOBS or J or A or TS command

overview information. Table 27 shows the operands that you can combine with ALL or A and the detailed information that results from each combination.

Table 27. Displaying System Activity: Information for the ALL Operand

Primary Operand	Information for the ALL Operand
JOBS or J	<p>List of active jobs, including, for each job:</p> <ul style="list-style-type: none"> • Jobname (APPC/MVS transaction program name), started task • Stepname • Procedure stepname or requesting userid • Type of job • Address space identifier • Address space status • Program event recording (PER) activity • Number of outstanding step-must-complete requests • Processor affinity • Elapsed time since initiation • Accumulated processor time • Work unit identifier • Transaction requestor's userid • Central (real) address range (V=R only)
	<p>Workload management information:</p> <ul style="list-style-type: none"> • Workload associated with the address space • Service class associated with the address space • Resource group associated with the service class. "N/A" is displayed if there is no resource group assigned to the service class • Whether the address space has been quiesced by the RESET command • Whether the address space is a server • The service class period
TS	<p>List of logged-on time-sharing users, including, for each user:</p> <ul style="list-style-type: none"> • Address space status • Address space identifier • Program event recording (PER) activity • Number of outstanding step-must-complete requests • Processor affinity • Elapsed time since LOGON • Accumulated processor time • Work unit identifier
	<p>Workload management information:</p> <ul style="list-style-type: none"> • Workload associated with the address space • Service class associated with the address space • Resource group associated with the service class. "N/A" is displayed if there is no resource group assigned to the service class • Whether the address space has been quiesced by the RESET command • Whether the address space is a server • The service class period

DISPLAY JOBS or J or A or TS command

Table 27. Displaying System Activity: Information for the ALL Operand (continued)

Primary Operand	Information for the ALL Operand
A	<p>List of all active units of work, including:</p> <ul style="list-style-type: none"> • For each active job, started task, APPC/MVS transaction program, and APPC/MVS scheduler initiator: <ul style="list-style-type: none"> – All of the information listed for JOBS or J • For each time-sharing user: <ul style="list-style-type: none"> – All of the information listed for TS • For each active system address space: <ul style="list-style-type: none"> – Name – Stepname – Procedure stepname

The system displays the most detailed information when you supply a specific name. This additional information may be useful to the system programmer for diagnostics. The detailed information is displayed after the overview information, Table 28 shows the operands that you can combine with a specific name and the detailed information that results from each combination.

Table 28. Displaying System Activity: Information for a Specific Name

Primary Operand	Information for the NAME Operand
JOBS or J	<p>List of active jobs for the specific name:</p> <ul style="list-style-type: none"> • Jobname, APPC/MVS transaction program name, initiator address space name • Stepname • Procedure stepname or requesting userid • Type of job • Address space identifier • Address space status • Program event recording (PER) activity • Number of outstanding step-must-complete requests • Processor affinity • Elapsed time since initiation • Accumulated processor time • Work unit identifier • Transaction requestor's userid • Central (real) address range (V=R only) • Central (real) address of address space number second table (ASTE) • Data space names and the data space ASTEs

DISPLAY JOBS or J or A or TS command

Table 28. Displaying System Activity: Information for a Specific Name (continued)

Primary Operand	Information for the NAME Operand
	<p>Workload management information:</p> <ul style="list-style-type: none"> • Workload associated with the address space • Service class associated with the address space • Resource group associated with the service class. "N/A" is displayed if there is no resource group assigned to the service class • Whether the address space has been quiesced by the RESET command • Whether the address space is a server • The service class period
TS	<p>List of logged-on time-sharing users with the specific name:</p> <ul style="list-style-type: none"> • Address space status • Address space identifier • Program event recording (PER) activity • Number of outstanding step-must-complete requests • Processor affinity • Elapsed time since LOGON • Work unit identifier • Accumulated processor time • Central (real) address of address space number second table (ASTE) • Data space names and the data space ASTEs
	<p>Workload management information:</p> <ul style="list-style-type: none"> • Workload associated with the address space • Service class associated with the address space • Resource group associated with the service class. "N/A" is displayed if there is no resource group assigned to the service class • Whether the address space has been quiesced by the RESET command • Whether the address space is a server • The service class period
A	<p>List of all active units of work for the specific name, including:</p> <ul style="list-style-type: none"> • For an active job, active APPC/MVS transaction program name, initiator address space and started task: <ul style="list-style-type: none"> – All of the information listed for JOBS or J • For a time-sharing user: <ul style="list-style-type: none"> – All of the information listed for TS • For an active system address space: <ul style="list-style-type: none"> – Name – Stepname – Procedure stepname

Using wildcards to display system activity

You can use the asterisk (*) wildcard to display information about more than one job or started task. A trailing asterisk (*) indicates that a DISPLAY command applies to *all* jobs or started tasks that match a leading character string. The

DISPLAY JOBS or J or A or TS command

DISPLAY JOBS, J, A, or TS command supports only a *trailing* asterisk. You cannot specify an asterisk in other character positions in job or started task names.

For example, you can enter the following command to display information about all jobs and started tasks beginning with the characters X11:

```
D A,X11*
```

You can also use the asterisk wildcard to specify both a job name and identifier. The system displays information about all jobs and started tasks that match the combinations of characters that precede one or more asterisks.

For example, you can enter the following command to pass a two-digit value to all jobs with names that begin with J22 *and* identifiers that begin with X11:

```
D A,J22*.X11*
```

Remember the following rules when using the asterisk wildcard in the DISPLAY JOBS, J, A, or TS command:

- If you specify both the *jobname* and *identifier* values, you cannot specify a single asterisk for *both* values.

For example, to display information about all jobs with names beginning with J22, you can specify a single asterisk on the *identifier* to indicate a *wildcard*:

```
D A,J22*.*
```

If you were to remove the J22 characters from the command, it would not be valid. You cannot specify *.* without a leading character string on the *jobname* parameter, the *identifier* parameter, or both.

- A slash (/) cannot precede an identifier that contains an asterisk.

The following tables describe how the asterisk wildcard works with DISPLAY JOBS, J, A, or TS. Table 29 shows examples of START commands used to start jobs. The third and fourth columns show the associated jobnames and identifiers.

Table 29. Examples of START Commands to Start Jobs

Job Number	START Command	Jobname	Identifier
1	START YZ	YZ	YZ
2	START WX.YZ	WX	YZ
3	START WX.YZ1	WX	YZ1
4	START WX1.YZ1	WX1	YZ1
5	START WX, JOBNAME =WX1	WX1	WX1
6	START WX, JOBNAME =WX2	WX2	WX2
7	START WX, JOBNAME =YZ	YZ	YZ
8	START Q.YZ3	Q	YZ3
9	START WX.R1	WX	R1
10	START WX, JOBNAME =YZ4	YZ4	YZ4

Table 30 on page 351 shows examples of DISPLAY commands. (The examples apply to DISPLAY JOBS, J, A, or TS, although only DISPLAY A commands are used in this figure.) The numbers in the second column indicate the jobs in Table 29 that apply to each DISPLAY command.

DISPLAY JOBS or J or A or TS command

Table 30. Examples of DISPLAY Commands

DISPLAY Command	Displayed Jobs
D A,YZ	1, 7
D A,WX.YZ	2
D A,WX.YZ*	2, 3
D A,YZ.*	1, 7
D A,WX*	2, 3, 4, 5, 6, 9
D A,YZ*	1, 7, 10
D A,WX*.YZ	2
D A,WX*.YZ*	2, 3, 4
D A,*.YZ*	1, 2, 3, 4, 7, 8, 10
D A,*.YZ	1, 2, 7
D A,WX*.*	2, 3, 4, 5, 6, 9
D A,WX.*	2, 3, 9
D A,*	Not valid (can be done using D A,ALL)
D A,*.*	Not valid (can be done using D A,ALL)

The following are examples of various forms of the DISPLAY JOBS, J, A, or TS command:

Example 1:

To display detailed information about all active units of work, enter:

```
D A,L
```

Example 2:

To display detailed information about active jobs, enter:

```
D J,L
```

Example 3:

To display more detailed information about active jobs, enter:

```
D J,A
```

Example 4:

To display detailed information about any active time-sharing user with the name WAGNERJ, enter:

```
D TS,WAGNERJ
```

Example 5:

To display detailed information about all active jobs, started tasks, time-sharing users, or address spaces with the name beginning with D96, enter:

```
D A,D96*
```

Example 6:

DISPLAY JOBS or J or A or TS command

To display detailed information about the master scheduler address space, enter:

```
D A,*MASTER*
```

Example 7:

To display detailed information about any active time-sharing user with the name LIST, enter:

```
D TS,(LIST)
```

Example 8:

To display detailed information about all jobs or APPC/MVS transaction programs running for user WANDA, enter:

```
D J,L,USERID=WANDA
```

Example 9:

To display detailed information about any jobs or APPC/MVS transaction programs named PHONE running for user WANDA, enter:

```
D J,PHONE,USERID=WANDA
```

Example 10:

To display detailed information about all initiator address spaces beginning with INIT, enter:

```
D A,INIT*
```

Example 11:

To display detailed information about started task X11 which has a job name of AOR2, enter:

```
D A,AOR2.X11
```

Example 12:

To display detailed information about all started tasks with the job name AOR2, enter:

```
D A,AOR2.*
```

Example 13:

To display detailed information about all started tasks with a job name of AOR2 and identifiers that start with T1, enter:

```
D A,AOR2.T1*
```

Example 14:

To display detailed information about all started tasks with job names that start with AOR and identifiers that start with T1, enter:

```
D A,AOR*.T1*
```

Example 15:

To display detailed information about all started tasks with identifiers that start with T1, enter:

```
D A,*.T1*
```

Displaying started task status

The displayed output for a display command depends on whether the started task source JCL is a JOB or a cataloged procedure and whether you use the JOBNAME parameter on the START command.

- **JOBNAME parameter.** This parameter on the START command names the started task. (See “Starting a system task from a console” on page 882 for additional information.)
- **Membername.** If you do not use the JOBNAME parameter on the START command and the source JCL is a procedure, the system automatically assigns the member name as the jobname.
- **Jobname within the source JCL.** If you do not use the JOBNAME parameter on the START command and the source JCL for the started task is a job, a job name is assigned based on the job name on the JOB statement.
- **Identifier.** If you use the identifier on the START command, you can identify the started task by both the identifier and the jobname that was assigned by the system.

If you issue a DISPLAY A,ALL command, the system will display status about all started tasks. In the following examples, the source JCL is provided and examples of the changes in the output are provided.

The following illustration has been slightly modified to improve the readability and the column identifiers have been added as pointers; the actual display output will not appear as in the illustration that follows. For message details, refer to *z/OS MVS System Messages, Vol 7 (IEB-IEE)*.

```
SYS1 D A,WTOR
SYS1 IEE115I 16.33.03 1996.308 ACTIVITY 048
  JOBS      M/S      TS USERS      SYSAS      INITS
00000      00006      00001      00016      00002
jobname    identifier  stepname
WTOR       WTOR      ONLYSTEP   OWT  S   A=0019
```

Figure 23. Display output illustration (column descriptions)

In the illustration:

- WTOR is the *jobname*
- WTOR is also the *identifier*
- ONLYSTEP is the *stepname*
- SYSAS is the number of system address spaces

Output (when the member contains a procedure)

The following examples indicate what the different commands will generate in displayed output when the started task source JCL is a procedure (SYS1.PROCLIB member named WTOR) as follows:

```
//ONLYSTEP EXEC PGM=WTOR,PARM='HELLO'
```

For the example START WTOR where only the *membername* was specified (neither *JOBNAME* nor *identifier* were specified), only the *membername* appears in the

More on the DISPLAY A command

output.

```
SYS1 D A,WTOR
SYS1 IEE115I 16.33.03 1996.308 ACTIVITY 048
JOBS M/S TS USERS SYSAS INITS
00000 00006 00001 00016 00002
WTOR WTOR ONLYSTEP OWT S A=0019
```

Figure 24. Display Output from D A,WTOR (Membername)

For the example START WTOR.IDENTIFY (*membername* and *identifier* were specified), the *membername* and *identifier* appear in the output.

```
SYS1 D A,WTOR
SYS1 IEE115I 16.34.57 1996.308 ACTIVITY 083
JOBS M/S TS USERS SYSAS INITS
00000 00006 00001 00016 00002
WTOR IDENTIFY ONLYSTEP OWT S A=0019
```

Figure 25. Display Output for D A,WTOR (Membername and Identifier)

For the example START WTOR,JOBNAME=WTORNAME (*membername* and JOBNAME were specified), only the job name appears in the output.

```
SYS1 D A,WTORNAME
SYS1 IEE115I 16.36.46 1996.308 ACTIVITY 118
JOBS M/S TS USERS SYSAS INITS
00000 00006 00001 00016 00002
WTORNAME WTORNAME ONLYSTEP OWT S A=0019
```

Figure 26. Display Output for D A,WTOR (Membername and JOBNAME)

Output (when the member contains a job)

The following examples indicate how the different displayed output appears for a started task (SYS1.STCJOBS member named SYM1) with source JCL of a JOB, given three different START commands. The source JCL of SYM1:

```
//SYMTEST JOB 'accounting_info',MSGLEVEL=(1,1)
//STEP1 EXEC PGM=WTOR,PARM='HELLO',TIME=1
```

For the example START SYM1, where only the *membername* is specified (neither *JOBNAME* nor *identifier* was specified), only the job name (provided in the member) appears in the output.

```
SYS1 D A,SYMTEST
SYS1 IEE115I 16.20.14 1996.308 ACTIVITY 811
JOBS M/S TS USERS SYSAS INITS
00000 00006 00001 00016 00002
SYMTEST SYMTEST STEP1 OWT S A=0019
```

Figure 27. Display Output from D A,SYM1

For the example START SYM1.IDENTIFY (*membername* and *identifier* were specified), both the job name (in the member) and the *identifier* (specified in the command) appear in the output.

```

SYS1  D A,SYMTEST
SYS1  IEE115I 16.22.24 1996.308 ACTIVITY 832
JOBS   M/S   TS USERS   SYSAS   INITS
00000  00006  00001   00016   00002
SYMTEST IDENTIFY STEP1  OWT S   A=001A

```

Figure 28. Display Output from D A,SYMTEST

For the example START SYM1,JOBNAME=SYMBOLS (*membername* and *JOBNAME* were specified), only the job name specified in the command appears in the output.

```

SYS1  D A,SYMBOLS
SYS1  IEE115I 16.23.41 1996.308 ACTIVITY 856
JOBS   M/S   TS USERS   SYSAS   INITS
00000  00006  00001   00016   00002
SYMBOLS SYMBOLS STEP1  OWT S   A=001A

```

Figure 29. Display Output from D A,SYMBOLS

Displaying library lookaside information

Use the DISPLAY LLA command to display information about library lookaside, and to display a list of all the libraries that LLA is managing.

The syntax of this command is:

```

D LLA
D LLA[,L={a|name|name-a}]

```

L=a, name, or name-a

Specifies the display area (*a*), console name (*name*), or both (*name-a*) where the display is to appear.

If you omit this operand, the display is presented in the first available display area or the message area of the console through which you enter the command.

Example:

If you enter a D LLA command the format of the output is:

```

CSV600I 12.38.09 LLA DISPLAY 529
EXITS: CSVLLIX1 - INACTIVE  CSVLLIX2 - ON
VLF: ACTIVE GET LIB ENQ: YES  SEARCH FAIL COUNT: 0
LNKLST SET: IPL
12 LIBRARY ENTRIES FOLLOW
ENTRY  L F R P  LIBRARY NAME
  1    L      SYS1.CSSLIB
  2    L      SYS1.MIGLIB
  3    L      TCP/IP.SEZALOAD
  4    L      SYS1.VTAMLIB
  5    L      SYS1.CMDLIB
  6    L      IMSVS.TEST.PGMLIB
  7    L      SYS1.MIGLIB
  8    L      SYS1.LINKLIB
  9    L      TCP/IP.SEZSLNK2
 10    L      SYS1.SORTLPA
 11    L F     SYS1.JOBLIB
 12    L      SYS1.SCBDHENU

```

DISPLAY LLA command

The following describes some of the CSV600I output fields. For a complete description of all of the output fields, see message CSV600I.

ENTRY

The entry number of the library being displayed. This does not relate to the order in which the libraries were specified or are processed.

L or LNKLST

The LNKLST status of the library being displayed. L is one of the following:

L The library is in the current LNKLST.

A The library is in an active, not current, LNKLST.

(blank)

The library is not in the LNKLST.

F or FREEZE

The FREEZE state of the library being displayed. F is one of the following:

F The library is in freeze state.

(blank)

The library is not in freeze state.

R or REMOVE

The REMOVE status of the library being displayed. R is one of the following:

R The library was requested to be removed.

(blank)

The library was not requested to be removed.

P or PDSE

The indicator of whether or not the library is a partitioned data set extended, or PDSE. P is one of the following:

P The library is a PDSE.

(blank)

The library is not a PDSE.

Displaying the system logger and its log streams

You can use the DISPLAY LOGGER command to display the status of the system logger, individual log streams, or one or all log streams from a sysplex view.

Note: You can use the asterisk as a wildcard character with the DISPLAY LOGGER command; specify an asterisk (*) as the search argument or specify an asterisk as the last character of a larger search argument. If used, the wildcard must be the last character in the search argument, or the only character.

The IXG601I message output contains the results of the DISPLAY LOGGER command.

Restrictions

- Do not use the same parameter twice within a single command.
- Do not exceed a command line length of 128 characters.

Syntax

```

D  LOGGER[, {STATUS|ST} [, {RECALLS|REC} ]
                                [, {ZAI} [, VERIFY]] ]
                                [, IXGCNF [, {ZAI|MONITOR|MON|MANAGE} ]
                                [, {CONNECTION|CONN|C} [, LSNAME|LSN=logstreamname] ]
                                [, JOBNAME|JOB|J=mvsjobname]
                                [, {SUMM|S } ]
                                {DETAIL|D}
                                [, {SYSPLEX}, {LSNAME = lsnname}]
                                [, DASDONLY ]
                                [, ZAI ]

                                [, {LOGSTREAM|L} [, LSNAME=logstreamname ] ]
                                [, STRNAME|STRN=structurename]
                                [, DASDONLY ]
                                [, ZAI ]
                                [, {SUMM|S } ]

                                [, {STRUCTURE|STR} [, STRNAME|STRN=structurename] ]
                                [, {SUMM|S } ]

                                [, L={a|name|name-a} ]

```

The parameters are:

STATUS or ST

Display the current operational status of the system logger. STATUS is the default if you specify no parameters.

RECALLS or REC

This filter requests a display of all the outstanding asynchronous recall requests that system logger has made to DFSMSHsm using the ARCHRCAL service.

ZAI

This filter requests a display of all the z/OS Advanced Workload Analysis Reporter (IBM zAware) log stream client settings and state information pertaining to any socket connections to the IBM zAware server, that is:

ACTIVE

There is at least one z/OS IBM zAware log stream client in communication with the IBM zAware server.

AVAILABLE

System logger is available to communicate with the IBM zAware server, but there are currently no z/OS IBM zAware log stream clients established.

NOT AVAILABLE

There is an inhibitor to system logger establishing a z/OS IBM zAware log stream client. Ensure there is a system logger IXGCNF parameter specification for the ZAI SERVER. For error conditions, message IXG371E might be issued and contains additional details. The DISPLAY OMVS commands is useful to determine whether OMVS is available and/or whether system logger is associated as a z/OS UNIX System Services address space.

QUIESCED

System logger has or was requested to quiesce any activity for z/OS

DISPLAY LOGGER command

IBM zAware log stream clients. Look for messages IXG371E, IXG376E or IXG382I for additional details on what might have led to the quiesced state. For this quiesced state, log streams will not be allowed to connect to the IBM zAware server until the appropriate SETLOGR FORCE,ZAICONNECT command is issued.

To obtain more details on any particular log stream, refer to the Display LOGGER,Connection,ZAI and Display LOGGER,Logstream,ZAI commands.

VERIFY

Requests that system logger verify that the IBM zAware server can be accessed for one or more potential z/OS IBM zAware log stream clients. The ZAI SERVER and PORT parameter information will be used to attempt communication with the IBM zAware server. The general system logger status, z/OS IBM zAware client state, and ZAI statement parameter options (for example: IXGCNF) will be provided along with an indication of the verify z/OS IBM zAware communication request being initiated or failed.

ZAI VERIFY INITIATED, CHECK FOR MESSAGES IXG37X, IXG38X

or

ZAI VERIFY FAILED

When the verify request is initiated, look for logger messages in the range IXG37x-IXG38x with the text "DISPLAY ZAI,VERIFY" included for the verify results.

IXGCNF

Display the system logger initialization and processing options. This default filter requests a display of all the merged system logger parameter options obtained during:

- System logger (IXGLOGR) initialization processing.
- SET IXGCNF command processing.
- SETLOGR command processing.

ZAI

Requests a display of all the system logger ZAI statement parameter options.

MONITOR or MON

Requests a display of all the system logger MONITOR statement parameter options.

MANAGE

Requests a display of all the system logger MANAGE statement parameter options.

CONNECTION or CONN or C

Display all log streams with one or more connections to the system(s) from which you issued the command.

You can use the following filters to limit or change the information displayed. (Note that if you use the SYSPLEX filter, the view of the output is changed to the systems or resources that are connected to the log stream, a sysplex view.)

LSNAME or LSN = *logstreamname*

This filter requests a display of all actively connected log streams that match the specified log stream name.

JOBNAME or JOB or J = mvsjobname

This filter requests a display of all log streams with one or more connections to the specified jobname.

SUMM or S, or DETAIL or D

These two mutually exclusive parameters are valid only when preceded by the specification of the LSName parameter or the Jobname parameter (or both) as part of the **CONNECTION** display. **SUMM** (summary), the default, displays a condensed overview of the requested information. **DETAIL** produces a more detailed report.

SYSPLEX

This filter requests to change the view of the output for the display logger command **CONNECTION** option from a system view to a sysplex view. If you use the LSName | LSN filter to narrow the information to search for and display, the system displays information about systems and resources connected to the log stream. Otherwise, the display will show all log streams with one or more connections on the sysplex.

DASDONLY

This filter requests a display of all log streams with a **DASDONLY** configuration.

ZAI

This filter requests a display of all log streams that match other filters that have a **ZAI(YES)** specification.

LOGSTREAM or L

Display log stream sysplex information.

LSNAME or LSN = logstreamname

This filter requests a display of all defined log streams that match the specified log stream name.

STRNAME or STRN = structurename

This filter requests a display of all log streams on the sysplex that are defined to a structure that matches the specified structure name.

DASDONLY

This filter requests a display of all log streams that match other filters that have a **DASDONLY** configuration.

ZAI

This filter requests a display of all log streams that match other filters that have a **ZAI(YES)** specification.

SUMM or S

When this (summary) filter is specified, logger displays only the summary count information for the number of log streams that meet the requested information. When the summary filter is specified along with an intent to reveal all the log streams, for example with **DISPLAYLOGGER,LOGSTREAM,SUMM** or the **DISPLAYLOGGER,LOGSTREAM,LSN=*,SUMM** command, then only the logstream defined and formatted counts are displayed along with the **DSEXTENT** record format and in use counts.

STRUCTURE or STR

Sort by structure name and display all log streams defined to any structure on a sysplex.

DISPLAY LOGGER command

STRNAME or **STRN** = *structurename*

This filter requests a sort by structure and display of all log streams on the sysplex defined to the specified structure name.

SUMM or **S**

When this (summary) filter is specified, logger displays only the summary count information for the number of logger structures that meet the requested information. When the summary filter is specified along with an intent to reveal all the logger structures, for example with the DISPLAY LOGGER,STRUCTURE,SUMM command, then only the counts are displayed.

L=a, name, or name-a

Specifies the display area (*a*), console name (*name*), or both (*name-a*) where the display is to appear.

If you omit this operand, the display is presented in the first available display area or the message area of the console through which you enter the command.

Examples

Example 1:

Display the current operational status of the System Logger.

```
DISPLAY LOGGER,STATUS
```

Example 2:

Display all log streams with one or more connections for the system that match the log stream name starting with the letters *logstr*.

```
DISPLAY LOGGER,CONN,LSN=logstr*
```

Example 3:

Display all log streams with at least one active connection in the sysplex that matches the log stream name starting with the letters *logstr*.

```
DISPLAY LOGGER,CONN,SYSPLEX,LSN=logstr*
```

Example 4:

Display all defined log streams for the sysplex that match the log stream name of *loga* and structure names that start with *list*.

```
DISPLAY LOGGER,L,LSN=loga,STRN=list*
```

Example 5:

Display all defined log streams for the sysplex that start with *logstr* and have a DASD only configuration.

```
DISPLAY LOGGER,L,LSN=logstr*,DASDONLY
```

Example 6:

Display all defined log streams for the sysplex and sort by structure name starting with the letters *list*.

```
DISPLAY LOGGER,STR,STRN=list*
```

Example 7:

DISPLAY LOGGER command

The following command displays details of all the log streams on the system with connections to the specified job name:

```
DISPLAY LOGGER,CONN,JOBNAME,DETAIL
```

The IXG601I message output is displayed as follows:

```
CONNECTION INFORMATION BY LOGSTREAM FOR SYSTEM SY1
LOGSTREAM          STRUCTURE      #CONN    STATUS
-----          -
NICKJ.TEST.LOGSTREAM  LIST01      00002    DISCONNECT PENDING
  DUPLEXING: STAGING DATA SET
    STGDSN: IXGLOGR.NICKJ.TEST.LOGSTREAM.PLEX1
    VOLUME=ALL001  SIZE=0040000    % IN-USE=30
  GROUP: PRODUCTION
  DISCONNECT PENDING FOR 0003 MINUTES
  FORCE DISCONNECT IN PROGRESS
  JOBNAME: LOGTEST1 ASID: LOGTAS1
  R/W CONN: 0003
  RES MGR./CONNECTED: no
  IMPORT CONNECT: no
  JOBNAME: LOGTEST2 ASID: LOGTAS2
  R/W CONN: 0003
  RES MGR./CONNECTED: no
  IMPORT CONNECT: no

NUMBER OF LOGSTREAMS: 000001
```

Example 8:

The following command displays inventory information by log stream for either the sysplex (DISPLAY LOGGER,CONN,SYSPLEX) or system (DISPLAY LOGGER,L):

```
DISPLAY LOGGER,CONN,SYSPLEX
DISPLAY LOGGER,L
```

The IXG601I message output is displayed as follows:

```
INVENTORY INFORMATION BY LOGSTREAM
LOGSTREAM          STRUCTURE      #CONN    STATUS
-----          -
NICKJ.TEST.LOGSTREAM1  LIST01      00000    AVAILABLE
NICKJ.TEST.LOGSTREAM2  LIST02      00003    IN USE
  SYSNAME: SY1
  DUPLEXING: LOCAL BUFFERS
  SYSNAME: SY2
  DUPLEXING: STAGING DATA SET
  SYSNAME: SY3
  DUPLEXING: LOCAL BUFFERS
  GROUP: PRODUCTION
NICKJ.TEST.LOGSTREAM3  LIST03      00001    IN USE
  SYSNAME: SY2
  DUPLEXING: LOCAL BUFFERS
  GROUP: TEST

NUMBER OF LOGSTREAMS: 000003
```

Example 9:

The following command displays the status of the system logger:

```
DISPLAY LOGGER,ST
```

If some resources and services are not available, the IXG601I message output is displayed as follows:

DISPLAY LOGGER command

```
SYSTEM LOGGER STATUS
SYSTEM  SYSTEM LOGGER STATUS
-----  -----
SY1     ACTIVE
        LOGR CDS IS NOT AVAILABLE
        LOGGER SERVICES DISABLED FOR GROUP:  TEST
```

Example 10:

The following command displays the log streams defined to any structure in the sysplex:

```
DISPLAY LOGGER,STR
```

The IXG601I message output is displayed as follows:

```
INVENTORY INFORMATION BY STRUCTURE
STRUCTURE          GROUP          CONNECTED
-----          -
LIST01             TEST
  OA08553.LOG.STREAM          NO
LIST02
  *NO LOGSTREAMS DEFINED*      N/A
LONG_STRUCT_NAME    PRODUCTION
NICKJ.TEST.LOG.STREAM          NO
NICKJ.TEST.LOG.STREAM2         YES
```

```
NUMBER OF STRUCTURES: 3
```

Example 11:

When interested in obtaining just the total number of logger structures that are currently defined, as well as the total number of LSTRR records formatted in the LOGR Couple Data Set, use the following command.

```
DISPLAY LOGGER,STR,SUMM
```

The IXG601I message output is displayed as follows:

```
INVENTORY INFORMATION BY STRUCTURE
NUMBER OF STRUCTURES: 000002
FORMATTED LSTRR #: 000025
```

Example 12:

The following command displays the status of system logger and requests any outstanding data set recalls be listed (from the oldest to the most recent):

```
DISPLAY LOGGER,ST,REC
```

The IXG601I message output is displayed as follows when there are outstanding recall requests:

```
SYSTEM LOGGER STATUS
SYSTEM  SYSTEM LOGGER STATUS
-----  -----
SY1     ACTIVE
        LOGGER DATA SET RECALLS
        GROUP:  PRODUCTION
          SECONDS  DATA SET NAME
          00000038  IXGLOGR.TEST102.STREAM01.A0000000
          00000173  IXGLOGR.TEST102.STREAM02.A0000003
        GROUP:  TEST
```

DISPLAY LOGGER command

```
SECONDS    DATA SET NAME
00000014   IXGLOGR.TEST103.STREAM04.A0000002
00000014   IXGLOGR.TEST103.STREAM03.PLEX1
```

The IXG601I message output is displayed as follows when there are no outstanding recall requests:

```
SYSTEM LOGGER STATUS
SYSTEM     SYSTEM LOGGER STATUS
-----
SY1       ACTIVE
          LOGGER DATA SET RECALLS
          GROUP: PRODUCTION
          NO DATA SET RECALLS WAITING
          GROUP: TEST
          NO DATA SET RECALLS WAITING
```

The IXG601I message output is displayed as follows when there are outstanding recall requests but the TEST group services have been disabled:

```
SYSTEM LOGGER STATUS
SYSTEM     SYSTEM LOGGER STATUS
-----
SY1       ACTIVE
          LOGGER SERVICES DISABLED FOR GROUP: TEST

          LOGGER DATA SET RECALLS
          GROUP: PRODUCTION
          SECONDS    DATA SET NAME
          00000088   IXGLOGR.TEST102.STREAM01.A0000000
          00000223   IXGLOGR.TEST102.STREAM02.A0000003
          GROUP: TEST
          LOGGER NO LONGER RECALLING DATA SETS ASYNCHRONOUSLY
```

Example 13:

The following command displays the status of system logger and the z/OS IBM zAware log stream client related settings, and z/OS IBM zAware client state information, when ZAI SERVER is specified in IXGCNFFNN parmlib.

```
DISPLAY LOGGER,STATUS,ZAI
```

The IXG601I and IXG607I messages sample output would be displayed as follows:

```
SYSTEM LOGGER STATUS
SYSTEM     SYSTEM LOGGER STATUS
-----
SY1       ACTIVE

ZAI LOGSTREAM CLIENTS: AVAILABLE [ | ACTIVE | NOT AVAILABLE
 | QUIESCED]
BUFFERS IN USE: 00 GB 0000 MB

LOGGER PARAMETER OPTIONS
KEYWORD    SOURCE  VALUE
-----
ZAI
SERVER     HOST    IPL (NN)  HOST.ZAWARE.SERVER.LOCATION
PORT      DEFAULT 2001
LOGBUFMAX  DEFAULT 02
LOGBUFWARN  DEFAULT 75
LOGBUFFULL  DEFAULT MSG
```

Example 14:

DISPLAY LOGGER command

Display all log streams defined in the LOGR Couple Data Set and if the log stream is in use, indicate when ZAI(YES) is specified for the log stream.

```
DISPLAY LOGGER,L

IXG601I 08.45.59  LOGGER DISPLAY 671
INVENTORY INFORMATION BY LOGSTREAM
LOGSTREAM          STRUCTURE          #CONN  STATUS
-----          -
COPYLOG.SOURCE    *DASDONLY*          000001  IN USE
  SYSNAME: SY1
  DUPLEXING: STAGING DATA SET
  GROUP: PRODUCTION  ZAI CLIENT: YES
ZOBES.STRLOG.STRM130  LIST01          000000  AVAILABLE

NUMBER OF LOGSTREAMS: 000002
```

Example 15:

When interested in obtaining just the total number of log streams currently defined as well as the total number of LSR records formatted in the LOGR Couple Data Set, use either of the following commands. The number of logger data set extent records (DSEXTENT) requested for formatting in the primary LOGR couple data set and the number of these records that are assigned to log streams for offload data set management are also revealed.

```
DISPLAY LOGGER,L,SUMM
DISPLAY LOGGER,L,LSN=*,SUMM
```

The IXG601I message output is displayed as follows:

```
INVENTORY INFORMATION BY LOGSTREAM

NUMBER OF LOGSTREAMS: 000006
  FORMATTED LSR #: 000025

DSEXTENT RECORDS FORMATTED #: 000015 / INUSE #: 000001
```

Example 16:

Display all log streams with one or more connections for the command target system and indicate when ZAI(YES) is specified for the log stream.

If system logger has established a socket connection to the IBM zAware server for the log stream, then the line with '...ZAI CLIENT: YES - CONNECTED' will be included in the message.

In the case of:

```
'LOG BLOCKS SENT TO SERVER OK: blkok, FAILED: blkfailed'
```

the following will be provided in the message text:

blkok

Number of log blocks sent to the IBM zAware server successfully during this connection.

blkfailed

The number of log blocks that were attempted to be sent over the socket to the IBM zAware server, but eventually failed to be sent. System logger moves on to the next buffered log block for the log stream to send to the IBM zAware server.

Also included in message output is information about the log stream current offload data set(s). The current offload data set sequence number that is allocated and open on the system is identified as A0000007. There is no advanced-current offload data set open, as indicated by the '-NONE-' text.

```
D LOGGER,C,LSN=*,D

IXG601I 08.47.06  LOGGER DISPLAY 674
CONNECTION INFORMATION BY LOGSTREAM FOR SYSTEM SY1
LOGSTREAM          STRUCTURE          #CONN  STATUS
-----
SYSPLEX.OPERLOG    STR_OPERLOG    000001  IN USE
  DUPLEXING: STAGING DATA SET
    STGDSN: IXGLOGR.SYSPLEX.OPERLOG.PLEX1
      VOLUME=SMSVL6  SIZE=000540 (IN 4K)  % IN-USE=001
  GROUP: PRODUCTION  ZAI CLIENT: YES - CONNECTED  [ ]  CONNECTING  |
  NOT CONNECTED  | QUIESCED]
  ZAIDATA: OPERLOG
    LOG BLOCKS SENT TO SERVER OK: blkok, FAILED: blkfailed
  OFFLOAD DSN FORMAT: IXGLOGR.SYSPLEX.OPERLOG.<SEQ#>
    CURRENT DSN OPEN: YES          SEQ#: A0000007
    ADV-CURRENT DSN OPEN: NO       SEQ#: -NONE-
  JOBNAME: CONNECTW  ASID: 001B
  R/W CONN: 000001 / 000000
  RES MGR./CONNECTED: *NONE* / NO
  IMPORT CONNECT: NO

NUMBER OF LOGSTREAMS: 000001
```

Example 17:

Display all log streams connected on the command target system that match the log stream name starting with the letters *SYSPLEX* and has *ZAI(YES)* specified.

```
DISPLAY LOGGER,CONN,LSN=SYSPLEX*,ZAI
```

Example 18:

The following command displays the status of the system logger and the z/OS IBM zAware log stream client related settings, and requests that system logger verify the IBM zAware server can be accessed for any potential z/OS IBM zAware log stream client(s).

```
DISPLAY LOGGER,STATUS,ZAI,VERIFY
```

The IXG601I IXG607I and IXG380I messages sample output are displayed as follows:

```
SYSTEM LOGGER STATUS
SYSTEM  SYSTEM LOGGER STATUS
-----  -----
SY1     ACTIVE

ZAI LOGSTREAM CLIENTS: AVAILABLE
BUFFERS IN USE: 00 GB 0000 MB
ZAI VERIFY INITIATED, CHECK FOR MESSAGES IXG37X, IXG38X

LOGGER PARAMETER OPTIONS
KEYWORD          SOURCE  VALUE
-----
ZAI
SERVER  HOST    IPL (NN)  HOST.ZAWARE.SERVER.LOCATION
PORT    DEFAULT  2001
LOGBUFMAX    DEFAULT  02
LOGBUFWARN   DEFAULT  75
LOGBUFFULL   DEFAULT  MSG
```

DISPLAY LOGGER command

```
IXG380I ZAI LOGSTREAM CLIENT ESTABLISHED
FOR DISPLAY ZAI,VERIFY
```

Example 19:

Display the system logger initialization and processing parameter options. Assume the following before the display command is issued:

1. SYS1.PARMLIB members IXGCNFNN, IXGCNFN1 and IXGCNFN2 exist and contain the following statements:
IXGCNFNN
 CTRACE(CTILOG01)
IXGCNFN1
 MONITOR OFFLOAD
 WARNALLOC(5)
 ACTIONALLOC(15)
IXGCNFN2
 MONITOR OFFLOAD
 ACTIONRECALL(26)
2. IEASYSxx member that was used during IPL contained IXGCNF=NN,
3. SET IXGCNF=(n1,n2) command was specified,
4. SETLOGR MONITOR,OFFLOAD,ACTIONALLOC(20) command was used.
5. SETLOGR ZAI,PORT(11112) command was also used.
 DISPLAY LOGGER,IXGCNF

```
SY1 IXG607I 18.00.56  LOGGER DISPLAY 395
LOGGER PARAMETER OPTIONS
KEYWORD          SOURCE  VALUE
-----
CTRACE           IPL (NN) CTILOG01
MONITOR OFFLOAD
WARNALLOC        SET (N1) 00005
ACTIONALLOC      SETLOGR 00020
WARNRECALL       DEFAULT 00060
ACTIONRECALL     SET (N2) 00026
ZAI
SERVER           DEFAULT NONE
PORT             SETLOGR 11112
LOGBUFMAX        DEFAULT 02
LOGBUFWARN       DEFAULT 75
LOGBUFFULL       DEFAULT MSG
```

Note: For the keyword CTRACE, the value (CTILOG01 here) represents the last specified CTiLOGnn member but might not reflect the current used logger CTRACE options if an error occurred trying to use the member. To view in use options, issue a D TRACE,COMP=SYSLOGR command.

Example 20:

The following command displays the system logger parameter specifications and reveals the keyword provided in parmlib IXGCNFAV put into effect via a SET IXGCNF=AV command:

```
d logger,IXGCNF
```

```
SY1 IXG607I 11.26.11  LOGGER DISPLAY 610          C
LOGGER PARAMETER OPTIONS
KEYWORD          SOURCE  VALUE
-----
CTRACE           DEFAULT CTILOG00
```

```

MONITOR OFFLOAD
WARNALLOC      DEFAULT  00030
ACTIONALLOC    DEFAULT  00060
WARNRECALL     DEFAULT  00060
ACTIONRECALL   DEFAULT  00120
MONITOR LSPRIMARY
CONSUMPTIONALERT SET (AV) SUPPRESS
ZAI
SERVER         DEFAULT  NONE
PORT           DEFAULT  2001
LOGBUFMAX      DEFAULT  02
LOGBUFWARN     DEFAULT  75
LOGBUFFULL     DEFAULT  MSG
    
```

Example 21:

The following command displays additional details on the named log stream on the system from which the command was issued. Included in the message output is the current offload data set sequence number that is allocated and open on the system and is identified as A0000008. The advanced-current offload data set that is also allocated and open on the system is identified as A0000009.

```

d logger,c,lsn=test1.mylog,detail

SY1 IXG601I 17.28.04  LOGGER DISPLAY 624
CONNECTION INFORMATION BY LOGSTREAM FOR SYSTEM SY1
LOGSTREAM          STRUCTURE          #CONN  STATUS
-----
TEST1.MYLOG        LIST01            000001  IN USE
DUPLExING: LOCAL BUFFERS
GROUP: PRODUCTION
OFFLOAD DSN FORMAT: IXGLOGR.SYSPLEX.OPERLOG.<SEQ#>
CURRENT DSN OPEN: YES      SEQ#: A0000008
ADV-CURRENT DSN OPEN: YES  SEQ#: A0000009
JOBNAME: WRITEJOB  ASID: 0023
R/W CONN: 000000 / 000001
RES MGR./CONNECTED: *NONE* / NO
IMPORT CONNECT: NO
    
```

Displaying the logrec recording medium

Use the DISPLAY LOGREC command to display the current logrec error recording medium, the environmental record recording medium, and any alternate medium, if available. The DISPLAY LOGREC command produces the following output:

- The current logrec error recording medium (either the name of a log stream, the name of a logrec data set, or IGNORE).
- The alternate recording medium, if a logrec data set has been defined.
- Both current and alternate recording medium status.

After the system processes the command, it issues message IFB090I to the console from which the command was issued or to a specified console. Refer to the description of message IFB090I, which shows the resulting display.

Restrictions

- Do not use the same keyword more than once within a single command.
- Do not exceed the maximum command line length of 124 characters.

DISPLAY LOGREC command

Syntax

D LOGREC
D LOGREC[, {CURRENT CURR} {DATASET DSN} {ALL A}] [,L={a name name-a}]

The parameters are:

CURRENT or CURR

Indicates that the system is to display the current logrec medium. CURRENT is the default. The possible current mediums are as follows:

- LOGSTREAM, which displays the log stream name and status.
- DATASET, which displays the logrec data set name and status.
- IGNORE, which indicates that there is no logrec medium.

DATASET or DSN

Indicates that the system is to display only the logrec data set name and status. If a data set name is displayed, then it is defined. The displayed data set, however, might not be the current logrec recording medium. To determine the current recording medium, use the CURRENT option. If there is no data set defined, the system displays the text NOT DEFINED.

ALL or A

Indicates that the system is to display all, both current and alternate, logrec medium and data set names and status.

L=a, name, or name-a

Specifies the display area (*a*), console name (*name*), or both (*name-a*) where the display is to appear.

If you omit this operand, the display is presented in the first available display area or the message area of the console through which you enter the command.

Example:

To display information for all the logrec medium settings:

```
DISPLAY LOGREC,ALL
```

Displaying system configuration information

Use the DISPLAY M command to display the status of sides, processors, ICRFs, channel paths, devices, storage-class memory (SCM) and central storage, or to compare the current hardware configuration to the configuration in a CONFIGxx parmlib member.

The DISPLAY M command can accept the subchannel set number to qualify the input device number. The output of message IEE097I includes the applicable subchannel set number.

When you specify a device number that might be mistaken for the device name, precede the device number with a slash. The slash is optional with a 3-digit device number.

Syntax

D M	<pre> D M[=CHP[(xx) (xx-xx) (list)] =CONFIG[(xx)] =CORE[(x) (list)] ={CPUAD CPU}[(x) (list)] =CU(xxxx) ={DEVICE DEV}[([/]devnum) ([/]lowdevnum-[/]highdevnum) (list)] ={DEVICE DEV}[([/]devnum,(chp))[,ROUTE={TODEV FROMDEV BOTH}[,HEALTH]] [,LINKINFO={FIRST LAST REFRESH COMPARE}] ={DEVICE DEV}(([/]devnum),chp)[,ROUTE={TODEV FROMDEV BOTH}[,HEALTH]] [,LINKINFO={FIRST LAST REFRESH COMPARE}] =HIGH =HSA =SCM(DETAIL) =SIDE[(id)] ={STORAGE STOR}[(dddM-dddM) (list) (E[=id])] =SWITCH(sssss [,pp[-pp] [,pp[-pp]]...]) =(parm[,parm]...) [,L={a name name-a}] </pre>
------------	---

Parameters

M The system is to display information about system configuration. When you enter DISPLAY M with no operands, the system displays the starting address and length of each portion of the hardware system area (HSA). The system also displays the status of all processors, ICRFs, central storage, channel paths, storage-class memory (SCM) and devices, depending on the type of processor or processor complex.

If the processor complex is partitioned, the system does not provide information about resources that are not part of the configuration on which you issue the command. Message IEE174I gives you the status of resources on the side from which you issue the command and tells you that information about the other side is unavailable. If you are running your processor complex in single-image mode with all resources in one side offline, message IEE174I identifies the other side as being offline but gives you the information about those resources. For example, to partition a processor complex, you configure offline the resources on one side. To verify that those resources are offline, issue the DISPLAY M=SIDE command. The display lists the side as offline and gives the status of the resources.

CHP

The system is to display the online and offline status of channel paths. If you do not specify any channel path, the system displays the status of all channel paths, as well as a status of either “managed and online” or “managed and offline” as part of the support of dynamic channel path management. For a description of the display format, see message IEE174I.

(xx)

A single channel path identified by *xx*. The channel path identifier can have a value from 0 to FF.

(xx-xx)

A range of channel path identifiers. The starting and ending channel path identifiers can have a value from 0 to FF.

DISPLAY M command

(list)

One or more single channel path identifiers, or a combination of single channel path identifiers and ranges of channel path identifiers, each separated by a comma.

CONFIG[(xx)]

The system is to display the differences between the current configuration and the configuration described in the CONFIGxx parmlib member. If you omit *xx*, the system assumes that you mean CONFIG00.

For a description of the display format, see message IEE097I.

You can also start this function from the HCD dialog. For details refer to the section "Process Display M=CONFIG(xx) Command" in *z/OS HCD User's Guide*.

CORE

The system is to display the online or offline status of one or more cores. If you do not specify any core identifiers, the system displays the online or offline status of all cores.

(x)

A single core identified by a core identifier in hexadecimal format.

(list)

One or more core identifiers, each separated by a comma.

Note: When you issue the DISPLAY M=CORE command from a PR/SM partition, the system displays the status for the logical cores and ICRFs defined to the partition.

Note: When you issue the DISPLAY M=CORE command from a system where PROCVIEW CPU is in effect, the command is rejected.

CPUAD or CPU

The system is to display the online or offline status of one or more processors and any ICRFs attached to those processors. See message IEE174I.

If you do not specify any processor identifiers, the system displays the online or offline status of all processors and any ICRFs attached to them. Whether you specify a processor identifier or not, the system displays "N" when a processor is neither online or offline, but is recognized by the machine.

Note: When you issue the DISPLAY M=CPU command from a PR/SM partition, the system displays the status for the logical processors, and ICRFs defined to the partition.

(x)

A single processor identified by processor identifier in hexadecimal format.

(list)

One or more processor identifiers, each separated by a comma.

Note: When you issue the DISPLAY M=CPU command from a PR/SM partition, the system displays the status for the logical CPUs, and ICRFs defined to the partition.

Note: When you issue the DISPLAY M=CPU command from a system where PROCVIEW CORE is in effect, the command is rejected. With LOADxx PROCVIEW CORE,CPU_OK, CPU is accepted and treated as an alias for CORE.

CU The system is to display the information for a specific control unit. For a description of the display format, see message IEE174I.

(xxxx)

The control unit number.

Note: The D M=CU command does not support displaying information for CTC control units.

DEVICE or DEV

The system is to display the number of online channel paths to devices (including special devices) or a single channel path to a single device.

For a description of the display format, see message IEE583I.

([/]devnum)

A single device number.

([/]lowdevnum-[/]highdevnum)

The lower device number *lowdevnum* and the upper device number *highdevnum* of a range of devices.

([/]devnum, (chp))

A single device number and single channel path identifier.

(([/]devnum), chp)

A single device number and single channel path identifier.

ROUTE

The ROUTE parameter displays the route through the fabric between the channel and the device.

Specify one of the following keywords on the ROUTE parameter:

TODEV

Displays the route through the fabric, starting with the channel and going to the device.

FROMDEV

Displays displays the route through the fabric, starting with the device and going to the channel.

BOTH

Displays the route through the fabric in both directions.

Routing and health information will only be determined and displayed when the channel is connected to a switch and the control unit definition for the channel path is defined in the I/O configuration with a two-byte link address.

For a description of the display format, see message IEE583I in *z/OS MVS System Messages, Vol 7 (IEB-IEE)*.

For more information about how the routing and health information can be used to diagnose a problem in the fabric, see "Diagnosing problems in a switched fabric" on page 75.

DISPLAY M command

HEALTH

Displays the health information, which includes the utilization, average delay, and error counts, for the fabric, switch, and port.

LINKINFO

The LINKINFO parameter displays link diagnostic information for a device and CHPID. Link diagnostic information consists of the optical transceiver values, error counters, and buffer credits for each port from the channel to the control unit, except inter-switch link (ISL) ports.

- For switched point-to-point configurations, information for the channel port, entry switch port, exit switch port, and control unit port is displayed.
- For point-to-point configurations, information for the channel port and control unit port is displayed.

The LINKINFO parameter may only be specified when a path is specified on the D M=DEV command.

Specify one of the following keywords on the LINKINFO parameter:

FIRST

Displays the link diagnostic information that was obtained during IPL or when the path was varied online for the first time after IPL.

LAST

Displays the link diagnostic information that was last retrieved by the system. The system retrieves new information for a path every 24 hours or when you specify LINKINFO=REFRESH.

REFRESH

Requests that the system obtain new link diagnostic information for the physical path and then displays that information. This replaces the prior information; a subsequent LINKINFO=LAST request will display this new information.

Notes:

1. A REFRESH request does not cause the entry switch port, exit switch port, and control unit port to retrieve new optical transceiver information; it simply causes the last retrieved values to be returned to the channel subsystem. The frequency at which a port retrieves its own optical transceiver information is manufacturer- and model-specific.
2. The system rejects a REFRESH request if the channel specified in the command is already processing the maximum number of concurrent requests. These requests could be from this system or from other systems running on the same CPC. The allowed maximum number of concurrent requests for a channel is model-dependent.

The system issues the IEE584I message in response to the FIRST, LAST, and REFRESH keywords.

COMPARE

Displays a comparison of the first and last set of link diagnostic information that was retrieved by the system. The system issues the IEE586I message in response to the COMPARE keyword.

Device numbers and ranges can be specified in any combination.

A device number consists of 3, 4, or 5 hexadecimal digits, optionally preceded by a slash (/). A channel path identifier can have a value from 0 to FF. In the 5-digit format, *sdddd*, *s* is the subchannel set identifier and *dddd* is the device number.

If a range of device numbers is found and one of the two numbers is a 5-digit number, the other number in the range must also be a 5-digit number.

HIGH

The system is to display the highest possible central storage addresses in decimal M bytes (megabytes) or when the value is greater than 16383 decimal, in hexadecimal M bytes. Each address indicates the amount of storage available at system initialization. For a description of the display format, see message IEE174I.

HSA

The system is to display the starting address and length of each portion of the hardware system area (HSA). For a description of the display format, see message IEE174I.

SCM [(DETAIL)]

Displays the online or offline status for all installed SCM increments, and usage information. If **DETAIL** is specified, details for each online increment are displayed; otherwise, summary information is displayed for ranges of SCM.

For a complete description of the display format of DISPLAY M=SCM, refer to message IEE174I.

SIDE[(*id*)]

The system is to display the resources installed in side (physical partition) *id*, whether the resources are online or offline, and whether the side is online, offline, or unavailable. If the processor complex is partitioned and the specified side is part of another configuration, no information is provided. If the processor complex is running in single-image mode and you do not specify an *id*, the system displays both sides. If the command is issued from MVS running in a partition, no information is provided.

For a complete description of the display format of DISPLAY M=SIDE, see message IEE174I.

STORAGE or STOR

The system is to display the status of central storage. The display includes storage offline, storage waiting to go offline, and reconfigurable storage sections. For storage waiting to go offline, the system displays:

- The address space identifier (ASID)
- The jobname of the current user of the storage
- The amount of unassigned storage in offline storage elements
- The amount of storage that belongs to another configuration

STORAGE also indicates if a given range of central storage contains data that is shared through the use of the IARVSERV macro.

In this display, storage offline does not include the hardware save area (HSA). To find the location and length of the HSA, enter DISPLAY M=HSA.

DISPLAY M command

If you do not specify (*ddddX-ddddX*), (*list*), or (E[=*id*]), the system displays the status of all central storage. For a description of the display format, see message IEE174I.

(*ddddX-ddddX*)

The starting and ending addresses of a range in central storage for which you want the status display. Specify up to five decimal digits followed by a multiplier (M-megabytes, G-gigabytes, T-terabytes, P-petabytes) for each address. The starting and ending addresses (*ddddX*) must each be on a valid storage boundary and cannot exceed 16383P. The starting and ending addresses must not be the same.

Instead of specifying the range using decimal numbers, you can specify it in hexadecimal, with or without a multiplier, in the format X'xxxxxx'-X'xxxxxx'. For example:

- X'123456789A00000'-X'123456789B00000'
- X'123'M-X'124'M

You can use underscores in any hexadecimal specification for better clarity. Underscores in the specification are ignored during processing.

(*list*)

One or more address ranges (in decimal), each separated by a comma.

(E[=*id*])

The system is to display the status of the requested storage element. The display includes the amount of storage (in megabytes) the system owns in each online storage element, the amount of storage available to be configured online, whether the storage element is online or offline. If you omit the *id*, the system displays this information for all installed storage elements.

Note: If the processor complex is partitioned and the specified storage element is part of another configuration, no information is provided.

SWITCH(*ssss* [,*pp*[-*pp*] [,*pp*[-*pp*]]...])

The system is to display the status of a specific switch, switch port, or list of switch ports.

For a description of the display format, see message IEE174I.

ssss

The device number of the switch device.

[,*pp*[-*pp*] [,*pp*[-*pp*]]...]

The port address or port address list.

(*parm*[,*parm*]...)

The system is to display the status of each resource you specify as *parm*. The list of *parms* you specify within the parentheses may contain any combination of CHP, CPU, DEV, HIGH, HSA, STOR(E[=*id*]), and STOR. You must separate the resources in the list with commas and you must enclose the list in parentheses. Do not use blanks within the parentheses and do not specify CONFIG in the list.

L=*a*, *name*, or *name-a*

Specifies the display area (*a*), console name (*name*), or both (*name-a*) where the display is to appear.

If you omit this operand, the display is presented in the first available display area or the message area of the console through which you enter the command.

Examples

Example 1:

To display the online or offline status of all devices on channel path 01, enter:

D M=CHP(01)

Example 2:

To display the following information:

- The online or offline status of all processors
- The number of online channel paths to each device
- The highest central storage address available
- The status of central storage

enter the following command:

D M=(CPU,DEV,HIGH,STOR)

Example 3:

To display the number of megabytes of storage the system owns in storage element 0 and the status of the storage element, enter:

D M=STOR(E=0)

Example 4:

To display the number of megabytes of storage the system owns in each storage element and the status of each element, enter:

D M=STOR(E)

Example 5:

To display the status of all processors, the status for channel paths 1, 3, 4, 5, and the high storage addresses for central storage, enter:

```
D M=CPU
D M=CHP(01,03-05)
D M=HIGH
      or
D M=(CPU,CHP(01,03-05),HIGH)
```

Example 6:

The following example displays the status of cores. In this example, the configuration supports MT Mode=2 (MT=2) where standard CP cores 0 and 1 are exploiting MT Mode=1 (CP=1) and zIIP cores 2 and 3 are exploiting MT Mode=2 (zIIP=2).

```
D M=CORE
CORE STATUS: HD=Y MT=2 MODE: CP=1 zIIP=2
ID ST ID RANGE VP ISCM CPU THREAD STATUS
```

|
|
|
|
|
|
|
|

DISPLAY M command

```
| 0000 + 0000-0001 H FC00 +N  
| 0001 + 0002-0003 H FC00 +N  
| 0002 +I 0004-0005 H 0200 ++  
| 0003 +I 0006-0007 H 0200 ++
```

It is possible for a core status to be mixed (/). A core status of mixed means that a core's CPU thread status is unexpected given the MT Mode for cores of that type. In the following example, the status of core 3 is mixed, because CPU 6 is online, CPU 7 is offline, and zIIPs are exploiting MT Mode=2. With zIIPs exploiting MT Mode=2, the system expects core 3 to have both threads (CPUs 6 and 7) online. If a core appears with a mixed mode, it is generally due to an internal system error and should be configured to the desired online or offline state.

```
| D M=CORE  
| CORE STATUS: HD=Y MT=2 MODE: CP=1 zIIP=2  
| ID ST ID RANGE VP ISCM CPU THREAD STATUS  
| 0000 + 0000-0001 H FC00 +N  
| 0001 + 0002-0003 H FC00 +N  
| 0002 +I 0004-0005 H 0200 ++  
| 0003 /I 0006-0007 H 0200 +-
```

Displaying message flood automation information

Use the DISPLAY MSGFLD command to display the following information about message flood automation:

- The enablement status of the message flood automation.
- The intensive mode states for all three message types: REGULAR, ACTION, and SPECIFIC.
- The values of parameters for all three message types or a specified message type.
- The default actions to be taken for all three message types or a specified message type.
- The message rate information.

The complete syntax for the DISPLAY MSGFLD command is:

```
D {MSGFLD|MF} [,STATUS]  
    [,MODE]  
    [,DEFAULTS]  
    [,JOBS]  
    [,MSGs]  
    [,PARAMETERS]  
    [,MSGTYPE=msgtype,keyword]  
    [,MSGRATE[,n] [,m]]  
    [,L={a|name|name=a}]
```

STATUS

Displays the current enablement status of message flood automation and the active MSGFLDxx parmlib member.

If you enter only the DISPLAY MSGFLD command, the default you get is STATUS.

MODE

Displays the current intensive mode states for all three message types.

DEFAULTS

Displays the default actions to be taken for all three message types. The default actions are specified on the DEFAULT statements of the active MSGFLDxx parmlib member.

JOBS

Displays the default actions to be taken for all the jobs that have been defined on the JOB statements of the active MSGFLDxx parmlib member.

MSGs

Displays the default actions to be taken for all the messages that have been defined on the MSG statements of the active MSGFLDxx parmlib member.

PARAMETERS

Displays the current values of the parameters for all three message types.

MSGTYPE=msgtype, keyword

Displays the parameter associated with the specified message type.

msgtype specification can be: REGULAR, ACTION, and SPECIFIC.

keyword specification can be: MSGTHRESH, JOBTHRESH, INTVLTIME, SYSIMTIME, JOBIMTIME, MSGLIMIT, and MSGIMTIME.

The valid combinations of *msgtype* and *keyword* are:

MSGTYPE=REGULAR	MSGTYPE=ACTION	MSGTYPE=SPECIFIC
INTVLTIME	INTVLTIME	INTVLTIME
JOBIMTIME	JOBIMTIME	
JOBTHRESH	JOBTHRESH	
		MSGIMTIME
		MSGLIMIT
MSGTHRESH	MSGTHRESH	MSGTHRESH
SYSIMTIME	SYSIMTIME	SYSIMTIME

MSGRATE[,n][,m]

Display message rate information collected by the message rate monitoring function.

n is an optional graph length parameter in lines. The default is 25 lines. Note that the command processor adjusts this value to obtain the best scaling. The smallest supported graph has a length of 8 lines; the largest supported graph has a length of 200 lines. Standard graph sizes are: 8, 10, 16, 20, 25, 32, 40, 50, 80, 100, and 200 lines.

m is percent of the graph to display in order to fill the number of lines specified by the *n* parameter. The *n* parameter must be specified if the *m* parameter is specified. An *m* value of 5 displays the top 5% of the graph, or the values from 95% to 100%. The default is 100 which displays 100% of the graph.

L=a, name, or name-a

Specifies the display area (*a*), console name (*name*), or both (*name-a*) where the display is to appear.

If you omit this operand, the display is presented in the first available display area or the message area of the console through which you enter the command.

Displaying MVS message service status and languages

Use the DISPLAY MMS command to request a display of the current status of the MVS message service (MMS) and a display of the languages that are currently available.

The complete syntax for the DISPLAY MMS command is:

D MMS
D MMS [,L={a name name-a}]

MMS

Displays the status of the MVS message service and the list of the languages that are currently available.

L=*a*, *name*, or *name-a*

Specifies the display area (*a*), console name (*name*), or both (*name-a*) where the display is to appear.

If you omit this operand, the display is presented in the first available display area or the message area of the console through which you enter the command.

Example:

To display the status of the MVS message service and the current languages, enter:

```
D MMS
```

The status display is in the following format:

```
CNLS026I 13.25.02 MMS DISPLAY
PARMLIB MEMBER = MMSLSTE2
LAST REFRESH WAS AT 10:21 on 04/24/89
CODE  CONFIG  OBJECT
ENU   CNLENU01 SYS1.MSG.ENG
JPN   CNLJPN02 SYS1.MSG.JAPAN
DEU   CNLDEU01 SYS1.MSG.GERMAN
EXIT  01 -  OURMMS1
```

When the MVS message service is not active, the system issues message IEE294I.

Displaying message suppression, retention, color, intensity, and highlighting options

Use the DISPLAY MPF (message processing facility) command to display information about message processing and presentation that is contained in the MPFLSTxx parmlib member or members currently in effect.

The MPF parameter on the INIT statement in the CONSOLxx parmlib member or the SET MPF=xx command activates and deactivates an MPFLSTxx member or members.

The syntax of the DISPLAY MPF command is:

D MPF
D MPF[, {MSG M}] [,L={a name name-a}] , {COLOR C} , CMD

MPF

The system is to display information about message processing and presentation. If you do not use operands on the DISPLAY MPF command, the system displays the following information:

- Which messages are being suppressed by MPF
- Which action message are not being retained by the action message retention facility
- Which installation exits receive control for selected messages
- The status of the general WTO installation exit IEAVMXIT
- Whether this message is automated by MPF
- The MPFLSTxx member that identifies the message ID, color attribute, or command installation exit definition
- What color, intensity, and highlighting capabilities are in effect
- The status of the command installation exit routines specified in parmlib member MPFLSTxx
- The current installation options for handling foreign messages
- Whether verbose messages are to be produced or not

Refer to see a description of the output in message IEE677I.

MSG or M

The system is to display information on all messages that are defined in the current MPFLSTxx member:

- Which messages are being suppressed by MPF
- Which action messages are not being retained by the action message retention facility
- Which installation exits receive control for selected messages
- The status of the general WTO installation exit IEAVMXIT
- Whether this message is automated by MPF
- The MPFLSTxx member is automated by MPF
- The MPFLSTxx member that identifies the message ID

COLOR or C

The system is to display:

- What color, intensity, and highlighting capabilities are in effect

CMD

The system is to display:

- The status of the command installation exit routines specified in parmlib member MPFLSTxx

L=a, name, or name-a

Specifies the display area (*a*), console name (*name*), or both (*name-a*) where the display is to appear.

DISPLAY MPF command

If you omit this operand, the display is presented in the first available display area or the message area of the console through which you enter the command.

Example 1:

To display information about the message IDs and WTOR installation exits for all consoles, enter:

```
D MPF,M
```

Example 2:

To display the color, intensity, and highlighting specifications for all consoles, enter:

```
D MPF,C
```

Example 3:

To display the message processing and presentation information for all consoles on console 2, area A, enter:

```
D MPF,L=CON2-A
```

Example 4:

To display the status of the command installation exits, enter:

```
D MPF,CMD
```

Displaying status of z/OS UNIX System Services

The MVS operator can use the DISPLAY command to obtain:

- z/OS UNIX System Services status information (for example, active or terminating, shutting down or restarting).
- File system information.
- z/OS UNIX System Services process information for address spaces, including an indication of which processes are registered as permanent or blocking.
- The current setting for all statements in the BPXPRMxx member (or members) of SYS1.PARMLIB, which is used by z/OS UNIX. This includes system-wide and process limits, their high-water marks, and current usage.
- Information about multiple parmlib members.
- Information about each physical file system that is currently part of the z/OS UNIX System Services configuration.
- Routing information from the common INET (CINET) prerouter tables.
- Thread-level information for any thread that is in a byte-range lock wait.
- z/OS UNIX System Services kernel private storage below the bar (<2G) usage.

Use this command to display address space information for a user who has a process that is hung or that is waiting to become a process. You can also use the information returned from this command to determine how many address spaces a given TSO/E user ID is using, whether an address space is using too many resources, and whether a user's process is waiting for a z/OS UNIX kernel function to complete.

The syntax for the DISPLAY OMVS command is:

```

D OMVS[{,SUMMARY|S}]
      ,ACTIVATE=SERVICE
      ,{ASID|A}=ALL
      ,{ASID|A}=asid
      ,{ASID|A}=DUBW
      ,{CINET|CI}=All |TPname
      ,{FILE|F}[,{NAME|N}=filesystem][,{CAPS|C}]
      ,{,EXCEPTION|E}
      ,{,OWNER|O}=systemname
      ,{,TYPE|T}=type
      ,{,UID|U}={USER|PRIV|uid}
      ,{LIMITS|L}[,PID=ProcessId][,{RESET}]
      ,{PID}=processid[,BRL]
      ,PIPES[,ALL][,{RESET}][,{UID|U}=uid]
      ,MF[={ALL|A}]
      ,MF={PURGE|P}
      ,{PFS|P}
      ,{OPTIONS|O}
      ,{SER}
      ,{SOCKETS|SO}
      ,{STORAGE|ST}[,{RESET}]
      ,U=userid
      ,USERMOUNTS
      ,{VSERVER|V}
      ,{WAITERS|W}[,{
      ,{AGE|A}
      ,{LATCHES|L}
      ,{MESSAGES|M}
      ,{OTHER|O}
      ,{SPECIAL|S}]

```

SUMMARY or S

Displays status of z/OS UNIX processes, file systems, and servers (for example, active or terminating) and the BPXPRMxx parmlib member that is specified during initialization or specified by the SET OMVS= system command.

ASID or A=ALL

Displays process information for all z/OS UNIX System Services address spaces.

ASID or A=asid

Displays process information for the specified hexadecimal address space ID (ASID). If the specified ASID is not a z/OS UNIX System Services address space, an error message is issued.

ASID or A=DUBW

Displays process information for all address spaces waiting to be dubbed a z/OS UNIX System Services process. After message BPXP022E is issued to indicate one or more jobs are waiting for z/OS UNIX System Services availability, you can issue D OMVS,A=DUBW to display all jobs waiting to be dubbed.

U=userid

Displays process information for all processes associated with the specified TSO/E user ID. Use this operand when a user requests that a hung process be canceled. You can display all processes owned by the user and find the address space ID (ASID) of the process that needs to be canceled. Then use the CANCEL command to cancel the address space.

PID=processid

DISPLAY OMVS command

Displays thread information for the *processid* that is specified in decimal numbers. In a sysplex environment, you must issue the D OMVS,PID= command from the system on which the specified process is running. Refer to the following examples.

BRL

Displays thread-level information for any thread that is in a byte-range lock wait. You can specify this operand with the PID operand. Refer to the following examples.

PIPES

Displays summary information about the z/OS UNIX pipe usage. The default output is to list the two UIDs with the highest pipe create count. If ALL is specified, then all UIDs with a pipe create count are displayed. Use the RESET option to reset the user HIGHWATER USAGE and the HIGHWATER USER information and display the two UIDs with the highest pipe create count.

ALL

Displays all UIDs with a pipe create count.

RESET

Resets the HIGHWATER USER information and displays the two UIDs with the highest pipe create count.

UID=*uid*

Displays the current pipe usage for the high-use processes for the specified UID. At most, the top 10 high-use processes are displayed.

FILE or F

Displays a list of file systems that z/OS UNIX System Services is currently using, including the following:

- The status of each file system.
- The date and time that the file system was mounted.
- The latch number for the file system.
- The quiesce latch number for the file system, or 0 if the file system has never been quiesced by z/OS UNIX System Services.

If you are using z/OS File System (zFS) and need to determine the file system owner, see *z/OS Distributed File Service zFS Administration*. You can limit the amount of information displayed by specifying one of the following keywords:

NAME or N=filesystem

Displays information about the specified file system or file systems. You can use one wildcard character (*) in the file system specified. For example, ZOS18*.HFS or ZOS.L*.HFS. Note that specifying D OMVS,F,NAME=* results in the system displaying all file systems, which is the same output as if you specified D OMVS,F. Also, single quotes (') can be used to specify lowercase characters.

OWNER or O=systemname

Displays information for the file systems owned by the specified system name. Specifying D OMVS,F,OWNER displays all the file systems that are owned by this system.

EXCEPTION or E

Displays file systems in an exception state, such as a file system that is quiesced, unowned, or in recovery.

TYPE or T=type

Displays all file systems of the specified PFS type.

CAPS or C

Displays variable data containing lowercase letters in uppercase.

VSERVER or V

Displays process information for all processes that have been defined as servers that use the virtual file system (VFS) callable services API.

CINET or CI = ALL|tpname

Displays the Common Inet routing information for all of the active transport providers in use by the common inet prerouter. The transport providers were specified with the SUBFILESYSTYPE statements in the BPXPRMxx profile or specified with the SETOMVS command. The network routing information was specified in the appropriate data set for the transport provider. When the name (*tpname*) of an active transport provider is specified, the command displays the Common Inet routing information for that specific transport provider. The Common Inet routing information includes home routes, implicit NON-DVIPA host routes, active host routes, and active network routes with route type, route metric, and net mask information. These displayed routes participate in the CINET prerouter route selection during request routing.

OPTIONS or O

Displays the current settings of the options that

- (a) were set during initialization in the parmlib member BPXPRMxx or by a SET OMVS or SETOMVS command after initialization, and that
- (b) can be altered dynamically via a SET OMVS or SETOMVS command.

If you issue the D OMVS,O command while OMVS is shut down, the system will attempt to display the OMVS parmlib options that were last in effect when OMVS was active. However, it is possible that some option values are unavailable and the values cannot be displayed.

PFS or P = Physical File System

Displays information about each physical file system that is currently part of the z/OS UNIX System Services configuration. The physical file systems were specified in the BPXPRMxx profile, or with the SETOMVS command, or are an internal part of z/OS Unix System Services.

UID or U=USER|PRIV|uid

Displays information for the file systems that were mounted by the specified user.

Specify one of the following UID options:

USER Displays all the file systems that were mounted by the nonprivileged users.

PRIV Displays all the file systems that were mounted by the privileged users.

uid Displays all the file systems that were mounted by the user whose effective UID is *uid*. If the specified *uid* is 0, it is equivalent to PRIV.

LIMITS or L

Displays information about current z/OS UNIX System Services parmlib limits, their high-water marks, and current system usage. When the PID= keyword is specified, LIMITS displays high-water marks and current usage for an individual process.

DISPLAY OMVS command

RESET

Resets the high-water mark for a system limit to 0.

SER

Reports serialization for all in-use, shared memory mutexes (mutual exclusion locks) and condition variables. Each mutex and condition variable is identified by the shared memory ID and the location of the shared memory object. If the object is in an above-the-bar shared-memory segment, the location information indicates the address of the mutex or condition variable. If it is in a below-the-bar segment, the location information indicates the offset within the shared-memory segment. The offset is displayed, in this case, because each address space sharing a below-the-bar segment can map it at a different virtual address. For each mutex, the output shows the owner's TCB address, process ID, and ASID and the same for those waiting for access, if the system can determine that information.

For each condition variable, the output shows the same information for the waiting task of the condition variable and additionally identifies the associated mutex. User data is displayed for each owner and waiting task of a mutex or condition variable. In the case where LE is the caller of BPX1SMC, the user data represents the address of the LE DSA data area for the waiting or owning task.

ACTIVATE=SERVICE

Specifies that all the dynamically activated service items are to be displayed. Dynamically activated service consists of SMP/E installable service for the z/OS UNIX kernel and logical file system (LFS) components that was activated with the F OMVS,ACTIVATE=SERVICE command. (See "Recycling z/OS UNIX System Services (z/OS UNIX)" on page 575).

The service items are displayed in the order they were activated, with the most recent set of activated service items being displayed first. The most recent set of service items, which are shown as the highest numbered set of service items, are the highest level of service items activated for z/OS UNIX.

The display includes the following information:

- The library and volume from which each set of service was activated.
- The amount of ECSA and OMVS address space storage consumed by all dynamically activated service items. Note that the amount of storage consumed will not decrease if you deactivate service items (F OMVS,DEACTIVATE=SERVICE), because the modules containing the deactivated service items remain in storage. Refer to the following examples.

This command will not display deactivated service items.

USERMOUNTS

Displays summary information for nonprivileged user mounts.

WAITERS or W

Displays information about delays caused by the following conditions:

- Mount latch contention
- Outstanding unprocessed sysplex messages
- File system latch contention
- File latch contention
- Other reasons

You can use the information displayed to figure out which tasks are hung, and why they are waiting. Refer to the following examples.

A set of filtering options limits the information that is displayed. If a section of the display is filtered out, the display does not show the section instead of displaying NONE. You can combine options in order to display certain sections. For example, specify `D OMVS,W,xxx` where *xxx* is one more of the following options, separated by commas:

LATCHES | L

Displays only the latch activity tables, including the mount, file system, and the file latch activity tables. The cross-system messages and other waiters tables are suppressed.

MESSAGES | M

Displays only the sent and received cross-system messages table. The mount latch, file system latch, file latch and other waiters tables are suppressed. This option is valid only in a shared file system environment.

OTHER | O

Displays only the other waiters table. The mount latch, the file system latch, file latch, and cross-system messages table are suppressed.

AGE | A

Displays only the waiters that have been waiting for more than five minutes. A table is displayed if there are waiters that meet the criteria.

SPECIAL | S

Displays special files in the other waiters table that are otherwise filtered out. These are character special files, pipes and sockets. This option is allowed by itself, with the A option, or when the O option has also been specified. For example: `D OMVS,W,S` and `D OMVS W,O,S`.

MF

MF=ALL | A

Displays information about move or mount failures:

- Enter MF to display information about the last 10 or less move or mount failures.
- Enter MF=ALL or MF=A to display information about the last 50 or less move or mount failures.

The system issues message BPXO058I to display the information about mount failures. Refer to the following examples.

MF=PURGE | P

Allows you to purge the saved information about mount failures displayed in message BPXO058I.

L=*a*, *name*, or *name-a*

Specifies the display area (*a*), console name (*name*), or both (*name-a*) where the display is to appear.

If you omit this operand, the display is presented in the first available display area or the message area of the console through which you enter the command.

SOCKETS | SO

Displays the following information about each AF_UNIX socket:

- The owner's userid
- The socket name
- The name of the peer socket

DISPLAY OMVS command

STORAGE or ST

Displays storage usage information for the kernel address space used by z/OS UNIX System Services. The display includes a summary of system-wide kernel stack cell pool cell usage, a list of processes using 50 or more stack cells, and private below the bar storage usage.

PROCESSES=xx | P=xx

When the PROCESSES option is specified, *xx* displays the number of processes that will be shown in the display. If the KERNELSTACKS(ABOVE) option is specified, the default is 10. For the KERNELSTACKS(BELOW) option, all the processes are displayed if the P=xx option is not specified.

RESET

Resets the HIGHWATER usage for PRIVATE STORAGE and STACK CELLS to the current usage.

UID=*uid*

Displays the current pipe usage for the high-use processes for the specified UID. At most, the top 10 high-use processes are displayed.

Example 1: To display process information for all z/OS UNIX System Services address spaces, enter:

```
DISPLAY OMVS,A=ALL
```

z/OS UNIX System Services status information (OMVS ACTIVE) appears before the process information. See the appropriate z/OS UNIX System Services documentation for an explanation of the data filled in below the headers, such as a state of MKI.

```
BPX0070I 14.31.40 DISPLAY OMVS 018
OMVS 000E ACTIVE OMVS=(93)
USER JOBNAME ASID PID PPID STATE START CT_SECS
IBMUSER BPX0INIT 0013 1 0 MKI 11.02.40 .037
LATCHWAITPID= 0 CMD=BPXPINPR
SERVER=Init Process AF= 0 MF=65535 TYPE=FILE
MEGA MEGA 001A 16777218 1 1RI 11.18.17 .634
LATCHWAITPID= 0 CMD=OMVS
MEGA MEGA 001A 16777219 16777218 1CI 11.18.25 .634
LATCHWAITPID= 0 CMD=sh -L
```

Example 2: To display z/OS UNIX System Services process information on all z/OS UNIX System Services address spaces owned by user ID MEGA, enter:

```
DISPLAY OMVS,U=MEGA
```

z/OS UNIX System Services status information (OMVS ACTIVE) appears before the process information.

```
BPX0070I 14.34.15 DISPLAY OMVS 021
OMVS 000E ACTIVE OMVS=(93)
USER JOBNAME ASID PID PPID STATE START CT_SECS
MEGA MEGA 001A 16777218 1 1RI 11.18.17 .634
LATCHWAITPID= 0 CMD=OMVS
MEGA MEGA 001A 16777219 16777218 1CI 11.18.25 .634
LATCHWAITPID= 0 CMD=sh -L
```

Example 3: To display z/OS UNIX System Services process information for the address space with ASID equal to 001A, enter:

```
DISPLAY OMVS,ASID=1A
```

z/OS UNIX System Services status information (OMVS ACTIVE) appears before the process information.

```

BPX0070I 14.36.04 DISPLAY OMVS 024
OMVS 000E ACTIVE OMVS=(93)
USER JOBNAME ASID PID PPID STATE START CT_SECS
MEGA MEGA 001A 16777218 1 1RI 11.18.17 .634
LATCHWAITPID= 0 CMD=OMVS
MEGA MEGA 001A 16777219 16777218 1CI 11.18.25 .634
LATCHWAITPID= 0 CMD=sh -L
    
```

Example 4: To display detailed file system information on currently mounted files, enter:

DISPLAY OMVS,FILE

z/OS UNIX System Services status information appears before the file system information.

```

d omvs,f
BPX0045I 12.46.36 DISPLAY OMVS 527
OMVS 000E ACTIVE OMVS=(Y2)
TYPENAME DEVICE -----STATUS----- MODE MOUNTED LATCHES
ZFS 2 ACTIVE RDWR 05/06/2010 L=15
NAME=MY.ZFS 08.31.43 Q=15
PATH=/SY1/Z1
OWNER=SY1 AUTOMOVE=N CLIENT=N
HFS 13 ACTIVE RDWR 05/11/2010 L=27
NAME=MY.HFS 21.40.45 Q=0
PATH=/SY1/H1
UID=25
OWNER=SY1 AUTOMOVE=Y CLIENT=Y
    
```

If AUTOMOVE was specified with a system list in the SETOMVS or **chmount** command, the list of candidates to take ownership of the file system is displayed under the file system owner.

For zFS file systems, the display includes an aggregate file system name indicating membership in a data set containing multiple file systems. Aggregates provide member file systems with a common pool of disk space.

Note: File systems can have a status of NOT ACTIVE if they were mounted under a physical file system (PFS) that has terminated, such as is possible with zFS, TFS, or NFS Client. These file systems cannot be made active again without unmounting and remounting them after the PFS is restarted. If the file systems are remounted, they will appear active with a new device number.

For the nonprivileged user-mounted file systems, the display includes the effective UID of the nonprivileged user who mounted the file system.

Example 5: To display process information for all processes that have been defined as a server, enter:

DISPLAY OMVS,V

z/OS UNIX System Services status information (OMVS ACTIVE) appears before the file system information.

DISPLAY OMVS command

```
BPX0070I 14.38.46 DISPLAY OMVS 030
OMVS 000E ACTIVE OMVS=(93)
USER JOBNAME ASID PID PPID STATE START CT_SECSS
IBMUSER BPX0INIT 0013 1 0 MKI 11.02.40 .0373
LATCHWAITPID= 0 CMD=BPXPINPR
SERVER=Init Process AF= 0 MF=65535 TYPE=FILE
```

Example 6: To display all options set during initialization by the parmlib member BPXPRMxx or with the SET command, enter:

```
DISPLAY OMVS,0
```

The SYSPLEX (YES) option indicates the system is in a sysplex and is using the shared file system capability. You cannot dynamically change the SYSPLEX parameter through SETOMVS or SET OMVS. For more information, see the section on shared file systems in *z/OS UNIX System Services Planning*.

You will see output that is similar to the following one:

```
d omvs,0
BPX0043I 13.10.16 DISPLAY OMVS 066
OMVS 000D ETC/INIT WAIT OMVS=(M7)
CURRENT UNIX CONFIGURATION SETTINGS:
MAXPROCSYS = 256 MAXPROCUSER = 16
MAXFILEPROC = 256 MAXFILESIZE = NOLIMIT
MAXCPUTIME = 1000 MAXUIDS = 200
MAXPTYS = 256
MAXMMAPAREA = 256 MAXASSIZE = 209715200
MAXTHREADS = 200 MAXTHREADTASKS = 1000
MAXCORESIZE = 4194304 MAXSHAREPAGES = 4096
IPCMSGQBYTES = 2147483647 IPCMSGQNUM = 10000
IPCMSGNIDS = 500 IPCSEMNIDS = 500
IPCSEMNOPTS = 25 IPCSEMNSEMS = 1000
IPCshmPAGES = 25600 IPCshMNIDS = 500
IPCshmNSEGS = 500 IPCshmSPAGES = 262144
SUPERUSER = BPXROOT FORKCOPY = COW
STEPLIBLIST =
USERIDALIASTABLE=
SERV_LINKLIB = POSIX.DYNSERV.LOADLIB BPXLK1
SERV_LPALIB = POSIX.DYNSERV.LOADLIB BPXLK1
PRIORITYPG VALUES: NONE
PRIORITYGOAL VALUES: NONE
MAXQUEUEDSIGS = 1000 SHRLIBRGNSIZE = 67108864
SHRLIBMAXPAGES = 4096 VERSION = /
SYSCALL COUNTS = NO TTYGROUP = TTY
SYSPLEX = NO BRLM_SERVER = N/A
LIMMSG = NONE AUTOCVT = OFF
RESOLVER PROC = DEFAULT LOSTMSG=ON
AUTHPGMLIST = NONE
SWA = BELOW NONEMPTYMOUNTPT = NOWARN
SERV_LINKLIB =
SERV_LPALIB =
MAXUSERMOUNTSYS = 0 MAXUSERMOUNTUSER = 0
MAXPIPEUSER = 8730
```

To display the current setting of the options that were set during initialization by the parmlib member BPXPRM93 or with the SET OMVS or SETOMVS command and that can be altered dynamically by either of those commands, enter:

```
DISPLAY OMVS,0
```

You will see output that is similar to the following one:

```

BPX0043I 11.08.44 DISPLAY OMVS 962
OMVS      000E ACTIVE          OMVS=(93)
z/OS UNIX CURRENT CONFIGURATION SETTINGS:
MAXPROCSYS      =      256  MAXPROCUSER      =      16
MAXFILEPROC     =      256  MAXFILESIZE     = NOLIMIT
MAXCPUPTIME     =     1000  MAXUIDS       =      32
MAXRTYS         =      256  MAXPTYs        =     256
MAXMMAPAREA     =     4096  MAXASSIZE     =  41943040
MAXTHREADS      =      200  MAXTHREADTASKS =      50
MAXCORESIZE     =  4194304  MAXSHAREPAGES =  131072
IPCMSGQBYTES    =  262144  IPCMSGQNUM    =  10000
IPCMSGNIDS      =      500  IPCSEMNIIDS   =      500
IPCSEMNOPTS     =      25  IPCSEMNSEMS   =      25
IPCshmmpages    =      256  IPCshmniids   =      500
IPCshmnsesgs    =      10  IPCshmnsesgs  =  262144
SUPERUSER       = BPXROOT   FORKCOPY       = COW
STEPLIBLIST     =
USERIDALIASTABLE=
PRIORITYGOAL VALUES: NONE
MAXQUEUEDSIGs   =     1000
SYSCALL COUNTS = NO        TTYGROUP         = TTY
AUTHPGMLIST     = /etc/authfile
SWA              = ABOVE   NONEMPTYMOUNTPT = DENY
SERV_LINKLIB    =
SERV_LPALIB     =
MAXUSERMOUNTSYS = 4        MAXUSERMOUNTUSER = 2
MAXPIPEUSER     = 8730
  
```

Example 7: To display the thread information for process ID 1, enter:

DISPLAY OMVS,PID=1

You will see a display similar to the following one:

```

BPX0070I 11.13.40 DISPLAY OMVS 971
OMVS      000E ACTIVE          OMVS=(93)
USER      JOBNAME ASID        PID      PPID STATE  START  CT_SECS
IBMUSER  BPXOINIT 0013      1        0 MKI    11.02.40 .037
LATCHWAITPID=      0 CMD=BPXPINPR
SERVER=Init Process AF=      0 MF=65535 TYPE=FILE
THREAD_ID  TCB@    PRI_JOB  USERNAME  ACC_TIME SC STATE
04B9267800000000 009DEA70 OMVS      .028 WAT W
04B92F2000000001 009DE8D8      .003 VRT Y
04B937C800000002 009DE278 OMVS      .002 KIN K
  
```

Example 8: To display information about each physical file system that is currently part of the z/OS UNIX System Services configuration when the physical file systems are specified in the BPXPRMxx profile, enter:

D OMVS,P

You will see a display similar to the following one:

DISPLAY OMVS command

```
BPX0068I 10.59.48 DISPLAY OMVS 741
OMVS 000E ACTIVE OMVS=(33)
PFS CONFIGURATION INFORMATION
PFS TYPE ENTRY ASNAME DESC ST START/EXIT TIME
CINET BPXTCINT SOCKETS A 2010/06/17 14.16.52
NFS GFSCINIT MVSNFSCCL REMOTE A 2010/06/17 10.58.31
TFS BPXTFS COLONY1 LOCAL A 2010/06/17 10.58.29
INET EZBPFINI SOCKETS A 2010/06/17 10.59.36
UDS BPXTUINT SOCKETS A 2010/06/17 10.58.29
ZFS IOEFSCM ZFSON2 LOCAL A 2010/06/17 10.58.23
AUTOMNT BPXTAMD LOCAL A 2010/06/17 10.58.23
HFS GFUAINIT LOCAL A 2010/06/17 10.58.23

PFS TYPE DOMAIN MAXSOCK OPNSOCK HIGHUSED
CINET AF_INET 400 0 0
INET AF_INET 50000 244 8146
UDS AF_UNIX 64 6 10

SUBTYPES OF COMMON INET
PFS NAME ENTRY START/EXIT TIME STATUS FLAGS
TCP/IP EZBPFINI INACT
TCP2 EZBPFINI INACT

PFS TYPE FILESYSTYPE PARAMETER INFORMATION
NFS INITD,biiod(2)
HFS CURRENT VALUES: FIXED(0) VIRTUAL(56)
```

The information displayed is:

PFS TYPE

For each FILESYSTYPE statement, the data specified with the TYPE operand is displayed.

PFS DESC

A brief description of the physical file system.

ENTRY

The name of the load module specified with the ENTRYPOINT operand on the FILESYSTYPE or SUBFILESYSTYPE statements.

MAXSOCK

This is the MAXSOCKETS operand of a NETWORK statement for a sockets physical file system. It specifies the maximum number of sockets that can be open at one time for the address family.

OPNSOCK

OPEN SOCKETS: The number of sockets that are currently opened for this sockets physical file system.

HIGHUSED

The highest number of sockets that have been in use at one time for each of the configured address families.

PFS NAME

For each SUBFILESYSTYPE statement, the transport provider specified with the NAME operand is displayed.

FILESYSTYPE PARAMETER INFORMATION

Data specified with the PARM operand on the FILESYSTYPE or SUBFILESYSTYPE statements is displayed. For the file system, in addition to the IPL settings specified with PARM, the current settings for the FIXED and VIRTUAL PARMs are displayed.

ST The state of each PFS. A = ACTIVE, I = INACTIVE, S = STOPPED, U = UNAVAILABLE.

START/EXIT TIME

The start or exit time of the PFS.

STATUS

The status of each PFS specified with the SUBFILESYSTYPE statement: ACT = ACTIVE, INACT = INACTIVE.

FLAGS

Additional information for each PFS that was defined with the SUBFILESYSTYPE statement:

- CD** Current Default transport provider. The system is currently using this PFS as the default transport provider although it wasn't specified as the default with the SUBFILESYSTYPE statement.
- SD** Specified Default transport provider. This PFS was specified as the default transport provider with the SUBFILESYSTYPE statement. Currently, however, it is not being used as the default.
- SC** Specified Current default transport provider. This PFS was specified as the default transport provider with the SUBFILESYSTYPE statement and the system is currently using it as the default.

Note:

1. Although you can specify up to 1024 bytes of parameter information in the BPXPRMxx profile, only the first 165 bytes of parameter information is displayed.
2. If a dash (-) appears as the first character for any PFS name, it means that the PFS is dead.

Example 9: To display the Common Inet routing information when there are three active transport providers, enter:

```
D OMVS,CINET
```

You will see a display similar to the following one. If internet protocol version 6 (IPv6) is in use, 16-byte IP addresses will display where appropriate. IPv6 data is displayed after IPv4 data.

DISPLAY OMVS command

```
BPX0047I 12.01.33 DISPLAY OMVS 285
OMVS 000E ACTIVE OMVS=(QY)
IPV4 HOME INTERFACE INFORMATION
TP NAME HOME ADDRESS FLAGS
TCPIPZ1 001.001.001.001
TCP1 003.003.003.003
TCPIPZ1 006.007.008.009
TCP1 044.044.044.044

IPV4 HOST ROUTE INFORMATION
TP NAME HOST DESTINATION METRIC
TCPIPZ1 001.001.001.001 0
TCP1 003.003.003.003 0
TCP1 127.000.000.001 0
TCPIPZ1 127.000.000.001 0

IPV4 NETWORK ROUTE INFORMATION
TP NAME NET DESTINATION NET MASK METRIC
TCPIPZ1 001.000.000.000 255.000.000.000 0
TCP1 003.000.000.000 255.000.000.000 0

IPV6 HOME INTERFACE INFORMATION
TP NAME HOME ADDRESS FLAGS
TCP1 0022:0022:0022:0022:0022:0022:0022:0022
TCPIPZ1 0000:0000:0000:0000:0000:0000:0000:0009
TCP1 0021:0021:0021:0021:0021:0021:0021:0021

IPV6 HOST ROUTE INFORMATION
TP NAME HOST DESTINATION METRIC
TCP1 0022:0022:0022:0022:0022:0022:0022:0022 0
TCP1 0001:0000:0000:0000:0000:0000:0000:0005 0
TCPIPZ1 0000:0000:0000:0000:0000:0000:0000:0008 0
TCP1 0000:0000:0000:0000:0000:0000:0000:0001 0
TCPIPZ1 0000:0000:0000:0000:0000:0000:0000:0001 0
TCPIPZ1 0000:0000:0000:0000:0000:0000:0000:0009 0
TCP1 0001:0000:0000:0000:0000:0000:0000:0007 0
TCP1 0021:0021:0021:0021:0021:0021:0021:0021 0

IPV6 NETWORK ROUTE INFORMATION
TP NAME NET DESTINATION METRIC
TCPIPZ1 432B:0055:0066:0099:0099:0033:0000:0000/090 0
TCPIPZ1 0000:0000:0099:0044:0055:0077:0099:0066/060 0
TCP1 0000:0000:002E:002E:002E:002E:002E:002E/056 0
TCPIPZ1 0000:0000:0011:0014:0014:0013:0013:0013/090 0
TCPIPZ1 0000:0000:0031:0031:0031:0031:0043:0044/056 0
TCP1 0000:0000:002B:002B:002B:002B:002B:002B/090 0
TCP1 0000:0000:002D:002D:002D:002D:002D:002D/060 0
TCP1 0000:0000:002C:002C:002C:002C:002C:002C/090 0
TCP1 0000:0000:002F:002F:002F:002F:002F:002F/100 0
TCPIPZ1 0000:0000:0033:0033:0033:0033:0033:0033/100 0
```

The information displayed is:

TP NAME

The name of the transport provider for which the information is being displayed.

HOME ADDRESS

The internet protocol (IP) address of the transport provider. 16–bytes display for IPv6.

HOST DESTINATION

When a transport provider is connected to a host, the host IP address is displayed. 16–bytes display for IPv6.

NET DESTINATION

When a transport provider supplies network routing information to the Common Inet Pre-Router, the network destination address is the IP address of a network that can be accessed through the transport provider. 16–bytes

DISPLAY OMVS command

can be issued from any of the systems in the shared file system configuration environment, and the change can also be caused by the subsequent OMVS initialization on the other systems.

Example 11: To display information about current parmlib limits for a process with a PID of 33554434, enter:

```
DISPLAY OMVS,L,PID=33554434
```

You will see a display similar to the following one:

```
d omvs,l,pid=33554434
BPX0051I 14.06.49 DISPLAY OMVS 907
OMVS 0042 ACTIVE OMVS=(69)
USER JOBNAME ASID PID PPID STATE START CT_SECS
WELLIE1 WELLIE1 001C 33554434 1 IRI 14.04.38 .015
LATCHWAITPID= 0 CMD=EXEC
PROCESS LIMITS: LIMMSG=SYSTEM
CURRENT HIGHWATER PROCESS
USAGE USAGE LIMIT
MAXFILEPROC 0 1 256,1000
MAXFILESIZE --- --- NOLIMIT
MAXPROCUSER 1 4 16
MAXQUEUEDSIGS 0 0 1000
MAXTHREADS 0 0 200
MAXTHREADTASKS 0 0 50
IPCSHMSEGS 0 0 10
MAXCORESIZE --- --- 4194304,NOLIMIT
```

An * displayed after a process limit indicates that the limit was changed, either directly, with a SETOMVS,PID= command; or indirectly, by a global change of this value with a SETOMVS command.

The values displayed are in the same units as the values used in the SETOMVS command. For example, MAXFILESIZE is displayed in units of 4KB.

Notes:

1. Although MAXFILESIZE and MAXCORESIZE are displayed in the output, their current and high-water usage are not monitored, and no resource messages are issued for these resources.
2. The MAXPROCUSER limit is based on UID, as opposed to PID, value. The current and high-water usage values reflect all values for all processes that have the same UID as the UID for the specified PID.
3. For UID=0, there is no limit on MAXPROCUSER. When the PID= value in the DISPLAY command is for a process with UID=0, the process limit appears as unlimited. For example:

```
MAXPROCUSER 4 11 NOLIMIT
```

4. MAXCORESIZE, MAXFILESIZE, and MAXFILEPROC each have hard and soft limits. (See the documentation for the C-RTL function **setrlimit()** in *z/OS XL C/C++ Runtime Library Reference*.) When the hard and soft limits are the same, only one value is displayed. When the limits are different, both values are displayed: first the soft limit and then the hard limit, separated by a comma. In the preceding example, MAXFILEPROC has a hard limit of 1000 and a soft limit of 256. For MAXFILESIZE, the soft limit is equal to the hard limit and is unlimited. For MAXCORESIZE, the soft limit is 4,194,304 and the hard limit is unlimited.

Example 12: If the SETOMVS command is issued to change the value of MAXFILEPROC to 256, the information displayed is:

	CURRENT USAGE	HIGHWATER USAGE	PROCESS LIMIT
MAXFILEPROC	0	0	100,256
.			
.			
.			

If the process changes its soft limit for MAXFILEPROC to 100 (using the `setrlimit()` function), the information displayed is:

Example 13: To display thread-level information for any thread that is in a byte-range lock wait, enter:

```
D OMVS,PID=16777219,BRL
```

You will see a display similar to the following one:

```
BPX0070I 13.50.54 DISPLAY OMVS 042
OMVS 000E ACTIVE OMVS=(99)
USER JOBNAME ASID PID PPID STATE START CT_SECS
WELLIE0 WELLIE0 0015 16777219 16777218 ICI 14.11.53 .703
LATCHWAITPID= 0 CMD=sh -L
THREAD_ID TCBO PRI_JOB USERNAME ACC_TIME SC STATE
250640E000000002 009C8550 OMVS .124 RED C
BRLWAIT DEV=00000001 INO=0000002E FILE=PoughkeepsiePho+ PID=12345678
The blocking process is on system: SY2
```

The information displayed in `BRLWAIT DEV=00000001 INO=0000002E FILE=PoughkeepsiePho+ PID=12345678` is:

DEV

The device number of the file's mounted file system.

INO

The inode number of the file, as shown by `ls -i`.

FILE

Up to 16 characters of the filename of the file that is being locked. If the filename has more than 16 characters, the first 15 are displayed, followed by a plus sign (+).

PID

The process ID of another process that is blocking this process from obtaining the lock. Usually this is the owner (or one of the owners) of a lock on the same range, but sometimes it is another process that is also waiting.

The system also displays the name of the system for where the blocking process is, when the following conditions occur:

- The command is issued in a sysplex configuration.
- The blocking process is from a system in the sysplex that is different from the system where the command is issued.

Example 14: To display a report of serialized, in-use, shared memory mutexes and condition variables, enter:

```
D OMVS,SER
```

You will see a display similar to the following one:

DISPLAY OMVS command

```
BPX0057I 08.51.42 DISPLAY OMVS 284
OMVS      000E ACTIVE          OMVS=(6D)
          UNIX SERIALIZATION REPORT
NO RESOURCE CONTENTION EXISTS
```

The output from D OMVS,SER will be as follows when there is contention:

```
BPX0057I 08.51.42 DISPLAY OMVS 284
OMVS      000E ACTIVE          OMVS=(6D)
          UNIX SERIALIZATION REPORT
RESOURCE  #1

  NAME=SHARED MUTEX  DATA: SHMID=00000648 OFFS/ADDR=000000000002428
JOBNAME ASID TCB      PID      USER DATA      EXC/SHR  OWN/WAIT
DOMINO1 013A 008EF190 16777220 0000000024780148 EXC      OWN
DOMINO2 02B2 008FA190 16908357 0000000024825220 EXC      WAIT
DOMINO3 0206 008FF458 16973924 0000000024824778 EXC      WAIT
RESOURCE  #2

  NAME=SHARED CONDVAR DATA: SHMID=00000648 OFFS/ADDR=000000000002458
JOBNAME ASID TCB      PID      USER DATA      EXC      WAIT
DOMINO2 02B6 008FA190 16908357 0000000024825220 EXC      WAIT
DOMINO3 0206 008FF458 16973924 0000000024824778 EXC      WAIT
RESOURCE #0002 IS LOCKED BY:
  NAME=SHARED MUTEX  DATA: SHMID=00000648 OFFS/ADDR=000000000002428
```

The information displayed is:

NAME= SHARED MUTEX / CONDVAR

An indication of whether the object is a mutex (MUTEX) or condition variable (CONDVAR).

Example 15: To display information about all the dynamically activated service items, enter:

```
D OMVS,ACTIVATE=SERVICE
```

You will see a display similar to the following one:

```
BPX0059I 08.51.42 DISPLAY OMVS 284
OMVS      000E ACTIVE          OMVS=(6D)
          DYNAMIC SERVICE ACTIVATION REPORT
SET #3:
  LINKLIB=SYS1.DYNLIB.PVT          VOL=BPXLK1
  LPALIB=SYS1.DYNLIB.LPA          VOL=BPXLK1
  OA12345 OA23456 OA34567 OA45678 ANLATC1
SET #2:
  LINKLIB=SYS1.DYNLIB.PVT          VOL=BPXLK1
  LPALIB=SYS1.DYNLIB.LPA          VOL=BPXLK1
  OA02001 OA02002 OA02003 OA02004 OA02004 OA02005
  OA02007 OA02008 OA02009
SET #1:
  LINKLIB=SYS2.DYNLIB.PVT          VOL=BPXLK1
  LPALIB=SYS1.DYNLIB.LPA          VOL=BPXLK1
  OA01001 OA01002 OA01003
ECSA STORAGE: 1268496          OMVS STORAGE: 4768248
```

This display output shows that the service items (such as OA12345) are listed in groups based on when they were activated. The displayed information includes the library and volume from which each set of service was activated. At the end of the report, the output shows the amount of ECSA and OMVS address space storage consumed by all dynamically activated service items. Note that the amount of storage consumed will not decrease if you deactivate service items because the

modules containing the deactivated service items remain in storage. For example, let us say you back off the most recently dynamically activated service (Set 3) shown in the preceding output with the following command:

```
F OMVS,DEACTIVATE=SERVICE
```

Next, you enter the display command again, to see the following output:

```
D OMVS,ACTIVATE SERVICE
```

You will see a display similar to the following one:

```
BPX0059I 08.58.26 DISPLAY OMVS 296
OMVS      000E ACTIVE          OMVS=(6D)
          DYNAMIC SERVICE ACTIVATION REPORT
SET #2:
LINKLIB=SYS1.DYNLIB.PVT          VOL=BPXLK1
LPALIB=SYS1.DYNLIB.LPA          VOL=BPXLK1
OA02001 OA02002 OA02003 OA02004 OA02005 OA02006
OA02007 OA02008 OA02009
SET #1:
LINKLIB=SYS2.DYNLIB.PVT          VOL=BPXLK1
LPALIB=SYS1.DYNLIB.LPA          VOL=BPXLK1
OA01001 OA01002 OA01003
ECSA STORAGE: 1268496          OMVS STORAGE: 4768248
```

Note that the service items in Set #3 are no longer shown because they have been deactivated, but the total ECSA and OMVS storage consumed has not decreased.

Example 16: To display information about waiters caused by mount latch contention, outstanding sysplex messages, file system contention or other conditions, enter:

```
D OMVS,W
```

You will see a display similar to the following one:

DISPLAY OMVS command

```

SY1 D OMVS,W
SY1 BPX0063I 12.39.07 DISPLAY OMVS 426
OMVS 000E ACTIVE OMVS=(QY)

MOUNT LATCH ACTIVITY:
  USER ASID TCB REASON AGE
-----
HOLDER:
OMVS 000E 008E9828 Inact Cycle 00.01.18
IS DOING: XPFS VfsInactCall / XSYS Message To: SY2
FILE SYSTEM: ZOS17.SY2.ETC.HFS
HOLDING: File System Latch 123 EXCL
WAITER(S):
OMVS 000E 008D97C8 FileSys Quiesce 00.00.05
OMVS 000E 008E9B58 FileSys Sync 00.01.10

OUTSTANDING CROSS SYSTEM MESSAGES:
SENT SYSPLEX MESSAGES:
  USER ASID TCB FCODE MEMBER REQID MSG TYPE AGE
-----
MEGA 0025 008DD218 0008 SY2 01000038 LookupCall 00.03.08
      FILE: somedirname (12,456)
      HOLDING: File System Latch 333 SHR
TCO 0026 008E6E88 1011 SY1 0100003A Quiesce 00.00.05
      HOLDING: File System Latch 456 EXCL
OMVS 000E 008E9828 0804 SY2 01000039 VfsInactCall 00.01.18
      HOLDING: File System Latch 27 EXCL

RECEIVED SYSPLEX MESSAGES:
  ON TCB FROM ASID FROM TCB FCODE MEMBER REQID MSG TYPE AGE
-----
008D97C8 0026 008E6E88 1011 SY1 0100003A Quiesce 00.00.05
IS DOING: Mount Latch Wait
008D1238 0022 008E6E00 0003 SY3 01000123 Read 00.07.25
IS DOING: ZFS Read
FILE: thefilename (44,1234)
FILE SYSTEM: ZOS17.SY2.VAR.HFS
HOLDING: File System Latch 33 SHR

FILE SYSTEM LATCH ACTIVITY:
  USER ASID TCB SHR/EXCL AGE
-----
Latch 432 FILE SYSTEM: THE.FILESYS.NAME
HOLDER(S):
User10 0044 00880460 SHR 00:12:08
IS DOING: NFS ReadCall
FILE: somefilename (88,1234)
User11 0045 00880460 SHR 00:15:58
IS DOING: NFS ReadCall
FILE: somefilename (88,1234)
WAITER(S):
OMVS 000E 008E9B58 EXCL 00.01.10
Latch 678 FILE SYSTEM: ANOTHER.FILESYS.NAME
HOLDER(S):
OMVS 000E 00820420 EXCL 00:12:08
IS DOING: ZFS SyncCall / Osi_Wait
WAITER(S):
User12 0022 008D97C8 SHR 00.00.05
User15 0072 008E9B58 SHR 00.01.10
FILE LATCH ACTIVITY:
  USER ASID TCB SHR/EXCL AGE
-----
LATCH 66 LSET 01 TYPE REGFILE DEVNO 2 INO 204
FILE: myfile
FILE SYSTEM: ZOS112.ETC.ZFS
HOLDER(S):
TCO 0026 008E6D90 EXCL 00.00.56
TIME: 2009/10/08 16.21.36
IS DOING: Running
FILE: myfile (2,204)
WAITER(S):
TCO 0027 008E6D90 SHR 00.00.53
TIME: 2009/10/08 16.21.38

OTHER WAITING THREADS:
  USER ASID TCB PID AGE
-----
USER01 0021 00908070 1234 00:12:41
IS DOING: NFS Readdir / Running
FILE: nfsdirname (33,5432)
FILE SYSTEM: HOST12.AJAX.DIRECTORY
HOLDING: File System Latch #123 SHR
USER03 0041 00908070 786534 00:12:41
IS DOING: BRML Wait
FILE: FileNameIsHere (22,845)
FILE SYSTEM: AJAX.DS88.ZFS
USER04 0051 00908070 15 00:00:49
IS DOING: File Latch Wait-Latch 1379
FILE: somefilename (88,1234)
FILE SYSTEM: HOST12.AJAX.DIRECTORY
HOLDING: File System Latch #123 SHR
USER05 0071 00908070 378992 00:08:51
IS DOING: ZFS Write / OS1_WAIT
FILE: zfsfilename
FILE SYSTEM: AJAX.DS23.ZFS

```

Example 17: To display information about the last 10 or less mount or move failures, enter:

```
D OMVS,MF
```

You will see a display similar to the following one:

```

SY1 d omvs,mf
SY1 BPX0058I 11.22.20 DISPLAY OMVS 480
OMVS 000D ACTIVE OMVS=(MN,ZS)
SHORT LIST OF FAILURES:
TIME=16.24.40 DATE=2003/11/18 MOVE RC=0489 RSN=1278054D
NAME=ZOS16.SY1.HFS
PATH=/SY1
SYSNAME=SY3
TIME=11.22.07 DATE=2003/11/18 MOUNT RC=0099 RSN=C5C7082A
NAME=MY.HFS
TYPE=HFS
PATH=/SY1/tmp
TIME=21.58.17 DATE=2003/11/17 MOVE RC=0079 RSN=119E04B7
NAME=*
SYSNAME=SY9
TIME=11.54.04 DATE=2003/11/25 MOVE RC=0079 RSN=119E04B7
PATH=/SY2
SYSNAME=CAT
TIME=11.52.15 DATE=2003/11/25 MOVE RC=0079 RSN=119E04B7
NAME=ZOS16.SY2.HFS
SYSNAME=DOG
    
```

Example 18: To display information about each AF_UNIX socket, enter:

D OMVS,SOCKETS

You will see a display similar to the following one:

```

BPX0060I 17.12.57 DISPLAY OMVS
OMVS 000D ACTIVE OMVS=(6F,JB)
AF_UNIX Domain Sockets
JOBNAME ID PEER ID STATE READ WRITTEN
-----
TCPCS 00000003 00000000 LISTEN 00000345
Socket name: /var/sock/SYSTCPCN.TCPCS
TCPCS 0000002A 00000022 ACP 000012AB 00054C2A
Socket name: /var/sock/SYSTCPCN.TCPCS
Peer name: /tmp/sock1
NETVIEW 00000022 0000002A CONN 00054C2A 000012AB
Socket name: /tmp/sock1
Peer name: /var/sock/SYSTCPCN.TCPCS
USER14 00000006 00000000 DGRAM 00000480 00000ABC
Socket name: /tmp/test.sock
TCPCS 00000037 00000034 ACP 00000012 0000034C
Socket name: /var/sock/SYSTCPCN.TCPCS
JLB 00000034 00000037 CONN 0000034C 00000022
Peer name: /var/sock/SYSTCPCN.TCPCS
    
```

Example 19: To display information about the nonprivileged user mounts, enter:

```

D OMVS,USERMOUNTS

691 D OMVS,USERMOUNTS
692 BPX0072I 13.28.20 DISPLAY OMVS 544
693 OMVS 000E ACTIVE OMVS=(3Z)
694 NONPRIVILEGED USER MOUNTS SUMMARY
695 UID CURRENT MOUNTS
696 295 1
697 647 2
698 25 1
    
```

Example 20: To display the default output, which will list the top two high-use UIDs, enter:

D OMVS,PIPES

DISPLAY OMVS command

You will see a display similar to the following one:

```
BPX0073I 15.40.20 DISPLAY OMVS 645
OMVS 000F ACTIVE OMVS=(2E)
PIPE OWNER SUMMARY MAXPIPEUSER=8730
CURRENT HIGHWATER
USERID UID USAGE USAGE
WELLIE2 12 3000 3000
WELLIE1 11 2100 2100
HIGHWATER USER:
USERID=WELLIE2 UID=12 HIGHWATER USAGE=3000
```

Example 21: To display all the open pipe creators, enter:

```
D OMVS,PIPES,ALL
```

You will see a display similar to the following one:

```
BPX0073I 15.41.58 DISPLAY OMVS 648
OMVS 000F ACTIVE OMVS=(2E)
PIPE OWNER SUMMARY MAXPIPEUSER=8730
CURRENT HIGHWATER
USERID UID USAGE USAGE
MEGA 0 1000 1000
WELLIE1 11 2100 2100
WELLIE2 12 3000 3000
HIGHWATER USER:
USERID=WELLIE2 UID=12 HIGHWATER USAGE=3000
```

Example 22: To display the processes that created active pipes for UID(11), enter:

```
D OMVS,PIPES,u=11
```

You will see a display similar to the following one:

```
BPX0074I 15.43.31 DISPLAY OMVS 651
OMVS 000F ACTIVE OMVS=(2E)
TOTAL CURRENT USAGE=2100
CURRENT SYSTEM
PID USAGE NAME
50331678 600 SY1
24 500 SY1
50331674 500 SY1
50331676 500 SY1
```

Example 23: To display the z/OS UNIX System Services kernel private storage below the bar (<2G) usage, enter:

```
D OMVS,ST
```

You will see a display similar to the following one:

```
BPX0075I 08.56.40 DISPLAY OMVS 068
OMVS 000F ACTIVE OMVS=(4Z)
KERNEL STORAGE USAGE
PRIVATE STORAGE:
CURRENT USAGE MAXIMUM AVAILABLE HIGH WATER REGION SIZE
36524028 303017164 36524028 1528799232
STACK CELLS:
CURRENT USAGE MAXIMUM CELLS HIGH WATER
101 32879 131
PROCESS STACK CELL USAGE
USER JOBNAME ASID PID PPID STATE THREADS STACKS
JOHNH JOHNH1 0038 16777221 1 HS----- 77 85
```

Example 24: When the KERNELSTACKS(BELOW) parmlib option is used, the display remains the same. When the KERNELSTACKS(ABOVE) parmlib option is used, the display shows threads instead of stack cells and looks as follows:

```

BPX0075I 11.01.17 DISPLAY OMVS 678
OMVS      000F ACTIVE          OMVS=(D3,DN,D4)
                KERNEL STORAGE USAGE
PRIVATE STORAGE:
CURRENT USAGE  MAXIMUM AVAILABLE  HIGH WATER  REGION SIZE
32501759      302244659             32501759   1525653504
THREADS:
CURRENT USAGE  MAXIMUM THREADS  HIGH WATER
64             500000             64
                PROCESS THREAD USAGE
USER  JOBNAME  ASID  PID  PPID STATE  THREADS
WELLIE0  WELLIE01 0026   7  33554438 HK-----  51
    
```

If no processes have more than 50 threads, you will get the following display instead of a list:

```
NO PROCESSES FOUND USING 50 OR MORE THREADS
```

Displaying operator information (OPDATA)

Use the DISPLAY OPDATA command to display operator information (OPDATA). Depending on the operands specified, the display may represent either sysplex-wide data or system-unique data.

The syntax of the DISPLAY OPDATA command is:

```

D {OPDATA|O} [,PREFIX      ] [,L={a|name|name-a}]
                [, {MONITOR|MN} [,FULL]]
                [,MODE]
    
```

OPDATA or O

The system displays operator information.

PREFIX

The system displays (in message IEE603I) sysplex-wide information about the command prefixes defined for the subsystems in the sysplex. This is the default if no other operands are specified. See *z/OS MVS Planning: Operations* for more information.

MONITOR or MN

The system is to display (in message CNZ1100I) the enablement status of the monitoring facility for all message types supported, including whether each of these monitor message types are sent to the system log/operlog. The system also displays the number of consoles and, if applicable, TSO/E users that have requested to receive specific message types.

FULL Instead of displaying the number of consoles and TSO/E users that have requested to receive specific message types, the system lists the names of those consoles. If there is any TSO/E user information to display, an additional section listing the user names will be included.

MODE

The system issues message CNZ9006I that displays the current Console Services mode and migration status of all systems in the sysplex.

DISPLAY OPDATA command

L=*a*, *name*, or *name-a*

Specifies the display area (*a*), console name (*name*), or both (*name-a*) where the display is to appear.

If you omit this operand, the display is presented in the first available display area or the message area of the console through which you enter the command.

Example 1:

To display information about the command prefixes current and active on the sysplex, enter:

```
D 0,PREFIX
```

Example 2:

To display information about the enablement status of the monitoring facility for all monitor message types supported, enter:

```
D 0,MONITOR
```

Example 3:

To display information about the Console Service mode and migration status, enter:

```
D 0,MODE
```

The output looks like:

```
CNZ9006I 11.27.40 DISPLAY 0,MODE
CURRENT: DISTRIBUTED
SYSTEM  MIGRATION STATUS
SY1     MIGRATION SUPPORTED
SY2     MIGRATION SUPPORTED
SY3     MIGRATION SUPPORTED
SY4     MIGRATION SUPPORTED
SY5     MIGRATION SUPPORTED
SY6     MIGRATION SUPPORTED
SY7     MIGRATION SUPPORTED
SY8     MIGRATION SUPPORTED
SYSPLEX ABLE TO MIGRATE: YES
```

Displaying PCIE information

Use the DISPLAY PCIE command to display:

- All registered device drivers (with assigned printable names).
- All available or in-use PCIe functions and their associated device types.
- Information on a specific PCIe device with a list of the client address spaces using the device.

D PCIE
D PCIE{[]} { [,DD]} { [,PFID=pfid]}

D PCIE

The Display PCIE command (without any optional keywords specified) lists all the available, configured, and in-use PCIe functions, each with the PFID *pfid*,

the device type name (or device type if the name is not known), the configuration status, the owner *asid*, *jobname*, physical channel ID *pchid*, and virtual function number *vfn*. Message IQP022I displays the output information.

DD Lists all registered device drivers, each with an assigned printable name. Message IQP023I displays the output information.

PFID=*pfid*

Displays the status only for a specific PCIE function *pfid*, along with a list of all the current client address spaces. Message IQP024I displays the output information, which also includes the PFID *pfid*, the device type name (or device type if the name is not known), the configuration status, the owner *asid*, *jobname*, physical channel ID *pchid*, virtual function number *vfn*, and the list of the current client address spaces for the requested *pfid*. *pfid* is specified in hexadecimal, and the accepted range for the *pfid* is X'0000' - X'FFFF'.

Displaying PARMLIB information

Use the DISPLAY PARMLIB command to display:

- The parmlib data sets and volume serial numbers that are defined in LOADxx.
- The parmlib data sets and volume serial numbers that are defined in the MASTER JCL (when there are no LOADxx parmlib statements).

Note: If you did not specify SYS1.PARMLIB in the parmlib concatenation, the system automatically adds it to the end of the parmlib concatenation.

D PARMLIB
D PARMLIB [,ERRORS E] [,L={a name name-a}]

ERRORS or E

Parmlib data sets and volume serial numbers that were defined in LOADxx PARMLIB statements but were not found.

L=*a*, *name*, or *name-a*

Specifies the display area (*a*), console name (*name*), or both (*name-a*) where the display is to appear.

If you omit this operand, the display is presented in the first available display area or the message area of the console through which you enter the command.

Example 1:

Assume a system has the following characteristics:

- Parmlibs STEVE.PARMLIB1 and STEVE.PARMLIB2 were used to IPL the system.
- Both parmlib data sets reside on volume D72665 and were specified on the PARMLIB statement in LOADxx.

D PARMLIB

The system returns the following display, slightly modified to improve readability:

```
SYS1      D PARMLIB
SYS1      IEE251I 16.41.05 PARMLIB DISPLAY 048
PARMLIB DATA SETS SPECIFIED
AT IPL
```

DISPLAY PARMLIB command

ENTRY	FLAGS	VOLUME	DATA SET
1	S	D72665	STEVE.PARMLIB1
2	S	D72665	STEVE.PARMLIB2
3	D	DEFVOL	PARMLIB

Example 2:

Assume a system has the following characteristics:

- Parmlib data sets STEVE.PARMLIB1 and STEVE.PARMLIB2 were used to IPL the system.
- SYS1.PARMLIB was also specified on the PARMLIB statement of LOADxx.

```
D PARMLIB
```

The system returns the following display, slightly modified to improve readability:

```
SYS1 D PARMLIB
SYS1 IEE251I 16.41.05 PARMLIB DISPLAY 048
PARMLIB DATA SETS SPECIFIED
AT IPL
ENTRY  FLAGS  VOLUME  DATA SET
  1      S      D72665  STEVE.PARMLIB1
  2      S      DEFVOL  PARMLIB
  3      S      D72665  STEVE.PARMLIB2
```

Example 3:

Assume a system has the following characteristics:

- The default parmlib data set is used to IPL the system.
- The following output could mean one of the following:
 - There were parmlib data sets specified in LOADxx but they were not found. Issue the D PARMLIB,ERRORS command.
 - No parmlib data sets were specified in either the LOADxx member or on the IEFPARM DD statement in Master JCL.

```
D PARMLIB
```

The system returns the following display, slightly modified to improve readability:

```
SYS1 D PARMLIB
SYS1 IEE251I 16.41.05 PARMLIB DISPLAY 048
PARMLIB DATA SETS SPECIFIED
AT IPL
ENTRY  FLAGS  VOLUME  DATA SET
  1      D      DEFVOL  PARMLIB
```

Example 4:

Assume a system has the following characteristics:

- There was no parmlib data set in LOADxx.
- The default parmlib data set is used to IPL the system.
- Parmlib data sets STEVE.PARMLIB3 and STEVE.PARMLIB4 were found in the IEFPARM DD statement of Master JCL.

```
D PARMLIB
```

The system returns the following display, slightly modified to improve readability:

```
SYS1 D PARMLIB
SYS1 IEE251I 16.41.05 PARMLIB DISPLAY 048
PARMLIB DATA SETS SPECIFIED
AT IPL
```

```
ENTRY  FLAGS  VOLUME  DATA SET
1      D      DEFVOL  PARMLIB
```

```
MASTER PROCESSING USING THE FOLLOWING PARMLIBS
ENTRY  FLAGS  VOLUME  DATE SET
1      S      D72666  STEVE.PARMLIB3
2      S      D72666  STEVE.PARMLIB4
```

Example 5:

To display the parmlib data sets defined but not found, enter:

```
D PARMLIB,ERRORS
```

Assume a system has the following characteristics:

- Parmlib data sets STEVE.PARMLIB5 and STEVE.PARMLIB6 were specified in LOAD *xx* PARMLIB statements, but they were not found.

```
D PARMLIB,ERRORS
```

The following illustration is slightly modified from what the user sees in order to improve readability in this documentation.

```
SYS1  D PARMLIB,ERRORS
SYS1  IEE251I 16.41.05 PARMLIB, ERRORS 048
PARMLIB DATA SETS SPECIFIED BUT NOT FOUND
ENTRY  FLAGS  VOLUME  DATA SET
1      S      D72666  STEVE.PARMLIB5
2      S      D72666  STEVE.PARMLIB6
```

Example 6:

To display the parmlib data sets defined after a SETLOAD command update:

```
D PARMLIB
```

Assume a system has the following characteristics:

- At 11.05.14 on 9/13/96, a SETLOAD command was issued.
- The SETLOAD command used LOADPL which was found in data set SYS1.PARMLIB on volume CTDSD1.
- The LOADPL member has 3 parmlib statements:
 1. RELSON.MACLIB
 2. SYS1.PARMLIB
 3. RELSON.PARMLIB
- All 3 parmlib data sets in LOADPL reside on volume CTDSD1.
- The cataloged SYS1.PARMLIB data set is added to the end of the parmlib concatenation by default.

Note: The cataloged SYS1.PARMLIB data set, which is not the same data set as the data set SYS1.PARMLIB on volume CTDSD1, is automatically added to the end of the parmlib concatenation by default (because it was not explicitly stated in the parmlib concatenation).

```
D PARMLIB
```

The following illustration is slightly modified from what the user sees in order to improve readability in this documentation.

```
SYS1  D PARMLIB
SYS1  IEE251I 16.41.04 PARMLIB DISPLAY 048
PARMLIB DATA SETS SPECIFIED
```

DISPLAY PARMLIB command

```
AT 11.05.14 ON 09/13/1996
ENTRY   FLAGS   VOLUME  DATA SET
  1     S      CTDS01  RELSON.MACLIB
  2     S      CTDS01  PARMLIB
  3     S      CTDS01  RELSON.PARMLIB
  4     D      CATALOG PARMLIB
```

Displaying commands defined for PFKs

Use the DISPLAY PFK command to display the PFK definitions in effect for a specified console, the PFK definitions in a specified PFK table, or the PFK tables that are available.

D PFK
D PFK[,CN=name [,L={a name name-a}] [, {TABLE T} [=nnnnnnnn]]

PFK

The system displays information about the PFKs (message IEE235I). Unless you specify otherwise on the CN= name operand, the PFK information refers to the console from which you issue the command.

Note: Only D PFK with the T or TABLE option is valid from extended consoles. Any other specification of the D PFK command has no effect on extended MCS consoles or on system consoles, and is not valid for managing these consoles.

TABLE or T

Requests PFK definitions in a specific PFK table or lists all names of PFK tables that are available to be displayed.

nnnnnnnn

Requests PFK definitions in the PFK table named *nnnnnnnn*. If you omit *=nnnnnnnn*, the system displays the list of PFK tables available.

CN=*name*

Requests the PFK definitions for the console called *name*.

L=*a*, *name*, or *name-a*

Specifies the display area (*a*), console name (*name*), or both (*name-a*) where the display will appear.

If you omit this operand, the display is presented in the first available display area or the message area of the console through which you enter the command.

Example 1:

To display PFK definitions for the console on which you issue the command, enter:

```
D PFK
```

Example 2:

To display all available PFK tables, enter:

```
D PFK,T
```

Example 3:

To display the contents (PFK definitions) of the PFK table named MVSCMDS, enter:

D PFK,T=MVSCMDS

Displaying PPTs

Displays the contents of the Program Properties Table (PPT).

D PPT	
{DISPLAY}	PPT [{,ALL }]
{ D }	{,PARMLIB PARM }
	{,DEFAULT DEF }
	{,NAME=pattern }
	[,L={a name name-a}]

PPT

Displays the contents of the Program Properties Table (PPT).

ALL

Indicates that all entries in the Program Properties Table are to be displayed.

PARMLIB or PARM

Indicates the PPT entries that were specified in a SCHEDxx parmlib member are to be displayed.

DEFAULT or DEF

Indicates the PPT entries that are IBM-supplied defaults, that have not been respecified by a SCHEDxx parmlib member, are to be displayed.

NAME=*pattern*

Indicates the PPT entries, that match the specified pattern, are to be displayed. You can specify wildcard characters (* and ?) in the pattern.

L=*a, name, or name-a*

Specifies the display area (*a*), console name (*name*), or both (*name-a*) where the display is to appear. If you omit this operand, the display is presented in the first available display area or the message area of the console through which you enter the command.

Example 1: Assuming that no SCHEDxx parmlib members have been used to modify the PPT, issuing the command: D PPT produces the following example output:

```
IEF386I 11.20.01 DISPLAY PPT
No Parmlib Values
Default Values
PgmName  NC NS PR ST ND BP Key 2P 1P NP NH CP
AHLGTF   Y Y . Y . . 0 . . Y . .
AKPCSIEP . Y . Y Y . 1 . . Y . .
ANFFIEP . Y . Y Y . 1 . . . . .
APSHPOSE . Y . Y Y . 1 . . Y . .
APSKAFPD . Y . Y Y . 1 . . Y . .
APSPPIEP . Y . Y Y . 1 . . Y . .
ASBSCHIN . Y . Y . . 1 Y Y . . .
ASBSCHWL . . Y . . . 1 . . . . .
ATBINITM . Y . Y . . 1 Y Y . . .
ATBSDFMU . . Y . . . 1 . . . . .
AVFMNBLD Y Y . Y . . 3 . . Y . .
BBGCTL . Y Y . . . 2 . . . . .
BBGDAEMN . Y Y Y . . 2 . . . . .
BBOCTL . Y Y . . . 2 . . . . .
BBODAEMN . Y Y Y . . 2 . . . . .
```

DISPLAY PPT command

BNJLINTX	.	Y	8
BPEINI00	.	Y	.	Y	.	.	7
BPXBATA2	.	.	Y	.	.	.	2
BPXINIT	Y	Y	.	Y	.	.	0
BPXPINPR	Y	.	.	Y	.	.	8	Y	Y	.	.	.
BPXVCLNY	.	Y	Y	Y	.	.	8
CBRIIAS	.	.	.	Y	.	.	5
CBROAM	.	Y	.	Y	.	.	5
CNLSSDT	.	Y	.	Y	.	.	0	Y	Y	.	.	.
COFMINIT	.	Y	.	Y	Y	Y	0
COFMISDO	Y	Y	.	Y	Y	Y	0
CQSINIT0	.	Y	.	Y	.	.	7	.	.	Y	.	.
CSFINIT	Y	Y	Y	Y	.	.	0
CSQYASCP	.	.	.	Y	.	.	7
CSVLLCRE	.	Y	.	Y	.	Y	0
CSVVFCRE	.	Y	.	Y	.	.	0
DFHSIP	.	Y	8	.	.	Y	.	.
DFSMVRC0	.	Y	.	Y	.	.	7
DFSYSVI0	.	Y	.	Y	.	.	7
DSIMNT	.	Y	8
DSNUTILB	7
DSNYASCP	.	Y	.	Y	.	.	7
DUIFT000	.	Y	8
DWW1SJST	Y	Y	Y	Y	.	.	5
DXRRLM00	.	Y	.	Y	.	.	7
EKGTC000	Y	Y	8
EPWINIT	Y	Y	.	.	Y	Y	0	.	.	Y	.	.
ERBMFMFC	.	Y	.	Y	Y	.	8
ERB3GMFC	.	Y	.	Y	Y	.	8
EZAPPAAA	.	Y	8
EZAPPFS	.	Y	1
EZBADNR	.	Y	Y	Y	.	.	8
EZBLBADV	.	Y	Y	Y	.	.	8
EZBLBAGE	.	Y	Y	Y	.	.	8
EZBREINI	Y	Y	Y	Y	.	.	6
EZBTCPIP	Y	Y	Y	Y	.	.	6	Y	Y	.	.	.
EZBTNINI	Y	Y	Y	Y	.	.	6
FRDRVS00	.	Y	.	Y	.	.	7
GDEICASB	.	Y	.	Y	.	.	5	.	.	Y	.	.
GDEISASB	.	.	.	Y	.	.	5	.	.	Y	.	.
GDEISBOT	.	Y	.	Y	.	.	5	.	.	Y	.	.
GEOXCFST	.	Y	Y	Y	.	.	8	Y
HASJES20	Y	Y	.	Y	Y	.	1	.	.	.	Y	.
HCW4MDDM	.	Y	.	Y	.	.	8	.	Y	.	.	.
HHLGTF	Y	Y	.	Y	.	.	0	.	.	Y	.	.
HSAPINIT	.	Y	Y	.	.	.	8
HWIAMIN1	.	Y	.	Y	.	.	4
HWIAMIN2	.	Y	.	Y	.	.	4	Y	Y	.	.	.
IASXWR00	Y	.	.	Y	.	.	1
IATCNDTK	Y	Y	Y	Y	.	.	1
IATINTK	Y	Y	.	Y	Y	.	1	.	.	.	Y	.
IATINTKF	.	Y	.	Y	Y	.	1
IATINXM	Y	Y	Y	Y	.	.	1	Y	Y	.	.	.
IAZNJTCP	.	.	Y	Y	.	.	0
IDAVSJST	Y	Y	Y	Y	.	.	5
IEAVTDSV	.	.	Y	Y	.	Y	0	Y	Y	.	.	.
IEDQTCAM	.	Y	6	.	.	Y	.	.
IEEMB860	Y	Y	.	Y	Y	Y	0
IEEVMNT2	Y	.	.	Y	.	.	0
IEFIIC	Y	.	Y	Y	.	.	0
IFASMF	Y	Y	Y	Y	Y	.	0
IFDOLT	8	Y	Y	.	.	.
IGDSSI01	Y	Y	.	Y	.	Y	5
IGG0CLX0	Y	Y	Y	Y	Y	.	0	Y
IHLGTF	Y	Y	.	Y	.	.	0	.	.	Y	.	.
IHVOINI	.	Y	8
IKTCAS00	Y	.	Y	Y	.	.	6

```

IOSHMCTL . Y Y Y . . 0 . . . . Y
IOSHSAPI . Y Y Y . . 0 . . . . Y
IOSVROUT Y Y . Y . Y 0 . . . . .
IQCINIO$ . Y . Y . . 7 . . . . .
IRRSSM00 Y Y Y Y . . 2 . . . . .
ISFHCTL . Y . . . . 1 . . . . .
ISTINM01 Y Y . Y . Y 6 . . Y . .
ITTRCWR Y Y Y Y . Y 0 Y Y . . .
IWMINJST Y Y . Y . . 0 Y Y . . .
IXCINJST Y Y . Y . . 0 Y Y . . Y
IXGBLF00 . Y . Y . . 0 . . . . .
IXGBLF01 Y Y . Y . . 0 . Y . Y .
IXZIX00 Y Y Y Y . . 1 . . . . .
MVPTNF Y Y Y Y . . 0 . . . . .
MVPXVMCF Y Y Y Y . . 0 . . . . .
SNALINK . Y . Y . . 6 . . . . .

```

Reference

Synonym	-----Meaning-----	----SCHEDxx keyword-----
NC	Non-cancelable	NOCANCEL
NS	Non-swappable	NOSWAP
PR	Privileged	PRIV
ST	System task	SYST
ND	No dataset integrity	NODSI
BP	Bypass password protection	NOPASS
Key	PSW key for this program	KEY(x)
2P	Second level preferred storage	SPREF
1P	First level preferred storage	LPREF
NP	No preferred storage	NOPREF
NH	No honor IEFUSI region settings	NOHONORIEFUSIREGION
CP	Critical paging	CRITICALPAGING

Displaying registered products

Use the DISPLAY PROD command to display information about products that have been registered or display the product enablement policy. You can also use the command to determine the state (enabled, disabled, not defined, or not found) that, according to the current policy, exists for a specific product or set of products.

When the system searches for any products you specify, it allows wildcard matching. OWNER, NAME, FEATURENAME, and ID can include wildcard characters (* and ?) that allow a single parameter to match many different actual conditions. For example, OWNER(AD?) matches owner names like AD1 or AD2 but not ADD1. OWNER(A*) matches A1 or AD1 or ADD1.

The complete syntax for the DISPLAY PROD command is:

D PROD
D PROD, {REGISTERED REG STATE STATUS}
[,OWNER(o)][,NAME(n)][,FEATURENAME(fn)][,ID(id)][,ALL][,L={a name name-a}]

Note: This command requires a /* */ around comments. Refer to “System command formats” on page 168 for further information.

PROD

Displays information about registered products or the product enablement policy.

DISPLAY PROD command

REGISTERED|REG

Displays information about any matching products that have registered as running on the system.

STATE

Displays information about the enablement state, defined in the enablement policy, for any matching products.

STATUS

For the product entry that is the best match for the product you specify, displays information about the enablement policy entry that the system would use if the product attempted to register.

If you specify STATUS, the system does not use wildcard matching; the wildcard characters (* and ?) receive no special treatment.

OWNER(o)

Specifies the owner for the products to be displayed. You can specify wildcard characters (* and ?). The default is OWNER(*), which matches all product owners unless you specified STATUS.

NAME(n)

Specifies the name of the products to be displayed. You can specify wildcard characters (* and ?). The default is NAME(*), which matches all product names unless you specified STATUS.

FEATURENAME(fn)

Specifies the feature name of the products to be displayed. You can specify wildcard characters (* and ?). The default is FEATURENAME(*), which matches all feature names unless you specified STATUS.

ID(i)

Specifies the identifier for the products to be displayed. You can specify wildcard characters (* and ?). The default is ID(*), which matches all product identifiers unless you specified STATUS.

ALL

Specifies that all matching products, including those that registered with Ifaedreg_Type_NoReport, are to be displayed. Unless you specify ALL, products that registered with Ifaedreg_Type_NoReport are not displayed, even if they match the other criteria.

L=a, name, or name-a

Specifies the display area (a), console name (name), or both (name-a) where the display is to appear.

Example 1:

The command produces the output format shown in the following example:

```
D PROD,REG
IFA111I 11.15.28 PROD DISPLAY 358
S OWNER          NAME          FEATURE          VERSION ID
E IBM CORP       z/OS          z/OS             **.**.* 5650-ZOS
E IBM CORP       z/OS          DFSMSTVS        **.**.* 5650-ZOS
E IBM CORP       z/OS          INFOPRINT SERVER **.**.* 5650-ZOS
E IBM CORP       z/OS          JES2            **.**.* 5650-ZOS
E IBM CORP       z/OS          RACF             **.**.* 5650-ZOS
E IBM CORP       z/OS          RMF              **.**.* 5650-ZOS
E IBM CORP       z/OS          Security Server **.**.* 5650-ZOS
E IBM CORP       z/OS          SDSF             **.**.* 5650-ZOS
E IBM CORP       z/OS          TCP/IP BASE     **.**.* 5650-ZOS
```

Displaying entries in the list of APF-authorized libraries

You can use the DISPLAY PROG,APF command to display one or more entries in the list of APF-authorized libraries. (APF means authorized program facility.) Each entry in the APF list display contains:

- An entry number
- The name of an authorized library
- An identifier for the volume on which the authorized library resides (or *SMS*, if the library is SMS-managed).

You can issue the DISPLAY PROG,APF command from a console with INFO authority.

The complete syntax for the DISPLAY PROG,APF command is:

D PROG,APF
<pre>D PROG,APF[,ALL][,L={a name name-a}] ,DSNAME=libname ,ENTRY=xxx ,ENTRY=(xxx-yyy)</pre>

Note: This command requires a /* */ around comments. Refer to “System command formats” on page 168 for further information.

PROG,APF

Displays libraries in the APF list. The parameters that follow this parameter determine the display information. If no parameters follow this parameter, the system displays all libraries in the APF list.

Both DISPLAY PROG,APF and DISPLAY PROG,APF,ALL display *all* libraries in the APF list.

ALL

Displays all libraries in the APF list. Both DISPLAY PROG,APF and DISPLAY PROG,APF,ALL display *all* libraries in the APF list.

L=*a*, *name*, or *name-a*

Specifies the display area (*a*), console name (*name*), or both (*name-a*) where the display is to appear.

DSNAME=*libname*

Displays all entries for this library name. If an asterisk follows *libname*, the system displays all entries for all libraries beginning with *libname*. DSNAME can be an alias for the library name.

This function does not map an alias to the actual library name. Therefore, if you specify an alias, only the entry for the alias is displayed. Similarly, when you specify an actual library name as input, no entries for the library's aliases are displayed.

ENTRY=*xxx*

Displays the library entry for the specified decimal entry number. The order of the libraries in the APF list is not necessarily the order in which they were added. Use this parameter to limit the display to a specific library.

ENTRY=(*xxx-yyy*)

Displays all library entries in the range beginning with decimal entry number *xxx* and ending with decimal entry number *yyy*. The order of the libraries in

DISPLAY PROG,APF command

the APF list is not necessarily the order in which they were added. Use this parameter to limit the display to a subset of the entire list of libraries.

Example:

If you enter the command **D PROG,APF** the output appears in the following format:

```
CSV450I 13.25.02 PROG,APF DISPLAY
FORMAT=DYNAMIC
ENTRY VOLUME DSNAME
  1 580130 SYS1.LINKLIB
  2 580130 SYS1.SVCLIB
  3 617680 SYS1.ACCTG.DATA
  4 *SMS* SYS1.MASAL.JOBS
```

Displaying PROG defaults

You can use the **DISPLAY PROG,DEFAULTS** command to display the default settings that apply to the following statements and commands:

- PROGxx LNKLST statement
- PROGxx LPA statement
- SETPROG LNKLST command
- SETPROG LPA command
- DISPLAY PROG,EXIT command

The syntax for the **DISPLAY PROG,DEFAULTS** command is:

D PROG,DEFAULTS
D PROG,DEFAULTS[,L={a name name-a}]

Note: This command requires a `/* */` around comments. See “System command formats” on page 168 for more information about system command formats.

L=a, name, or name-a

Specifies the display area (*a*), console name (*name*), or both (*name-a*) where the display is to appear.

If you omit this operand, the display is presented in the first available display area or the message area of the console through which you enter the command.

Displaying dynamic exits

Use the **DISPLAY PROG,EXIT** command to display exits that have been defined to the dynamic exits facility or have had exit routines associated with them.

The complete syntax for the **DISPLAY PROG,EXIT** command is:

D PROG,EXIT
<pre>D PROG,EXIT,{{EXITNAME EX EN}=exitname }[,DIAG] {{EXITNAME EX EN}=exitname* } {{MODNAME MOD}=modname } {[ALL][,IMPLICIT],IMP} {[INSTALLATION PROGRAM NOTPROGRAM]} [,L={a name name-a}]</pre>

Note: This command requires a /* */ around comments. Refer to “System command formats” on page 168 for further information.

PROG,EXIT

Displays the names of exits that have been defined to the dynamic exits facility, had exit routines associated with them, or had their attributes changed.

ALL

Displays the names of all the exits that have been defined to the dynamic exits facility, have had exit routines associated with them, or have had their attributes changed.

EXITNAME= or EX= or EN=exitname

Displays the names of all exit routines associated with the named exit, along with status information about the exit. The exit routines are displayed in the order in which they are invoked by dynamic exits services.

If no exit routines are associated with a particular exit, the system issues message CSV463I.

EXITNAME= or EX= or EN=exitname*

Displays the names of exits that both:

- Have a name that matches *exitname*. The trailing asterisk '*' is a wildcard that is used to match patterns.
- Are defined or have had an exit routine associated with them.

DIAG

An optional keyword that specifies diagnostic information for the exit specified by EXITNAME=*exitname*. The CSV464I. The message displays information about the state of the exit, the entry point address of the exit routine, the load point address of the exit routine module, the length of the exit routine module, and jobname. For the sample output, see the following examples.

MODNAME= or MOD=name

Displays the names of the exits with which the specified exit routine is associated. You can use this information before replacing an exit routine to ensure that the exit routine is not defined to any exits.

IMPLICIT or IMP

Displays the names of exits that have been implicitly defined. An exit is implicitly defined when:

- You add exit routines to an exit before the exit is defined
- You set attributes using the ATTRIB parameter of the SETPROG EXIT command before defining the exit.

You can use this parameter to determine whether exit routines were improperly added to an exit that might never be defined. Issue SETPROG EXIT,UNDEFINE,EXITNAME=*exitname* to have the system remove the improper definition of that exit.

DISPLAY PROG,EXIT command

Both IMPLICIT and ALL,IMPLICIT display the names of all the exits that have been implicitly defined.

INSTALLATION

INSTALLATION, or INSTALL, is used to filter the output to list only exits that were defined by CSVDYNEX with EXITTYPE=INSTALLATION.

PROGRAM

Filters the output to list only exits that were defined by CSVDYNEX with EXITTYPE=PROGRAM.

NOTPROGRAM

NOTPROGRAM, or NOTPROG, is used to filter the output to avoid listing exits that were defined by CSVDYNEX with EXITTYPE=PROGRAM.

NOTPROGRAM displays exits that are defined by CSVDYNEX without EXITTYPE or with EXITTYPE=INSTALLATION.

L=*a*, *name*, or *name-a*

Specifies the display area (*a*), console name (*name*), or both (*name-a*) where the display is to appear.

Example 1:

To display exits that have an exit name starting with "IEF", and either are defined or have had an exit routine associated with them, enter:

```
D PROG,EXIT,EXITNAME=IEF*
```

The output appears in the following format:

```
CSV460I 17.01.16 PROG,EXIT DISPLAY 710
EXIT          DEF EXIT          DEF EXIT          DEF
IEF_ALLC_OFFLN  E IEF_SPEC_WAIT  E IEF_VOLUME_ENQ  E
IEF_VOLUME_MNT  E IEFDB401      E
```

Example 2:

To display all exit routines associated with exit SYS.IEFU84 along with status information about the SYS.IEFU84, enter:

```
D PROG,EXIT,EXITNAME=SYS.IEFU84
```

The output appears in the following format:

```
CSV461I 17.04.20 PROG,EXIT DISPLAY 725
EXIT          MODULE  STATE MODULE  STATE MODULE  STATE
SYS.IEFU84    IEFU84   A  MYIEFU84  I
```

Example 3:

To display exit names that are associated with exit routine IEFU84, enter:

```
D PROG,EXIT,MODNAME=IEFU84
```

The output appears in the following format:

```
CSV462I 17.05.33 PROG,EXIT DISPLAY 731
MODULE IEFU84
EXIT(S) SYS.IEFU84      SYSSTC.IEFU84
```

Example 4:

To display information about the exit entry point address, the load point address of the exit routine module, and other diagnostic information for exit routine SYS.IEFU84, enter:

```
D PROG,EXIT,EXITNAME=SYS.IEFU84,DIAG
```

The output appears in the following format:

```
CSV464I 11.45.00 PROG,EXIT DISPLAY
EXIT SYS.IEFU84
MODULE STATE EPADDR LOADPT LENGTH JOBNAME
IEFU84 A 12345678 00000000 00000000 *
```

Displaying LNKLST information

Use the DISPLAY PROG,LNKLST command to display information about the LNKLST set. The command provides information about LNKLST sets for the LNKLST concatenation and associated jobs.

The complete syntax for the DISPLAY PROG,LNKLST command is:

D PROG,LNKLST	
D PROG, LNKLST	[, NAME=[lnklstname CURRENT]]
	[, NAMES]
	[, USERS, [CURRENT NOTCURRENT NAME=lnklstname]]
	[, ASID=asid]
	[, JOBNAME=jobname]
	[, L={a name name-a}]

Note: This command requires a /* */ around comments. Refer to “System command formats” on page 168 for further information.

PROG, LNKLST

Displays information about the LNKLST concatenation and jobs associated with it. When the LNKLST is authorized by default, the APF authorization status provided is only applicable when the data set is referenced independently of the LNKLST. LINKLIST, LINKLST, LNK, or LNKLIST can be specified as an alternative to LNKLST.

NAME=CURRENT

NAME=lnklstname

Displays the data sets for the specified LNKLST set or concatenation.

If you specify CURRENT, the system displays information for the current LNKLST set that has been activated as the LNKLST concatenation.

For *lnklstname*, you must specify a valid 1 to 16 character name of a LNKLST set defined to the system.

Default: NAME=CURRENT is the default. If you omit this parameter, the system displays information for the current LNKLST concatenation.

NAMES

Displays the name of each LNKLST set defined to the system.

USERS, CURRENT

Displays a list of address spaces that use the current LNKLST set.

Default: CURRENT is the default. If you omit this parameter, the system displays a list of address spaces for the current LNKLST set.

DISPLAY PROG,LNKLST command

USERS,NOTCURRENT

Displays a list of address spaces that use any LNKLST set besides the current LNKLST set.

USERS,NAME=*lnklstname*

Displays a list of address spaces that use the LNKLST set specified by **NAME**=*lnklstname*.

For *lnklstname*, you must specify a valid 1 to 16 character name defined of a LNKLST set defined to the system.

ASID=*asid*

Displays the LNKLST set in use by the address space for the specified ASID.

JOBNAME=*jobname*

Displays the LNKLST set in use by the specified job. The system provides information for any job that matches *jobname*. *jobname* can include wildcard characters (* or ?).

L=*a*, *name*, or *name-a*

Specifies the display area (*a*), console name (*name*), or both (*name-a*) where the display is to appear.

Example 1:

To display information for the LNKLST concatenation (defined as LNKLST1 in PROGxx and activated at IPL), enter:

```
D PROG,LNKLST
```

The output appears in the following format. See also message CSV470I.

```
CSV470I 01.00.00
LNKLST DISPLAY
LNKLST SET LNKLST1 LNKAUTH
=APFTAB
ENTRY APF VOLUME DSNAME
1 A DRV602 SYS1.LINKLIB
2 A DRV602 SYS1.MIGLIB
3 A DRV602 SYS1.CSSLIB
4 SMS MY.LINKLIB
```

Example 2:

To display the LNKLST set associated with the job that matches the jobname MYJOB, enter:

```
D PROG,LNKLST,JOBNAME=MYJOB
```

The output appears in the following format:

```
CSV473I 02.15.00 LNKLST DISPLAY
LNKLST SET ASID JOBNAME
MYLNKLST 0018 MYJOB
```

Displaying LPA information

Use the DISPLAY PROG,LPA command to display the entry point, load point, and size of modules in the LPA, and to display the minimum amount of CSA and ECSA that must remain after dynamically adding a module to the LPA.

The complete syntax for the DISPLAY PROG,LPA command is:

D PROG,LPA
D PROG,LPA{,MODNAME=modname} [,L={a name name-a}] {,CSAMIN }

Note: This command requires a /* */ around comments. Refer to “System command formats” on page 168 for further information.

MODNAME=

Displays entry point, load point, and length information about the LPA module. You can use MOD and MODULE as synonyms of MODNAME.

modname

is the 1-8 character LPA module name. If the last character of the modname is an asterisk (*), it will be treated as X'CO'.

CSAMIN

Displays the current CSA and ECSA minimum values.

L=a, name, or name-a

Specifies the display area (*a*), console name (*name*), or both (*name-a*) where the display is to appear.

Displaying the status of the REFRPROT option

Use the DISPLAY PROG,REFRPROT command to display the status of the REFRPROT option. In response, message CSV565I is displayed.

You can issue the DISPLAY PROG,REFRPROT command from a console with INFO authority.

The complete syntax for the DISPLAY PROG,REFRPROT command is:

D PROG,REFRPROT [,L={a name name-a}]

Note: This command requires a /* */ around comments. Refer to “System command formats” on page 168 for further information.

PROG,REFRPROT

Displays the status of the REFRPROT option.

L=a, name, or name-a

Specifies the display area (*a*), console name (*name*), or both (*name-a*) where the display is to appear.

Example:

If you enter the command D PROG,REFRPROT, the output is displayed in the following format:

```
CSV565I REFRPROT IS {IN EFFECT | NOT IN EFFECT}
```

Displaying the status of the TRACKDIRLOAD option

Use the DISPLAY PROG,TRACKDIRLOAD command to display the status of the TRACKDIRLOAD option. In response, message CSV567I is displayed.

DISPLAY PROG,TRACKDIRLOAD command

The complete syntax for the DISPLAY PROG,TRACKDIRLOAD command is:

```
D PROG,TRACKDIRLOAD [,L={a|name|name-a}]
```

L=a, name, or name-a

Specifies the display area (*a*), console name (*name*), or both (*name-a*) where the display is to appear.

Example:

If you enter the command D PROG,TRACKDIRLOAD, the output is displayed in the following format:

```
CSV567I TRACKDIRLOAD IS {IN EFFECT | NOT IN EFFECT}
```

Displaying system requests

Use the following form of the DISPLAY command to display outstanding messages requiring operator action. These messages include WTOR messages, action messages saved by AMRF, action messages issued by the communications task, and action messages that were not displayed on all necessary consoles. You can request that the system display:

- The immediate action messages (descriptor codes 1 or 2), eventual action messages (descriptor code 3), and critical eventual action messages (descriptor code 11)
- The device numbers of devices waiting for mount requests to be fulfilled
- The device numbers of devices waiting for operator intervention
- The status of the action message retention facility
- An alphabetical list of key names of outstanding action messages
- The messages issued by a specified system
- The messages that await operator response at a specified console
- The messages that have specific routing codes

The following list summarizes how to use the operands on the DISPLAY command to retrieve and display information:

- The U operand displays information about devices and units.
- The I, E, CE, R, and M operands display outstanding action messages.
- The LIST, L, ALL, and A operands display combinations of information.
- The KEY operand displays an alphabetical list of key names of outstanding action messages.

The resulting display is described in messages IEE112I (successful result) or IEE312I (unsuccessful result).

Syntax

D R	
D R[,U]
,KEY[,SYS=sysname] [,CN=(ALL)]	
[,I][,msgformat][,MSG=msgid][,SYS=sysname][,KEY=keyname]
[,][,JOB=jobname]
,E	[,CN={name (ALL)}][,ROUT={ALL (rrr[,sss]...)}]
,CE	{(rrr-sss[,rrr-sss]...)}
,R	
,M	
,{LIST L}	
,{ALL A}	
,	
	(See Note)
[,L={a name name-a}]	

Note: If you supply all commas between DISPLAY R and the operands that have equal signs, you get default values. However, supply only one comma before the L operand, even if you omit the preceding operands. For example, DISPLAY R,I,L=RICK-B.

Because TSO consoles in OPERATOR mode do not route messages by console IDs or routing codes, do not use the ROUT or CN operands on DISPLAY R commands issued from these consoles.

Parameters

R

The system is to display information about outstanding action messages (that is, messages with descriptor codes 1, 2, 3, or 11), WTORs, and devices awaiting mount requests to be fulfilled, and units requiring intervention. Information includes either the text of all outstanding action messages and WTORs, a summary of key names associated with the outstanding action messages, or device numbers. The system also displays a number that represents the total of all outstanding WTORs or action messages.

If the issuing console has master authority, the system displays, on the issuing console, all outstanding WTORs. Otherwise, unless you specify the CN parameter on the command, the system displays information about only those messages that appeared on the console that issues the DISPLAY R command.

Consoles of some subsystems, such as NetView®, must specify the CN=(ALL) parameter to ensure displaying all outstanding requests.

Optional subparameters are:

- I** Display the texts and message identification numbers of all outstanding immediate action messages (descriptor codes 1 or 2).
- E** Display the texts and message identification numbers of all outstanding eventual action messages (descriptor code 3).
- CE** Display the texts and identification numbers of all outstanding critical eventual action messages (descriptor code 11).
- R** Display the texts and message identification numbers of all messages awaiting replies (WTORs).

DISPLAY R command

- M** Display the texts and message identification numbers of all immediate action, eventual action, and critical eventual action messages, and messages awaiting replies.

LIST or **L** or **ALL** or **A** or *blank*

Display the texts and message identification numbers of all immediate action, eventual action, and critical eventual action messages and messages awaiting replies. Also display the device numbers of devices with unfulfilled mount requests and any units requiring operator intervention.

- U** Display the device numbers of devices with unfulfilled mount requests and any units requiring operator intervention.

msgformat

Specifies the information that is to accompany messages when they are displayed on a console. The possible values of *msgformat* are:

- J** Display the message text with the job name or job ID of the message issuer. If JES3 is the primary subsystem and is running in XCF-local mode, this option displays the job name, but not the job ID.
- JN** Display the message text with only the job name of the message issuer. If JES3 is the primary subsystem and is running in XCF-local mode, JN has the same effect as J.
- M** Display only the text of each message.
- S** Display the message text, the name of the system that sent the message, and the job name or job ID of the message issuer. If JES3 is the primary subsystem and is running in XCF-local mode, this option displays the jobname, but not the job ID.
- SN** Display the system name and the job name of the message issuer. If JES3 is the primary subsystem and is running in XCF-local mode, SN has the same effect as S.
- T** Display the message text with the time stamp, the name of the system that sent the message, and the jobname or job ID of the message issuer. If JES3 is the primary subsystem and is running in XCF-local mode, this option displays the jobname, but not the job ID.
- TN** Display the message text with the time stamp, the name of the system that sent the message, and the jobname of the message issuer. If JES3 is the primary subsystem and is running in XCF-local mode, TN has the same effect as T.

The format of a message that includes all message format options is:

Time stamp System name Jobname/id Message text

Default: For MCS, HMCS, SMCS and extended MCS consoles, the default message format differs depending on the primary subsystem. If it is JES2, the default format is defined by the MFORM setting for the console. (You can use the CONTROL S command (K S,MFORM) to change the MFORM setting.) If it is JES3, the default message format option is **S**. You can use the CONTROL command to change the default for MCS, HMCS and SMCS consoles.

M is the default message format option for extended MCS consoles. To change the default value for extended MCS consoles, use the RACF command, ALTUSER userid OPERPARM(MFORM(T,S,J,M,X)). See *z/OS Security Server RACF Command Language Reference* for more information.

MSG=msgid

The text of any action message awaiting a reply is to be displayed if the message identifier begins with the one to ten characters specified by *msgid*. Specify a trailing asterisk (*) wildcard to request messages for all message identifiers that match a leading character string.

JOB=jobname

The system requests the messages that are identified by a one to eight-character job name (*jobname*). Specify a trailing asterisk (*) wildcard to request messages for all job names that match a leading character string. For example, enter the following command to display outstanding messages requiring operator action for all job names that begin with the characters TSO1:

```
D R,JOB=TSO1*
```

SYS=sysname

The system is to display messages that have appeared at the system named *sysname* or, if you also specify **KEY**, the key names of messages issued at the system with this name.

If you issue **DISPLAY R,M,SYS=*sysname*** from a console on the JES3 global, you get all messages for the system named *sysname*. (Note that the system retrieves the same information if you issue the **DISPLAY R,L,SYS=*sysname*** command. You cannot retrieve unit information from another system.)

If you issue **DISPLAY R,M** without the **SYS=*sysname*** operand, at an MCS, HMCS or SMCS console that also controls the JES3 global, the system displays all outstanding messages for that system and for the local systems attached to it. If you issue the same command at an MCS, HMCS or SMCS console that also controls a JES3 local or JES2 system, the system displays the messages only for that system.

KEY

The system displays an alphabetical list of key names associated with outstanding messages. The system also displays the total number of messages for each key name.

KEY=keyname

The system requests those messages that are identified by a one to eight-character key name (*keyname*), such as those messages issued by the specified dynamic support program (DSP) of JES3.

KEY=MOUNT

The system displays outstanding tape mount requests.

CN The system displays a set of messages and device numbers of devices awaiting mount requests to be fulfilled, and units requiring intervention, or, if you also specify **KEY**, a list of outstanding key names of messages that appear at a specified console or all consoles. These messages include those directed by routing code and those directed by console ID.

If you omit the **CN** operand, the default is the current console on which you enter the **D R** command.

name

Requests those outstanding action messages that the system directed to the console with the name *name*.

(ALL)

Requests the outstanding action messages that the system directed to all consoles. The parentheses are required.

DISPLAY R command

ROUT

The system displays only the outstanding action messages that have the specified routing codes. The system rejects the ROUT operand if you also request a summary of key names.

ALL

Requests messages with any routing code.

(*rrr*[,*sss*]...)

Requests messages with one or more routing codes.

(*rrr-sss*)[,*(rrr-sss)*]...

Requests messages within a range of routing codes. When you specify a range of routing codes, the first *rrr* in the range must be less than or equal to the second *sss*.

NONE

Requests only those messages that the system directs to the console by console ID.

L=*a*, *name*, or *name-a*

Specifies the display area (*a*), console name (*name*), or both (*name-a*) where the display is to appear.

If you omit this operand, the display is presented in the first available display area or the message area of the console through which you enter the command.

Examples

Example 1:

To display the identification numbers and texts of all unanswered system requests, the device numbers of all devices waiting for mount requests to be fulfilled, and the device numbers of all devices waiting for operator intervention in area A of the console named CON2, enter:

```
D R,L,L=CON2-A or D R,A,L=CON2-A
```

Example 2:

To display the identifications and texts of all unanswered requests for operator action or reply that begin with identifier IEF in the first available area of the console through which the command is entered, enter:

```
D R,MSG=IEF
```

Example 3:

To display the total number (and not the texts) of outstanding action messages, WTORs, devices awaiting mount requests to be fulfilled, and units requiring intervention, enter:

```
D R
```

Example 4:

To display all outstanding action and WTOR messages that have routing codes 1-12, enter:

```
DISPLAY R,M,ROUT=(1-12)
```

If the console is defined to receive, for example, only routing codes 1 and 2, the display includes only messages with those routing codes.

Example 5:

To display a summary of all key names currently active and the number of outstanding messages associated with each key name, enter:

```
DISPLAY R,KEY
```

Example 6:

To display the text of the outstanding message associated with the key name TAPE listed in response to the command in Example 5, enter:

```
DISPLAY R,KEY=TAPE
```

Example 7:

To display the system names, job IDs, and message texts of all messages issued at any system within a JES3 complex, enter from a console with master authority:

```
DISPLAY R,A,S
```

Example 8:

To display all outstanding messages issued on system SY2:

```
DISPLAY R,M,SYS=SY2
```

The system also displays numbers of devices that await mount requests and units requiring intervention.

Example 9:

To display all outstanding messages directed specifically to the console named CON02, excluding messages that were directed to the console by default, enter:

```
DISPLAY R,L,CN=CON02
```

The system also displays numbers of devices that await mount requests and units requiring intervention.

Example 10:

To display all outstanding messages directed specifically to the console named CON04 by any routing code, enter:

```
DISPLAY R,ROUT=ALL    issued from console CON04
```

or

```
DISPLAY R,ROUT=ALL,CN=CON04    issued from another console
```

Example 11:

To display all outstanding messages with their job names, enter:

```
DISPLAY R,L,JN
```

Example 12:

To display all outstanding messages whose job names begin with the characters CICS, enter:

DISPLAY R command

```
DISPLAY R,L,JOB=CICS*  
or  
DISPLAY R,L,JN,JOB=CICS*
```

Displaying resource recovery services (RRS) information

Use the DISPLAY RRS command to display status information about RRS coordinated transactions to the system console and SYSLOG. You can also use automation to parse the output and trigger alerts.

The command supports the following parameters:

- **UR** - Display unit of recovery information, in either summary or detailed format. You can filter the output information with the optional keyword filter parameters.
- **RM** - Display resource manager information, in either summary or detailed format. You can filter the output information with the optional keyword filter parameters.
- **URSTATUS** *or* **URST** - Display unit of recovery information statistics for the local system or the systems specified on the SYSNAME= and GNAME= parameters.
- **UREXCEPTION** *or* **UREX** - Display unit of recovery information for URs that are in exceptions on the local system or the systems specified on the SYSNAME= and GNAME= parameters.

Restrictions:

1. The DISPLAY RRS command is not a performance path.
2. Trying to process more than 1500 URs may exceed the DISPLAY RRS internal work area. When the area is exceeded, the following conditions are expected:
 - D RRS,UR will terminate with:
ATR605I DISPLAY RRS COMMAND TRUNCATED, SOME DATA NOT AVAILABLE
 - D RRS,UREX will process all the data in the work area issuing message ATR624I and will terminate with:
* Data truncated. DISPLAY RRS work area exceeded

or

 - * Data truncated. DISPLAY RRS secondary work area exceeded
 - D RRS,URST is not affected by the number of URs.
3. Trying to process lots of URs may exceed the CONSOLE buffer. Message CNZ3011I will be issued and the output will be truncated when the buffer is exceeded. The number of lines written before truncation is based on a buffer limit specified at IPL in the CONSOLxx member. However, the data will appear in the system log without being truncated.

Syntax

<pre> D RRS D RRS[,UR[,SUMMARY SUM S DETAILED D]uroptions] [,UR[,FAMILY F]urfamoptions] [,RM[,SUMMARY SUM S DETAILED D]rmoptions] [,URSTATUS URSTsysoptions] [,UREXCEPTION UREXsysoptions] [,L=a name name-a] uroptions: [,URID=ur-identifier] [,STATE=FLT SCK PRP DBT CMT BAK END OLA CMP FGT] [,SYSNAME=system-name] [,GNAME=logging-group-name] urfamoptions: [,URID=ur-identifier] [,SYSNAME=system-name] [,GNAME=logging-group-name] rmoptions: [,RMNAME=resource-manager-name] [,SYSNAME=system-name] [,GNAME=logging-group-name] sysoptions: [,SYSNAME=system-name] [,GNAME=logging-group-name] </pre>
--

Parameters

RRS

The system is to display status information about RRS coordinated transactions to the system console and SYSLOG.

UR Indicates that the system is to display information about RRS coordinated transactions.

SUMMARY or SUM or S

Indicates that the system is to use the summary form of the output (ATR601I). The resulting message contains a list of RRS coordinated transactions that were selected through the optional filter parameters.

A summary UR entry includes the following information:

- UR identifier
- System name
- RRS logging group name
- UR state
- UR type - protected or unprotected
- Comment - comments about this UR

DETAILED or D

Indicates that the system is to use the DETAILED form of the output (ATR603I). The resulting message contains detailed information for the particular transaction as indicated by the **URID=** parameter.

With this output form, The **URID=** parameter is required and only one particular UR can be selected (no wildcards are allowed). **SYSNAME** and **GNAME** cannot use wildcards.

A detailed UR entry includes all the information in a summary report, plus the following information:

DISPLAY RRS command

- A list of expression of interests that are associated with the transaction. Each expression of interest includes: URI token, resource manager name, resource manager role, interest type, interest status, interest state, exit status, and duration.

FAMILY or **F**

Indicates that the system is to display the units of recovery (UR) in the cascaded transaction specified as input. See *z/OS MVS System Messages, Vol 3 (ASB-BPX)* for more information about message ATR622I.

RM Indicates that the system is to display information about resource managers that are currently active or were previously active with RRS.

SUMMARY or **SUM** or **S**

Indicates that the system is to use the summary form of the output (ATR602I). The resulting message contains a list of resource managers that were selected through optional keyword filter parameters. A summary RM entry includes the following information:

- Resource manager name
- Resource manager state
- System name
- RRS logging group name

DETAILED or **D**

Indicates that the system is to use the **DETAILED** form of the output (ATR604I). The resulting message contains the detailed information for then specified resource manager as indicated by the **RMNAME=** parameter.

With this output form, the **RMNAME=** parameter is required and only one particular RM can be selected (no wildcards are allowed). **SYSNAME** and **GNAME** can not use wildcards.

A detailed RM entry includes all the information in a summary report, plus the following information:

- RM token
- A list of URs associated with the resource manager. The information displayed for each UR is similar to the UR summary information.

URID=ur-identifier

A UR identifier used to limit the number of URs returned for a UR request. For a **SUMMARY** request, this parameter is optional. If specified, wildcards are allowed (* or ?). If not specified, the UR identifier is not used to filter the returned UR information. For a **DETAILED** request, this parameter is required and can not contain any wildcards.

STATE=FLT|SCK|PRP|DBT|CMT|BAK|END|OLA|CMP|FGT]

The UR state of the URs to be returned. If not specified, URs in any state are returned.

RMNAME=resource-manager-name

A resource manager name used to limit the number of RMs returned for a RM request. For a **SUMMARY** request, this parameter is optional. If specified, wildcards are allowed (* or ?). If not specified, the resource manager name is not used to filter the returned RM information. For a **DETAILED** request, this parameter is required and can not contain any wildcards.

GNAME=logging-group-gname

An RRS logging group name used to limit the amount of returned information. Wildcards (* or ?) are allowed for only the summary form of output. The default is the logging group for the current system.

SYSNAME=system-name

A system name used to limit the amount of returned information. Wildcards (* or ?) are allowed for only the summary form of output. The default is the current system.

URSTATUS or URST

Indicates that the system is to display unit of recovery statistics that includes UR state, UR count, and UR duration time information for in storage URs and does not process any URs found in the log streams. The system is to use message output ATR623I for the information. See *z/OS MVS System Messages, Vol 3 (ASB-BPX)* for more information about message ATR623I.

UREXCEPTION or UREX

Indicates that the system is to display unit of recovery (UR) information for URs that are in exceptions or waiting for a resource. The system is to use message output ATR624I for the information. If the DISPLAY RRS,UREXCEPTION command fails during processing, messages are issued indicating the problem. In such a situation, failure messages prevent the display of any valid information. See *z/OS MVS System Messages, Vol 3 (ASB-BPX)* for more information about message ATR624I.

L=a,name, or name-a

Indicates the display area (**a**), console name (**name**), or both the console name and the display area (**name-a**) where the display will be presented. If you omit this operand, the display is presented in the first available display area or the message area of the console through which you enter the command.

Displaying SLIP trap information

Use the DISPLAY SLIP command to display information about SLIP traps.

```
D SLIP{ [=xxxx] | [,PER] | [,ENIPT] } [,L={a|name|name-a}]
```

SLIP

Indicates that the system is to display summary information about SLIP traps or detailed information about one SLIP trap (message IEE735I).

xxxx

The system is to display detailed information about the SLIP trap associated with the identifier *xxxx*. If you do not specify *xxxx*, the system lists all the SLIP traps in the system and tells whether each trap is enabled or disabled.

Where asterisks replace any or all of the four characters of *xxxx*, the system displays all SLIP traps whose identifiers match the non-asterisk characters in *xxxx*. If you specify fewer than four characters, the *xxxx* is padded on the right with blanks. A matching identifier must have blanks in those positions.

The asterisks allow you to group your SLIP traps by common characters and display them as a group.

DISPLAY SLIP command

PER

This will display the names of the PER traps (or a suitable message if there are none), indicating for each whether it is:

- DISABLED
- ENABLED but IGNORE
- ENABLED and non-IGNORE

ENIPT

This will display the name of the enabled non-ignore PER trap if there is one, and a suitable message if there is not.

L=*a*, *name*, or *name-a*

Specifies the display area (*a*), console name (*name*), or both (*name-a*) where the display is to appear.

If you omit this operand, the display is presented in the first available display area or the message area of the console through which you enter the command.

Example 1:

To display all SLIP traps and whether they are enabled or disabled, enter:

```
DISPLAY SLIP
```

Example 2:

To display detailed information about trap W292, enter:

```
D SLIP=W292
```

Example 3:

To display all SLIP traps with an identifier having 'A' as the first character and 'B' as the third character and identify whether they are disabled or enabled, enter:

```
DISPLAY SLIP=A*B*
```

Example 4:

To display all PER traps, enter:

```
DISPLAY SLIP,PER
```

Displaying SMF data

Use the DISPLAY SMF command to display System Management Facilities (SMF) data.

D SMF
D SMF[, {S O M}] [, L={a name name-a}]

SMF

Indicates that the status of SMF data sets or the SMF options in effect are to be displayed (message IEE967I).

- S** Directs the system to display the names and status of the SMF data sets.
- O** Directs the system to display the current SMF options.

M Directs the system to display information about in-memory resources and connections to them. In response, the system issues the IFA714I message.

L=a, name, or name-a

Specifies the display area (*a*), console name (*name*), or both (*name-a*) where the display is to appear.

If you omit this operand, the display is presented in the first available display area or the message area of the console through which you enter the command.

Displaying the in-storage copy of the SMF limits

Use the DISPLAY SMFLIM command to display the storage limits that are specified in the in-storage copy of the SMFLIMxx parmlib members. This command is particularly helpful when you are debugging issues where a job is canceled or has failed because of out-of-space conditions.

Syntax

D SMFLIM
D SMFLIM[, {S SUMMARY}]
[, {R REGION}]
[, {R REGION}, MEMBER=SMFLIMxx [, RULE=xxxx]]
[, {R REGION}, <i>joboptions</i>]
[, L={a name name-a}]

Parameters

S or SUMMARY

Displays the following information about the in-storage copy of the SMFLIMxx parmlib members:

- Date and time the rules were last modified.
- Number of rules that are active on the system.
- Number of rules that were excluded because of syntax errors or SYSNAME filtering.

R or REGION

Displays information about all the SMFLIM rules that are defined in the in-storage copy of the SMFLIMxx parmlib members. Specify the MEMBER filter or the *joboptions* filters to limit the output to the SMFLIM rules that match the specified filter criteria.

MEMBER=SMFLIMxx

Displays information about all the SMFLIM rules that are defined in the specified parmlib, where *xx* is the two alphanumeric characters indicating the SMFLIMxx parmlib member.

RULE=xxxx

Displays only the specified SMFLIM rule for the specified SMFLIM parmlib member, where *xxxx* represents the one- to four-digit rule number.

joboptions

Displays the SMFLIM rules for the job steps that satisfy the filter criteria. To filter by job step, specify a comma-separated list of one or more of the following filters:

JOBNAME=*jobname* or NOJOBNAME

To add filter criteria for the job name, specify either the JOBNAME or

DISPLAY SMFLIM command

NOJOBNAME keyword. Use the JOBNAME keyword to find rules for a specific job, where *jobname* is the 1- to 8-character job name. Use the NOJOBNAME keyword to display rules where no job name is specified.

STEPACCT=*stepacctinfo* or NOSTEPACCT

To add filter criteria for the step account information, specify either the STEPACCT or NOSTEPACCT keyword. Use the STEPACCT keyword to find rules for a specific step account, where *stepacctinfo* is the 1- to 142-character step account string. Use the NOSTEPACCT keyword to display rules where no step account information is specified.

JOBACCT=*jobacctinfo* or NOJOBACCT

To add filter criteria for the job account information, specify either the JOBACCT or NOJOBACCT keyword. Use the JOBACCT keyword to find rules for a specific job account, where *jobacctinfo* is the 1- to 142-character job account string. Use the NOJOBACCT keyword to display rules where no job account information is specified.

PGMNAME=*pgmname* or NOPGMNAME

To add filter criteria for the program name, specify either the PGMNAME or NOPGMNAME keyword. Use the PGMNAME keyword to find rules for a specific program, where *pgmname* is the 1- to 8-character program name. For the *pgmname*, you can also specify *.DD to match a program referenced by a DD statement, specified in JCL using the PGM=*.stepname.ddname or PGM=*.stepname.procstepname.ddname syntax.

Use the NOPGMNAME keyword to display rules where no program name is specified.

JOBCLASS=*jobclass* or NOJOBCLASS

To add filter criteria for the job class, specify either the JOBCLASS or NOJOBCLASS keyword. Use the JOBCLASS keyword to find rules for a specific job class, where *jobclass* is the 1- to 8-character job class specified by the job entry subsystem that is initiating the job step. Use the NOJOBCLASS keyword to display rules where no job class is specified.

USER=*userid* or NOUSER

To add filter criteria for the user ID, specify either the USER or NOUSER keyword. Use the USER keyword to find rules for a specific user ID, where *userid* is the 1- to 8-character user ID. Use the NOUSER keyword to display rules where no user ID is specified.

L=*a*, *name*, or *name-a*

Specifies the display area (*a*), console name (*name*), or both (*name-a*) where the display is to appear.

If you omit this operand, the display is presented in the first available display area or the message area of the console through which you enter the command.

Examples

Example 1:

To display a summary of the SMFLIM rules specified in the in-storage copy of the SMFLIMxx parmlib members, enter either of the following commands:

```
DISPLAY SMFLIM
DISPLAY SMFLIM,S
```

Figure 30 provides sample output from the DISPLAY SMFLIM,S command.

```
IFA900I 15.15.19 SMF LIMIT DATA 560
SMF LIMIT rules were last set at: 09/17/2015 14.09.54
There are 3 REGION rules active on this system.
0 REGION rules were excluded due to syntax errors.
0 REGION rules were excluded due to SYSNAME filtering.
```

Figure 30. Sample output for the DISPLAY SMFLIM,S command

Example 2:

To display information about all the SMFLIM rules that are defined in the in-storage copy of the SMFLIMxx parmlib members, enter the following command:

```
DISPLAY SMFLIM,R
```

Figure 31 provides sample output from the DISPLAY SMFLIM,R command.

```
IFA900I 15.51.09 SMF LIMIT DATA 614
Member and rule number SMFLIMAA 0001
Jobname:
SAMPLE
Stepacct:
(%)
Stepname:
UNOACCT
Attributes:
EXECUTE: CANCEL
Member and rule number SMFLIMAA 0002
Jobname:
SAMPLE
Stepacct:
<NotSpecified>
()
(A,,B)
(%)
Stepname:
UNOACCT
Attributes:
EXECUTE: CANCEL
Member and rule number SMFLIMCC 0003
Jobname:
SAMPLE
Stepacct:
(./&+'BCE)
(A,,B)
()
Attributes:
EXECUTE: CANCEL
```

Figure 31. Sample output for the DISPLAY SMFLIM,R command

Example 3:

To display rule 1 in the SMFLIMU6 parmlib member, enter the following command:

```
DISPLAY SMFLIM,R,MEMBER=SMFLIMU6,RULE=1
```

DISPLAY SMFLIM command

Figure 32 provides sample output from the DISPLAY SMFLIM,R,MEMBER=SMFLIMU6,RULE=1 command.

```
IFA900I 15.11.45 SMF LIMIT DATA 557
Member and rule number SMFLIMU6 0001
Jobname:
  XTUSI06
Stepacct:
  (%)
Attributes:
  EXECUTE: NOCHANGE
  REGION BELOW: NOLIMIT
  REGION ABOVE: NOLIMIT
  SYSRESVBELOW: 00001M
  SYSRESVABOVE: 00100M
```

Figure 32. Sample output for the DISPLAY SMFLIM,R,MEMBER=SMFLIMU6,RULE=1 command

Example 4:

To display rules where the job name is XTUSI06, but no program name filter is specified for the rule, enter the following command:

```
DISPLAY SMFLIM,R,JOBNAME=XTUSI06,NOPGMNAME
```

Figure 33 provides sample output from the DISPLAY SMFLIM,R,JOBNAME=XTUSI06,NOPGMNAME command.

```
IFA900I 15.49.40 SMF LIMIT DATA 592
Member and rule number SMFLIMU6 0001
Jobname:
  XTUSI06*
Attributes:
  EXECUTE: NOCHANGE
  REGION BELOW: NOLIMIT
  REGION ABOVE: NOLIMIT
  SYSRESVBELOW: 00001M
  SYSRESVABOVE: 00100M
```

Figure 33. Sample output for the DISPLAY SMFLIM,R,JOBNAME=XTUSI06,NOPGMNAME command

Displaying storage management subsystem information

Use the DISPLAY SMS command to display the following kinds of information about the Storage Management Subsystem (SMS):

- Active SMS configuration
- 3990-3 or 3990-6 cache control unit statistics (if the 3990-3 or 3990-6 is installed and has at least one system-managed volume attached)
- Status of system-managed volumes, storage groups, drives, or libraries
- SMS trace options in effect
- SMSVSAM status of sharing control data sets, the SMSVSAM server, data set statistical monitoring, coupling facility cache and lock structures and cache structures that contain data for a specified volume
- CICSVR status of Recovery Control Data sets (RCDSs) and the status of the CICSVR address space.

Storage groups and volumes can be in one of the following states:

- *Not defined* means that the storage group or volume (specified on this command) is specified in the SMS configuration as not being connected to this MVS system.

If the storage group or volume is not defined in the active configuration, a message indicates that the system rejects this command for that reason. If the command is issued for a storage group with no volume, another message indicates the lack of volumes in that group. The symbol for this state is '.'

- *Enabled* means that SMS permits allocation of data sets in this storage group or volume to this MVS system. The symbol for this state is '+'
- *Disabled* means that SMS does not allow allocation of data sets in this storage group or volume for this MVS system. The symbol for this state is '-'
- *Disabled (new only)* means that SMS does not allow allocation of new data sets in this storage group or volume for this MVS system. The symbol for this state is 'D'
- *Quiesce* means that for a data set, SMS selects the specified volume or storage group only if it finds no other choices. The symbol for this state is '*'
- *Quiesce(new)* means that for a new data set, SMS selects the specified volume or storage group only if it has no other choices. The symbol for this state is 'Q'

For a detailed discussion of the DISPLAY SMS command pertaining to optical and tape volumes, libraries, and drives, and the OAM address space, see *z/OS DFSMS OAM Planning, Installation, and Storage Administration Guide for Object Support*, and the *z/OS DFSMS OAM Planning, Installation, and Storage Administration Guide for Tape Libraries*.

DISPLAY SMS command

Syntax

```

D SMS[, {ACTIVE|A} ]
    [, CACHE ]
    [, CFCACHE({structurename|*}) ]
    [, CFLS(ALL|lockstructurename) ]
    [, CFVOL(volid) ]
    [, CICSVR[, {ALL|LOGSTREAMS({LogstreamName|ALL})|RCDS} ]
    [, {DRIVE|DRI}({name|ALL})[ ,STATUS ]
        |,DETAIL ]
    [, DSNAME(dsn){,WTOR} ]
    [, JOB(jobname){,WTOR} ]

    [, {LIBRARY|LIB}({name|ALL})[ ,STATUS[,LISTDRI]]
        |,LISTDRI
        |,DETAIL ]
    [, LOG({logstreamid|ALL}){,WTOR} ]
    [, MONDS({specmask|*}) ]

    [, OAM ]
    [, OPTIONS ]

    [, OSMC[, TASK(name)] ]
    [, {PDSE|PDSE1}{,LATCH(laddr)[,DETAILED]
        |,SUMMARY
        {,MODULE(modname) }
        {,VSTOR }
        {,HSPSTATS[,DSN(dsname)][,STORCLAS(sc)]]
        |,UNMANAGED
        [,SUMMARY ]
        [,MAXDSNS(maxds) ]
        {,CONNECTIONS,DSN(dsname)[,VOL(volser)] } } ]

    [, SEP ]
    [, SHCDS ]
    [, SHUNTED,{SPHERE(sphere)|UR({urid|ALL}){,WTOR} ]

    [, SMSVSAM[,ALL] ]
    [, SMSVSAM,QUIESCE ]

    [, SMSVSAM,DIAG({CONTENTION|C}) ]
    [, {STORGRP|SG}({storgrp|ALERT|ALL})[ ,LISTVOL ]
        |,DETAIL ]
    [, {TRACE|T} ]
    [, TRANSAM[,ALL][,ALLLOGS][,WTOR] ]
    [, URID({urid|ALL}){,WTOR} ]

    [, {VOLUME|VOL}(volume) ]
    [, VOLSELMSG ]
    [, L={a|name|name-a} ]

```

Figure 34. DISPLAY SMS command syntax

Parameters

SMS

Displays information about the Storage Management Subsystem. If SMS is the only operand specified, this command displays the active SMS configuration.

ACTIVE or A

The display includes the names of the three main SMS system data sets

currently in use: the active control data set (ACDS), the communications data set (COMMDS), and the source control data set (SCDS). The display also includes the interval (DINTERVAL), in seconds, that SMS waits between reading device statistics for the 3990-3 control unit. In addition, the display shows the values of the REVERIFY and ACSDEFAULTS parameters in the IGDSMSxx parmlib member.

The display also includes a list of the MVS systems and system groups in the complex. For each system or system group, the display shows a date and time stamp that indicates the level of its SMS configuration, and the synchronizing interval value for its SMS subsystem (not the same as DINTERVAL). This synchronizing interval is the number of seconds that an SMS subsystem delays before synchronizing with the other SMS subsystems in the complex. A longer interval setting enables a slower system to avoid being locked out from accessing the communications data set. For more information on the SMS control data sets, the levels of SMS configuration, and the synchronizing interval, see *z/OS DFSMSdfp Storage Administration*.

CACHE

Displays the following information for each 3990-3 or 3990-6 control unit that has at least one system-managed volume attached to it:

SSID Four-character identifier for the subsystem

SMSCNT

Number of SMS volumes attached to the cache

READ CONTROL

Percentage of reads and non-retentive writes for SMS-controlled data sets that will use the cache

FAST WRITE CONTROL

Percentage of writes with SMS-controlled data that will use the fast write feature

READ HIT RATIO

Percentage of I/O requests that make a hit in the cache

FAST WRITE RATE

Number of DASD fast write bypasses per minute due to non-volatile storage (NVS) overload.

CFCACHE(*structurename* or *)

Displays information about cache structures in the coupling facility. Specify *structurename* to display information for a given structure. Specify '*' to display information for all cache structures.

CFLS[,ALL|*lockstructurename*]

Displays the following information about the coupling facilities lock structure:

- Size
- Status
- Contention rate
- False contention rate

D SMS,CFLS[,ALL] display information for all lock structures known to VSAM RLS including IGWLOCK00.

D SMS,CFLS(*lockstructurename*) returns information for the single lock structure specified. The lock structure name can be specified as IGWLOCK00. Only systems with the multiple lock structure support display information about secondary lock structures.

DISPLAY SMS command

If no lock structure name is specified, IGWLOCK00 is displayed.

CFVOL (*valid*)

Displays a list of coupling facilities cache structures that contain data for the specified volume (*valid*) and the status of the volume.

CICSVR [, {**ALL** | **LOGSTREAMS** (*LogstreamName* | **ALL**) | **RCDS**}]

Displays overall information concerning the CICSVR address space.

- [**ALL**] is specified. The command returns the requested information from all of the active CICSVR address spaces within the sysplex.
- [**LOGSTREAMS**(*LogstreamName* | **ALL**)] allows the operator to view all the logstreams that are currently connected to the CICSVR address space. If **ALL** is specified, the system displays information about all the logstreams in use and known to CICSVR on the system on which the command is issued. If a *LogstreamName* is specified, the system displays only the information regarding that specific logstream.
- [**RCDS**] returns the information about the Recovery Control data sets in the CICSVR address spaces.

DETAIL

Displays detailed status information for tape and optical libraries, tape and optical storage groups and optical drives (in messages CBR1110I, CBR1120I, and CBR1130I).

If you specify a system-managed tape library name, then the system displays more detailed information about the named system-managed tape library. If you issue this command from a TSO/E terminal in OPERATOR mode, you cannot obtain detailed status for optical drives or libraries.

Note: When you specify the **DETAIL** keyword, you cannot specify the **LISTDRI** keyword.

DRIVE (*name* or **ALL**)

Displays system connectivity and the online/offline status of optical drives only. When the drive name is specified, the status for that drive is shown in a single line display. When **ALL** is specified the status for all the optical drives is shown.

To display the status of a drive named **ALL**, place the keyword in double parentheses, as **DRIVE((ALL))**.

Tip: To obtain the online or offline status of devices within a tape library, use the **DISPLAY UNIT**, **DEVSERV** or **LIBRARY DISPDRV** command.

DSNAME (*dsn*)

For a given fully qualified data set name, displays the jobs currently accessing the data set using DFSMS Transactional VSAM Services (DFSMSStvs) access on the systems within the sysplex. If you specify **WTOR**, the system will issue a **WTOR** if the display output exceeds 255 lines.

JOB (*jobname*)

Displays information about a particular job that is using DFSMSStvs services on one of the systems in the sysplex. The output includes:

- The name of the current step within the job
- The current URID for the job
- The status of the unit of recovery (in-reset, in-flight, in-prepare, in-commit, in-backout, indoubt)

If you specify WTOR, the system will issue a WTOR if the display output exceeds 255 lines.

LIBRARY(*name* or ALL)

Displays system connectivity and the online or offline status of the tape and optical libraries. Specify the library name to display the status on a single line for the named library. Specify ALL to display the status for all tape and optical libraries.

If both optical libraries and system-managed tape libraries are defined in the SMS configuration, then the system or system group displays the optical library information followed by the system-managed tape library information.

To display a library named ALL, place the name in double parentheses, as LIBRARY((ALL)).

LISTDRI

Displays the offline or online status for all the optical drives associated with the specified libraries.

Restriction: When you specify the LISTDRI keyword, you cannot specify the DETAIL keyword.

LOG(*logstreamid* or ALL)

Displays information about a log stream that DFSMStvs is currently using on one of the systems in the sysplex. If ALL is specified, information is displayed about all of the logs in use on the entire sysplex. The output includes the status of the log stream (failed or available), type of log (undo, shunt, forward recovery, or log of logs), the job name and URID of the oldest unit of recovery using the log, and a list of all DFSMStvs instances that are using the log. If information about a specific log stream is requested and the log stream is either a system log or a forward recovery log, the output includes the names of the jobs using the log stream.

This command might be issued to determine why a log stream is increasing in size. If a unit of recovery is long running, DFSMStvs would be unable to delete any log blocks that contain data associated with the unit of recovery, which in turn would make truncation of the log stream impossible.

If you specify WTOR, the system will issue a WTOR if the display output exceeds 255 lines.

MONDS(*specmask* or *)

Displays the data set specifications eligible for coupling facilities statistics monitoring. You can specify a full or partial data set name (*specmask*) to view a subset of the data set specifications. You must specify at least one high-level qualifier. A wildcard in the data set name cannot be followed by additional qualifiers.

Specify an asterisk (*) to display all the data set specifications eligible for coupling facilities statistics monitoring.

OAM

If both optical libraries and tape libraries are defined in the SMS configuration, then the system displays the optical library information followed by the tape library information.

Note: This operand is not valid when issued from a TSO/E terminal in OPERATOR mode.

OPTIONS

Displays all of the SMS parameters and their status, and the setting of the

DISPLAY SMS command

FAST_VOLSEL parameter at the time this command is issued. The display indicates whether each option is on or off, what data sets are being used, the size of regions, the time interval for recording data, and all other parameter specifications.

For a description of the output, see message IGD002I.

When DFSMStvs is running on the system, the output of this command includes DFSMStvs-related information.

OSMC

Displays the status of the OAM storage management component (OSMC).

Note: This operand is not valid when issued from a TSO/E terminal in OPERATOR mode.

TASK(name)

Displays the OSMC status for a specific task.

STATUS

Displays online/offline status for tape or optical libraries or optical drives.

{PDSE|PDSE1}, LATCH(laddr), {DETAILED|SUMMARY}

Displays the status of PDSE latch at latch address (*laddr*) for the SMSPDSE or SMSPDSE1 address space. See message IGW045I for information provided by this command.

PDSE Indicates the SMSPDSE address space.

PDSE1

Indicates the SMSPDSE1 address space.

{PDSE|PDSE1}, MODULE(modname)

Displays the address and maintenance level of module name (*modname*) for the SMSPDSE or SMSPDSE1 address space. This command is provided to help users when a SLIP is needed for a particular module. See message IGW046I for information provided by this command.

{PDSE|PDSE1}, VSTOR

Indicates the current PDSE 64-bit directory buffer virtual storage utilization.

The **D SMS, PDSE, VSTOR** or **D SMS, PDSE1, VSTOR** command can display the amount of virtual storage page utilization that is larger than the directory storage size which is defined by the **PDSE_DIRECTORY_STORAGE** or **PDSE1_DIRECTORY_STORAGE** parameter. The **PDSEx_DIRECTORY_STORAGE** value defines the above the bar storage that is used for caching PDSE directory pages. The minimum size for this pool is 64 MB; the default size is 2 GB. The defined value is not a hard limit because heavy periods of PDSE processing requires increasing the pool size. Because PDSE does not compress its internal pools, the pool size reflects a high water mark.

{PDSE|PDSE1}, HSPSTATS[, DSN(dsname)] [, STORCLAS(sc) | UNMANAGED]

Displays the member cache information about SMS-managed PDSE data sets and non-managed PDSE data sets.

HSPSTATS

Displays the member cache information.

DSN(dsname)

An HSPSTATS optional parameter that if specified, indicates that the information is for a specific PDSE, using a fully qualified name, or for a list of PDSEs, using a partially qualified name.

STORCLAS(*sc*)

An HSPSTATS optional parameter that limits the report to SMS-managed PDSE data sets under this storage class. STORCLAS and UNMANAGED parameters cannot be used in the same command.

UNMANAGED

An HSPSTATS optional parameter that limits the report to the data sets that are non-managed PDSEs. STORCLAS and UNMANAGED parameters cannot be used in the same command.

Note:

1. If STORCLAS and UNMANAGED are not specified, the information is for both SMS-managed and non-managed PDSEs.

2. Example of valid names:

IBMUSER.PDSE.DATASET (specific dataset)
 IBMUSER.* (all PDSEs with the high level qualifier of IBMUSER)
 IBMUSER.PDSE.* (all PDSEs starting with IBMUSER.PDSE)

{PDSE|PDSE1}, HSPSTATS [, SUMMARY]

Displays a summary report of the member cache information.

SUMMARY

An HSPSTATS optional parameter that displays only a summary report. SUMMARY parameter cannot be used with the other parameters.

{PDSE|PDSE1}, HSPSTATS [, MAXDSNS(*maxds*)]

Displays the member cache information report to a number of data sets.

MAXDSNS(*maxds*)

An HSPSTATS optional parameter that limits the report to a number of data sets. If specified, the report displays up to this number of data sets. The default is the complete report in a scrollable screen. The maximum number allowed is 9999. MAXDSNS can be used with the different variations of DSN, STORCLAS or UNMANAGED parameters.

{PDSE|PDSE1}, CONNECTIONS, DSN(*dsname*) [, VOL(*volser*)]

Displays the users of a particular PDSE or PDSE1. *volser* specifies the volume required if the data set is not cataloged.

SEP

Displays the name of the active data separation profile.

SHCDS

Displays the following information about the sharing control data sets. (SHCDS):

- Name
- Size
- Amount of free space for the active and spare SHCDS
- Whether the data set is usable

SHUNTED{, SPHERE(*sphere*)|URID({*urid*|ALL})}

Displays the entries currently contained in the shunt logs of the systems in the sysplex. Entries are moved to the shunt log when DFSMStvs is unable to finish processing a syncpoint, for example, due to an I/O error. As long as a shunted entry exists, the locks associated with that entry are retained.

Three types of information that can be displayed in response to this command:

DISPLAY SMS command

- When neither the SPHERE nor URID keyword is specified, this command results in a list of systems in the sysplex and the number of units of recovery which that system has shunted
- When the SPHERE keyword is specified, this command results in a list of shunted work for the sphere specified for all of the systems in the sysplex
- When the URID keyword is specified, this command results in a list of shunted work for the unit of recovery specified for all of the systems in the sysplex. When ALL is specified, this command results in a list of shunted work for all shunted units of recovery for all the systems in the sysplex. To avoid flooding the console, DFSMStvs writes out 255 lines and then issues a WTOR to determine whether or not to continue.

If the error is correctable, the installation might choose to fix the problem and then request that DFSMStvs again attempt processing of the entry by issuing the SHCDS RETRY command. If the data set cannot be restored to a point where it is consistent with the log entry, so that it does not make sense to attempt processing of the log entry again, the installation might choose to discard the log entry by issuing the SHCDS PURGE command.

If you specify WTOR, the system will issue a WTOR if the display output exceeds 255 lines.

SHCDS

Displays the following information about the sharing control data sets. (SHCDS):

- Name
- Size
- Amount of free space for the active and spare SHCDS
- Whether the data set is usable

SMSVSAM [,ALL]

Displays the status of the SMSVSAM server on this system or all the SMSVSAM servers and lock table connection status.

The D SMS,SMSVSAM command displays system connect and quiesce status for all lock structures connected by the system issuing the command.

The D SMS,SMSVSAM, ALL command summarizes the system connect and quiesce status for all lock structures connected in the sysplex. IGWLOCK00 cannot be quiesced.

SMSVSAM, QUIESCE

Displays the status of all active VSAM record-level sharing (VSAM/RLS) sphere quiesce events **on the system that the command is entered**. (This is not a SYSPLEX-wide command.)

SMSVSAM,DIAG(CONTENTION) or SMSVSAM,DIAG(C)

Displays the status of latch contention related to SMSVSAM. Use this command when you suspect that VSAM RLS latch contention is causing a hang or deadlock. For more information about diagnosing VSAM RLS latch contention, refer to VSAM RLS contention in *z/OS DFSMSdfp Diagnosis*.

STATUS

Displays the online or offline status for tape or optical libraries or optical drives.

STORGRP (*storgrp*) or SG (*storgrp*) [,LISTVOL]

Displays the status of the storage group for each MVS system or system group in the SMS complex. If LISTVOL is specified, all the volumes in the storage

group and their SMS status are displayed. The status of the storage group is displayed for each MVS system or system group in the SMS complex.

To display a drive named ALL, place the name in double parentheses, as STORGRP((ALL)) or SG((ALL)).

STORGRP(ALERT) or SG(ALERT) [,LISTVOL]

Display a list of all the pool storage groups in the SMS configuration that have already reached either the total space alert threshold or the track-managed alert threshold on the system at which the command is issued. The list includes the status of each storage group for each MVS system or system group.

If you specify LISTVOL, the system displays the following information:

- A list of volumes in the storage group, giving the status of each volume for each MVS system or system group in the complex.
- The device number of the volume on the system or system group at which the command is issued.

If no storage groups defined in the active configuration has reached either threshold, the system displays an IGD0004I message:

```
IGD0004I NO STORAGE GROUPS HAVE REACHED THEIR
        ALERT THRESHOLDS
```

To display a drive named ALERT or ALL, place the name in double parentheses, for example, STORGRP((ALERT)) or SG((ALERT)).

STORGRP(ALL) or SG(ALL) [,LISTVOL]

Displays a list of all storage groups in the SMS configuration, indicating by symbols (. + - * Q D) the status of each storage group for each MVS system or system group.

If you specify LISTVOL, the system displays the following information:

- A list of volumes in the storage group, giving the status of each volume for each MVS system or system group in the complex.
- The device number of the volume on the system or system group at which the command is issued.

If ALL is specified and no storage groups are defined in the active configuration, the system displays this message:

```
NO STORAGE GROUPS DEFINED IN THE ACTIVE CONFIGURATION
```

To display a drive named ALL, place the name in double parentheses, as STORGRP((ALL)) or SG((ALL)).

TRACE or T

Displays the SMS trace options in effect at the time the command was issued, followed by the setting of the parameters that are related to SMS volume selection analysis messages. The display indicates whether each trace option is now on or off. See message IGD002I.

TRANVSAM [,ALL]

Displays information about the instance of DFSMStvs on this system, or on all systems in the sysplex when the ALL keyword is specified. The output includes this information:

- The activity keypoint (AKP) trigger, which is the number of logging operations between the taking of keypoints
- The status of this instance of DFSMStvs (initializing, active, quiescing, quiesced, disabling, disabled)
- How DFSMStvs started:

DISPLAY SMS command

- Cold start

The log data was not read, and any old data was discarded.

- Warm start

The log data was read and processed.

- DFSMStvs status with respect to resource recovery services (RRS)
- The quiesce timeout value
- All logs known to this instance of DFSMStvs, including the log of logs if one is in use
- The number of active units of recovery
- The status of all known logs associated with this TVS instance, if you specify ALLLOGS. Otherwise, only the UNDO and SHUNT logs are returned

If you specify WTOR, the system will issue a WTOR if the display output exceeds 255 lines.

URID({urid|ALL})

Displays information about a particular unit of recovery currently active within the sysplex or about all units of recovery currently active on the system on which the command was issued on whose behalf DFSMStvs has performed any work. This parameter does not include information about work that has been shunted because you can use the DISPLAY SMS,SHUNTED command to display that information. This parameter also does not include information about units of recovery that might be in restart processing as a result of an earlier failure. This work is not considered to be currently active because it is not associated with any batch job, and the units of recovery associated with the work will end as soon as commit or backout processing for them can be completed. The output includes this information:

- The age of the unit of recovery
- The name of the job with which the unit of recovery is associated
- The name of the current step within the job
- The status of the unit of recovery (in-reset, in-flight, in-prepare, in-commit, in-backout, indoubt)
- The user ID associated with the job

If you specify WTOR, the system will issue a WTOR if the display output exceeds 255 lines.

VOLUME or VOL(*volume*)

For a DASD volume, the system displays detailed status in the pool storage group with respect to the systems or system groups in the complex. The status indication can be NOT DEFINED TO THE SYSTEM, ENABLED, DISABLED, QUIESCED, DISABLED FOR NEW ALLOCATIONS ONLY, or QUIESCED FOR NEW ALLOCATIONS ONLY. The display also gives the device number of the device on which the volume is mounted. This occurs only on the system or system group at which the command is issued.

For an optical volume, the system displays (in message CBR1140I) detailed status from the optical configuration database.

For a system-managed tape volume, the system displays (in message CBR1180I) detailed status from the tape configuration database.

If the specified volume is not system managed, this message is issued:

```
COMMAND REJECTED; VOLUME volume IS NOT DEFINED
```

To display a volume named ALL, place the name in double parentheses, as VOLUME((ALL)) or VOL((ALL)).

VOLSELMSG

Displays the setting of the parameters that are related to SMS volume selection analysis messages, followed by the setting of parameters that are related to SMS trace.

L=*a*, *name*, or *name-a*

Specifies the display area (*a*), console name (*name*), or both (*name-a*) where the display is to appear.

If you omit this operand, the display is presented in the first available display area or the message area of the console through which you enter the command.

Examples

Example 1:

Either of the following commands displays the active SMS configuration:

```
d sms
```

```
d sms,a
```

In this example, three MVS systems are defined to SMS, but only the first two systems have an active Storage Management Subsystem. The third system is either not IPLed or was IPLed without starting SMS.

The response to this command is as follows:

```
IGD002I 10:13:25 DISPLAY SMS 050
SCDS = STAGE2.SCDSPLEX.DATA
ACDS = SYS1.PDSESHR.ACDS
COMMDS = SYS1.PDSESHR.COMMDS
DINTERVAL = 150
REVERIFY = NO
ACSDEFAULTS = YES
SYSTEM CONFIGURATION LEVEL INTERVAL SECONDS
SYSTEM1 2005/03/18 10:13:10 15
SYSTEM2 ----- N/A
SYSTEM3 ----- N/A
SYSTEM4 ----- N/A
SYSTEM5 ----- N/A
SYSTEM6 ----- N/A
SYSTEM7 ----- N/A
SYSTEM8 ----- N/A
```

Example 2:

To display the name of the active data separation file, enter:

```
d sms,sep
```

In response to this command, the system issues message IGD002I:

```
IGD002I 09:59:03 DISPLAY SMS 047
ACTIVE DATA SET SEPARATION PROFILE NAME: sep_dsname
```

If there are no active separation profile, the system issues message IGD002I as:

```
IGD002I 09:59:03 DISPLAY SMS 047
NO DATA SET SEPARATION PROFILE IS ACTIVE
```

Example 3:

DISPLAY SMS command

To display the status of the storage group **sgmixed**, enter:

```
d sms,sg(sgmixed)
```

The response to this command is as follows:

```
IGD002I 11:50:52 DISPLAY SMS 448
STORGRP  TYPE                                SYSTEM= 1 3 4 5 6 7 8
SGMIXED  TYPE                                + . . . . .
***** LEGEND *****
. THE STORAGE GROUP OR VOLUME IS NOT DEFINED TO THE SYSTEM
+ THE STORAGE GROUP OR VOLUME IS ENABLED
- THE STORAGE GROUP OR VOLUME IS DISABLED
* THE STORAGE GROUP OR VOLUME IS QUIESCED
D THE STORAGE GROUP OR VOLUME IS DISABLED FOR NEW ALLOCATIONS ONLY
Q THE STORAGE GROUP OR VOLUME IS QUIESCED FOR NEW ALLOCATIONS ONLY
SYSTEM 1 = SYSTEM1
IEF196I IEF285I  SYS2.LINKLIB                      KEPT
IEF196I IEF285I  VOL SER NOS= MVSRES.
```

Example 4:

To display storage group **group26**, showing the states of all its volumes, enter:

```
d sms,storgrp(group26),listvol
```

The output from this command is similar to that of the previous example except that the specific volumes defined to each system are listed.

```
IGD002I 11:51:34 DISPLAY SMS 453
STORGRP  TYPE                                SYSTEM= 1 7 8
GROUP26  OBJECT                              + .
LISTVOL IS IGNORED FOR OBJECT, OBJECT BACKUP, AND TAPE STORAGE GROUPS STORGRPNAME
***** LEGEND *****
. THE STORAGE GROUP OR VOLUME IS NOT DEFINED TO THE SYSTEM
+ THE STORAGE GROUP OR VOLUME IS ENABLED
- THE STORAGE GROUP OR VOLUME IS DISABLED
* THE STORAGE GROUP OR VOLUME IS QUIESCED
D THE STORAGE GROUP OR VOLUME IS DISABLED FOR NEW ALLOCATIONS ONLY
Q THE STORAGE GROUP OR VOLUME IS QUIESCED FOR NEW ALLOCATIONS ONLY
SYSTEM 1 = SYSTEM1
```

Example 5:

To illustrate the display of trace options, assume that the following two commands have been issued for system MVS3:

```
SETSMS TRACE(ON),SIZE(128K),TYPE(ERROR),JOBNAME(*)
SETSMS DESELECT(ALL),SELECT(ACSINT,CONF,MSG),ASID(*)
```

The first command turns on tracing and sets the trace table size to 128KB. The second command turns off all trace options except for the three options indicated. To display the SMS trace options now in effect, enter:

```
DISPLAY SMS,TRACE
```

The output from this command is similar to that shown below. Note that the trace is shown to be *on*, the trace table size is indicated, and all options are shown to be *off* except for the three turned *on* by the SETSMS...,SELECT command.

```
IGD002I 10:34:39 DISPLAY SMS 053
TRACE = ON SIZE = 128K TYPE = ERROR
JOBNAME = * ASID = *
TRACING EVENTS:
MODULE = ON SMSSJF = ON SMSSSI = ON ACSINT = ON
OPCMD = ON CONF = ON CDSC = ON CONFS = ON
MSG = ON ERR = ON CONFR = ON CONFA = ON
```

```

ACSPRO = ON IDAX = ON DISP = ON CATG = ON
VOLREF = ON SCHEDP = ON SCHEDS = ON
VTOCL = ONVTOCD = ON VTOCR = ON VTOCC = ON VTOCA = ON
RCD = ON DCF = ON DPN = ON TVR = ON
DSTACK = ON UAFF = ON VOLSELMSG = (OFF,0) TYPE = ERROR JOBNAME = *
ASID = * STEPNAME = *
DSNAME = *

```

Example 6:

To display the SMS options now in effect, enter:

```
12.16.35          d sms,options
```

The output from this command is similar to the following output.

```

IGD002I 09:28:44 DISPLAY SMS 133
ACDS      = SYS1.PDSESHR.ACDS
COMMDS    = SYS1.PDSESHR.COMMDS
ACDS LEVEL = z/OS V2.1
SMS PARMLIB MEMBER NAME = IGDMSZV
INTERVAL = 15          DINTERVAL = 150
SMF_TIME = YES        CACHETIME = 3600
CF_TIME = 3600        PDSE_RESTARTABLE_AS = YES
PDSE_BMFTIME = 3600   PDSE1_BMFTIME = 3600
PDSE_LRUTIME = 60     PDSE1_LRUTIME = 60
PDSE_LRUCYCLES = 15   PDSE1_LRUCYCLES = 15
LOCAL_DEADLOCK = 15   GLOBAL_DEADLOCK = 4
REVERIFY = NO         DSNTYPE = LIBRARY
ACSDFAULTS = YES     PDSESHARING = EXTENDED
OVRD_EXPDT = NO      SYSTEMS = 8
PDSE_HSP_SIZE = 8MB  PDSE1_HSP_SIZE = 64MB
USE_RESOWNER = YES   RLS_MAX_POOL_SIZE = 100MB
RLSINIT = YES        RLSTMOUT = 500
COMPRESS = GENERIC   LOG_OF_LOGS = IGWTVS1.LOG.OF.LOGS
QTIMEOUT = 400       TVSNMAME = 001
AKP = 200            TV_START_TYPE = WARM
MAXLOCKS = (100,50)
CICSVR_INIT = NO     CICSVR_DSNAME_PREFIX = DWW.
CICSVR_RCDS_PREFIX = DWW
CICSVR_GRPNAME_SUFFIX = PROD
CICSVR_ZZVALUE_PARM =
CICSVR_UNDOLOG_CONTROL =
CICSVR_UNDOLOG_PREFIX = DWW
CICSVR_BACKOUT_CONTROL =
CICSVR_GENERAL_CONTROL =
IGD002I 09:28:44 DISPLAY SMS
R1s_MaxCfFeatureLevel = A
R1sAboveThebarMaxPoolSize = 1000 R1sFixedPoolSize = 0
PDSE_MONITOR = (YES,0,0) PDSE1_MONITOR = (YES,0,0)
PDSE_DIRECTORY_STORAGE = 2000M PDSE1_DIRECTORY_STORAGE = 2000M
PDSE_BUFFER_BEYOND_CLOSE = YES PDSE1_BUFFER_BEYOND_CLOSE = YES
GDS_RECLAIM = YES    DSSTIMEOUT = 0
BLOCKTOKENSIZE = NOREQUIRE FAST_VOLSEL = OFF
USEEAV = YES         BREAKPOINTVALUE = 10
OAMPROC =            SUPPRESS_DRMGS = NO
OAMTASK =            PDSE_SYSEVENT_DONTSWAP = NO
DB2SSID = DBG1      SAM_USE_HPF = YES
CA_RECLAIM = DATACLAS
PS_EXT_VERSION = 1
IGD002I 09:28:44 DISPLAY SMS
TRACE     = ON      SIZE = 128K    TYPE = ERROR
JOBNAME = *        ASID = *
TRACING EVENTS:
MODULE = ON  SMSSJF = ON  SMSSSI = ON  ACSINT = ON
OPCMD = ON  CONFC = ON  CDSC = ON  CONFS = ON
MSG = ON  ERR = ON  CONFR = ON  CONFA = ON
ACSPRO = ON  IDAX = ON  DISP = ON  CATG = ON
VOLREF = ON  SCHEDP = ON  SCHEDS = ON  VTOCL = ON
VTOCD = ON  VTOCR = ON  VTOCC = ON  VTOCA = ON
RCD = ON  DCF = ON  DPN = ON  TVR = ON
DSTACK = ON  UAFF = ON  DEBUG = ON
VOLSELMSG = (OFF,0) TYPE = ERROR  JOBNAME = *
ASID = * STEPNAME = *
DSNAME = *

```

Example 7:

The DISPLAY SMS,TRANVSAM command displays information about the status of DFSMStvs.

DISPLAY SMS command

If DFSMStvs is not active, this results in:

```
IGW800I DFSMS VSAMRLS REQUEST TO DISPLAY TRANSACTIONAL VSAM INFORMATION
IS REJECTED: TRANSACTIONAL VSAM IS NOT ACTIVE ON THIS SYSTEM
```

If DFSMStvs is active, this command results in the following output:

```
D SMS,TRANVSAM
IEE932I 774
IGW800I 13.33.01 DISPLAY SMS,TRANSACTIONAL VSAM
DISPLAY SMS,TRANSACTIONAL VSAM - SERVER STATUS
System   TVSNAME  State  Rrs   #Urs   Start   AKP   QtimeOut
-----
SYSTEM1  IGWTV001 ACTIVE REG           1 WARM/WARM   200   400
DISPLAY SMS,TRANSACTIONAL VSAM - LOGSTREAM STATUS
LogStreamName      State   Type      Connect Status
-----
IGWTV001.IGWLOG.SYSLOG   Enabled  UnDoLog   Connected
IGWTV001.IGWSHUNT.SHUNTLOG Enabled  ShuntLog  Connected
IGWTVS1.LOG.OF.LOGS     Enabled  LogOfLogs Connected
IGWTVS.FR.LOG001        Enabled  FrLog     Connected
```

Example 8:

To display information about DFSMStvs, enter this command:

```
D SMS,TRANVSAM,ALL
```

The output from this command

```
D SMS,TRANVSAM,ALL
IEE932I 777
IGW800I 13.33.12 DISPLAY SMS,TRANSACTIONAL VSAM,ALL
DISPLAY SMS,TRANSACTIONAL VSAM,ALL - SERVER STATUS
System   TVSNAME  State  Rrs   #Urs   Start   AKP   QtimeOut
-----
SYSTEM1  IGWTV001 ACTIVE REG           1 WARM/WARM   200   400
SYSTEM2  IGWTV002 ACTIVE REG           0 WARM/WARM   200   400
DISPLAY SMS,TRANSACTIONAL VSAM,ALL LOGSTREAM STATUS
LogStreamName: IGWTV001.IGWLOG.SYSLOG
System   TVSNAME      State   Type      Connect Status
-----
SYSTEM1  IGWTV001      Enabled  UnDoLog   Connected
LogStreamName: IGWTV001.IGWSHUNT.SHUNTLOG
System   TVSNAME      State   Type      Connect Status
-----
SYSTEM1  IGWTV001      Enabled  ShuntLog  Connected
LogStreamName: IGWTVS1.LOG.OF.LOGS
System   TVSNAME      State   Type      Connect Status
-----
SYSTEM1  IGWTV001      Enabled  LogOfLogs Connected
SYSTEM2  IGWTV002      Enabled  LogOfLogs Connected
LogStreamName: IGWTV002.IGWLOG.SYSLOG
System   TVSNAME      State   Type      Connect Status
-----
SYSTEM2  IGWTV002      Enabled  UnDoLog   Connected
LogStreamName: IGWTV002.IGWSHUNT.SHUNTLOG
System   TVSNAME      State   Type      Connect Status
-----
SYSTEM2  IGWTV002      Enabled  ShuntLog  Connected
LogStreamName: IGWTVS.FR.LOG001
System   TVSNAME      State   Type      Connect Status
-----
SYSTEM1  IGWTV001      Enabled  FrLog     Connected
```

Example 9:

The DISPLAY SMS,JOB command displays information about the status of a job.

If the job is using DFSMStvs services, this command results in the following output:

```
D SMS,JOB(TVS30601)
IEE932I 780
IGW801I 13.33.27 DISPLAY SMS,JOB
TRANSACTIONAL VSAM Job Status On System: SYSTEM1
JobName  StepName  Urid                               Ur Status  # Locks
-----
TVS30601 STEP04   B4E070267EAFD000000000301010000  IN_FLIGHT  20
```

Example 10:

The DISPLAY SMS,UR command displays information about a particular unit of recovery on whose behalf DFSMStvs has performed any work.

If the unit of recovery is not active, this command results in the following output:

```
IGW802I DFSMS REQUEST TO DISPLAY ACTIVE TRANSACTIONAL VSAM UR(s)
WAS REJECTED, SPECIFIED URID(s) ARE NOT ACTIVE
ON ANY TRANSACTIONAL VSAM INSTANCE IN THE SYSPLEX.
```

If the UR is currently active, this command results in the following output:

```
D SMS,URID(ALL)
IEE932I 783
IGW802I 13.33.39 DISPLAY SMS,URID
TRANSACTIONAL VSAM UrId Status For System: SYSTEM1
Urid                               Ur Status  JobName  StepName # Locks
-----
B4E070267EAFD000000000301010000  InFlight   TVS30601 STEP04  20
```

Example 11:

Use the DISPLAY SMS,SHUNTED command to display information about URs currently in the DFSMStvs shunt log.

If there is currently no shunted work, the results are as follows:

```
IGW803I 09.50.47 DISPLAY SMS,UR (Summary Data)
SysName  # Urid(s) SysName  # Urid(s) SysName  # Urid(s)
-----
SYSTEM1  0          -----  0          -----  0
```

If there are shunted URs,the results are as follows:

```
IGW803I 09.50.47 DISPLAY SMS,UR (Summary Data)
SysName  # Urid(s) SysName  # Urid(s) SysName  # Urid(s)
-----
SYSTEM1  urid      -----  0          -----  0
```

Example 12:

Use the DISPLAY SMS,LOG command to display information about the log streams that DFSMStvs is using.

If the log stream is not currently in use by DFSMStvs, this command results in the following output:

```
IGW804I DFSMS REQUEST TO DISPLAY
TRANSACTIONAL VSAM LOG STREAM: logstream WAS REJECTED.

LOG STREAM NOT KNOWN TO DFSMS.
```

DISPLAY SMS command

If the log stream is currently in use, this command results in the following output:

```
D SMS,LOG(IGWTVS.FR.LOG001)
IEE932I 789
IGW804I 13.34.10 DISPLAY SMS,LOG
DISPLAY SMS,LOG - LOG STREAM STATUS
  Name: IGWTVS.FR.LOG001      State: Enabled      Type: FrdRecovr
System  TVSNAMES  JobName  Urid of Oldest Log Block
-----
SYSTEM1 IGWTV001 TVS30601 B4E070267EAFD0000000000301010000*
DISPLAY SMS,LOG - LOG STREAM USAGE
  LogStreamName: IGWTVS.FR.LOG001
System  TVSNAMES  JobName  JobName  JobName  JobName  JobName
-----
SYSTEM1 IGWTV001 TVS30601
*OLDEST URID ACROSS ALL SYSTEMS IN THE SYSPLEX
```

Example 13:

The DISPLAY SMS,LOG(ALL) command displays information about log streams that DFSMStvs is using.

```
D SMS,LOG(ALL)
```

This command results in the following output:

```
IEE932I 792
IGW804I 13.34.18 DISPLAY SMS,LOG
DISPLAY SMS,LOG - LOG STREAM STATUS
  Name: IGWTVS.FR.LOG001      State: Enabled      Type: FrdRecovr
System  TVSNAMES  JobName  Urid of Oldest Log Block
-----
SYSTEM1 IGWTV001 TVS30601 B4E070267EAFD0000000000301010000*
DISPLAY SMS,LOG - LOG STREAM USAGE
  LogStreamName: IGWTVS.FR.LOG001
System  TVSNAMES  JobName  JobName  JobName  JobName  JobName
-----
SYSTEM1 IGWTV001 TVS30601
*OLDEST URID ACROSS ALL SYSTEMS IN THE SYSPLEX
DISPLAY SMS,LOG - LOG STREAM STATUS
  Name: IGWTVS1.LOG.OF.LOGS    State: Enabled      Type: LogOfLogs
System  TVSNAMES  JobName  Urid of Oldest Log Block
-----
SYSTEM1 IGWTV001 TVS30601 B4E070267EAFD0000000000301010000*
DISPLAY SMS,LOG - LOG STREAM USAGE
  LogStreamName: IGWTVS1.LOG.OF.LOGS
System  TVSNAMES  JobName  JobName  JobName  JobName  JobName
-----
SYSTEM1 IGWTV001 TVS30601
*OLDEST URID ACROSS ALL SYSTEMS IN THE SYSPLEX
DISPLAY SMS,LOG - LOG STREAM STATUS
  Name: IGWTV001.IGWLOG.SYSLOG State: Enabled      Type: UnDo
System  TVSNAMES  JobName  Urid of Oldest Log Block
-----
SYSTEM1 IGWTV001 TVS30601 B4E070267EAFD0000000000301010000*
DISPLAY SMS,LOG - LOG STREAM USAGE
  LogStreamName: IGWTV001.IGWLOG.SYSLOG
System  TVSNAMES  JobName  JobName  JobName  JobName  JobName
-----
SYSTEM1 IGWTV001 TVS30601
*OLDEST URID ACROSS ALL SYSTEMS IN THE SYSPLEX
DISPLAY SMS,LOG - LOG STREAM STATUS
  Name: IGWTV001.IGWSHUNT.SHUNTLOG State: Enabled      Type: Shunt
System  TVSNAMES  JobName  Urid of Oldest Log Block
-----
SYSTEM1 IGWTV001 ----- NO ACTIVE UR -----*
```

```

DISPLAY SMS,LOG      - LOG STREAM USAGE
  LogStreamName: IGWTV001.IGWSHUNT.SHUNTLOG
System  TVSNAM  JobName  JobName  JobName  JobName  JobName
-----
SYSTEM1  IGWTV001  **NONE**
*OLDEST URID ACROSS ALL SYSTEMS IN THE SYSPLEX

DISPLAY SMS,LOG      - LOG STREAM STATUS
  Name: IGWTVS1.LOG.OF.LOGS      State: Enabled      Type: LogOfLogs
System  TVSNAM  JobName  Urid of Oldest Log Block
-----
SYSTEM2  IGWTV002                ----- NO ACTIVE UR -----*
DISPLAY SMS,LOG      - LOG STREAM USAGE
  LogStreamName: IGWTVS1.LOG.OF.LOGS
System  TVSNAM  JobName  JobName  JobName  JobName  JobName
-----
SYSTEM2  IGWTV002  **NONE**
*OLDEST URID ACROSS ALL SYSTEMS IN THE SYSPLEX
DISPLAY SMS,LOG      - LOG STREAM STATUS
  Name: IGWTV002.IGWLOG.SYSLOG    State: Enabled      Type: UnDo
System  TVSNAM  JobName  Urid of Oldest Log Block
-----
SYSTEM2  IGWTV002                ----- NO ACTIVE UR -----*
DISPLAY SMS,LOG      - LOG STREAM USAGE
  LogStreamName: IGWTV002.IGWLOG.SYSLOG
System  TVSNAM  JobName  JobName  JobName  JobName  JobName
-----
*OLDEST URID ACROSS ALL SYSTEMS IN THE SYSPLEX
DISPLAY SMS,LOG      - LOG STREAM STATUS
  Name: IGWTV002.IGWSHUNT.SHUNTLOG State: Enabled      Type: Shunt
System  TVSNAM  JobName  Urid of Oldest Log Block
-----
SYSTEM2  IGWTV002                ----- NO ACTIVE UR -----*
DISPLAY SMS,LOG      - LOG STREAM USAGE
  LogStreamName: IGWTV002.IGWSHUNT.SHUNTLOG
System  TVSNAM  JobName  JobName  JobName  JobName  JobName
-----

```

Example 14:

The DISPLAY SMS,DSNAME command displays information about the jobs that have a data set open for DFSMStvs access.

If the data set is not currently open for DFSMStvs access, this command results in the following output:

```

IGW805I DFSMS REQUEST TO DISPLAY TRANSACTIONAL VSAM USAGE OF
DATASET: dsname WAS REJECTED.

DATASET NOT KNOWN TO TRANSACTIONAL VSAM.

```

If the data set is currently open for DFSMStvs access, this command results in the following output:

```

D SMS,DSNAME(SYSPLEX.SHCD.SUND01.KSDS01)
IEE932I 795
IGW805I 13.34.44 DISPLAY SMS,DSNAME
DATASET: SYSPLEX.SHCD.SUND01.KSDS01
IS CURRENTLY IN USE BY THE FOLLOWING JOBS:

System Name: SYSTEM1 TVSNAM: IGWTV001
JobNames: TVS30601

```

Example 15:

DISPLAY SMS command

The DISPLAY SMS,OPTIONS command displays the values with which SMS, SMSVSAM, and DFSMSStvs are currently operating.

This command results in the following output:

```
D SMS,OPTIONS
IGD002I 13:01:52 DISPLAY SMS 918
ACDS = SYS1.PDSESHR.ACDS
COMMDS = SYS1.PDSESHR.COMMDS
INTERVAL = 15 DINTERVAL = 150
SMF_TIME = YES CACHETIME = 3600
CF_TIME = 3600 PDSE_RESTARTABLE_AS = YES
PDSE_BMFTIME = 3600 PDSE1_BMFTIME = 3600
PDSE_LRUTIME = 60 PDSE1_LRUTIME = 60
PDSE_LRUCYCLES = 15 PDSE1_LRUCYCLES = 15
LOCAL_DEADLOCK = 15 GLOBAL_DEADLOCK = 4
REVERIFY = NO DSNTYPE = LIBRARY
ACSDEFAULTS = YES PDSESHARING = EXTENDED
OVRD_EXPDT = NO SYSTEMS = 8
PDSE_HSP_SIZE = 256MB PDSE1_HSP_SIZE = 256MB
USE_RESOWNER = YES RLS_MAX_POOL_SIZE = 100MB
RLSINIT = YES RLSTMOUT = 500
COMPRESS = GENERIC LOG_OF_LOGS = IGWTVS1.LOG.OF.LOGS
QTIMEOUT = 400 TVSNMAME = 001
AKP = 200 TV_START TYPE = WARM
MAXLOCKS = (100,50)
CICSVR_INIT = NO CICSVR_DSNAME_PREFIX = DWW.
CICSVR_RCDS_PREFIX = DWW
CICSVR_GRPNAME_SUFFIX = PROD
CICSVR_ZZVALUE_PARM =
CICSVR_UNDOLOG_CONTROL =
CICSVR_UNDOLOG_PREFIX = DWW
CICSVR_BACKOUT_CONTROL =
CICSVR_GENERAL_CONTROL =
Rls_MaxCfFeatureLevel = A
RlsAboveThebarMaxPoolSize = 0
RlsFixedPoolSize = 0
PDSE_MONITOR = (YES,0,0) PDSE1_MONITOR = (YES,0,0)
PDSE_BUFFER_BEYOND_CLOSE = NO
PDSE1_BUFFER_BEYOND_CLOSE = NO
GDS_RECLAIM = YES DSSTIMEOUT = 0
BLOCKTOKENSIZE = REQUIRE
IGD002I 13:01:52 DISPLAY SMS
TRACE = ON SIZE = 128K TYPE = ERROR
JOBNAME = * ASID = *
TRACING EVENTS:
MODULE = ON SMSSJF = ON SMSSSI = ON ACSINT = ON
OPCMD = ON CONFC = ON CDSC = ON CONFS = ON
MSG = ON ERR = ON CONFR = ON CONFA = ON
ACSPRO = ON IDAX = ON DISP = ON CATG = ON
VOLREF = ON SCHEDP = ON SCHEDS = ON VTOCL = ON
VTOCD = ON VTOCR = ON VTOCC = ON VTOCA = ON
RCD = ON DCF = ON DPN = ON TVR = ON
DSTACK = ON UAFF = ON VOLSELMSG = (OFF,0) TYPE = ERROR JOBNAME = *
ASID = * STEPNAME = *
DSNAME = *
```

Example 16:

To display the setting of the parameters that are related to SMS volume selection analysis messages, enter:

```
D SMS,VOLSELMSG
```

The response to this command is as follows:

```
IGD002I 13:58:46 DISPLAY SMS 789
VOLSEMSG = (OFF,0) TYPE = ERROR JOBNAME = *
ASID = * STEPNAME = *
DSNAME = *
TRACE = ON SIZE = 128K TYPE = ERROR
JOBNAME = * ASID = *
```

Example 17:

The D SMS,SMSVSAM and D SMS,SMSVSAM,ALL commands display lock structure connect status.

To display the system connect and quiesce status for all lock structures connected by the system issuing the command, enter:

```
D SMS,SMSVSAM
```

The response to this command is as follows:

```
IEE932I 847
IGW420I DISPLAY SMS,SMSVSAM
DISPLAY SMS,SMSVSAM - SERVER STATUS
SYSNAME: SYSTEM1 AVAILABLE ASID: 0037 STEP: SmsVsamInitComplete
DISPLAY SMS,SMSVSAM - JOB STATUS
SUBSYSTEMS CONNECTED: 2 BATCH: 2
DISPLAY SMS,SMSVSAM - LOCK TABLE STATUS (IGWLOCK00)
CONNECT STATUS:
SYSNAME: SYSTEM1 ACTIVE RSN: 02010407 RbldNotActive
COMPOSITE STATUS:
ORIGINAL STRUCTURE: NOT VOLATILE FAILURE ISOLATED
NEW STRUCTURE: NOT VOLATILE FAILURE ISOLATED
STRUCTURE STATUS:
SYSNAME: SYSTEM1 Duplex
SECONDARY LOCK TABLE STATUS (TESTLOCK1)
CONNECT STATUS:
SYSNAME: SYSTEM1 ACTIVE RSN: 02010407 RbldNotActive
COMPOSITE STATUS:
ORIGINAL STRUCTURE: NOT VOLATILE FAILURE ISOLATED
NEW STRUCTURE: NOT VOLATILE FAILURE ISOLATED
STRUCTURE STATUS:
SYSNAME: SYSTEM1 NOTCONN
```

To display the system connect and quiesce status for all lock structures connected in the sysplex, enter:

```
D SMS,SMSVSAM,ALL
```

The response to this command is as follows:

```
DISPLAY SMSVSAM - LOCK TABLE STATUS (TESTLOCK1)
CONNECT STATUS:
SYSNAME: SYSTEM2 ACTIVE RSN: 02010407 RbldNotActive
SYSNAME: SYSTEM1 ACTIVE RSN: 02010407 RbldNotActive
SYSNAME: SYSTEM3 ACTIVE RSN: 02010407 RbldNotActive
SYSNAME: ..... RSN: .....
SYSNAME: ..... RSN: .....
SYSNAME: ..... RSN: .....
SYSNAME: ..... RSN: .....
SYSNAME: ..... RSN: .....
COMPOSITE STATUS:
ORIGINAL STRUCTURE: NOT VOLATILE FAILURE ISOLATED
NEW STRUCTURE: NOT VOLATILE FAILURE ISOLATED
STRUCTURE STATUS:
SYSNAME: SYSTEM2 Duplex Quiesced
SYSNAME: SYSTEM1 Duplex Quiesced
SYSNAME: SYSTEM3 NOTCONN
SYSNAME: .....
```

DISPLAY SMS command

```
SYSNAME: .....  
SYSNAME: .....  
SYSNAME: .....  
SYSNAME: .....
```

Displaying information about all subsystems

Use the DISPLAY SSI command to display the following information about all subsystems defined to MVS:

- Whether the subsystem is dynamic
- Whether the subsystem is active
- For a dynamic subsystem, whether it accepts or rejects dynamic SSI commands such as SETSSI.
- For an active subsystem, the function codes it supports.

An operator can use keyword filters to specify the information to be displayed from those subsystems that meet the specified criteria. For example, an operator may choose to display information about a particular subsystem by specifying its name.

The output from the DISPLAY SSI command is a multi-line message. It is written to the console from which the command was issued or to the specified console.

Syntax

D SSI
D SSI[, {LIST L} {ALL A}] [, {DYNAMIC DYN D}={YES Y} {NO N}] [, {FUNC F}=func] list] [, {STATUS STAT ST}={ACTIVE ACT} {INACTIVE INACT I}] [, {SUBSYS SUB}=subsysname] [, L={a name name-a}]

Parameters

SSI

Displays information about all subsystems defined to the SSI.

LIST or L

Displays the LIST output format, which includes the following information for each subsystem defined to the system:

- Whether the subsystem is dynamic
- Whether the subsystem is active
- For a dynamic subsystem, whether the subsystem accepts or rejects dynamic SSI commands such as SETSSI.

The LIST format is the default keyword.

ALL or A

Displays the ALL output format. This output is the same as the LIST format except that the system includes a sub-list after each list element. The sub-list contains a list of function codes to which the subsystem responds.

For the output messages of the DISPLAY SSI command, see message IEFJ100I.

DYNAMIC or DYN or D=YES or Y or No or N

Displays either dynamic or non-dynamic subsystems. If dynamic, the subsystem can use dynamic SSI services. See *z/OS MVS Using the Subsystem Interface* for more information on dynamic SSI requests.

FUNC or F=funclist

Displays those subsystems that respond to the function codes specified. The *funclist* value can be either a number no greater than three digits or a list of numbers no greater than three digits. The list of numbers must be separated by commas and enclosed in parentheses. For example, you can specify FUNC=3 or FUNC=(18,5,100).

You can use the FUNC parameter with either the LIST parameter or the ALL parameter. For either format, only those subsystems which respond to all the specified function codes appear in the display. If you use the ALL format, the list of function codes for each subsystem displayed is the complete list of all the function codes to which that subsystem responds. If you specify the FUNC parameter, inactive subsystems or subsystems without a vector table do not appear in the display.

STATUS or STAT or ST=ACTIVE or ACT or INACTIVE or INACT or I

Displays subsystems whose status is either active or inactive. Specifying ACTIVE or ACT means that displayed subsystems accept function requests directed to it by the SSI. Specifying INACTIVE or INACT or I means that displayed subsystems do not accept function requests directed to it by the SSI.

SUBSYS or SUB=subsysname

Displays information about the subsystem whose name matches the specified pattern. The pattern could be the name of the subsystem or it could contain wildcard characters.

Subsystem names that are not enclosed in apostrophes may contain any character that is valid for operator commands, with the following exceptions:

- , comma
- (left parenthesis
-) right parenthesis
- / slash
- = equals sign

Subsystem names containing these characters must be enclosed in apostrophes.

Subsystem names that contain any character that is not valid for operator commands must be enclosed in apostrophes. See Chapter 4, "MVS system commands reference," on page 153 for a list of characters supported by commands.

You can specify an asterisk (*) or question mark (?) anywhere in the subsystem name. An asterisk (*) is a wildcard character used to replace 0 or more characters to obtain a matching name. A question mark (?) is a wildcard character used to replace one character to obtain a matching name. For example, if a system has subsystems JES2, JESA, A, SS2 and J specified: SUBSYS=JES* causes JES2 and JESA to appear in the display. SUBSYS=J* causes JES2, JESA and J to appear in the display. SUBSYS=*S2 causes JES2 and SS2 to appear in the display. SUBSYS=?S2 causes SS2 to appear in the display. SUBSYS=* causes all the subsystems to appear in the display. Note that specifying SUBSYS=* has the same effect as not specifying the SUBSYS parameter at all.

DISPLAY SSI command

Also, you can specify the character string '!PRI' rather than a subsystem name, which causes the system to display only the primary subsystem.

L=a, name, or name-a

Specifies the display area (*a*), console name (*name*), or both (*name-a*) where the display is to appear.

If you omit this operand, the display is presented in the first available display area or the message area of the console through which you enter the command.

Notes:

1. You cannot use the same parameter twice within a command.
2. A command line cannot be longer than 126 characters.

Examples

Example 1:

To display information for all the subsystems defined to the system which:

- Are currently active
- Can use dynamic SSI services

without including the list of function codes to which the subsystems respond, enter:

```
D SSI,STAT=ACT,DYN=YES
```

Example 2:

To display information for every subsystem whose name begins with 'JES' and include the list of function codes for each subsystem, enter:

```
D SSI,ALL,SUB=JES*
```

Example 3:

To display information for every subsystem that responds to function codes 9 and 10 and include the list of function codes for each subsystem, enter:

```
D SSI,A,FUNC=(9,10)
```

Note: If a display in response to the command is greater than 65,533 lines, the system will truncate the output. If this happens, re-enter the DISPLAY SSI command using parameters to decrease the size of the display. For example, if D SSI,ALL yields a display that is too large, you can use D SSI,LIST to display subsystems without listing the function codes to which they respond. Then use D SSI,ALL,SUBSYS=subsysname to display the function codes for the particular subsystems of interest one subsystem at a time.

Displaying static system symbols

Use the DISPLAY SYMBOLS command to display the current static system symbols and their associated substitution texts.

D SYMBOLS

D SYMBOLS [,DETAIL] , {SUMMARY | SUM} | , {SYMNAME=*symname* | S=*symname*}
 [,L={*a* | *name* | *name-a*}]

SYMBOLS

The system is to display, in message IEA007I, the static system symbols defined to this system.

DETAIL

Displays the names and substitution text of the static system symbols. The DETAIL parameter is optional.

Default: DETAIL

SUMMARY | SUM

Displays summary information about the static system symbols currently in use with message IEA994I. The SUMMARY parameter is optional. You can use SUM as a synonym of SUMMARY.

SYMNAME=*symname* | S=*symname*

Displays all system symbols that match *symname*. S is a synonym for SYMNAME. The specification *symname* must not include the trailing period that is allowed when using a system symbol. *symname* must either not have the leading ampersand (for example, SYSNAME) or must use a double ampersand (for example, &&SYSNAME). The SYMNAME parameter is optional.

If you use a single ampersand for a defined symbol (&SYSNAME), the system tries to match a system symbol of the same name as the substitution text for the specified symbol instead of a system symbol of the same name as the specified symbol.

The symbol specification may include wildcard characters "*" and "?", and information for all matching symbols is displayed. The display will indicate if no matching symbol is found. For example, to display the static system symbols defined to this system that have names with S in the first and third characters, enter:

D SYMBOLS,SYMNAME=S?S*

L=*a*, *name*, or *name-a*

Specifies the display area (*a*), console name (*name*), or both (*name-a*) where the display is to appear.

If you omit this operand, the display is presented in the first available display area or the message area of the console through which you enter the command.

Example:

To display the static system symbols defined to this system, enter:

D SYMBOLS

Displaying the local and coordinated universal time and date

Use the DISPLAY T command to display the local time of day and date and the coordinated universal time (UTC) of day and date.

DISPLAY T command

D T
D T

T The local time of day and date and the coordinated universal time (UTC) of day and date are to be displayed (message IEE136I).

Displaying component or transaction trace status

Use the DISPLAY TRACE command to obtain status information about either components or applications defined to component trace, or about transaction trace.

D TRACE
D TRACE[,COMP=cname[,SUB=(subname)][,N=nnn][,SUBLEVEL]]
[,COMP={(cname[,cname]...) ALL}]
[,WTR={(name[,name],...) ALL}]
[,TT]
[,L={a name name-a}]

TRACE

Indicates that the system is to display status information, in short form, about the components defined to component trace.

COMP=ALL

Specifies that the system is to display status, in long form, for all components.

COMP=(cname[,cname]...)

Specifies that the system is to display component status, in long form, for the component names requested. See your system programmer for the components and applications active on the system that are defined to component trace.

SUB=(subname)

Specifies that the system is to display, in long form, the status of the specified sublevel trace. Obtain the specific names of sublevels from the system programmer. If the sub level trace name contains any national characters (@ # \$ _) then the name must be enclosed in quotation marks. Otherwise, quotation marks are not required. In either case, the alphabetic characters can be specified in upper or lower case.

The command displays information for only one sublevel trace. Enter a separate DISPLAY command for each sublevel trace.

N=nnn

Specifies that the system is to display the subordinate node status and, when the SUBLEVEL keyword is specified, the specific 'nnn' number of parallel or sublevel nodes of the requested subordinate node.

SUBLEVEL

Specifies that sublevel trace status is to be displayed.

WTR=(name[,name],...)

Displays information only about the component trace external writers you specify.

WTR=ALL

Displays information about all component trace external writers.

TT Displays the status of the transaction trace currently in effect. In a parallel sysplex environment it displays the status of the transaction trace currently in effect in the sysplex. See Example 6.

L=a, name, or name-a

Specifies the display area (*a*), console name (*name*), or both (*name-a*) where the display is to appear.

If you omit this operand, the display is presented in the first available display area or the message area of the console through which you enter the command.

Note: See *z/OS MVS Programming: Authorized Assembler Services Reference ALE-DYN* for information about application traces of application programs. See *z/OS MVS Diagnosis: Tools and Service Aids* for information about component traces of components.

Example 1

To display the status of component trace in short form, enter:

```
DISPLAY TRACE
```

The system responds with:

```
IEE843I 15.18.24 TRACE DISPLAY 447
      SYSTEM STATUS INFORMATION
ST=(ON,0001M,00001M) AS=ON BR=OFF EX=ON MO=OFF MT=(ON,024K)
COMPONENT MODE COMPONENT MODE COMPONENT MODE COMPONENT MODE
-----
SYSRSM  MIN SYSGRS  ON  SYSVLF  PRE  SYSLLA  MIN
```

COMPONENT

The component name.

MODE

The current state of the trace:

ON Trace is on.

OFF
Trace is off.

MIN

This component has reduced tracing activity to the minimum required to provide serviceability data in a dump.

PRE

This trace is PRESET. Trace options were established with a TRACE CT specifying a parmlib member containing the PRESET(DEFINE) option.

Example 2

To display the component trace status of all components, enter:

```
DISPLAY TRACE,COMP=ALL
```

The system responds with:

```
IEE843I 15.18.24 TRACE DISPLAY 450
      SYSTEM STATUS INFORMATION
ST=(ON,0001M,00001M) AS=ON BR=OFF EX=ON MO=OFF MT=(ON,024K)
```

DISPLAY TRACE command

COMPONENT	MODE	BUFFER	HEAD	SUBS

SYSVLF	PRE	4M		
ASIDS		*NOT SUPPORTED*		
JOBNAMES		*NOT SUPPORTED*		
OPTIONS		COMPONENT, SPECIFIC, OPTIONS, EXAMPLE		
WRITER		*NOT SUPPORTED*		

SYSLLA	MIN	200K	HEAD	20
ASIDS		*NOT SUPPORTED*		
JOBNAMES		*NOT SUPPORTED*		
OPTIONS		COMPONENT, SPECIFIC, OPTIONS, EXAMPLE		
WRITER		*NOT SUPPORTED*		

SYSRSM	MIN	4M		
ASIDS		*NONE*		
JOBNAMES		*NONE*		
OPTIONS		*NONE*		
WRITER		*NONE*		

COMPONENT

The component name.

MODE

The current state of the trace:

ON Trace is on.

OFF

Trace is off.

MIN

This component has reduced tracing activity to the minimum required to provide serviceability data in a dump.

PRE

This trace is PRESET. Trace options were established with a TRACE CT specifying a parmlib member containing the PRESET(DEFINE) option.

BUFFER

The buffer size, in decimal, established by PRESET(DEFINE) or by operator command when the component trace was turned on.

ASIDS

The ASIDs, in hexadecimal, currently in use as a filter for tracing this component, or one of the following values:

NONE

ASIDs can act as a tracing filter, but none were specified.

NOT SUPPORTED

ASIDs cannot be used as a filter for this component.

JOBNAMES

The job names currently in use as a filter for tracing this component, or one of the following values:

NONE

Job names can act as a tracing filter, but none were specified.

NOT SUPPORTED

Job names cannot be used as a filter for this component.

OPTIONS

List of options established when the component trace was turned on.

NONE indicates that options are permitted but none are currently in use.

WRITER

The component trace external writer established when the component trace was turned on or modified.

NOT SUPPORTED indicates that writers cannot be used for this component.

Example 3

To display the status of all component trace external writers, enter:

```
DISPLAY TRACE,WTR=ALL
```

The system responds with:

```
IEE843I 15.18.24 TRACE DISPLAY 447
      SYSTEM STATUS INFORMATION
ST=(ON,0001M,00001M) AS=ON BR=OFF EX=ON MO=OFF MT=(ON,024K)
WRITER  STATUS  HEAD  COMPONENT  SUBNAME
-----
WTRABC  ACTIVE              SYSGRS
              SYSXCF
WTRDEF  ACTIVE
WTRXYZ  INACTIVE  HEAD  SYSSMS
```

WRITER

The component trace external writer name.

STATUS

The current state of the component trace external writer:

ACTIVE

Writer is active, and the components shown in the COMPONENT column are connected to it.

INACTIVE

Writer is inactive, and the components shown in the COMPONENT column are connected to it. Tracing begins when the component trace external writer is started.

HEAD

The specified trace is a HEAD trace, there may be SUB traces implicitly connected through the HEAD trace.

COMPONENT

The component(s) connected to the specified component trace external writer. Several components can be connected to the same component trace external writer.

SUBNAME

The specified trace is a SUB trace.

Example 4

To display the status of two sublevels of SAMPLE STEP1.STEP2, enter:

```
D TRACE,COMP=SAMPLE,SUB=(STEP1),N=2,SUBLEVEL
```

Example 5

To display the status of 2 parallel traces of 'SAMPLE STEPB.STEPC', enter:

```
D TRACE,COMP=SAMPLE,SUB=(STEPB.STEPC),N=2
```

DISPLAY TRACE command

Example 6

To display the status of the transaction trace in a sysplex, enter:

```
D TRACE,TT
IEE843I 14.47.19 TRACE DISPLAY 709
SYSTEM STATUS INFORMATION
ST=(ON,0001M,00001M) AS=ON BR=OFF EX=ON MO=OFF MT=(ON,024K)
-----
TRANSACTION TRACE STATUS: ON
  BUFSIZ=0002M WRITER=*NONE* LATENT=YES
  01: TRAN=TRAN1      USER=TESTERP1
      LVL=0001
  02: USER=DONNA*    LVL=002
SYSTEMS PARTICIPATING IN TT: SYS1  SYS2  SYS3
```

Displaying device status and allocation

Use the DISPLAY U command to help you keep track of the status (that is, the availability for allocation) of the devices attached to the system. This command lets you request the status of:

- All devices
- A specific device type
- Online devices
- Offline devices
- Allocation information (that is, jobname and ASID)
- A range of devices
- Automatically switchable devices
- Unavailable devices

The DISPLAY U command can also display the job names and ASIDs of device users. Knowing the jobs and ASIDs using a particular device can help you determine if you can or cannot take a particular device offline.

Syntax

```
D U{[,deviceclass][,ONLINE ][, [/]devnum[,nnnnn]
      [,OFFLINE][, [/]devnum[,nnnnn]
      [,ALLOC ][, [/]devnum[,nnnnn]
      [,AUTOSWITCH|AS][, [/]devnum[,nnnnn]][SYS=sysname]
      [,UNAVAILABLE|UNAVAIL][, [/]devnum[,nnnnn]} (See Note)

{,IPLVOL}

{,VOL=volser}

[,L={a|name|name-a}]
```

Note: Supply all commas between DISPLAY U and a specified operand. For example, DISPLAY U, ,OFFLINE.

To compare this DISPLAY U command with the DEVSERV PATHS command, see “Displaying the status of devices and availability of paths” on page 11.

Parameters

U

The system is to display unit status information about all devices or about specified devices, including non-supported devices (those devices defined in the IODF as DUMMY devices) and channel-to-channel (CTC) links.

deviceclass

The device class for which the system is to display unit status information. You can enter any one of the following operands for device type:

- CTC — channel-to-channel (CTC) adapters
- DASD — direct access storage devices
- GRAPHIC — graphic devices
- TAPE — magnetic tape units
- TP — communication equipment
- UR — unit record and dynamic switches
- ALL — all options displayed (equivalent to specifying DISPLAY U)

ONLINE

The system is to display information (in message IEE457I) about only those devices of the specified device type that are online. If you do not specify a device type, the system displays information about all online devices.

OFFLINE

The system is to display information (in message IEE457I) about only those devices of the specified device type that are offline. If you do not specify a device type, the system displays information about all offline devices.

ALLOC

The system is to display allocation information (in message IEE106I) for any specified device that is allocated. Allocation information includes the jobname and address space identifier (ASID) of each job to which the device is currently allocated.

AUTOSWITCH or AS

The system is to display information the coupling facility has about one specific tape device or all tape devices that are defined as automatically switchable. AUTOSWITCH is valid only for tape devices (that is, for a *deviceclass* of TAPE.) If you omit *deviceclass*, the system displays information about all automatically switchable tape devices. If a device is offline to the issuing system, the information specifies that the device is offline (“OFFLINE” in the STATUS column) and does not provide any other information about the device.

UNAVAILABLE or UNAVAIL

The system is to display information (in message IEE457I) about the OFFLINE and UNAVAILABLE tape devices. When one or more devices are offline and unavailable, the UNIT and TYPE are displayed in message IEE457I.

UNAVAILABLE is valid only for tape devices (that is, for a *deviceclass* of TAPE.) If you omit *deviceclass*, the system displays information about all offline and unavailable tape devices.

SYS=sysname

The system is to display information about the status of automatically switchable devices on the system named *sysname*.

IPLVOL

The system is to display information (in message IEE457I) about the device

DISPLAY U command

from which the system was initially loaded (IPL'ed). For additional IPL information use the **DISPLAY IPLINFO** command.

VOL=volser

The volume serial of the device for which the system is to display unit status information in message IEE457L.

Note: If you do not specify **ONLINE**, **OFFLINE**, or **ALLOC**, the system displays status information, without allocation information, about both online and offline devices.

[/]devnum,nnnn

The system is to display unit status information about devices starting with device number *devnum* for *nnnn* number of devices. *devnum* is a 3-digit or 4-digit hexadecimal device number, optionally preceded by a slash (/).

If you omit the device number, the system assumes the starting device number is X'000'.

If you omit the number of devices and do not specify **ALLOC**, the system assumes the number of devices is 16. If you omit the number of devices and specify **ALLOC**, the system assumes the number of devices is 8.

The system displays status information for primary paths only.

L=a, name, or name-a

Specifies the display area (*a*), console name (*name*), or both (*name-a*) where the display is to appear.

If you omit this operand, the display is presented in the first available display area or the message area of the console through which you enter the command.

Notes:

1. If you specify a device number that was not specified in the IODF during system installation, the display starts with the next higher device number that was specified.
2. For multiple-exposure devices (supported pre-MVS/ESA SP 5.2), the value you specify for *devnum* must be the same as that specified in the IODF.
3. For parallel access volumes, if you specify an alias device number, the system ignores it and starts with the next device number that is not an alias device number.
4. When the system displays the device type for an MCS or SMCS console as a 3270 model X, HCD identifies it as a 3270 console.
5. For autoswitchable devices, a **DISPLAY U** command without the **AUTOSWITCH** parameter may display a volume serial number other than for the currently mounted volume if the device is assigned to a different system. Use the **AUTOSWITCH** parameter to display up-to-date information for such a device.

Examples

Example 1:

To list the status of the first ten (if any) direct access devices with device numbers of 400 or higher, enter:

```
D U,DASD,,400,10
```

Example 2:

To list the users (jobnames and ASIDs) of the first eight allocated devices with device numbers of A250 or higher, enter:

```
D U,,ALLOC,/A250,8
```

or

```
D U,,ALLOC,/A250
```

Example 3:

To list the status of a device specified by the volume serial number D72665, enter:

```
D U,VOL=D72665
```

Example 4:

To list the status of the automatically switchable tape device with the device number of 270, enter:

```
D U,,AUTOSWITCH,270,1
```

Example 5:

To list the status of the first 16 automatically switchable tape devices with device numbers of 000 or higher on the system named GRS127, enter:

```
d U,,AUTOSWITCH,,SYS=GRS127
```

Displaying Unicode services

Use the DISPLAY UNI command to show the status of available conversions and whether the conversion services are already initialized (message CUN3000I).

The syntax for the DISPLAY UNI command is:

```
D UNI{,ENVIRONMENT|ENV          }
      {,SERVICE|SERV           }
      {,STORAGE|STOR            }
      {,CONVERSION|CONV         }
      {,NORMALIZATION|NORM      }
      {,COLLATION|COLL          }
      {,FROMID=ccsid            }
      {,TOID=ccsid              }
      {,FROMID=ccsid1,TOID=ccsid2}
      {,CASECONV|CASE           }
      {,STRPROFILE|STRP         }
      {,ALL|A                    }

[,L={a|name|name-a}]
```

The parameters are:

ENVIRONMENT or ENV

Displays three time stamps. The date and time are shown in the format of --/--/---- and --,--,-- respectively.

The first time stamp shows when the Unicode environment was created; the second shows when the last change was made with the SET UNI or SETUNI command; the third shows when the image was created. The third time stamp

DISPLAY UNI command

shows a value only if there is an image loaded at IPL time or if an image was added dynamically to an empty Unicode environment. Any subsequent modification to the Unicode environment or dynamic additions of individual tables to an empty environment will result in clearing out of the time stamp field.

If all three time stamps are equal and an uni member was specified at IPL time, no active image can be loaded. In that case, check your system log for Unicode error messages during IPL.

If you specify no parameters for the D UNI command, the default is ENVIRONMENT.

SERVICE or **SERV**

Lists the available conversion services.

STORAGE or **STOR**

Show information about the storage used by the Unicode Services environment.

CONVERSION or **CONV**

Displays the supported character conversion services.

NORMALIZATION or **NORM**

Displays if normalization service is enabled or disabled. If the service is enabled, the output includes the normalization versions loaded in the environment.

COLLATION or **COLL**

Displays if collation service is enabled or disabled. And if the service is enabled, the output includes the collation versions loaded in the environment.

FROMID=ccsid

Displays only the conversions with the specified From-CCSID.

TOID=ccsid

Displays only the conversions with the specified To-CCSID.

FROMID=ccsid1,TOID=ccsid2

Displays only the conversions with the specified From-CCSID and To-CCSID.

CASECONV or **CASE**

Displays the supported case conversion services.

STRPROFILE or **STRP**

Displays the string preparation profiles loaded in the environment.

ALL or **A**

Displays the following information:

- Three time stamps for when the environment was created and last modified, and when the active image was modified.
- The names of available services.
- The data space pages currently in use and the page limit.
- The status of available services.

L=a, name, or name-a

Specifies the display area (*a*), console name (*name*), or both (*name-a*) where the display is to appear.

If you omit this operand, the display is presented in the first available display area or the message area of the console through which you enter the command.

Example 1:

To list the time stamps of the Unicode environment, enter:

```
D UNI,ENV
```

If the system has been IPLed with an image, the system responds:

```
SY1 CUN3000I 23.30.23 UNI DISPLAY 698
ENVIRONMENT: CREATED      02/28/2006 AT 19.21.14
              MODIFIED    02/28/2006 AT 19.36.22
              IMAGE CREATED 05/18/2004 AT 13.12.43
```

Otherwise, the system responds:

```
SY1 CUN3000I 23.30.23 UNI DISPLAY 698
ENVIRONMENT: CREATED      02/28/2006 AT 19.21.14
              MODIFIED    02/28/2006 AT 19.36.22
              IMAGE CREATED --/--/---- AT --.---.---
```

Example 2:

To list the conversion loaded in the environment, enter:

```
D UNI,CONV
```

The system shows the active conversions:

```
CUN3000I 00.09.01 UNI DISPLAY 584
CONVERSION: 00037-01200(13488)-R
```

If no conversion service is available, the system responds:

```
SY1 CUN3000I 23.51.10 UNI DISPLAY 459
CONVERSION: NO CONVERSIONS FOUND
```

Example 3:

To show the environment, storage status and details of available services, enter:

```
D UNI,ALL
```

The system responds:

```
CUN3000I 00.10.40 UNI DISPLAY 587
ENVIRONMENT: CREATED      02/28/2006 AT 23.56.52
              MODIFIED    03/01/2006 AT 00.08.02
              IMAGE CREATED 02/28/2006 AT 23.56.52
SERVICE: CHARACTER CASE NORMALIZATION COLLATION STRINGPREP BIDI
STORAGE: ACTIVE      140 PAGES
              FIXED   0 PAGES
              LIMIT   524287 PAGES
CASECONV: NORMAL SPECIAL
NORMALIZE: DISABLED
NORM VER: NONE
COLLATE: DISABLED
COLL RULES: NONE
STRPROFILES: NONE
CONVERSION: 00037-01200(13488)-R      00037-01200(13488)-L
```

Displaying virtual storage information

Use the DISPLAY VIRTSTOR command to identify the virtual storage configuration. The following information is displayed in message IAR019I:

- If DISPLAY VIRTSTOR,HVSHARE is specified:

DISPLAY VIRTSTOR,HVSHARE command

- Source of HVSHARE parameter can be a parmlib member, operator supplied, or the default.
- The size of the high virtual shared area in gigabytes, in decimal.
- The range of the high virtual shared area in gigabytes, in decimal.
- The amount of shared storage allocated into memory objects in megabytes, in decimal.
- If DISPLAY VIRTSTOR,HVCOMMON is specified:
 - Source of HVCOMMON parameter can be a parmlib member, operator supplied, or the default.
 - The size of the 64-bit common area in gigabytes, in decimal.
 - The range of the 64-bit common area in gigabytes, in decimal.
 - The amount of 64-bit common area that is allocated in megabytes, in decimal.
- IF DISPLAY VIRTSTOR,LFAREA is specified:
 - Source of LFAREA parameter can be a parmlib member, operator-supplied or the default.
 - The size of both the 1 MB LFAREA, in megabytes, and 2 GB LFAREA, in gigabytes, in decimal.
 - The amount of both the 1 MB LFAREA, in megabytes, and 2 GB LFAREA, in gigabytes, that is available, in decimal.
 - The amount of 1 MB LFAREA that is allocated in megabytes, in decimal, on behalf of 1 MB-page requests.
 - The amount of 1 MB LFAREA that is allocated in megabytes, in decimal, on behalf of 4 KB-page requests.
 - The high water mark for the amount of 1 MB LFAREA that is allocated in megabytes, in decimal, on behalf of 1 MB-page requests.
 - The high water mark for the amount of 1 MB LFAREA that is allocated in megabytes, in decimal, on behalf of 4 KB-page requests.
 - The amount of 1 MB LFAREA that is allocated in megabytes, in decimal, on behalf of pageable 1 MB-page requests.
 - The high water mark for the amount of 1 MB LFAREA that is allocated in megabytes, in decimal, on behalf of pageable 1 MB-page requests.
 - The amount of 2 GB LFAREA that is allocated in 2G units, in decimal.
 - The high water mark for the amount of 2 GB LFAREA that is allocated in 2G units, in decimal.

D {VIRTSTOR VS} {HVSHARE HVCOMMON LFAREA}

D { <u>VIRTSTOR VS</u> }, {HVSHARE HVCOMMON LFAREA}

[,L={a name name-a}]

L=a, name, or name-a

Specifies the display area (*a*), console name (*name*), or both (*name-a*) where the display is to appear.

If you omit this operand, the display is presented in the first available display area or the message area of the console through which you enter the command.

Note: For the output of the DISPLAY VIRTSTOR command, see the description of message IAR019I.

Displaying workload manager information

Use the DISPLAY WLM command to display the following information:

- The name of the active service policy for the sysplex, if there is one. If there is no active service policy, the response indicates that the system is running with the DEFAULT service policy.
- The date and time the service policy was activated.
- The date and time the service definition was installed.
- The status information for a specific application environment or for all application environments.
- The status information for a specific scheduling environment on a specific system or on all systems.
- The status information for a resource on a specific system or on all systems.
- The status of the Application Response Measurement (ARM) services as well as the guest platform management provider (GPMP).

```
D WLM[,SYSTEM=sysname|,SYSTEMS]
  [,APPLENV=app|envname|*]
  [,DYNAPPL=app|envname|*[,SNODE=nodename]
                                [,SNAME=subsystemname]
                                [,STYPE=subsystemtype]]
  [,SCHENV=schenvname[,SYSTEM=sysname|,SYSTEMS]]
  [,RESOURCE=resourcename[,SYSTEM=sysname|,SYSTEMS]]
  [,AM[,ALL]]
  [,SYSTEMS[,GPMP]]
  [,L={a|name|name-a}]
```

WLM

If no other parameters are specified, displays the name of the active service policy in effect on all systems in the sysplex, as well as the time and date that the service policy was activated. Also, for systems in the sysplex that are in an exception state, it shows summary information. If coupling facility structures are defined for either multisystem enclaves or for LPAR clustering, the status of those is shown.

SYSTEM=*sysname*

When used with D WLM, displays the name of the active service policy in effect on the *sysname* system only, including the time and date that the service policy was activated, when the service definition was installed, and the workload management version level. If coupling facility structures are defined for either multisystem enclaves or for LPAR clustering, the status of those is shown. It also displays the status of the named system in the sysplex (active or otherwise), including the service policy in effect on the named system.

SYSTEMS

When used with D WLM, displays the name of the active service policy in effect on all systems in the sysplex, the time and date that the service policy was activated, when the service definition was installed, the workload management version level, functionality level, and couple data set format level. If coupling facility structures are defined for either multisystem enclaves or for LPAR clustering, the status of those is shown. Finally, it displays the status of each system in the sysplex (active or otherwise), including the service policy in effect.

If you see a system listed that is not running with the active service policy, either the system does not have connectivity to the WLM couple data set or an attempt to activate the policy on that system failed. If connectivity to the WLM

DISPLAY WLM command

couple data set has been lost (or does not exist), establish the connection. You can use the DISPLAY XCF,COUPLE,TYPE=WLM command to query the status of the WLM couple data set. If connectivity to the WLM couple data set is established and the system is still not running with the active service policy, contact the IBM support center.

When you partition a system out of a sysplex, the system may nevertheless remain listed for a period of time, even though it is no longer part of the sysplex. The reason is that workload management retains knowledge of the system for a certain amount of time in case your installation decides to reactivate the system. If the system is not activated within several days, the system is automatically removed from the list of systems.

APPLENV=*applenvname* or *

Displays status information for the specified application environment (*applenvname*). Specifying APPLENV=* | DYNAPPL=*, the command displays status information for all application environments. The following keywords are valid:

SNODE=*nodename*

When SNODE=*nodename* is used, DISPLAY WLM,DYNAPPL displays only information for dynamic application environments with the specified *nodename*.

SNAME=*subsystemname*

When SNAME=*subsystemname* is used, DISPLAY WLM,DYNAPPL displays only information for dynamic application environments with the specified *subsystemname*.

STYPE=*subsystemtype*

When STYPE=*subsystemtype* is used, DISPLAY WLM,DYNAPPL displays only information for dynamic application environments with the specified *subsystemtype*.

Note: The DISPLAY WLM,APPLENV command is processed on the coordinator system, which is determined dynamically and may not be the local system where the command was issued. The command output is routed to the console from which the command has been issued, but the command hardcopy is logged on the system on which the command has been processed. Therefore, the message may not appear in the SYSLOG on the system where the command was entered.

SCHENV=*schenvname*

Displays status information for the specified scheduling environment (*schenvname*). You can display multiple scheduling environments by using wildcard characters. The multiple-character symbol (*) and the single-character symbol (?) can be used in any position.

SYSTEM=*sysname*

Displays the state of the scheduling environment and the availability of each resource referenced by the scheduling environment on the designated system.

SYSTEMS

Displays the state of the scheduling environment on all active systems in the sysplex.

If neither SYSTEM=*sysname* or SYSTEMS is specified, SYSTEMS is the default.

RESOURCE=resource

Displays status information for the specified resource (*resource*). You can display multiple resources by using wildcard characters. The multiple-character symbol (*) and the single-character symbol (?) can be used in any position.

SYSTEM=sysname

Displays the resource status information on the *sysname* system only.

SYSTEMS

Displays the resource status information on all active systems in the sysplex.

If neither **SYSTEM=sysname** or **SYSTEMS** is specified, the default is the system on which the command is entered.

AM Displays the current state of the Application Response Measurement (ARM) services together with the number of active processes (address spaces) using ARM services.

ALL

Displays a list of address spaces that are registered with ARM, together with the registered applications and the started application instances.

GPMP

Displays the status information associated with the guest platform management provider (GPMP).

L=a, name, or name-a

Specifies the display area (*a*), console name (*name*), or both (*name-a*) where the display is to appear.

If you omit this operand, the display is presented in the first available display area or the message area of the console through which you enter the command.

Example 1:

To display the name of the active service policy, enter:

```
D WLM
```

The system responds with:

```
IWM025I 17.40.54 WLM DISPLAY 913
ACTIVE WORKLOAD MANAGEMENT SERVICE POLICY NAME: WEEKDAY
ACTIVATED: 2009/08/12 AT: 12:55:57 BY: USER01 FROM: SYS2
DESCRIPTION: Weekday policy with ResGrp
RELATED SERVICE DEFINITION NAME: COEFFS
INSTALLED: 2009/08/12 AT: 12:55:51 BY: IBMUSER FROM: SYS2
WLM VERSION LEVEL: LEVEL025
WLM FUNCTIONALITY LEVEL: LEVEL025
WLM CDS FORMAT LEVEL: FORMAT 3
STRUCTURE SYSZWLM_WORKUNIT STATUS: CONNECTED
STRUCTURE SYSZWLM_EBAE2097 STATUS: CONNECTED
STATE OF GUEST PLATFORM MANAGEMENT PROVIDER (GPMP): CONNECTED
```

Example 2:

To display status information associated with system WLTEAM9, enter:

```
D WLM,SYSTEM=w1team9
```

The system responds with:

DISPLAY WLM command

```
IWM025I 17.40.16 WLM DISPLAY 810
ACTIVE WORKLOAD MANAGEMENT SERVICE POLICY NAME: WEEKDAY
ACTIVATED: 2009/08/12 AT: 12:55:57 BY: USER01 FROM: SYS2
DESCRIPTION: Weekday policy with ResGrp
RELATED SERVICE DEFINITION NAME: COEFFS
INSTALLED: 2009/08/12 AT: 12:55:51 BY: IBMUSER FROM: SYS2
WLM VERSION LEVEL: LEVEL025
WLM FUNCTIONALITY LEVEL: LEVEL025
WLM CDS FORMAT LEVEL: FORMAT 3
STRUCTURE SYSZWLM_WORKUNIT STATUS: CONNECTED
STRUCTURE SYSZWLM_EBAE2097 STATUS: CONNECTED
STATE OF GUEST PLATFORM MANAGEMENT PROVIDER (GPMP): CONNECTED
*SYSNAME* *MODE* *POLICY* *WORKLOAD MANAGEMENT STATUS*
WLTEAM9 GOAL BASEPOL ACTIVE
```

Example 3:

To display status information associated with all systems in the sysplex, enter:

```
D WLM,SYSTEMS
```

The system responds with:

```
IWM025I 17.41.57 WLM DISPLAY 960
ACTIVE WORKLOAD MANAGEMENT SERVICE POLICY NAME: WEEKDAY
ACTIVATED: 2009/08/12 AT: 12:55:57 BY: USER01 FROM: SYS2
DESCRIPTION: Weekday policy with ResGrp
RELATED SERVICE DEFINITION NAME: COEFFS
INSTALLED: 2009/08/12 AT: 12:55:51 BY: IBMUSER FROM: SYS2
WLM VERSION LEVEL: LEVEL025
WLM FUNCTIONALITY LEVEL: LEVEL025
WLM CDS FORMAT LEVEL: FORMAT 3
STRUCTURE SYSZWLM_WORKUNIT STATUS: CONNECTED
STRUCTURE SYSZWLM_EBAE2097 STATUS: CONNECTED
STATE OF GUEST PLATFORM MANAGEMENT PROVIDER (GPMP): CONNECTED
*SYSNAME* *MODE* *POLICY* *WORKLOAD MANAGEMENT STATUS*
SYS2 GOAL BASEPOL ACTIVE
WLTEAM9 GOAL BASEPOL ACTIVE
```

Example 4:

To display status information associated with the guest platform management provider, enter:

```
D WLM,SYSTEMS,GPMP
```

The system responds with:

```
IWM025I 17.42.24 WLM DISPLAY 977
ACTIVE WORKLOAD MANAGEMENT SERVICE POLICY NAME: WEEKDAY
ACTIVATED: 2009/08/12 AT: 12:55:57 BY: USER01 FROM: SYS2
DESCRIPTION: Weekday policy with ResGrp
RELATED SERVICE DEFINITION NAME: COEFFS
INSTALLED: 2009/08/12 AT: 12:55:51 BY: IBMUSER FROM: SYS2
WLM VERSION LEVEL: LEVEL025
WLM FUNCTIONALITY LEVEL: LEVEL025
WLM CDS FORMAT LEVEL: FORMAT 3
STRUCTURE SYSZWLM_WORKUNIT STATUS: CONNECTED
STRUCTURE SYSZWLM_EBAE2097 STATUS: CONNECTED
STATE OF GUEST PLATFORM MANAGEMENT PROVIDER (GPMP): CONNECTED
*SYSNAME* *MODE* *POLICY* *WORKLOAD MANAGEMENT STATUS*
SYS2 GOAL BASEPOL ACTIVE
WLTEAM9 GOAL BASEPOL ACTIVE
*SYSNAME* *GPMP STATUS* *GPMP TRACE LEVEL*
SYS2 CONNECTED LOW-MEMORY
WLTEAM9 CONNECTED MEDIUM-FILE
```

Example 5:

To display the status of the application environment named DB2PAY, enter:

D WLM,APPLENV=db2pay

The system responds with:

```
IWM029I 18.59.22 WLM DISPLAY 319
APPLICATION ENVIRONMENT NAME      STATE      STATE DATA
DB2PAY                            AVAILABLE
ATTRIBUTES: PROC=BR14             SUBSYSTEM TYPE: DDF
```

Example 6:

To display status of all application environments, enter:

D WLM,APPLENV=*

The system responds with:

```
IWM029I 19.02.29 WLM DISPLAY 341
APPLICATION ENVIRONMENT NAME      STATE      STATE DATA
BR14                              AVAILABLE
FRESCA                            AVAILABLE
PAYAT2                            AVAILABLE
PAYAT5                            AVAILABLE
PAYROLL                           AVAILABLE
PAYTEST                           AVAILABLE
PAYTEST2                          AVAILABLE
```

Example 7:

To display status of the scheduling environment DB2LATE, enter:

D WLM,SCHENV=DB2LATE

The system responds with:

```
IWM036I 12.21.05 WLM DISPLAY 181
SCHEDULING ENVIRONMENT: DB2LATE
DESCRIPTION:              Offshift DB2 Processing
AVAILABLE ON SYSTEMS:    SYS1 SYS3
```

Example 8:

To display status of all scheduling environments in a sysplex beginning with the string 'DB2', enter:

D WLM,SCHENV=DB2*

The system responds with:

```
IWM036I 12.21.05
WLM DISPLAY 181
SCHEDULING ENVIRONMENT: DB2LATE
DESCRIPTION:              Offshift DB2 Processing
AVAILABLE ON SYSTEMS:    SYS1 SYS3

SCHEDULING ENVIRONMENT: DB2PRIME
DESCRIPTION:              Primetime DB2 Processing
AVAILABLE ON SYSTEMS:    SYS2
```

Example 9:

DISPLAY WLM command

To display system-level status information about the DB2LATE scheduling environment on system SYS1, enter:

```
D WLM,SCHENV=DB2LATE,SYSTEM=SYS1
```

The system responds with:

```
IWM037I 12.21.05 WLM DISPLAY 181
SCHEDULING ENVIRONMENT: DB2LATE
DESCRIPTION:           Offshift DB2 Processing
SYSTEM:                SYS1
STATUS:                AVAILABLE

RESOURCE NAME          REQUIRED   CURRENT
                      STATE     STATE
DB2A                   ON      ON
PRIMETIME              OFF     OFF
```

Example 10:

To display status of all resources on all systems in a sysplex, enter:

```
D WLM,RESOURCE=*,SYSTEMS
```

The system responds with:

```
IWM038I 12.21.05 WLM DISPLAY 181
RESOURCE: DB2A
DESCRIPTION: DB2 Subsystem
SYSTEM STATE   SYSTEM STATE   SYSTEM STATE
SYS1   ON      SYS2   ON      SYS3   ON

RESOURCE: PRIMETIME
DESCRIPTION: Peak Business Hours
SYSTEM STATE   SYSTEM STATE   SYSTEM STATE
SYS1   OFF     SYS2   ON      SYS3   OFF
```

Example 11:

To display whether the Application Response Measurement (ARM) services are enabled or disabled, enter:

```
D WLM,AM
```

The system responds with:

```
IWM075I 17.54.21 WLM DISPLAY 512
ARM SERVICES ARE ENABLED
GUEST PLATFORM MANAGEMENT PROVIDER JOBNAME=HVEMCA ASID=0032
GPMP POLICY IS ACTIVE
NUMBER OF REGISTERED PROCESSES=3, APPLICATIONS=1
```

To display the list of all ARM instrumented address spaces together with the registered applications and started application instances, enter:

```
D WLM,AM,ALL
```

The system responds with:

```
IWM075I 16.32.14 WLM DISPLAY 068
ARM SERVICES ARE ENABLED
GUEST PLATFORM MANAGEMENT PROVIDER JOBNAME=HVEMCA ASID=0032
GPMP POLICY IS ACTIVE
NUMBER OF REGISTERED PROCESSES=2, APPLICATIONS=2
ADDRESS SPACES CURRENTLY REGISTERED WITH ARM:
JOBNAME=CICSREG1 ASID=0027
APPLICATION=CICS
IDENTITY PROPERTIES=0 CONTEXT NAMES=0
STARTED APPLICATION INSTANCES:
```

```
EWLINST1
  TRAN=0 GROUP=<name omitted>
REGISTERED TRANSACTIONS:
  SYS_DefaultZWLMTransactionName
JOBNAME=BGBOMYT1 ASID=0035
APPLICATION=My ARM Application
IDENTITY PROPERTIES=7 CONTEXT NAMES=1
STARTED APPLICATION INSTANCES:
  <name omitted>
  TRAN=2 GROUP=My-Group
REGISTERED TRANSACTIONS:
  My-HttpTransaction
ADDRESS SPACES WITH DISABLED ARM REGISTRATION:
JOBNAME=BGBOMYT2 ASID=0034
```

Displaying cross system coupling facility (XCF) information

Use the DISPLAY XCF command to display cross system coupling information in the sysplex.

DISPLAY XCF command

Syntax

The syntax of the DISPLAY XCF command is:

```
D XCF[, {PATHIN|PI} ]
    [, {DEVICE|DEV}={ ([/]indevnum[, [/]indevnum...)] |ALL} ]
    [, {STRNAME|STRNM}={ (strname[, strname]...) |ALL} ]
    [, {SYSNAME|SYSNM}={ (sysname[, sysname]...) } ]
    [, {STATUS|STAT}={ ([STARTING] [, RESTARTING] [, WORKING]
        [, STOPPING] [, STOPFAILED] [, INOPERATIVE]
        [, LINKING] [, QUIESCING] ) } ]

[, {PATHOUT|PO} ]
    [, {DEVICE|DEV}={ ([/]outdevnum[, [/]outdevnum...)] |ALL} ]
    [, {STRNAME|STRNM}={ (strname[, strname]...) |ALL} ]
    [, CLASS={ (classname[, classname]...) |ALL} ]
    [, {SYSNAME|SYSNM}={ (sysname[, sysname]...) } ]
    [, {STATUS|STAT}={ ([STARTING] [, RESTARTING] [, WORKING]
        [, STOPPING] [, STOPFAILED] [, INOPERATIVE]
        [, LINKING] [, QUIESCING] )
        [, REBUILDING] [, QUIESCED] ) } ]

[, {LOCALMSG|LM} [, CLASS={ (classname[, classname]...) |ALL} ] ]
[, {GROUP|GRP}, groupname[, membername |ALL] ] ]
[, {SYSPLEX|S} [, systemname |ALL] ] ]
[, {COUPLE|CPL} [, TYPE={ (name[, name]...) |ALL} ] ] ]

[, {CLASSDEF|CD} ] ]
    [, CLASS={ classname | (classname[, classname]...) |ALL} ]
    [, {GROUP|G}=groupname ] ]

[, {STRUCTURE|STR} ] ]
    [, ALTER={ DISABLED | ENABLED } ] ]
    [, {STRNAME|STRNM}={ (strname[, strname]...) |ALL} ] ]
    [, {CONNAME|CONNM}={ (conname[, conname]...) |ALL} ] ]
    [, {STATUS|STAT}={ ([ALLOCATED] [, NOTALLOCATED]
        [, DUPENAB] [, DUPALLOW]
        [, DUPMISMATCH] [, LOSSCONN]
        [, RBPROC] [, RBPEND]
        [, POLICYCHANGE] [, DEALLOCPENDING]
        [, LARGERCFRMDS] [, REBUILD] [, STRDUMP]
        [, ALTER] [, FPCONN] [, NOCONN] [, DUPREBUILD] ) } ] ]

[, {CF} [, {CFNAME|CFNM}={ (cfname[, cfname]...) |ALL} ] ] ]
[, {POLICY|POL} [, TYPE={ (name[, name]...) |ALL} ] ] ]
[, {PRMPOLICY|PRMPOL} ] ]

[, {ARMSTATUS|ARMS} ] ]
    [, {RESTARTGRP|RG}=rgname ] ]
    [, {ELEMENT|EL}=elname | {JOBNAME|JOB}=jobname ] ]
    [, INITSYS=initsys ] ]
    [, CURRSYS=currsys ] ]
    [, STATE=([ STARTING | START ] [, {AVAILABLE | AVAIL} [, FAILED]
        [, {RESTARTING | RESTART} [, {RECOVERING | RECOVER} ] ] ) ] ]
    [, DETAIL ] ]

[, {CONNECT|CON} ] ]
[, {REALLOCATE|REALLOC}, {REPORT|TEST} ] ]
[, {SERVER|SRV} ] ]
    [, SYSNAME|SYSNM={ (sysname[, sysname]...) } ] ]
    [, SERVERNAME|SRVNAME|SRVNM=servername ] ]
    [, SCOPE={ (SUMMARY|SUM) |, {DETAIL|DET} } ] ]
    [, TYPE=NAME [, STATUS=(STALLED)] ] ]
    [, TYPE=INSTANCE | INST [, STATUS=([ WORKING | WORK } [, STALLED] ) ] [, {INSTNUM|INST#}=inst# ] ] ]
    [, STATUS=([ WORKING | WORK } [, STALLED] ) ] ] ]

[, {NOTEPAD|NP} ] ]
    [, {NOTEPADNAME|NPNAME|NPNM}={ notepadname |ALL } ] ]
    [, {STRNAME|STRNM}={ hostname |ALL } ] ]
    [, SCOPE={ SUMMARY | SUM } | {DETAIL|DET} ] ]
[, L={ a | name | name-a } ] ]
```

Parameters

XCF

Displays a summary of the current sysplex.

PATHIN or PI

Displays in message IXC355I the device number of one or more inbound signalling paths that XCF can use and information about inbound XCF signalling paths to this system. The display provides information for only those devices and structures that are defined to the system where this command is executed. The path summary response identifies each inbound path and, if known, the system name and device address of its associated outbound path. If specified without further qualification, summary information about all inbound XCF signalling paths displays. Use of the DEVICE or STRNAME keyword requests that more detailed information be displayed.

If there are no inbound paths to this system, the system displays message IXC355I.

Use, but do not repeat, the following keywords in any combination or order:

DEVICE= or DEV={([/]indevnum[, [/]indevnum]...)} or ALL

Displays in message IXC356I detailed information about the devices requested. If you specify DEVICE=ALL, the system provides information on all inbound signalling paths currently defined to XCF. If you specify only one device number, you do not need to enter the parentheses. A device number consists of 3 or 4 hexadecimal digits, optionally preceded by a slash (/).

If no paths match, the system displays message IXC355I. If there are no inbound paths to this system, the system displays message IXC355I.

STRNAME= or STRNM=(strname[, strname...]) or ALL

Requests that the system display (message IXC356I) detailed signalling path information for one or more named coupling facility structures. You may specify ALL to request information for all coupling facility structures. Wildcard (*) suffixes are allowed.

strname specifies the structure name of a coupling facility structure that is being used as a XCF signalling path for which information is to be displayed. The structure name can be up to 16 characters long. It may contain numeric characters, uppercase alphabetic characters, or the four special characters: \$, @, #, _. It must begin with an uppercase alphabetic character.

XCF signalling structures must begin with the letters IXC.

SYSNAME= or SYSNM=sysname(s)

Requests that signalling path information be displayed only for paths connected to one or more named systems.

sysname specifies the name of a system that is connected by a XCF signalling path for which information is to be displayed. The system name can be up to 8 characters long. It may contain numeric characters, uppercase alphabetic characters, or the three special characters: \$, @, #. It must begin with a numeric or uppercase alphabetic character.

STATUS= or STAT=state(s)

Requests that the system display signalling path information for paths

DISPLAY XCF command

or coupling facility structures having at least one of the specified states. *state* specifies the path status of a signalling path or coupling facility structure for which information is requested. You may use any of the following or the indicated abbreviation:

STARTING or START

Validating and initializing hardware.

RESTARTING or RESTART

Making ready (again) for use.

LINKING or LINK

Establishing communication.

WORKING or WORK

Capable of being used.

QUIESCING

Quiescing the use of.

QUIESCED

Use was quiesced.

REBUILDING

In the process of being rebuilt.

STOPPING or STOP

Stopping use, in the process of being removed from service.

STOPFAILED or STOPF

Stop failed, intervention required.

INOPERATIVE or INOP

Defined, but removed from service.

PATHOUT or PO

Displays in message IXC356I the device number of one or more outbound signalling paths that XCF can use and information about outbound XCF signalling paths to this system. The display provides information for only those devices and structures that are defined to the system where this command is executed. The path summary response identifies each outbound path and, if known, the system name and device address of its associated inbound path. If specified without further qualification, summary information about all outbound XCF signalling paths displays. Use of the **DEVICE**, **STRNAME** or **CLASS** keyword requests that detail information be displayed.

If there are no outbound paths to this system, the system displays message IXC356I.

DEVICE= or DEV={([/]outdevnum[, [/]outdevnum]...) or ALL}

Displays in message IXC356I detailed information about the devices requested. If you specify **DEVICE=ALL**, the system provides information on all outbound signalling paths currently defined to XCF. If you specify only one device number, you do not need to enter the parentheses. A device number consists of 3 or 4 hexadecimal digits, optionally preceded by a slash (/).

If no paths match, the system displays message IXC356I. If there are no outbound paths to this system, the system displays message IXC356I.

CLASS={ (classname [, classname]...) or ALL}

Displays (message IXC356I) detailed information about all devices

assigned to the requested transport class. If you specify CLASS=ALL, the system provides information on outbound signalling paths for all transport classes. When you specify a classname ending with an *, then all classes beginning with the specified name are displayed. Do not specify an asterisk for the first character of the classname. If you specify only one class, you do not need to enter the parentheses.

If no classes match, or if there are no outbound paths to this system, the system displays message IXC356I.

STRNAME= or STRNM=*strname*(s)

Requests that the system display (message IXC356I) detailed signalling path information for one or more named coupling facility structures. You may specify ALL to request information for all coupling facility structures. Wildcard (*) suffixes are allowed.

strname specifies the structure name of a coupling facility structure that is being used as a XCF signalling path for which information is to be displayed. The structure name can be up to 16 characters long. It may contain numeric characters, uppercase alphabetic characters, or the four special characters: \$, @, #, _. It must begin with an uppercase alphabetic character.

XCF signalling structures must begin with the letters IXC..

SYSNAME= or SYSNM=*sysname*(s)

Requests that signalling path information be displayed only for paths connected to one or more named systems.

sysname specifies the name of a system that is connected by a XCF signalling path for which information is to be displayed. The system name can be up to 8 characters long. It may contain numeric characters, uppercase alphabetic characters, or the three special characters: \$, @, #. It must begin with a numeric or uppercase alphabetic character.

STATUS= or STAT=*state*(s)

Requests that the system display signalling path information for paths or coupling facility structures having at least one of the specified states. *state* specifies the path status of a signalling path or coupling facility structure for which information is requested. You may use any of the following or the indicated abbreviation:

STARTING or START

Validating and initializing hardware.

RESTARTING or RESTART

Making ready (again) for use.

LINKING or LINK

Establishing communication.

WORKING or WORK

Capable of being used.

QUIESCING

Quiescing the use of.

QUIESCED

Use was quiesced.

REBUILDING

In the process of being rebuilt.

DISPLAY XCF command

STOPPING or **STOP**

Stopping use, in the process of being removed from service.

STOPFAILED or **STOPF**

Stop failed, intervention required.

INOPERATIVE or **INOP**

Defined, but removed from service.

LOCALMSG or **LM**

Displays (message IXC341I) information about the signalling resources that service local message traffic.

If classes are missing, the system displays message IXC345I.

CLASS={(*classname* [, *classname*]...) or **ALL**}

Displays (message IXC341I) information for a specific transport class. If you do not specify this option, the system displays information for all transport classes. When you specify a classname ending with an *, then all classes beginning with the specified name are displayed. Do not specify an asterisk for the first character of the classname. If you specify only one class, you do not need to enter the parentheses.

GROUP or **GRP**

Displays information about multisystem groups. If you do not provide a qualifying operand, message IXC331I provides a list of all currently defined XCF groups.

If no groups are defined to the sysplex, the system displays message IXC339I.

groupname

Displays (message IXC332I) the members of the specified group.

If no groups match, the system displays message IXC340I.

membername or **ALL**

Displays (message IXC333I) detailed information -- the system name, MVS job name, or current status -- about the members of a particular group or all groups. When you specify a membername ending with an *, then all members beginning with the specified name are displayed. Do not specify an asterisk for the first character of the membername.

If no members of a group match, the system displays message IXC326I.

When ALL is specified, detailed information displays for all the members of the specified group.

SYSPLEX or **S**

Displays (message IXC336I) system status and the last recorded system status monitor time stamp for a system. If ALL is specified for the system name, detailed information for all systems in the sysplex displays.

systemname or **ALL**

Displays (message IXC337I) system status and the last recorded system status monitor time stamp for a system. If ALL is specified for the system name, detailed information for all systems in the sysplex displays.

If the system is not defined to the sysplex, the system displays message IXC330I.

COUPLE or **CPL**

Displays (message IXC357I) information about the couple data set in use

by the sysplex. If specified without further qualification, information will be displayed about all couple data sets.

If there is no primary data set defined, the system displays message IXC357I.

TYPE={(*name*[,*name*...]) or ALL}

Indicates that information about the couple data sets associated with the named (or ALL) data types is to be displayed.

name specifies the name of the service using the couple data set for which information is to be displayed. The name may be up to eight characters long. It may contain characters A-Z and 0-9 and the characters \$, @, and #. The name must start with a letter. The supported service names are:

- SYSPLEX for sysplex (XCF) types
- ARM for automatic restart management
- CFRM for coupling facility resource management
- SFM for sysplex failure management
- LOGR for the system logger
- WLM for workload management

CLASSDEF or CD

Displays (message IXC343I) the transport classes that are currently defined to XCF on the system upon which the DISPLAY command is executed. If you do not specify either CLASS or GROUP, an alphabetical summary of all transport classes is provided. The CLASS and GROUP operands are mutually exclusive: specify one or the other.

CLASS={(*classname*{, *classname*}...) or ALL}

Displays (message IXC344I) detailed information about the requested transport classes. When you specify a classname ending with an *, then all classes beginning with the specified name are displayed. Do not specify an asterisk for the first character of the classname. Specify CLASS=ALL to request detailed information for all transport classes defined to XCF. If you specify only one class, you do not need to enter the parentheses.

If specified transport classes are not defined to XCF, the system displays message IXC345I.

GROUP= or G=*groupname*

Displays (message IXC344I) detailed information about the transport classes to which the specific group is assigned. You can obtain information for any valid group name, even a group that is not active in the sysplex. Use *UNDESIG* to list information for those transport classes to which the undesignated groups have been assigned.

If the specified group is not assigned to any transport class, the system displays message IXC346I.

STRUCTURE or STR

Requests information about the coupling facility structures in the policy. If specified without further qualification, summary information (message IXC359I) will be displayed about all coupling facility structures that are in the policy. Using the STRNAME keyword requests the system to display detail information.

DISPLAY XCF command

Use, but do not repeat, the following keywords in any combination or order:

STRNAME= or STRNM=*strname*(s)

Requests that the system display (message IXC360I) detailed information for one or more named coupling facility structures. You may specify **ALL** to request information for all coupling facility structures. Wildcard (*) suffixes are allowed.

strname specifies the structure name of a coupling facility structure for which information is to be displayed. The structure name can be up to 16 characters long. It may contain numeric characters, uppercase alphabetic characters, or the four special characters: \$, @, #, _. It must begin with an uppercase alphabetic character. Names provided by IBM begin with SYS, an IBM component prefix, or letters A-I.

CONNNAME= or CONNM=*connname*(s)

Requests that the system display detailed information about one or more connectors to a structure. You may specify **ALL** to request information for all connectors to the structure.

ALTER=*setting*

Requests that the system display only structure information for coupling facility structures with the specified **ALLOWALTER** setting. The following values are valid for *setting*:

DISABLED

Display only CF structures for which CF structure alter processing is disabled. Requests to start CF structure alter processing for such structures are not permitted.

ENABLED

Display only CF structures for which CF structure alter processing is enabled.

STATUS= or STAT=*state*(s)

Requests that the system display only structure information for coupling facility structures having at least one of the specified states. *state* specifies the status of a coupling facility structure for which information is requested and may be any of the following states:

ALLOCATED or ALLOC

A coupling facility structure is allocated in a coupling facility.

ALTER

A coupling facility structure is in the process of being altered.

DEALLOCENDING or DEALLOC

A coupling facility structure is pending deallocation because of a loss of connectivity to the coupling facility where the structure is allocated or because of a structure dump table being associated with the structure.

DUPALLOW

An allocated coupling facility structure with a CFRM policy specification of **DUPLEX(ALLOWED)**.

DUPENAB

A coupling facility structure with a CFRM policy specification of **DUPLEX(ENABLED)**. Requesting only structures with this status can be helpful in determining if the system has been able to duplex all **DUPLEX(ENABLED)** structures.

DUPMISMATCH

A coupling facility structure with a duplexed state (duplex or simplex) that does not match the CFRM policy specification: simplex structures with a policy specification of DUPLEX(ENABLED); duplexed structures with a policy specification of DUPLEX(DISABLED); and duplexed structures when a CFRM policy stop is pending. This can also include duplexed structures with a pending policy change to remove a coupling facility from the structure preference list. A structure in this state can remain in this state until there are no structures with a state of LOSSCONN, RBPROC, and RBPEND.

DUPREBUILD

A coupling facility structure is in a duplexing rebuild process.

FPCONN

A coupling facility structure has at least one failed-persistent connector. The system displays all connectors to the structure, including those that are not failed-persistent.

LARGERCFRMDS or LARGER

A coupling facility structure has connections that cannot be represented in the coupling facility resource management couple data set.

LOSSCONN

Use of a coupling facility structure by an active connection is inhibited due to a loss of connectivity between a system and a coupling facility. The LOSSCONN RECOVERY IN PROGRESS text in messages IXC359I and IXC360I appears only when there is a structure in this state. A structure in this state can cause CFRM to defer the following actions: policy-initiated start duplexing; policy-initiated stop duplexing; continue REALLOCATE process; and continue POPULATECF process.

NOCONN

A coupling facility structure has no connectors.

NOTALLOCATED or NOTALLOC

Coupling facility structure is not allocated in any coupling facility.

POLICYCHANGE or POLCHG

The activation of a coupling facility resource management policy has caused pending policy changes to some coupling facility structures. The changes are pending the deallocation of the structure in a coupling facility or a REALLOCATE process.

RBPEND

There is a pending structure rebuild for a rebuild to populate a coupling facility (POPULATECF), or a REALLOCATE evaluation is pending for the structure. A structure in this state can cause CFRM to defer the following actions: policy-initiated start duplexing; policy-initiated stop duplexing. A structure in this state can remain in this state until there are no structures with a state of LOSSCONN .

RBPROC

A coupling facility structure is in a rebuild (or a duplexing rebuild) phase other than duplex established. A structure in this state can

DISPLAY XCF command

cause CFRM to defer the following actions: policy-initiated start duplexing; policy-initiated stop duplexing.

REBUILD or RB

A coupling facility structure is in the process of being rebuilt or there is a pending structure rebuild for a rebuild to populate a coupling facility (POPULATECF).

STRDUMP or STRD

A structure dump table is associated with a coupling facility structure.

CF Requests information about the coupling facility in the policy. If specified without further qualification, the system displays (message IXC362I) summary information about all coupling facilities that are in the policy.

CFNAME= or CFNM= {(cfname[,cfname...]) or ALL}

Requests that detailed usage information (message IXC362I) for the named coupling facility be displayed. **ALL** may be specified to request information for all coupling facilities. Generic, or "wildcard", (*) suffixes are allowed.

cfname specifies the name of a coupling facility for which detailed information is to be displayed.

The coupling facility name can be up to 8 characters long. It may contain numeric characters, uppercase alphabetic characters and the special characters \$, @, # and underscore (_). It must begin with an uppercase alphabetic character.

POLICY or POL

Requests information about the policies in use. If specified without further qualification, the system displays (message IXC364I) summary information about all policies that are active.

TYPE={ (name[, name...]) or ALL}

Requests information (message IXC364I) about the policy associated with the named (or ALL) services is to be displayed. The named service is one that uses a couple data set to maintain policy data and supports usage of the SETXCF command to control the policy.

name specifies the name of a service for which policy information is to be displayed. The name may be up to eight characters long. The valid characters are A-Z and 0-9 and the characters \$, @, and #. The name must start with a letter. The supported service names are:

- ARM for automatic restart management
- CFRM for coupling facility resource management
- SFM for sysplex failure management

PR SMPOLICY or PR SMPOL

Displays (message IXC349I) the name of the parmlib member that contains the current active XCF PR/SM policy.

If there is no XCF PR/SM parmlib member in use, the system displays message IXC348I.

ARMSTATUS or ARMS

Displays information (through message IXC392I) about active batch jobs and started tasks that are registered as elements of automatic restart management. The element information is grouped by the restart group in which they are defined (based on the current policy). If you specify

ARMSTATUS without further qualification, summary information about all the active elements will be displayed. You may filter the information by specifying RESTARTGRP, ELEMENT, JOBNAME, INITSYS, CURRSYS, or STATE. You may specify DETAIL to request more information about the elements. The JOBNAME and ELEMENT parameters are mutually exclusive.

RESTARTGRP= or RG=*rgname*

Information displays only for elements in the specified restart group. The *rgname* may contain a wildcard character (*) at the end, to request information for a set of restart groups. If you specify RG=* as the only filter for the display command, only summary information is shown for the restart groups.

ELEMENT= or EL=*elname*

Information displays only for the element specified. The *elname* may contain a generic character (*) at the end, to request information for a set of elements.

ELEMENT may not be specified with JOBNAME.

JOBNAME= or JOB=*jobname*

Information displays only for elements with the specified job name or started task name.

JOBNAME may not be specified with ELEMENT.

INITSYS= *initsys*

Information displays only for elements initially running on the system specified. The *initsys* may contain a generic character (*) at the end, to request information for a set of systems.

CURRSYS= *currsys*

Information displays only for elements currently running on the system specified. The *currsys* may contain a generic character (*) at the end, to request information for a set of systems.

STATE= *state*

Information displays only for elements in the states specified.

STARTING or START

The element has initially registered,(has issued the IXCARM macro with the REQUEST=REGISTER parameter) but has not yet indicated it is ready to accept work (has not issued the IXCARM macro with the REQUEST=READY parameter).

AVAILABLE or AVAIL

The element has indicated it is ready to accept work (has issued the IXCARM macro with the REQUEST=READY parameter) or the element exceeded the ready timeout threshold before it issued the IXCARM macro with the REQUEST=READY parameter.

FAILED

The element has ended and a restart has not been initiated by MVS, yet. This condition should apply only for a short amount of time if automatic restart management restarts have been enabled. (This state is not related to the failed state for an XCF member.)

RESTARTING or RESTART

MVS has initiated a restart of this element, but it has not

DISPLAY XCF command

re-registered with automatic restart management (has not issued the IXCARM macro with the REQUEST=REGISTER parameter), yet.

RECOVERING or RECOVER

The element has been restarted and has re-registered with automatic restart management (has issued the IXCARM macro with the REQUEST=REGISTER parameter), but has not indicated that it is ready to accept work (has not issued the IXCARM macro with the REQUEST=READY parameter), yet.

DETAIL

Detailed information displays. The scope of this information depends on the other parameters specified.

CONNECT or CON

Displays information about active connections to coupling facility (CF) structures through message IXC374I. Requesting this information can be useful in determining the processing that is being performed for CF lossconn recovery.

REALLOCATE or REALLOC

Displays information about the REALLOCATE process.

REPORT

Requests information (through message IXC347I) about the most recent REALLOCATE process.

TEST

Requests information (through message IXC347I) about what can be expected from subsequent REALLOCATE processing. Analysis is performed for a simulated REALLOCATE process.

SERVER or SRV

Displays information about servers in the sysplex. If you do not provide a qualifying operand, message IXC395I provides a list of all defined servers. If there are no active servers that match the filter criteria, the system displays message IXC399I.

SYSNAME or SYSNM=*sysname*(s)

Requests that server information be displayed only for servers residing on the named systems.

sysname can be up to 8 characters long. It can contain numeric characters, uppercase alphabetic characters, or the three special characters: \$, @, #. It must begin with a numeric or uppercase alphabetic character.

SERVERNAME or SRVNAME or SRVNM=*servername*

Requests that server information be displayed only for servers whose server names match the specified *servername* criteria.

servername is a server name or name template that consists of four 8-byte name sections separated by periods. For name sections that are not specified, blanks are assumed. *servername* can contain one or more wildcard character (*) and when placed in quotation marks (") is case-sensitive. For example, *.* matches any server name that contains any characters in the first two sections and all blanks in the last two sections. The system displays information for all servers if you do not specify *servername*.

Consider the following when specifying *servername*:

- Each section in a *servername* can contain any alphanumeric (A-Z,a-z,0-9), national (@,#,\$), or underscore character.

- Any section but the first can be entirely blank.
- If the name contains embedded, that is, non-trailing blanks or lower-case letters, the name must be enclosed within apostrophes. Lower-case letters not enclosed within apostrophes are folded to upper case.
- Server names are case sensitive. For example, 'comp1.subcomp1.*.job1' matches any server name with comp1 in the first section, subcomp1 in the second section, any text in the third section, and any text ending with job1 in the fourth section, all case sensitive.

Each 8-byte name section can contain a wildcard (*), which matches zero or more characters in the section. Here are some general matching rules for a server name with four sections:

- * matches server names with anything in the first section and blanks in the other three sections.
- *.*.* matches any server name.
- *.* matches server names with anything in the first and the second sections and all blanks in the third and the fourth sections.
- *.* matches server names with anything in the first and the third sections and all blanks in the second and the fourth sections.
- COMP* matches any server names with the first section beginning with COMP and all blanks in the other sections.
- COMP1 .SUBCOMP.*.JOB1 matches any server name that has COMP1 in the first 8-byte section, a second 8-byte section consisting of SUBCOMP, any text in the third 8-byte section, and JOB1 (padded with blanks) in the fourth section.

SCOPE=scope

Specifies the scope of server information to be displayed, where *scope* can be one of the following values:

SUMMARY or SUM

Requests that summary server information be displayed.

DETAIL or DET

Requests that detailed server information be displayed.

TYPE=type

Specifies the type of server information to be displayed where *type* can be one of the following:

NAME

Requests that information associated with servers that have one or more of the specific server names be displayed; that is, information is for the named server as a whole.

INSTANCE or INST

Requests that information associated with server instances be displayed, that is, information is for the state of each instance of the server.

STATUS=state

Requests that server information be displayed for only those servers that are in one of the following specified states:

STALLED

The server is considered stalled.

DISPLAY XCF command

WORKING or WORK

The server instance is currently working on a request. You can specify this status only for TYPE=INSTANCE.

INSTNUM or INST#=*inst#*

Requests that server information be displayed only for server instances that have the specified instance number. You can only specify this option for TYPE=INSTANCE.

Issue the DISPLAY

XCF,SERVER,SERVERNAME=*servername*,TYPE=INSTANCE command to see the server instance numbers for all server instances of the servers whose server names match the specified *servername* criteria. The information is returned through message IXC397I.

NOTEPAD or NP

Display information about XCF note pads that are defined in the sysplex. If specified without further qualification, message IXC442I provides summary information about all XCF note pads that are defined in the sysplex. If there are no XCF note pads that match the filter criteria, the system displays message IXC444I.

NOTEPADNAME= or NPNAME= or NPNM={*notepadname* or ALL}

Requests that note pad information display for only those XCF note pads with names that match the specified *notepadname* criteria. If you specify NOTEPADNAME=ALL, the system provides information about all XCF note pads that are defined in the sysplex.

Note the following considerations when specifying *notepadname*:

- A note pad name consists of two to four sections separated by periods.
- If a section is not specified, it is defaulted to all blanks.
- The first two sections cannot be blank. The third and the fourth sections can be blank.
- Each section must be left-justified with no trailing blanks.
- Each section in a *notepadname* can contain up to 8 alphanumeric (A-Z, a-z, 0-9), national (@,#,\$), or underscore (_) characters. The system automatically folds lowercase alphabetic characters to upper case.
- Each section can contain a wildcard character (*) that matches zero or more characters in the section. For example:
 - *.*.* matches any note pad name.
 - *.* matches note pad names with anything in the first two sections and blanks in the last two sections.
 - *.*.* matches note pad names with anything in the first, the second, and the fourth sections and all blanks in the third section.
 - OWNER*.* matches note pad names with the first section beginning with OWNER, anything in the second section, and all blanks in the third and the fourth sections.
 - OWNER1.APP1.*.QUA1 matches note pad names with OWNER1 in the first section, APP1 in the second section, anything in the third section, and QUA1 in the fourth section.

STRNAME= or STRNM={*hostname* or ALL}

Requests that note pad information displays for only those XCF note pads that are allocated in the named structure. If you specify STRNAME=ALL, the note pad information is not filtered by host structure names. A wildcard (*) suffix is allowed.

SCOPE=scope

Specifies the scope of the displayed note pad information, where *scope* is one of the following values:

SUMMARY or SUM

Requests that summary note pad information (message IXC442I) displays.

DETAIL or DET

Requests that detailed note pad information (message IXC443I) displays.

L=a, name, or name-a

Specifies the display area (*a*), console name (*name*), or both (*name-a*) where the display is to appear.

If you omit this operand, the display is presented in the first available display area or the message area of the console through which you enter the command.

DUMP command

The DUMP command requests a system dump (SVC dump) of virtual storage. The SVC dump is stored in a direct access data set. The data set may be either a pre-allocated dump data set named SYS1.DUMPxx, or an automatically allocated dump data set named according to an installation-specified pattern.

You should request only one dump at a time on one system. Otherwise, you might have trouble determining the dump request that causes a particular IEE094D message. Also, a system writes only one SVC dump at a time, so it does not save anything to make several requests at once.

Hiperspace™ information is not included in SVC dumps. For more information about hiperspace data in dumps, see *z/OS MVS Diagnosis: Tools and Service Aids*.

Wildcards

You can use wildcards to identify multiple names. On a reply for a DUMP command, you can specify wildcards in job names, data space names, user IDs, XCF group names, and XCF member names. The parameter descriptions tell you when you can use wildcards. The wildcards are:

Wildcard**Meaning**

- * Zero or more characters, up to the maximum length of the string. An * can start the string, end it, appear in the middle, or appear in several places in the string. A single * for the name indicates that all job names, data space names, user IDs, XCF group names, or XCF member names will match.
- ? One character. One or more ? can start the string, end it, appear in the middle, or appear in several places in the string. A single ? indicates all names consisting of one character.

Note: You can mix wildcards in any combination.

Examples are:

- *A* specifies all names that contain an A, including the name A.

DUMP command

- *A*B specifies all names that contain an A and ending with a B, with or without any intervening characters.
- ?A? specifies all 3-character names with an A as the second character.
- ?A?B specifies all 4-character names with A as the second character and B as the fourth character.
- ?A* specifies all names of 2 or more characters whose second character is A.

Syntax

The complete syntax for the DUMP command is:

```
DUMP {COMM={(title)} [,PARMLIB=xx] }  
      {'title'} | [ ,PARMLIB=(xx[,xx]...)]  
      {"title"} [SYMDEF=(symdef[,symdef]...)]  
      {TITLE={(title)} }  
            {'title'}  
            {"title"}
```

Parameters

```
COMM={(title)}  
      {'title'}  
      {"title"}  
TITLE={(title)}  
      {'title'}  
      {"title"}
```

The title (1-100 characters) you want the dump to have. This title becomes the first record in the dump data set. COMM and TITLE are synonyms.

Note: The system determines the title of a dump as follows:

- A title specified in the DUMP command (for example, DUMP TITLE="DUMP Specified via WTOR") takes precedence over a title specified within a parmlib member.
- When you do not specify a title in the DUMP command, the title specified within a parmlib member takes precedence.
- If you specify titles in multiple parmlib members, the title in the first parmlib member takes precedence. For example, if all of the parmlib members in **PARMLIB = (RA,XC,CF)** are titled, the dump title is the one specified in the **RA** parmlib member.
- With no title specified in the DUMP command or parmlib members, the title becomes DUMP FOR PARMLIB=(*xx,yy,zz*), where *xx,yy,zz* are the parmlib members.

```
PARMLIB=xx | PARMLIB=(xx[,xx]...)]
```

If the installation has set up DUMP command parmlib members (IEADMCxx parmlib members), you can avoid having to reply with many dump options by instead specifying the suffixes of one or more IEADMCxx parmlib members. When you do this, the system concatenates the contents of the IEADMCxx parmlib members together. If each parmlib member contains a title, the first title in the sequence is used. If specified on the DUMP command, the TITLE= parameter supercedes the titles in the parmlib members.

For example, if parmlib member IEADMCTC represents dump options for a base TCP/IP configuration, and IEADMCTA contains additional dump options

to append to the base settings, issuing the command DUMP PARMLIB=(TC,TA) will get you the base options plus the additional options.

If you do not specify the PARMLIB= parameter, the system prompts you with the following message for the dump options you want to specify:

```
* id IEE094D SPECIFY OPERAND(S) FOR DUMP COMMAND
```

For information on setting up IEADMCxx parmlib members, and on using the IBM-supplied sample IEADMCxx parmlib members, see *z/OS MVS Diagnosis: Tools and Service Aids*.

SYMDEF=(symdef[,symdef]...)

You may specify one or more symbol definitions for use within dump command parmlib members by specifying the SYMDEF= keyword. *symdef* should take the form *&symbol.=value*. The value passed within the *&symbol.=value* parameter will be parsed as if specified within an IEASYMxx member; symbolic substrings, defining a symbol using a previously defined symbol, and character conventions are recognized, including upper and lower case. For example:

```
DUMP PARMLIB=xx,SYMDEF=(&PAGING1.='AQFT',&CICS.='CICS1')
```

Note:

1. You can override existing symbols by specifying a double ampersand. If you do not use the double ampersand when specifying an existing symbol, it is ignored and a warning message is issued.
2. When specifying the substitution text, you need to observe the same rules as you define it within the IEASYMxx members. For example, the length of the resolved substitution text cannot exceed the length of *&symbol*, including the ampersand on *&symbol* and excluding the single quotation marks on *value*. In addition, all specified symbols must be unique. Specifying the same symbol for multiple times will result in unexpected behavior.

For more information about the rules of defining symbols, see the IEASYMxx parmlib member in *z/OS MVS Initialization and Tuning Reference*.

The syntax of a DUMP command specified within the IEADMCxx members of Parmlib is identical to that specified on the DUMP command through writes to operator with reply (WTORs).

Specifying dump options

You must use the REPLY command to respond to message IEE094D.

The REPLY command syntax for specifying dump options is:

```
R id,U
```

or

```
R id[,ASID=(n[,n]...)][,JOBNAME=(name[,name]...)][,TSONAME=(name[,name]...)]
  [,DSPNAME=(dspname-entry[,dspname-entry]...)]
  [, {PROBDESC|PROB|PD}=key-spec] [,REMOTE=(request[,request]...)]
  [,SDATA=[(option[,option]...)] [,STOR=(beg,end[,beg,end]...)]
  [,STRLIST=(s-option[,s-option]...)] [,DEFERTND=Yes|No]
  [,CONT|,END]
```

Notes:

1. When you specify CONT or END, it must be the last parameter on the input line.

DUMP command

2. The CONT keyword does not work within a SYSP list.
3. When you specify U, it must be the first parameter following the identification number.

Where **request** represents:

```
{GRPLIST={group(member)
           {(group(member[,member]...) [,group(member[,member]...)...) } }
{SYSLIST={sysinfo|(sysinfo[,sysinfo]...) }
          [,DSPNAME|,DSPNAME=(dspname-entry[,dspname-entry]...) ]
          [,SDATA|,SDATA=(option[,option]...) ]
          [,STOR|,STOR=(beg,end[,beg,end]...) ]
```

Where **s-option** represents:

```
STRNAME=strname
  [,CONNAME=conname ]
  [,ACCESSTIME={ENFORCE|NOLIMIT|NOLIM} ]
  [,LOCKENTRIES ]
  [,USERCNTLS ]
  [,EVENTQS ]
  [, (EMCONTROLS={ALL|(list)}) ]
  [, ({COCLASS|STGCLASS|LISTNUM}={ALL|(list)}) ]
  { [,ADJUNCT={CAPTURE|DIRECTIO}] [,ENTRYDATA={UNSERIALIZE|SERIALIZE}] }
  { [,SUMMARY] }
```

- id** The identification number (0-99), as specified in system message IEE094D. The leading zero can be omitted.
- U** The dump is to be of the master scheduler address space and include the storage areas defined by the SDATA default options. No other parameters are allowed with this parameter.

ASID=(n[,n]...)

n is the hexadecimal address space identifier of an address space you want to dump. If you specify only one identifier, you do not need to enter the parentheses. The maximum number of address space identifiers (ASIDs) that can be specified is 15. See the following limitation.

Limitation: An address space limitation applies to the ASID, JOBNAME, TSONAME, and DSPNAME parameters. A dump request can only handle a maximum of 15 unique ASIDs. The following items are used in the specified order to determine which ASIDs are added:

1. MASTER ASID is added first when TYPE=XMEM or TYPE=XMEME is in force (in this case, the operator dump command can only accept 14 other ASIDs as input)
2. The address spaces directly requested in the ASID parameter
3. The address spaces associated with the jobs named in the JOBNAME parameter
4. The address spaces associated with the user IDs in the TSONAME parameter
5. The address spaces for the data spaces in the DSPNAME parameter

Each ASID added due to an earlier item reduces the available slots for the next item. Also, wildcards used in the JOBNAME, TSONAME, and DSPNAME parameters can result in multiple address spaces being requested.

When the REPLY results in more ASIDs being requested than processing can handle, the system issues message ASA104I. If TYPE=XMEM or TYPE=XMEME is in force, then only the first 14 unique ASIDs will be allowed. Otherwise, 15 ASIDs are allowed. Regardless, the dump is taken with the truncated list of ASIDs as shown on the resultant IEA911E or IEA611I message.

JOBNAME=(*name* [,*name*] ...)

name identifies a background job whose address space you want to dump. If you specify only one name, you do not need to enter the parentheses. You can specify a maximum of 15 job names. See the ASID parameter for the actual limit on address spaces that can be specified.

You can specify each name explicitly or with wildcards. See “Wildcards” on page 487.

TSONAME=(*name* [,*name*] ...)

name is the name of any address space you want to dump, including the user identifier (ID) of a TSO user. If you specify only one name, you do not need to enter the parentheses. You can specify a maximum of 15 names. See the ASID parameter for the actual limit on address spaces that can be specified.

You can specify the name explicitly or with wildcards. See “Wildcards” on page 487.

Note:

1. If you do not specify ASID, JOBNAME, or TSONAME, the master scheduler address space is dumped.
2. Dumping several large address spaces such as the VTAM, master scheduler, and job entry subsystem address spaces or large system areas such as the CSA and SQA degrades performance of the system significantly. Dump only the address spaces that are likely to be involved in a problem. For example, if a TSO terminal in OPERATOR mode is having a problem, dump only the TSO user's address space and the VTAM address space.

DSPNAME=(*dspname-entry* [,*dspname-entry*] ...)

Specifies the data spaces to be dumped. Hiperspace names are not supported. If both hiperspaces and basic data spaces are specified, the basic data spaces are dumped, but the hiperspaces are not dumped. If only hiperspace names are specified, message ASA104I or message ASA008I is issued. The form of a *dspname-entry* is:

- *asid.name*
- '*jobname*'.*name*.

You can mix the two forms.

asid

is the explicit hexadecimal address space identifier of the owner of the data space you want to dump.

Note: When a data space is owned by an address space not included in the dump, the ASID of that address space is added to the dump. While up to 15 unique ASIDs and/or JOBNAMEs may be specified for the limit of 256 address spaces, refer to the ASID parameter of the DUMP command

DUMP command

for the actual limit on the number of unique ASIDs that can be specified for DSPNAME. The address space limitation may prevent specifying the maximum number of data spaces.

'*jobname*'

is the name of the job associated with the data space you want to dump. The *jobname* must be enclosed in single quotation marks; see the CONT parameter for special handling details. You can specify *jobname* explicitly or with wildcards. See "Wildcards" on page 487.

name

is the 1 to 8 character name associated with the data space at its creation. You can specify the data space name explicitly or with wildcards. See "Wildcards" on page 487.

If you specify to dump only one data space, represented by *dspname-entry*, you do not need to enter the parentheses. You can dump a maximum of 256 data spaces. If you enter a larger number, the system will dump only 256 data spaces.

PROBDESC or PROB or PD = *key-spec*

Provides problem information that is passed to any SVC dump, but is intended for dumps requested by the REMOTE parameter. When a system requests a dump on another system in the sysplex, the system being dumped calls an IEASDUMP.QUERY routine. The routine uses the information to determine if its system should be dumped and, if so, what storage areas should be added to the dump; the IEASDUMP.QUERY routine suppresses the requested dump only if PROBDESC specifies SYSDCOND.

key-spec is either of the following:

- *key*
- (*key-value*[,*key-value*]...)

key-value is either of the following:

- *key*
- (*key,data*)

You can mix the two forms. You can specify a maximum of 16 *key-value* forms.

key

Is a 1- to 8-character value that corresponds to the SDPD_KLD_KEY field in the IHASDPD mapping macro. The key must not begin with A through I or SYS; these are reserved for IBM use. IBM-supplied values for *key* are:

SYSDCOND

Suppresses a dump on another system in a sysplex if the other system does not have an IEASDUMP.QUERY routine or if no IEASDUMP.QUERY routine returns a code of 0.

SYSDLOCL

Requests the following:

- Dumps of other systems in a sysplex.
- An immediate dump of the local system, on which you are entering the DUMP command.
- A second, deferred dump of the local system, if a SYSLIST or GRPLIST option of the REMOTE parameter includes the local system. The deferred dump contains areas added by IEASDUMP.QUERY, IEASDUMP.GLOBAL, and IEASDUMP.LOCAL exit routines, if any routines had been associated with those exits.

SYSDNGRP

Causes the IEASDUMP.QUERY routine to receive control without the implicit address spaces specified with the SYSLIST or GRPLIST option of the REMOTE parameter. This allows the IEASDUMP.QUERY routine to control which address spaces should be dumped.

No data is specified with the IBM-supplied keys.

data

Specifies 1 to 16 characters of information to be used by the IEASDUMP.QUERY routine. If a *data* value is not provided, the system passes 16 blanks to the IEASDUMP.QUERY routine. If the value is shorter than 16 characters, the system pads it on the right with blanks to the length of 16.

For dumps on other systems in a sysplex initiated by the DUMP command, the other systems will not invoke IEASDUMP.QUERY routines unless the DUMP command contains a PROBDESC parameter.

For the IHASDPD data area, see *z/OS MVS Data Areas* in the z/OS Internet library (<http://www.ibm.com/systems/z/os/zos/bkserv/>).

For the IEASDUMP.QUERY routine, see *z/OS MVS Programming: Authorized Assembler Services Guide* .

REMOTE=(request [,request]...)

Specifies a dump on one or more systems in the sysplex. Each request consists of a GRPLIST or SYSLIST option to identify the system or systems, optionally followed by DSPNAME, SDATA, and STOR options to specify attributes for the requested dump or dumps. GRPLIST and SYSLIST options can appear more than once in the REMOTE parameter; each DSPNAME, SDATA, or STOR option applies to the preceding GRPLIST or SYSLIST option.

If the reply specifies a key of SYSDLOCL in the PROBDESC parameter and the GRPLIST or SYSLIST option includes the *local system* on which you are entering the DUMP command, the local system is dumped twice: the immediate dump is for the DUMP command and the deferred dump is for the REMOTE parameter. If the reply does not specify a key of SYSDLOCL, the REMOTE parameter does not apply to the local system; only the immediate dump is written.

Note: A dump requested through the REMOTE parameter may not be written. The reasons for dump suppression are listed in *z/OS MVS Diagnosis: Tools and Service Aids*.

If the GRPLIST and SYSLIST options specify the same system more than once, only one dump is written combining all of the options.

If the reply specifies REMOTE and the other parameters do not indicate the areas to be dumped on the local system, the immediate dump of the local system is of the master scheduler address space.

The *request* subparameters and values follow:

GRPLIST=group (member)**GRPLIST=(group (member [,member]...)[, group (member [,member]...)]...)**

Specifies one or more systems by the XCF group and member names.

You can specify the *group* and *member* explicitly or with wildcards. See "Wildcards" on page 487.

DUMP command

SYSLIST=*sysinfo*

SYSLIST=(*sysinfo***[,***sysinfo***...)**

Specifies one or more systems and, optionally, address spaces and jobnames to be dumped on those systems. The *sysinfo* consists of:

sysname

Specifies the name of the system to be dumped.

If SYSLIST does not specify any address spaces or job names, the dumping services address space (DUMPSRV) is dumped.

sysname* (*space-id[,***space-id***...)****

Specifies the name of the system and its address spaces or jobs to be dumped. *space-id* is of the form:

(*asid*)

Specifies the identifier of the address space.

('*jobname***')**

Specifies the name of the job to be dumped.

The asids and job names can be in any order; each job name must be enclosed in single quotation marks.

You can specify the *sysname* and *jobname* explicitly or with wildcards. See “Wildcards” on page 487.

See the ASID parameter for the limit on address spaces that can be specified for each of the dumps.

DSPNAME

Specifies for the dumps on other systems the same data spaces specified for the local SVC dump.

DSPNAME=(*dspname-entry***[,***dspname-entry***...)**

Specifies the data spaces to be dumped on the other systems. Refer to the DSPNAME values.

Note: If DSPNAME is not specified for the other systems, data spaces are not dumped.

SDATA

Specifies for the dumps on other systems the same SDATA options specified or defaulted for the local SVC dump.

Note: The SDATA options for dumps on other systems are not affected by CHNGDUMP changes in effect for local SVC dumps.

SDATA=(*option***[,***option***...)**

Specifies the specific storage areas you want to dump on the other systems. See the SDA values for the valid options and their definitions.

Note: If SDATA is not specified in the REMOTE parameter, each system uses the SDATA options that apply to any SVC dump on that system. The contents of a dump on each system are affected by CHNGDUMP commands previously entered on the system.

STOR

Specifies for the dumps on other systems the same ranges of virtual storage specified for the local SVC dump.

STOR=(beg,end[,beg,end]...)

Specifies the ranges of virtual storage you want to dump on the other systems. See the STOR values.

Note: If STOR is not specified for the other systems, ranges of virtual storage are not dumped.

SDATA=(option[,option]...)

Specifies the specific storage areas you want to dump. The valid options and their definitions are:

ALLNUC All of the DAT-on nucleus, including page-protected areas, and all of the DAT-off nucleus.

COUPLE XCF related information in the sysplex.

CSA Dumps the following storage:

- Common service area. SDUMP captures data for the entire CSA, including the high virtual CSA storage.
- Virtual storage for 64-bit addressable memory objects created using one of the following services:
 - IARV64 REQUEST=GETCOMMON,DUMP=LIKECSA
 - IARCP64 COMMON=YES,DUMP=LIKECSA
 - IARST64 COMMON=YES,TYPE=PAGEABLE

GRSQ Global resource serialization (ENQ/DEQ/RESERVE) queues. Note that the GRS information collection is related to the GRSCNFxx GRSQ(xx) option setting.

HCAS High virtual CSA storage that is owned by the ASIDs for which SDUMP captures data. See the ASID parameter for details about the ASIDs that are dumped.

Attention: When this option is specified alone, it might result in the inclusion of none of the above the bar CSA storage in the dump.

The following table describes how HCAS, HCNO, and HCSY affect the CSA storage that is captured in an SVC dump:

Table 31. Affects on the CSA storage captured in an SVC dump

Specified SDATA option or options	CSA storage that is included in the dump
CSA	All above the bar and below the bar CSA storage
CSA, HCAS, HCNO, HCSY	All below the bar CSA storage, high virtual CSA storage that is owned by the ASIDs that are included in the dump, high virtual CSA storage for which the owner has ended, and high virtual CSA storage that belongs to the SYSTEM. The dump does not include high virtual CSA storage that is owned by the ASIDs that are excluded from the dump.

DUMP command

Table 31. Affects on the CSA storage captured in an SVC dump (continued)

Specified SDATA option or options	CSA storage that is included in the dump
HCAS, HCNO, HCSY	All high virtual CSA storage that is owned by the ASIDs that are included in the dump, high virtual CSA storage for which the owner has ended, and high virtual CSA storage that belongs to the SYSTEM No below the bar CSA storage is included in the dump.
(Neither CSA nor any of the HCSAxxxx options)	None of the CSA storage is included in the dump.

HCNO High virtual CSA storage for which the owner has ended.

Attention: When this option is specified alone, it might result in the inclusion of none of the above the bar CSA storage in the dump.

HCSY High virtual CSA storage that belongs to the SYSTEM.

Attention: When this option is specified alone, it might result in the inclusion of none of the above the bar CSA storage in the dump.

LPA Link pack area modules for the dumping task.

LSQA Local system queue area and virtual storage for 64-bit addressable memory objects created using one of the following services:

- IARV64 REQUEST=GETSTOR,DUMP=LIKELSQA
- IARCP64 COMMON=NO,DUMP=LIKELSQA
- IARST64 COMMON=NO

NUC Non-page-protected areas of the DAT-on nucleus.

PSA Prefixed storage area for all processors. (Equivalent to the ALLPSA option on the SDUMPC macro.)

NOPSA No prefixed storage area. (Equivalent to the NOALLPSA option on the SDUMPC macro.)

RGN Entire private area and virtual storage for 64-bit addressable memory objects created using one of the following services:

- IARV64 REQUEST=GETSTOR,DUMP=LIKERGN
- IARV64 REQUEST=GETSTOR,SVCDUMPRGN=YES
- IARCP64 COMMON=NO,DUMP=LIKERGN
- IARST64 COMMON=NO

SERVERS

Requests that the registered IEASDUMP.SERVER dynamic exits receive control.

SQA System queue area and virtual storage for 64-bit addressable memory objects created using one of the following services:

- IARV64 REQUEST=GETCOMMON,DUMP=LIKESQA
- IARCP64 COMMON=YES,DUMP=LIKESQA
- IARST64 COMMON=YES,TYPE=FIXED
- IARST64 COMMON=YES,TYPE=DREF

NOSQA No system queue area.

SUM Summary dump.

NOSUM No summary dump.
SWA Scheduler work area.
TRT GTF, system trace, master trace, and NIP hard-copy buffer data.
WLM Workload management related data areas and storage.

XESDATA
coupling facility-related information.

If you do not specify **SDATA**, or if you specify **SDATA** with no options, the system uses these **SDUMPX** macro options: **ALLPSA**, **SQA**, **SUM**, and **IO**. Also, **SDATA=SERVERS** is always used for operator dumps.

STOR=(beg, end [, beg, end] . . .)

Specifies the ranges of virtual storage you want to dump. You can specify the beginning and ending addresses of each range in one of the following formats:

- Up to 16 hexadecimal numbers, such as 10BA040. When using this format, the last eight digits may optionally be preceded with an underscore, such as 01EB_80000000. That can make 64-bit addresses more intelligible.
- Up to 7 decimal numbers followed by a K, such as 50860K.

STRLIST= or STL=(STRNAME=strname . . .)

Used to include in the dump a list of coupling facility structures. Cache and list structures can be dumped; lock structures cannot be dumped. Following are the structure-related keywords:

STRNAME= or STRNM=strname

Designates a particular coupling facility list or cache structure. *strname* is the name of the coupling facility structure to be included in the dump. Any dump options for this structure are replaced when you issue this command. If *strname* does not begin with a letter or is longer than 16 characters the system issues syntax error message IEE866I. You may include more than one **STRNAME=strname** within the parentheses, separated by commas.

CONNAME= or CONNM=conname

When specified for a coupling facility cache structure, requests the user registry information for this user be included in the dump. *conname* is the name of a connected user. If the connected user represented by the *conname* does not exist, the dump will not contain user registry information.

ACCESSTIME= or ACC={ENFORCE or ENF or NOLIMIT or NOLIM}

Indicates whether the dump time limit specified on the **ACCESSTIME** parameter of the **IXLCONN** macro is in effect. When **ACCESSTIME=ENFORCE** is specified, the system holds structure dump serialization no longer than the time interval specified on the **IXLCONN** macro. This is the default. If **ACCESSTIME=0** is specified on the **IXLCONN** macro and **ACCESSTIME=ENFORCE** is specified on the dump request, the structure will not be included in the dump.

When **ACCESSTIME=NOLIMIT** is specified, the dump time limit is not in effect and the system will hold structure dump serialization until processing is completed.

LOCKENTRIES or LOCKE

When specified for a coupling facility list structure, the system includes in the dump the lock table entries for the requested structure. Since lock table

DUMP command

entries do not exist for coupling facility cache structures, this keyword is ignored when specified for a coupling facility cache structure.

USERCNTLS or **UC**

Requests that the user attach controls be included in the dump.

EVENTQS or **EQS**

Requests that the event queues be included in the dump.

(list)

Represents a list of values, ranges of values, or values and ranges of values.

(start1-end1,value2,start3-end3, ...)

EMCONTROLS= or **EMC=ALL** or **(list)**

Specifies which event monitor controls are included in the dump.

EMCONTROLS is valid only for a coupling facility list structure. If specified for a coupling facility cache structure, the structure is not included in the dump.

When EMC=ALL is specified, the event monitor controls associated with all lists in the structure are dumped.

When EMC=(list) is specified, the event monitor controls associated with the specified list number are included in the dump. The values specified for (list) are the decimal list values, 0 – 4294967295. When event monitor controls for a requested list do not exist, they are not dumped and no error results.

COCLASS= or **COC=ALL** or **(list)**

Specifies which cast-out classes are included in the dump. For each cast-out class, the cast-out class controls are dumped and the directory information for each of the entries within the requested cast-out classes are dumped (if SUMMARY is not specified).

COCLASS is valid only for a coupling facility cache structure. If specified for a coupling facility list structure, the structure is not included in the dump.

When COC=ALL is specified, the cast-out class controls for all cast-out classes are dumped along with the directory information for all entries within the classes (if SUMMARY is not specified).

When COC=(list) is specified, the cast-out class controls for (list) are dumped along with the directory information for the entries in the requested cast-out classes (if SUMMARY is not specified). The values specified in a range are the decimal cast-out class values in the range 0 – 65535. When a requested class does not exist, it is not dumped.

STGCLASS= or **SC=ALL** or **(list)**

Specifies which storage classes are included in the dump. For each storage class, the storage class controls are dumped and the directory information for each of the entries within the requested storage classes are dumped (if SUMMARY was not specified).

STGCLASS is valid only for a coupling facility cache structure. If specified for a coupling facility list structure, the structure will not be included in the dump.

When SC=ALL is specified, the storage class controls for all storage classes are dumped along with the directory information for all entries within the classes (if SUMMARY is not specified).

When `STGCLASS=(list)` is specified, the storage class controls for *(list)* are dumped along with the directory information for the entries in the requested storage classes (if `SUMMARY` is not specified). The values specified are the decimal storage class values, 0 – 255. When a requested class does not exist, it is not dumped.

LISTNUM= or LNUM=ALL or (list)

Specifies which lists are included in the dump. The list controls are dumped along with the entry controls for the entries on each requested list (if `SUMMARY` is not specified).

`LISTNUM` is only valid for a coupling facility list structure. If specified for a coupling facility cache structure, the structure is not included in the dump.

When `LISTNUM=ALL` is specified, the list controls for all lists in the coupling facility list structure are dumped along with the entry controls (if `SUMMARY` is not specified).

When `LISTNUM=(list)` is specified, the list controls for *(list)* are included in the dump along with the entry controls for those lists. The values specified are the decimal list values, 0 – 4294967295. The system ignores a zero in the case of `LISTNUM`. No error results. When a requested list does not exist, it is not dumped.

You may use the following keyword to further modify the `STGCLASS`, `COCLASS` and `LISTNUM` keywords:

ADJUNCT= or ADJ={CAPTURE or CAP or DIRECTIO or DIO}

Indicates that the adjunct data for each entry specified by the range is included in the dump. When this keyword is not specified or when adjunct data does not exist for this structure, the adjunct data is not included in the dump.

`ADJUNCT` may not be specified with `SUMMARY`. If they are both specified, a syntax error is issued.

When `ADJUNCT=CAPTURE` is specified, the adjunct data is captured in the facility dump space along with the directory information while dumping serialization is held.

When `ADJUNCT=DIRECTIO` is specified, the adjunct data is written directly to the dump data set after the directory information is captured. The adjunct data is not captured in the structure dump table. The adjunct data may be changing as dumping proceeds.

ENTRYDATA= or EDATA={UNSERIALIZE or UNSER or SERIALIZE or SER}

Indicates that the entry data for each entry within the requested range is included in the dump. When this keyword is not specified or when entry data does not exist for the structure, entry data is not included in the dump.

`ENTRYDATA` may not be specified with `SUMMARY`. If they are both specified, a syntax error is issued.

When `ENTRYDATA=UNSERIALIZE` is specified, the entry data is dumped after structure dump serialization is released. The entry data may be changing relative to the entry controls that were captured while structure dump serialization was held.

When `ENTRYDATA=SERIALIZE` is specified, the entry data is dumped while serialization is held. If `ACCESSTIME=ENFORCE` is specified and the

DUMP command

dump time limit expires before the entry data is written to the dump data set, the system continues to write the entry data to the dump data set even though serialization is not held.

SUMMARY or SUM

Indicates that a summary of the range of classes or lists is dumped. The directory information for the entries is excluded from the dump.

SUMMARY may not be specified with ADJUNCT or ENTRYDATA. If it specified with either of these keywords, a syntax error is issued.

Note:

1. A syntax error is issued if STRNAME is not the first keyword.
2. If CONNAME and ACESSTIME are specified more than one time for a structure, the first CONNAME and the last ACESSTIME are used.
3. When a list number, event monitor controls, a storage class, a cast-out class, or an entry is specified in the STRLIST more than once, it will be dumped more than once. An example of this is when STGCLASS=ALL is specified with COCLASS=ALL. All entries in the coupling facility cache structure are dumped twice. Once grouped by storage class and again grouped by cast-out class.
4. When neither LISTNUM, STGCLASS, EMCONTROLS, or COCLASS is specified, no list or class controls are dumped and no entries are dumped.
5. If a large amount of data is requested to be dumped, the system may not be able to completely dump all the data. You can expect to successfully dump up to a maximum of 47 structures if you specify no more than a total of six ranges. If you must specify more than six ranges, you must specify fewer structures. For each structure less than 47 that you specify, you can specify another 10 ranges, as follows:

Number of structures	Number of ranges
47	6
46	16
45	26
44	36
⋮	⋮

If the system cannot dump all the data you requested, it prioritizes the data according to your specifications on the command in the following manner:

- a. The system will attempt to dump the first requested structure first.
 - 1) Within that structure, the system processes the LOCKENTRIES, EVENTQS, EMCONTROLS, USERCNTLS, COCLASS, STGCLASS, and LISTNUM parameters in the order that they are specified. COCLASS, STGCLASS, EMCONTROLS, and LISTNUM may be specified more than once for a single structure.
 - 2) The system dumps requested serialized data before requested unserialized data starting with the first requested data in the structure and proceeding through the last data that was requested as *serialized*.
- b. The system then dumps the next-requested structure data starting with the first requested data in the structure and proceeding through the last data that was requested as *serialized*.

- c. The system continues in this manner until all *serialized* data in all requested structures has been prioritized for dumping.
- d. The system then dumps any remaining data that was requested as *unserialized* that may not have been dumped beginning with the first-requested structure.

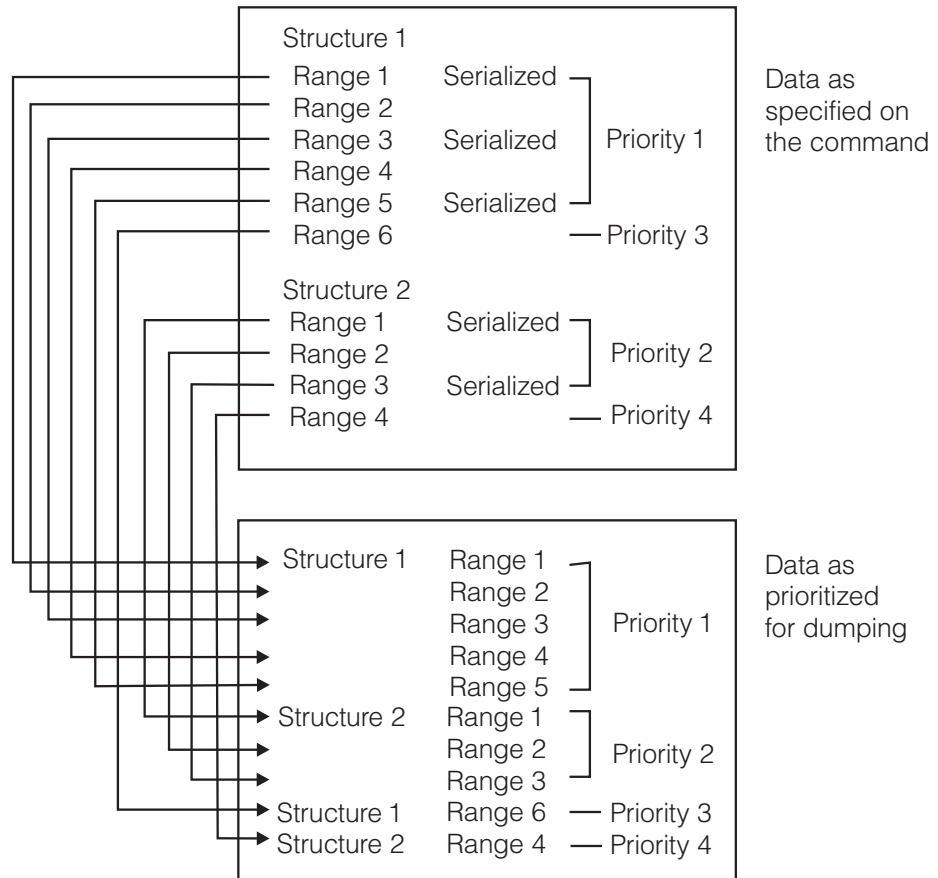

- 6. The CONT parameter allows the operator to provide input to the CHNGDUMP command that spans more than one line of input. You can specify the CONT parameter after any comma within the STRLIST parameter list. If a line of input ends with a comma and any closing parentheses are missing, the system assumes the CONT parameter.

DEFERTND=YES or NO

Specifies whether SDUMP processing should defer setting the tasks of the address space non-dispatchable until the capture of global storage is completed. The default is NO.

CONT

Specifies that you want to continue the reply on another line. The system reissues message IEE094D in response to this parameter, after which you can continue your reply. All parameters can appear on a continuation line.

On a continuation line, you can continue values for any parameter. In a parenthesized expression in the parameters, as you reach the end of a line, add the comma after a value and press ENTER, without typing CONT. The system will issue message IEE094D. In response, continue with the next value in the expression. For example:

DUMP command

```
R 17,JOBNAME=(PQRJOB07,QRSJOB08),REMOTE=(SYSLIST=(S1)),JOBNAME=(PQRJOB07,  
* 18 IEE094D ...  
R 18,QRSJOB08),END
```

If you reach the end of a line with a keyword, a syntax error occurs; for example:

```
JOBNAME=
```

If you reach the end of a line with a value that is not in parentheses, the system considers the reply ended; for example:

```
JOBNAME=PQRJOB07
```

If a reply **begins** with a single quotation mark, double all single quotation marks in the line and enclose the line with quotation marks. For example, a *jobname* in the DSPNAME parameter must be enclosed in quotation marks. If the first line is:

```
R 1,DSPNAME=('job1'.dsp1,
```

Then the second line is:

```
R 2,,''job2''.dsp2, ...)'
```

To avoid this problem, do **not** end the R 1 line with a comma, but instead begin the R 2 line with the comma:

```
R 1,DSPNAME=('job1'.dsp1  
R 2,,'job2'.dsp2, ...)
```

END

Identifies the end of your reply. You need to specify END only when the reply line contains no other parameters. If you do not specify any parameters in the reply other than CONT and END, the system dumps the master address space with the SDATA default options.

Examples

Example 1:

To dump the virtual address space for the job named PAYROLL, including the private area, the non-page-protected areas of the DAT-on nucleus, the GTF, system trace, and master trace data, the contents of storage locations 010CD450 to 010FF400, and the contents of storage locations 0000012K to 0000060K, you can enter:

```
DUMP COMM=(DUMP FOR PAYROLL)
```

In response to this command, the system issues:

```
* id IEE094D SPECIFY OPERAND(S) FOR DUMP COMMAND
```

Reply as follows:

```
R id,JOBNAME=PAYROLL,SDATA=(NUC,RGN,TRT),STOR=(010CD450,010FF400,0000012K,0000060K)
```

Because you did not specify CONT at the end of this reply, the system considers your dump request complete.

Example 2:

To dump the private storage for ASIDs 6, 1, 2, 3, B, and C, so you can solve a problem loop in ASID 6, you can enter:

```
DUMP COMM=(LOOP IN ASID 6)
```

In response to this command, the system issues:

```
* id IEE094D SPECIFY OPERAND(S) FOR DUMP COMMAND
```

If you are sure of the address space you want to dump, but are not yet sure of the storage areas you need to find the problem, you can enter:

```
R id,ASID=(6,1,2,3,B,C),CONT
```

Because you specified CONT, the system reissues:

```
* id IEE094D SPECIFY OPERAND(S) FOR DUMP COMMAND
```

Now, if you decide you need to see only the private areas (including the LSQA and SWA) for the address spaces you are dumping, you can enter:

```
R id,SDATA=(RGN)
```

Because you did not specify CONT at the end of this reply, the system considers your dump request complete.

Example 3:

To dump the default storage areas of the TSO address spaces TERMINAL and CONSOLE so you can help a user stuck in a loop, you can enter:

```
DUMP COMM=(TSO USER TERMINAL IN LOOP)
```

In response to this command, the system issues:

```
* id IEE094D SPECIFY OPERAND(S) FOR DUMP COMMAND
```

If you think the default storage areas might not be enough to find the loop but you are sure that TERMINAL and CONSOLE are the address spaces you want, you can enter, for now:

```
R id,TSONAME=(TERMINAL,CONSOLE),CONT
```

Because you specified CONT, the system reissues:

```
* id IEE094D SPECIFY OPERAND(S) FOR DUMP COMMAND
```

Now, if you decide that the default storage areas are really all you need to see, you can complete the dump request as follows:

```
R id,END
```

Example 4:

Request a dump of two structures named CACHESTRUCTURE and LISTSTRUCTURE.

```
Enter: DUMP COMM=(Dump of CACHESTRUCTURE and LISTSTRUCTURE)
```

```
See: * id IEE094D SPECIFY OPERAND(S) FOR DUMP COMMAND
```

```
Enter: R id,STRLIST=(STRNAME=CACHESTRUCTURE,USERCNTLS,(STGCLASS=ALL),
STRNAME=LISTSTRUCTURE,LOCKENTRIES,(LISTNUM=ALL))
```

This dump will include:

- Structure control data for CACHESTRUCTURE
- User attach control information for CACHESTRUCTURE
- Entry directory information for every entry, grouped by storage class.
- Structure control data for LISTSTRUCTURE

DUMP command

- All lock table entries for LISTSTRUCTURE
- List entry controls for every entry, grouped by list.

Example 5:

Request a dump of LISTSTRUCTURE

```
Enter: DUMP COMM=(LISTSTRUCTURE, PRIORITIZE OPTIONS)
```

```
See: * id IEE094D SPECIFY OPERAND(S) FOR DUMP COMMAND
```

```
Enter: R id,STRLIST=(STRNAME=LISTSTRUCTURE,(LISTNUM=(5-8),SUMMARY),  
LOCKENTRIES,CONT
```

```
See: * id IEE094D SPECIFY OPERAND(S) FOR DUMP COMMAND
```

```
Enter: R id,(LISTNUM=1,ADJUNCT=CAPTURE,ENTRYDATA=UNSERIALIZE))
```

This dump will include:

- Structure control data for LISTSTRUCTURE
- List control data for lists 5-8 (but no directory information for the entries)
- All lock table entries for LISTSTRUCTURE
- List entry controls, adjunct data and entry data for all entries in list 1. The adjunct data was captured with the list entry controls. The entry data may have changed relative to the adjunct data or entry controls that were captured while the system held structure dump serialization.

Example 6:

Request a dump of CACHESTRUCTURE

```
Enter: DUMP COMM=(CACHESTRUCTURE, GROUP ENTRIES)
```

```
See: * id IEE094D SPECIFY OPERAND(S) FOR DUMP COMMAND
```

```
Enter: R x,STRLIST=(STRNAME=CACHESTRUCTURE,CONNAME=USER,  
ACCESSTIME=OVERRIDE,CONT
```

```
See: * id IEE094D SPECIFY OPERAND(S) FOR DUMP COMMAND
```

```
Enter: R x,(STGCLASS=(3-8,10),ENTRYDATA=SERIALIZE),(COCLASS=ALL))
```

This dump will include:

- Structure control data for CACHESTRUCTURE
- Directory information and entry data for all entries in storage classes 3-8 and 10. The entry data is written to the dump data set while structure dump serialization remains held. The entry data is unchanged relative to the captured adjunct or entry control information.
- Directory information for all entries grouped by cast-out class. The changed entries in storage classes 3-8 and 10 are dumped twice.
- The local cache index pertaining to USER is also dumped with each entry (and is dumped again with the changed entries in storage classes 3-8 and 10).

Example 7:

The REMOTE parameter specifies a dump on another system in the sysplex, system S1; the SDATA parameter specifies the same SDATA options used for the local system's dump. The REMOTE parameter also specifies dumps on all the

members of XCF groups G1 and G2; the DSPNAME parameter specifies the DSPNAME values specified for the local system's dump.

```
DUMP COMM=(REMOTE DUMP)
* 5,IEE094D SPECIFY OPERAND(S) FOR DUMP COMMAND
R 5,SDATA=(COUPLE),DSPNAME='XCFAS'.*,CONT
* 6,IEE094D SPECIFY OPERAND(S) FOR DUMP COMMAND
R 6,REMOTE=(SYSLIST=(S1),SDATA,
* 7,IEE094D SPECIFY OPERAND(S) FOR DUMP COMMAND
R 7,GRPLIST=(G1(*),G2(*)),DSPNAME)
```

You need CONT in R 5 because you are at the end of a parameter at the end of the line. You do not need CONT in R 6 because the end of the line is within the parentheses; the system prompts for a reply to complete the parenthetical value.

Example 8:

The REMOTE parameter specifies dumps on S1 and all systems with names matching S2*. On these systems, the dumps are to include a data space with a name matching MYDS* for a job matching J* and a data space named THATDS for address space 01.

```
DUMP COMM=(REMOTE DUMP)
* 6,IEE094D SPECIFY OPERAND(S) FOR DUMP COMMAND
R 6,REMOTE=(SYSLIST=(S1,S2*),DSPNAME=('J*'.MYDS*,01.THATDS))
```

Example 9:

The REMOTE parameter specifies dumps on members M1 and M2 of XCF group G1, with the SQA included in the dumps.

```
DUMP COMM=(REMOTE DUMP)
* 7,IEE094D SPECIFY OPERAND(S) FOR DUMP COMMAND
R 7,REMOTE=(GRPLIST=G1(M1,M2),SDATA=(SQA))
```

Example 10:

Request a dump of jobname MYJOB on all systems in a sysplex, including the local system. JOBNAME=MYJOB requests the dump for the local system; the REMOTE parameter with SYSLIST=*(MYJOB) requests the dump on all remote systems. Note that when specifying the jobname on the SYSLIST parameter, you must place the jobname in single quotation marks ('MYJOB'), and there is no comma between the asterisk and ('MYJOB').

```
DUMP COMM=(MYJOB DUMP)
* 8,IEE094D SPECIFY OPERAND(S) FOR DUMP COMMAND
R 8,JOBNAME=MYJOB,REMOTE=(SYSLIST=*( 'MYJOB' ))
```

Example 11:

Request a dump of all jobs whose names begin with IRLM, on all systems in a sysplex, including the local system. You might have IRLMA, IRLMB, IRLMC, and so on.

```
DUMP COMM=(IRLM DUMP)
* 9,IEE094D SPECIFY OPERAND(S) FOR DUMP COMMAND
R 9,JOBNAME=IRLM*,REMOTE=(SYSLIST=*( 'IRLM*' ))
```

Example 12:

DUMP command

Request a dump of all jobs whose names begin with IRLM, on all systems in a sysplex, including the local system. These jobs are the members of an XCF group called GRP1.

```
DUMP COMM=(IRLM DUMP)
* 10,IEE094D SPECIFY OPERAND(S) FOR DUMP COMMAND
R 10,JOBNAME=IRLM*,REMOTE=(GRPLIST=GRP1(*))
```

Example 13:

Request a dump of all jobs that are members of an XCF group called GRP1, on all systems in a sysplex, including the local system. The jobnames begin with IRLM. Other XCF groups also exist, and contain members whose jobnames also begin with IRLM. You only want the members of GRP1 to be dumped. Note that the PROBDESC=SYSDLOCL parameter causes 2 dumps to be written for the local system: the master scheduler address space, and the address spaces for GRP1.

```
DUMP COMM=(IRLM GRP1 DUMP)
* 11,IEE094D SPECIFY OPERAND(S) FOR DUMP COMMAND
R 11,PROBDESC=SYSDLOCL,REMOTE=(GRPLIST=GRP1(*))
```

Example 14:

Request a dump of *jobname1*, *jobname2*, and *jobname3* on all systems in a sysplex, including the local system.

```
DUMP COMM=(DUMP OF JOB NAMES 1, 2, AND 3)
* 12,IEE094D SPECIFY OPERAND(S) FOR DUMP COMMAND
R 12,JOBNAME=(jobname1,jobname2,jobname3),CONT
* 13,IEE094D SPECIFY OPERAND(S) FOR DUMP COMMAND
R 13,REMOTE=(SYSLIST=(*'jobname1','jobname2','jobname3'))
```

Example 15:

Request a dump of jobname J on all systems in the sysplex except the local system.

```
DUMP COMM=(JOBNAME J DUMP)
* 14,IEE094D SPECIFY OPERAND(S) FOR DUMP COMMAND
R 14,REMOTE=(SYSLIST=*( 'J' ))
```

Example 16:

Request a dump of jobname J on systems named S1 and S2 in a sysplex.

```
DUMP COMM=(DUMP OF JOBNAME J ON S1 & S2)
* 15,IEE094D SPECIFY OPERAND(S) FOR DUMP COMMAND
R 15,REMOTE=(SYSLIST=(S1('J'),S2('J')))
```

Example 17:

Request a dump of jobnames J and Q on all systems in a sysplex, including the local system.

```
DUMP COMM=(JOB NAMES J & Q DUMP)
* 16,IEE094D SPECIFY OPERAND(S) FOR DUMP COMMAND
R 16,JOBNAME=(J,Q),REMOTE=(SYSLIST=*( 'J', 'Q' ))
```

Example 18:

Request a dump of jobname J on all systems in a sysplex, including the local system, and jobname Q only on system S2.

```
DUMP COMM=(JOBNAMES J ALL & Q S2 DUMP)
* 17,IEE094D SPECIFY OPERAND(S) FOR DUMP COMMAND
R 17,JOBNAME=J,REMOTE=(SYSLIST=*( 'J' ),SYSLIST=S2('Q'))
```

Example 19:

Request a dump of the following:

- XCF-related information from all systems in a sysplex including the local system
- All data spaces owned by jobs named MYJOB on all systems in a sysplex, including the local system.

Note that SDATA=(COUPLE) requests the XCF information for the local system. Specifying SDATA on the REMOTE parameter requests the same SDATA option for the remote systems as that used for the local system's dump.

DSPNAME=('MYJOB'.*) requests all data spaces belonging to jobs named MYJOB on the local system (note that while parentheses are included, they are optional, because you are specifying only one *dspname-entry*). Specifying DSPNAME on the REMOTE parameter requests the same DSPNAME option for the remote systems as that used for the local system's dump.

```
DUMP COMM=(XCF & MYJOB DUMP)
* 18,IEE094D SPECIFY OPERAND(S) FOR DUMP COMMAND
R 18,SDATA=(COUPLE),DSPNAME=('MYJOB'.*),CONT
* 19,IEE094D SPECIFY OPERAND(S) FOR DUMP COMMAND
R 19,REMOTE=(SYSLIST=*,SDATA,DSPNAME)
```

Example 20:

Request dumps of the following in a sysplex:

- On the local system, dump the XCF and common service area information.
- On the local system, dump data space DSP1 owned by MYJOB.
- On all remote systems, dump the XCF, common service area, and workload manager information.
- On all remote systems, dump all data spaces owned by MYJOB.

```
DUMP COMM=(VARIOUS DUMP`S)
* 20,IEE094D SPECIFY OPERAND(S) FOR DUMP COMMAND
R 20,SDATA=(COUPLE,CSA),DSPNAME=('MYJOB'.DSP1),CONT
* 21,IEE094D SPECIFY OPERAND(S) FOR DUMP COMMAND
R 21,REMOTE=(SYSLIST=*,SDATA=(COUPLE,CSA,WLM),DSPNAME=('MYJOB'.*))
```

DUMP command parmlib examples:

See *z/OS MVS Initialization and Tuning Reference* for examples of using the DUMP command with the IEADMCxx parmlib member.

DUMPDS command

Use the DUMPDS command to:

- Change the system's list of dump data sets and resources
- Clear full SYS1.DUMP data sets and make them available for dumps
- Set up and alter the configuration of automatic dump data set allocation

DUMPDS command

Table 32. Summary of the DUMPDS Command

Command:	Topic:
DUMPDS ADD	"Adding system dump resources" on page 509
DUMPDS ALLOC	"Enabling and disabling automatic dump data set allocation" on page 512
DUMPDS CLEAR	"Making dump data sets ready to receive dumps" on page 513
DUMPDS DEL	"Deleting system dump resources" on page 513
DUMPDS NAME	"Setting the name-pattern for dump data sets" on page 516

Note:

1. You must issue the DUMPDS command from a console with SYSTEM authority.
2. SVC dump supports pre-allocated dump data sets and automatically allocated dump data sets.

Pre-allocated dump data sets are direct access data sets with names of the form SYS1.DUMPxx, where xx can be any decimal number from 00-99. You can allocate SYS1.DUMPxx data sets with both primary and secondary extents. When you allocate a dump data set, specify enough secondary extents to hold the entire dump. Also, specify RECFM=FB, LRECL=4160 and BLKSIZE=4160.

When automatic allocation is active, the dump is written to SMS-managed storage or to DASD volumes. The system allocates dump data sets of the correct size at the time a dump is requested. No pre-allocation is required for them.

3. A DUMPDS CLEAR or DUMPDS DEL command has no effect on any data set that is receiving an SVC dump when you issue the command.
4. Symbol substitution is supported on all sub-operands (e.g., ADD, ALLOC, ...) of the DUMPDS command except NAME=. (No substitution is done for the DD NAME=name-pattern command because the name-pattern may contain symbols that need to be passed through unchanged. See "Setting the name-pattern for dump data sets" on page 516 for more information about the NAME= sub-operand of the DUMPDS command.)

Syntax

The syntax for each operand of the DUMPDS command is shown immediately preceding its respective parameter list.

DUMPDS or DD

Note: After using the DUMPDS command to make changes, you can use the DISPLAY DUMP command to verify, among other characteristics of dump data set automatic allocation:

- The status
- What resources are defined
- The naming convention
- The title and error-related data for pre-allocated and automatically allocated data sets

See "Displaying dump options or dump data set status" on page 290 for more information.

Adding system dump resources

Use the DUMPDS ADD command to add specific SYS1.DUMP data sets, SMS classes, or direct access storage device (DASD) volumes to the system's list of dump data set resources.

DD ADD
<pre>DD ADD, {DSN={nn } } {(nn[,nn]...) } {nn-nn } {(nn-nn[,nn-nn]...) } {(nn[,nn]...,nn-nn[,nn-nn]...)} {ALL } {(ALL) } {SMS={class } } {(class[,class]...)} {VOL={volser } } {(volser[,volser]...)} Where class represents: {storclas } {([DATA D=[dataclas]] [,MGMT M=[mgmtclas]] [,STOR S=[storclas]])}</pre>

ADD, DSN=*nn* or ALL

Identifies the DASD data sets you request the system to add to its list of SYS1.DUMP data sets. You should allocate, catalog, and protect the data sets you specify before using this command.

If any DASD data set you specify is empty, or does not contain a valid dump, the system marks it as available for a dump. If any data set you specify is full and you want to make it available for a dump, you must clear it.

If you do not want to keep the contents of the data set, issue a DUMPDS CLEAR,DSN= command for the data set. That will clear the data set and mark it as available for a dump, but not save the data set contents.

DUMPDS ADD,DSN= does not process any DASD SYS1.DUMP data set that is already on the system's list of SYS1.DUMP data sets.

nn The two-digit decimal identifier (00-99) of a DASD SYS1.DUMP data set you want the system to add to its list of SYS1.DUMP data sets. You can specify one or more single identifiers and/or one or more ranges of identifiers. For any range of identifiers you specify, the first identifier must be less than the second. If you specify more than one range, use a comma between them and enclose the entire set in parentheses.

ALL

Directs the system to add to its list of SYS1.DUMP data sets all the cataloged DASD SYS1.DUMP data sets not already on the list.

ADD, SMS=*class*

Designates SMS classes you request the system to add to its list of resources eligible for allocation as dump data sets. Installation-written automatic class selection (ACS) routines, if present, may use but can override a data, management, or storage class you specify. When a dump is taken, allocation of

DUMPDS command

a dump data set to an SMS class occurs only if SMS is active, and allocation of a dump data set to an SMS resource takes place only if automatic allocation is active.

class

The SMS class(es) you want the system to consider allocating as dump data sets. If you specify multiple SMS classes, enclose them in parentheses and separate them with commas.

(DATA=*dataclas*, MGMT=*mgmtclas*, STOR=*storclas*)

The SMS class consisting of the specified combination of data, management, and storage class you want SMS to pass to the ACS routines.

dataclas

The 1-8 character name of the data class you want SMS to pass to the ACS routine.

mgmtclas

The 1-8 character name of the management class you want SMS to pass to the ACS routine.

storclas

The 1-8 character name of the storage class you want SMS to pass to the ACS routine.

The DATA, MGMT, and STOR keywords are optional.

Note: If the SMS option is not specified and the dump data set exceeds 64,000 tracks, the dump data set will be allocated with DSNTYPE=LARGE specified. This will override any DSNTYPE specification in the data class that might be assigned.

Specifying SMS=() with no classes is valid and implies that the dump data sets will use the installation-assigned SMS constructs using the ACS routines.

ADD,VOL=*volser*

Identifies the DASD volume(s) to add to the list of resources for automatic allocation of dump data sets. Allocation will assign space from the first resource in the list until that resource is full, then use the next resource. Dump data sets that will occupy less than 64,000 tracks can have their attributes changed by SMS ACS routines. Dump data sets that exceed 64,000 tracks will be allocated using the DSNTYPE=LARGE attribute, and that attribute cannot be changed by ACS routines unless SMS=() is specified. If a dump is taken when automatic allocation is active, allocation of a dump data set to the specified DASD volume takes place if either of the following conditions occurs:

- No SMS classes are defined or assigned by the SMS ACS routines.
- SMS classes are defined but an attempt to allocate a dump data set using those classes failed (for example because of space problems).

volser

The 1-6 character volume serial identifier of the DASD volume you want added to the system's list of resources for automatic allocation. You can specify one or more DASD volume serial identifiers. (Enclose multiple volume serial identifiers in parentheses and separate them with commas.)

If you want to process the contents of any dump data set, use the interactive problem control system, IPCS. For more information about IPCS, see the *z/OS MVS IPCS User's Guide*, GC28-1631.

Notes:

1. Protect the data sets using your normal password or RACF procedures.
2. If resources assigned for automatic allocation become full, the system attempts to write dumps to pre-allocated dump data sets.

Example 1

To put the allocated and cataloged direct access data set SYS1.DUMP02 on the system's list of SYS1.DUMP data sets, enter:

```
DUMPDS ADD,DSN=02
```

Example 2

To add the following allocated and cataloged direct access data sets to the system's list of SYS1.DUMP data sets,

- SYS1.DUMP00-SYS1.DUMP05
- SYS1.DUMP08
- SYS1.DUMP10-SYS1.DUMP12

enter:

```
DD ADD,DSN=(00-05,08,10-12)
```

Example 3

To add to the system's list of SYS1.DUMP data sets all the allocated and cataloged direct access dump data sets not already on the list, enter:

```
DD ADD,DSN=ALL
```

Example 4

To specify the storage class DUMPC1, or if it is not available, storage class DMPADIT, for SMS to validate for use as dump data sets (which an ACS routine could override), enter:

```
DD ADD,SMS=(DUMPC1,DMPADIT)
```

Example 5

To use the data, management, and storage class defaults defined by the installation's SMS ACS routine, enter:

```
DD ADD,SMS=()
```

Example 6

To request that SMS consider allocating dump data sets from data class DUMP and management class KEEP, enter:

```
DD ADD,SMS=(DATA=DUMP,MGMT=KEEP,STOR=)
or
DD ADD,SMS=(D=DUMP,M=KEEP)
```

DUMPDS command

Example 7

To specify that an installation's ACS routine consider allocating as dump data sets SMS storage class DUMP, and then when DUMP is filled, storage class DUMPTEMP, enter:

```
DD ADD,SMS=((STOR=DUMP),(S=DUMPTEMP))
```

The installation's SMS ACS routine will define the data and management classes for these storage classes. If you desire specific data or management classes, you must explicitly identify them. For example, to use management class KEEP with storage class DUMP, and management class SCRATCH with storage class DUMPTEMP, enter:

```
DD ADD,SMS=((STOR=DUMP,M=KEEP),(M=SCRATCH,S=DUMPTEMP))
```

Enabling and disabling automatic dump data set allocation

Use the DUMPDS ALLOC command to activate or inactivate the automatic allocation of dump data sets.

DD ALLOC
DD ALLOC={ACTIVE INACTIVE}

ALLOC=ACTIVE

Dump data sets are automatically allocated when a dump is requested. Any of the resources that have been defined by the DUMPDS ADD command as available for automatically allocated dump data sets are used. If no automatic allocation resources are defined, the system issues message IEA799I and writes the dump to a pre-allocated dump data set on its list of SYS1.DUMP data sets. If no pre-allocated dump data sets are on the system's list of SYS1.DUMP data sets, then message IEA793A is issued requesting operator intervention. The requested dump is kept in virtual storage until an automatic allocation resource is defined, a pre-allocated dump data set is made available either by allocating a new one or clearing an existing one, or the dump is deleted either by operator request or expiration of the CHNGDUMP MSGTIME parameter.

ALLOC=INACTIVE

This is the initial state of the system after IPL. Dump data sets are not automatically allocated when a dump is requested. Resources defined by the DUMPDS ADD command as available for automatic allocation of dump sets are not used. Any requested dump will be written to a pre-allocated dump data set specified on the system's list of SYS1.DUMP data sets. If no pre-allocated dump data sets are specified on the system's list of SYS1.DUMP data sets, then message IEA793A is issued requesting operator intervention. The requested dump is kept in virtual storage until automatic allocation is enabled, a pre-allocated dump data set is made available either by allocating a new one or clearing an existing one, or the dump is deleted either by operator request or expiration of the CHNGDUMP MSGTIME parameter.

Example:

To make the automatic dump data set allocation function inactive, without changing the automatic allocation resources or naming convention, enter:

```
DD ALLOC=INACTIVE
```

This is the system default.

Making dump data sets ready to receive dumps

Use the DUMPDS CLEAR command to empty the specified data set and mark it as available to receive a dump.

DD CLEAR,DSN	
DD CLEAR,DSN={nn	}
{(nn[,nn]...)	}
{nn-nn	}
{(nn-nn[,nn-nn]...)	}
{(nn[,nn]...[,nn-nn[,nn-nn]...)	}
{ALL	}
{(ALL)	}

CLEAR,DSN=*nn* or ALL

Clear and mark as available for dumps the specified direct access dump data sets on the system's list of SYS1.DUMP data sets. The system clears each full direct access dump data set by writing an end-of-file mark at the beginning of the data set.

A DUMPDS CLEAR,DSN= command does not process any data set that is not in the system's list of SYS1.DUMP data sets.

nn The two-digit decimal identifier (00-99) of a direct access SYS1.DUMP data set you want to clear and mark as available for a dump. You can specify one or more single identifiers and/or one or more ranges of identifiers. If you specify a range of identifiers, the first identifier **must** be less than the second identifier.

ALL

Clears and marks as available for a dump all direct access dump data sets in the system's list of SYS1.DUMP data sets.

Example 1:

To clear, and mark as available for dumps, the direct access data sets SYS1.DUMP00-SYS1.DUMP05 and SYS1.DUMP09, enter:

```
DD CLEAR,DSN=(00-05,09)
```

Example 2:

To clear and mark as available for dumps all the full direct access data sets on the system's list of SYS1.DUMP data sets, enter:

```
DD CLEAR,DSN=(ALL)
```

Deleting system dump resources

Use the DUMPDS DEL command to remove from the system's list of dump data set resources specific SYS1.DUMP data sets, SMS classes or DASD volumes.

DUMPDS command

DD DEL
<pre>DD DEL, {DSN={nn } } { (nn[,nn]...) } { nn-nn } { (nn-nn[,nn-nn]...) } { (nn[,nn]...,nn-nn[,nn-nn]...) } { ALL } { (ALL) } {SMS={class } } { (class[,class]...) } { ALL } { (ALL) } {VOL={volser } } { (volser[,volser]...) } { ALL } { (ALL) }</pre>
Where class represents:
<pre>{storclas { ([DATA D=[dataclas]] [,MGMT M=[mgmtclas]] [,STOR S=[storclas]]) }</pre>

DEL,DSN=*nn* or ALL

The system is to remove the specified direct access dump data sets from its list of SYS1.DUMP data sets. In response to this command, the system does not uncatalog or change the space allocation for any data set you specify.

A DUMPDS DEL,DSN= command does not process any data set that is not on the system's list of SYS1.DUMP data sets.

nn The two-digit decimal identifier (00-99) of a cataloged direct access SYS1.DUMP data set you want to remove from its list of SYS1.DUMP data sets. You can specify one or more single identifiers or one or more ranges of identifiers. If you specify a range of identifiers, the first identifier **must** be less than the second identifier.

ALL

The system is to remove all pre-allocated direct access dump data sets from its list of SYS1.DUMP data sets.

DEL,SMS=*class* or ALL

The system is to remove the specified SMS resources from the system's list of resources for automatic allocation of dump data sets. Removing SMS resources does not inactivate automatic allocation of dump data sets.

class

The SMS resource you want to remove from the system's list of resources for automatic allocation. You can specify one or more SMS resources. Enclose multiple resources in parentheses, separated by commas.

storclas

The SMS resource consisting of the specified 1-8 character SMS storage class you want removed from the system's list of resources for automatic allocation.

(DATA=*dataclas*,MGMT=*mgmtclas*,STOR=*storclas*)

The SMS resource consisting of the specified combination of data,

management, and storage class you want removed from the system's list of resources for automatic allocation.

dataclas

The 1-8 character SMS data class you want specified for this allocation resource.

mgmtclas

The 1-8 character SMS management class you want specified for this allocation resource.

storclas

The 1-8 character SMS storage class you want specified for this allocation resource.

The DATA, MGMT, and STOR keywords are optional and may be specified only once per resource.

ALL

Requests that all SMS resources classes be removed from the system's list of resources available for automatic dump data set allocation.

DEL,VOL=*volser* or ALL

Remove the specified direct access volume(s) from the system's list of resources for automatic allocation of dump data sets. Removing direct access volumes does not inactivate automatic allocation of dump data sets.

volser

The 1-6 character volume serial number of the direct access volume you want to remove from the system's list of resources for automatic allocation. You can specify one or more direct access volume serial numbers. Multiple volume serial numbers must be enclosed in parentheses and separated by commas.

ALL

Request that all DASD volumes be removed from the system's list of resources available for automatic allocation of dump data sets.

Example 1:

To remove SYS1.DUMP02 from the system's list of SYS1.DUMP data sets, enter:

```
DD DEL,DSN=02
```

Example 2:

To remove all direct access data sets from the system's list of SYS1.DUMPnn data sets, enter:

```
DD DEL,DSN=ALL
```

Example 3:

To remove SMS resources consisting of the storage classes DUMPC1 and DMPADIT from the system's list of resources for automatic allocation of dump data sets, enter:

```
DD DEL,SMS=(DUMPC1,DMPADIT)
   or
DD DEL,SMS=(DUMPC1,(STOR=DMPADIT))
```

Setting the name-pattern for dump data sets

Use the DUMPDS NAME command to establish a name-pattern for automatically allocated dump data sets.

DD NAME
DD NAME=name-pattern

The parameter is:

NAME=*name-pattern*

The system names automatically allocated dump data sets according to the naming convention specified by the name-pattern. The name-pattern can include both text and system symbols. The system substitutes text for the system symbols when it creates data set names.

The system default name-pattern is:

```
SYS1.DUMP.D&YYMMDD..T&HHMMSS..&SYSNAME..S&SEQ.
```

Note: If you want to use a name pattern other than the system default, place the DUMPDS NAME command before the DUMPDS ADD commands, so that the system uses the correct name pattern for the added resources. Using a different name pattern could cause the system to use different RACF profiles for the allocation.

Before you specify system symbols in the DUMPDS NAME command, read the rules and recommendations for using system symbols in commands in “Sharing system commands” on page 15.

Note:

1. All name-patterns must specify the &SEQ. sequence number system symbol to ensure uniqueness. The system rejects the name-pattern if you do not specify &SEQ..
2. When you change the installation naming convention for dump data sets, also change the procedures for protecting them (password or RACF protection).
3. If the installation has a SYSNAME that begins with a numeral, the default will be changed to either SYS1.DUMP.D&YYMMDD..T&HHMMSS..S&SYSNAME..S&SEQ. or | SYS1.DUMP.D&YYMMDD..T&HHMMSS..S&SYSNAME(2&colon.8)..S&SEQ to ensure that the resulting S&SYSNAME position will have only eight characters.
4. Names generated by a name-pattern must adhere to MVS data set naming conventions and limitations. Ensure that system symbols do not return a numeric character as the first character of any qualifier in the data set name. For example, in the default name-pattern:

```
SYS1.DUMP.D&YYMMDD..T&HHMMSS..&.SYSNAME..S&SEQ.
```

&HHMMSS, &SEQ, and &YYMMDD return numeric substitution texts. Each symbol is preceded by an alphabetic character to avoid placing a numeric character in the first character of each qualifier. If resolved substitution texts create a data set name that is not valid, the system rejects the name-pattern and issues message IEE855I. The previous name-pattern remains in effect.
5. The DUMPDS NAME function will not work when the command is issued from an MCS, HMCS or SMCS console and the character '&' is specified as a command delimiter. Command delimiters are defined using the CMDDELIM

parameter on the INIT statement of the CONSOLxx parmlib member. See *z/OS MVS Initialization and Tuning Reference* for more information on defining command delimiters.

Example:

To establish automatically allocated dump data sets with names such as
SYS1.USERIDX.T025930.S00001

where the system name is *SYS1* and *USERIDX* is the name of the job requesting the dump, enter:

```
DD NAME=&SYSNAME..&JOBNAME..T&HHMMSS..S&SEQ.
```

FORCE command

Consider using the FORCE command as a last resort when the CANCEL command still fails to perform its function after you have issued it several times.

Table 33 summarizes the tasks that the FORCE command can perform. “Considerations” discusses several considerations about using the FORCE command.

Table 33. FORCE command tasks

Task - Immediately terminate...	Syntax
<ul style="list-style-type: none"> A job in execution A running Advanced Program-to-Program Communication/MVS (APPC/MVS) transaction program A started task 	FORCE <i>jobname</i>
<ul style="list-style-type: none"> A specific task (<i>ttttt</i>) within the indicated <i>jobname</i>. 	FORCE <i>jobname</i> ,TCB= <i>ttttt</i>
<ul style="list-style-type: none"> A time-sharing user (U=<i>userid</i>) 	FORCE U= <i>userid</i>
<ul style="list-style-type: none"> A started task A MOUNT command An external writer allocation The output processing for a job A z/OS UNIX process 	FORCE <i>identifier</i>

Considerations

- FORCE is not a substitute for CANCEL. Unless you first issue CANCEL for a cancelable job, the system issues error message IEE838I. The steps to use in the process are:
 - Issue the CANCEL *nnn* command, making several attempts if necessary.
 - Use the DUMP command if you want a dump produced. Respond to the prompt for parameters with the job name or ASID of the “stuck” job, as well as ASID(1)=MASTER.
 - Issue the FORCE *nnn*,ARM command for non-cancelable procedures.
 - Issue the FORCE *nnn* command only when the previous steps fail.
- Attention:** Never use the FORCE command without first understanding that:
 - After issuing FORCE, you might have to re-IPL.

FORCE command

- If you issue FORCE for a job in execution or for a timesharing user, the system deletes the affected address space and severely limits recovery unless you use the ARM parameter. (The ARM parameter is described in “Parameters.”)
- If you need a dump, you must *issue the DUMP command before you issue the FORCE command*. Once you have issued a FORCE command, it is usually *not* possible to get a dump of the failing address space.
- If your system was part of a global resource serialization ring (GRS=START, GRS=JOIN, or GRS=TRYJOIN was specified at IPL) but has been quiesced (by entering the VARY GRS(*system name*), QUIESCE command), FORCE processing might not complete immediately. The system suspends termination of all address spaces holding global resources until the quiesced system rejoins the ring or is purged from the ring. Use a DISPLAY GRS command to determine GRS status.
- Do not FORCE a job that is in a loop; use the RESTART function. See “Using the system restart function” on page 20 for more information.
- The availability manager (AVM) cannot be ended by a STOP or CANCEL command. To end AVM, a FORCE AVM,ARM command is required.
- When you use the FORCE command to end the availability manager (AVM) address space, the operator must restart that address space by issuing the START AVM,SUB=MSTR command.
- You can enter FORCE only from a console with master authority.

Syntax

The complete syntax for the FORCE command is:

```
FORCE {jobname } [,ARM] [,A=asid] [,ARMRESTART] [,TCB=ttttt] [,RETRY=NO|YES]]  
      {[jobname.]identifier}  
  
      {U=userid } [,ARM] [,A=asid] [,TCB=ttttt] [,RETRY=NO|YES]]
```

Parameters

jobname

The name of the batch job, started task, or APPC/MVS transaction program you want to end.

The name of a started task is based on whether the JOBNAME= keyword was specified on the START command.

If JOBNAME= was specified, *jobname* is the name assigned to the started task.

If JOBNAME= was not specified and the source JCL for the started task is

- A *job*, the system will use the job name from the JCL JOB statement.
- A *procedure*, the system will use the member name as the job name.

Notes:

1. When you use the FORCE command to end a job in execution, you also terminate the address space for the job and any other tasks executing in that address space. If you use FORCE for a job running under an initiator, you terminate the initiator along with the job. With JES2 on your system, you must issue another START command to recover use of such an initiator. With JES3 on your system, this additional START command might not be necessary.

2. When you force an APPC/MVS transaction program, you can find *jobname* (the transaction program's name as specified in the TP PROFILE in the address space) on the output by issuing a DISPLAY ASCH,A command.
3. Entering FORCE for an external writer while the system is allocating the writer to a job terminates both the device allocation and the writer itself. Entering FORCE for an external writer while the writer is processing output for a job terminates both the output processing and the writer itself.

[*jobname.*]identifier

The identifier for the unit of work to terminate, optionally preceded by the job name. You can specify the following types of identifiers:

- The identifier that was specified on the START command.
- *[/]devnum*, the device number that was specified when the START or MOUNT command was entered. The device number is 3 or 4 hexadecimal digits, optionally preceded by a slash (/). You can precede the device number with a slash to prevent ambiguity between the device number and a device type or identifier.
- *devicetype*, the type of device specified when the START or MOUNT command was issued.

If no identifier was specified on the START command, the system assigns temporary identifier "STARTING" to the unit of work, until the system can assign an identifier according to the following order of precedence:

1. If an identifier was not specified on the START command, the identifier is the device type (for instance, 3410) or device number (for instance, X'0000') specified on the START or MOUNT command.
2. If an identifier, a device type, or a device number was not specified on the START or MOUNT command, the identifier is the device type specified on an IEFORDER DD statement (invoking a cataloged procedure) in the JCL.
3. If none of these was specified, the identifier defaults to the job name.

Specifying both the job name and the entire identifier causes the command to take effect if *one and only one* work unit with that combination of job name and identifier is running. If two or more work units with the same combination of job name and identifier are running, see the description of the **A=asid** parameter.

U=userid

The user ID of the timesharing user to terminate.

If the user is just logging on and does not yet have a unique name, you must find out the address space identifier for the user (as explained under the **A=asid** parameter) and use the following version of the command:

```
FORCE U=*LOGON*,A=asid
```

ARM

The system is to terminate the specified job, timesharing user, or started procedure if it is non-cancelable. If the FORCE ARM command fails to terminate the address space within a reasonable time, reissue the FORCE ARM command. The ARM parameter executes normal task termination routines without causing address space destruction. The system rejects this parameter if the address space for the specified job, timesharing user, or started procedure cannot be terminated or should be terminated using the CANCEL command. If the FORCE command still fails after several attempts, try issuing the FORCE command without the ARM parameter.

FORCE command

Note: This keyword is not related to the ARMRESTART parameter and the functions of the automatic restart manager.

A=asid

The hexadecimal address space identifier of the work unit to terminate.

If two or more work units are running with the same job name, identifier, combination of job name and identifier, or user ID that you specified on the FORCE command, the system rejects the command because it does not know which work unit to terminate. To avoid this, you must add the parameter *A=asid* to your original FORCE command in order to specify the address space identifier of the work unit.

To find out the address space identifier for a unit of work, you can use the DISPLAY command in one of the following ways:

DISPLAY JOBS,ALL

Lists the address space identifiers for all batch jobs and started tasks.

DISPLAY ASCH,ALL

Lists the address space identifiers for all APPC/MVS transaction programs.

DISPLAY TS,ALL

Lists the address space identifiers for all logged-on timesharing users.

DISPLAY OMVS,ASID=ALL or

DISPLAY OMVS,A=ALL

Lists the address space identifiers for all z/OS UNIX processes.

ARMRESTART

Indicates that the batch job or started task should be automatically restarted after the force has completed, if it is registered as an element of the automatic restart manager. If the job or task is not registered, or if you do not specify the ARMRESTART parameter, the system will not automatically restart the job or task. The ARMRESTART parameter is not valid with the *U=userid* parameter.

TCB=tttttt

The 6-digit hexadecimal TCB address of the task to terminate. Exactly six digits are required; leading zeroes are permitted. This command is rejected if the address space in which the task is running does not support the FORCE TCB command. Only use this command with the guidance of IBM Support.

RETRY=NO|YES

Only accepted for FORCE TCB. Indicates whether retry will be attempted on ABTERM. The default for RETRY is NO.

Examples

Example 1: To terminate an earlier MOUNT command for a 3380 device, enter:

```
FORCE 3380
```

Example 2: To terminate an earlier MOUNT command for the device number 3380, enter:

```
FORCE /3380
```

Example 3: To remove job JOBXYZ from the system, enter:

```
FORCE JOBXYZ
```

Example 4: To stop device allocation for writer 1AF and terminate the writer itself, enter during device allocation for writer 1AF:

```
FORCE 1AF
```

Example 5: To stop the output processing on a writer with device number B1AF and terminate the writer itself, enter:

```
FORCE /B1AF
```

Example 6: To log user A237 off the system, enter:

```
FORCE U=A237
```

Example 7: To terminate the non-cancelable job BIGTASK, enter:

```
FORCE BIGTASK,ARM
```

Example 8: To terminate the non-cancelable job SERVICE with the address space identifier of 1A8, enter:

```
FORCE SERVICE,ARM,A=1A8
```

Example 9: To FORCE an APPC/MVS transaction program whose job name is CALENDAR and whose address space identifier is 3B, enter:

```
FORCE CALENDAR,A=3B
```

Example 10: To end the task whose TCB address is X'5E6D90' in the JOBA1 address space issue:

```
FORCE JOBA1,TCB=5E6D90
```

HALT command

Use the HALT command to record statistics before stopping the operating system. After you have stopped all subsystem processing (through the use of the appropriate subsystem command) and the system notifies you that all system activity has completed, you can issue the HALT EOD command to ensure that important job and system statistics and data records in storage are recorded.

Note: Do not use the HALT command if you intend to keep running, because this command:

- closes the system log
- allows SMF to continue writing records after switching to a new data set. During the next IPL, you might see message IEE949I, indicating the presence of old SMF data from a previous IPL. This SMF data was written after HALT was issued.

Syntax

The complete syntax for the HALT command is:

```
Z EOD
```

The HALT EOD command causes the system to take the following steps:

- Store the internal I/O device error counts in the logrec data set.
- Empty the SMF buffers onto the active SMF data set in SYS1.MANx.
- Switch to another SMF data set in SYS1.MANx, allowing the previously active SMF data set to be dumped according to your installation's procedures.
- Close the system log and put it on the print queue.

HALT command

When these actions are completed, the system sends you the message:
IEE334I HALT EOD SUCCESSFUL.

For more information about SMF HALT processing, see *z/OS MVS System Management Facilities (SMF)*.

IOACTION command

Use the IOACTION command to stop and resume I/O activity to direct access storage devices (DASDs) without varying the DASD offline, when the DASD is shared between systems AND is in recovery by the input/output system (IOS).

CAUTION:

Use this command only in response to the IOS recovery messages IOS427A and IOS062E and wait state X'062'.

After the IO STOP command is entered, the system allows several seconds for current I/O activity to end.

Do not leave devices stopped any longer than necessary to perform recovery. System storage is used by all initiated I/O operations and is only freed after the I/O operations complete.

Do not use this command for devices that contain system-owned data sets or the system residence volume, or page data sets. Also, EREP will not run while devices are stopped.

The system displays message IOS601I to remind you that I/O activity is stopped to the specified DASD. This message remains displayed until all I/O activity is resumed with the IOACTION RESUME command.

Syntax

The complete syntax for the IOACTION command is:

```
IO {STOP,DEV=( [/] devnum[, [/] devnum] ... ) }  
   {STOP,DEV=( [/] lowdevnum-[/] highdevnum[, [/] lowdevnum-[/] highdevnum] ... ) }  
   {RESUME,DEV=( [/] devnum[, [/] devnum] ... ) | ALL }  
   {RESUME,DEV=( [/] lowdevnum-[/] highdevnum[, [/] lowdevnum-[/] highdevnum] ... ) }
```

Note: You can enter individual device numbers and ranges on the same command. For example:

```
IO RESUME,DEV=(/2233,/990-/1012,160)
```

Parameters

STOP,DEV

The system stops all I/O activity to the specified DASD. The system allows several seconds for current activity to complete. You do not have to enter the parentheses when specifying only one device. The system displays message IOS601I to remind you that I/O activity is stopped to specified DASD. To display stopped DASD, enter DISPLAY IOS,STOP.

Note: Before stopping a device, enter `D U,DASD,ALLOC,devnum` to determine what data sets will be affected. If any system-owned data sets, such as `SYS1.LINKLIB`, are stopped, the system will be affected.

RESUME,DEV

The system resumes normal I/O activity to the specified devices. When `ALL` is specified, I/O activity is resumed on any device that had been stopped by an `IOACTION STOP` command on that system. You do not have to enter the parentheses when specifying only one device.

[/]devnum

The device number of a DASD for which the system is to stop or resume I/O activity. You do not have to enter the parentheses when specifying only one DASD.

[/]lowdevnum-[/]highdevnum

The lower device number *lowdevnum* and the upper device number *highdevnum* of a range of DASDs for which the system is to stop or resume I/O activity. You do not have to enter the parentheses when specifying only one range of DASDs.

A device number is 3 or 4 hexadecimal digits, optionally preceded by a slash (/).

Example 1:

To stop I/O activity to device numbers 1A0 through 1AF, enter:

```
IO STOP,DEV=(1A0-1AF)
```

Example 2:

To stop I/O activity to device number 1B0, enter:

```
IOACTION STOP,DEV=1B0
```

Example 3:

To resume I/O activity to device number 1B0 and device numbers 1A0A through 1AFA, enter:

```
IO RESUME,DEV=(1B0,1A0A-1AFA)
```

Example 4:

To resume I/O activity to device number 3480, enter:

```
IO RESUME,/3480
```

Example 5:

To resume I/O activity to all devices previously stopped, enter:

```
IO RESUME,ALL
```

LIBRARY command

Use the `LIBRARY` command to perform any of several tasks associated with tape drives and tape volumes.

For a complete description of the syntax and parameters of the `LIBRARY` command, including the tasks that command can perform, refer to *z/OS DFSMS*

LIBRARY command

OAM Planning, Installation, and Storage Administration Guide for Tape Libraries, and z/OS DFSMS OAM Planning, Installation, and Storage Administration Guide for Object Support.

LOG command

Use the LOG command to make an entry into the system log, the OPERLOG, or the system log and the OPERLOG.

Syntax

The complete syntax for the LOG command is:

```
L 'text'
```

Parameters

'text'

The entry (up to 122 characters) to be made in the system log, the OPERLOG or the system log and the OPERLOG.

Note: Lowercase characters in quotation marks are not converted to uppercase.

Example:

To include the following comment in the system log, the OPERLOG or the system log and the OPERLOG enter:

```
L 'DEVICE 235 OFFLINE FOR REPAIRS'
```

LOGOFF command

Use the LOGOFF command to log off from an MCS, HMCS or SMCS console.

LOGOFF is the recommended method of ending an SMCS console session.

Syntax

The complete syntax for the LOGOFF command is:

```
LOGOFF
```

You must issue LOGOFF when you leave your console and your installation requires operators to log on before issuing commands.

When your installation requires LOGON, the LOGOFF command leaves the console in a secure state. This applies to MCS and HMCS consoles only. The system does not accept commands from this console until another LOGON command is completed.

For SMCS consoles, use LOGOFF to deactivate the console. You can use LOGOFF whether the operator has logged on to the SMCS console or not.

If a TIMEOUT value is specified for the console and an operator has logged on with a user ID, the system will automatically issue a LOGOFF command after the number of minutes specified by TIMEOUT has elapsed without any console input activity (pressing an attention-generating key, such as Enter, PA1, PA2, or a PFK).

For MCS and HMCS consoles, if LOGON is automatic at your installation, the system issues another automatic MCS LOGON command for this console, after performing the LOGOFF.

If a TIMEOUT value is specified for a console with LOGON(AUTO), a LOGOFF command *will not* be issued (that is, the TIMEOUT value will be ignored) if the user ID and console name are the same.

Example:

To leave your console secure, enter:
LOGOFF

LOGON command

Use the LOGON command to identify yourself to the system when your installation requires operators to log on before issuing commands.

The LOGON command enables an operator to access the SMCS console. An installation can indicate that this command be mandatory.

Guideline: If an SMCS console session can be established from outside a secure area, logging on should be mandatory.

Typically, an operator logs on to a single console. If your installation wishes to allow an operator to be concurrently logged on to multiple consoles within a system or sysplex, your security administrator can allow this. When the security profile MVS.MULTIPLE.LOGON.CHECK is defined in the OPERCMDS class, an operator may log on to multiple consoles. Defining this profile allows all operators to be able to log on multiple times. There is no limit to the number of consoles to which an operator may be logged on. Operators are still required to provide a password while logging on to each console.

To remove the LOGON prompt from the screen for MCS and HMCS consoles, use the CLEAR key or the PA2 key. For SMCS consoles, the prompt cannot be cleared from the screen until the console is successfully logged on. To restore the prompt enter:

```
LOGON userid
```

The LOGON command restores the logon prompt display.

The *userid* is an 8-character field where you enter your operator *userid*. The *userid* parameter is optional; the system will prompt you for it. Issuing the LOGON or LOGON *userid* command results in the LOGON prompt being displayed. The LOGON prompt is presented in the Syntax section of the LOGON command.

The LOGON command has been architected such that all keywords and keyword values appear in the same position when the LOGON command is issued. All LOGON commands are issued as if they were issued from a typical console that is 80 columns wide. For the architected LOGON mapping, which is mapped by

LOGON command

CNZMYLGN, see *z/OS MVS Data Areas* in the *z/OS Internet library* (<http://www.ibm.com/systems/z/os/zos/bkserv/>).

Note that the system does not substitute text for system symbols specified in the LOGON command.

Syntax

The complete syntax for the LOGON prompt follows the message:

```
IEE187I  ENTER LOGON PARAMETERS

LOGON {userid}      PASSWORD {password}

GROUP [racfgroup]  SECLABEL [label]
```

Parameters

LOGON {*userid*}

The panel displays the LOGON prompt in a protected field. The *userid* is an 8-character field where you enter your operator *userid*. The *userid* parameter is required.

PASSWORD {*password*}

The panel displays the PASSWORD prompt in a protected field. The *password* is a 26-character field where you enter your *password* of up to 8 characters. The input to this field is not displayed. The *password* field allows you to change your *password* by using the old-password/new-password/new-password format. The *password* parameter is required.

GROUP [*racfgroup*]

The panel displays the GROUP prompt in a protected field. The *racfgroup* is an 8-character field where you enter your RACF group identifier. The *racfgroup* parameter is optional.

SECLABEL [*label*]

The panel displays the SECLABEL prompt in a protected field. The *label* is an 8-character field where you enter your RACF security label identifier. The *label* parameter is optional.

Notes:

1. The syntax of the user id, password, group id, and security label is defined by RACF.
2. You can use the tab keys to tab from one input field to the next on the LOGON prompt.
3. The LOGON command for MCS, HMCS and SMCS consoles is supported for full capability display consoles only.
4. Changes made to a user's access authority to a logged-on console may not take effect until the user logs off and then back on again to the console.
5. If a TIMEOUT value is specified for the console, the system will automatically issue a LOGOFF command after the number of minutes specified by TIMEOUT has elapsed without any console input activity (pressing an attention-generating key, such as Enter, PA1, PA2, or a PFK).

MODE command

Use the MODE command to control the actions of recovery management when certain types of machine check interruptions occur. The actions you can control are:

- The recording/monitoring status for each type of machine check interruption controlled by the MODE command. For the procedure to print the logrec data set, see the *EREP User's Guide* and the *EREP Reference*
- The monitoring of hard machine checks, including machine checks that indicate timing facility damage
- The suppressing of system recovery or degradation machine-check interruptions

Table 34 summarizes the information that the MODE command provides.

Table 34. Summary of the MODE Command

Command:	Topic:
MODE AD MODE CC MODE CO MODE CS MODE IC MODE IV MODE PD MODE PS MODE PT MODE SC MODE SD MODE SL MODE SS MODE TC	"Controlling the recording of hard machine check interruptions" on page 529
MODE DG MODE SR	"Controlling the recording of system recovery and degradation machine check interruptions" on page 531
MODE STATUS	"Displaying recording and monitoring status" on page 532

Note: When PROCVIEW CORE is in effect, the MODE commands AD, CC, IV, PD, PS, PT, SD, SL, and TC operate with RECORD=ALL,CPU=ALL. When PROCVIEW core is in effect, these MODE commands can no longer specify a machine check threshold.

You can enter the MODE command any number of times for any processor. Issuing the MODE command for a particular type of machine check changes only the recording or monitoring mode for that type of machine check, and changes it only for the processor(s) specified (or for all processors if no particular processor is specified). To change the recording or monitoring mode for several types of machine checks, you must enter a series of MODE commands. Each such MODE command specifies one type of machine check and the desired recording or monitoring mode for that type of machine check. If you issue the MODE command more than once for the same type of machine check, the last command (most recent) supersedes the previous commands.

Syntax

The syntax for each variation of the MODE command is shown immediately preceding its respective parameter list.

MODE command

MODE

Table 35 shows the machine check interruption types you can specify and the parameters allowed for each type:

Table 35. *MODE* parameters allowed for machine check interruptions

Machine check interruption type	Command parameters				
	CPU	QUIET	RECORD	REPORT	INTERVAL
DG — degradation	Yes	Yes ¹	Yes ^{1,2}	Yes ²	n/a
SR — system recovery	Yes	Yes ¹	Yes ^{1,2}	Yes ²	n/a
PD — instruction processing damage	Yes	n/a	Yes ³	n/a	Yes ³
SD — system damage	Yes	n/a	Yes ³	n/a	Yes ³
IV — invalid PSW or registers	Yes	n/a	Yes ³	n/a	Yes ³
TC — TOD clock damage	Yes	n/a	Yes ³	n/a	Yes ³
PT — processor timer damage	Yes	n/a	Yes ³	n/a	Yes ³
CC — clock comparator damage	Yes	n/a	Yes ³	n/a	Yes ³
PS — primary synchronization damage	Yes	n/a	Yes ³	n/a	Yes ³
AD — ETR-attachment damage	Yes	n/a	Yes ³	n/a	Yes ³
SL — switch to local synchronization	Yes	n/a	Yes ³	n/a	Yes ³
SC — ETR synchronization check	Yes	n/a	Yes ³	n/a	Yes ³
SS — STP synchronization check	Yes	n/a	Yes ³	n/a	Yes ³
IC — STP island condition	Yes	n/a	Yes ³	n/a	Yes ³
CO — STP configuration change	Yes	n/a	Yes ³	n/a	Yes ³
CS — STP clock source error	Yes	n/a	Yes ³	n/a	Yes ³

Table footnotes:

1. QUIET and RECORD are mutually exclusive.
2. REPORT can only be used with RECORD=ALL.
3. RECORD=ALL and INTERVAL are mutually exclusive.

When you specify more than one option, you can enter the parameters in any order, but you must separate them with commas.

Controlling the recording of hard machine check interruptions

You can use the MODE command to control the recording or monitoring of hard machine-check interruptions.

```

MODE {PD}[, INTERVAL={nnnn}][, RECORD[={nnn}][, CPU={x }]]
      {SD}           {300}           |=ALL      {ALL}
      {IV}           |                =25
      {TC}           |                =16
      {PT}           |                =5
      {CC}           |                =10
      {PS}           |                =20
      {AD}
      {SL}           {SC}
      {SS}
      {IC}
      {CO}
      {CS}

```

The parameters are:

- PD** Instruction-processing damage machine checks are to be monitored in the specified mode.
- SD** System damage machine checks are to be monitored in the specified mode.
- IV** Machine checks indicating invalid PSW or registers are to be monitored in the specified mode.
- TC** Machine checks indicating TOD clock damage are to be monitored in the specified mode.
- PT** Machine checks indicating processor timer damage are to be monitored in the specified mode.
- CC** Machine checks indicating clock comparator damage are to be monitored in the specified mode.
- PS** Machine checks indicating primary clock synchronization are to be monitored in the specified mode.
- AD** Machine checks indicating ETR attachment are to be monitored in the specified mode.
- SL** Machine checks indicating switch to local synchronization are to be monitored in the specified mode.
- SC** Machine checks indicating ETR synchronization checks are to be monitored in the specified mode.
- SS** Machine checks indicating STP synchronization checks are to be monitored in the specified mode.

MODE command

- IC** Machine checks indicating STP island condition are to be monitored in the specified mode.
- CO** Machine checks indicating STP configuration change are to be monitored in the specified mode.
- CS** Machine checks indicating STP clock source error condition are to be monitored in the specified mode.

INTERVAL=nnnn

This parameter is used together with the **RECORD=nnn** parameter. It defines the number of seconds used in counting hard machine check interrupts. If the specified number of seconds elapses before the specified number of interrupts of the specified type occur on the specified processor, the count of that type of interrupt is set to zero, and the counting is started again from zero. If the specified number of hard machine check interrupts does occur in the specified interval, then the system either performs a timer-related recovery action or invokes alternate CPU recovery (ACR) to take the failing processor offline. If the **INTERVAL** parameter is omitted, then **INTERVAL=300** is assumed.

RECORD=nnn

After the specified number (1 to 999) of hard machine checks of the specified type occurs on the specified processor in the specified interval, the system either performs a timer-related recovery action or invokes alternate CPU recovery (ACR) to take the failing processor offline. All interruptions of that type occurring on that processor are recorded on the logrec data set until the specified number is reached. If no number is specified or if the **RECORD** parameter is omitted, the system uses the following default setting:

- **RECORD=16** for PD
- **RECORD=25** for SL
- **RECORD=20** for SC
- **RECORD=10** for SS, IC, CO, and CS
- **RECORD=5** for all others

RECORD=ALL

All specified hard machine-check interruptions of the specified type occurring on the specified processor are to be recorded on the logrec data set. The system will no longer monitor the frequency of hard machine-check interruptions of that type occurring on that processor.

CPU=x

The address (0, 1, 2, 3...) of the processor to be monitored in the specified mode. If the parameter is omitted, **ALL** is assumed.

CPU=ALL

All processors in the system are to be monitored in the specified mode.

Example 1:

Monitor instruction-processing-damage machine-check interruptions on processor 0. If seven of these interruptions occur in 600 seconds on processor 0, invoke ACR to take processor 0 offline.

```
mode pd,record=7,interval=600,cpu=0
```

Example 2:

Record on the logrec data set all machine-check interruptions indicating invalid PSW or registers, but do not monitor them for any processor in the system.

```
MODE IV,CPU=ALL,RECORD=ALL
```

Example 3:

Monitor the frequency of system damage machine-check interruptions on all processors, using the default values of five for the RECORD= parameter and 300 for the INTERVAL= parameter. After five system damage machine checks have occurred on a given processor within five minutes (300 seconds), invoke ACR to take that processor offline.

```
mode sd
```

Controlling the recording of system recovery and degradation machine check interruptions

You can use the MODE command to control the recording and reporting of system recovery and degradation machine check interruptions.

```
MODE {SR} [,QUIET ] [,CPU={x|ALL}]
      {DG} [,RECORD[=nnn ]
          | =ALL [,REPORT=nnn]
          | =50
          | =1
```

The parameters are:

SR System recovery machine checks are to be placed in the specified recording mode.

DG Degradation machine checks are to be placed in the specified recording mode.

QUIET

No machine check interruptions of the specified type (system recovery or degradation) are to occur or be recorded for the specified processor.

RECORD=nnn

After the specified number (1 to 999) of system recovery or degradation machine check interruptions occur on the specified processor, the system is to notify you and switch the recording mode to QUIET for that type of interruption on that processor. If you do not specify a number or omit the RECORD parameter, the system uses the following defaults:

- RECORD=1 for DG
- RECORD=50 for SR

RECORD=ALL

All system recovery or degradation machine check interruptions occurring on the specified processor are to be recorded on the logrec data set. The default number of interruptions is 1 for DG and 50 for SR unless you specify the REPORT parameter along with RECORD=ALL. You are notified each time the defined number of interruptions occur, (see the description of REPORT=nnn for more information) but the system does not switch to QUIET mode for that type of interruption.

REPORT=nnn

You are notified each time the specified number (1 to 999) of system recovery or degradation machine check interruptions occur on the specified processor. Use this parameter only with the RECORD=ALL parameter. If

MODE command

you omit the REPORT parameter, you will be notified each time the default number of interruptions occurs. The defaults are:

- REPORT=50 for SR
- REPORT=1 for DG

CPU=x

The address (0, 1, 2, 3,...) of the processor to be put in the specified mode. If the parameter is omitted, ALL is assumed.

CPU=ALL

All processors in the system are to be put in the specified mode.

Example 1:

Degradation machine check interruptions are to be counted on processor 0. If the default number (1) occurs, the system notifies you and switches the recording mode to QUIET for these interruptions. The other processor(s) in the system is not affected and no other types of machine check interruptions for processor 0 are affected.

```
MODE DG,CPU=0
```

Example 2:

Degradation machine checks are to be put in QUIET mode on processor 2.

```
MODE DG,QUIET,CPU=2
```

Displaying recording and monitoring status

You can use the following form of the MODE command to display the status of each type of machine check interruption.

```
MODE [STATUS]
```

STATUS

The event counters and recording/monitoring status associated with each type of machine check interruption are to be displayed for each processor. If the STATUS parameter is specified, it must be the only parameter specified.

MODIFY command

Use the MODIFY command to pass information to a job or started task.

Restriction: You can communicate with a currently running program only if it is designed to recognize input from the MODIFY command. If it is not, you will get an error message.

Notes to Programmers:

- For more information, see the topic on communicating with a program using EXTRACT and QEDIT in *z/OS MVS Programming: Authorized Assembler Services Guide*.
- For more information about the MODIFY ZFS command, see *z/OS Distributed File Service zFS Administration*.
- For more information about the MODIFY DFS command, see *z/OS Distributed File Service SMB Administration*.

- For more information about the MODIFY PFA command for Predictive Failure Analysis, see *z/OS V2R2 Problem Management*.

Summary of MODIFY

Table 36 shows examples of the tasks that the MODIFY command can perform. Use it to access the pages on which you can find details and examples of a particular task.

Table 36. Summary of the MODIFY command

Topic:	Command:
"MODIFY command" on page 532	F jobname.identifier,parameters
"Controlling the CIM server" on page 538	F jobname,APPL=CONFIG,property=
"Passing information to a z/OS UNIX System Services application" on page 538	F jobname.identifier,APPL=text
"Modifying TSO/VTAM time sharing" on page 539	F jobname.identifier,USERMAX=,USER=
"Communicating with System REXX" on page 540	F AXR,parameters
"Controlling z/OS UNIX System Services (z/OS UNIX)" on page 543	F BPXOINIT,parameters
"Communicating with the catalog address space" on page 549	F CATALOG,parameters
"Processing the common event adapter (CEA) parameters" on page 550	F CEA,CEA=
"Refreshing the common event adapter (CEA) component information" on page 550	F CEA,DIAG,COMPTABLE
"Managing common event adapter (CEA) REXX exec tracing" on page 551	F CEA,DIAG,REXXDEBUG=
"Displaying the common event adapter (CEA) environment" on page 552	F CEA,DISPLAY
"Disconnecting the common event adapter (CEA) from the IPCS sysplex dump directory data set" on page 554	F CEA,DROIPCS
"Adjusting the common event adapter (CEA) mode of operation" on page 554	F CEA,MODE=
"Communicating with the device manager address space" on page 555	F DEVMAN,parameters
"Changing the DLF processing mode" on page 559	F DLF,MODE=
"Changing the DLF parameters" on page 560	F DLF,NN=
"Displaying DLF status" on page 560	F DLF,STATUS
"Starting, configuring, and stopping hardware event data collection" on page 561	F hisproc,parameters
<i>IBM Health Checker for z/OS User's Guide.</i>	F hzsproc,parameters
"Building and replacing library lookaside directories" on page 573	F LLA,parameters
"Operating with the network file system server" on page 574	F MVS NFS

MODIFY command

Table 36. Summary of the MODIFY command (continued)

Topic:	Command:
"Managing the object access method (OAM)" on page 574	F OAM,parameters
"Recycling z/OS UNIX System Services (z/OS UNIX)" on page 575	F OMVS,parameters
"Dynamically activating maintenance for z/OS UNIX System Services (z/OS UNIX)" on page 576	F OMVS,parameters
"Stopping a physical file system (PFS) through a logical file system (LFS) interface" on page 577	F OMVS,STOPPFS=
"Passing a MODIFY command string to a physical file system (PFS) through a logical file system (LFS)" on page 577	F OMVS,PFS=
"Replacing the sysplex root file system in the shared file system configuration (z/OS UNIX)" on page 578	F OMVS,NEWROOT=
"Stopping a temporary file system (TFS)" on page 579	F TFS,parameters
"Changing the virtual lookaside facility (VLF) parameters" on page 579	F VLF,REPLACE,NN=
"Enabling and disabling the Application Response Measurement (ARM) services" on page 580	F WLM,AM=DISABLE ENABLE
"Starting, stopping and modifying options for the guest platform management provider" on page 581	F WLM,GPMP
"Changing workload manager resource states" on page 582	F WLM,RESOURCE
"Specifying data set selection criteria for an external writer" on page 583	F XWTR.identifier,devnum,parameters
"Causing an external writer to pause" on page 585	F XWTR.identifier,devnum,PAUSE

Using asterisks in MODIFY commands

Certain forms of the MODIFY command allow you to specify the following for a job or started task:

- An identifier
- An optional job name.

You can use the asterisk wildcard to direct the MODIFY command to more than one job or started task. The asterisk indicates that a MODIFY command applies to all jobs or started tasks that match a leading character string.

For example, when specifying an identifier without an optional job name, you can enter the following command to pass a two-digit value to all jobs with identifiers beginning with R1:

```
F R1*,00
```

You can also use the asterisk wildcard when you specify both a job name and identifier. For example you can enter the following command to pass a two-digit value to all jobs with names beginning with WX *and* identifiers beginning with R1:

```
F WX*.R1*,00
```

When you specify asterisks with device numbers, the system assumes that the device numbers are four digits long. For example, /13* would match on 1301, 1302, and so on, but would not match on 13C.

Remember the following rules when using asterisk notation:

- If you specify only the *identifier* parameter (without the *jobname* parameter), you cannot specify a stand-alone asterisk on the *identifier* parameter.
- If you specify both the *jobname* and *identifier* parameters, you cannot specify a stand-alone asterisk for *both* parameters.

For example, to pass a two-digit value to all jobs with names beginning with WX, you can specify a single asterisk on the *identifier* to indicate a *wildcard*:

```
F WX*.*,00
```

If you were to remove the WX characters from the command, it would not be valid. You cannot specify *.* without a leading character string on the *jobname* parameter, *identifier* parameter, or both.

The following figures illustrate how asterisk notation works in MODIFY commands. Table 37 shows examples of START commands that are used to start jobs. Columns three and four show the associated jobnames and identifiers.

Table 37. Examples of START commands to start jobs

Job number	START command	Jobname	Identifier
1	START YZ	YZ	YZ
2	START WX.YZ	WX	YZ
3	START WX.YZ1	WX	YZ1
4	START WX1.YZ1	WX1	YZ1
5	START WX, JOBNAME =WX1	WX1	WX1
6	START WX, JOBNAME =WX2	WX2	WX2
7	START WX, JOBNAME =YZ	YZ	YZ
8	START Q.YZ3	Q	YZ3
9	START WX.R1	WX	R1
10	START WX, JOBNAME =YZ4	YZ4	YZ4

Table 38 shows examples of MODIFY commands. The numbers in the second column indicate to which jobs in Table 37 each MODIFY command applies.

Table 38. Examples of MODIFY commands

MODIFY command	Affected jobs
F WX.YZ, <i>parameters</i>	2
F WX.YZ*, <i>parameters</i>	2, 3
F YZ*, <i>parameters</i>	1, 7

MODIFY command

Table 38. Examples of MODIFY commands (continued)

MODIFY command	Affected jobs
F WX*,parameters	5, 6
F YZ*,parameters	1, 2, 3, 4, 7, 8, 10
F WX*.YZ,parameters	2
F WX*.YZ*,parameters	2, 3, 4
F *.YZ*,parameters	1, 2, 3, 4, 7, 8, 10
F *.YZ,parameters	1, 2, 7
F WX*.*,parameters	2, 3, 4, 5, 6, 9
F WX.*,parameters	2, 3, 9

MODIFY command syntax

The syntax for each variation of the MODIFY command is shown immediately preceding its respective parameter list.

MODIFY or F

Syntax

MODIFY | F [jobname,]identifier,parameters

Parameters

The parameters for this command are:

jobname

The name of the batch job, started task, or APPC/MVS transaction program to be modified.

The job name for a given started task can be assigned based on a variety of inputs. These inputs are examined in the following order, so that if item #1 is not specified, item #2 is used. If neither #1 nor #2 is specified, then #3 is used, and so on.

1. The jobname specified in the JOBNAME= parameter of the START command
or
The specified on the START command.
2. The jobname specified on the JOB JCL statement within the member.
3. The device number specified on the START command, or the device number associated with the device type specified on the START command
or
The device number associated with the device type specified on the START command.
4. The device number associated with the IEFORDER DD statement within the member.
5. The member name.

You can use asterisk notation to specify more than one job or started task on the MODIFY command. See “Using asterisks in MODIFY commands” on page 534 for more information.

identifier

The identifier assigned to the job or started task. (See “Displaying started task status” on page 353 for information about determining the jobname and identifier of currently active started tasks.)

Use one of the following types of identifiers:

- The identifier that was specified on the START command.
- *//devnum*, the 3-digit or 4-digit hexadecimal device number specified when the START or MOUNT command was issued.

When you specify a device number that could be mistaken for the device name, precede the device number with a slash. The slash is optional with a 3-digit device number.

- *devicetype*, the type of device specified when the START or MOUNT command was issued.

If no identifier was specified, the identifier “STARTING” is temporarily assigned until the system can assign another according to the following order of precedence:

1. If an identifier was not specified on the START command, the identifier is the device type (for example, 3410) or device number (for example, X'0000') specified on the START or MOUNT command.
2. If an identifier, a device type, or a device number was not specified on the START or MOUNT command, the identifier is the device type specified on an IEFORDER DD statement (invoking a catalogued procedure) in the JCL.
3. If none of the these was specified, the identifier defaults to the job name.

You can use asterisk notation to specify more than one job or started task on the MODIFY command. See “Using asterisks in MODIFY commands” on page 534 for more information.

parameters

Program parameters passed to the started program.

Example 1:

If the program currently running in job TMASGX02 was set up by the programmer to accept 2-digit values from the operator, enter the following (where nn is an appropriate 2-digit value):

```
f tmasgx02,nn
```

Example 2:

If started tasks are running with the following jobnames and identifiers:

```
Jobname = ABC1, identifier = DEF1
Jobname = ABC2, identifier = DEF2
```

And both tasks accept the value “INPUT1” from the operator, enter:

```
f ABC*.DEF*,INPUT1
```

Both tasks receive the value INPUT1.

Passing information to a z/OS UNIX System Services application

```
F jobname.identifier,APPL=text
```

The parameters are:

jobname

The name of the job.

You can use asterisk notation to specify more than one job or started task on the MODIFY command. See “Using asterisks in MODIFY commands” on page 534 for more information.

identifier

The identifier used on the START command to identify the application.

If an identifier was not specified on the START command, the system automatically uses the job name as the identifier. (See “Displaying started task status” on page 353 for information about determining the job name and identifier of currently active started tasks.)

You can use asterisk notation to specify more than one job or started task on the MODIFY command. See “Using asterisks in MODIFY commands” on page 534 for more information.

APPL=text

Up to 110 characters. Quotation marks around the text are optional. If you do put the text in quotation marks, the quotation marks will be passed, with the text, back to the application.

Example:

To modify the jobname DATASRV, enter:

```
F DATASRV,APPL=threadlimit=5
```

Job names can be a maximum of eight characters. No spaces are allowed.

Controlling the CIM server

In addition to the cimconfig command-line utility, see *z/OS Common Information Model User's Guide*, starting with z/OS 1.10 the CIM server configuration can be changed from the z/OS system console using the MODIFY command. The general syntax for using the MODIFY command to pass information to a UNIX System Services Application is described in “Passing information to a z/OS UNIX System Services application.”

Following is the specific syntax for using the MODIFY command to pass configuration changes to the CIM server. Between the options, no spaces are allowed:

```
F jobname ,APPL=CONFIG,property=[value|'value'] [,PLANNED]
```

Basically the CIM server accepts the same options for the MODIFY command as for the cimconfig utility.

jobname

The name of the job that runs the CIM server. When the CIM server is run as a started task, this will usually be CFZCIM.

APPL=CONFIG

This is the indicator for the CIM server that a configuration change was requested through the z/OS system console.

property

The name of the configuration property to be changed. For a complete list of CIM server configuration properties see *z/OS Common Information Model User's Guide*. Typically, the only current configuration properties that you can change dynamically are the *shutdownTimeout* property and the logging and tracing properties. Permanent changes require a CIM server restart. They are indicated using the PLANNED keyword at the end of the MODIFY command string.

value

The new value for the configuration property to be changed. For values that contain a comma or for case sensitive property values such as path names the value needs to be enclosed in single quotes ('). To reset a property to its default value, omit the *value* parameter.

PLANNED

Indicates that the configuration change should be made permanently. This means that the change will only become effective after a CIM server restart, and that the change will also persist further restarts until it is changed again. If PLANNED was not specified at the end of the command, the changes will only stay in effect until the next restart of the CIM server.

Example:

F CFZCIM,APPL=CONFIG,traceComponents=xmlio

F CFZCIM,APPL=CONFIG,traceLevel=4

Turns on tracing of the CIM server's XML traffic.

F CFZCIM,APPL=CONFIG,enableRemotePrivilegedUserAccess=true,PLANNED

Permanently enables superusers (UID=0) to issue requests against the CIM server from a remote system.

Modifying TSO/VTAM time sharing

You can use the MODIFY command to control the number of users allowed to be logged on to TSO/VTAM and to terminate TSO user address spaces.

```
F [jobname,]identifier,{USERMAX=nnnn}
                        {USER={SIC } }
                        {      {FSTOP} }
```

The parameters are:

jobname

The name of the job. Many installations use TCAS as the name.

You can use asterisk notation to specify more than one job or started task on the MODIFY command. See "Using asterisks in MODIFY commands" on page 534 for more information.

MODIFY command

identifier

The identifier specified on the START command for TSO/VTAM time-sharing.

If an identifier was not specified on the START command, the system automatically assigns the job name as the identifier. (See “Displaying started task status” on page 353 for information about determining the jobname and identifier of currently active started tasks.)

You can use asterisk notation to specify more than one job or started task on the MODIFY command. See “Using asterisks in MODIFY commands” on page 534 for more information.

USERMAX=nnnnn

The maximum number (0 to 32,767) of users that can be logged on to TSO/VTAM time-sharing at one time. Note that specifying USERMAX=0 causes the terminal control address space (TCAS) to suppress all LOGONs.

USER=SIC

Causes the TCAS to cancel all TSO/VTAM terminal user address spaces normally. The terminal users receive any messages queued for them. The TCAS remains active.

USER=FSTOP

Forces the TCAS to cancel all TSO/VTAM terminal user address spaces immediately. The terminal users do not receive any messages queued for them. The TCAS remains active. Specify FSTOP only if a system problem causes SIC to be ineffective.

If you issue the MODIFY command with the USER=FSTOP parameter, the affected address space is deleted from the system and recovery is severely limited.

Communicating with System REXX

You can use the MODIFY AXR command to either obtain status about System REXX, initiate the execution of a REXX exec, cancel a REXX exec, or start and stop TSO Server address spaces.

You can also use the prefix defined in the CPF parameter of the AXR00 parmlib member to replace MODIFY(F) AXR. See the AXR00 information in *z/OS MVS Initialization and Tuning Reference* for more information.

```
F AXR, {SYSREXX|SR[_],} STATUS|ST[,DETAIL|D] [REXXLIB|R] }
F AXR, {SYSREXX|SR[_],} CANCEL,REQTOKEN=token}
F AXR, {SYSREXX|SR[_],} STARTTSO}
F AXR, {SYSREXX|SR[_],} STOPTS0}
F AXR, {rexexecname[,TIMEINT|T=seconds] [,OREQTOKEN|OREQ] [,TSO=[YES|NO]]
      {_'[']arg1 arg2 ..argn['] }
```

The parameters are:

SYSREXX | SR[_],

Indicates that the SYSREXX command is to be run. Either a blank or a comma is permitted between SYSREXX and the subsequent operand. For example, you can enter:

```
F AXR,SYSREXX STATUS
```

or
 F AXR,SYSREXX,STATUS

STATUS | ST

Specifies or indicates that general information about System REXX execs is to be returned to the invoker.

DETAIL | D

Indicates that detailed information about execs that are currently running in System REXX is to be returned to the invoker.

REXXLIB | R

Indicates that information about data sets in the REXXLIB concatenation is to be returned to the invoker. The information includes the following details:

- concatenation order number
- data set name
- volume serial of the data set

CANCEL

Indicates that a REXX request is to be canceled.

REQTOKEN=token

Indicates the 16-byte token that identifies the request to be canceled.

STARTTSO

Indicates that the effects of STOPTSO are to be reversed. The operator can determine the status of TSO=YES processing by issuing F AXR,SYSREXX STATUS.

STOPTSO

Indicates that all idle TSO Server address spaces will be terminated. Any TSO Server address spaces with ongoing work will complete, and then those address spaces will terminate. Any inbound AREXX TSO=YES request or request that has not started execution, when the STOPTSO request was issued, will be rejected with a return code of 0Cx and reason code of xxxx0C11x.

rexexecname

A 1-8 character name of a member of the System REXX library (SYS1.SAXREXEC) where the exec resides. The exec will be executed in a TSO=YES environment with CONSNAME=Name of Issuing Console. See *z/OS MVS Programming: Authorized Assembler Services Guide* for more information. The invoker should avoid flooding the console with messages because any SAY or TRACE output will be sent to the invoking console.

TIMEINT | T

This is an optional parameter that is used to specify a time limit for the exec. If TIMEINT=0 is specified, no time limit will be applied. The exec exceeds this threshold, it will be halted. A maximum of 21474536 seconds may be specified. The default is 30 seconds.

OREQTOKEN | OREQ

Indicates that a request token is to be returned. The request token is returned with message AXR0213I, and that token can subsequently be used to cancel the request.

TSO=[YES | NO]

Indicates if an exec will run in a TSO environment. When TSO=NO is specified, the exec is run in the AXR address space, which has the following characteristics:

```
F AXR,SYSREXX REXXLIB

AXR0202I SYSREXX REXXLIB DISPLAY
NUMBER  VOLUME      DATA SET
01      TST005      RONN.REXX
02      SBOX00      SYS1.SAXREXEC
```

Example 4:

To invoke a REXX exec from a console with part of its argument string kept as lower case and part converted to upper case by system command processing, enter the following command:

```
F AXR,TheExec 'here''s a lower case string' here''''s an uppercase string
```

Controlling z/OS UNIX System Services (z/OS UNIX)

If you are using zFS and need to determine the file system owner, see the *z/OS Distributed File Service zFS Administration*.

You can use the MODIFY command to control z/OS UNIX System Services and to terminate a z/OS UNIX process or thread. You can also use it to shut down z/OS UNIX initiators and to request a SYSMDUMP for a process.

```
F BPXOINIT,{APPL=appl_data}
      {DUMP=pid}
      {FILESYS={DISPLAY[, FILESYSTEM=filesystemname]}[, OVERRIDE]}
      |,ALL
      |,EXCEPTION
      |,GLOBAL
      {DUMP }
      {FIX }
      {REINIT }
      {RESYNC }
      {UNMOUNT, FILESYSTEM=filesystemname }
      {UNMOUNTALL }
      {FORCE=pid[.tid]}
      {RESTART=FORKS}
      {RECOVER=LATCHES}
      {SHUTDOWN={FILEOWNER | FILESYS | FORKINIT | FORKS}}
      {SUPERKILL=pid}
      {TERM=pid[.tid]}
```

The parameters are:

BPXOINIT

The name of the job.

APPL=*appl_data*

Allows information to pass straight through to the application. *appl_data* is a string that is passed back to the invoker in whatever format the application expects it.

Note: BPXOINIT does not accept any APPL= parm values. You will receive the error message BPXM029I APPL= KEYWORD WAS IGNORED BY BPXOINIT.

DUMP=*pid*

Requests a SYSMDUMP. A SIGDUMP signal is sent to the specified process. *pid* is the decimal form of the process id to be terminated.

MODIFY command

FILESYS=

Indicates that a file system diagnostic or recovery operation is to be performed.

This function is applicable only to a sysplex environment where shared file system has been enabled by specifying SYSPLEX(YES) in the BPXPRMxx parmlib member named during system initialization. The command is intended to help diagnose and correct certain shared file system problems or errors that impact one or more systems in a sysplex environment.

Use this command with caution with an exception of the DISPLAY option, and only under the direction of an IBM service representative.

To obtain the best results, issue this command at the system with the highest shared file system software service level. To determine which system is executing with the highest shared file system software service level, issue the command

```
F BPX0INIT,FILESYS=DISPLAY,GLOBAL
```

and select the system with the highest "LFS Version" value.

Specify one of the following functions:

DISPLAY or D

Display the type BPXMCDs couple data set information relating to the shared file system file system. **D** is an alias of **DISPLAY**.

Specify one of the following display options:

ALL

Displays all file systems in the shared file system hierarchy.

EXCEPTION

Displays all file systems that are in an exception state. A file system is in an exception state if one of the following criteria is met:

- State = Mount in progress
- State = Unmount in progress
- State = Quiesce in progress
- State = Quiesced
- State = Unowned
- State = In recovery
- State = Unusable
- The file system state in the couple data set representation is inconsistent with the local file system.

FILESYSTEM=*filesystemname*

Displays information for the specified file system.

GLOBAL

Displays the current sysplex state, consisting of the following items:

- The active systems in the sysplex (system name, logical file system (LFS) version, verification status, recommended recovery action).
- The type BPXMCDs couple data set version number.
- The minimum LFS version required to enter the BPXGRP sysplex group.
- The device number of the last mounted file system.
- The maximum and in-use mounts.
- The maximum and in-use AMTRULES.

- The active "serialization categories," which systems are associated with each category, and the time that each "serialization category" was first started. The following serialization categories are defined:
 - SYSTEMS PERFORMING INITIALIZATION
 - SYSTEMS PERFORMING MOVE
 - SYSTEMS PERFORMING QUIESCE
 - SYSTEMS PERFORMING UNMOUNT
 - SYSTEMS PERFORMING MOUNT RESYNC
 - SYSTEMS PERFORMING LOCAL FILE SYSTEM RECOVERY
 - SYSTEMS PERFORMING FILE SYSTEM TAKEOVER RECOVERY
 - SYSTEMS RECOVERING UNOWNED FILE SYSTEMS
 - SYSTEMS PERFORMING REPAIR UNMOUNT
 - The system settings for MAXUSERMOUNTSYS and MAXUSERMOUNTUSER
 - The highwater marks for MAXUSERMOUNTSYS and MAXUSERMOUNTUSER

GLOBAL is the default display option.

DUMP

Initiate an SVC dump to capture all of the file system sub-records in the active type BPXMCDS couple data set.

FIX

Perform automatic file system and couple data set diagnosis and repair. As a part of the file system analysis, the system performs an analysis of possible file system latch contention on each system in the sysplex. An operator message identifies any possible problems. The system also analyzes file system serialization data that is maintained in the couple data set, and corrects it if an error is detected. It reports the status of the analysis in an operator message.

Note that the system initiates a dump of critical file system resources as a part of the FIX function. The dump is captured prior to the diagnosis and repair. If, however, a dump was captured due to a FIX or DUMP function that was initiated within the previous 15 minutes, the dump is suppressed.

Perform FIX prior to the UNMOUNTALL and REINIT functions.

REINIT

Re-initialize the file system hierarchy on all systems in the Z/OS Unix sharing group based on the ROOT and MOUNT statements in the BPXPRMxx parmlib member used by each system during its initialization. (Any changes to the BPXPRMxx parmlib member that are made after the system's initialization are not included in the REINIT processing. The system uses a cached version of the file system parmlib statements that is maintained in kernel storage. It does not re-process the parmlib member.)

Note that the system where the MODIFY command is issued will become the z/OS Unix file system owner to those file systems common to all systems in the sysplex (such as the ROOT file system) unless the SYSNAME() parameter is specified on the parmlib MOUNT statement.

The intended use of this function is to re-initialize the file system hierarchy after an **UNMOUNTALL** has been performed. However, you can issue **REINIT** at any time; those file systems that are already mounted will not be affected when **REINIT** processes the cached parmlib mount statements.

MODIFY command

Note: If any unmount processing is occurring when the REINIT is issued, some file systems might not be mounted when REINIT completes; the REINIT command should be issued again.

REINIT is not applicable to MKDIR support in the BPXPRMxx parmlib member. The directory mountpoints are not available and thus cause successive mounts to fail.

Note: The REINIT is not applicable to the ALTROOT parmlib statement. To re-enable the ALTROOT, you must explicitly process the ALTROOT statement using the SETOMVS system command.

RESYNC

Perform a file system hierarchy check on all systems. If a system has not mounted a file system that is active in the shared file system hierarchy, it is mounted locally and thus made available to local applications.

UNMOUNT

Unmount the file system specified by the *filesystem=* parameter. The file system cannot have any active mount points for other file systems. You must unmount those file systems first.

UNMOUNTALL

Unmount all file systems in the sysplex file system hierarchy, including the root file system. When processing is complete, mount SYSROOT on all systems.

Always issue the FIX function before performing the UNMOUNTALL function.

OVERRIDE

Normally only one MODIFY command for a FILESYS= function can be active on each system. Additionally, only one instance of the MODIFY command *in the sysplex* can be active for the **FIX**, **UNMOUNT**, **UNMOUNTALL**, and **REINIT** functions. If you specify the **OVERRIDE** parameter, the system accepts multiple invocations of this command on each system for the **DISPLAY**, **DUMP**, and **RESYNC** functions. Note, however, that the second invocation may be delayed.

The primary intent of the **OVERRIDE** parameter is to allow issuance of the **DISPLAY** functions while there is still a **MODIFY** in progress and the **MODIFY** appears to be delayed.

FORCE=

Indicates that the signal interface routine cannot receive control before the thread is terminated.

pid.tid

pid is the decimal form of the process id to be terminated. *tid* is the hexadecimal form of the thread id to be terminated.

RESTART=FORKS

Enables the system to resume normal processing. Suspended dub requests are resumed.

RECOVER=LATCHES

This command ends user tasks that are holding latches for an excessive amount of time. You can enter this command manually or provide an automation script allowing the system to automatically respond to message BPXM056E to aid in resolution of excessive latch contention. The command is primarily intended as an aid in resolving latch hangs that are caused by user

task usage of z/OS UNIX System Services. The command can also be used to terminate a system task that holds latches, if the system task is not critical. However, it might not be able to resolve latch hangs caused by critical internal system tasks in the OMVS kernel address space, if the owning system task is in critical system code that cannot be interrupted.

Note:

1. Only use this command if message BPXM056E is outstanding. The command causes one of the following:
 - If the contention can be resolved, the system DOMs the BPXM056E message. After the contention is resolved, the system issues message BPXM067I to indicate that condition.
 - If the contention cannot be resolved, the system issues message BPXM057E to indicate that condition.

See the following examples for the message output under different conditions.
2. MVS isolates the abnormal termination to individual tasks, but this command can result in the termination of an entire process. It is important to note that the abnormal termination will be caused by a non-retryable 422-1A5 abend that will cause the generation of a system dump, because of the likelihood of an internal system problem. Additionally, if more than one latch is in contention, multiple tasks might be abended and result in requests for multiple dumps.

SHUTDOWN=FILEOWNER

Unmounts the z/OS UNIX System Services file systems. Also prevents the system from becoming a filesystem owner through a move or recovery operation until z/OS UNIX System Services is recycled.

SHUTDOWN=FILESYS

Unmounts the z/OS UNIX System Services file systems.

SHUTDOWN=FORKINIT

Shuts down the z/OS UNIX initiators. Normally, these initiators shut themselves down in 30 minutes. Attempts to purge JES2 (command= P JES2) cannot complete until z/OS UNIX initiators have shut down.

SHUTDOWN=FORKS

Requests a shutdown of the fork() service by preventing future forks and non-local spawns. The kernel cannot obtain additional WLM fork initiators for fork and spawn. It attempts to terminate all WLM fork initiator address spaces that are running processes created by fork or non-local spawn. All other services remain "up", but any new dub requests are suspended until the fork() service is restarted.

SUPERKILL=pid

Indicates that a terminating signal is sent to the target process.

Guideline: SUPERKILL=pid ends the entire process and any subprocesses within the address space. Because SUPERKILL=pid is a stronger form of the TERM= and FORCE= parameters, only use this command if you are not able to end the process using F BPXOINIT TERM= and FORCE= commands.

pid

pid is the decimal form of the process ID to be ended.

MODIFY command

TERM=

Indicates that the signal interface routine can receive control before the thread is terminated.

pid.tid

pid is the decimal form of the process id to be terminated. *tid* is the hexadecimal form of the thread id to be terminated.

Example 1:

To display process information for a process id of '117440514' enter:

```
DISPLAY OMVS,pid=117440514
BPX0070I 14.16.58 DISPLAY OMVS 177
OMVS 000E ACTIVE
USER JOBNAME ASID PID PPID STATE START CT_SECS
MEGA TC1 0021 117440514 117440515 HKI 14.16.14 .170
 LATCHWAITPID= 0 CMD=ACEECACH
THREAD_ID TCB@ PRI_JOB USERNAME ACC_TIME SC STATE
0496146000000000 009E0438 OMVS .050 PTJ KU
04961D0800000001 009D5E88 OMVS WELLIE1 .002 SLP JSN
049625B000000002 009D8798 OMVS WELLIE1 .003 SLP JSN
04962E5800000003 009D5090 OMVS WELLIE1 .012 SLP JSN
0496370000000004 009D5228 OMVS WELLIE1 .011 SLP JSN
04963FA800000005 009D5A88 OMVS WELLIE1 .010 SLP JSN
0496485000000006 009D8048 OMVS WELLIE1 .011 SLP JSN
049650F800000007 009D81E0 OMVS WELLIE1 .011 SLP JSN
049659A000000008 009D8378 OMVS WELLIE1 .011 SLP JSN
0496624800000009 009D8510 OMVS WELLIE1 .011 SLP JSN
04966AF00000000A 009D8930 OMVS WELLIE1 .030 SLP JSN
```

```
f bpxoinit,force=117440514.04962E5800000003
BPXM027I COMMAND ACCEPTED.
```

```
f bpxoinit,term=117440514.0496624800000009
BPXM027I COMMAND ACCEPTED.
```

Example 2:

To shut down the fork() service, enter:

```
F BPXOINIT,SHUTDOWN=FORKS
BPXIxxxE FORK SERVICE HAS BEEN SHUTDOWN SUCCESSFULLY. ISSUE F
BPXOINIT,RESTART=FORKS TO RESTART FORK SERVICE.
```

Example 3:

To restart the fork() service, enter:

```
F BPXOINIT,RESTART=FORKS
```

Example 4:

Sample outputs of the MODIFY BPXOINIT,FILESYS command:

```
• F BPXOINIT,FILESYS=DISPLAY,GLOBAL
BPXM027I COMMAND ACCEPTED.
BPXF040I MODIFY BPXOINIT,FILESYS PROCESSING IS COMPLETE.
BPXF242I 2006/10/05 13.30.41 MODIFY BPXOINIT,FILESYS=DISPLAY,GLOBAL
SYSTEM LFS VERSION ---STATUS----- RECOMMENDED ACTION
SY1 1. 9. 0 VERIFIED NONE
SY2 1. 9. 0 VERIFIED NONE
SY3 1. 9. 0 VERIFIED NONE
CDS VERSION= 2 MIN LFS VERSION= 1. 9. 0
DEVICE NUMBER OF LAST MOUNT= 10
```

```

MAXIMUM MOUNT ENTRIES=      500   MOUNT ENTRIES IN USE=      9
MAXIMUM AMTRULES=          50     AMTRULES IN USE=        0
MAXSYSTEM=                  8
SYSTEM PERFORMING ZFS RECYCLE
(Since 2006/10/05 13.30.36)
SY2
ACTIVE QUEUE
RECYCLING                    EXCLUSIVE

```

- F BPXOINIT,FILESYS=DISPLAY,FILESYSTEM=POSIX.SY4.HFS

```

BPXM027I COMMAND ACCEPTED.
BPXF035I 2000/05/12 11.55.34 MODIFY BPXOINIT,FILESYS=DISPLAY
-----NAME-----
POSIX.SY4.HFS                                23  RDWR
  PATH=/SY4
  PARM=SYNC(04)
  STATUS=ACTIVE                               LOCAL STATUS=ACTIVE
  OWNER=SY1      RECOVERY OWNER=SY1      AUTOMOVE=Y PFSMOVE=Y
  TYPENAME=HFS   MOUNTPPOINT DEVICE=     12
  MOUNTPPOINT FILESYSTEM=POSIX.SYSPLEX9.HFS1
  ENTRY FLAGS=90000000  FLAGS=40000000  LFSFLAGS=08000000
  LOCAL FLAGS=40000000  LOCAL LFSFLAGS=2A000000
SY1 BPXF040I MODIFY BPXOINIT,FILESYS PROCESSING IS COMPLETE.

```

- F BPXOINIT,FILESYS=DISPLAY,FILESYSTEM=POSIX.ZFS.ETC

```

BPXM027I COMMAND ACCEPTED.
BPXF035I 2000/05/12 11.55.34 MODIFY BPXOINIT,FILESYS=DISPLAY
-----NAME-----
POSIX.ZFS.ETC                                23  RDWR

  PATH=/SY1/etc
  PARM=SYNC(04)
  STATUS=ACTIVE                               LOCAL STATUS=ACTIVE
  OWNER=SY1      RECOVERY OWNER=SY1      AUTOMOVE=Y PFSMOVE=Y
  TYPENAME=ZFS   MOUNTPPOINT DEVICE=     12
  MOUNTPPOINT FILESYSTEM=POSIX.SYSPLEX9.ZFS1
  ENTRY FLAGS=90000000  FLAGS=40000000  LFSFLAGS=08000000
  LOCAL FLAGS=40000000  LOCAL LFSFLAGS=2A000000
SY1 BPXF040I MODIFY BPXOINIT,FILESYS PROCESSING IS COMPLETE.

```

Example 5:

In response to message BPXM056E z/OS UNIX SYSTEM SERVICES LATCH CONTENTION DETECTED, enter the MODIFY or F BPXOINIT,RECOVER=LATCHES command to resolve the contention. You will receive one of the followings in response to the command:

- f bpxoinit,recover=latches
BPXM067I UNIX SYSTEM SERVICES LATCH CONTENTION RESOLVED
- f bpxoinit,recover=latches
BPXM057E UNIX SYSTEM SERVICES LATCH CONTENTION NOT RESOLVING

Communicating with the catalog address space

Use the MODIFY CATALOG command to communicate with the catalog address space to display information or to request a specified service. **Use this command only at the direction of the system programmer.**

For complete descriptions, including under which circumstances to use and when not to use this command, see *z/OS DFSMS Managing Catalogs*.

MODIFY command

When an operator issues any MODIFY CATALOG command, messages return to that console exclusively with one exception: for a MODIFY CATALOG,RESTART command, messages return to the console issuing the command and any consoles receiving routing code 2.

Processing the common event adapter (CEA) parameters

Use the MODIFY CEA,CEA= command to redrive the CEAPRMxx parmlib member for various parameter changes and corrections without taking down CEA.

For more information on how to configure CEA see the *z/OS Planning for Installation*.

```
F CEA,CEA=(xx1,xx2,...xxN)
```

The parameters are:

xx Denotes the specific CEA parmlib member that is processed to change the policy for CEA. The xx suffix can be any two alphanumeric characters except "NO". More than one parmlib member can be specified. There are no defaults for this command. The xx must be supplied even if the default parmlib member CEAPRM00 is requested.

Note: The CEA parmlib members specified in the list will be applied cumulatively. That is, any parmlib member specified will be processed in adjunct with the ones that have already been processed. This may result in more than one parmlib member being presented on the F CEA,D,P output. To 'remove' a statement value, it will be necessary to re-issue that statement with the new value in a parmlib member on a subsequent MODIFY CEA,CEA=xx command. This MODIFY CEA command does not remove all the new parmlib members. Even after a parmlib member is deleted, its values will remain in effect until the value is specifically replaced by a new statement and the deleted parmlib member name will still appear in displays, such as F CEA,D,P. The MODIFY CEA,D,PARMS can be used to check what the current parameter values are for the settings of the CEA statements in use.

Example 1:

```
f cea,cea=00
```

```
CEA0502I   CEA PARMLIB PROCESSING COMPLETE.
```

Refreshing the common event adapter (CEA) component information

Use the MODIFY CEA,DIAG,COMPTABLE command when the IBM Support Center directs you to issue the command to refresh the CEA component table as part of correcting an internal problem.

For more information on how to configure CEA see Configure CEA to work with z/OS in the *z/OS Planning for Installation*.

```
F CEA,DIAG,COMPTABLE
```

The parameters are:

COMPTABLE

This parameter specifies that you want to refresh the component table information for CEA without restarting CEA.

Example 1:

```
f cea,diag,comptable
```

```
CEA0018I COMPONENT TABLE RELOAD SUCCESSFUL.
```

Displaying the common event adapter (CEA) component TSO/E address space information

Use the MODIFY CEA,DIAG,SESSTABLE command to display the data associated with the CEA TSO/E address spaces that CEA manages. This console command displays the same information that is available to the z/OS CEA TSO/E address space manager callable service query function CEATsoRequest.

For information about the CEA TSO/E address space manager, see *z/OS MVS Programming: Callable Services for High-Level Languages*.

```
F CEA,DIAG,SESSTABLE
```

The parameters are:

SESSTABLE

This parameter specifies that you want to display the TSO/E address space information for the CEA TSO/E address space manager callable service.

Example 1:

```
f cea,diag,sesstable
```

```
00- SY1 f cea,diag,sesstable
SY1 CEA0401I CEA SESSION TABLE DISPLAY 780 C
INDEX=0001 USERID=ZOSMFAD APPID=IZUIS ASID=0039 MSGQID=00000004
COUNT=0002 ASCBADDR=FC6E80 STOKEN=000000E400000001 STTIME=17:04:39.875
LRTIME=17:07:36.933 LOGONPROC=CEANN GROUP=ZOSMFGRP REGION=0
CODEPG=1047 CHARSET=697 ROWS=200 COLS=160 RECONN=N RCTIME=00:00:00.000
ACCT=123123
INDEX=0002 USERID=ZOSMFAD APPID=IZUIS ASID=003A MSGQID=00000005
COUNT=0000 ASCBADDR=FC6D00 STOKEN=000000E800000001 STTIME=17:10:00.651
LRTIME=17:10:00.651 LOGONPROC=CEANN GROUP=ZOSMFGRP REGION=0
CODEPG=1047 CHARSET=697 ROWS=200 COLS=160 RECONN=Y RCTIME=17:10:24.045
ACCT=123123
```

Managing common event adapter (CEA) REXX exec tracing

Use the MODIFY CEA,DIAG,REXXDEBUG= command to manage CEA REXX exec tracing. Use this command only when the IBM support center directs you to issue the command to debug a problem.

For information on how to configure CEA see *Configure CEA to work with z/OS in the z/OS Planning for Installation*.

```
F CEA,DIAG,REXXDEBUG={ON | OFF | nnnnnnn}
```

The parameters are:

MODIFY command

REXXDEBUG={ON | OFF | *nnnnnnnn*}

Specifies CEA REXX exec tracing:

ON Specifies that you want all CEA REXX execs to write trace entries to the debug file.

OFF

Specifies that all REXX exec tracing be turned off.

nnnnnnnn

Hex value supplied by the IBM Support Center that specifies which subset of CEA REXX execs should write trace entries to the debug file.

If you specify a zero here, no CEA REXX exec will write trace entries.

Example 1:

```
f cea,diag,rexdebug=00000001
```

```
CEA0016I CEA REXX DEBUG TRACE IS ON  
(DIAG="00000001")
```

Displaying the common event adapter (CEA) environment

Use the `MODIFY CEA,DISPLAY` command to display information about the Common Event Adapter (CEA) address space. The information displayed shows which activities are being monitored by CEA, and on behalf of which internal z/OS components and clients using the CEA application programming interface. For more information on how to configure CEA see *Configure CEA to work with z/OS* in the *z/OS Planning for Installation*.

```
F CEA,DISPLAY|D[,{SUMMARY|S} ]  
[,{PARMS|P} ]  
[,{CLIENT={*|name|'name'} } ]  
[,CLIENTSUMMARY]  
[,DIAG,EXIT={*|exitname} ]  
[,EVENT={*|eventname} ]
```

The parameters are:

SUMMARY or **S**

Provides summary information about client and event subscriptions.

PARMS or **P**

Displays the currently active settings in CEA from the contents of the `CEAPRMxx` members of `SYS1.PARMLIB`. This is a cumulative set of values that might have been derived from more than one `CEAPRMxx` member. The parmlib member handling is a little different for CEA. See "Processing the common event adapter (CEA) parameters" on page 550 for more information.

CLIENT={*|name|'name'}

Displays information about a named CEA client, including:

- The events that the client subscribes to
- The name of the exit routine, and so on

Specifying '*' indicates that information for all connected clients is to be displayed.

CLIENTSUMMARY

Displays information about CEA clients including the number of each type of event to which the client is subscribed.

DIAG,EXIT={*|exitname}

Displays information about a specific event exit routine. Specifying '*' indicates that information for all event exit routines is to be displayed.

EVENT={*|eventname}

Displays information about a specific event to which a CEA client is subscribed. Specifying '*' indicates that information for all events is to be displayed.

Example 1

f cea,d

```
CEA0004I COMMON EVENT ADAPTER      288
STATUS: ACTIVE-FULL      CLIENTS: 0  INTERNAL: 0
EVENTS BY TYPE: #WTO: 0  #ENF: 0  #PGM: 0
TSOASMGR: ALLOWED: 50  INUSE: 0  HIGHCNT: 5
```

Example 2

f cea,d,clientsummary

```
CEA0004I COMMON EVENT ADAPTER      385
STATUS: ACTIVE-FULL      CLIENTS: 1  INTERNAL: 0
EVENTS BY TYPE: #WTO: 0  #ENF: 0  #PGM: 1
CLIENT NAME          #WTO  #ENF  #PGM
CIM_Provider_1      0      0      1
```

Example 3

f cea,d,client='CIM_Provider_1'

```
CEA0004I COMMON EVENT ADAPTER      388
STATUS: ACTIVE-FULL      CLIENTS: 1  INTERNAL: 0
EVENTS BY TYPE: #WTO: 0  #ENF: 0  #PGM: 1
CLIENT: CIM_Provider_1 USERID: DAVIDZ
EVENT NAME          HANDLER
PGM_EVENT_0        CEASAPFN
```

Example 4

f cea,d,diag,exit=*

```
CSV460I 15.34.06          EXITINFO
EXIT          DEF EXIT          DEF EXIT          DEF
PGM_EVENT_0  E
```

Example 5

f cea,d,diag,exit=pgm_event_0

```
CSV464I 15.33.19          EXITINFO
EXIT PGM_EVENT_0
MODULE STATE EPADDR  LOADPT  LENGTH  JOBNAME
CEASAPFN  A  FF427500  7F427500  00000248  *
```

Example 6

f cea,d,parms

```
CEA0023I COMMON EVENT ADAPTER      427
STATUS: ACTIVE-FULL      CLIENTS: 0  INTERNAL: 0
CEA = (01)
SNAPSHOT          = Y
HLQLONG           =          HLQ           = CEA
BRANCH            = 901          COUNTRYCODE = 001
CAPTURE RANGE FOR SLIP DUMPS:
LOGREC            = 01:00:00  LOGRECSUMMARY = 04:00:00
```

MODIFY command

```
|          OPERLOG          = 00:30:00
|          CAPTURE RANGE FOR ABEND DUMPS:
|          LOGREC          = 01:00:00  LOGRECSUMMARY = 04:00:00
|          OPERLOG          = 00:30:00
|          CAPTURE RANGE FOR CONSOLE DUMPS:
|          LOGREC          = 01:00:00  LOGRECSUMMARY = 04:00:00
|          OPERLOG          = 00:30:00
|          VOLSER, 1-4     = AUXPK1
|          TSOASMGR:
|          RECONSESSIONS   = 0          RECONTIME     = 00:00:00
|          MAXSESSIONS     = TABLE DATA NOT AVAILABLE NOW.
```

Disconnecting the common event adapter (CEA) from the IPCS sysplex dump directory data set

Use the F CEA,DROPIPCS command to forcibly disconnect the CEA instrumentation from the IPCS sysplex dump directory data set. Use this command if you are locked out from performing the maintenance of the sysplex dump directory data set.

For more information on how to configure CEA see Configure CEA to work with z/OS in the *z/OS Planning for Installation*.

```
F CEA,DROPIPCS
```

The parameters are:

DROPIPCS

This parameter specifies that you want to forcibly disconnect the instrumentation from the IPCS sysplex dump directory data set.

Example 1:

```
CEA00020I      DROPIPCS REQUEST SUCCESSFUL.
```

Adjusting the common event adapter (CEA) mode of operation

Use the MODIFY CEA,MODE command to adjust the mode of operation for CEA. The CEA address space can be operated in MIN mode or FULL mode. MIN mode is in effect when the CEA is only providing indication support to internal z/OS components. When in FULL mode, CEA is providing indication support to both internal z/OS components and appropriate CIM clients.

Adjusting the CEA mode of operation might be necessary when transitioning to a new environment; for example, when permissions and security product setups need to be performed on behalf of the CEA address space.

z/OS UNIX System Services must be available for CEA to be transitioned into FULL mode.

```
F CEA,MODE=[MIN | FULL]
```

Example 1:

Setting CEA mode to MIN and CEA is already in MIN mode.

```
F CEA,MODE=MIN
```

```
CEA0015I      CEA ALREADY PROCESSING IN REQUESTED MODE.
```

Example 2:

CEA is already in MIN mode and transitioning to FULL mode.

```
F CEA,MODE=FULL
```

```
CEA0107I COMMON EVENT ADAPTER IS RUNNING IN FULL FUNCTION MODE.
CEA0013I MODE REQUEST SUCCESSFUL.
```

Example 3:

CEA is in MIN mode, trying to transition to FULL mode, and request fails due to some interaction with USS. Codes in the error message give specific details.

```
F CEA,MODE=FULL
```

```
CEA0106I COMMON EVENT ADAPTER IS RUNNING IN MINIMUM MODE. OMVS IS NOT ACTIVE.
CEA0014I MODE REQUEST FAILED. DIAG1=0000000C DIAG2=04010122
```

Communicating with the device manager address space

Use the MODIFY DEVMAN command to communicate with the device manager address space to display information or to request a specified service. **Use this command only at the direction of the system programmer.**

```
F DEVMAN, {DUMP}
           {REPORT}
           {RESTART}
           {END(taskid)}
           {ENABLE(feature) }
           {DISABLE(feature)}

           {?|HELP}
```

The following are brief descriptions of the parameters.

DUMP

Captures a diagnostic dump of the device manager address space, including the dataspace that contains device manager CTRACE records.

Note: The device manager CTRACE component name is SYSDMO. To connect the device manager to an output writer, use the command TRACE CT,ON,COMP=SYSDMO.

REPORT

Provides basic information about the current activity and module levels for the device manager address space.

Notes:

1. If Multiple Incremental FlashCopy is enabled by installing the PTF for the enablement APAR OA45412 followed by a system IPL, the output of the F DEVMAN,REPORT command displays the MULTIPLE INCREMENTAL FLASHCOPY: CHANGE RECORDING V2 status.

If Multiple Incremental FlashCopy is disabled by issuing the SET DEVSUP=xx command with MULTINCRFLC=NO in the DEVSUPxx member of PARMLIB, the MULTIPLE INCREMENTAL FLASHCOPY: CHANGE RECORDING V2 status will not appear in the output of the F DEVMAN,REPORT command.

For more information, see Example 4 under “Examples” on page 558.

MODIFY command

2. If Easy-Tier Copy Temperature function for software defined storage is enabled by setting EASYTIERHINTS=YES in the DEVSUP xx member of PARMLIB, the output of the F DEVMAN,REPORT command displays the EASY-TIER FOR SOFTWARE DEFINED STORAGE status.

If Easy-Tier Copy Temperature function for software defined storage is disabled by issuing the SET DEVSUP= xx command with EASYTIERHINTS=NO in the DEVSUP xx member of PARMLIB, the EASY-TIER FOR SOFTWARE DEFINED STORAGE status will not appear in the output of the F DEVMAN,REPORT command.

For an example of the output of the F DEVMAN,REPORT command, see Example 5 under “Examples” on page 558. For more information about the EASYTIERHINTS keyword, see *z/OS MVS Initialization and Tuning Reference*.

RESTART

Terminates the device manager address space and restarts the device manager in a new address space. The system allows any subtasks that are active in the device manager address space at the time of the restart to finish processing. The time allowed for subtask completion is determined by using the average time taken by previous subtasks. The system abnormally ends any subtasks that do not complete in time before it restarts the address space.

Notes:

1. Use RESTART to avoid IPL when you install software. You can install most device manager APARs by refreshing LLA (F LLA,REFRESH), and then restarting the device manager (F DEVMAN,RESTART).
2. You can end and not restart the device manager address space by using the CANCEL DEVMAN command. When you end the address space in this way, you must restart the device manager with the DEVMAN cataloged procedure.

END(*taskid*)

Terminates the subtask identified by *taskid*. The F DEVMAN,REPORT command displays the *taskid* for a subtask.

ENABLE(*feature*)

Enables an optional feature. The supported features are named as follows:

REFVTOC

Use ICKDSF to automatically REFORMAT/REFVTOC a volume when it expands.

DATRACE

Capture dynamic allocation diagnostic messages.

REFUCB

Enables the automatic REFUCB function of the Device Manager. When the REFUCB feature is enabled the system automatically updates the UCB when device support software detects that a DSS COPY or RESTORE or ICKDSF REFORMAT NEWVTOC operation has changed either the volser or the VTOC location. In the case of a volser or VTOC location change, the system invokes the DEVMAN REFUCB service on each system in the sysplex that has REFUCB enabled.

- If the device is ONLINE, REFUCB issues a VARY ONLINE,UNCONDITIONAL command, which updates both the volser and VTOC location in the UCB.
- If the device is OFFLINE, no action is taken.

PPRCSUM

Enables the PPRCSUM feature of the Device Manager, which means using message IEA075I instead of IEA494I to report devices that transition to PPRC suspended state. The PPRCSUM feature significantly reduces the volume of messages that are written to the console when devices in a PPRC relationship are suspended due to a PPRC freeze. If you enable PPRCSUM, the system will issue one or more IEA075I messages to summarize the PPRC state for all devices in the control unit.

Attention: If GDPS or other PPRC monitoring software is active, make sure that you have the appropriate version of this software before enabling PPRCSUM.

Note that if the PPRCSUM feature is enabled or disabled after IPL, one device in every control unit must be varied online to activate the feature.

QUERYFC:*num*

Enables Query FlashCopy Capability (QUERYFC) with the specified number *num* (1 - 9999) of requests. The *num* variable represents a UNIT of work for requests issued at any given time when an ADRDSSU COPY command is invoked. A conservative value for UNIT is 64, which is specified by the F DEVMAN,ENABLE(QUERYFC:64) command, indicating that 64 QUERYFC channel programs are issued in parallel. When the first 64 complete, another set of 64 QUERYFC channel programs are added, and the sequence repeats until all volumes in the Storage Group are queried.

When QUERYFC is enabled, the F DEVMAN,REPORT command verifies that the UNIT value is specified correctly via the *num* parameter. The command also reports the maximum number of observed QUERYFC requests. If many tasks are running in parallel, a large number of QUERYFC requests is typical.

DISABLE(*feature*)

Disables one of the following optional features:

- REFVTOC
- DATRACE
- REFUCB
- PPRCSUM

When PPRCSUM feature is disabled, the system issues a PPRC suspend notification message (IEA494I) for each individual device in the control unit.

Note that if the PPRCSUM feature is enabled or disabled after IPL, one device in every control unit must be varied online to activate the feature.

- QUERYFC

Disables QUERYFC, which allows all Query FlashCopy Capability (QUERYFC) requests to be issued simultaneously. This is the default, which does not limit users to a fixed number of requests. For example, the F DEVMAN,DISABLE(QUERYFC) command does not limit the number of QUERYFC requests, allowing all requests to go to the controller simultaneously.

HELP|?

Displays the DEVMAN MODIFY command syntax.

MODIFY command

Examples

Example 1:

The DEVMAN REPORT display has the following format:

```
FMID: HDZ1A10
APARS: NONE
OPTIONS: REFVTOC
SUBTASKS:
JOBNAME  STARTED  SERVICE  UNIT  STATUS          ID
-----
DEVMAN   15.42.32  REFVTOC  3700  SUBTASK RUNNING  0001
```

Where:

FMID Displays the FMID level of DEVMAN.

APARS

Displays any DEVMAN APARs that are installed (or the word NONE).

OPTIONS

Displays the currently enabled options (in the example, REFVTOC is enabled).

SUBTASKS

Lists the status of any subtasks that are currently executing.

Example 2:

The MODIFY DEVMAN,HELP command displays the DEVMAN MODIFY syntax, as follows:

```
?|HELP      - display devman modify command parameters
REPORT      - display devman options and subtasks
RESTART     - quiesce and restart devman in a new address space
DUMP        - obtain a dump of the devman address space
END(taskid) - terminate subtask identified by taskid
DSFTRACE((TP01))- define ICKDSF trace point(s) ((TP01)(TP02)(etc))
ENABLE(feature) - enable an optional feature
DISABLE(feature)- disable an optional feature
-----
Optional features:
REFVTOC     - automatic VTOC rebuild
REFUCB      - Allow UCB update after DSS volume restore
PPRCSUM     - DASD summary message support DATRACE
             - dynamic allocation diagnostic trace
QUERYFC:num - Enable QUERYFC with num(1-9999) requests
QUERYFC     - Disable QUERYFC to allow all QUERYFC requests
```

Example 3:

The F DEVMAN,ENABLE(QUERYFC:64) command displays the following example text:

```
DM00012I DEVICE MANAGER ENABLE QUERYFC(64)
f devman,report
**** DEVMAN ****
* FMID: HDZ1D10 *
* APARS: OA39569 UA63192 *
* OPTIONS: *
* QUERYFC : UNIT = 0064 TOTAL = 0000 *
* NO SUBTASKS ARE ACTIVE *
**** DEVMAN ****
```

Example 4:

When Multiple Incremental FlashCopy is enabled, the F DEVMAN,REPORT command displays the following example text:

```

**** DEVMAN *****
* FMID: HDZxxxx *
* APARS: AA46256 *
* OPTIONS: NONE *
* HPF FEATURES DISABLED: NONE *
* MULTIPLE INCREMENTAL FLASHCOPY: CHANGE RECORDING V2 *
* NO SUBTASKS ARE ACTIVE *
**** DEVMAN *****
    
```

Note that the **APARS** field displays only DEVMAN APARs or PTFs; it does not display APARs or PTFs that are not in the DEVMAN component.

Example 5:

When Easy-Tier Copy Temperature function for software defined storage is enabled, the F DEVMAN,REPORT command displays the following example text:

```

**** DEVMAN *****
* FMID: HDZxxxx *
* APARS: AA45241 *
* OPTIONS: NONE *
* HPF FEATURES DISABLED: NONE *
* EASY-TIER FOR SOFTWARE DEFINED STORAGE *
* NO SUBTASKS ARE ACTIVE *
**** DEVMAN *****
    
```

Changing the DLF processing mode

Use the MODIFY DLF,MODE command to change the processing mode for the data lookaside facility (DLF).

```

F DLF,MODE={DRAIN|D }
           {QUIESCE|Q}
           {NORMAL|N }
    
```

The parameters are:

DLF

The name of the job.

MODE

Changes the processing for DLF.

Note: This is the beginning of the shutdown process for DLF.

DRAIN or D

Sets drain mode. In drain mode, DLF connects the user to existing DLF objects or disconnects the user from DLF objects. No new DLF objects are created while in DRAIN mode.

Setting drain mode is part of the shutdown procedure for DLF. DLF will operate in normal mode until the STOP DLF command is issued.

QUIESCE or Q

Sets quiesce mode. In quiesce mode, DLF only disconnects the user

MODIFY command

from DLF objects. No new DLF objects are created while in QUIESCE mode. Specify QUIESCE only at the direction of the system programmer.

Setting quiesce mode is part of the shutdown procedure for DLF. DLF will operate in normal mode until the STOP DLF command is issued.

NORMAL or **N**

Sets normal mode. In normal mode DLF creates and connects the user to new DLF objects, connects the user to existing DLF objects, and disconnects the user from DLF objects.

Normal mode is in effect when DLF is active and not stopping. You need to specify MODE=NORMAL only when you have started to shutdown DLF but then decide to resume normal processing and cancel the shutdown.

Changing the DLF parameters

Use the MODIFY DLF,NN command to cause the data lookaside facility (DLF) to use the specified COFDLFxx member of the logical parmlib. The COFDLFxx parmlib member must contain a valid CLASS statement. The only values that change are limits on DLF use of storage through the keywords: MAXEXPB and PCTRETB. The new limit values affect only new connections; any existing connections or DLF objects that exceed the new limits are not affected. The CONEXIT parameter from the initial COFDLFxx member remains valid. See *z/OS MVS Initialization and Tuning Reference* for further information about the use of the COFDLFxx member.

```
F DLF,NN=xx
```

The parameters are:

DLF

The name of the job.

NN=xx

Causes DLF to use the COFDLFxx member of the logical parmlib where xx identifies the COFDLFxx member of the logical parmlib.

Displaying DLF status

Use the MODIFY DLF,STATUS command to display the limits from the COFDLFxx parmlib member currently in effect.

```
F DLF[, {STATUS|ST|S}]  
      |,SM  
      |,SB
```

The parameters are:

DLF

The name of the job.

STATUS or ST or S

Displays the DLF limits set in the COFDLFxx parmlib member that is currently in effect.

SM The status is displayed in megabytes.

SB The status is displayed in 4K blocks.

Note: When STATUS is specified the display is in the most recently requested unit, 4K blocks or megabytes. The default is megabytes.

Starting, configuring, and stopping hardware event data collection

Use the MODIFY *hisproc* command to manage collection of hardware event data for System z10 or later machines. Use F *hisproc*,BEGIN to configure and start a run of data collection, and F *hisproc*,END to stop the run. You must explicitly start each run of hardware data collection. You cannot set up data collection to run automatically.

During a run of hardware data collection, the system writes the data to z/OS UNIX System Services output files and to SMF record type 113. The system writes the raw data to SMF record type 113 at the start, the end, and defined intervals during the data collection run, and writes different types of data to the z/OS UNIX System Services output files at the end of the run. For more information about the different z/OS UNIX System Services output files, see “Accessing the output from a hardware event data collection run” on page 43.

If there is a significant state change within the system, such as a CPU capability change during a collection run, the STATECHANGE parameter from the MODIFY *hisproc* command will determine the appropriate action. When the action is SAVE (the default), there will be two SMF 113 records at every state change, one for the end of the previous state and one for the start of the new state. There will also be an additional set of z/OS UNIX output files for each detected state change. Each z/OS UNIX output file only represents an interval of time between the start and the end of the same system state. Each interval of a collection run has a unique set of z/OS UNIX output files, determined by the sequence number as part of the filename (the *xxx* section of the filename). If a .MAP file is to be generated for the collection run, one is not generated at a every state change. A .MAP file is only generated at the end of a collection run with a sequence number representing the last collection run interval. The group of files relating to the same run can be identified through the file prefix (SYSHISyyyymmdd.hhmmss).

Before you issue the F *hisproc*,BEGIN command to configure and start hardware event gathering on a system, you must do some set up steps. See “Setting up hardware event data collection” on page 40.

Note:

1. It is important to assign a sufficiently high dispatch priority to the instrumentation started task *hisproc*, so that the task can write the sampling data to the .SMP output files in a timely manner.
2. The sampling frequency is the number of samples per second regardless of processor model. The relative impact of sampling at the default rate is greater for slower processors. For slower sub-capacity models, a lower sampling frequency might be appropriate. For more information, see the SAMPFREQ parameter description.

MODIFY command

See “Accessing the output from a hardware event data collection run” on page 43 for information on the different files the HIS Profiler generates, depending on the F *hisproc*,BEGIN parameters you specify.

If you configure a new processor online in a system **after** you've already issued the F *hisproc*,BEGIN command to start a data collection run for that system, HIS might not collect data for that processor. To ensure that data is collected for all the processors on a system, bring the processors online before beginning a hardware data event collection run. The system does not collect data on a processor that is configured offline.

Note that z/OS IRD processor management can configure processors offline or online automatically. A processor is online at the start of the instrumentation run, but it might be configured offline (and sometimes online again) during the run. The system does not collect data on the offline processor.

```
F hisproc,{BEGIN|B}
    [, {TITLE|TT}='textdata']
    [, PATH='pathname']
    [, {DDNAME|DD}=ddname]
    [, {DURATION|DUR}=duration_value]
    [, {STATECHANGE|SC}={SAVE|STOP|IGNORE}]
    [, {DATALOSS|DL}={IGNORE|STOP}]

    [, SMP={YES|NO}]
        [, {SAMPTYPE|ST}=samptype|PERSIST|NONE]
        [, {BUFCNT|BUF}={bufcnt|PERSIST}]
        [, {SAMPFREQ|SF}=freq|PERSIST]

    [, CNT={YES|NO}]
        [, {CNTSET|CTRSET|CTR}={COMPLETE
            SOFTWARE
            HARDWARE
            (ctr1,ctr2,...ctrn)}]
        [, {CNTINTVAL|CI|SMFINTVAL|SI}={SYNC|intv}]
        [, CNTFILE={YES|NO}]

    [, MAP={YES|NO}]
        [, {MAPASID|MAS}={ALL|(asid1,asid2,...asidn)}]
        [, {MAPJOB|MJOB}={job1,job2,...jobn}]
        [, {MAPVERBOSE|MAPV}]

    [, {CNTONLY|CTRONLY|MAPONLY}]

    {END|E}

    {SERVICE|S}
        [, {DDNAME|DD}=ddname]
        [, {BUFCNT|BUF}={bufcnt|PERSIST}]
        [, {SAMPFREQ|SF}=freq|PERSIST]
        [, {SAMPTYPE|ST}=samptype|PERSIST|NONE]
        [, {REFRESH|REFR}]
```

The parameters are:

hisproc

The name of the hardware instrumentation services (HIS) catalogued startup procedure.

{BEGIN|B} or {END|E} or {SERVICE|S}

You must specify either BEGIN or END or SERVICE on the *F hisproc* command to begin or end a run of hardware event data collection, or update the service parameters, for a system:

BEGIN|B

Specifies that the system begin a HIS Profiler collection run. Note that you must first start the HIS address space with the *START hisproc* command before you can start the HIS Profiler. Note that any service parameters specified will be accepted and will be used as the new service parameter values.

END|E

Specifies that the system end a HIS Profiler collection run. As part of the end processing, the system writes the hardware data to your z/OS UNIX System Services output files and writes the last SMF record type 113 to the SMF data set.

Note that while both *F hisproc,END* and *STOP hisproc* end the data collection run, the two commands are different:

- Using *F hisproc,END* ends the HIS Profiler collection. You must issue *F hisproc,BEGIN* command to restart a HIS Profiler collection.
- Using *STOP hisproc* both ends the HIS Profiler collection and stops the HIS address space, which also disables the HISSERV service. You must reissue the *START hisproc* command before starting the HIS Profiler with the *F hisproc,BEGIN* command, as well as any HISSERV exploiter.

SERVICE|S

Specifies that the system should update the service parameters for all exploiters of the HISSERV service. If the HIS Profiler run is currently collecting instrumentation data, it will be notified of the change and a state change event will occur.

TITLE|TT='textdata'

Optional parameter specifying up to 32 characters of text data meaningful to the user. This data will be displayed in the z/OS UNIX System Services .CNT output file. For example, you might use this field to create an eye catcher to identify the reason for a hardware data collection run. The text data must be enclosed in single quotation marks.

PATH='pathname'

Specifies the z/OS UNIX System Services path (in a local file system) where you want the system to write the collected hardware event data for one run. The system creates all the output files (the .MAP, .CNT and .SMP files) and writes the collected data to the output files at the end of a run. This parameter is required, unless you have already set up the file path using the HOME keyword in the OMVS segment of an *ADDUSER hisproc* or *ALTUSER hisproc* command. See “Setting up hardware event data collection” on page 40 for more information.

The *pathname* must be enclosed in single quotation marks and can be up to 64 characters. For example, you could specify the following for *pathname*:

- *PATH='.'*, which means to use the current working directory.
- *PATH='/u/john'*, which means to use the absolute directory */u/john*.
- *PATH='user/mary'*, which means to use the relative directory *user/mary*, which is relative to the current working directory.

MODIFY command

If instrumentation is to be run concurrently on multiple LPARs with a shared file system, a unique path that is specified by the PATH parameter must be created for each LPAR sharing the file system.

See “Accessing the output from a hardware event data collection run” on page 43 for information on the files the HIS Profiler generates at the z/OS UNIX System Services path.

{DDNAME|DD}=ddname

Optional parameter specifying the 1- to 8-character name identifying the job control language (JCL) data definition (DD) statement that defines a command file for HIS MODIFY *hisproc* parameters. The command file referenced contains parameters for HIS Profiler collection runs or for a service update (depending on whether it is a BEGIN or SERVICE request) which are set up the same way they would appear in the MODIFY command - the same rules and formatting apply to the command file that you would use in the console command. The command file gives you an alternative to specifying data collection options in a MODIFY *hisproc* command, which can be useful if you have difficulty fitting all the desired parameters on the command.

Note that duplicate parameters on the MODIFY *hisproc* command and in the command file are not allowed and will be flagged as errors.

When the system processes the DDNAME parameter, the system takes the character string on each line and concatenates them into one command string for parsing. It then merges the command file contents with the parameters specified on the MODIFY *hisproc* command used to process the command. Thus, you can specify some of your data collection options in the command file, and some in the MODIFY *hisproc* command. For example, you can put all the constant parameters in the command file and dynamic parameters on the command line. For example, TITLE can be used to document the reason for the run on the command line.

The statements in the command file are normal MODIFY *hisproc* parameters, without the MODIFY *hisproc*, BEGIN or MODIFY *hisproc*, SERVICE heading.

The following shows an example of valid command file contents assuming a MODIFY *hisproc*, BEGIN, DDNAME=*ddname1* heading:

```
PATH='/user/john',CTRSET=(BASIC,PROB),
BUFCNT=PERSIST,  SAMPTYPE=BASIC,
SAMPFREQ=850000,DATALOSS=IGNORE,
MAPASID=(7,0E,E1D),
MAPJOB=(PROG*,DB*,GRS,JE??)
```

These commands would be valid in a command file for a MODIFY *hisproc*, SERVICE, DDNAME=*ddname2* heading :

```
SAMPTYPE=BASIC,
SAMPFREQ=130000
```

Use the following syntax rules for the command file:

- The parameters specified can reside on multiple lines of the command file.
- You must separate keywords with commas.
- The system treats a blank character between any two non-blank characters on the same line (unless the blank is quoted within quotation marks) as the end of the command.
- You can use columns 1-72 of each line.

- A quoted string (a title or path name, for example) can not span more than one line.
- Parameters and values in the command file must be in UPPER case, unless the parameter value is a quoted string.

In order to use a command file for MODIFY *hisproc*, you must specify the *ddname* in the HIS started catalogued start up procedure *hisproc*. The following example shows how to use a command file named CMDFILE for the MODIFY *hisproc* command. In the example, DDNAME1 specifies a command file CMDFILE, which is a member of SAMPLING.PROCLIB and contains some or all of the parameters for the MODIFY *hisproc* command. Likewise, DDNAME2 specifies command file CMDFILE2 which would contain a different set of parameters.

```
//HISPROC PROC
//HISPROC EXEC PGM=HISINIT,REGION=0K,TIME=NOLIMIT
//DDNAME1 DD DSN=SAMPLING.PROCLIB(CMDFILE),DISP=SHR
//DDNAME2 DD DSN=SAMPLING.PROCLIB(CMDFILE2),DISP=SHR
//SYSPRINT DD SYSOUT=*
```

The command file must have a RECFM format of LRECL=80 fixed length record.

Note that the same syntax rules apply to the parameters in the command file as to a MODIFY *hisproc* command. The system flags duplicate parameters or mutually exclusive parameters entered in the MODIFY *hisproc* command and the command file as errors and you will receive an error message.

There is no default for the DDNAME.

{DURATION|DUR}=duration_value

Optional parameter specifying the duration, in minutes, that you want the hardware event data collection run to last. At the end of this period, data collection stops automatically.

The default DURATION for instruction address sampling is 10 minutes. If request is for event counters only (CTRONLY), the default DURATION is unlimited. To stop an unlimited data collection run, you must explicitly specify one of the following commands:

- F *hisproc*,END
- STOP *hisproc*

Value range: 1–1440 (minutes)

{STATECHANGE|SC}={SAVE|STOP|IGNORE}

Optional parameter specifying the action you want the system to take when a significant change to the system is detected. An example of a significant state change would be if the capability of a CPU has changed. You can specify the following for STATECHANGE:

- **SAVE**, the current run of hardware event data collection will save all data collected as if the duration of the run has expired. It will then resume collecting hardware event data in the new state for the remaining duration of the current collection run.
- **STOP**, the current run of hardware event data collection for a system is ended as if the duration of the run has expired.
- **IGNORE**, the current run of hardware event data collection continues as if no state change had been detected.

Default: SAVE

MODIFY command

{**DATALOSS**|**DL**}={**IGNORE**|**STOP**}

Optional keyword specifying the action you want the system to take if data loss occurs during the instrumentation run. Data loss can occur from any of the following events:

- Sampling buffer overflow condition
- Loss of Sample Data Measurement Alert (raised by hardware)
- Loss of Counter Data Measurement Alert (raised by hardware)

You can specify the following values for the **DATALOSS** parameter:

IGNORE | **I**

The system continues with the instrumentation run if data loss occurs.

STOP | **S**

The system stops the instrumentation run if data loss occurs.

You can reduce the chances of losing data in the event of a buffer overflow by either allocating more buffers for data collection or increasing the priority of the HIS started task.

A Loss of Sample Data Measurement Alert and a Loss of Counter Data Measurement Alert are determined by the hardware and cannot be predicted nor prevented.

Default: IGNORE

SMP={**YES**|**NO**}

Specifies that you want to collect sample data. The default is YES.

{**SAMPTYPE**|**ST**}={*samptype*|**PERSIST**|**NONE**}

Optional parameter that specifies the sampling functions to be performed. This parameter is only valid when SMP=YES is in effect.

Whether this option is specified or omitted under the MODIFY *hisproc*, BEGIN or the MODIFY *hisproc*, SERVICE heading, the change is global to all HISSERV exploiters.

samptype

The sampling functions (*samptype*) supported include:

- **BASIC** or **B**: for basic sampling functions.
- **DIAG** or **D**: for basic and diagnostic sampling. Diagnostic sampling provides additional information over what is available in basic sampling. When diagnostic sampling is requested, basic sampling is also automatically selected. To use the diagnostic sampling function, you must first authorize to the diagnostic sampling facilities on the SE console. Unless instructed by IBM, use ST=Basic.

For information about how to set up the authorization of the sampling facilities through the support element (SE) console, see *Support Element Operations Guide* for System z10 machine on the Resource Link home page (<http://www.ibm.com/servers/resourceLink>).

PERSIST

The sampling functions to be performed are not changed from its prior value.

NONE

No sampling functions will be performed, and no HISSERV exploiters will be authorized to collect sampling data.

Example: SAMPTYPE=DIAG

Default: Basic. If you do not specify SAMPTYPE, the default is used.

{BUFCNT|BUF}={*bufcnt*|PERSIST}

Optional parameter that specifies the number of sampling buffers. This parameter is only valid when SMP=YES is in effect.

Whether this option is specified or omitted under the MODIFY *hisproc*, BEGIN or the MODIFY *hisproc*, SERVICE heading, the change is global to all HISSERV exploiters.

bufcnt

The number of sampling buffers (in 4K pages) per processor for the system. A range of values between 4 - 1024 (pages) is supported.

The total number of sampling buffers the system uses is calculated from the BUFCNT specified, as follows:

(BUFCNT * Number of active processors in the configuration)

If you specify too small a value for BUFCNT and the system runs out of buffer space, you might lose some sample data. If you specify a high sampling frequency on the SAMPFREQ parameter, HIS will consume more sampling buffer space and you might need a higher value for BUFCNT to prevent loss of samples.

PERSIST

The number of sampling buffers is not changed from its prior value.

Default: If you do not specify BUFCNT, the system calculates the number of buffers needed using the number of processors in the configuration and the sampling frequency in effect (SAMPFREQ).

{SAMPFREQ|SF}=*freq*|PERSIST}

Optional parameter that specifies the frequency for the sampling functions. This parameter is only valid when SMP=YES is in effect.

Whether this option is specified or omitted under the MODIFY *hisproc*, BEGIN or the MODIFY *hisproc*, SERVICE heading, the change is global to all HISSERV exploiters.

freq

is the total number of samples to be taken in a minute on all active processors in the configuration. For example, a *freq* value of 500000 specifies a sampling frequency of 500,000 samples per minute.

Note that the effective sampling rate is usually smaller than the specified SAMPFREQ for LPARs that share the processors. Samples are captured only on logical processors that are actively in use. (A waiting shared logical processor does not produce samples.)

PERSIST

The sampling frequency is not changed from its prior value.

Default: 800000, which is equivalent to 8 million samples in 10 minutes. This default may be aggressive for slower sub-capacity models. A less aggressive value of 130 000 should be used if there is an unacceptable performance degradation when the default value is used. The DURATION can be extended as needed if more samples are required. For example, to achieve 8 million samples with a sample frequency of 130 000, the duration of the sampling run would be 60 minutes.

MODIFY command

If you do not specify SAMPFREQ, the default is used.

CNT={YES|NO}

Specifies that you want to collect event counter set data. The default is YES.

{CNTSET|CTRSET|CTR}={COMPLETE|SOFTWARE|HARDWARE|(ctr1,ctr2,...ctrn)}

Optional parameter specifying the set of counters you want to collect. **CTRSET** and **CTR** are aliases of **CNTSET**. This parameter is only valid when CNT=YES is in effect.

COMPLETE

When you specify COMPLETE the system collects event counters for all available counter sets. For example, if you have installed and authorized only the basic and problem-state counter sets on your system, a specification of CNTSET=COMPLETE, results in basic and problem-state counter set events being collected. Be aware that specifying CNTSET=COMPLETE also means collecting event counters that are not currently defined, but may be defined in the future. It is possible that event counter sets in the future may have unforeseen performance impacts on the system. Note that COMPLETE, is not enclosed in parentheses.

SOFTWARE

When you specify SOFTWARE, the system collects all software related event counter sets. Any future counter set defined as a software counter set may have unforeseen performance impact on the system. Note that SOFTWARE is not enclosed in parentheses. CNTSET=SOFTWARE is currently equivalent to CNTSET=(Z).

HARDWARE

When you specify HARDWARE, the system collects all hardware related event counter sets. Any future counter set defined as a hardware counter set will have little unforeseen performance impact on the system. Note that HARDWARE is not enclosed in parentheses. CNTSET=ALL is an alias to CNTSET=HARDWARE. CNTSET=HARDWARE is currently equivalent to CNTSET=(B,P,C,E).

(ctr1,ctr2,...ctrn)

You can also specify a list of counter sets to collect. This comma separated list can be one or more of the following counter sets:

- **B or BASIC for basic:** This is a hardware CPUcounter set and includes architected system activities, such as cycle count, instruction count, level 1 cache misses, for example, for a CPU in either the problem or supervisor state.
- **P or PROB for problem state:** This is a CPU hardware counter set and includes the architected system activities only when the CPU is in the problem state.
- **C or Crypto for crypto:** This is a hardware CPU counter set and includes the architected crypto activities, such as function count, cycle count, blocked function count, and blocked cycle count for each of the PRNG, SHA, DEA, and AES functions.
- **E or EXT for extended:** This is a hardware CPUcounter set and includes model dependent counters described in model dependent system library publications. For more information about the extended counters for the supported counter version number for each model, see the extended counter definition in "The

CPU-Measurement Facility” available on the Resource Link home page (<http://www.ibm.com/servers/resourcelink>).

- **Z or ZOS for z/OS:** This is a software CPUcounter set and includes counters for z/OS related activities. Enabling the z/OS counter set incurs a slightly higher performance overhead than the hardware counter sets. The z/OS counter set uses the Enhanced Monitor Facility. Note the z/OS counters are not defined and are primarily used for IBM diagnostic purposes.
- **MTD or MTDIAG for MT-diagnostic:** This is a hardware core counter set and includes model dependent counters described in model dependent system library publications. For more information about the MT-diagnostic counters for the supported counter version number for each model, see the MT-diagnostic counter definition in “The CPU-Measurement Facility” available on the Resource Link home page (<http://www.ibm.com/servers/resourcelink>).

Default: If you do not specify **CNTSET**, HIS uses the B (basic) and P (problem state) counter sets. For example, use **CNTSET=(B,P,E)** to specify three counter sets (Basic, Problem state, and extended), and use **CNTSET=(BASIC,E)** to specify two counter sets (BASIC and extended).

{CNTINTVAL|CI|SMFINTVAL|SI}={SYNC|intv}

Optional parameter that specifies the interval at which SMF record type 113 records are recorded. **CI**, **SMFINTVAL**, and **SI** are aliases of **CNTINTVAL**. This parameter is only valid when **CNT=YES** is in effect. The following values are accepted:

SYNC

Specifies that the SMF record type 113 should be recorded in sync with the SMF global recording interval. The global recording interval is set by parameters **INTVAL** and **SYNCCVAL** in parmlib member **SMFPRMxx**. Note that if SMF is not active, global recording interval processing is disabled or there is some other error that prevents HIS to sync with the SMF global recording interval, no interval SMF record type 113 will be recorded. Receiving messages IEE500I or IEE068A is an example of when no SMF record type 113 will be recorded. For more information on the SMF global recording interval, see **INTVAL** and **SYNCCVAL** - Performing interval accounting in *z/OS MVS System Management Facilities (SMF)*.

intv

An interval, in minutes, that you want to record interval SMF record type 113 records. The acceptable value range is 1 - 60.

If **CNTINTVAL** is not specified, the default is 15.

CNTFILE={YES|NO}

Optional parameter that specifies whether event counter set data is to be written to z/OS UNIX System Services .CNT output files. This parameter is only valid when **CNT=YES** is in effect.

Default: YES

MAP={YES|NO}

Specifies that you want to collect load module mapping information. The default value is NO.

MODIFY command

{MAPASID|MAS}={ALL|(asid1,asid2,...asidn)}

Optional parameter that specifies a list of address space IDs (ASIDs), in hexadecimal, to identify the address spaces for which you want to collect private load module map data. HIS will collect the virtual storage addresses of modules loaded into private virtual storage for the specified ASIDs that are not terminating, swapping, swapped, or inactive. This parameter is only valid when you specify MAP=YES.

Acceptable hexadecimal values are between X'1' and X'7FFF'.

You can specify up to 32 ASIDs on the **MAPASID** parameter.

- If you need to collect data from more than 32 address spaces, you can use the **MAPJOB** parameter in place of or in addition to the **MAPASID** parameter.
- The system supports a total of up to 128 address spaces, including those specified in both the **MAPASID** and **MAPJOB** parameters. If you need load module map data for more than 128 address spaces, specify **MAPASID=ALL**. When you specify **MAPASID=ALL**, the load module map data for all active ASIDs can be returned. When collecting data for IBM, specify **MAPASID=ALL**, unless directed otherwise.
- If you specify **MAPASID** with any value, you will always map the nucleus and LPA areas as well.
- You may want to enable tracking of directed load modules with the **SETPROG TRACKDIRLOAD** command so that your results are complete. See "Tracking directed load modules" on page 736

Examples:

- **MAPASID=(7,8,32)**
- **MAPASID=ALL**

Default: None.

{MAPJOB|MJOB}=(job1,job2,...jobn)

Optional parameter specifying a list of job names for which HIS will collect the virtual storage addresses of modules loaded into private virtual storage. HIS collects the virtual storage addresses for jobs that are not terminating, swapping, swapped, or inactive. The system ignores duplicate, invalid, or inactive job names specified. This parameter is only valid when you specify MAP=YES.

Specify job names with 1-8 characters, following the rules for a valid job name. You can use wildcard characters * and ? for pattern matching of job names. See "Using wildcards in commands" on page 19 for more information.

You can specify up to 32 job names, including all the pattern matches from wildcard characters. Note that using wildcard characters can result in requesting more than 32 physical jobs.

When you specify job names on **MAPJOB**, the system converts each active job name into one or more ASIDs. If the job is not active when the system does the load module mapping, the system will not produce load module information for that job. The system supports a total of up to 128 address spaces, including those specified on both the **MAPASID** and **MAPJOB** parameters. If you specify more than 128 address spaces, the system produces load module mapping data for the first 128 address spaces and ignores the rest. For example, **MAPJOB=(*)** might produce load module

mapping information for 128 active address spaces, starting with ASID 1. If you need load module map data for more than 128 address spaces, specify **MAPASID=ALL**. When you specify **MAPASID=ALL**, the load module map data for all active ASIDs can be returned. If you specify **MAPJOB** with any value, you will always map the nucleus and LPA areas as well.

You may want to enable tracking of directed load modules with the **SETPROG TRACKDIRLOAD** command so that your results are complete. See "Tracking directed load modules" on page 736.

Examples:

- **MAPJOB=(task1,grs,omvs,db*,task2)**
- **MAPJOB=(o*s)**
- **MAPJOB=(JOB1??.JE*)**

Default: None.

{MAPVERBOSE|MAPV}

Optional keyword specifying that you want the system to produce additional diagnostic information about any errors encountered during the load module mapping phase of data collection. **MAPVERBOSE** specifies that the system issues system messages to the job log if it encounters multiple errors during load module mapping. This parameter is only valid when you specify **MAP=YES**.

You can only specify **MAPVERBOSE** if you also activate the load module mapping with the **MAPONLY**, **MAPASID**, or **MAPJOB** parameters. If you specify **MAPVERBOSE** without specifying one of these load module mapping parameters, the system ignores the **MAPVERBOSE** parameter.

Default: None; no load module mapping diagnostic information is collected.

{CNTONLY|CTRONLY|MAPONLY}

These optional keywords allow you to limit collection, as follows:

CNTONLY|CTRONLY

Specifies that you want to collect only event counter set data. Data collection for instruction address sampling is not activated. The system generates only a .CNT z/OS UNIX System Services output file. (The system does not generate .SMP and .MAP output files if you specify **CNTONLY**.) **CTRONLY** is an alias of **CNTONLY**.

When this keyword is specified, you cannot specify keywords associated with instruction sampling, such as **SAMPTYPE** and **SAMPFREQ**.

Keywords allowed with **CNTONLY** include **TITLE**, **PATH**, **DURATION**, **CNTSET**.

The **CNTONLY** parameter is equivalent to **CNT=YES,SMP=NO,MAP=NO**.

MAPONLY

Specifies that you want to collect only load module mapping information. Data collection event counter sets and instruction address sampling is not activated. The system generates only a .MAP z/OS UNIX System Services output file. (The system does not generate .SMP and .CNT output files if you specify **MAPONLY**.)

When you specify **MAPONLY**, you must also specify **MAPASID** or **MAPJOB** (or both) to identify the address spaces for which you want private

MODIFY command

load module map data. You cannot specify keywords associated with sampling and counter sets, such as **SAMPTYPE**, **SAMPFREQ**, or **CNTSET**.

Keywords allowed with **MAPONLY** include **TITLE**, **PATH**, **MAPASID**, **MAPJOB**.

The **MAPONLY** parameter is equivalent to **CNT=NO**, **SMP=NO**, **MAP=YES**.

{REFRESH|REFR}

Optional parameter instructing the system to refresh the HISSERV service. A refresh of the service will allow the service to begin using any counter set or sample type recently authorized through the Hardware Management Console. **REFRESH** is mutually exclusive with all other service parameters.

Example 1: Start the HIS Profiler data collection using defaults, including SMF data, and create **.CNT** and **SMP.cpu#**. files. By default, the following instrumentation data are captured besides SMF data:

- Data from the basic and problem state counter sets
- Basic sampling data

Because no service parameters were explicitly specified with the **PERSIST** option, all service parameters will be changed to the defaults.

```
MODIFY hisproc,BEGIN
```

Example 2: Start the HIS Profiler for data collection that runs for 12 minutes, collects load module mapping information for jobs PGMA and PGMB. collects SMF data and creates **.MAP**, **.CNT** and **SMP.cpu#**. files. Because all service parameters are explicitly specified with the **PERSIST** option, they will remain at their prior values.

```
MODIFY hisproc,BEGIN,DURATION=12,MAPJOB=(PGMA,PGMB),BUFCNT=PERSIST,  
SAMPTYPE=PERSIST,SAMPFREQ=PERSIST
```

Example 3: End the HIS Profiler for data collection:

```
MODIFY hisproc,END
```

Example 4: Refresh HISSERV to begin using the counter sets and sample types that were recently authorized through the Hardware Management Console, and then increase the buffer count to allow for additional data. **SAMPREQ** and **SAMPTYPE** will be implicitly changed to their default values.

```
MODIFY hisproc,SERVICE,REFRESH  
MODIFY hisproc,SERVICE,BUFCNT=100
```

Example 5: Direct HISSERV to stop generating sampling data for profilers requesting it. These changes are global and will affect all exploiters. **BUFCNT** and **SAMPFREQ** are specified as **PERSIST** to maintain their values.

```
MODIFY hisproc,SERVICE,SAMPTYPE=NONE,BUFCNT=PERSIST,SAMPFREQ=PERSIST
```

Example 6: Direct HISSERV to generate basic sampling data, the default, at a frequency of 100,000 samples per minute, and use the default buffer count. These changes are global and will affect all exploiters.

```
MODIFY hisproc,SERVICE,SAMPFREQ=100000
```

Example 7: Direct the HIS Profiler to begin collecting just counter data for problem diagnosis for IBM. These specific options may be the most commonly requested by IBM. All HIS exploiters are affected. This particular command labels the measurement 'Counters Only', requests data for basic and extended counter sets, sends the output to the **.CNT** file in the /HIS OMVS directory, (no **.MAP** or **.SMP** files are produced). Data collection for instruction address sampling is not

activated, and the **SAMPTYPE**, **SAMPFREQ**, and **BUFCNT** values have been preserved with the **PERSIST** option. SMF record type 113 will be recorded in sync with the SMF global recording interval, and this current run will save all data collected as if the duration of the run has expired. It will then resume collecting hardware event data in the new state until a **MODIFY hisproc,END** command is issued.

```
MODIFY hisproc,BEGIN,TT='Counters Only',PATH='/HIS',CNTONLY,CNTSET=(B,E),SI=SYNC,
SC=SAVE,SAMPTYPE=PERSIST,SAMPFREQ=PERSIST,
BUFCNT=PERSIST
```

Example 8: Direct the HIS Profiler to begin collecting extensive data for problem diagnosis for IBM. These specific options may be the most commonly requested by IBM. All HIS exploiters are affected by the **MODIFY hisproc,BEGIN** command. This command labels the measurement 'FOR IBM', sends the output to the /HIS OMVS directory, requests data for basic, problem, cryptographic, and extended counter sets, requests a map of all swapped in address spaces, and uses a buffer count of 1024 4K buffers. The recommended buffer count value is 1024 for minimal overhead at the expense of more storage (1024 4K blocks per processor.) The sampling data is basic, with the frequency of 800,000 samplings per minute and will run for 10 minutes.

```
MODIFY hisproc,BEGIN,TT='FOR IBM',path=/HIS,CNTSET=(B,P,C,E),MAS=ALL,BUF=1024,ST=B,
SF=800000,DUR=10
```

Building and replacing library lookaside directories

Use the **MODIFY LLA** command to cause the library lookaside (LLA) program to build a new copy of all or part of the library directory indexes and then replace the old copy with this new copy.

```
F LLA,{REFRESH }
      {UPDATE=xx}
      {UPDATE,LIBRARY=libname[,MEMBER=[memname|(memname1{,...,memnamen})]]}
```

The parameters are:

LLA

The name of the job.

REFRESH

Causes LLA to build a new copy of all the library directory indexes for the complete set of data sets currently managed by LLA. This procedure is necessary when an installation makes changes to the LLA directories.

UPDATE=xx

Causes LLA to rebuild a specified part of the directory. *xx* identifies the CSVLLAxx parmlib member or the data set pointed to by the IEFPARM DD statement in the START LLA procedure. CSVLLAxx contains libraries LLA is to manage.

UPDATE,LIBRARY=libname[,MEMBER=memname]

Causes LLA to update an entire LLA managed library or to update specific members of that library.

LIBRARY=libname

identifies one library managed by LLA to be updated. Only one library managed by LLA can be specified; UPDATE,LIBRARY can not be used

MODIFY command

to add a library to LLA management. LLA rejects the command if the UPDATE,LIBRARY request is for a library not currently managed by LLA.

Do not specify “-LNKLST-” for *libname*.

LIBRARY can be specified as LIBRARIES (but only one *libname* can be specified).

MEMBER=memname

identifies one or more members of the specified library to be updated. MEMBER can be specified as:

MEMBER=*memname*

MEMBER=(*memname*)

MEMBER=(*memname1,memname2,...*)

If MEMBER is omitted, the entire library is updated.

If multiple member names are specified, they must be in a comma-separated list enclosed in parentheses

MEMBER can be specified as MEMBERS (regardless of whether you are specifying one or more than one member).

Note:

1. Use the MODIFY LLA command rather than stopping and restarting LLA to change the library directory indexes; system performance is slowed anytime LLA is stopped.
2. The MODIFY LLA command does not reload (or refresh) modules that are already loaded, for example, modules in long-running or never-ending tasks. The refreshed version does not get picked up unless the module is loaded after the MODIFY LLA completes. To refresh such a module, the system programmer has two options:
 - If the module has no co-requisite requirement in LPALIB, you can use the subsystem's command to replace the module, or stop and then restart the long-running or never-ending task.
 - Re-IPL the system with the CLPA option.

Operating with the network file system server

The network file system server provides transparent access from different client workstations to MVS data sets. It allows access to most file formats available under MVS. A server provides resources to the network service, such as disk storage and file transfer. For more information about the network file system server, see *z/OS Network File System Guide and Reference*.

Managing the object access method (OAM)

Use the MODIFY OAM command to display information about the object access method (OAM) or to request that OAM perform a specified service: object management, space management, or recovery functions.

F OAM,parameters

For a detailed discussion of the MODIFY OAM command parameters, see the *z/OS DFSMS OAM Planning, Installation, and Storage Administration Guide for Object Support*, and the *z/OS DFSMS OAM Planning, Installation, and Storage Administration Guide for Tape Libraries*.

Recycling z/OS UNIX System Services (z/OS UNIX)

Use the MODIFY OMVS command to recycle z/OS UNIX System Services. This is an alternative to re-IPLing the the system in order to reinitialize the z/OS UNIX System Services environment. This command should be used only on a **limited** basis when complete reinitialization and reconfiguration are required. Prior to issuing MODIFY OMVS to initiate a shutdown, you should review the information about shutdown in *z/OS UNIX System Services Planning*.

The MODIFY OMVS,SHUTDOWN command completely disables z/OS UNIX services. IBM strongly recommends that an installation perform the following steps prior to issuing the command:

1. Attempt to dry up batch and interactive workloads. Once a shutdown request is accepted, jobs that subsequently attempt to connect to z/OS UNIX services for the first time will be delayed until restart occurs; jobs that are already connected to z/OS UNIX services (dubbed) will be sent terminating signals and will end abruptly.
2. Follow recommended procedures to quiesce applications and subsystem workloads using z/OS UNIX services. This will allow subsystems such as DB2, CICS, and IMS[™], and applications such as SAP, LOTUS DOMINO, NETVIEW, and WEBSPHERE to be quiesced in a more controlled manner than would occur if simply using this command. Use the D OMVS,A=ALL command to determine which applications, if any, require quiescing.
3. Shut down TCP/IP and all TCP/IP applications in the manner that TCP/IP recommends.
4. Shut down any colony PFS address spaces. This could potentially include NFS and DFS.

```
F OMVS{,SHUTDOWN}
  {,RESTART[,OMVS=(xx,yy)]}
```

The parameters are:

OMVS

The name of the job.

SHUTDOWN

Request that the system shut down the UNIX services environment, which includes quiescing all running UNIX services work on a given system.

RESTART

Request that the system restart the UNIX services environment which has shut down successfully.

OMVS

Specifies the parmlib member or members (BPXPRMxx) to use to locate the parmlib statements to configure the z/OS UNIX kernel.

If the OMVS parameter is not specified, the BPXPRMxx member used on the previous start of OMVS is processed again, with any updated contents taking effect.

MODIFY command

Example 1:

To shut down the UNIX services environment, enter:

```
F OMVS,SHUTDOWN
```

The following highlighted console message will be displayed when the shutdown request is accepted:

```
BPXI055I OMVS SHUTDOWN REQUEST ACCEPTED
```

If a shutdown request cannot be accepted, the following console message will be displayed:

```
BPXI057I OMVS SHUTDOWN REQUEST REJECTED
```

If a shutdown request is delayed because of blocking jobs or processes, the following console message will be displayed when the delay exceeds a finite time interval:

```
BPXI064E OMVS SHUTDOWN REQUEST DELAYED
```

Dynamically activating maintenance for z/OS UNIX System Services (z/OS UNIX)

Use the MODIFY OMVS command to dynamically activate maintenance for z/OS UNIX System Services.

```
F OMVS {,ACTIVATE=SERVICE}
        {,DEACTIVATE=SERVICE}
```

The parameters are:

ACTIVATE=SERVICE

Requests that the system dynamically activate SMP/E installable service for the z/OS UNIX kernel and logical file system (LFS) components without requiring a component restart or system IPL. The system activate the service from the target libraries specified in BPXPRMxx parmlib statements, SERV_LPALIB and SERV_LINKLIB. When the F OMVS,ACTIVATE=SERVICE is issued, the system allocates and opens load libraries specified on SERV_LPALIB and SERV_LINKLIB to locate and load the new services items. Therefore, do not update these libraries during the activation process.

Restriction: The ACTIVATE=SERVICE parameter will **only** activate those service items in the target libraries that are appropriate for the installation service level. Your installation's service level might be too low to allow dynamic activation of some service items in the target library.

Result: The system issues message BPXM061I to display the service items to be activated. It then issues BPXM061D and prompts for the activation to continue based on the information in BPXM061I. The operator can reply 'Y' to let activation continue. Any other reply cancels the command.

You can also use the DISPLAY command (D OMVS,ACTIVATE=SERVICE) to display the dynamically activated service. See "Displaying status of z/OS UNIX System Services" on page 380.

DEACTIVATE=SERVICE

Requests that the system dynamically back off a set of dynamically activated service items. You might need to use this command if you encounter a problem with a service item, or if you do not need it any longer. The

DEACTIVATE=SERVICE parameter dynamically deactivates **only** those service items that were activated with the previous ACTIVATE=SERVICE command.

Result:The system issues message BPXM063I to display the service items to be deactivated. It then issues message BPXM063D and prompts for the deactivation to continue based on the information in message BPXM063I. The operator can reply 'Y' to let deactivation continue. Any other reply cancels the command.

You can also use the DISPLAY command (D OMVS, ACTIVATE=SERVICE) to display the dynamically activated service. See "Displaying status of z/OS UNIX System Services" on page 380.

Stopping a physical file system (PFS) through a logical file system (LFS) interface

Use the MODIFY OMVS command to stop a PFS through an LFS interface.

```
F OMVS,STOPPFS=pfsname
```

The parameters are:

pfsname

Indicates the name of the PFS to be stopped. This is the name used on the FILESYSTYPE statement from the BPXPRMxx parmlib member that defined the PFS.

Passing a MODIFY command string to a physical file system (PFS) through a logical file system (LFS)

The MODIFY OMVS command passes a modify command to a PFS through an LFS interface. This command is useful when a PFS runs in the OMVS address space and wants to support MODIFY commands. It can also be used for PFSes that run in their own address space.

```
F OMVS,PFS=pfsname,command_string
```

The parameters are as follows:

pfsname

Indicates the name of the PFS that will receive the *command_string*. It is the name used on the FILESYSTYPE TYPE statement from the BPXPRMxx parmlib member that defined the PFS.

command_string

The command string to be passed from the LFS to the PFS. The LFS passes the command string to the PFS with a vfs_pfsctl with command code PC_MODIFYPFS. For a description of MODIFY commands that are supported by zFS, see *z/OS Distributed File Service zFS Administration*.

For a description of the MODIFY commands that are supported by TFS, see *z/OS UNIX System Services Planning*.

Replacing the sysplex root file system in the shared file system configuration (z/OS UNIX)

Use the MODIFY OMVS command to dynamically replace the sysplex root file system. This support does **not** copy any directories, data, or links from one sysplex root to another, and active connections to any files or directories will be broken on replacement of new sysplex root file system.

Requirements or restrictions: The following conditions are verified by the system before the replacement:

1. Use this supported function only in the shared file system configuration. The sysplex can be a single-system sysplex.
2. All systems in the shared file system environment must be at the level that supports this function.
3. The current sysplex root PFS and the new sysplex root PFS are up in all the systems in shared file system configuration.
4. The sysplex root must be locally mounted on all systems in the shared file system configuration.
5. Byte range locks must not be held on the sysplex root during replacement processing.
6. The current sysplex root and the new sysplex root must be either HFS or zFS in any combination.
7. The sysplex root or any directories on it cannot have been exported by the DFS or SMB server.
8. Remote NFS mounts of the sysplex root or any directories on it are considered as active use of the current sysplex root.
9. During the replacement, the new zFS sysplex root file system must not be HSM-migrated, mounted, or in use.
10. The UID, GID and the permission bits of the root directory in the new sysplex root file system must match those of the root directory in the current sysplex root file system.
11. If the SECLABEL class is active and the MLFSOBJ option is active, the multilevel security label for the new sysplex root must be identical to the assumed multilevel security label of the current sysplex root.

F OMVS,NEWROOT= <i>fsname</i> ,COND= <u>YES</u> NO FORCE

The parameters are:

NEWROOT=*fsname*

Specifies the new sysplex root file system that is to replace the existing one. The new file system must follow the sysplex root file system convention described in *z/OS UNIX System Services Planning*.

After the replacement, the MOUNT parameters are preserved or dropped depending on the type of the new file system:

- If the file system type is the same as the old file system, the MOUNT specifications are preserved.
- If the file system type is different from the old file system, the MOUNT specifications are dropped.
- If the MOUNT parameters have been dynamically changed, they are dropped anyway.

Message BPXF247I is issued if MOUNT parameters are dropped.

COND=YES

Proceed conditionally. Failure message BPXF244E is displayed. If any active usage is found in the current sysplex root file system, report the active usage through BPXF245I message to the console and stop the command processing. The default is COND=YES.

COND=NO

Proceed unconditionally. If any active usage is found in the current sysplex root file system, report the active usage through BPXF245I message to the console and continue processing the command to replace the current sysplex root file system with the new sysplex root file system. Active connections to any files or directories in current sysplex root file system will be broken when the new sysplex root file system replaces the current one, and might get an EIO return code.

COND=FORCE

Use the FORCE option if the current sysplex root file system is failing or unowned.

The BPXI085D message is issued to the console to confirm the FORCE option. Mount points are validated. Symbolic links are not validated. In addition to the restrictions listed previously, the following restrictions must be met to use the FORCE option:

- All systems in the sysplex must be at the V1R11 level or higher.
- The mount points in the current sysplex root file system must not exceed 64 characters in length.

For more information about replacing the sysplex root file system, see *z/OS UNIX System Services Planning*.

Stopping a temporary file system (TFS)

Use the MODIFY TFS command to stop a TFS running in a colony address space. The MODIFY TFS command can be used to force a TFS to stop or terminate even if TFS file systems are mounted.

Note: The MODIFY TFS command is not supported if TFS runs in the z/OS UNIX kernel address space.

For information about managing the temporary file system, see *z/OS UNIX System Services Planning*.

Changing the virtual lookaside facility (VLF) parameters

Use the MODIFY VLF,REPLACE,NN command to cause the virtual lookaside facility (VLF) to use the specified COFVLFxx member of the logical parmlib. See *z/OS MVS Initialization and Tuning Reference* for more information about the use of the COFVLFxx member.

```
F VLF,REPLACE,NN=xx
```

The parameters are:

VLF

The name of the job.

MODIFY command

REPLACE, NN=xx

Causes VLF to replace the current configuration with a new configuration. The *xx* value can be a single COFVLFxx member of the logical parmlib, or a concatenated list of up to 16 COFVLFxx parmlib members, enclosed within parentheses and separated by commas.

Example: The following command replaces the current VLF configuration with a new configuration from a concatenation of parmlib members COFVLF_{AA}, COFVLF_{BB}, and COFVLF_{CC}:

```
MODIFY VLF,REPLACE,NN=(AA,BB,CC)
```

Enabling and disabling the Application Response Measurement (ARM) services

Use the MODIFY WLM,AM command to enable or disable Application Response Measurement (ARM) services. For more information on ARM services, see, IBM Systems Software Information Center:

<http://publib.boulder.ibm.com/infocenter/eserver/v1r2/index.jsp?topic=/ewlminfo/eicauthzosusers.htm>

The complete syntax for the MODIFY WLM,AM command is:

```
F WLM,AM={DISABLE|ENABLE}
```

WLM

The name of the job.

AM Indicates that the state of ARM services is to be changed.

DISABLE

Disables ARM services. Applications calling any of the ARM services will receive a return code indicating that this function is not operational from that point on; however, the applications continue to run.

If ARM is disabled:

- A running guest platform management provider (GPMP) terminates.
- Manually starting the guest platform management provider (using the MODIFY WLM,GPMP,START command) results in message IWM078I.
- Activating a WLM policy that contains a valid configuration for the guest platform management provider does not result in the start of a GPMP instance.
- The state of the guest platform management provider is displayed as “DISABLED”. If ARM is enabled again, the state of the guest platform management provider changes to “STOPPED”. To start the guest platform management provider again, you need to use the MODIFY WLM,GPMP,START command to manually start it.

See “Starting, stopping and modifying options for the guest platform management provider” on page 581 for details about GPMP.

ENABLE

Enables previously disabled ARM services. ARM-instrumented applications that are already active at the time this command is invoked must be restarted if the ARM calls should be processed. In addition, when the ARM services are enabled, you can restart the GPMP.

Starting, stopping and modifying options for the guest platform management provider

Use the MODIFY WLM,GPMP command to start, stop and modify options of the guest platform management provider (GPMP).

The complete syntax for the MODIFY WLM,GPMP command is:

```
F WLM,GPMP, {START|STOP|TRACE=LOW|MEDIUM|HIGH[,DEST=FILE|MEMORY]}
```

WLM

The name of the job.

GPMP

Indicates that you can start, stop and modify options of the guest platform management provider manually.

START

Indicates that WLM starts the guest platform management provider.

- If the GPMP is already active, message IWM077E is issued.
- If ARM is disabled, message IWM078E is issued.

For details about messages IWM077E and IWM078E, see *z/OS MVS System Messages, Vol 9 (IGF-IWM)*.

STOP

Indicates that WLM stops the currently active guest platform management provider instance.

WLM does not automatically restart the guest platform management provider even if the WLM policy contains a valid guest platform management provider configuration. The guest platform management provider is restarted only if the MODIFY WLM,GPMP,START command is issued from the MVS console. Even in the case of an activation of a new policy that contains a valid guest platform management provider configuration, it is not restarted. The DISPLAY WLM,SYSTEMS operator command indicates that situation with a status of "STOPPED".

When the instance of the guest platform management provider terminates unexpectedly or when too many errors occur, the state in the DISPLAY WLM,SYSTEMS command is set to "FAILED".

TRACE=LOW|MEDIUM|HIGH

Enables the operator to dynamically change the level of trace data being collected for the guest platform management provider. By default, the guest platform management provider runs with a low trace level. Change this trace setting only under the direction of IBM Support.

DEST=FILE|MEMORY

Enables the operator to dynamically change the destination of trace data being collected. By default, the guest platform management provider writes trace data to memory. Change this trace setting only under the direction of IBM Support.

Example:

Only when IBM Support personnel request you to collect the guest platform management provider trace data that is required to diagnose a problem, issue the MODIFY WLM command to alter the trace level and destination for trace data:

MODIFY command

```
MODIFY WLM,GPMP,TRACE=HIGH,DEST=FILE
```

The system responds with messages FEW0614I and FEW0612I:

```
FEW0614I TRACE LEVEL CHANGED FROM LOW TO HIGH.  
FEW0612I TRACE DESTINATION CHANGED FROM MEMORY TO FILE.
```

Once these trace settings are changed, the values persist even if you restart the guest platform management provider or if you re-IPL, so you must reset them to prevent the file system from filling up with unnecessary trace data.

After collecting the trace data as instructed by IBM Support, reset the trace level and destination for trace data:

```
MODIFY WLM,GPMP,TRACE=LOW,DEST=MEMORY
```

Changing workload manager resource states

Use the MODIFY WLM command to change the state of a resource. This command changes the resource state only on the system where you issue the command.

Note: The MODIFY WLM command cannot be specified in the COMMNDxx parmlib member.

Resource states are used by workload management in conjunction with scheduling environments to ensure that work is scheduled only on a system with the appropriate resources to handle that work. See *z/OS MVS Planning: Workload Management* for more information about resources and scheduling environments.

The complete syntax for the MODIFY WLM command is:

```
F WLM, [RESOURCE=resourcename, {ON|OFF|RESET}]
```

WLM

The name of the job.

RESOURCE=*resourcename*

Changes the state of *resourcename*.

ON Specifies that if the required resource state in a scheduling environment is ON, that requirement will be satisfied on the target system.

OFF

Specifies that if the required resource state in a scheduling environment is OFF, that requirement will be satisfied on the target system.

RESET

Specifies that this resource setting will satisfy neither an ON nor an OFF resource requirement. Therefore if a scheduling environment includes *resourcename* in its list of resources (whether ON or OFF), then that scheduling environment will not be available on the target system.

Example:

To change the setting of the DB2A resource to ON, enter:

```
F WLM,RESOURCE=DB2A,ON
```

The system will respond:

IWM039I RESOURCE DB2A IS NOW IN THE ON STATE

Specifying data set selection criteria for an external writer

You can use the MODIFY command to specify the criteria that an external writer is to use in selecting data sets for processing.

```
F [XWTR.|jobname.]identifier,
  {{CLASS|C}=[classes]          }
  {{DEST|D}=[LOCAL              ]}
  |remote-workstation-name
  {{FORMS|F}=[forms-name]      }
  {{JOBID|J}=[JOBnnnnn|Jnnnnn  ]
  | [STCnnnnn|Snnnnn]
  | [TSUnnnnn|Tnnnnn]}
  {{WRITER|W}=[STDWTR          ] }
  |user-writer-name
```

The parameters are:

XWTR

The name of the IBM-supplied cataloged procedure for the external writer.

jobname

The job name assigned to the external writer.

The job name for a started task depends on whether the JOBNAME parameter was specified on the START command for the task:

- If JOBNAME was specified, *jobname* is the name specified on the JOBNAME parameter.
- If JOBNAME was *not* specified and the source JCL for the started task is a *job*, *jobname* is the name specified on the JCL JOB statement.
- If JOBNAME was *not* specified and the source JCL for the started task is a *procedure*, *jobname* is the member name.

You can use asterisk notation to specify more than one job or started task on the MODIFY command. See “Using asterisks in MODIFY commands” on page 534 for more information.

identifier

The identifier, from the START command, of the writer to be modified. (See “Displaying started task status” on page 353 for information about determining the jobname and identifier of currently active started tasks.)

The following types of identifiers can be used:

- The identifier that was specified on the START command.
- *[/devnum]*, the device number specified on the START or MOUNT command. A device number is 3 or 4 hexadecimal digits, optionally preceded by a slash (/). You can precede the device number with a slash to prevent ambiguity between the device number and a device type or identifier.
- *devicetype*, the type of device specified on the START or MOUNT command.

MODIFY command

If no identifier was specified, the identifier "STARTING" is temporarily assigned until the system can assign another according to the following order of precedence:

1. If an identifier was not specified on the START command, the identifier is the device type (for example, 3410) or device number (for example, X'0000') specified on the START or MOUNT command.
2. If an identifier, a device type, or a device number was not specified on the START or MOUNT command, the identifier is the device type specified on an IEFRDER DD statement (invoking a cataloged procedure) in the JCL.
3. If none of these was specified, the identifier defaults to the job name.

You can use asterisk notation to specify more than one job or started task on the MODIFY command. See "Using asterisks in MODIFY commands" on page 534 for more information.

CLASS= or C=[classes]

Select only data sets enqueued in the specified classes. You can specify up to eight output classes, in priority order.

The output classes are named without separating commas. If no default class was specified in the cataloged procedure to start the external writer, and no class list is provided in the START or MODIFY command, the external writer selects any ready data set on the hard-copy queue.

JOBID= or J= [JOB or J]nnnnn, [STC or S]nnnnn, or [TSU or T]nnnnn

Select only data sets from the job with this subsystem-assigned JOBID, where *nnnnn* is the JOB id number, the STC id number, or the TSU id number. If JOBID is omitted, the external writer does not select data sets by job.

Note:

1. JES2 ignores the prefix (JOB or J, STC or S, or TSU or T) and uses only the id number, *nnnnn*.
2. With JES2 operating on z/OS version 1.2 or higher, you may specify up to a six-digit id number, or *nnnnnnn*.

WRITER or W=

STDWTR

Select only data sets that are to be processed by the standard (IBM-supplied) writer.

user-writer-name

Select only data sets that are to be processed by the specified user writer.

If WRITER= is specified without STDWTR or user-writer-name, the external writer does not use the writer program as a data set selection criterion and automatically invokes the correct writer programs.

FORMS= or F=[forms-name]

Select only data sets that specify this forms name.

If *forms-name* is omitted, the external writer does not use the forms name as a data set selection criterion, and notifies you whenever a forms change is needed.

DEST= or D=

LOCAL

Select only data sets destined for the central processor complex.

remote-workstation-name

Select only data sets destined for the specified remote workstations attached to this local complex.

If DEST= is specified without LOCAL or remote-workstation-name, the external writer does not use the destination as a data set selection criterion.

Previously-specified options remain in effect until respecified. Before the first MODIFY command is issued, the default options are:

CLASS=(see note),JOBID=,WRITER=,FORMS=,DEST=LOCAL

Note: If no default class list is specified in the cataloged procedure to start the external writer, and you do not provide a class list in the START command, the external writer does not begin processing until you enter a MODIFY command.

The MODIFY command passes the entire command buffer, including comments, to the external writer that is to be modified. Therefore, all modifiable external writers should be sensitive to embedded blanks in their parameter fields.

Causing an external writer to pause

You can use the MODIFY command to cause an external writer to pause for operator intervention.

```
F [XWTR.|jobname.]identifier,{PAUSE|P}={FORMS  }
                                     {DATASET }
```

The parameters are:

XWTR

The name of the IBM-supplied cataloged procedure for the external writer.

jobname

The job name assigned to the external writer.

The job name for a started task depends on whether the JOBNAME parameter was specified on the START command for the task:

- If JOBNAME was specified, *jobname* is the name specified on the JOBNAME parameter.
- If JOBNAME was *not* specified and the source JCL for the started task is a *job*, *jobname* is the name specified on the JCL JOB statement.
- If JOBNAME was *not* specified and the source JCL for the started task is a *procedure*, *jobname* is the member name.

You can use asterisk notation to specify more than one job or started task on the MODIFY command. See “Using asterisks in MODIFY commands” on page 534 for more information.

identifier

The identifier of the writer to be modified. (See “Displaying started task status” on page 353 for information about determining the job name and identifier of currently active started tasks.)

The following types of identifiers can be used:

- The identifier that was specified on the START command.

MODIFY command

- *[/]devnum*, the device number specified on the START or MOUNT command. A device number is 3 or 4 hexadecimal digits, optionally preceded by a slash (/). You can precede the device number with a slash to prevent ambiguity between the device number and a device type or identifier.
- *devicetype*, the type of device specified on the START or MOUNT command.

If no identifier was specified, the identifier "STARTING" is temporarily assigned until the system can assign another according to the following order of precedence:

1. If an identifier was not specified on the START command, the identifier is the device type (for example, 3410) or device number (for example, X'0000') specified on the START or MOUNT command.
2. If an identifier, a device type, or a device number was not specified on the START or MOUNT command, the identifier is the device type specified on an IEFORDER DD statement (invoking a cataloged procedure) in the JCL.
3. If none of these was specified, the identifier defaults to the job name.

You can use asterisk notation to specify more than one job or started task on the MODIFY command. See "Using asterisks in MODIFY commands" on page 534 for more information.

PAUSE= or P=FORMS

For unit record devices, the writer is to pause when a change of forms is necessary. The writer stops when it encounters a form name other than the installation default form name on a SYSOUT DD statement.

PAUSE= or P=DATA SET

For unit record devices, the writer is to pause before starting to process each data set. When you are ready to continue processing, you can restart the writer by entering a single character response to message IEF382A.

Example 1:

To stop writer 00E before it processes each new data set, enter:

```
F 00E,PAUSE=DATA SET
```

Example 2:

To stop writer ABCD before it processes each new data set, enter:

```
F /ABCD,PAUSE=DATA SET
```

MODIFY (F) JES3 commands

JES3 will accept the following MVS MODIFY commands:

MODIFY JES3, CHK

The command allows the operator to check the 'health' of the JES3 address space. A summary report is issued to the console listing any unusual conditions found.

The command runs asynchronously to the JES3 address space code. Therefore, it is possible that JES3 is changing the data while the command is executing.

This can lead to an occasional program check or a loop while the command is executing. When a loop is detected, message "IAT6417 Command 'CHK ' exceeded 1 minute. Reply 'CANCEL' to stop" is issued and a response is required. In either case, enter the command again. If the error happens persistently, you can report the problem to IBM.

MODIFY JES3, INT=*n*

This command allows changing of the Monitoring interval for the Wait and Loop monitor. *n* specifies the interval in seconds. The default value is 10 seconds. The maximum value is 59940 (999 minutes).

The interval specification controls how frequently JES3 will check what the currently dispatched FCT is.

MODIFY JES3, THRSH=*n*

This command allows changing of the Monitoring threshold for the Wait and Loop Monitor. *n* specifies the threshold in seconds. The default value is 30 seconds. The maximum value is 300 seconds.

The threshold determines when messages IAT6397, IAT6398, IAT6415 and IAT6410 are issued for an FCT that has been continuously active for the specified number of seconds.

MONITOR command

Use the MONITOR command to display jobnames, data set status, and time-sharing user sessions continuously, and to add certain information to mount and demount messages. If you want to activate the monitor function without associating the monitor request with a console, use the SETCON MONITOR command.

The MONITOR command does not display Advanced Program-to-Program Communication/MVS (APPC/MVS) transaction programs.

Note:

1. To stop the MONITOR display, use the STOPMN command.
2. The monitor display ends when the specified MCS, HMCS or SMCS console is varied offline. The operator must re-issue the MONITOR command when the MCS, HMCS or SMCS console is restarted.
3. The DSNAMES and SPACE operands are not routable and are not sysplex wide.
4. The MONITOR command and operands are not sysplex wide when they are activated from a TSO user. In this case the TSO user names will only be displayed (in response to the DISPLAY OPDATA,MONITOR command) if they are active on the system where the display is processed.

Use the SETCON command if you want the system to generate monitor messages, but you do not want the messages to appear on the console.

Scope in a sysplex

The MONITOR command has sysplex scope only when you specify L=. See "Using commands that have sysplex scope" on page 12 for an explanation of sysplex scope.

MONITOR command

Syntax

The complete syntax for the MONITOR command is:

```
MN {JOBNAMES[,T] [,L={a|name|name-a}]}  
  {DSNAME                               }  
  {SPACE                               }  
  {STATUS                               }  
  {SESS[,T]                             }
```

Parameters

The parameters are:

JOBNAMES

The system is to display the name of each job when the job starts and terminates, and display unit record allocation when the step starts. If a job terminates abnormally, the job name appears in a diagnostic message.

DSNAME

The system is to display, in mount messages, the name of the first non-temporary data set allocated on the volume to which the messages refer. No data set name appears in messages for data sets with a disposition of DELETE.

Note: This operand is only effective on the system where the command was processed (system scope only).

SPACE

The system is to display, in demount messages, the available space on the direct access volume.

Note: This operand is only effective on the system where the command was processed (system scope only).

STATUS

The system is to display the data set names and volume serial numbers of data sets with dispositions of KEEP, CATLG, or UNCATLG whenever they are freed.

SESS

The system is to display the user identifier for each TSO terminal when the session is initiated and when it is terminated. If the session terminates abnormally, the user identifier appears in the diagnostic message.

T The system is to display the time (in hours, minutes, and seconds) along with the user identifier or job name information. When specified, **T** is activated for all consoles that have MONITOR turned on.

L=*a*, *name*, or *name-a*

The display area (*a*), console name (*name*), or both (*name-a*) where the system is to present the display. If you omit this operand, the console on which the MONITOR command is entered is assumed.

Example:

To display the job name information and the time when each job starts and terminates, enter:

```
MN jobnames,T
```

MOUNT command

Use the MOUNT command to allow allocation of an I/O device to all job steps that require a particular volume without intervening de-mountings and re-mountings of the volume. Because the system must schedule MOUNT commands, there is a short delay between when you issue the command and when the volume is mounted.

In a JES3 complex, use the MOUNT command with great care. When a volume is to be mounted on a JES3-managed direct access device, you must enter a MOUNT command on each system in the complex that has access to the device. In addition, if you are requesting that a volume be mounted on a JES3-managed unit, you must also enter a JES3 mount command (*MODIFY,S,M=...). See *z/OS JES3 Commands*.

Once the system has executed a MOUNT command, the specified device becomes reserved and remains mounted and reserved until an UNLOAD or VARY OFFLINE command is issued. A reserved direct access volume can be assigned the USE attribute of PUBLIC, PRIVATE, or STORAGE. A reserved tape volume can be assigned the USE attribute of PRIVATE or PUBLIC.

If you need to nullify a scheduled mount before the system executes the MOUNT command, use the CANCEL command.

Note that the system will issue a mount message for a pre-mounted volume. However, the mount message will only appear on the job's JES Job Log and in the SYSLOG. It will not appear on the operator's console.

Scope in a sysplex

The MOUNT command has sysplex scope only when you issue the command against an automatically switchable tape device. See "Using commands that have sysplex scope" on page 12 for an explanation of sysplex scope.

Syntax

The complete syntax for the MOUNT command is:

```
M {[/]devnum  },VOL=({NL},serial)[,USE={STORAGE}]
  {devicetype }      {SL}          {PUBLIC }
                   {AL}          {PRIVATE}
```

Parameters

The parameters are:

[/]devnum

The device number for the input/output device to be mounted. A device number is 3 or 4 hexadecimal digits. A slash (/) must precede a 4-digit number and is optional before a 3-digit number.

devicetype

The type of device to be mounted. It can be any IBM-supplied name (for example, 3380).

MOUNT command

VOL=(NL,*serial*)

The volume specified does not have a standard label. This parameter must not be used for direct access volumes. The serial number, up to six characters long, is used for allocation references.

Do not try to mount volumes with a label type of NL in a system-managed tape library these volumes are not supported.

VOL=(SL,*serial*)

The volume specified has a standard label (SL). The serial number, up to six characters long, is used for label verification and allocation references. Tape label verification is not performed until the tape is opened.

VOL=(AL,*serial*)

The volume has an American National Standard label (AL). The serial number, up to six characters long, is used for label verification and allocation references. AL can be specified only if it was selected as an option at system installation. Tape label verification is not performed until the tape is opened.

USE=STORAGE, PUBLIC, or PRIVATE

The USE attribute, defined by your installation procedures, to be assigned to the specified volume. Refer to *z/OS MVS Initialization and Tuning Guide* for more information on USE attributes.

Example 1:

To request that a volume with a standard label of 222222 be mounted on device 282, enter:

```
m 282,vol=(sl,222222),use=private
```

Example 2:

To request that a volume with a standard label of 222222 be mounted on device 3333, enter:

```
m /3333,vol=(sl,222222),use=private
```

Tape library dataserwer considerations

The MOUNT command is the only type of library request that can be used to request a specific system-managed tape library device. (Requesting a specific device is also called demand allocation.) The request must specify a system-managed tape library volume.

Table 39 shows the possible volume and device combinations you can specify on the MOUNT command, and how the system will handle those inputs.

Table 39. Possible Volume and Device Combinations on MOUNT Command

Volume location:	Device location:	System action:
Non-library	Non-library	Processing continues
Non-library	Library	Issues error message IEF120I
Library	Non-library	Issues error message IEF113I
Library A	Library B	If volume and device are in different libraries — issues error message IEF111I

Table 39. Possible Volume and Device Combinations on MOUNT Command (continued)

Volume location:	Device location:	System action:
Library A	Library A	If volume and device are in the same library but the volume record for the device could not be obtained from the tape configuration data base — issue error message IEF150I.
Library A	Library A	If the requested device is not found in the device pools returned by the system – issue error message IEFA106I.

Tape multi-volume considerations

When a tape volume is premounted using the MOUNT command, the system will not dismount that volume even if additional volumes are required for the data set. Instead, an additional tape drive or drives will be allocated for the additional volumes. For example, assume that dataset BACKUP.SMFDATA.DAILY already resides on tape volume 123456, which is premounted using the MOUNT command.

```
//DUMPOUT DD DSNAME=BACKUP.SMFDATA.DAILY,DISP=(MOD,KEEP),
//          VOL=(,,40)
```

If a job has a DD statement with a volume count of 40, it will cause the system to allow for 39 scratch volumes. But since volume 123456 may not be dismounted, the system will allocate an additional tape drive for the scratch volumes, even if the data set does not extend onto any additional volumes.

Note also that the system will issue a mount message for the premounted volume. However, the mount message will only appear on the job's JES Job Log and in the SYSLOG. It will not appear on the operator's console.

PAGEADD command

PAGEADD adds auxiliary storage space (local page data sets) to the system. The page data sets added remain available to the system until you IPL with the CLPA (create link pack area) option, IPL with the CVIO (clear virtual I/O) option, or issue a PAGEDEL command. PAGEADD can also direct VIO pages away from a page data set that is being added.

Use the PAGEADD command only at the request of your system programmer.

You might need to add auxiliary storage space if any of these conditions exist:

- The planned system load increases.
- The space provided during system initialization proves insufficient.
- Space is lost because of a hardware failure.

If the system detects a shortage of available auxiliary storage space, it issues the following message:

```
IRA200I AUXILIARY STORAGE SHORTAGE
```

The system rejects LOGONs and START commands until the shortage is relieved. If the shortage increases, the system issues the following message:

```
IRA201I CRITICAL AUXILIARY STORAGE SHORTAGE
```

PAGEADD command

The system rejects LOGONs and START commands and might delay the starting of certain initiators until the shortage is relieved.

Requested data sets are placed in use in the order specified in the command. The system informs you when each is available for use.

The number of page data sets that can be in use by the system is limited by the number specified on the PAGTOTL system parameter. (See *z/OS MVS Initialization and Tuning Guide*.) If these limits are exceeded, the system issues a message, and you cannot add any more data sets of that type during this IPL. However, if the limit has been exceeded for one type of data set, you could still add data sets of the other type.

If your paging device contains a subsystem cache, it is important to note that the PAGEADD command determines the status of the subsystem cache and resets it, if necessary. However, MVS does not set the subsystem cache on if it was powered off with the IDCAMS command SETCACHE SUBSYSTEM OFF. MVS resets the data in the cache only under certain circumstances, such as at a cold start or at the first issuance of a PAGEADD command to the device.

The page data sets must be defined before you can issue the PAGEADD command. If the volume containing the data set is not mounted before you enter the command, the system issues a mount message.

A data set that is draining, as the result of a PAGEDEL DRAIN command, can be made read/write again by issuing a PAGEADD for the data set. A data set that has been marked BAD cannot be made read/write again with the PAGEADD command.

When you issue a PAGEADD command for a data set previously deleted with a PAGEDEL command, the system might indicate that some slots are already in use on the newly allocated data set. These slots contain pages that the system has migrated to another data set but that the owner has not yet referenced. Once the owner references the page, the system frees the slot both from the newly allocated data set and from the data set on which the page actually resides.

Use the DISPLAY ASM command to identify the page data sets the system is currently using.

Syntax

The complete syntax for the PAGEADD command is:

```
PA {[PAGE=]} {dsname[,dsname]...}  
  {NONVIO=}
```

Parameters

The parameters are:

[PAGE=] *dsname* [, *dsname*] ...

The name of one or more page data sets to be added. If *dsname* is not the name of a page data set, the system issues message IEE782I.

NONVIO=dsname [,dsname]...

The name of one or more page data sets to be added. The system is not to use these added page data sets to receive VIO pages.

Example 1: To add one page data set, enter:

```
PA page3
```

Example 2: To add three page data sets, enter:

```
pa page=sys1.page01,sys1.page02,page3
```

Example 3: To add SYS1.PAGE01 as a page data set and specify not to use it for VIO paging, enter:

```
PA NONVIO=SYS1.PAGE01
```

PAGEDEL command

Use the PAGEDEL command to delete, replace, or drain (quiesce) local page data sets.

Attention: Use this command only at the request of your system programmer. Misuse can seriously impair system performance.

This command allows you to remove or replace local page data sets without requiring an IPL.

Note: Draining a data set means freeing its in-use slots. The system effects this by making the data set read-only.

You might need to delete, replace or drain local page data sets for any of the following reasons:

- The hardware is being reconfigured.
- The hardware is generating I/O errors.
- The page configuration is being changed.
- System tuning requires the change.

When you *replace* a local page data set, the system migrates the in-use slots from the old data set to the new one.

When you *delete* a page data set, the system migrates the in-use slots to other data sets before it deletes the data set. When ASM migrates pages, storage-class memory (SCM) is not used as part of the auxiliary storage pool. Before ASM migrates pages, you must ensure that sufficient space is available on other paging data sets.

The system keeps track of the in-use slots on both the old or deleted data set and the new data set until the owner references the pages. Thus, when you issue a PAGEADD command to allocate a new data set, the system might indicate that some slots on the newly allocated data set are already in use. As soon as the owner references a page, the system frees the slot both from the newly allocated data set and from the data set to which the page was migrated.

Note:

1. You cannot use PAGEDEL to delete, replace, or drain the PLPA, common, or the last local page data sets.

PAGEDEL command

2. When you enter a PAGEDEL command, the system issues a highlighted, non-rollable message to indicate that the command is accepted. The message remains on the console screen until the PAGEDEL command completes.
3. If you enter a PAGEDEL command while a PAGEDEL command is already in progress, the system issues a message that it rejects the command.
4. The system rejects a PAGEDEL command that decreases the amount of auxiliary storage below a fixed percentage of the available auxiliary storage.
5. To identify the page data sets the system is currently using or the status of the PAGEDEL command, issue the DISPLAY ASM command.
6. When issuing the PAGEDEL DELETE command, there is the potential for significant storage usage. Several blocks of storage in ESQA are obtained in order to process the PAGEDEL command. This includes a x'500' byte block for each cylinder on the deleted data set that contains in-use slots. Some of this storage will remain in use and not freed until all the in-use slots are freed, which could be some time after the PAGEDEL has completed (as indicated by message IEE205I).

If possible, use the PAGEDEL REPLACE option instead of the DELETE option to avoid the ESQA storage usage associated with the DELETE option. With the REPLACE option, slots are migrated from the old data set directly to the new data set without the need to keep track of the location of the migrated slots (thus eliminating the need for extra ESQA storage).

Syntax

The complete syntax for the PAGEDEL command is:

```
PD {DELETE,PAGE={dsname[,dsname]...}           }
   {REPLACE,PAGE={{(dsname,rdsname)[,(dsname,rdsname)]...}}
   {DRAIN,PAGE={dsname[,dsname]...}           }
```

Parameters

The parameters are:

DELETE

Specifies that the system is to remove one or more local page data sets from system use. The system migrates the in-use slots of the deleted data set(s) to other page data sets.

REPLACE

Specifies that a local page data set is to be replaced by a newly-opened data set of equal or greater size. The new data set must previously have been formatted and cataloged. It can be on a different type of device than the original data set. REPLACE fails if an I/O error occurs on either data set. The system migrates the in-use slots from the old data set to the new data set, then remove the old data set from system use.

DRAIN

Specifies that one or more local page data set are to be made read-only. When the current tasks complete, the in-use slots are freed during normal system operation. When you plan a PAGEDEL DELETE or REPLACE operation as part of a system reconfiguration, by allowing the data sets to drain (quiesce) before issuing the DELETE or REPLACE, you will reduce the number of in-use page

data sets to migrate. You can make a data set that is draining read/write again by issuing a PAGEADD command for the data set.

PAGE=dsname [,dsname] . . .

The name of one or more local page data sets. If *dsname* is not the name of an in-use local page data set, the system issues messages IEE201I and IEE202I.

(dsname,rdsname) [(dsname,rdsname)] . . .

The name of one or more data sets to be replaced by the new data set name(s). If any data set name you specify as (*dsname*) is not the name of an in-use local page data set, if any data set name you specify as (*rdsname*) is in use, the system issues messages IEE201I and IEE202I.

Example 1:

To delete a local page data set, enter:

```
PD DELETE,PAGE=page3
```

Example 2:

To delete three local page data sets, enter:

```
PD DELETE,PAGE=sys1.page01,sys1.page02,page3
```

Example 3:

To replace SYS1.PAGE01, a local page data set, and specify SYS1.PAGE04 to replace it, enter:

```
PD REPLACE,PAGE=(sys1.page01,sys1.page04)
```

Example 4:

To replace two local page data sets, enter:

```
PD REPLACE,PAGE=(sys1.page01,sys1.page02),(page3,page7)
```

QUIESCE command

Use the QUIESCE command to put the system in a manual state without affecting job step timing; for example, when you want to alter storage. You can enter QUIESCE only from a console with MASTER authority. You can restart the system by performing the RESTART function.

Syntax

QUIESCE

If possible, all jobs currently processing terminate normally. Otherwise, current activity is suspended, and the system enters a manual state or a wait state with a code of hexadecimal 80000CCC. See *z/OS MVS System Codes* for more information on wait state code CCC. You might receive the following message on an MCS, HMCS or system console:

```
BLW002I  SYSTEM WAIT STATE 'CCC'X - QUIESCE FUNCTION PERFORMED
```

Note:

QUIESCE command

1. If this system is actively using global resource serialization to share global resources and the global resource serialization complex is not the same as the sysplex, issue a VARY GRS (*), QUIESCE command before issuing the QUIESCE command. Issuing a VARY GRS (*), QUIESCE command before issuing the QUIESCE command prevents the disruption of the global resource serialization ring.
2. Do not issue a SYSTEM RESET after quiescing the system if you intend to issue a RESTART after the quiesce. Issuing a SYSTEM RESET will cause the system to enter an enabled wait state.

REPLY command

Use the REPLY command to respond to system requests for information. The system associates an identification number with each information request it makes. The REPLY command for a specific request must contain the same identification number as the request. The verb, REPLY or R, is not required when you respond to a request.

When MVS is running in a single system (or in a sysplex configured for eight or fewer systems), reply IDs are assigned in sequential order. For example, four sequential WTORS might be assigned reply IDs 01, 02, 03, 04. An operator monitoring a console that sees all WTORS could expect to see all four reply IDs (01, 02, 03, 04), without skipping a number. If there were multiple consoles that received WTORS, an operator might track down any missing reply IDs and see who replied (or if it was replied to).

In a sysplex configured for greater than eight systems, reply IDs might not appear in sequential order. For example, an operator might see reply IDs 01, 02, 04, 03. This is normal and does not affect system processing.

Table 40 summarizes the system requests for information for which you would use the REPLY command.

Table 40. Summary of the REPLY Command

Topic:
"Replying to system information requests" on page 597
"Replying to system requests during recovery processing" on page 598
"Replying to system security WTORS" on page 598
"Setting the time-of-day clock" on page 598
"Specifying component trace options" on page 600
"Specifying dump options" on page 600
"Specifying SMF options" on page 601
"Specifying system parameters" on page 602

Using system symbols in REPLY commands

When system symbols are specified in the REPLY command, the system that receives the WTOR message substitutes text for the system symbols in the response portion ('text') of the command. There are two exceptions to that rule:

- If the WTOR is synchronous, the system does not substitute text for system symbols in the reply 'text'.

- If the WTOR is issued early in the IPL (while the NIP console is still in use), the system cannot substitute text for system symbols that are not yet processed. If the WTOR is issued after message IEA347A SPECIFY MASTER CATALOG PARAMETER, the system substitutes text for all system symbols.

Note: The system issues message IEE600I in place of message IEE295I for replies during system initialization that are changed by symbolic substitution.

For more information about using system symbols in system commands, see “Using system symbols in commands” on page 16.

Scope in a sysplex

The REPLY command has sysplex scope. See “Using commands that have sysplex scope” on page 12 for an explanation.

Syntax

The general syntax for the REPLY command is:

```
[R] id[,]['text'|text]
```

Replying to system information requests

You can use the REPLY command to respond to system requests. To review outstanding requests before replying, issue DISPLAY R.

```
[R] id[,]['text'|text]
```

The parameters are:

id The identification number (0-9999), as specified in the message requesting a response. Leading zeros can be omitted. You may also specify a value of 00.

'text'

The response to the message. The apostrophes are optional and need only be included if your answer contains uppercase and lowercase characters. If you include the apostrophes and your answer contains an apostrophe, use two apostrophes in the message text.

The short form of the REPLY command does not require that you enter either REPLY or R. The short form of the reply command allows you to enter a total length of 124 character spaces. Anything beyond that length is truncated. If the system console is not in problem determination mode, you cannot use the short form of the REPLY command when responding to WTORs from the system console.

The RMAX value can affect the way you enter the short form of the REPLY command. The RMAX value determines the maximum number of REPLY ids that you can use to respond to WTOR messages.

REPLY command

On JES2 systems, when using the short form of the REPLY command, the operator can omit the comma, but the system might misinterpret the command, depending on the RMAX value. For example, if RMAX is 99, and the operator enters the following:

```
103NONE
```

MVS interprets the command as follows:

```
R 10,3NONE
```

On JES3 systems, an operator must use a comma to separate the REPLY id from the command text:

```
5,NONE
```

Example:

To use the short form of the REPLY command to reply 'U' to system message 03

On JES2 systems, enter:

```
3u
```

On JES2 and JES3 systems, enter:

```
3,u
```

Replying to system requests during recovery processing

During system recovery processing, normal console operations are suspended. The system uses the first available console specified in SYNCHDEST to display synchronous WTOR messages. The system will wait 125 seconds for a reply. If there is no reply, the system displays the WTOR messages on the next available console in SYNCHDEST. If there is no reply on the next console, the system displays the WTOR messages to the system console. These messages remain displayed until a reply is given on any console.

```
R [00|0][,]['text'|text]
```

Replying to system security WTORs

System security WTORs are specified with ROUTCDE=9. When you reply to a security WTOR, instead of seeing the actual response text on the display screen, you will see the text "SUPPRESSED" and the SYSLOG and SMF record type 80 reports will also show "SUPPRESSED" instead of the actual response text.

Setting the time-of-day clock

Once the system has been initialized, it can issue one of two messages, depending on whether or not the time-of-day clock is set.

If the time-of-day (TOD) clock is not set, the system asks you to set it:

```
* 00 IEA886A TOD CLOCK(S) MUST BE SET
```

Use the following form of the REPLY command to set the time of day clock:

```
R 00, '[DATE=yyyy.ddd] [,CLOCK=hh.mm.ss] [,UTC] '
```

Where *yyyy* is the year (1924-2042), *ddd* is the day (001-366), *hh* is the hour (00-23), *mm* is the minute (00-59), and *ss* is the second (00-59). Note that you must specify the year *yyyy* using four digits.

Note: The apostrophes in the reply are optional.

If you include UTC in your reply, the time and date are Coordinated Universal Time. GMT is obsolete, but will be accepted as an alias of UTC. Without the UTC parameter the system assumes the values are local time and date, and only updates the local time of day offset without affecting UTC.

When you have entered a valid reply to message IEA886A, the system issues message IEA903A, requesting a response. There are two possible responses, depending on the environment in which MVS is running. The first requests you to reply U to message IEA903A and, at the exact time that matches the TOD clock setting, press the TOD clock security switch. The second version does not request you to press the TOD clock security switch. You reply U to message IEA903A and, at the exact time that matches the TOD clock setting, press the ENTER key for the reply text. Once you have successfully set the TOD clock, or if the TOD clock is already set but you are allowed to alter it, the system displays the time and date and gives you the option of accepting or changing them:

```
* id IEA888A UTC DATE=yyyy.ddd,CLOCK=hh.mm.ss
      IEA888A LOCAL DATE=yyyy.ddd,CLOCK=hh.mm.ss REPLY U, OR UTC/LOCAL TIME
```

If the values are acceptable, reply 'U'. If you want to change either the local date or time (or both) or the TOD clock, enter the new value(s) as follows, remembering that you must include the UTC parameter to change the value of the TOD clock:

```
R id, '[DATE=yyyy.ddd] [,CLOCK=hh.mm.ss] [,UTC] '
```

Again, the year *yyyy* must have four digits, and the apostrophes are optional.

Note: The system automatically issues message IEA888A at IPL time if the OPERATOR PROMPT parameter is included in the active CLOCKxx parmlib member. (See *z/OS MVS Initialization and Tuning Guide* for details.)

If you specified a different clock setting, the system issues message IEA903A (which was described earlier). If you omitted UTC, the system assumes local date and/or time. Once you have set the new time and/or date, the system re-issues message IEA888A with new values. Reply to the message as described above.

Resetting UTC time causes the system to reset the TOD clock and recalculate the local time value, using the new UTC or GMT and the system time zone constant.

Resetting local time does not affect UTC time or the TOD clock. However, it will cause the system to recalculate the system time zone constant (which is initialized at IPL from the CLOCKxx parmlib member). The new time zone constant remains in effect until either local time is modified again or the next IPL.

All of the real time TQEs get adjusted when the local time is updated. Outstanding real time TQEs have their time adjusted based on the local time change that was made. For the External Timer Reference (ETR) or Server Time Protocol (STP), an

REPLY command

external interrupt occurs with the time zone offset change, and the timer supervisor code invokes the same TQE time adjustment routine.

If message IEA888A indicates that both UTC and local time values are incorrect, reset the UTC value first.

Note: Set the TOD clock to a value based on zero being equivalent to 00 hours, 00 minutes, 00 seconds on January 1, 1900 UTC. During an IPL, the TOD clock might contain a value that, relative to this base, is not correct. This can happen, for example, when a customer engineer (C.E.) left the clock in the error state. In such a case, to ensure that the local time and date are correct, specify UTC before setting the local time and date.

Specifying component trace options

After you issue a TRACE CT command, the system prompts you for the options you want to specify with message ITT006A. Use the following form of the REPLY command to respond to this message:

```
R id[,ASID=(nnnn[,nnnn]...)]  
    [,JOBNAME=(name[,name]...)]  
    [,OPTIONS=(name[,name]...)]  
    [,WTR={membername|DISCONNECT}]  
    [,CONT|,END ]
```

Note: When you specify CONT or END, it must be the last parameter on the input line.

For a detailed explanation of the TRACE CT options, see “Specifying TRACE CT options” on page 915.

Specifying dump options

After you issue a DUMP command, the system prompts you for the DUMP options you want to specify with message IEE094D. Use the following form of the REPLY command to respond to this message:

```
R id,U
```

or

```
R id[,ASID=(n[,n]...)] [,JOBNAME=(name[,name]...)] [,TSONAME=(name[,name]...)]  
    [,DSPNAME=(dspname-entry[,dspname-entry]...)]  
    [, {PROBDESC|PROB|PD}=key-spec] [,REMOTE=(request[,request]...)]  
    [,SDATA[=(option[,option]...)] [,STOR=(beg,end[,beg,end]...)]  
    [,STRLIST=(s-option[,s-option]...)] [,DEFERTND=Yes|No]  
    [,CONT|,END]
```

Note:

1. When you specify CONT or END, it must be the last parameter on the input line.
2. The CONT keyword does not work within a SYSP= list.
3. When you specify U, it must be the first parameter following the identification number.

Where **request** represents:

```

{GRPLIST={group(member)
           {(group(member[,member]...) [,group(member[,member]...)...) } }
}
{SYSLIST={sysinfo|(sysinfo[,sysinfo]...) }
          [,DSPNAME|,DSPNAME=(dspname-entry[,dspname-entry]...) ]
          [,SDATA|,SDATA=(option[,option]...) ]
          [,STOR|,STOR=(beg,end[,beg,end]...) ]
}

```

Where **s-option** represents:

```

STRNAME=strname
  [,CONNAME=conname ]
  [,ACCESSTIME={ENFORCE|NOLIMIT|NOLIM} ]
  [,LOCKENTRIES ]
  [,USERCNTLS ]
  [,EVENTQS ]
  [, (EMCONTROLS={ALL|(list)}) ]
  [, ({COCLASS|STGCLASS|LISTNUM}={ALL|(list)}
     { [,ADJUNCT={CAPTURE|DIRECTIO}] [,ENTRYDATA={UNSERIALIZE|SERIALIZE}] }
     { [,SUMMARY] }) ]

```

For a detailed explanation of the DUMP options, see “Specifying dump options” on page 489.

Specifying SMF options

If PROMPT (LIST or ALL) is specified in the SMFPRMxx parmlib member, you can change the SMF options, and you receive this message:

```
IEE354I SMF PARAMETERS
```

The system lists the SMF parameters specified at system installation time and issues the following message:

```
* id IEE357A REPLY WITH SMF VALUES OR U
```

```
R id, {U }
      {options}
```

Respond to message IEE357A by specifying that you do not want to change the SMF values (U) or by specifying the options separated by commas as provided by your system programmer. A description of these parameters can be found in *z/OS MVS System Management Facilities (SMF)*.

If PROMPT (IPLR or ALL) is specified, the system issues message IEE956A when an IPL occurs. This message prompts you to reply with the time the failure occurred, the name of the operator, and the reason for the IPL.

Once specification of system options is complete, JES2 or JES3 is automatically invoked if your installation has provided for that capability.

Specifying system parameters

During system initialization, you receive the following message:

```
IEA101A SPECIFY SYSTEM PARAMETERS FOR RELEASE xx.yy.zzz
```

where xx is the release number, yy is the release level, and zzz is the system type.

You must reply to this message with the REPLY command. The short form reply is valid. You can accept the default system parameters by using the following form of the REPLY command with the 'U' operand. However, if your system programmer has given you parameters to enter, use the following form of the REPLY command to enter them.

```
R [0|00],{U
      {
      {'parm=','                               }[,CONT] }
      {'parm=,parm,'                             }           }
      {'parm=value'                               }           }
      {'parm=(value[,value]...[,L])'              }           }
      {'parm=(value[,value]...[,L]),parm=value'} }
}
```

The parameters are:

- 00** The identification number (00) as specified in the message requesting information. A single zero can be used.
- U** No parameters are to be changed. The system uses the default list of system parameters in the parmlib data set.

'parm=,'

The parameter, as specified in the parmlib data set, is to be canceled for this IPL. If a system default exists for this parameter, it is used.

'parm=,parm,'

The parameters, as specified in the parmlib data set, are to be canceled for this IPL. If system defaults exist for these parameters, they are used.

'parm=value'

'parm=(value[,value]...[,L])'

'parm=(value,value), parm=value'

The specified parameters are to override the corresponding parameters in the parmlib data set. When specifying system parameters, (1) A blank or comma must separate multiple parameters and (2) U is not a valid value for a parameter. The reply can be at most 80 characters per line. If the reply is longer than one line, follow the last parameter with a comma or a blank and CONT. The system prompts you for the remaining values.

Example:

```
R 00,'MLPA=(00,01,02,CONT'
IEA116A CONTINUE SYSTEM PARAMETERS
R 00,'03,L),BLDL=02'
```

- L** List the parameters as they are processed.

If you are uncertain of the format of a system parameter, see *z/OS MVS Initialization and Tuning Reference* or ask your system programmer.

RESET command

Use the RESET command to:

- Change the service class of work currently in execution.
- Quiesce a problem job or address space.
- Resume a quiesced job or address space.
- Force a subsystem console to be inactive.
- Release the console name ENQ for an inactive EMCS console.
- Force an MCS, HMCS or SMCS console out of standby mode and into the offline state, which allows the console to be removed by the SETCON DELETE command. See *z/OS MVS Planning: Operations* for IEARELCN details.
- Release storage associated with messages sent to the system console (SYSCONS).

Note: All of these RESET tasks, except for the console-oriented tasks, cause SMF to create an SMF 90 subtype 30 record to log the reset operation.

Table 41 summarizes the functions that the RESET command provides.

Table 41. Summary of the RESET Command

Command:	Topic:
RESET CN	"Forcing a hung console offline or freeing console resources"
RESET <i>jobname</i>	"Changing service classes or quiescing work" on page 604

Scope in a sysplex

The RESET command has sysplex scope only when you specify the CN parameter. See "Using commands that have sysplex scope" on page 12 for an explanation of sysplex scope.

Issue the command from the system where the console was attached to avoid inconsistent sysplex results.

Syntax

The syntax for each variation of the RESET command is shown immediately preceding its respective parameter list.

```
RESET or E
```

Forcing a hung console offline or freeing console resources

There are two forms of the RESET command. Use the following form to force a hung MCS, HMCS or SMCS console into the offline state.

```
RESET|E [CN(consname)]
```

CN(*consname*)

Specifies the hung MCS, HMCS or SMCS console device that the system is to force into the offline state. The console name can be 2 to 8 characters in length.

RESET command

After issuing the RESET CN command, you might need to vary the console between the offline state and the console state to complete device recovery. Issue this command only after exhausting all other means of console recovery such as:

- Verifying the physical path to the device
- Verifying the control unit the device is attached to
- If the device is attached to a channel extender, verifying that the channel extender is in working order
- Issuing a VARY OFFLINE command that fails

For SMCS consoles you should issue a VARY NET,INACT,ID=*consolelu* command. If the console is not deactivated, try a VARY NET,INACT,ID=*consolelu*,I command. If that is not successful, try a VARY NET,INACT,ID=*consolelu*,F command.

Resetting a console might take up to 30 seconds to complete. If it is taking a long time to process the command, the system may issue this message: IEE059I RESET CN(*consname*) COMMAND IN PROGRESS, to indicate that the command is in progress but cannot complete quickly. The system will issue this message: IEE712I RESET PROCESSING COMPLETE, after the command finally completes.

Note: The discussion about forcing consoles offline only applies to MCS, HMCS and SMCS consoles. The situation differs when you use RESET CN for subsystem or EMCS consoles:

For subsystem consoles, the RESET CN command marks the console as being unused *without* notifying the application that might have allocated the console. Therefore, only use RESET CN for subsystem consoles when you have to take the console away from the application or know that the application is no longer active.

For EMCS consoles, the RESET CN command can only be used if the console is inactive. The command cleans up any ENQ resources associated with the console that might have been left outstanding.

For the system console (SYSCONS), the RESET CN command releases storage associated with the messages that have been presented on the system console. Having the system console in PD mode for long periods of time can cause this amount of storage to grow large and CP utilization by the console address space to increase. Using the RESET CN command releases the storage but *may cause messages that are displayed on the system console to never be automatically deleted (DOMed) by the system*. Operator action at the system console will be needed to manually remove those messages.

Changing service classes or quiescing work

Use the RESET command to:

- Change the service class of work currently in execution, with the SRVCLASS keyword. Resetting to a new service class also resumes quiesced work.
- Quiesce work currently in execution, with the QUIESCE keyword.
- Reclassify work currently in execution according to the service policy in effect, with the RESUME keyword. If there had been a prior quiesce you can specify a quiesced piece of work and the RESUME keyword to reclassify the work and resume processing.

The RESET command causes SMF to create an SMF 90 subtype 30 record to log the reset operation.

Use this command only at the direction of the system programmer.

The syntax for this form of the RESET command is:

```
RESET|E jobname [,A=asid],
                               {SRVCLASS=classname}
                               {QUIESCE|Q      }
                               {RESUME         }
```

jobname

The name of the job, time-sharing user, or started task whose performance characteristics you want to change. This command affects the current job step and all subsequent job steps in this execution.

A=*asid*

The hexadecimal address space identifier (ASID) of the job, time-sharing user, or started task you want to change. You can specify this keyword before or after the SVRCLASS, QUIESCE, or RESUME parameters.

This parameter is required if there is more than one job with the same job name.

SVRCLASS=*classname*

The name of the service class to be assigned to the job or address space. Resetting to a new service class also resumes quiesced work.

When you issue a RESET against a server (for example, an address space) to a new service class, the goals associated with that service class are ignored. However, the resource group associated with the new service class is honored. The one exception is the case where the goal for a server is honored when the transactions it is serving have been assigned a discretionary goal.

There may be special circumstances under which you would wish to reset an address space with a SYSTEM or SYSSTC service class. See the "Defining Classification Rules" topic in *z/OS MVS Planning: Workload Management* for information about the use of the SYSTEM and SYSSTC service classes.

RESET SVRCLASS will remain in effect until one of the following events occurs:

- The job ends.
- The policy is switched to a new policy in which the target service class has been deleted.
- A RESET RESUME command is issued.

QUIESCE|Q

Requests that the target job or address space be quiesced; that is, given the lowest possible performance characteristics. QUIESCE swaps out swappable work, effectively shutting off that work. QUIESCE just lowers the performance of non-swappable work, leaving it swapped in.

RESET QUIESCE will remain in effect until one of the following events occurs:

- The job ends.
- A RESET RESUME command is issued.

RESUME

Specifies that a job or address space be reclassified. If the job or address space was quiesced by a previous RESET *jobname*, QUIESCE command, or if the job or address space was assigned to a different service class, RESUME causes the work to be reclassified according to the service policy in effect and resumes processing at the performance targets specified in the service policy.

RESET command

The classification rules used are those in effect at the time the RESET command is issued.

Examples

Example 1: To assign the performance goals associated with service class QUICK to job BEEMER, enter:

```
e beemer,srvclass=quick
```

Example 2: To assign the lowest system performance goals to job MARCUS, enter:

```
e marcus,quiesce
```

Example 3: To resume execution of job MARCUS in the service class specified by the active service policy (after a previous QUIESCE request) enter:

```
e marcus,resume
```

Example 4: To reclassify a job according to the service policy in effect, enter:

```
e beemer,resume
```

Once this is done, job BEEMER no longer has the service class QUICK as previously assigned in Example 3.

Restrictions

- The MASTER address space, idle INIT / ASCHINT initiator address spaces, and the WLM address space may not be reset.
- There are no restrictions for the RESET command when the originating and target service classes are both customer-defined.
- Attempts to move a privileged or high dispatching priority address space into a customer-defined service class are rejected with message, IRA702I RESET NOT VALID.
- With APAR OA12625 installed, attempts to move a privileged address space into a customer-defined service class are allowed and no longer rejected with message IRA702I.
- RESET *can* be used to move eligible address spaces (not just started tasks) from a customer-defined service class to the SYSSTC service class. If the address space originally was privileged, the privileged attribute is restored.
- RESET *can* be used to move started tasks eligible for high dispatching priority into the SYSTEM service class. The high dispatching attribute is restored when the started task is moved into SYSTEM.

ROUTE command

Use the ROUTE command to direct a command to one or more systems in a sysplex for processing. You can direct a command to:

- All systems in the sysplex
- A subset of the systems in the sysplex
- One system in the sysplex.

You can enter this command from any MCS, HMCS, SMCS or extended MCS console with INFO authority.

You can enter most system commands using the ROUTE command, including MVS, JES2, JES3, and other commands.

For most system commands routed to multiple systems, the system combines the command responses into an aggregated response. The combined response sorts the command responses by system name. For more information, see "How MVS displays aggregated response from ROUTE" on page 608.

You cannot send more than one command on a single invocation of the ROUTE command. If you need to route multiple commands in strict sequential order, you should route one command, wait for successful response from all systems to which you routed the command, and then route the next command.

Restrictions

The following restrictions apply to this command:

1. When you specify *ALL or *sysgrpname* on the ROUTE command, do not also specify the following commands on that ROUTE command:
 - A ROUTE command itself
 - Commands that display or change an MCS, HMCS or SMCS console's attributes, such as:
 - D PFK
 - K A
 - K C
 - K D
 - K E
 - K N
 - K Q
 - K S
 - K V,USE
 - Commands that specify "*", where "*" means the console issuing the command, such as:
 - D C,*
 - V CN(*),ACTIVATE
 - The DUMP command.

Note: Instead of specifying the DUMP command on the ROUTE command, you can request a remote dump, which does not use the ROUTE command. See the DUMP command and the associated REMOTE REPLY option.
 - Commands that display an excessive amount of data, such as:
 - D U,,,100,999
 - Commands that are sysplex-wide in scope. For example, the following command would show identical data for each system in the sysplex:
 - D XCF
2. Do not issue ROUTE commands to multiple systems at a sysplex rate that exceeds the rate indicated by the ROUTTIME value. For example, if the ROUTTIME is the default 30 seconds, issuing ROUTEs to multiple systems in the sysplex at a rate faster than 1 per half-minute could lead to resource contention and delays in processing the commands.
3. Do not use the L keyword abbreviation with the ROUTE command when other commands you are routing contain an L keyword abbreviation.
4. If your ROUTE command has the keyword parameter "L=", the result may not be what you want. The first "L=" will be interpreted as a parameter on ROUTE, not on the ROUTEd command.

How MVS displays aggregated response from ROUTE

When you route a command to multiple systems, command responses are returned to the issuing console as part of message IEE421I.

If an out-of-line display area exists on the issuing console, IEE421I is written to the out-of-line display area.

If the L= parameter is specified on a ROUTE *ALL or ROUTE *sysgrpname* command, the aggregated response will be redirected as specified by the L= parameter.

Note: Do not use system symbols on the L= parameter when aggregating command responses.

MVS returns an aggregated response when one of the following occurs:

- MVS has received at least one response from all systems and a period of time has elapsed during which it has received no additional responses. MVS calculates this period of time based on the pattern of responses received for the command.
- The maximum timeout interval in effect for the ROUTE command is reached.

For command responses to be aggregated, the maximum timeout interval that is in effect for the ROUTE command cannot be zero. The maximum timeout interval in effect for a ROUTE command is determined as follows:

1. The current sysplex-wide default, which is determined as follows:
 - a. The IBM-defined default for the maximum timeout interval is 30 seconds. This can be changed by any of the following conditions.
 - b. An installation-defined default for the maximum timeout interval can be specified in the CONSOLxx parmlib member of the first system to join the sysplex. (This is specified on the ROUTTIME keyword of the INIT statement.) This installation-defined default applies to all other systems joining the sysplex.
 - c. The operator can dynamically change the default maximum timeout interval for all systems in the sysplex by issuing the CONTROL M,ROUTIME= command.
2. When entering the ROUTE command, the operator can specify the maximum timeout interval in effect for that one time by specifying the T= operand on the ROUTE command itself.

For a specific command response to appear in the aggregated response, individual responses to the routed command must meet these criteria:

- The command processor for the routed command must direct command response(s) to the console ID where the command originated.
If, when issuing a command response, a command processor does not use the console ID of the command issuer, MVS cannot return the command responses to the ROUTE command issuer.
- The specific command response must be received at the originating system before the originating system stops aggregating responses.

Command responses that do not meet the stated criteria are not aggregated. However, if MVS receives command responses after the timeout period, MVS attempts to return the responses to the originator of the ROUTE command.

Using system symbols in ROUTE commands

You can specify system symbols in commands that are routed to one or more systems in a sysplex. This section explains special considerations for using system symbols in routed commands. Before you read this section, see “Sharing system commands” on page 15 for information about how to use system symbols in commands and lists of system symbols that the system provides.

When you enter a ROUTE command, the system views the command in two parts:

- The actual ROUTE command, which indicates where and how the command is to be routed. The system on which the ROUTE command is entered processes the system symbols in this part of the command.
- The command that is to be processed on one or more other systems. The system to which the command is routed processes the system symbols in this part of the command.

Because several systems can be involved in processing a ROUTE command, **IBM recommends that you enter a DISPLAY SYMBOLS command on each system that is to process parts of the ROUTE command containing system symbols.**

DISPLAY SYMBOLS shows the current static system symbols and their associated substitution texts. See the description of the DISPLAY SYMBOLS command for more information.

For example, suppose that the following values are defined for system symbols on systems SYS1 and SYS2:

System	System Symbol	Value
SYS1	&T1	999
SYS1	&SYSNAME2	SYS2
SYS1	&SYSCLONE	S1
SYS2	&T1	0
SYS2	&SYSNAME	SYS2
SYS2	&SYSCLONE	S2

Then suppose you enter the following ROUTE command on system SYS1:

```
RO T=&T1,&SYSNAME2,F JOB&SYSCLONE,parameters
```

```
-----  
Processed by SYS1    Processed by SYS2
```

The systems process the command in the following way:

1. The system on which the ROUTE command is entered, SYS1, substitutes text for the &T1 and &SYSNAME2 system symbols in the first part of the command.
2. The system to which the command is to be routed, SYS2, substitutes text for the &SYSCLONE system symbol in the second part of the command.

The result of the substitution is:

```
RO T=999,SYS2,F JOBS2,parameters
```

If a system group had been specified in place of a system name in the ROUTE command, the MODIFY command would have been routed to all systems in that

ROUTE command

group. Each system would have substituted text for system symbols in the instance of the command that was routed to that system.

Syntax

The complete syntax for the ROUTE command is:

```
RO {sysname,text }
   {[T=nnn,]*ALL text } [,L={a }]] }
   {sysgrpname } {name }
   {*OTHER } {name-a}
   {(sysname[,sysgrpname,sysname...])}
```

Parameters

sysname

The system name (1 to 8 characters) that will receive and process the command.

MVS returns the command response to the issuing console (inline area for an MCS, HMCS or SMCS console) unless redirected by the L= parameter on the routed command.

text

The system command and specific operands of the command being routed. Do not code any leading blanks before the text.

T= Specifies an optional timeout interval. T= is valid with *ALL, *OTHER, *sysgrpname*, or a list of system names or *sysgrpnames*. You can specify a value from 0 to 999. This value indicates the maximum number of seconds MVS waits for responses from each system before aggregating the responses.

If you specify T=0, MVS does not aggregate command responses, but individually sends responses to the originator.

Note:

1. IBM recommends that you specify T=0 when you are routing the START and STOP commands to multiple systems. This is because the system does not collect aggregate responses for routed START and STOP commands. If you attempt to do so (if T= is nonzero), the system states that there is "no response" from all of the systems, and all the START and STOP command responses are displayed inline.
2. IBM does not recommend that you specify T=0 for most DISPLAY commands. Command responses from most DISPLAY commands appear in an out-of-line display area, and the responses from multiple DISPLAY commands can be written into the same area one right after the other, so that only the last one is readable. If there is no display area defined, or if L=Z is used, the responses are inline, but will probably roll off the console. Responses from ROUTE with T=0 and a DISPLAY command specified could be useful to an automation program and as a hardcopy record, but not for a human operator.

***ALL**

Specifies that the command is to be routed to all systems in the sysplex.

***OTHER**

Specifies that the command is to be routed to all systems in a sysplex *except* the system on which the command is entered.

If you enter a ROUTE *OTHER command on a system that is not a member of a sysplex, or if you enter ROUTE *OTHER from a system that is a member of a sysplex in which no other systems are active, MVS issues message IEE413I.

sysgrpname

Specifies that the command will be routed to a subset of systems in the sysplex. The *sysgrpname* can be 1 to 8 characters and represents the set of systems to which the command is to be routed. System group names are defined by the installation. For information on defining system group names, see *z/OS MVS Planning: Operations*.

(sysname[, sysgrpname, sysname...])

Specifies that the command is to be routed to a list of systems or system groups, or both. System group names are defined by your installation.

If you route a command to a list of systems or system groups, and *none* of the systems or system groups is active, the system issues message IEE413I.

L=a, name, or name-a

Specifies the display area (*a*), console name (*name*), or both (*name-a*) where the display will appear.

For the ROUTE command, you can specify the L= operand as follows:

- When routing a command to only one system, you can specify the L= operand only if supported by the routed command. For example, the following is valid because the D C command supports the L= operand:

```
R0 sys1,D C,L=con1
```

The following is not valid because the D T command does not support the L= operand:

```
R0 sys1,D T,L=con1
```

- When routing a command to all systems, or to a named subset of systems, the L= operand is supported if aggregation of responses occurs (the timeout interval is not zero). For example, the following is valid:

```
R0 T=20,*ALL,D T,L=con1
```

If you do not specify the L= option, the system displays the command responses in the first available display or message area of the console on which you entered the ROUTE command.

Note: Do not use system symbols on the L= parameter when aggregating command responses. For more information about specifying system symbols when routing commands, see “Using system symbols in ROUTE commands” on page 609.

Example 1:

To route a DISPLAY UNITS command for device 320 on system SY4 and have the response returned to the issuing console, enter:

```
ROUTE SY4,D U,,,320,1
```

Example 2:

To route a DISPLAY UNITS command to system SY1 and have the response returned to the console named CON1A, enter:

ROUTE command

```
ROUTE SY1,D U,L=CON1A
```

Example 3:

To change the OPNOTIFY value on all systems in the sysplex, enter:

```
ROUTE *ALL,SETXCF COUPLE,OPNOTIFY=15
```

Example 4:

To start JES2 on all systems in the sysplex, enter:

```
ROUTE T=0,*ALL,S JES2
```

Note: The system does not aggregate command responses for routed START and STOP commands. If you attempt to do so (if T= is nonzero), the system states that there is “no response” from all of the systems, and all the START and STOP command responses are displayed inline.

Example 5:

After JES3 initialization completes on the global, to start JES3 on all local processors in the sysplex, from a console associated with the global, enter:

```
ROUTE T=0,*OTHER,S JES3
```

Note: The system does not aggregate command responses for routed START and STOP commands. If you attempt to do so (if T= is nonzero), the system states that there is “no response” from all of the systems, and all the START and STOP command responses are displayed inline.

Example 6:

To issue D A on system SY1 and system SY4, where TEST is a system group name representing both system SY1 and system SY4, enter:

```
ROUTE TEST,D A
```

Example 7:

To issue D A on the systems represented by TEST and have the aggregated responses received within 10 seconds, enter:

```
ROUTE T=10,TEST,D A
```

Example 8:

To issue D T (DISPLAY TIME) to be processed on system SYS1, enter:

```
ROUTE SYS1,D T
```

The system returns this information:

```
SYS1 IEE136I LOCAL: TIME=09.59.49 DATE=1993.257 GMT: TIME=13.59.43  
DATE=1993.257
```

Example 9:

To route the command D T (DISPLAY TIME) to be processed on all systems (SYS1, SYS2, and SYS3), enter:

```
ROUTE T=0,*ALL,D T
```

The system returns the following information:

```
SYS1 IEE136I LOCAL: TIME=10.00.59 DATE=1993.257 GMT: TIME=14.00.59
      DATE=1993.257
SYS3 IEE136I LOCAL: TIME=10.00.59 DATE=1993.257 GMT: TIME=14.00.59
      DATE=1993.257
SYS2 IEE136I LOCAL: TIME=10.00.59 DATE=1993.257 GMT: TIME=14.00.59
      DATE=1993.257
```

Note:

1. Because T=0 is specified, the information is not aggregated, but individually returned.
2. Most DISPLAY commands produce multi-line command responses in an out-of-line display area on the console. Such command responses are written into the same area. IBM does not recommend specifying such DISPLAY commands on the ROUTE command when T=0 is in effect. However, because the D T (DISPLAY TIME) command produces a single-line command response, you can successfully specify the D T command on the ROUTE command, as shown in this example.

Example 10:

To route the command D T (DISPLAY TIME) to all systems and receive an aggregated response, use the T= parameter and enter:

```
ROUTE T=5,*ALL,D T
```

The system returns the following **aggregated** information:

```
IEE421I RO *ALL,D T                               FRAME LAST F     E   SYS=SYS1
SYSNAME  RESPONSES -----
SYS1     IEE136I LOCAL: TIME=10.06.48 DATE=1993.257 GMT:
          TIME=14.06.48 DATE=1993.257
SYS2     IEE136I LOCAL: TIME=10.06.48 DATE=1993.257 GMT:
          TIME=14.06.48 DATE=1993.257
SYS3     IEE136I LOCAL: TIME=10.06.48 DATE=1993.257 GMT:
          TIME=14.06.48 DATE=1993.257
```

Example 11:

This example illustrates what can happen when the timeout interval occurs before all the command responses are received for aggregation. If you issue the ROUTE command to vary device 414 offline on all systems:

```
ROUTE T=1,*ALL,V 414,OFFLINE
```

and system SYS2 does not respond within one second (the timeout interval) MVS cannot include the command response from SYS2 with the other command responses.

- First, MVS lists the systems from which no response was received in time for aggregation.

```
IEE421I RO *ALL,V 414,OFFLINE
NO RESPONSE RECEIVED FROM THE FOLLOWING SYSTEM(S):
SYS2
```

- After the operator scrolls forward to the second frame of message IEE421I, MVS displays the aggregated response:

```
IEE421I RO *ALL,V 414,OFFLINE
SYSNAME  RESPONSES -----
SYS1     IEF281I 0414 NOW OFFLINE
SYS3     IEE303I 0414   OFFLINE
```

ROUTE command

Example 12:

Route the \$SPRT1 command to all systems in a sysplex except the system on which the command is entered:

```
ROUTE *OTHER,$SPRT1
```

Example 13:

Quiesce systems S0 and S9 from system S1:

```
RO (S0,S9),QUIESCE
```

Example 14:

Quiesce systems S0 and the subset of systems represented by system group name G8:

```
RO (S0,G8),QUIESCE
```

If the ROUTE *OTHER command is issued on a system which is not a member of a SYSPLEX, or a system that is a member of a sysplex but no other systems are active members in the sysplex, a message is issued (see messages section for details). This same message will be issued if a list of systems/groups is specified and none of the systems/groups represent at least one active system.

SEND command

Use the SEND command to communicate with other operators in a multiple-console support (MCS), HMC multiple-console support (HMCS) or SNA multiple-console support (SMCS) environment. In a time-sharing environment, use the SEND command to communicate with a specific terminal user or all terminal users, and to manage the SYS1.BROADCAST data set. Table 42 summarizes the information that the SEND command provides. Use it to find details about a particular use of the SEND command.

Table 42. Summary of the SEND Command

Command:	Topic:
SEND ...,BRDCST SEND ...,OPERATOR=... SEND ...,CN=...	"Communicating with other operators" on page 615
SEND ...,USER=...	"Communicating with specified users" on page 616
SEND ...,LOGON SEND ...,NOW	"Communicating with all logged-on terminal users" on page 617
SEND ...,SAVE	"Saving messages in the broadcast data set" on page 618
SEND ...,LIST	"Listing the notices section of the broadcast data set" on page 619
SEND ...,DELETE	"Deleting a message from the broadcast data set (notices section)" on page 620

Scope in a sysplex

The SEND command has sysplex scope only when sending to consoles; SEND does not have sysplex scope when sending to TSO users. See "Using commands that have sysplex scope" on page 12 for an explanation of sysplex scope.

Syntax

The syntax for each variation of the SEND command is shown immediately preceding its respective parameter list.

```
SEND or SE
```

Communicating with other operators

Use the SEND command to communicate with other operators at MCS, HMCS and SMCS consoles.

```
SE {'message'}, {BRDCST          }
  {msgno   } {OPERATOR=routecode }
             {CN=consname|INTERNAL}
```

The parameters are:

'message'

The message to be sent.

msgno

The number of the message in SYS1.BROADCAST to be sent. (See "Saving messages in the broadcast data set" on page 618 for information on how to save and later send messages by message number.)

BRDCST

The specified message is to be sent to all active consoles that have not specified the 'no broadcast' option (using the K V,LEVEL command).

OPERATOR=routecode

The installation area (such as tape library) to receive the message, specified as a one or three digit number between 1 and 128 (see Table 12 on page 139).

CN=consname or INTERNAL

The console to receive the message.

consname

Specifies the name of the console where the message is to be sent. The console name is 2 to 8 alphanumeric characters; the first character must be alphabetic or one of the following characters: \$, #, or @.

INTERNAL

Specifies that the message is to be directed to console ID 0, and to be received by any active console defined to receive these messages (INTIDS=Y).

When you are uncertain of the routing codes and console identifiers in effect, enter the DISPLAY CONSOLES command. See "Displaying console status information" on page 282.

Example 1:

To send message number 46 to the console named CON12, enter:
se 46,cn=CON12

Example 2:

SEND command

To send the following message to all active consoles, enter:

```
se 'Close down in 15 minutes',brdcst
```

Communicating with specified users

Use the SEND...,USER command to communicate with specific time-sharing users.

```
SE {'message'},USER=(userid[,userid]...),{NOW|LOGON},{WAIT|NOWAIT}  
  {msgno }
```

The parameters are:

'message'

The message to be sent to the terminal users.

msgno

The number of the message to be sent. (See "Saving messages in the broadcast data set" on page 618. for information about how messages can be saved and later sent by message number.)

USER=(userid[,userid]...)

The identifiers of those users who are to receive the message.

NOW

Specifies that the message is to be sent immediately. If the recipient is not logged on, you are notified and the message is deleted.

When NOWAIT and USER are specified and the user's terminal is busy:

- The user does not receive the message
- You are notified which users did not receive the message
- The message is deleted

LOGON

If any specified user is currently logged on and is accepting messages, the user receives the message. If the user is logged on but is not receiving messages, the message is stored in the mail section of the broadcast data set until the user requests it. If the user is not logged on, the message is stored in the mail section of the broadcast data set until requested when the user logs on.

When NOWAIT is specified and the user's terminal is busy, the message is stored in the mail section of the broadcast data set until the user requests it.

WAIT

Specifies that the message is held until system output buffers are available for the specified logged on users. This option ensures that the message is received by all the specified users. When a user's terminal is busy, other users will not receive the message until that user's terminal is free.

NOWAIT

Specifies that the message is **not** held. When USER is specified, you are notified of any users who do not received the message. If LOGON is specified, the message is saved as mail for those user's who's terminal is busy or who were not logged on.

Note: When possible, use the LOGON parameter so you do not interrupt the user's terminal session unnecessarily.

Example 1:

To send the following message to users D58 and D04 immediately, if they are receiving messages, or when they request messages, enter:

```
se 'your listings are ready',user=(d58,d04),logon
```

If they are not logged on the system, they receive the message when they log on.

Example 2:

To send the message to the specified user immediately, if he is logged on, enter:

```
se 'getting I/O errors on your pack',user=(payroll)
```

Communicating with all logged-on terminal users

You can use the SEND command to send a message to all terminal users currently logged on the system.

```
SE { 'message' }, { NOW | LOGON }, { WAIT | NOWAIT }, { ROUTE={ *ALL | systemname | groupname } }
{msgno }
```

The parameters are:

'message'

The message that is to be sent to all time-sharing terminal users.

msgno

The number of the message to be sent. (See "Saving messages in the broadcast data set" on page 618 for information about how to save and later send messages by message number.)

NOW

Specifies that the message is to be sent immediately to all users currently logged on; the message is not retained for users not logged on.

When NOWAIT is specified and the user's terminal is busy:

- the user does not receive the message
- you are NOT notified which users did not receive the message
- The message is deleted

LOGON

All users logged on and accepting messages receive the message. Those users logged on but not receiving messages receive it upon requesting messages. The message is stored in the notices section of the broadcast data set and is sent to those users requesting messages when they log on. The message is retained until you delete it.

When NOWAIT is specified and the user's terminal is busy, the message is stored in the mail section of the broadcast data set until the user requests it.

WAIT

Specifies that the message is held until system output buffers are available for the specified logged on users. This option ensures that the message is received by all the specified users. When a user's terminal is busy, other users will not receive the message until that user's terminal is free.

SEND command

NOWAIT

Specifies that the message **not** be held. If you specify LOGON, the system saves the message as mail for those users whose terminals are busy or who were not logged on.

ROUTE

Sends the message to all users logged onto the specified system(s). If you do not specify the ROUTE= parameter, the system sends the message only to the users logged onto the system where you issue the SEND command. Valid values for the ROUTE parameter are:

*ALL

Directs the system to send the message to all users logged onto all systems participating in the sysplex

systemname

Directs the system to send the message only to users logged onto *systemname*

groupname

Directs the system to send the message to all users logged onto the sysplex subset defined by *groupname*

Note: When possible, use the LOGON parameter so you do not interrupt the users' terminal sessions unnecessarily.

Example 1:

To send the following critical message to all users immediately, enter:

```
SE 'system going down in 5 minutes'
```

Example 2:

To send the following general interest message to users when they request messages or at LOGON time, enter:

```
SE 'time-sharing will not be up next Thursday',LOGON
```

Saving messages in the broadcast data set

Use the SEND...,SAVE command to store messages in the broadcast data set to be issued only at LOGON time, or when requested.

```
SE {'message'},{USER=(userid[,userid]...)},SAVE  
  { msgno   } {ALL }
```

The parameters are:

'message'

The message to be sent to the terminal users.

msgno

The number of the message to be sent.

USER(userid)

The identifications of those users to receive the message. The message is stored in the mail sections for those users. (There is a mail section for each TSO user.)

ALL

All terminal users are to receive the message. Terminal users who are currently using the system receive the message immediately. In addition, the message is placed in the notices section and assigned a number. This number, printed when the message is stored, can be used as *msgno* in this and other forms of the SEND command.

SAVE

The message is to be stored in the appropriate section of the broadcast data set until a user logs on or requests messages. If ALL is specified, the message is stored in the notices section of the broadcast data set and is retained until explicitly deleted. If *userid* is specified, the message is stored in the mail section of the broadcast data set and deleted after it is sent to the intended user. No attempt is made to send it immediately, even to those users logged on and receiving messages.

Note: WAIT and NOWAIT have no effect when specified with SAVE.

Example:

To submit messages to the broadcast data set before stopping time-sharing for the day, enter:

```
se 'time-sharing will close down at 5:00 p.m. today.',save
```

When you start timesharing the next day, the messages are available for users logging on. This command does not affect those users currently logged on and receiving messages.

Listing the notices section of the broadcast data set

Use the SEND...,LIST command to keep track of accumulated messages in the notices section of the broadcast data set. You can list one or all of the messages.

```
SE [msgno,]LIST
```

The parameters are:

msgno

The number of the message to list. Omitting this operand results in all messages in the notices section, and the message numbers assigned to them, being listed.

LIST

The requested message or all messages in the notices section of the SYS1.BROADCAST data set are to be listed on the console.

Example 1:

To list all messages in the notices section of the SYS1.BROADCAST data set, enter:

```
SE LIST
```

Example 2:

To list message number 21, enter:

```
SEND 21,LIST
```

Deleting a message from the broadcast data set (notices section)

If you find, after listing the notices section of the broadcast data set, that a message is no longer needed, use the SEND...,DELETE command to delete it.

```
SE msgno,DELETE
```

The parameters are:

msgno

The number of the message to be deleted.

DELETE

The specified message is to be deleted.

Example: To delete message number 23, enter:

```
SE 23,DELETE
```

SET command

Use the SET command to change the local date, time, and the local time offset value.

Also use the SET command to change the system configuration by specifying the following parmlib members:

- ADYSETxx: Change the dump analysis and elimination (DAE) parameters.
- APPCPMxx: Change the Advanced Program-to-Program Communication/MVS (APPC/MVS) address space information.
- ASCHPMxx: Change the APPC/MVS Transaction Scheduler information.
- AUTORxx: Change the auto-reply processing settings on a system.
- BPXPRMxx: Dynamically change the BPXPRMxx parmlib members in use.
- CEEPRMxx: Change the system level Language Environment run-time options.
- CNGRPxx: Change the active console group definitions in the sysplex.
- CONSOLxx: Change the environment's console configuration.

Note: Specifying SET CON= on the same command with CNGRP=, MMS=, MPF= or MSGFLD= can have unpredictable results.

Note: This command is only processed when running in the distributed mode of console operation. For more information, see the operation modes of console support section in *z/OS MVS Planning: Operations*

- CUNUNIxx: Change the conversion environment when the system is already up and running.
- DEVSUPxx: Dynamically change keyword values in parmlib member DEVSUPxx.
- DIAGxx: Start or stop the common storage tracking and GETMAIN/FREEMAIN/STORAGE trace functions.
- EXSPATxx:
 - Change the excessive spin recovery actions.

- Change the spin loop timeout interval.
- GRSRNLxx: Change the GRS resource name lists (RNLs).
- GTZPRMxx: Change the Generic Tracker (GTZ) parameters.
- IEAOPTxx: Change the system resources manager (SRM) parameters.
- IEASLPxx: Change the commands SLIP is to process.
- IECIOSxx:
 - Change all the MIH time intervals.
 - Change all the I/O timing limits.
 - Change the status of FICON switch statistics gathering.
 - Change the residency of where IOS storage blocks are obtained.
 - Change certain IOS recovery options.
- IEFOPZxx: Specify data set optimization configuration.
- IGDSMSxx:
 - Change the storage management subsystem (SMS) parameters, or start SMS if it was not started at IPL, or restart SMS if it could not be automatically restarted.
 - Specify the method that VSAM Record Level Sharing (RLS) uses to determine the size of the data placed in the coupling facility cache structure.
- IKJTSOxx: Dynamically specify which TSO/E parameter set should be activated.
- IQPPRMxx: Specify one or more IQPPRMxx parmlib members that contain the zEDC options.
- IXGCNFxx: Dynamically specify system logger options.
- MMSLSTxx:
 - Change or refresh the MVS message service (MMS) parameters.
 - Start, refresh, or stop MMS.
- MPFLSTxx:
 - Change messages processed by the message processing facility (MPF), or the color, intensity, highlighting, and foreign message handling options, and whether verbose messages are to be produced or not.
 - Change the command installation exits the system is to use.
- MSGFLDxx: Change the message flood automation parameters.
- PFKTABxx: Change the set of available PFK tables.
- PROGxx:
 - Update the format or contents of the APF list.
 - Control dynamic exits and exit routines.
 - Update the LNKLST set for the LNKLST concatenation.
 - Dynamically add modules to, or remove modules from the LPA.
- SCHEDxx: Change the PPT information.
- SMFLIMxx: Update the in-storage copy of the SMF limit rules with the values specified in the SMFLIMxx parmlib members.
- SMFPRMxx: Change the system management facilities (SMF) parameters or restart SMF.

Note: The system allows a maximum of 38 suffixes.

Scope in a sysplex

The following table describes the conditions under which the SET command has sysplex scope. See “Using commands that have sysplex scope” on page 12 for an explanation of sysplex scope.

Table 43. Sysplex Scope for SET Command

Command	Conditions
SET CNGRP	Has sysplex scope provided all systems are sharing the same members of the logical parmlib.
SET CON	Has sysplex scope provided all systems are sharing the same members of the logical parmlib.
SET DAE	Has sysplex scope only when all systems are sharing the same DAE data set, and the same members of the logical parmlib.
SET GRSRNL	Has sysplex scope only when all systems are sharing the same members of the logical parmlib.
SET SMS	<p>Has sysplex scope when you are issuing the command to change the name of the ACDS or COMMDS. All systems in the sysplex must be in the same SMS complex, and using the same members of the logical parmlib. If you are issuing the command to start or restart SMS on a system, only the system on which you issue the command is affected.</p> <p>RLS_MAXCFFEATURELEVEL has sysplex scope when you IPL the first system in the sysplex to set the value. All other systems will be told the current value when IPLed. You can change the value by issuing the SET SMS=xx command and specifying RLS_MAXCFFEATURELEVEL in the IGDSMSxx parmlib member, or by using the SETSMS command with the RLS_MAXCFFEATURELEVEL keyword.</p>

Syntax

The complete syntax for the SET command is:

Table 44. Syntax for the SET command

```
{SET | T} [APPC=(xx[,xx]...,L)]
[ASCH=(xx[,xx]...,L)]
[AUTOR=(xx[,xx]...)]
[CEE=(xx[,xx]...,L)]
[CLOCK=hh.mm.ss]
[CNGRP={ (xx[,xx]...) } | NO ]
[CON={xx}]
[DAE=xx]
[DATE=yyyy.ddd]
[DEVSUP=(xx[,xx...])]
[DIAG=xx]
[EXS=xx]
[GRSRNL=(xx[,xx]...)]
[GTZ=(xx[,xx]...)]
[IEFOPZ= { (xx...,xx [,C]) | REFRESH}]
[IKJTSO=xx]
[IOS=xx]
[IQP=(xx[,xx...])]
[IXGCNF=(xx[,yy...,nn])]
[MMS={xx|NO}]
[MPF={ (xx[,xx]...) | NO}]
[MSGFLD=xx]
[OMVS=(xx[,yy...,nn])]
[OPT=xx]
[PFK=xx]
[PROD=(xx[,xx]...)]
[PROG=(xx[,xx...][,C])]
[RESET]
[SCH=(xx[,xx]...,L)]
[SLIP=xx]
[SMF=xx]
[SMFLIM=(xx[,xx...][,C])]
[SMS=xx]
[TIMEZONE={W|E}.hh.mm]
[UNI=xx]
```

Note:

1. You may specify the operands in any order, and must specify at least one operand. Do not put a comma before the first operand you specify.
2. You can specify the CLOCK and DATE parameters either individually or in combination with one another. However, do not specify them with any other parameters. If both CLOCK and DATE are specified, separate the specifications with a comma.
3. You may use the SET parameters to determine which members of the logical parmlib the system is to use. Use them only at the direction of the system programmer. For more information on members of the logical parmlib, see *z/OS MVS Initialization and Tuning Guide*.
4. If you specify only one parmlib member, putting parentheses around the member is optional. If you specify more than one parmlib member, you must put parentheses around the members.

Parameters

APPC=(xx[,xx...][,L])

The two alphanumeric characters indicating the APPCPMxx parmlib member that contains the desired APPC/MVS address space configuration that is appended to the existing configuration. The APPCPMxx member can reside in a logical parmlib or if no logical parmlib is specified, in any parmlib data set specified on an //IEFPARM DD statement in the master scheduler JCL. The L is optional and causes the system to display parmlib statements on the operator console as they are processed.

ASCH=(xx[,xx...][,L])

The two alphanumeric characters indicating the ASCHPMxx parmlib member that contains the desired APPC/MVS scheduler configuration that is appended to the existing configuration. The ASCHPMxx member can reside in a logical parmlib or if no logical parmlib is specified, in any parmlib data set specified on an //IEFPARM DD statement in the master scheduler JCL. The L is optional and causes the system to display parmlib statements on the operator console as they are processed.

AUTOR=(xx[,xx...])

The two alphanumeric characters indicating that the AUTORxx parmlib member that contains auto-reply processing configuration on a system is to be activated. Multiple AUTORxx parmlib members can be concatenated together, and up to 38 members can be specified in the command. The supported values for xx are uppercase letters A through Z, numerals 0-9, or national characters including #, @ and \$.

CEE=(xx[,xx...][,L])

The two alphanumeric characters that specify one or more CEEPRMxx parmlib members. The L is optional and causes the system to display parmlib statements on the operator console as they are processed.

CLOCK=hh.mm.ss

The local time in hours (00-23), minutes (00-59), and seconds (00-59).

Note:

1. The system does not change the date when the new time implies a change of date; if you want a new date, use the DATE parameter or wait for the time to pass midnight.
2. If you specify CLOCK for day 2042.260, the last allowable date, the clock value must not exceed 23.53.47. Later values may cause unpredictable results.

CNGRP=(xx,[xx...])

The two alphanumeric characters indicating the CNGRPxx member of the logical parmlib to be activated. This data is broadcast across the sysplex. It refers to the logical parmlib only on the system where the command executes, and activates only the CNGRPxx members found in that logical parmlib.

CNGRP=NO

The system is to remove all active console group definitions from the sysplex.

CON=xx

The two alphanumeric characters indicating the CONSOLxx parmlib member that defines the installation's console configuration. The supported values for xx are uppercase letters A-Z, numerals 0-9, and national characters including #, @ and \$.

DAE=xx

The two alphanumeric characters indicating the ADYSETxx member of the logical parmlib that contains the new parameters that dump analysis and elimination (DAE) program is to use.

Note: The OPT=, SMF=, and DAE= parameters affect the jobs in progress as well as the jobs read and scheduled after the command.

DATE=yyyy.ddd

The local date, where

- *yyyy* is the year, in the range 1900-2042, and
- *ddd* is the day, in the range 001-366.

Note:

1. The most distant date in the future you may specify is 2042.260.
2. The year must be within seventy (70) years of the UTC date or the system ignores the entire SET command.
3. You must specify the year *yyyy* using four digits.
4. If you specify a new time that implies a change of date, you must explicitly specify the new local date.

DEVSUP=(xx[,xx...])

Specifies one or more DEVSUPxx members of the logical parmlib that contains the parameters the system is to use to set device related controls. Each value of *xx* is two alphanumeric characters that indicate a DEVSUPxx member.

DIAG=xx

The two alphanumeric characters indicating the DIAGxx member of the logical parmlib containing definitions that control:

- Common service area (CSA), extended CSA (ECSA), system queue area (SQA), and extended SQA (ESQA) tracking
- GETMAIN/FREEMAIN/STORAGE (GFS) trace
- Execution of traps and traces for various system functions
- Authorization for user key programs to obtain CSA
- Tolerable region loss amounts for initiator address spaces
- Location in virtual storage for certain system control blocks
- Use of reusable ASIDs
- Use of the AUTOIPL function

For a complete description of the options controlled by DIAGxx, see *z/OS MVS Initialization and Tuning Reference*.

EXS=xx

The two alphanumeric characters indicating the EXSPATxx member of the logical parmlib that contains the excessive spin recovery actions and the excessive spin loop timeout interval.

GRSRNL=(xx[,xx...])

Specifies one or more GRSRNLxx members of the logical parmlib that contain the specified GRS resource name lists. Each value of *xx* is two alphanumeric characters that indicate a GRSRNLxx member. GRSRNL enables you to change the current RNLs specified in one or more GRSRNLxx member of SYS1.PARMLIB.

Attention: Use extreme caution when issuing the SET GRSRNL command to change heavily used or highly critical resources. Work that requires resources

SET command

for a critical application, or resources used by the operating system, might become suspended or delayed, which can impair the performance of that critical application or the operating system itself.

For more information about the use of the SET GRSRNL command, see *z/OS MVS Planning: Global Resource Serialization*.

Restriction: In a GRSRNL=EXCLUDE environment, the GRSRNL= parameter cannot be specified unless in a single system STAR complex. See *z/OS MVS Planning: Global Resource Serialization* for more on migrating from GRSRNL=EXCLUDE to standard RNLs.

GTZ=(xx[,xx...])

The two alphanumeric (A-Z,0-9) or national (@,#,\$) characters that specify one or more GTZPRMxx parmlib members. GTZPRMxx members contain statements that control the Generic Tracker, typically a list of EXCLUDE statements which prevent known track events from being recorded.

IEFOPZ=parameters

IEFOPZ can be specified as follows:

IEFOPZ=(xx[,xx...])

Specifies one or more IEFOPZxx parmlib members that contain statements that define the data set optimization configuration, which could, for example, provide a list of pairings of an old Cobol library and the intended new libraries (one per desired architecture level) and specifies which members are to be processed (optimized).

The existing IEFOPZ configuration is replaced with the configuration formed from the identified IEFOPZxx members, applying the rule identified by the KeepOnError parameter. Jobs that have already started will continue with the joblib/steplib definition current when they started and, if they have a relevant DDNAME, will continue with the DDNAME definition current when that DD was allocated.

IEFOPZ=(xx[,xx...],C)

The trailing “C” notation indicates “syntax check only”. The system will check the validity of the syntax of the specified parmlib members, but will make no changes to the suffix list and will not use the provided suffix list for any subsequent IEFOPZ=REFRESH command.

IEFOPZ=REFRESH

SET IEFOPZ=REFRESH indicates that processing is to use the most recently remembered suffix list. The system remembers the suffix list from the IEFOPZ system parameter. It also remembers the suffix list from the most recent SET IEFOPZ command (without “syntax check only”) when that SET IEFOPZ command had no missing (or could-not-be-read) parmlib member and did not terminate due to some system error (with an SVC dump) and either had KeepOnError(VAID) or had KeepOnError(NONE) and there were no errors detected.

IKJTSO=xx

The two alphanumeric characters indicating the IKJTSOxx parmlib member to be activated. This command will perform processing similar to the TSO/E PARMLIB UPDATE command. A switch will be attempted when a broadcast data set that is different from the one currently being used is specified in the IKJTSOxx parmlib member. If the IKJTSOxx parmlib member specifies a new broadcast data set, operator confirmation of the switch will be required unless NOPROMPT is specified in the parmlib member.

IOS=xx

The two alphanumeric characters indicating the IECIOSxx member of the logical parmlib that contains the parameters the system is to use to control MIH processing, I/O timing processing, and other IOS functions.

You can change the MIH timing intervals, or the I/O timing intervals, or the MIH timing intervals and the I/O timing intervals ONLY for devices that have MIH statements coded in IECIOSxx.

Note:

1. IECIOSxx can also contain parameters that control hot I/O processing. Using SET IOS=xx to change to another member does not affect the hot I/O parameters; hot I/O processing is unchanged. You can only change hot I/O processing parameters at system initialization time in response to message IEA101A.
2. During IPL (if the device is defined to be ONLINE), or during the VARY ONLINE process, some devices present their own MIH timeout values through the primary/secondary MIH timing enhancement contained in the self-describing data for the device. The primary MIH timeout value is used for most I/O commands. However, the secondary MIH timeout value can be used for special operations such as long-busy conditions or long-running I/O operations. Any time a user specifically sets a device or device class to have an MIH timeout value that is different from the IBM-supplied default for the device class, the user-specified value overrides the device-established primary MIH time value. This implies that if an MIH time value that is equal to the MIH default for the device class is explicitly requested, IOS does NOT override the device-established primary MIH time value. To override the device-established primary MIH time value, you must explicitly set aside a time value that is not equal to the MIH default for the device class.

Overriding the device-supplied primary MIH timeout value can adversely affect MIH recovery processing for the device or device class.

See the specific device's reference documentation to determine if the device supports self-describing MIH time values.

IQP=(xx[,xx...])

The two alphanumeric (A-Z,0-9) or national (@,#,\$) characters that specify one or more IQPPRMxx parmlib members. IQPPRMxx members define parameters for managing PCIE-related devices, such as the zEDC Express feature.

IXGCNF=(xx[,xx...,nn])

The two alphanumeric characters that specify one or more IXGCNFxx parmlib members that control system logger options on the system.

You can specify one or more current IXGCNFxx parmlib members. For example, a SET IXGCNF=(01,02) specification informs the system to use IXGCNF01 and IXGCNF02 as current members. The system processes these members in the order they are specified. For all options, the last parmlib member specifying the option is honored. If an error is encountered, command processing stops. Note, the L (list) option is syntactically allowed but ignored.

Before changing options with SET IXGCNF=xx, consider issuing a D LOGGER,IXGCNF command to see what options are currently in effect. Combine the displayed options with any new request that shares the same option statement.

SET command

As part of the SET command, system logger may issue a TRACE CT or a DISPLAY LOGGER command. See *z/OS MVS Setting Up a Sysplex* Define authorization for the system logger address space for required SAF authority.

Note: The SETLOGR system command can also be used to make changes to the system logger (IXGLOGR) address space processing.

MMS=xx

When the MVS message service (MMS) is not active, SET MMS=xx starts the message translation service. When MMS is active, SET MMS=xx changes the MMSLSTxx member. The two alphanumeric characters indicate the MMSLSTxx member of the logical parmlib the system is to use.

MMS=NO

Ends MMS processing and frees all allocated resources.

MPF=(xx[,xx...])

Specifies one or more MPFLSTxx members of the logical parmlib that are concatenated to form the MPF table. The value of xx can represent any of these items:

- The message(s) being suppressed by MPF
- The action message(s) not being retained by the action message retention facility
- The installation exit(s) to receive control for selected messages
- The status of the general WTO installation exit IEAVMXIT
- Whether this message is automated by MPF
- The MPFLSTxx member that identifies the message ID, color attribute, or command installation exit definition
- What color, intensity, and highlighting capabilities are in effect
- The status of the command installation exit routines specified in the logical parmlib member MPFLSTxx
- The current installation options for handling foreign messages
- Whether verbose messages are to be produced or not

The MPF parameter in the INIT statement in the CONSOLxx member of the logical parmlib controls which, if any, MPFLSTxx members are active at IPL.

MPF=NO

Ends MPF processing (message suppression and presentation). NO is ignored when specified in combination with a 2-character suffix.

MSGFLD=xx

The two characters xx indicating the MSGFLDxx member of the logical parmlib that contains the message flood automation parameters. Message flood automation processing requires the xx be alphabetic, numeric or national characters.

OMVS=(xx[,xx...,nn])

The two alphanumeric characters that specify one or more BPXPRMxx parmlib members.

OPT=xx

The two alphanumeric characters indicating the IEAOPTxx member of the logical parmlib that contains the new parameters SRM is to use.

Note: For IEAOPTxx , you can only have one parmlib member active. If you want to change one of the parameters, you have to copy the whole parmlib member and make the change. Use the changed one as your new IEAOPT member.

PFK=xx

The two alphanumeric characters indicating the PFKTABxx member of the logical parmlib that contains the PFK tables that are to be available for a console. The PFK(xx) keyword on the INIT statement in CONSOLxx identifies the PFKTABxx member that is available at IPL.

Note: The CONTROL command (K N,PFK=nnnnnnnn) must be issued to invoke the PFKTABxx member specified in the SET command.

PROD=(xx[,xx...])

The two alphanumeric characters indicating the IFAPRDxx members of the logical parmlib that contain the desired product enablement policy. If a policy already exists, the system performs the actions defined in the specified member(s) to modify the existing policy.

The system processes the members in the order specified. If it encounters a member that does not exist, command processing stops.

PROG=(xx[,xx...][,C])

The two alphanumeric characters that specify one or more PROGxx parmlib members. The system processes the members in the order specified. If it encounters a member that does not exist, command processing stops. When C is appended to this command, the system checks the validity of the syntax of the specified PROGxx parmlib members only. Each PROGxx member contains definitions that:

- Control the format and contents of the list of APF-authorized libraries
- Control the use of exits and exit routines
- Control the LNKLST concatenation by defining and modifying LNKLST sets
- Control the addition of modules to, and removal of modules from, the LPA after IPL

You can use the SET PROG=xx command to control exits previously defined to the dynamic exits facility. Dynamic exits services are implemented by:

- The EXIT statement of the PROGxx parmlib member. The EXIT statement of PROGxx allows an installation to add exit routines to an exit, delete an exit routine for an exit, change the state of an exit routine, change the attributes of an exit, and undefine an implicitly defined exit.

The PROGxx EXIT statement interacts with the PROG=xx parameter of IEASYSxx and the SET PROG=xx command. At IPL, you can use PROG=xx to specify the particular PROGxx parmlib member the system is to use. During normal processing, you can use the SET PROG=xx command to set a current PROGxx parmlib member. See *z/OS MVS Initialization and Tuning Reference* for information about the PROGxx parmlib member.

- The SETPROG EXIT operator command. This command performs the same functions as the EXIT statement of the PROGxx parmlib member.
- The CSVDYNEX macro. The CSVDYNEX macro can be used to define exits to the dynamic exits facility, control their use within a program, and associate one or more exit routines with those exits. It can also be used to associate exit routines with the existing SMF and allocation exits, which have been defined to the dynamic exits facility.

SET command

You can use the SET PROG=xx command to control the LNKLST concatenation. The PROGxx LNKLST statement interacts with the PROG=xx parameter of IEASYSxx and the SET PROG=xx command. At IPL, you can use PROG=xx to specify the particular PROGxx parmlib member the system is to use. During normal processing, you can use the SET PROG=xx command to set a current PROGxx parmlib member, or use the SETPROG LNKLST operator command to modify LNKLST sets. This command performs the same functions as the LNKLST statement of the PROGxx parmlib member and allows you to make dynamic changes to a LNKLST set. See "SETPROG command" on page 720.

You can use the SET PROG=xx command to control the content of the LPA dynamically following IPL. The PROGxx LPA statement can specify modules that are to add to the LPA following IPL, those to delete from the LPA, and threshold values for minimum amounts of CSA storage that must still be available after an ADD operation.

You can also initiate a change to LPA from a program via the CSVDYLPA macro, or by an operator using the SETPROG command. See *z/OS MVS System Commands*. However, modules accessed through a Program Call (PC) instruction cannot be replaced using a SETPROG LPA command. That is because even though the addresses of those modules are stored in the PC table, that table is not updated by the SETPROG LPA command.

RESET

Specifies the time zone constant that is used to calculate the local date and time is reset to the value that was read in from the CLOCKxx member of the logical parmlib during system initialization. The local date and time are changed accordingly. When you specify RESET, omit DATE and CLOCK.

SCH=(xx[,xx...][,L])

The two alphanumeric characters indicating the SCHEDxx members of the logical parmlib that contain the desired program properties table (PPT) configuration. The L is optional and causes the system to display parmlib statements on the operator console as they are processed.

The SET SCH command causes the system to replace the current PPT definitions with the IBM-supplied default PPT definitions and the PPT definitions from one or more SCHEDxx members that you specify on the command. The effect of the command is not cumulative. The new PPT definitions take effect immediately, without requiring a re-IPL of the system.

Note:

1. The SET SCH command only affects the PPT configuration statement.
2. If the SET SCH command fails, the current PPT configuration remains active.

SLIP=xx

The two alphanumeric characters indicating the IEASLPxx member of the logical parmlib that contains the commands SLIP processing is to use.

SMF=xx

The two alphanumeric characters indicating the SMFPRMxx member of the logical parmlib containing the parameters the system is to use when restarting SMF.

SMFLIM=(xx[,xx...][,C])

The two alphanumeric characters indicating the SMFLIMxx members of the logical parmlib that contain the desired SMF limit rules. Issuing this command without appending the C refreshes the in-storage copy of the specified parmlib

members with the SMF limits specified in the SMFLIMxx parmlib members in SYS1.PARMLIB. When you append C to this command, the system checks the validity of the syntax of the specified parmlib members, but does not update the SMF limit rules.

The new SMF limits are activated when the next job step starts. Job steps that are currently running are not affected, potentially resulting in different limits being used within the same job.

Tip: To display the in-storage copy of the SMF limits, issue the DISPLAY SMFLIM command. For instructions, see “Displaying the in-storage copy of the SMF limits” on page 429.

SMS=xx

The two alphanumeric characters indicating the IGDSMSxx member of the logical parmlib that contains the parameters the system is to use when it starts SMS. Specifying SMS=xx also starts SMS if it was not started at IPL or, restarts SMS if it has stopped and can't restart itself. Depending on the setting of the PROMPT keyword in the IEFSSNxx parmlib member, this command can display the parameters in the IGSMStvs member. (For a comparison of the SET SMS command with the SETSMS command, see Table 61 on page 743.)

You can use SET SMS=xx to specify an IGDSMSxx PARMLIB member that contains PDSESHARING(EXTENDED) to migrate members of a sysplex to PDSE extended sharing. This SET SMS command must be routed to every system that was operating with a PDSESHARING(NORMAL) PARMLIB member. This SET SMS command establishes that system's preference and causes it to communicate with the other sysplex members that it would like to switch to extended sharing. When all members have requested extended sharing, the sysplex can migrate to that level of sharing. You might have to issue SET SMS=xx a second time to trigger the switch from normal to extended sharing. Each of the systems issues message IGW306I when it migrates to extended sharing.

When the IGDSMSxx member of SYS1.PARMLIB is read, it can cause changes to any of the parameters that DFSMSStvs is using. The SET SMS command affects the following DFSMSStvs parameters in the IGDSMSxx member:

- AKP
- LOG_OF_LOGS
- MAXLOCKS
- QTIMEOUT
- RLSTMOUT
- RLS_MAXCFFEATURELEVEL
- RLSABOVETHEBARMAXPOOLSIZE
- RLSFIXEDPOOLSIZE

Refer to the optional keywords for the IGDSMSxx parmlib member in *z/OS MVS Initialization and Tuning Reference*.

TIMEZONE={W | E}.hh.mm

Specifies the local time zone value.

W | E

Specifies the direction from UTC. W for west of UTC or E for east of UTC.

SET command

hh.mm

Specifies the number of hours (hh) and minutes (mm) for the local time zone value. The value for hh must be between 00 and 15. The value for mm must be between 00 and 59.

If you omit mm, the default value is zero.

Do not use the SET TIMEZONE command on any z/OS release before Release 7. If a user attempts to issue this parameter on any z/OS Release before Release 7, the system will issue message IEE309I as follows:

```
IEE309I SET      UNIDENTIFIABLE KEYWORD
```

UNI=(xx[,xx...])

The two alphanumeric characters indicating the CUNUNIXx parmlib member that controls the conversion environment (Unicode services). Use this command to change the environment when the system is already up and running.

Example 1:

When the displayed local time and date are 19.00.00 and 191.141, respectively, to set the local time ahead to 1:00 a.m., enter:

```
T DATE=1991.142,CLOCK=01.00.00
```

OR

```
T DATE=91.142,CLOCK=01.00.00
```

It is necessary to enter DATE because the time change, in this example to 1:00 a.m., implies a change of date.

Example 2:

To reset the time and date to the values set during IPL, enter:

```
T RESET
```

Example 3:

To restart SMF with the parameters found in the SMFPRMAA member of the logical parmlib, enter:

```
T SMF=aa
```

Example 4:

To change SMS parameters to those found in the IGDSMS21 member of the logical parmlib, or to start or restart SMS by using the parameters in that member, enter:

```
SET SMS=21
```

Example 5:

To change MMS parameters to the parameters found in the MMSLST3A member of the logical parmlib or to start MMS using the parameters in that member, enter:

```
SET MMS=3A
```

Example 6:

To change the current GRSRNLs to those found in the GRSRNL01, GRSRNL09, and GRSRNL12 members of the logical parmlib, enter:

```
SET GRSRNL=(01,09,12)
```

Example 7:

To change the desired APPC/MVS address space configuration with the parameters found in the APPCPM01 member of the logical parmlib and the desired APPC/MVS scheduler configuration in ASCHPM12, ASCHPM03, and ASCHPM09, enter:

```
SET APPC=01,ASCH=(12,03,09)
```

Example 8:

To change the desired PPT configuration with the parameters found in the SCHED04 and SCHED05 members of the logical parmlib and also list the parmlib statements to the operator console as they are processed, enter:

```
SET SCH=(04,05,L)
```

Example 9:

To SET the console group definitions in the CNGRPAA member, enter:

```
SET CNGRP=AA
```

Example 10:

To SET the console group definitions in the members CNGRPAA and CNGRPBB, enter:

```
SET CNGRP=(AA,BB)
```

Example 11:

To remove all console group definitions from the sysplex, enter:

```
SET CNGRP=NO
```

Example 12:

To change the MPFLSTxx member that builds the MPF table the system uses, enter:

```
SET MPF=06
```

Example 13:

To change the MPFLSTxx members that builds the MPF table the system uses, enter:

```
SET MPF=(A1,A2,B4)
```

Example 14:

To set the PROGxx member that the system uses to refer to the APF list, enter:

```
SET PROG=03
```

Example 15:

To set the current DIAGxx member to DIAG05, enter:

SET command

```
SET DIAG=05
```

Example 16:

To change the product enablement policy with the parameters found in IFAPRDA2 and IFAPRDA3, enter:

```
SET PROD=(A2,A3)
```

Example 17:

To change to using the TSO/E parameters found in IKJTSOA1, enter:

```
SET IKJTSO=A1
```

Example 18:

To change the auto-reply policy with additional entries, create a new AUTORS0 member and issue:

```
t autor=(S0,00)
CNZ2600I AUTO-REPLY PROCESSING MODIFIED.
```

Example 19:

To set the current IXGCNFxx member to IXGCNF05, enter:

```
SET IXGCNF=05
```

Example 20:

To process parmlib member CONSOLZX, enter:

```
SET CON=ZX
```

Example 21:

To verify the syntax of the SMFLIMS1 and SMFLIMS2 parmlib members without changing the active SMF limit definitions, issue the following command:

```
SET SMFLIM=(S1,S2,C)
```

Figure 35 provides sample output for the SET SMFLIM=(S1,S2,C) command.

```
ASA021I SYNTAX CHECKING IS COMPLETE FOR PARMLIB MEMBER=SMFLIMS1. NO
ERRORS WERE FOUND
ASA021I SYNTAX CHECKING IS COMPLETE FOR PARMLIB MEMBER=SMFLIMS2. NO
ERRORS WERE FOUND
```

Figure 35. Sample output for the SET SMFLIM=(S1,S2,C) command

SETALLOC command

Use the SETALLOC command to dynamically modify Device Allocation settings.

Syntax

The complete syntax for the SETALLOC command is:

```

SETALLOC {SPACE[,PRIMARY=n]
          [,SECONDARY=n]
          [,DIRECTORY=n]
          [,MEASURE={TRK|CYL|AVEBLK}}
          [,BLKLNTH=n]
          [,ROUND={ROUND|NOROUND}}
          [,PRIM_ORG={CONTIG|MXIG|ALX|NONCONTIG}}
          [,RLSE={RLSE|NORLSE}} ]
{UNIT [,NAME=group]
      [,UNITAFF={unit|SYSTEMDEFAULT}}
      [,REDIRECTED_TAPE={TAPE|DASD}} ]
{TIOT,SIZE=n}
{SDSN_WAIT,WAITALLOC={YES|NO}}
{VOLUME_ENQ,POLICY={WTOR|CANCEL|WAIT}}
{VOLUME_MNT,POLICY={WTOR|CANCEL}}
{SPEC_WAIT[,POLICY={WTOR|CANCEL|WAITHOLD|WAITNOH}}
      [,MAXNWAIT=n]
      [,POLICYNW={WTOR|CANCEL}} ]
{ALLC_OFFLN[,POLICY={WTOR|CANCEL|WAITHOLD|WAITNOH}}
      [,MAXNWAIT=n]
      [,POLICYNW={WTOR|CANCEL}} ]
{CATLG_ERR[,FAILJOB={YES|NO}}
      [,ERRORMSG={YES|NO}} ]
{VERIFY_VOL,POLICY={YES|NO}}
{SYSTEM[,IEFBR14_DELMIGDS={LEGACY|NORECALL}}
      [,TAPELIB_PREF={EQUAL|BYDEVICES}}
      [,REMIND_INTV=intv]
      [,TEMPDSFORMAT={UNIQUE|INCLUDELABEL}}
      [,VERIFY_UNCAT={FAIL|TRACK|MSGTRACK|LOGTRACK}}
      [,MEMDSENQMGMT={ENABLE|DISABLE}}
      [,BATCH_RCLMIGDS={SERIAL|PARALLEL}}}]

```

Note:

1. For the output of the SETALLOC command, see the description of message IEFA010I in *z/OS MVS System Messages, Vol 8 (IEF-IGD)*.
2. Only Allocation parameters that are applicable to the current setting can be set. For example, for an ALLC_OFFLN POLICY=WTOR, MAXNWAIT is not applicable, so a SETALLOC ALLC_OFFLN,POLICY=WTOR,MAXNWAIT=10 command would be rejected.
3. Likewise, all applicable Allocation parameters are required when the setting is changed to one that has dependent keywords. For example, when the ALLC_OFFLN policy is changed from POLICY=WTOR to POLICY=WAITNOH, MAXNWAIT and POLICYNW are applicable and must be specified, so a SETALLOC ALLC_OFFLN,POLICY=WAITNOH command would be rejected.
 SETALLOC
 ALLC_OFFLN,POLICY=WAITNOH,MAXNWAIT=10,POLICYNW=WTOR
 would be a valid command.
4. Duplicate keywords are not allowed. For example, SETALLOC ALLC_OFFLN,POLICY=WAITNOH,POLICY=WAITNOH is not valid.
5. If any part of the command is not valid, the entire command is rejected and no parameter changes are made to the system.
6. The SETALLOC command does not support modification of the 2DGT_EXPDT POLICY that can only be changed by the ALLOCxx parmlib member.

SETALLOC command

7. Configuration updates made using the SETALLOC command are only applicable during the current IPL. If the updates are intended to be permanent, the appropriate ALLOCxx parmlib member must also be updated.
8. Options changed by the SETALLOC command apply only to job steps that start after the command has completed. The command has no effect on existing allocations.

Parameters

SPACE

Specifies the installation defaults for some space allocation parameters. These defaults apply to only dynamic allocation and VIO requests. Space allocations specified on JCL (for VIO requests), on dynamic allocation, or in SMS data classes take precedence over the values coded on this statement.

PRIMARY=n

Specifies one of the following:

- If MEASURE=TRK, the number of tracks to be allocated.
- If MEASURE=CYL, the number of cylinders to be allocated.
- If MEASURE=AVEBLK, the number of average data blocks in the data set, where n is a number in the range of 0-16,777,215 or $2^{24}-1$.

When you specify TRK or CYL for a partitioned data set (PDS), the primary quantity includes the space for the directory. When you specify a block length for a PDS, the primary quantity does not include the directory space; the system assigns the directory space outside the primary space assignment.

One volume must have enough available space for the primary quantity. If you request a particular volume and it does not have enough space available for your request, the system ends the job step. Allow for track overflow when you compute track requirements.

SECONDARY=n

Specifies the number of additional tracks, cylinders, blocks, or records to be allocated, if more space is needed, where n is a number in the range 0-16,777,215 or $2^{24}-1$. The system does not allocate additional space until it is needed.

If the requested volumes have no more space available, and if at least one volume is demountable, the system asks the operator to mount scratch (nonspecific) volumes until the secondary allocation is complete. If none of the volumes are demountable, the system abnormally ends the job step.

Note: Your program should not write with a disposition of DISP=SHR unless you take precautions to prevent other programs from being written at the same time.

DIRECTORY=n

Specifies the number of 256-byte records needed in the directory of a PDS, where n is a number in the range 0-8,388,607 or $2^{23}-1$.

MEASURE=TRK|CYL|AVEBLK

Specifies the unit of measure of the space allocation as one of the following:

- TRK** Requests that space be allocated in tracks.
- CYL** Requests that space be allocated in cylinders.

AVEBLK

Requests that the system is to decide how many tracks to allocate based on the average block size. The size of the average block is specified using the BLKLNTH parameter, and the number of blocks is specified using the PRIMARY parameter.

Note: When you change MEASURE to AVEBLK, BLKLNTH and ROUND must also be specified on the same command.

BLKLNTH=n

Specifies, in bytes, the average block length of the data, where n is a number in the range 0-65535 or $2^{16}-1$.

Note: This parameter can be changed only when MEASURE=AVEBLK is specified.

ROUND=ROUND|NOROUND

Specifies whether (ROUND) or not (NOROUND) space allocated to the data set must be equal to an integral number of cylinders.

Note: This parameter can only be changed when MEASURE=AVEBLK is specified.

PRIM_ORG={CONTIG|MXIG|ALX|NONCONTIG}

Specifies the organization of the primary space allocation.

CONTIG

Requests that space allocated to the data set be contiguous. If CONTIG is specified on a dynamic allocation non-VIO request and contiguous space is not available, the request fails.

MXIG Requests that space allocated to the data set meet the following requirements:

- The space is the largest area of available contiguous space on the volume.
- The space is equal to or greater than the value specified on the PRIMARY parameter.

Take care when coding this parameter. Large amounts of storage could be allocated, depending on how much free space is available at the time when the request is made. If you code this parameter, it is suggested that you also code the RLSE parameter to release any unused space.

MXIG is useful when you wish to dedicate as much space as possible on the volume to one data set, but is not useful as a system default.

Note: MXIG can also be specified in a job's JCL.

ALX Requests that up to five of the largest separate areas of available contiguous space are to be allocated to the data set, and each area must be equal to or greater than the value specified on the PRIMARY parameter.

Take care when coding this parameter. Large amounts of storage could be allocated, depending on how much free space is available at the time when the request is made. If you code this parameter, it is suggested that you also code the RLSE parameter to release any unused space.

SETALLOC command

ALX is useful when you wish to dedicate as much space as possible on the volume to one data set and it does not have to be contiguous.

Note: ALX can also be specified in a job's JCL.

NONCONTIG

Specifies that non-contiguous space is acceptable.

RLSE=RLSE|NORLSE

Specifies whether (RLSE) or not (NORLSE) space allocated to an output data set, but not used, is to be released when the data set is closed, and the CLOSE macro does not specify TYPE=T. Unused space is released only if the data set is open for output and the last operation was a write.

UNIT

Specifies the installation default for the device on which the system is to place data sets.

NAME=group

Specifies the group of devices onto which data sets are placed, where group is a valid device group name. The installation must have assigned the name to the device(s) during system initialization or IBM must have assigned the name. This default applies only to dynamic requests.

UNITAFF={name|SYSTEMDEFAULT}

Specifies the installation default for the unit name on which the system is to place data sets when the following conditions are true:

- The data set for the referencing DD, namely, the DD that specifies UNIT=AFF, DISP=NEW or DISP=MOD (MOD treated as NEW), is not SMS-managed.
- The data set for the referenced DD, namely, the DD statement pointed to by the UNIT=AFF subparameter, is SMS-managed.
- The allocation is not part of a data set collection involving data set stacking.
- The system cannot obtain a unit name from the primary DD statement in the unit affinity chain.

When name is specified, the installation must have assigned the name to the device(s) during system initialization, or IBM must have assigned the name. When SYSTEMDEFAULT is specified, the tape generic that is highest in the device preference table is used. This generic must be available on every IODF used on the system between this IPL and the next IPL.

REDIRECTED_TAPE=DASD|TAPE

Allows the installation to specify whether unopened batch-allocated DASD data sets that were redirected from tape should be treated as DASD or TAPE.

Specifying REDIRECTED_TAPE(TAPE) causes unopened batch allocated data sets that have been redirected from TAPE to DASD to be deleted during final disposition processing. These unopened redirected data sets are deleted regardless of the disposition requested.

Specifying REDIRECTED_TAPE(DASD) causes unopened batch allocated data sets that have been redirected from TAPE to DASD to be processed according to the original disposition, as they would have been if they had been directed to DASD and not redirected to DASD from TAPE.

Note: Dynamic allocation of SMS DASD data sets that were redirected from TAPE continue to be treated as DASD during dynamic allocation.

TIOT

Specifies the installation defaults for the task I/O table (TIOT).

SIZE=n

Specifies the size of the TIOT, where n is a number in the range 16-64 for each KB of space . (For example: 16 means 16KB).

The TIOT contains an entry for each DD statement. The size of the TIOT decides how many DDs are allowed per jobstep. See *z/OS MVS Initialization and Tuning Reference*

for examples on calculating the TIOT space required for a jobstep.

SDSN_WAIT

Specifies the installation policy for batch jobs that must wait for availability of data sets that have special types of names.

WAITALLOC=YES|NO

Specifies whether (YES) or not (NO) to cancel jobs that must wait to enqueue on a GDG absolute generation data set name, or a real data set name (when its corresponding alias data set name is specified on the JCL).

When YES is specified, and the enqueue request of a batch job cannot be satisfied, the system issues messages IEF861I, IEF863I and IEF458D. The job waits, holding any resources it might have acquired. The system operator can choose to cancel the job in response to message IEF458D, or allow the job to continue waiting until the enqueue becomes available. If the operator cancels the job, the system writes an informational message IEF330I to the job log.

When NO is specified, the system cancels the job, releases its resources, and issues message IEF211I.

Note:

1. Use with caution when specifying YES. Allowing jobs to wait for data set availability can cause deadlocks with other jobs in the system.
2. When you specify YES, the system does not allow the job to wait for a data set when both of the following conditions are true:
 - a. This job plus one (or more) other jobs have the data set allocated as DISP=SHR.
 - b. This job requests that its use of the data set be upgraded from DISP=SHR to DISP=OLD. The system ends this job and issues message IEF211I.
3. The WAITALLOC option applies only to batch allocation requests (that is, allocation requests specified in the job's JCL).

VOLUME_ENQ

Specifies the installation policy for enqueueing on volumes when an allocation request has to wait for a volume or a series of volumes.

POLICY=WTOR|CANCEL|WAIT

Specifies the action to take. An installation exit can override the policy.

WTOR

The policy is to issue a message and let the operator make the decision about the allocation request.

SETALLOC command

CANCEL

The policy is to cancel a job that needs an unavailable volume. The system cancels the job, releases its resources, and issues message IEF251I.

WAIT

The policy is to let a job that needs an unavailable volume wait until the volume is available.

CAUTION: When WAIT is used as the default, deadlocks with other jobs in the system might arise for tape volumes.

VOLUME_MNT

Specifies the installation policy for mounting a volume when an allocation request requires a volume to be mounted.

The system calls the exit when processing mount requests for single volumes or the first volume of a multi-volume request. The system does not call the exit for tape mount requests that specify UNIT=DEFER or second and subsequent volumes of a multi-volume request. Use the EOV exit routine to handle second and subsequent volumes.

POLICY=WTOR|CANCEL

Specifies the action to take. An installation exit can override the policy.

WTOR

The policy is to issue a message and let the operator make the decision about the volume mount.

CANCEL

The policy is to cancel a job that needs a volume mounted. The system cancels the job, releases its resources, and issues message IEF251I.

SPEC_WAIT

Specifies the installation policy to be followed when an allocation request must wait for a specific volume or unit.

POLICY=WTOR|WAITHOLD|WAITNOH|CANCEL

Specifies the action to take. An installation exit can override the policy.

WTOR

The policy is to issue a message and let the operator make the decision about the wait request.

WAITHOLD

The policy is for the system not to release any of the devices that have already been allocated to this job before it waits for the required units or volumes. The system issues message IEF289E.

Be aware that using the WAITHOLD policy might cause a deadlock situation, particularly when the device is being used by a job that is going to wait. The system does not release any non-sharable devices (namely, non-DASD) that have already been allocated to the job before it waits for required units and volumes. To avoid this problem, do not specify WAITHOLD.

When devices for a job are held during a wait, and a device that was eligible for allocation to the job becomes ineligible for allocation (because of its use by a system utility, for example), the job might fail because it does not have enough devices to complete successfully. See IEF700I in the job log identifies this failure. Refer to message IEF700I for information about how to respond to this failure.

Note: When you change POLICY to WAITHOLD, POLICYNW must also be specified on the same command.

WAITNOH

The policy is to let the job wait while it does not hold the obtained resources. The system releases those devices that have been allocated to this job, and issues message IEF289E.

Note: When you change POLICY to WAITNOH, MAXNWAIT and POLICYNW must also be specified on the same command.

CANCEL

The policy is to cancel the allocation request. If a TSO/E user issues the allocation request, the user receives an error message. If a batch job or started task issues the request, the system cancels the job or task, releases its resources, and issues message IEF251I.

MAXNWAIT=n

Specifies the number of WAITNOH decisions that can be made for the specific volume or unit allocation request before the default specified on the POLICYNW parameter takes effect, where n is a number in the range 1-255 or 2^8-1 .

The WAITNOH decisions counted are those specified either through the default on the POLICY parameter or through an installation exit specified in the EXITxx parmlib member. "WAITNOH" decisions made by the operator are not included in the MAXNWAIT count.

Note: This parameter can be changed only when POLICY=WAITNOH is specified.

POLICYNW=CANCEL|WTOR

Specifies how the system handles the allocation request under the following circumstances:

- Either WAITHOLD or WAITNOH is specified on the POLICY parameter and the system does not allow the job to wait for resources.
- The maximum number of WAITNOH decisions (specified on the MAXNWAIT parameter) has been exceeded.

The system is to either cancel the allocation request (CANCEL) or issue a message (WTOR).

Note: This parameter can be changed only when POLICY=WAITNOH or POLICY=WAITHOLD is specified.

ALLC_OFFLN

Specifies the installation policy to be followed when an allocation request needs a device that is offline, or must wait for a non-specific volume or unit.

Note: If all eligible devices are offline, they cannot be brought online without operator intervention. In this case, the system ignores the WAITHOLD and WAITNOH options and issues the WTOR immediately.

POLICY=WTOR|WAITHOLD|WAITNOH|CANCEL

Specifies the action to take. An installation exit can override the policy.

WTOR

The policy is to issue a message and let the operator make the decision about the needed device.

SETALLOC command

WAITHOLD

The policy is for the system not to release any of the devices that have already been allocated to this job before it waits for the required units or volumes. The system issues message IEF289E.

Be aware that using the WAITHOLD policy might cause a deadlock problem, particularly when the device is being used by a job that is going to wait. The system does not release any non-sharable devices (namely, non-DASD) that have already been allocated to the job before it waits for required units and volumes. To avoid this problem, do not specify WAITHOLD.

When devices for a job are held during a wait, and a device that was eligible for allocation to the job becomes ineligible for allocation (because of its use by a system utility, for example), the job might fail because it does not have enough devices to complete successfully. Message IEF700I in the job log identifies this failure. See message IEF700I for information about how to respond to this failure.

Note: When you change POLICY to WAITHOLD, POLICYNW must also be specified on the same command.

WAITNOH

The policy is to let the job wait while it does not hold the obtained resources. The system releases those devices that have been allocated to this job, and issues message IEF289E.

Note: When you change POLICY to WAITNOH, MAXNWAIT and POLICYNW option must also be specified on the same command.

CANCEL

The policy is to cancel the allocation request. If a TSO/E user issues the allocation request, the user receives an error message. If a batch job or started task issues the request, the system cancels the job or task, releases its resources, and issues message IEF251I.

MAXNWAIT=n

Specifies the number of WAITNOH decisions that can be made for the specific volume or unit allocation request before the default specified on the POLICYNW parameter takes effect, where n is a number in the range 1-255 or 2^8-1 .

The WAITNOH decisions counted are those specified either through the default on the POLICY parameter or through an installation exit specified in the EXITxx parmlib member. WAITNOH decisions made by the operator are not included in the MAXNWAIT count.

Note: This parameter can be changed only when POLICY=WAITNOH is specified.

POLICYNW=CANCEL|WTOR

Specifies how the system handles the allocation request under the following circumstances:

- Either WAITHOLD or WAITNOH is specified on the POLICY parameter and the system does not allow the job to wait for resources (needed devices).
- The maximum number of WAITNOH decisions (specified on the MAXNWAIT parameter) has been exceeded.

The system is to either cancel the allocation request (CANCEL) or issue a message (WTOR).

Note: This parameter can be changed only when POLICY=WAITNOH or POLICY=WAITHOLD is specified.

CATLG_ERR

Specifies the installation policy for handling certain types of errors that might occur when the system processes the disposition of batch unallocated data sets (data sets that have been unallocated at step termination time). The CATLG_ERR statement applies when the system is unable to:

- Catalog a new data set for which the user specified a disposition of CATLG.
- Catalog an old uncataloged data set for which the user specified a disposition of CATLG.
- Catalog an old cataloged data set again for which the volume list was extended, and for which the user specified a disposition of CATLG, KEEP or PASS.
- Roll an SMS-managed generation data set into the GDG base.

The CATLG_ERR statement does not apply when the user unallocates a data set before step termination with the following two methods:

- Dynamic deallocation (DYNALLOC macro).
- Having previously specified FREE=CLOSE on the allocation request (DYNALLOC macro or DD statement in the JCL of the job).

FAILJOB=YES|NO

Specifies whether (YES) or not (NO) the system is to end the job if a catalog error occurs.

When a job is ended by **FAILJOB(YES)**, the action of ending is considered a post-execution error.

Note:

1. The setting of the condition code is not affected.
2. The job is NOT abnormally ended, unless the step that encountered the error had itself previously abnormally ended. Termination means that subsequent steps will not be taken.
3. The normal disposition for data sets is taken, unless the step that encountered the error had already abnormally ended, in which case the abnormal or conditional disposition is taken.

ERRORMSG=YES|NO

Specifies whether (YES) or not (NO) the system is to issue an error message to the operator if a catalog error occurs.

When YES is specified, the system issues message IEF377I. If FAILJOB=YES was also specified, the system ends the job, releases its resources, and issues message IEF378I.

Note: If any of the following conditions is true, the system writes the error message even when **ERRORMSG=NO** is specified:

- The user specifies MSGLEVEL=(,1) on the JCL JOB statement.
- The JES installation default sets the message level to MSGLEVEL=(,1).
- The job abnormally ends.

SETALLOC command

VERIFY_VOL

Specifies the installation policy for verifying premounted, passed or retained volumes on autoswitchable (AS) tape devices.

Note: The OPEN, FEOV and CLOSE macros allow the specification of a positioning parameter, and the LEAVE option of these macros is treated the same as RETAIN.

An AS Tape device that is connected and possibly used outside of this allocation's tape management scheme can be "stolen" for temporary use by allocation on a system outside this scheme. This causes the volume status for the device to change, unbeknownst to the allocation's scheme. In this case, if the volume has been premounted, or the volume is passed or retained, this allocation scheme can cause inadvertent read/write activity on a volume, and result in data loss or data integrity exposures.

If, for a given DD statement, MVS allocation selects an AS tape device, and the UCB for the device shows that any currently mounted volume is the required volume for the DD, the system can optionally cause volume verification when an OPEN is performed for that DD.

POLICY=YES|NO

Specifies whether the system is to perform volume verification of an apparently premounted, passed or retained AS tape device at open time.

YES Volume verification is to be done by OPEN for Standard, ISO/ANSI Version 1, or ISO/ANSI/FIPS Version 3 labeled tape volumes that are premounted, passed or retained on an AS tape device. Both volume serial and tape position are verified.

NO No specific volume verification is to be done by OPEN for premounted, passed or retained volumes on an AS tape device. Select POLICY=NO option if it is certain that there is no exposure to the "stolen" AS device for premounted, passed or retained volumes as described in the previous scenarios. For example, specify POLICY=NO option if all systems within a sysplex are z/OS V1R2 or later, and tape devices that are defined as AS to systems within that sysplex are NOT shared with any systems, or sysplexes, outside of that sysplex.

SYSTEM

Specifies the system defaults.

IEFBR14_DELMIGDS=LEGACY|NORECALL

Specifies the policy on whether to recall a migrated data set when you use an IEFBR14 JCL program with DD DISP=(x,DELETE) to delete the data set. The recall is, in most cases, unnecessary, because the data set is being deleted anyway.

LEGACY

Indicates that the system is to recall HSM-migrated data sets before deletion.

NORECALL

Indicates that the system can delete (through HSM HDELETE processing) the data set without first recalling the data set to the primary storage.

TAPELIB_PREF=EQUAL|BYDEVICES

Specifies the policy on balancing non-specific tape library requests (for example, scratch tape requests) across multiple tape libraries.

EQUAL

Indicates that for non-specific tape library requests, all tape libraries must be treated as equal, and receive an equal share of the requests.

BYDEVICES

Indicates that non-specific tape library requests must be balanced across all tape libraries according to the number of tape devices in the tape library. Tape libraries with more tape devices receive more non-specific tape requests than libraries with fewer devices when all devices have the same attributes.

REMINDE_INTV(*xxx*)

Specifies the number of seconds for how often the message IEF882E/IEF883E is displayed, letting an operator know of an outstanding IEF238D/IEF433D/IEF434D. This interval is a number in the range 10-999, indicating how many seconds between reminder messages, or 0 to disable them.

TEMPDSFORMAT=UNIQUE | INCLUDELABEL

Specifies how the system generates data set names for temporary data sets that include '&&label' as the specified data set name. This statement affects only the data sets that specify DSN=&&mysdn, but not the data sets that do not specify DSN= at all.

UNIQUE

Indicates that when the system processes JCL that includes temporary data sets with DSN=&&LABEL, the generated data set name will be in the form "SYSydd.Thhmss.RA000.jjobname.Rggnnnnn", which does not include the &&label specified in the JCL. All references to "&&mysdn" throughout the JCL correctly refer to the same data set. Using TEMPDSFORMAT=UNIQUE ensures that jobs with the same jobname running simultaneously do not create temporary data sets with the same names. See *z/OS MVS JCL Reference* for more information.

INCLUDELABEL

Indicates that when the system processes JCL that includes temporary data sets with DSN=&&LABEL, the generated data set name will include the &&label specified in the JCL. See *z/OS MVS JCL Reference* for more information.

Note: When this parameter is specified and the Job Entry Subsystem (JES) allows multiple jobs with the same job name to execute at the same time, jobs with the same name, executing simultaneously, might fail with a duplicate data set name error.

Restrictions: The SETALLOC SYSTEM,TEMPDSFORMAT= command only affects jobs and job steps that are initiated after the command completes. Jobs that were initiated and created the temporary data sets before the command completes continue to use the old setting.

VERIFY_UNCAT

Specifies the policy for handling UNCATLG requests in JCL and dynamic allocation when the data set information is not retrieved from the catalog.

FAIL Fails the request. This option prevents a job from accidentally

SETALLOC command

uncataloging a cataloged data set with the same name as the data set that is allocated. This is the default behavior.

TRACK

Allows the data set to be uncataloged, and tracks the request in the tracking facility. This option allows a job to uncatalog a cataloged data set with the same name as the data set that is allocated. The installation can use this option to find and correct existing JCL that have uncataloged data sets incorrectly.

Note: This option is provided for migration purposes. It might be removed from the system in the future.

The tracking facility must be active for UNCATLG requests to be tracked. Whenever a job attempts to uncatalog a data set for which the data set information was not retrieved from the catalog, the job will be tracked with the tracking information containing the string IEFALC 01, followed by the step name and DD name.

- For batch allocated DDs, the program name contains IEFIIC.
- For dynamically allocated DDs, the program name is the invoking program if it can be determined, or SVC-099 if it cannot be determined.

The track value field is unused, and will contain zeros.

Instances of the IEFALC 01 event should be corrected by the installation rather than reported to IBM. For more information about the tracking facility, see *z/OS MVS Planning: Operations*.

MSGTRACK

Allows the data set to be uncataloged, tracks the request in the tracking facility, and issues a message. This option allows a job to uncatalog a cataloged data set with the same name as the data set that is allocated. The installation can use this option to find and correct existing JCL that have uncataloged data sets incorrectly.

Note: This option is provided for migration purposes. It might be removed from the system in the future.

The tracking facility must be active for UNCATLG requests to be tracked. Whenever a job attempts to uncatalog a data set for which the data set information was not retrieved from the catalog, the job will be tracked with the tracking information containing the string IEFALC 01, followed by the step name and DD name.

- For batch allocated DDs, the program name contains IEFIIC.
- For dynamically allocated DDs, the program name is the invoking program if it can be determined, or SVC-099 if it cannot be determined.

The track value field is unused, and will contain zeros.

Instances of the IEFALC 01 event should be corrected by the installation rather than reported to IBM. For more information about the tracking facility, see *z/OS MVS Planning: Operations*.

In addition to tracking the event, message IEF384I is issued to indicate that the data set is uncataloged, but the volume information is not retrieved from the catalog. This message informs the submitter of the job that the JCL should be corrected. The

message is only issued to the job log. For details about message IEF384I, see *z/OS MVS System Messages, Vol 8 (IEF-IGD)*.

LOGTRACK

Allows the data set to be uncataloged, tracks the request in the tracking facility, and issues a message. This option allows a job to uncatalog a cataloged data set with the same name as the data set that is allocated. The installation can use this option to find and correct existing JCL that have uncataloged data set incorrectly.

Note: This option is provided for migration purposes. It might be removed from the system in the future.

The tracking facility must be active for UNCATLG requests to be tracked. Whenever a job attempts to uncatalog a data set for which the data set information was not retrieved from the catalog, the job will be tracked with the tracking information containing the string IEFALC 01, followed by the step name and DD name.

- For batch allocated DDs, the program name contains IEFIIC.
- For dynamically allocated DDs, the program name is the invoking program if it can be determined, or SVC-099 if it cannot be determined.

The track value field is unused, and will contain zeros.

Instances of the IEFALC 01 event should be corrected by the installation rather than reported to IBM. For more information about the tracking facility, see *z/OS MVS Planning: Operations*.

In addition to tracking the event, message IEF384I is issued to indicate that the data set is uncataloged, but the volume information is not retrieved from the catalog. This message informs the submitter of the job that the JCL should be corrected. The message is issued to the job log and as a hardcopy only WTO. For details about message IEF384I, see *z/OS MVS System Messages, Vol 8 (IEF-IGD)*.

MEMDSENQMGMT

Specifies whether the MEMDSENQMGMT feature is available for exploitation by jobs and subsystems.

ENABLE

Allows jobs and subsystems to use memory-based data set ENQ management for dynamically allocated data sets. Memory-based data set ENQ management is faster than the other option, SWA-based data set ENQ management, for jobs that allocate a large number of data sets. In addition to the above parmlib setting, a job or subsystem that is to use the new management system must enable the feature using the IEFDDSRV macro, e.g. IEFDDSRV MODIFY TYPE=FEATURE, DSENQMGMT=MEMORY. Note that this feature makes the job or subsystem non-restartable through the checkpoint/restart interface.

DISABLE

Disables jobs and subsystems from using memory-based data set ENQ management for dynamically allocated data sets.

BATCH_RCLMIGDS

Specifies how migrated data sets will be recalled. When the

SETALLOC command

BATCH_RCLMIGDS option is changed, future jobs and jobsteps will use the new option while processing batch allocation. As such, the command can enable or disable this feature for a running job as it starts its next job step.

SERIAL

Indicates the system will allow the CATALOG LOCATE function to recall data sets on its behalf, resulting in serial recall processing. SERIAL is the default value.

PARALLEL

Indicates the system will note which data sets are migrated and recall them in parallel, potentially reducing job execution time.

Default: SERIAL

SETAPPC command

Use the SETAPPC command to dynamically define or modify the APPC/MVS configuration. Using this command, you can dynamically add or modify definitions for the APPC configuration without the need to edit an APPC parmlib member and issue a separate SET APPC command. However, if changes made to the APPC configuration using SETAPPC are permanent in nature, incorporate the configuration modifications into the appropriate APPC parmlib member. In this way, whenever APPC is recycled or if the system is re-IPLed, the configuration reflects the changes made by the SETAPPC command.

Syntax

The syntax of the SETAPPC command is:

```
SETAPPC {LUADD,ACBNAME=luname
        [,SCHED=schedname|NOSCHED]
        [,BASE ]
        [,PSTIMER=value|NONE|INDEFINITE]
        [,TPDATA=(dsname)]
        [,TPLEVEL={SYSTEM|GROUP|USER}]
        [,ALTLU=scheduler-supplied-value]
        [,USERVAR=scheduler-supplied-value]
        [,GRNAME=genericname]
        [, {NQN | NONQN}]}

        {LUDEL,ACBNAME=luname
        ,[{PERSIST | NOPERSIST}] }
        {SIDEINFO,DATASET=(dsname)}
```

Parameters

LUADD

Defines a local LU for the APPC/MVS configuration.

Use the SETAPPC LUADD command to define a local APPC/MVS LU to the APPC configuration.

The LUADD command must specify an LU name and (optionally)

- An indication of whether the LU is associated with a transaction scheduler
- The name of the transaction scheduler, if one is to be associated with this LU

- The amount of time the LU's sessions will persist in the event the LU becomes unavailable
- The TP profile file associated with the LU
- The level of TP profile from which the LU starts to search
- Optional values to be passed to an alternative transaction scheduler, or to any other member of the APPC XCF group, such as an APPC/MVS server
- A VTAM generic resource name to associate with the LU
- An indication of whether the LU is enabled to support network-qualified names for its partner LUs.

Each LU managed by APPC/MVS must be defined by either an LUADD statement previously invoked through the SET APPC command or through the SETAPPC command. When an installation uses the ASCH transaction scheduler exclusively, only one LU is required. If other transaction schedulers are used, each scheduler requires a separate LU. An installation might choose to define additional LUs to isolate TPs for security or testing.

An installation can also define LUs that are not associated with transaction schedulers. These LUs handle work that is processed by APPC/MVS servers, rather than scheduled by a transaction scheduler. Such LUs are indicated by using the NOSCHED keyword on LUADD. Installations can also use NOSCHED LUs when they want to flow outbound allocate requests without having a transaction scheduler active. (Note that APPC/MVS servers can also run under LUs that are associated with transaction schedulers.)

You can modify an LU by overriding previously defined LUs made through either the SET APPC or SETAPPC commands. In this case, the SETAPPC LUADD command specifies an ACBNAME that names an existing LU and then the parameters to be modified. The only parameters you cannot modify with an overriding LUADD are the SCHED, NOSCHED, ALTLU, USERVAR, GRNAME, NQN and NONQN parameters. To change these parameters, first delete the LU with a SETAPPC LUDEL command and then issue a SETAPPC LUADD command to re-add the LU with a changes to the parameters.

Example:

The following example defines LU MVSLU01 to be associated with the transaction scheduler provided with APPC/MVS:

```
SETAPPC LUADD,ACBNAME=MVSLU01,SCHED=ASCH,TPDATA=(SYS1.APPCTP),TPLEVEL=USER
```

ACBNAME(1uname)

The required name of the LU that APPC/MVS is to remove. If this LU was defined to VTAM, its association with VTAM is terminated after active conversations end.

Value Range: A one- to eight-byte character string of uppercase letters A through Z, numerals 0-9, national characters (@,\$,#) that must begin with an alphabetic or national character.

The SNA LU 6.2 architecture defines a network-qualified LU name to be up to 17 bytes in length and in the form *network_id.network_LU_name*, where *network_id* is the optional 8-byte id of the network and *network_LU_name* is the 8-byte local LU name. SAA CPI Communications allows the full 17-byte network-qualified LU name. However, for the ACBNAME keyword, specify only the 8-byte local LU name.

Default: None, this parameter is required.

SCHED(ASCH|schedname)

SETAPPC command

NOSCHED

An optional parameter that indicates whether the LU is to be associated with a transaction scheduler. LUs associated with a transaction scheduler cannot become active until that scheduler identifies itself to APPC/MVS. LUs not associated with a transaction scheduler become active as soon as APPC/MVS becomes active.

SCHED indicates that the LU is associated with a transaction scheduler. *schedname* must match the name the transaction scheduler specifies when it calls the Identify service. For more information about the Identify service and its scheduler_name parameter, see *z/OS MVS System Messages, Vol 3 (ASB-BPX)*.

NOSCHED indicates that the LU is not to be associated with a scheduler. When *NOSCHED* is specified, the LU becomes active as soon as APPC/MVS becomes active. Installations can use *NOSCHED* LUs to isolate work from schedulers when the work is to be processed by APPC/MVS servers. Installations can also use *NOSCHED* LUs to flow outbound allocate requests without having a transaction scheduler active.

Value Range: For *schedname*, the value is a one- to eight-byte character string and each character must be an uppercase letter (A-Z) or a numeral (0-9).

Note: *SCHED* and *NOSCHED* are mutually exclusive keywords; you cannot specify both *SCHED* and *NOSCHED* in a single LUADD statement. Doing so causes the system to ignore the statement and issue message ATB041I to the system operator.

Default: When you omit both *SCHED*(*schedname*) and *NOSCHED*, the default is *SCHED*(ASCH).

BASE

An optional parameter that designates the LU as the base LU. Base LUs are default LUs assigned to handle outbound work. A base LU can be the default LU associated with a particular transaction scheduler or a *NOSCHED* LU.

When a *NOSCHED* LU is defined with the *BASE* option, the LU becomes the *system base LU*. That means the LU is to be the default LU used for outbound allocate requests from MVS programs, such as batch jobs, TSO/E users, started tasks, and other work requests that attempt to enter the network without being associated with a scheduler or an LU.

Example: The following example defines a *NOSCHED* LU, MVSLU02, to be the system base LU.

```
SETAPPC LUADD,ACBNAME=MVSLU02,NOSCHED,BASE,TPDATA=(SYS1.APPCTEST),TPLEVEL=SYSTEM
```

If you do not define a *NOSCHED* LU as a base LU, the base LU defined for the APPC/MVS transaction scheduler (ASCH) becomes the system base LU. If the system base LU does not exist, APPC/MVS rejects conversations allocated by MVS programs that are not associated with a scheduler or an LU.

IBM recommends that you define one LU per transaction scheduler as the base LU for the scheduler. In addition, define a *NOSCHED* LU as the system base LU if you want to allow outbound requests from the system when no transaction schedulers are active.

When more than one LU is defined as the base LU, the one most recently defined is the base.

PSTIMER(value)

An optional parameter that sets the maximum amount of time for which the LU's sessions **persist** (are maintained) during interruptions in APPC/MVS or a transaction scheduler's service.

When you specify a valid value other than NONE, the LU's sessions persist when the APPC address space is canceled, forced, terminated, or automatically restarted. The sessions also persist during interruptions in scheduler service.

Any conversations that were active at the time of the interruption are lost. When APPC service is resumed, the conversation partners can re-establish these conversations, if desired.

Sessions do not persist in the event the LU is deleted.

Value Range:

- 0 or INDEFINITE (Sessions persist indefinitely)
- 1 - 86400 (Number of seconds the sessions can persist)
- NONE (Sessions are not to persist)

Default: NONE

TPDATA(dsname)

An optional parameter that specifies the name of the VSAM key-sequenced data set that contains TP profiles, along with an optional data base token for the LU. The data base token is used for verifying access authority to TP profiles. If this LU is a NOSCHED LU, APPC/MVS uses only the data set's data base token, if any. The data set specified on TPDATA must be cataloged in either a user catalog or the master catalog.

Value Range: Up to 44 characters in length consisting of one- to eight-byte character string of uppercase letters A through Z, numerals 0-9, national characters (@,\$,#) that must begin with an alphabetic or national character.

Default: SYS1.APPCTP

TPLEVEL({SYSTEM|GROUP|USER})

An optional parameter that identifies the level of TP profiles for which the LU searches in response to an inbound allocate request. TPLEVEL limits the search to the levels desired.

Each TP can have different levels of TP profiles with scheduling characteristics associated with a user, a group of users, or all users (system). The TPLEVEL parameter tells the LU which of those levels of TP profile to search.

Value Range:

SYSTEM means that the LU searches for system-level TP profiles only (NOT for a specific user or group of users).

GROUP means that the LU searches for TP profiles associated with (1) a specific group of users and (2) system-level TP profiles, in that order.

USER means that the LU searches for TP profiles associated with (1) a specific user, (2) a group of users, and (3) system-level TP profiles, in that order.

Note: If you specify NOSCHED, TPLEVEL must be SYSTEM. Also, TP profile entries in the data set specified in TPDATA are not used for NOSCHED LUs; only the data base token is used.

SETAPPC command

Default: SYSTEM

ALTLU(scheduler-supplied value)

This parameter allows optional, installation-supplied data to be passed to a member of the APPC XCF group, such as an alternative transaction scheduler or an APPC/MVS server.

If specified, the data is passed to the APPC XCF group member at the activation and deactivation of the associated LU. For information about the APPC XCF group, see *z/OS MVS System Messages, Vol 3 (ASB-BPX)*.

Value Range: A one- to eight-byte character string of uppercase letters A through Z, numerics 0-9, or national characters (@, \$, #), with the exception that the first character cannot be numeric (0-9).

Default: None

USERVAR(scheduler-supplied value)

This parameter allows optional, installation-supplied data to be passed to a member of the APPC XCF group, such as an alternative transaction scheduler or an APPC/MVS server.

If specified, the data is passed to the APPC XCF group member at the activation and deactivation of the associated LU. For information about the APPC XCF group, see *z/OS MVS System Messages, Vol 3 (ASB-BPX)*.

Value Range: A one- to eight-byte character string of uppercase letters A through Z, numerics 0-9, or national characters (@, \$, #), with the exception that the first character cannot be numeric (0-9).

Default: None

GRNAME(genericname)

This optional parameter specifies a VTAM generic resource name to be associated with the LU. The LU may be one of multiple LUs in the same generic resource group, represented by *genericname*. This parameter cannot be dynamically modified or added to an existing LU definition.

See *z/OS MVS Planning: APPC/MVS Management* for advice and restrictions about selecting a generic resource name, and deciding which LUs should become members of a generic resource group.

Value Range: A one- to eight-byte character string of uppercase letters A through Z, numerals 0-9, national characters (@, \$, #) and must begin with an alphabetic or national character.

Default: None. If the GRNAME parameter is not specified, the LU is activated but is not part of a generic resource group.

NQN

NONQN

An optional parameter that specifies whether the APPC/MVS LU is enabled to use a network-qualified partner LU name when first allocating outbound conversations. If you specify **NQN**, APPC/MVS uses the 17-byte network-qualified LU name when both verifying the partner LU, and sending the outbound Allocate request to the partner LU. If you specify **NONQN** (or allow the system to use the default), APPC/MVS uses the entire name when verifying the partner, but only the 8-byte network-LU-name portion when sending the outbound Allocate request.

See *z/OS MVS Planning: APPC/MVS Management* for the requirements for enabling APPC/MVS LUs to support network-qualified names.

Default: NONQN

LUDEL

The LUDEL command deletes a local APPC/MVS LU from the APPC configuration. One LUDEL statement must be specified for each LU to be deleted. The LUDEL statement contains:

- The LU name
- An indication of whether APPC/MVS keeps all persistent sessions active between this LU and all of its partners

When an LUDEL statement is processed, incoming allocation requests to the named LU are rejected; however, all active conversations are allowed to continue until completed. The LU is removed only after all active conversations have ended.

ACBNAME(1uname)

The required name of the LU that APPC/MVS is to remove. If this LU was defined to VTAM, its association with VTAM is terminated after active conversations end.

Value Range: A one- to eight-byte character string of uppercase letters A through Z, numerals 0-9, national characters (@,\$,#) and must begin with an alphabetic or national character.

For an explanation of why SAA CPI partner LU names can be 17 characters, see the note under the ACBNAME parameter in ACBNAME(luname) .

Default: None; this parameter is required.

PERSIST | NOPERSIST

An optional parameter that specifies whether APPC/MVS will deactivate all sessions between this LU and its partners when the LU is deleted. If you specify PERSIST, and if the LU was previously enabled to support persistent sessions through the PSTIMER keyword on the LUADD statement, APPC/MVS does not deactivate sessions between the LU and its partners. VTAM keeps these sessions active as long as the LU is re-added to the APPC configuration on the same system image within the PSTIMER time limit (single-node persistent sessions) or in any system image in the sysplex within the PSTIMER time limit (multi-node persistent sessions). See *z/OS MVS Planning: APPC/MVS Management* for further information. If you specify NOPERSIST (or allow the system to use the default), APPC/MVS deactivates all sessions between this LU and its partners when the LU is deleted.

Default: NOPERSIST

SIDEINFO

The SIDEINFO statement names the VSAM key sequenced data set that contains side information. Only one side information file is allowed per MVS system.

DATASET(dsname)

An optional parameter that specifies the name of the VSAM key sequenced data set that contains side information. The file must be cataloged in either a user catalog or the master catalog.

Value Range: Up to 44 characters in length consisting of one- to eight-byte character string of uppercase letters A through Z, numerals 0-9, national characters (@,\$,#) and must begin with an alphabetic or national character.

SETAPPC command

Default: SYS1.APPCSI

SETAUTOR command

Use the SETAUTOR command to deactivate auto-reply processing or to stop monitoring a current outstanding WTOR.

Syntax

The complete syntax for the SETAUTOR command is:

```
SETAUTOR {OFF  
          {IGNORE,RID={repid  
                    {0,SYS=sysname}          }}
```

Parameters

OFF

An optional parameter indicating that the auto-reply processing should deactivate and stop monitoring all WTORS.

IGNORE

An optional parameter requesting that the auto-reply processing should stop monitoring a WTOR.

repid The reply ID that identifies the WTOR that will no longer be monitored by auto-reply processing. The values supported are 0-9999.

Note: Different WTORS might each have a reply ID of zero. When the limit of outstanding WTORS is reached, each system will have one more ID (ID zero) that is to be assigned to one important WTOR at a time. Therefore, to distinguish which reply ID zero is desired, a system name must also be specified.

sysname

The name of the system where the reply ID zero message is issued.

For the output of the SETAUTOR command, see the descriptions of messages CNZ2600I and CNZ2607I in *z/OS MVS System Messages, Vol 4 (CBD-DMO)*.

Examples

Assume the following VARY command is issued to generate message IEE800D:

```
V 3D0,OFFLINE,FORCE  
0009 IEE800D CONFIRM VARY FORCE FOR 3D0 - REPLY NO OR YES
```

If message IEE800D (reply ID 0009) is to be ignored by auto-reply processing, issue:

```
SETAUTOR IGNORE,RID=9  
CNZ2607I AUTO REPLY WILL NO LONGER OCCUR FOR THE FOLLOWING WTOR:  
0009 06.46.55 2008130 IEE800D CONFIRM VARY FORCE FOR 3D0 - REPLY NO OR  
YES
```

If auto-reply processing is to be deactivated, issue:

```
setautor off  
CNZ2600I AUTO-REPLY PROCESSING DEACTIVATED.
```

SETCEE command

Use the SETCEE command to override system-level Language Environment options. You can modify multiple options in one SETCEE command; however, there is a limit of 126 characters per command. You can not continue the SETCEE command on a second line, each option must be completed in the 126 character limit. To synchronize the setting of multiple options, use the SET CEE command to use additional parmlib members.

Syntax

The complete syntax for the SETCEE command is:

```
SETCEE [CEEDOPT,opt,opt,...]
       [CEECOPT,opt,opt,...]
       [CELQDOPT,opt,opt,...]
       [CEEROPT,{ALL|COMPAT}]
       [CEEQROPT,{ALL|NONE}]
       [CLEAR]
```

Parameters

CEEDOPT

Sets your specified Language Environment run-time options in a non-CICS environment.

CEECOPT

Sets your specified Language Environment run-time options in a CICS environment.

CELQDOPT

Sets your specified Language Environment run-time options in an AMODE 64 environment.

opt

Specifies the Language Environment run-time option that is to be changed. The option can be any option that is valid in the CEEPRMxx parmlib member. For a list of valid options, see the example of the CEEPRMxx parmlib member in *z/OS MVS Initialization and Tuning Reference*.

CEEROPT

Specifies whether region-specific run-time options should be used in a non-CICS/non-LRR environment.

ALL

Load CEEROPT in all cases.

COMPAT

Load CEEROPT only in a CICS or LRR environment.

CELQROPT

Specifies whether region-specific run-time options should be used in AMODE 64.

ALL

Load CELQROPT in AMODE 64.

NONE

CELQROPT will not be loaded.

SETCEE command

CLEAR

Clears all the system level default run-time options and keywords that were set during IPL or with the SETCEE or SET CEE commands.

Example 1:

```
SETCEE CEEDOPT,POSIX(ON)
```

Example 2:

```
SETCEE CELQDOPT,HEAP64(1M),IOHEAP64(1M,1M)
```

SETCON command

Use the SETCON command to activate functions pertaining to the console environment. Also use the SETCON MONITOR command to control the monitoring of messages in your installation. The MONITOR option allows you to receive monitored messages without requiring that the messages be queued to a console or be written to SYSLOG or OPERLOG. For more information about the the MONITOR option and the console support modes, see *z/OS MVS Planning: Operations*.

The SETCON DELETE,CN=*nnnnnnnn* command can be used to delete the definition of any inactive MCS, HMCS, SMCS, EMCS, System or Subsystem console and cause all system resources that are assigned to the console to be released.

Note: The SETCON DELETE command is only processed when running in the distributed mode of console operation. For more information, see the operation modes of console support section in *z/OS MVS Planning: Operations*

Scope in a sysplex

The SETCON command has sysplex scope with the MODE parameter and the DELETE,CN= parameter. See "Using commands that have sysplex scope" on page 12 for an explanation.

Syntax

The syntax of the SETCON command is:

```
SETCON  {DELETE,CN=nnnnnnnn}
        {MODE={SHARED|DISTRIBUTED}}

        {MONITOR|MN} {,JOBNAMES={ (ON[,LOG|NOLOG]) |OFF}}
                   {,SESS={ (ON[,LOG|NOLOG]) |OFF}}
                   {,STATUS={ (ON[,LOG|NOLOG]) |OFF}}
                   {,T={ON|OFF}}
```

Parameters

DELETE, CN=*nnnnnnnn*

Deletes the definition of the specified console from the system. The console name *nnnnnnnn* and all resources that are associated with it will be freed and removed from the system.

MODE

Dynamically migrate between the console services shared and distributed

mode. You can use the `DISPLAY OPDATA,MODE` command to determine the current mode and the status of each system at that point in the migration.

SHARED

Migrates to the shared mode.

DISTRIBUTED

Migrates to the distributed mode.

MONITOR or MN

Controls whether monitor messages are to be enabled or disabled, as defined by each of the specified message types.

,JOBNAMES

The name of the job is displayed whenever the job starts and terminates, including unit record allocation when the step starts. If a job terminates abnormally, the job name will appear in a diagnostic message.

,SESS

The TSO/E user identifier is displayed whenever the TSO/E session begins and ends. If the session terminates abnormally, the user identifier appears in the diagnostic message.

,STATUS

The data set names and volume serial numbers of data sets with dispositions of `KEEP`, `CATLG`, or `UNCATLG` are displayed whenever data sets are freed.

,T For monitor messages that can optionally contain a timestamp, the timestamp is included in the message.

ON Controls whether monitor messages for the specified message type are to be enabled, or are to include a timestamp.

,LOG

Monitor messages are also to be sent to the `SYSLOG` or `OPERLOG`.

,NOLOG

Monitor messages are not to be sent to the `SYSLOG` or `OPERLOG`.

OFF

Controls whether monitor messages for the specified message type are to be disabled, or are not to include a timestamp. Note that when a request to disable this message type is made, production of these messages is disabled only if there are no consoles in the sysplex currently receiving this message type.

SETETR command

Use the `SETETR` command to enable external time reference (ETR) ports that have been disabled. An ETR port disabled by a hardware problem can be enabled after the problem has been corrected.

Also you might use `SETETR` to indicate to MVS that an adjustment has been made to the time from the 9037 Sysplex Timer. This use of `SETETR` is necessary for an MVS system using the 9037 Sysplex Timer and when it is running on a processor that follows:

- 3090 model J's
- 9121-320 based models
- 9021-340 based models

SETETR command

Syntax

The complete syntax for the SETETR command is:

```
SETETR PORT=n
```

Note: The SETETR command does not have an abbreviation.

Parameters

PORT=*n*

Specifies the number of the ETR port to be enabled. The valid values for *n* are 0 and 1.

Example:

To enable ETR port 1, enter:

```
SETETR PORT=1
```

SETGRS command

Use the SETGRS command to:

- Migrate a currently active global resource serialization ring complex to a star complex
- Modify the current RESMIL or TOLINT values
- Set the system values for
 - GRSQ
 - SYNCHRES
 - ENQMAXA
 - ENQMAXU
 - MONITOR
- Change the contention notifying system (CNS) in a global resource serialization complex
- Lower the AUTHQLVL keyword value
- Change the GRSMON xx parmlib member for this system

Syntax

The complete syntax for the SETGRS command is:

```
SETGRS {MODE=STAR}
        {[RESMIL=nnnnnnnn|RESMIL=OFF] [, TOLINT=nnnnn] [, SYNCHRES={YES|NO}]}
        {ENQMAXA|ENQMAXU=nnnnnnnn} [, {NOPROMPT|NP}]
        {CNS=sysname} [, {NOPROMPT|NP}]
        {GRSQ=ALL|CONTENTION|LOCALQ}
        {AUTHQLVL=n}
        {MONITOR={YES|NO}}
        {GRSMON=XX}
```

Note: The installation's system programmer should direct use of this command.

Parameters

MODE=STAR

Directs the system to convert a global resource serialization ring complex to a global resource serialization star complex.

MODE=STAR is mutually exclusive with the RESMIL and TOLINT parameters.

RESMIL=nnnnnnnn | RESMIL=OFF

Specifies the RSA-message residency time. The value indicates the minimum RSA-message residency time in milliseconds (that is, the least amount of time that the RSA-message is to spend in this system). The actual amount of time that the RSA-message is to spend in this system will vary between the time you specify in milliseconds and a maximum value calculated by global resource serialization. In this way, global resource serialization balances CPU use and ENQ response time.

If you specify RESMIL=OFF, the RSA-message residency time is set to zero and global resource serialization does no tuning. If you specify RESMIL=0, the system tunes the residency time in a range with a minimum of zero.

The RESMIL value can be from 0 to 99999999 milliseconds, or OFF. If you omit the RESMIL parameter, the current RESMIL value remains in effect. The current value was specified either by the GRSCNFxx parmlib member or by a previous SETGRS command.

TOLINT=nnnnn

Specifies, in seconds, the maximum tolerance time interval global resource serialization allows the RSA-message to return to this system, before it considers the RSA-message overdue.

The value of TOLINT can be from 1 to 86399 seconds. If you omit the TOLINT parameter, the current TOLINT value remains in effect. The current value was specified either by the GRSCNFxx parmlib member or by a previous SETGRS command.

SYNCHRES=YES | NO

Specifies whether synchronous reserve processing is activated. Action is only taken on the system where the command is issued.

ENQMAXA | ENQMAXU=nnnnnnnn [,NOPROMPT]

Assigns a new global resource serialization system enqueue maximum value for concurrent authorized (ENQMAXA) or unauthorized (ENQMAXU) requesters in a single system. This function enables you to dynamically update workload estimation for enqueue processing. Global resource serialization attempts to update the appropriate enqueue maximum as specified. The ISGADMIN service can update the maximum values for a specific address space. Global resource serialization uses the greater of the two maximums for its checking. For more information, see *z/OS MVS Programming: Authorized Assembler Services Reference EDT-IXG*.

value

A required parameter specifies the new concurrent maximum ENQ request value.

The ENQMAXA range is 250,000 to 99,999,999. The default is 250,000.

The ENQMAXU range is 16,384 to 99,999,999. The default is 16,384. See *z/OS MVS Planning: Global Resource Serialization* for complete guidance information.

SETGRS command

NOPROMPT

An optional parameter that informs the system not to issue the confirmation message.

Abbreviation: NP

CNS=*system-name* [,NOPROMPT]

CNS assigns a new global resource serialization contention notifying system (CNS) in a star complex.

Restriction: CNS is only applicable in a star complex.

NOPROMPT

An optional parameter that informs the system not to issue the confirmation message.

Abbreviation: NP

GRSQ={LOCAL | CONTENTION | ALL}

This parameter is specific to star mode and affects how quickly a dump is taken. GRSQ is system-specific; action is only taken on the system where the command is issued.

Restriction: GRSQ is only applicable in a star complex.

AUTHQLVL=1

An optional parameter that allows you to change the active GRS AUTHQLVL value to 1. IBM suggests setting the AUTHQLVL to the maximum value of 2 through the GRSCNFxx parmlib member. It can be changed to 1 if it is determined that various products still require particular qnames to be unauthorized.

For information about authorized qnames, see *z/OS MVS Planning: Global Resource Serialization*.

The GRSCNFxx parmlib member allows you to use the default or reset the value for the global resource serialization ring or start complex. See the GRSCNFxx member in *z/OS MVS Initialization and Tuning Reference*.

To issue the command you must have appropriate access to the RACF resource name MVS.SETGRS.AUTHQLVL. See *z/OS MVS Planning: Operations* for more information.

Use the DISPLAY GRS command to return information about the level for authorized qnames that are in effect.

MONITOR={YES|NO}

This parameter indicates whether to write SMF 87 monitoring records. MONITOR is system-specific; the parameter only affects the system on which the command is issued. To issue the command, you must have access to the RACF resource MVS.SETGRS.MONITOR.

GRSMON=XX

This parameter indicates the GRSMONxx parmlib member to use to determine which requests to monitor when MONITOR=YES.

Notes:

- GRSMON is system-specific; the parameter affects only the system on which the command is issued.
- To issue the command, you must have access to the RACF resource MVS.SETGRS.GRSMON.

- You may specify only a single GRSMONxx parmlib member on SETGRS. Specifying a concatenation of multiple GRSMONxx members is not supported.

For more information about GRSMONxx, see *z/OS MVS Initialization and Tuning Reference*.

Note:

1. The system on which you enter the SETGRS MODE=STAR command controls the migration.
2. When global resource serialization completes the transition to the star complex, the system issues the following message to indicate that the migration has completed and global resource serialization is active for the complex:
ISG334I GRS STAR COMPLEX INITIALIZATION COMPLETE
3. During processing of a SETGRS MODE=STAR command, no global resource requests (ENQ, DEQ, or RESERVE) will be processed. The length of time global resource serialization requesters are suspended may be several minutes, because the global resource serialization lock structure and sysplex couple data set records are going to be initialized with all of the complex-wide information, along with significant changes to the internal control block structures. IBM recommends invoking the migration capability at a time of minimal global resource serialization activity.
4. A SETGRS MODE=STAR request is valid if the following criteria are met:
 - Global resource serialization is running a ring complex.
 - All systems in the global resource serialization ring complex support a star complex.
 - There are no systems in the global resource serialization ring complex that are interconnected through the global resource serialization channel-to-channel support rather than the coupling facility.
 - All systems can access the ISGLOCK lock structure on the coupling facility.
 - The global resource serialization records are defined on the sysplex couple data set.
 - There are no dynamic RNL changes still in progress.
5. The RESMIL and TOLINT parameters are not valid on a SETGRS command issued in a global resource serialization star complex.
6. The RESMIL and TOLINT parameters of the SETGRS command affect only the system on which the SETGRS command is issued.
7. A SETGRS CNS=sysname request is only valid if the following criteria are met:
 - Global resource serialization is running in star complex.
 - All systems in the global resource serialization star complex support SETGRS CNS command (systems are at or above z/OS V1R7 with the required PTF).
 - The target system is an active system in the global resource serialization star complex.

Examples

Example: To migrate from a global resource serialization ring complex to star complex, enter:

```
SETGRS MODE=STAR
```

Example:

SETGRS command

```
SETGRS CNS=TEST2
XX ISG366D CONFIRM REQUEST TO MIGRATE
THE CNS TO TEST2. REPLY SYSNAME=TEST2
TO CONFIRM OR C TO CANCEL.
R XX,CNS=TEST2
Result: (when current CNS is TEST1)
ISG364I CONTENTION NOTIFYING SYSTEM MOVED
FROM SYSTEM TEST1 TO SYSTEM TEST2. OPERATOR COMMAND INITIATED.
```

Example:

```
SETGRS CNS=TEST2,NP
Result: (when current CNS
is TEST1) ISG364I CONTENTION NOTIFYING SYSTEM
MOVED FROM SYSTEM TEST1 TO SYSTEM TEST2.
OPERATOR COMMAND INITIATED.
```

Example:

```
SETGRS ENQMAXU=25000
XX ISG366D CONFIRM REQUEST TO SET THE ENQMAXU ON
SYSTEM TEST1 TO 25000.
REPLY ENQMAXU=25000 TO CONFIRM OR C TO CANCEL.
```

```
R XX,ENQMAXU=25000
result: ISG370I ENQMAXU ON SYSTEM
TEST1 HAS BEEN SET TO 25000.
```

Example:

```
SETGRS ENQMAXA=400000,NP
result: ISG370I ENQMAXA FOR SYSTEM
TEST1 HAS BEEN SET TO 400000.
```

Example:

```
SETGRS GRSQ=CONTENTION
result: ISG370I GRSQ FOR SYSTEM TEST1 HAS BEEN SET TO CONTENTION.
```

Example:

```
SETGRS
CONTENTION: WAITCNT=1
ALL: neither of the above
```

Example: The GQSCAN parameters for a dump with GRSQ requested is one of the following:

```
LOCAL: XSYS=NO
CONTENTION: WAITCNT=1
ALL: neither of the above
```

Example:

```
SETGRS AUTHQLVL=1
result: Sets the level for the AUTHQLVL to 1 to indicate that
the IBM default list of authorized qnames is in effect.
```

Example:

```
SETGRS MONITOR=YES
result: Monitoring of SMF 87 records is enabled on the system that issued
the command.
```

Example:

```
SETGRS GRSMON=XX
result: Parmlib member GRSMONxx is now activated to control monitoring
on this system.
```

SETGTZ command

Use the SETGTZ command to allow various changes to Generic Tracker using a set of parameters.

Upon completion of the command, one of the following messages is sent as a command response:

- GTZ1105I - processing completed successfully, with no pending asynchronous work.
- GTZ1106I - processing completed with errors.
- GTZ1103I - the command was accepted successfully, but some asynchronous work is still pending.
- GTZ1104I - the pending work is complete. This is a hardcopy-only message.

For additional references and an overview of the tracking facility, see *z/OS MVS Diagnosis: Tools and Service Aids*.

Table 45. Summary of the SETGTZ command

Command:	Topic:
SETGTZ TRACKING	"SETGTZ TRACKING command"
SETGTZ CLEAR	"SETGTZ CLEAR command" on page 664
SETGTZ EXCLUDE	"SETGTZ EXCLUDE command" on page 664
SETGTZ DEBUG	"SETGTZ DEBUG command" on page 669
SETGTZ DIAGNOSE	"SETGTZ DIAGNOSE command" on page 671
SETGTZ PERSIST	"SETGTZ PERSIST command" on page 671

Syntax

The syntax for each variation of the SETGTZ command is shown immediately preceding its respective parameter description.

Notes:

1. The SETGTZ command does not have an abbreviation.
2. The SETGTZ command follows the conventions for the second command format described in "System command formats" on page 168 and, in particular, requires explicit comment start and end sequences: a forward slash directly followed by an asterisk (/*), and an asterisk directly followed by a forward slash (*/).

SETGTZ TRACKING command

Use the SETGTZ TRACKING command to enable or disable tracking for the Generic Tracker. The Generic Tracker starts with TRACKING initially disabled (OFF).

Syntax

Table 46. SETGTZ TRACKING command

```
SETGTZ TRACKING={ON|OFF}
```

SETGTZ command

Parameters

The parameters for SETGTZ TRACKING are:

TRACKING=ON

Enables tracking. The tracking facility will honor GTZTRACK service requests and record data as appropriate.

TRACKING=OFF

Disables tracking. The tracking facility will ignore all GTZTRACK service requests and will not record any data. Tracking data, GTZPRMxx information, or related statistics will not be deleted at this time and will continue to be accumulated after a future TRACKING=ON request. To remove data from the facility, you can use the SETGTZ CLEAR command. To retrieve any data, use the DISPLAY GTZ command, the GTZQUERY service, or the GTZPRINT utility.

The Generic Tracker starts with TRACKING initially disabled (OFF).

SETGTZ CLEAR command

Use the SETGTZ CLEAR command to remove and reset assorted tracking facility data, settings, and statistics.

Syntax

Table 47. SETGTZ CLEAR command

SETGTZ CLEAR={TRACKDATA EXCLUDE DEBUG ALL}
--

Parameters

The parameters for SETGTZ CLEAR are:

CLEAR=TRACKDATA

Removes all tracked instances, and related data, like occurrence counts and timestamps for unique instances from the facility.

CLEAR=EXCLUDE

Removes all EXCLUDE statements and related data such as hit statistics for EXCLUDE statements from the facility.

CLEAR=DEBUG

Removes all DEBUG statements and related data such as hit statistics for DEBUG from the facility.

CLEAR=ALL

Executes all the actions for CLEAR=EXCLUDE, DEBUG, and TRACKDATA. Using CLEAR=ALL also resets additional statistics such as the list of GTZPRMxx parmlib member suffixes.

SETGTZ EXCLUDE command

Use the SETGTZ EXCLUDE command to add an EXCLUDE statement to the facility. The EXCLUDE statement consists of a filter for tracked instances. Any future GTZTRACK request with data matching the filter will not be recorded and any matching recorded tracked instances will be cleared from the facility.

Note: When trackdata comes in, if both an EXCLUDE statement and a DEBUG statement apply, the debug action will be triggered and the tracked instance will not be recorded.

Note: Duplicate EXCLUDE statements are allowed and will be ignored by the system.

Syntax

Table 48. SETGTZ EXCLUDE command

```
SETGTZ EXCLUDE(filter)
with filter:
  ALL
  | [OWNER={owner-filter-text|*}]
  | { [, SOURCETYPE=ALL
      | [, SOURCETYPE=NOPATH[, SOURCE={source-filter-text|*}]
      | [, SOURCETYPE=PATH[, SOURCEPATH={sourcepath-filter-text|*}]] }
  | [, EVENTDESC={event-description-filter-text|*}]
  | [, EVENTDATA={event-data-filter-value|*}]
  | [, EVENTJOB={event-job-filter-text|*}]
  | [, EVENTASID={event-ASID-filter-value|*}]
  | { [, PROGRAMTYPE=ALL
      | [, PROGRAMTYPE=NOPATH[, PROGRAM={program-filter-text|*}]
      | [, PROGRAMTYPE=PATH[, PROGRAMPATH={programpath-filter-text|*}]] }
  | [, PROGRAMOFFSET={program-offset-filter-value|*}]
  | [, HOMEJOB={home-job-filter-text|*}]
  | [, HOMEASID={home-ASID-filter-value|*}]
```

Parameters

The parameters for SETGTZ EXCLUDE are:

filter

Any tracked instance which matches the whole filter (all the filter pieces, OWNER, SOURCE,... match their GTZTRACK based counterparts) will be excluded from being recorded (for future GTZTRACK calls), or will be cleared from the facility (for past GTZTRACK data which has already been recorded).

OWNER=*owner*

To be compared to the OWNER value of a tracked instance (as specified on its GTZTRACK request).

If OWNER is specified, the *owner* value

- has to be a 1-16 character string.
- can contain wildcard characters anywhere in the string
 - an asterisk (*) will match any character sequence of zero or more characters and a question mark (?) will match a single arbitrary character.
- can only contain alphabetic characters (A-Z,a-z), numerics (0-9), national characters (@,\$,#), an underscore ('_'), a period (.), a dash (-), a slash (/), or wildcard characters.
- will have all lower-case characters (a-z) folded to uppercase (A-Z) for comparisons.

If OWNER is not specified, a default value of * (match all) is assumed.

SOURCETYPE

SOURCETYPE is optional with default ALL.

SETGTZ command

ALL

Any tracked instances with either a SOURCE or SOURCEPATH value will be matched. No further filtering on the SOURCE or SOURCEPATH value is provided.

PATH

Only tracked instances with a SOURCEPATH will be matched. Optionally a specific SOURCEPATH filter value can be specified. Tracked instances with a SOURCE value will not be matched.

NOPATH

Only tracked instances with a SOURCE will be matched. Optionally a specific SOURCE filter value can be specified. Tracked instances with a SOURCEPATH value will not be matched.

SOURCE=*source*

To be compared to the SOURCE value of a tracked instance (as specified on its GTZTRACK request). SOURCE can only be specified for SOURCETYPE=NOPATH.

If SOURCE is specified, the *source* value

- has to be a 1-8 character string.
- can contain wildcard characters anywhere in the string
 - an asterisk (*) will match any character sequence of zero or more characters and a question mark (?) will match a single arbitrary character.
- can only contain alphabetic characters (A-Z,a-z), numerics (0-9), national characters (@,\$,#), or wildcard characters.
- will have all lower-case characters (a-z) folded to uppercase (A-Z).

If SOURCE is not specified, a default value of * (match all) is assumed.

SOURCEPATH=*sourcepath*

To be compared to the SOURCEPATH value of a tracked instance (as specified on its GTZTRACK request). SOURCEPATH can only be specified for SOURCETYPE=PATH.

If SOURCEPATH is specified, the *sourcepath* value

- has to be a 1-1024 character string.
- has to be surrounded by quotes ('), which do not count toward the maximum length, if it contains any other characters than 'A-Z,a-z,0-9,#,\$,@,"',*,?,-,/,_,%,\'.
 - an asterisk (*) will match any character sequence of zero or more characters and a question mark (?) will match a single arbitrary character.
 - a single asterisk (*) can be specified without any quotes.
- can contain any EBCDIC character, but not just blanks or X'00'. IBM recommends to use printable characters.
- is case sensitive. If quotes are used, it will *not* have its alphabetic characters folded to upper-case. If quotes are not used, will have its alphabetic characters folded to upper-case.

Note: The pathnames are case sensitive, so IBM recommends to use quotes when specifying this value.

- will *not* have its trailing blanks removed when quotes are used.

If SOURCEPATH is not specified, a default value of * (match all) is assumed.

EVENTDESC=event-description-filter-text

To be compared to the EVENTDESC value of a tracked instance (as specified on its GTZTRACK request).

If EVENTDESC is specified, the *event-description-filter-text*

- has to be a 1-64 character string.
- has to be surrounded by quotes ('), which do not count toward the maximum length, if it contains any other characters than 'A-Z,a-z,0-9,#,\$,@,,"',*,?,-,_,/,-,%'.
- can contain wildcard characters anywhere in the string. An asterisk (*) will match any character sequence of zero or more characters and a question mark (?) will match a single arbitrary character.
- can contain any EBCDIC character, but not just blanks or X'00'. IBM recommends to use printable characters.
- if unquoted:
 - will *not* have its alphabetic characters folded to upper-case and will be compared case-sensitive.
 - will *not* have its trailing blanks removed.

Note: The event description is case sensitive, so IBM recommends to use quotes when specifying this value.

If EVENTDESC is not specified, a default value of * (match all) is assumed.

EVENTDATA=eventdata

To be compared to the EVENTDATA value of a tracked instance (as specified on its GTZTRACK request).

If EVENTDATA is specified, the *eventdata* value

- is interpreted as a 16 byte binary value.
- can be specified in hexadecimal format: One of X'hh' or 0hhx or 'hh'X or xhh, with hh representing 1 to 32 hexadecimal digits (A-F,a-f,0-9).
- can be specified as a decimal number.

If EVENTDATA is not specified, a default value of * (match all) is assumed.

EVENTJOB=eventjob

To be compared to the event address space job name, as derived from the EVENTASID value of a tracked instance (as specified on its GTZTRACK request).

If EVENTJOB is specified, the *eventjob* value

- has to be a 1-8 character string.
- can contain wildcard characters anywhere in the string. An asterisk (*) will match any character sequence of zero or more characters and a question mark (?) will match a single arbitrary character.
- can only contain alphabetic characters (A-Z,a-z), numerics (0-9), national characters (@,\$,#), or wildcard characters.
- will have all lower-case characters (a-z) folded to uppercase (A-Z).

If EVENTJOBNAME is not specified, a default value of * (match all) is assumed.

EVENTASID=eventASID

To be compared to the EVENTASID value of a tracked instance (as specified on its GTZTRACK request).

SETGTZ command

If EVENTASID is specified, the *eventASID* value

- is interpreted as a 16 bit binary value.
- can be specified in hexadecimal format, for example as X'82C1' or 082C1x or '82C1'X or x82C1.
- can be specified in decimal format, for example as 33473.

If EVENTASID is not specified, a default value of * (match all) is assumed.

PROGRAM=program

To be compared to the program name, as derived from the EVENTADDR value of a tracked instance (as specified on its GTZTRACK request). PROGRAM can only be specified for PROGRAMTYPE=NOPATH.

If PROGRAM is specified, the *program* value

- is interpreted as a 1-8 character string.
- can contain wildcard characters anywhere in the string:
 - an asterisk (*) will match any character sequence of zero or more characters and a question mark (?) will match a single arbitrary character.
- can only contain alphabetic characters (A-Z,a-z), numerics (0-9), national characters (@,\$,#), or wildcard characters.
- will have all lower-case characters (a-z) folded to uppercase (A-Z).

If PROGRAM is not specified, a default value of * (match all) is assumed.

PROGRAMTYPE=programtype

PROGRAMTYPE is optional with default ALL.

ALL

Any tracked instances with either a PROGRAM or PROGRAMPATH value will be matched. No further filtering on the PROGRAM or PROGRAMPATH value is provided.

PATH

Only tracked instances with a PROGRAMPATH will be matched. Optionally a specific PROGRAMPATH filter value can be specified. Tracked instances with a PROGRAM value will not be matched.

NOPATH

Only tracked instances with a PROGRAM will be matched. Optionally a specific PROGRAM filter value can be specified. Tracked instances with a PROGRAMPATH value will not be matched.

PROGRAMPATH=programpath

To be compared to the program path name, as derived from the EVENTADDR value of a tracked instance (as specified on its GTZTRACK request). PROGRAMPATH can only be specified for PROGRAMTYPE=PATH.

If PROGRAMPATH is specified, the *programpath* value

- has to be a 1-1024 character string.
- has to be surrounded by quotes ('), which do not count toward the maximum length, if it contains any other characters than 'A-Z,a-z,0-9,#,\$,@,,"',,*,?,-,/,;,%'.
- can contain wildcard characters anywhere in the string. An asterisk (*) will match any character sequence of zero or more characters and a question mark (?) will match a single arbitrary character.
- can contain any EBCDIC character, but not just blanks or binary zeros. IBM recommends to use printable characters.

- is case sensitive. If quotes are used, it will *not* have its alphabetic characters folded to upper-case. If quotes are not used, will have its alphabetic characters folded to upper-case.

Note: The pathnames are case sensitive, so IBM recommends to use quotes when specifying this value.

- will *not* have its trailing blanks removed when quotes are used.

If PROGRAMPATH is not specified, a default value of * (match all) is assumed.

PROGRAMOFFSET=programoffset

To be compared to the program offset, as derived from the EVENTADDR value of a tracked instance (as specified on its GTZTRACK request).

If PROGRAMOFFSET is specified, the *programoffset* value

- is interpreted as an 8 byte binary value.
- can be specified in hexadecimal format, for example as X'C2' or 0C2x or 'C2'X or xC2.
- can be specified in decimal format, for example as 193.

If PROGRAMOFFSET is not specified, a default value of * (match all) is assumed.

HOMEJOB=homejobname

To be compared to the home address space job name as derived from the dispatchable unit under which a tracked instance's GTZTRACK request was executed.

If HOMEJOB is specified, the *homejob* value

- has to be a 1-8 character string.
- can contain wildcard characters anywhere in the string
 - an asterisk (*) will match any character sequence of zero or more characters and a question mark (?) will match a single arbitrary character.
- can only contain alphabetic characters (A-Z,a-z), numerics (0-9), national characters (@,\$,#), or wildcard characters.
- will have all lower-case characters (a-z) folded to uppercase (A-Z).

HOMEASID=homeASID

To be compared to the ID of the home address space as derived from the dispatchable unit under which a tracked instance's GTZTRACK request was executed.

If HOMEASID is specified, the *homeASID* value

- is interpreted as a 16 bit binary value.
- can be specified in hexadecimal format, for example X'82C1' or 082C1x or '82C1'X or x82C1.
- can be specified in decimal format, for example as 33473.

If HOMEASID is not specified, a default value of * (match all) is assumed.

SETGTZ DEBUG command

Use the SETGTZ DEBUG command to add a DEBUG statement to the facility. DEBUG statements are intended as diagnostic aid to further debug certain tracked instance occurrences.

SETGTZ command

The DEBUG statement has parameters to describe the desired debug action and which tracked instances should trigger this action (via a filter). Any future GTZTRACK request with data matching the filter will have the requested debug action executed.

Besides triggering the debug action, a matching tracked instance will be recorded, unless there is also a matching EXCLUDE statement. This implies that an EXCLUDE statement will not prohibit a DEBUG statement from triggering, but just from being recorded.

If there is more than one debug statement that matches a GTZTRACK request, the most recently entered debug statement will be used. To be able to do that, the system will keep track of the order in which debug statements are specified. IBM recommends to be as specific as possible on your DEBUG filter and to avoid "almost" duplicate statements, such as having different reason code or debug action, to avoid unexpected behavior.

Syntax

Table 49. SETGTZ DEBUG command

```
SETGTZ DEBUG=(  
  ACTION={ABEND | DUMP}  
  ,REASON=usrrsn  
  ,LIMIT={actionlimit | NOLIMIT}  
  ,filter  
)
```

Parameters

The parameters for SETGTZ DEBUG are:

ACTION=ABEND

For matching GTZTRACK requests, the system triggers a non-percolating ABEND with system completion code X'E77' and with a reason code as specified by REASON. This action is recommended when a matching track request is made when SLIP processing is available, since SLIP allows a number of actions for when this ABEND is trapped, including creating an SVC dump. For example:

```
SLIP SET,ENABLE, ID=TRAK,COMP=E77,REASON=34,ACTION=SVCD,END
```

If no SLIP is set, an entry in LOGREC will be made, but no dump will be taken.

To help identify the occurrence of what is being tracked, the following registers at the time of the abend will contain the information shown:

- R2** The address of the GTZTRACK parameter list. See the program listing of the GTZTRACK invoker for a mapping.
- R3** The HOME-ASID of the GTZTRACK caller.
- R4** The eight characters of the HOME-jobname of the GTZTRACK caller.
- R5** The eight characters of the event-jobname, associated with the EVENTASID parameter of the GTZTRACK request.
- R6** The eight characters of the PROGRAM name as derived from the EVENTADDR parameter of the GTZTRACK request, or the address of the derived PROGRAMPATH.

R7 The program OFFSET as derived from the EVENTADDR parameter of the GTZTRACK request.

ACTION=DUMP

For matching GTZTRACK requests the system triggers a percolating ABEND with system completion code X'E77' and with a reason code as specified by REASON. A dump according to the current job's DUMP options will be created. This action is only recommended when a matching track request is made and SLIP processing is not available yet, otherwise ACTION=ABEND is recommended.

See ACTION=ABEND for special register contents being set by the system.

REASON=user-reason-code

Specifies which reason code to tag the debug action with.

The reason code:

- has to be in the range of 0000x - 0FFFx.
- can be specified in hexadecimal format, for example as X'02C1' or 02C1x or '02C1'X or x2C1.
- can be specified in decimal format, for example as 705.

LIMIT=(action-limit|NOLIMIT)

Requests that this DEBUG statement should not trigger more than *action-limit* number of debug actions of the specified kind for all future, matching GTZTRACK requests. The limit has to be in the range of 1 - 65535 or NOLIMIT has to be used.

Once the limit has been reached and you want to "reset" the limit to allow additional debug actions in the future, IBM recommends to use the CLEAR DEBUG command and then to add any DEBUG statement(s) again. You can combine this in a separate GTZPRMxx parmlib member and use the SET GTZ=xx command to have the tracking facility process these statements.

filter

Any new tracked instance which matches the whole filter (all the filter pieces, OWNER, SOURCE,... match their GTZTRACK based counterparts) and has not reached its limit yet will trigger the requested DEBUG action.

See "Parameters" on page 665 for more information.

SETGTZ DIAGNOSE command

Use the SETGTZ DIAGNOSE command only as directed and requested by IBM Service personnel to aid in collecting diagnostic information.

Syntax

Table 50. SETGTZ DIAGNOSE command

SETGTZ DIAGNOSE(ACTION= <i>action</i> ,VALUE= <i>value</i>)
--

SETGTZ PERSIST command

Use the SETGTZ PERSIST command to enable or disable the persistence of data for the tracking facility. The Generic Tracker starts with PERSIST initially disabled (OFF).

SETGTZ command

Syntax

Table 51. SETGTZ PERSIST command

SETGTZ PERSIST={OFF SMF}

Parameters

The following parameters are available for SETGTZ PERSIST:

PERSIST=OFF

The tracking facility will not attempt to persist GTZ data. This is the default when the tracking facility starts.

Note: GTZ data is normally kept in dynamic storage of the GTZ address space. When the system or GTZ shuts down, this data is lost, unless either of the following conditions exists:

- Before the shutdown, the data is extracted using GTZ tools such as the DISPLAY GTZ operator command, the GTZPRINT tool, the GTZQUERY service, or the GTZLQRY REXX function.
- The data is persisted in parallel with storage in dynamic storage. See PERSIST=SMF for more information.

PERSIST=SMF

The tracking facility will attempt to persist GTZ data in the form of SMF records.

Note: Other options that are in effect, for example the TYPE and NOTYPE options in PARMLIB member SMFPRMxx, might prevent the data from writing to the SMF records.

The SMF record type for GTZ data is 117, with one subtype of value 1. Subtype 1 records contain persisted TRACKDATA information. For a description of the fields in type 117 records, see mapping macro GTZZSMF. Also see the utility programs GTZSMFU2 and GTZSMFU3, which you can use to format type 117 records in text form.

Note: TRACKDATA information that the tracking facility collected before SMF persistence was enabled is not recorded in SMF records. To ensure that you record all TRACKDATA information, consider enabling data persistence using the corresponding PERSIST statement in a GTZPRMxx PARMLIB member, which is read when the tracking facility starts. Also see system parameter GTZ, which you can specify in, for example, IEASYSxx.

SETHS command

Use this command to manage Basic HyperSwap. The issuing operator must have at least RACF UPDATE authority to use the SETHS command or console IO authority. See Table 10 on page 125 and Table 11 on page 127 for additional information.

Note: Basic HyperSwap (BHS) command handling is performed by the BHS Subsystem Interface (SSI) exit processing. Therefore, this command requires the BHS address space to be active in order to recognize and process this command. If this command is issued when the BHS address space is not active, then message IEE305I will be issued indicating that the command is not valid at this time.

Syntax

The syntax for the SETHS command is:

```
SETHS {ENABLE}
      {DISABLE}
      {RESUMEIO}
      {UNBLOCK}
      {SWAP[,NAME(session_name)]}
      {UNFENCE}
```

ENABLE

Enables the HyperSwap function for all PPRC pairs.

DISABLE

Disables the HyperSwap function for all PPRC pairs.

Note: The DISABLE status does not persist across a sysplex-wide IPL.

RESUMEIO

Resumes normal I/O activity to all DASD devices that have been stopped by Basic HyperSwap because the STOP option was used. See message IOSHM0303I for the explanation of the STOP option. These devices can be identified by the device status DEVICE STOPPED BY HYPERSWAP when the DISPLAY M=DEV(*nnnn*) command is issued.

UNBLOCK

Unconditionally reset the HyperSwap inhibited by programmatic blocking condition.

SWAP

Initiates a HyperSwap for all PPRC pairs.

NAME(*session_name*)

Optionally selects a specific configuration (replication session) for the planned HyperSwap. If NAME is not specified, the planned HyperSwap will be attempted using the current preferred configuration.

session_name

The 16-character configuration name.

UNFENCE

Unconditionally remove the soft fence condition for all DASD devices.

SETICSF command

On systems running ICSF FMID HCR77B1 or later, and running z/OS V1R13 (with the PTF for APAR OA47380 installed) or later, the SETICSF command is used to perform the following specific administration functions:

- Activate, deactivate, or restart a cryptographic device.
- Add, check, or delete an open cryptographic device.
- Attempt to reopen sockets that were not previously opened.
- Change a subset of ICSF's installation options.
- Enable or disable updates to a key data set (KDS).

For a description of the SETICSF command, see *z/OS Cryptographic Services ICSF System Programmer's Guide*.

SETICSF command

Note: For additional information on these administrative functions and their impact on ICSF and cryptographic devices, see *z/OS Cryptographic Services ICSF Administrator's Guide*.

SETIOS command

In contrast to the SET command, which allows an installation to specify a different IECIOSxx parmlib member, the SETIOS command can dynamically change the missing interruption handler (MIH) or I/O timing (IOT) parameter. The parameters can appear in any order in the command, but there can only be one DEV and TIME parameter pair or DEV and IOTIMING pair in a command. You can create user classes for particular situations such as test environments and special job processing.

In addition, you can use the SETIOS command to do the following:

- Enable or disable the dynamic channel path management function.
- Refresh the control unit model table for the single point of failure detection function in dynamic channel path management.
- Enable or disable the gathering of FICON switch statistics.
- Enable or disable the use of FICON fabric I/O priority for the system.
- Enable or disable the MIDAW facility.
- Enable or disable UCB overlay protection.
- Indicate whether IOS blocks are obtained in 24 or 31 bit storage.
- Indicate the actions to be taken for an IO Timing HyperSwap trigger.
- Indicate the use of HyperPAV mode for the system.
- Enable or disable the encryption key management.
- Enable or disable the IOS recovery functions.
- Enable or disable the zHPF facility.
- Enable or disable IBM zHyperWrite data replication.

Syntax

The complete syntax for the SETIOS command is:

```

SETIOS [MIH[,class=mm:ss[,class=mm:ss]...]]
      [,MOUNTMSG={YES|NO}]
      [,DEV=([/]devnum[/],[/]devnum)...[,[/]lowdevnum-[/]highdevnum]...)]
      [,TIME=mm:ss]
      [,IOTIMING=mm:ss]
      [,DCCF={MESSAGE|WAIT_STATE}]
      [,MSGONLY={YES|NO}]
      [,IOTHSWAP={YES|NO}[,IOTTERM={YES|NO}]]]
[DCM={ON|OFF|REFRESH}]
[MIDAW={YES|NO}]
[FICON,STATS={YES|NO},FABRICPRTY={YES|NO}]
[CAPTUCB,PROTECT={YES|NO}]
[STORAGE,IOSBLKS={24|31}]
[HYPERPAV={NO|YES|BASEONLY}]
[EKM[,PRIMARY={host_name[:port],PRIPORT=port}] ]
      {ipv4_address[:port],PRIPORT=port}]
      {ipv6_address[,PRIPORT=port]}
      {NONE}
      [,SECONDARY={host_name[:port],SECPORT=port}] ]
      {ipv4_address[:port],SECPORT=port}]
      {ipv6_address[,SECPORT=port]}
      {NONE}
      [,MAXCONN=dd1]
      [,MAXPCONN=dd2]
[RECOVERY[,LIMITED_RECTIME=ss]
      [,DEV={DASD|IOTIMING}]
      [,PATH_SCOPE={CU[,PATH_INTERVAL=nn] } ]
      [,PATH_THRESHOLD=nnn]
      {DEVICE}]
[ZHPF={YES|NO}]
[HYPERWRITE={YES|NO}]

```

Note:

1. The SETIOS command does not have an abbreviation.
2. DEV and TIME together specify a user device class for one or more devices.
3. DEV and IOTIMING together specify a user device class for one or more devices.
4. During IPL (if the device is defined to be ONLINE), or during the VARY ONLINE process, some devices may present their own MIH timeout values, via the primary/secondary MIH timing enhancement contained in the self-describing data for the device. The primary MIH timeout value is used for most I/O commands. However, the secondary MIH timeout value may be used for special operations such as long-busy conditions or long-running I/O operations. Any time a user specifically sets a device or device class to have an MIH timeout value that is different from the IBM-supplied default for the device class, that value will override the device-established primary MIH time value. This implies that if an MIH time value that is equal to the MIH default for the device class is explicitly requested, IOS will NOT override the device-established primary MIH time value. To override the device-established primary MIH time value, you must explicitly set aside a time value that is not equal to the MIH default for the device class.

Note that overriding the device-supplied primary MIH timeout value may adversely affect MIH recovery processing for the device or device class.

SETIOS command

Please refer to the specific device's reference documentation to determine if the device supports self-describing MIH time values.

5. IOTHSWAP and IOTTERM together specify how an I/O timing timeout condition is handled with respect to triggering a HyperSwap.

Parameters

The parameters are:

MIH, *class=mm:ss*

Specifies the time interval for *class* in the form *mm:ss*, where *mm* is minutes and *ss* is seconds. The value range for *mm* is 00 - 99, and for *ss* is 00 - 59. When you set a class to 00:00, MIH or IOT no longer monitors the class.

You can specify the time interval for one or more of the following device class values for *class*:

CHAR

The character reader device class.

COMM

The communications device class.

CTC

The channel-to-channel device class.

DASD

The DASD device class. This device class name represents the MIH.

GRAF

The graphics device class.

TAPE

The tape drive device class.

UREC

The unit record device class.

USnn

A user-specified device class, where nn can be any two-digit number from 01 through 99 that matches a device group created by MIH or I/O timing processing. A user-specified device group is a set of devices associated with a specific time interval. The system creates this type of group and assigns the user class number (USnn) when either of the following is true:

- The MIH time interval is not equal to the time interval of its device class.

Note that some devices present their own MIH timeout values, via the primary/secondary MIH timing enhancement contained in the self-describing data for the device. If the primary MIH timeout value for the device does not equal the timeout value for the device class and the device's timeout value has not been altered by the user, the system will create a user-specified class to contain the timeout value for the device. The user-specified class for these devices will be created at IPL (if the device is defined to be ONLINE) or at VARY ONLINE time.

- The IOT time interval is not equal to the time interval of its device class.

Other time intervals that you can specify for *class* are:

HALT

Specifies the time interval for halt (HSCH) and clear (CSCH) subchannel operations. Setting this device-independent keyword affects all devices on the system.

IOTDASD

Specifies the I/O timing (IOT) time interval for the DASD device class. The maximum I/O timing limit is 5,999 seconds.

Note: Paging devices are not supported for I/O timing.

IOTTAPE

Specifies the I/O timing (IOT) time interval for the TAPE device class. The maximum I/O timing limit is 5,999 seconds. Consult the vendor of your tape device for recommendations when using this keyword.

Note: I/O timing for TAPE requires the use of the MSGONLY=YES parameter because full I/O timing support is not available.

MNTS

Specifies the time interval for monitoring "mount pending" conditions for DASD and TAPE drives.

STND

Specifies the MIH time interval for all of the following device classes: CHAR, COMM, CTC, GRAF, TAPE, and UREC.

If you code STND following any of those class names, the value for STND overrides the values for those device classes. Similarly, if you code any of those class names following STND, the values for those device classes override the value for STND.

Note: During IOS recovery processing, the system will override your time interval specification and may issue MIH messages and MIH logrec error records at this IOS-determined interval.

MIH,MOUNTMSG={YES or NO}

Indicates whether or not the system is to display the mount pending messages. Specify YES to have the message displayed; specify NO to suppress the message display.

Default: NO

MIH,DEV=([/devnum[, [/devnum]...[, [/lowdevnum-[/highdevnum]...])

The specific device identified by a device number, *devnum*, or all devices in the range of *lowdevnum-highdevnum*. A device number is 3 or 4 hexadecimal digits, optionally preceded by a slash (/).

MIH,TIME=mm:ss

Specifies the time interval in the form *mm:ss*, where *mm* is minutes and *ss* is seconds. The value range for *mm* is 00-99 and for *ss* is 00-59.

When you set TIME to 00:00, MIH no longer monitors the device.

If you specify TIME, you must also specify DEV. The system accepts only one pair of TIME and DEV keywords per command line.

MIH,IOTIMING=mm:ss

Specifies the I/O timing limit in the form *mm:ss*, where *mm* is minutes and *ss* is seconds. The value range for *mm* is 00-99, and for *ss* is 00-59. The maximum I/O timing limit is 5,999 seconds. When IOTIMING is set to 00:00, I/O timing is not in effect for that device or range of devices.

SETIOS command

Note: Do not modify the I/O timing limits without first checking with your system programmer.

If you specify IOTIMING, you must also specify DEV. The system accepts only one pair of IOTIMING and DEV keywords per command line.

Note: If the identified device is a TAPE device, MSGONLY=YES is also required because full I/O timing support is not available. Consult the vendor of your tape device for recommended settings when using IOTIMING with TAPE devices.

MIH,MSGONLY={YES or NO}

Specifies whether an I/O timeout condition is processed using message-only recovery (MSGONLY=YES) or full I/O timing recovery (MSGONLY=NO).

Message-only processing allows the system to detect I/O timeout conditions while providing the user the ability to decide which I/O requests the system should terminate.

When an I/O request exceeds the I/O timing interval, the system issues a message to the operator and writes a record to SYS1.LOGREC. Then,

1. When MSGONLY=YES is specified, the I/O request is left in the system.
2. When MSGONLY=NO is specified, the system abnormally terminates the I/O request.

The default, when you do not specify MSGONLY, is MSGONLY=NO. The system applies this only to devices it modifies as a result of this command.

If a command contains more than one MSGONLY keyword, the system uses only the last valid MSGONLY keyword.

The MSGONLY keyword is valid only when you specify the IOTDASD keyword or the DEV and IOTIMING keywords. Otherwise, the system ignores MSGONLY. That is, the MSGONLY keyword value relates only to devices affected by the IOTDASD or the DEV and IOTIMING keywords.

MIH,IOTHSWAP={YES or NO}[,IOTTERM={YES or NO}]

Specifies how an I/O timeout condition is handled with respect to HyperSwap processing.

IOTHSWAP indicates whether an I/O timing timeout condition is allowed to trigger a HyperSwap. IOTTERM indicates whether a timed-out I/O operation should be terminated with permanent error when a HyperSwap has been triggered for the I/O timing timeout condition.

The IOTTERM keyword is valid only when you specify the IOTHSWAP keyword on the same command.

Note: An I/O timeout does not trigger a GDPS® HyperSwap when message-only recovery is specified for the device or as the result of a timeout condition specified by an I/O driver program.

DCM={ON or OFF or REFRESH}

Specifies that dynamic channel path management is to be turned on or off. If REFRESH, then a control unit model table update will be initiated.

MIDAW={YES or NO}

Specifies whether the modified indirect addressing word (MIDAW) facility is enabled or disabled on a system. When disabling with MIDAW=NO, the MIDAW facility will remain in effect for one minute to allow queued I/O using MIDAWs to finish.

FICON,STATS={YES or NO}

Specifies whether FICON switch statistics are to be gathered on a system. When specifying FICON,STATS=NO, turn off FICON Director Activity Reporting in Resource Measurement Facility (RMF) in order to avoid the possibility of inconsistent report data.

FICON,FABRICPRTY={YES or NO}

Specifies whether FICON fabric I/O priority should be used within the system.

CAPTUCB,PROTECT={YES or NO}

Specifies whether to enable write protection on captured UCBs.

STORAGE,IOSBLKS={24 or 31}

Use this command to enable 24 or 31-bit storage for IOS blocks.

Note: To use this command, set the IOS Address Space (IOSAS) as a TRUSTED address space.

HYPERPAV={NO or YES or BASEONLY}

Specifies the use of HyperPAV mode. Use of this keyword changes the mode of operation of HYPERPAV-capable DASD control units to the requested mode.

HYPERPAV=NO

Specifies that HyperPAV mode is not to be used.

HYPERPAV=YES

Specifies that HyperPAV mode is to be used.

HYPERPAV=BASEONLY

Specifies that I/O is to be run only on non-PAV-alias devices in HyperPAV mode.

If the HYPERPAV keyword is not specified, the current HYPERPAV setting is not altered.

Note:

1. Using SETIOS HYPERPAV to change the mode of operation of all DASD control units on the system can take considerable time, depending on how many control units are configured on the system. This operation, if required, should be done during periods of lower system utilization, and should be done without concurrent IODF or microcode changes affecting the control unit.
2. If all devices in a logical control unit (LCU) are offline at IPL, SETIOS HYPERPAV mode changes will only take effect after a device on that LCU is varied online.
3. If a dynamic ACTIVATE and a SETIOS affect the devices on the same control unit, the aliases might not be converted to the correct mode. To detect this condition, use the D M=DEV command and examine the output. To correct the problem, issue VARY *bbbb* ONLINE,UNCOND where *bbbb* is a base device on the affected control unit. For more information about the error condition and how to correct it, see "Placing an I/O device or a range of I/O devices online or offline" on page 941.
4. SETIOS HYPERPAV is not supported when running MVS as a VM guest.

EKM,PRIMARY=

Specifies the hostname or IP address and port number of the primary key manager. The primary host is used exclusively until a failure is encountered and all attempts to retry are unsuccessful. In subsequent requests after a

SETIOS command

failure, the primary will be retried before the use of the secondary is attempted. When a connection to the primary is re-established normal operation continues.

Note: In-band tape encryption requires that the IOS address space has security permission for a USS segment. The USS segment is only for TCP/IP connectivity. UID(0) or super user ability is not required. For example, for RACF environments, issue:

```
ADDUSER IOSAS OMVS(UID(XXXX) HOME('/'))
```

where *xxxx* is a unique user id.

host_name[:*port* or ,**PRIPORT**=*port*]

The host name of the encryption key manager.

port

The port number of the encryption key manager. If you include a port number, use a colon to separate it from the host name or IP address. Its specification is mutually exclusive with the **PRIPORT**= keyword. If *port* and **PRIPORT**= keyword are both not specified, a value of 3801 is the default port number.

PRIPORT=*port*

Specifies the port number for the hostname or IP address for the primary key manager. **PRIMARY**= must be specified for **PRIPORT**= to be valid.

Default: 3801 (if not specified on the **PRIMARY** keyword)

ipv4_address[:*port* or ,**PRIPORT**=*port*]

The IP address of the encryption key manager. IP addresses must be specified as a dotted decimal quad *ddd.ddd.ddd.ddd*.

port

The port number of the encryption key manager. If you include a port number, use a colon to separate it from the host name or IP address. Its specification is mutually exclusive with the **PRIPORT**= keyword. If *port* and **PRIPORT**= keyword are both not specified, a value of 3801 is the default port number.

PRIPORT=*port*

Specifies the port number for the hostname or IP address for the primary key manager. **PRIMARY**= must be specified for **PRIPORT**= to be valid.

Default: 3801 (if not specified on the **PRIMARY** keyword)

ipv6_address [,**PRIPORT**=*port*]

The IP address of the encryption key manager in IPv6 format (for example, ::FFFF:127.0.0.1). The optional port number for an IPv6 address must be specified with the **PRIPORT**= keyword.

PRIPORT=*port*

Specifies the port number for the hostname or IP address for the primary key manager. **PRIMARY**= must be specified for **PRIPORT**= to be valid.

Default: 3801 (if not specified on the **PRIMARY** keyword)

NONE

No encryption key manager is specified. **NONE** is the default option.

EKM,SECONDARY=

Specifies the hostname or IP address and port number of the secondary key manager.

Note: In-band tape encryption requires that the IOS address space has security permission for a USS segment. See EKM,PRIMARY= parameter description for more information.

host_name[:*port* or ,SECPORT=*port*]

The host name of the encryption key manager.

port

The port number of the encryption key manager. If you include a port number, use a colon to separate it from the host name or IP address. Its specification is mutually exclusive with the SECPORT= keyword. If *port* and SECPORT= keyword are both not specified, a value of 3801 is the default port number.

SECPORT=*port*

Specifies the port number for the hostname or IP address for the secondary key manager. SECONDARY= must be specified for SECPORT= to be valid.

Default: 3801 (if not specified on the SECONDARY keyword)

ipv4_address[:*port* or ,SECPORT=*port*]

The IP address of the encryption key manager. IP addresses must be specified as a dotted decimal quad ddd.ddd.ddd.ddd.

port

The port number of the encryption key manager. If you include a port number, use a colon to separate it from the host name or IP address. Its specification is mutually exclusive with the SECPORT= keyword. If *port* and SECPORT= keyword are both not specified, a value of 3801 is the default port number.

SECPORT=*port*

Specifies the port number for the hostname or IP address for the secondary key manager. SECONDARY= must be specified for SECPORT= to be valid.

Default: 3801 (if not specified on the SECONDARY keyword)

ipv6_address [,SECPORT=*port*]

The IP address of the encryption key manager in IPv6 format (for example, ::FFFF:127.0.0.1). The optional port number for an IPv6 address must be specified with the SECPORT= parameter.

SECPORT=*port*

Specifies the port number for the hostname or IP address for the secondary key manager. SECONDARY= must be specified for SECPORT= to be valid.

Default: 3801 (if not specified on the SECONDARY keyword)

NONE

No encryption key manager is specified. NONE is the default option.

EKM,MAXCONN=*ddl*

Specifies the maximum number of concurrent socket connections for

SETIOS command

encryption key management. If in the situation of high network stress due to high socket utilization for encryption key management this number can be lowered.

Value range: 1-255

Default: 255

EKM,MAXPCONN=dd2

Specifies the maximum number of permanent concurrent socket connections for encryption key management. The permanent connections remain open to prevent the overhead of opening and closing socket communication.

Value range: 0- the number specified in MAXCONN

Default: 8

RECOVERY,LIMITED_RECTIME=ss

Specifies the time in seconds to be used for certain IOS recovery functions. Specify 0 second to disable the recovery function. If the recovery function is disabled, IOS continues to use its predefined value to monitor the IOS recovery I/O completion. The recovery function is disabled by default.

Value range: 2-14 (seconds)

RECOVERY,DEV={DASD or IOTIMING}

Specifies the devices that will exploit the recovery function. Valid options are DASD or IOTIMING:

DASD

All DASD devices.

IOTIMING

Only the devices that have the IOTIMING facility enabled.

RECOVERY,DCCF={MESSAGE or WAIT_STATE}

Specifies the action that IOS-enabled interrupt processing will take when a no paths or intervention required condition occurs on a paging device:

MESSAGE

DCCF will be invoked to issue the IOS115A WTOR.

WAIT_STATE

Non-restartable wait state X'140' will be loaded.

RECOVERY,PATH_SCOPE={CU or DEVICE}

Specifies whether the scope of the path recovery is for all devices attached to the control unit (CU) or on a device-by-device basis (DEVICE).

Default: DEVICE

RECOVERY,PATH_INTERVAL=nn

Specifies the length of time to monitor for channel path errors in minutes. This keyword can only be used when PATH_SCOPE=CU is specified or when PATH_SCOPE=CU is the current value for the scope of the path recovery.

Value Range: 1-10 (minutes)

Default: 10

RECOVERY,PATH_THRESHOLD=nnn

Specifies the minimum number of channel path-related errors that must occur every minute for the specified period of time (PATH_INTERVAL) before IOS takes action. This keyword can only be used when

PATH_SCOPE=CU is specified or when PATH_SCOPE=CU is the current value for the scope of the path recovery.

Value Range: 1-100 (errors)

Default: 10

ZHPF={YES or NO}

Specifies whether the High Performance FICON for z Systems (zHPF) facility is enabled or disabled on a system.

Default: NO

HYPERWRITE={YES or NO}

Indicates whether IBM zHyperWrite data replication should be enabled or disabled on a system-wide basis.

Note: Certain exploiting applications, such as DB2, may also provide their own controls to enable or disable the use of this function.

IBM zHyperWrite processing can be used by I/O drivers, such as Media Manager, for certain write I/O operations to perform software mirroring to peer-to-peer remote copy (PPRC) devices that are monitored for HyperSwap processing (with GDPS or TPC-R). IBM zHyperWrite data replication can be used to reduce latency in these HyperSwap environments. In order to have maximum benefit, IBM zHyperWrite data replication should only be used when all synchronously mirrored relationships are managed by HyperSwap. Devices support IBM zHyperWrite data replication when the following conditions are true:

- The devices support IBM zHyperWrite data replication. Both the primary and secondary devices in a synchronous PPRC relationship must support this function.
- The devices in the synchronous PPRC relationship are managed by HyperSwap (either GDPS HyperSwap or TPC-R HyperSwap).

YES

IBM zHyperWrite data replication is to be enabled system-wide.

NO IBM zHyperWrite data replication is to be disabled.

Default: YES

Notes:

1. You can specify more than one parameter as long as the length of the command does not exceed 124 characters.
2. The SET IOS, SETIOS, and DISPLAY IOS commands cannot run concurrently. The system processes the first command only.

Example 1

Change the setting of several classes:

```
SETIOS MIH,CTC=01:00,STND=04:00,DASD=00:10,HALT=00:08,TAPE=05:00
```

This command sets time intervals as follows:

- CHAR, COMM, CTC, GRAF, and UREC device classes: 4 minutes, 0 seconds
- DASD device class: 0 minutes, 10 seconds
- HSCH and CSCH I/O instructions: 0 minutes, 8 seconds for all devices in the system

SETIOS command

- TAPE device class: 5 minutes, 0 seconds

Note that the value for the CTC device class is 4:00, because the value specified for STND overrides the value specified for CTC (STND is coded after CTC on the SETIOS MIH command). However, the value for the tape device class is 5:00, because the value specified for TAPE overrides the value specified for STND. (TAPE is coded after STND on the SETIOS MIH command.)

All other classes remain unchanged.

Example 2

Change the setting of one class and an option:

```
SETIOS MIH,UREC=02:00,MOUNTMSG=YES
```

This command sets a time interval of 2 minutes, 0 seconds for unit record devices, and specifies that the system should display all mount pending messages. Time intervals for all classes other than UREC remain unchanged.

Example 3

Change the setting of one device with a 4-digit device number:

```
SETIOS MIH,DEV=/4472,TIME=01:10
```

This command sets an MIH time interval of 1 minute, 10 seconds for device 4472. All other classes remain unchanged.

Example 4

Create a user class for a device range:

```
SETIOS MIH,DEV=(431-435),TIME=00:45
```

This sets an MIH time interval of 45 seconds for devices 431 through 435. All other classes remain unchanged.

Example 5

To set the I/O timing limit to 2 minutes and 30 seconds for device 008, enter:

```
SETIOS MIH,DEV=008,IOTIMING=02:30
```

Example 6

Establish an I/O timing limit of 10 minutes for all non-paging DASD devices. Also, establish message-only processing for all DASD devices.

```
SETIOS MIH,IOTDASD=10:00,MSGONLY=YES
```

In this example, if any I/O request to any DASD device exceeds the ten minute I/O limit, the system issues a message and records the condition in SYS1.LOGREC, but does NOT abnormally terminate the request. Instead, the system retains the request. Then, if another I/O timing interval expires, the system will again issue a message and record the condition in SYS1.LOGREC.

Example 7

Establish an I/O timing limit of one minute for all non-paging DASD devices. Also, set up an I/O timing limit of thirty seconds for devices 180 through 18F.
 SETIOS MIH,IOTDASD=01:00,DEV=(180-18F),IOTIMING=00:30

Note in this example that because MSGONLY is not specified, if I/O timing message-only processing had previously been active on any device this SETIOS command is processing, message-only processing will be reset and full I/O timing recovery will now occur.

Example 8

Delete a device-specific time interval setting. Assume that the MIH time interval for DASD class is 15 seconds, and the MIH time interval for a DASD device 0411 is 31 seconds. Issuing DISPLAY IOS,MIH produces the following display:

```
IOS086I 12.58.49 MIH AND IOT TIMES 988
MOUNTMSG = NO,          HALT=00:05, MNTS=03:00, UREC=03:00,
DASD=00:15, TAPE=03:00, GRAF=03:00, CTC =03:00, COMM=03:00,
CHAR=03:00, IOTDASD=00:00,
US01=00:30 UDEV=0184, 02E0, 02E4, 02E5, 02E6, 02E7, 02E8, 02E9,
US02=00:31 UDEV=0411, 0412, 0413, 0414, 0415, 0416, 0417, 0710.
```

Change the MIH interval for device 0411 to be equal to that of the DASD class:

```
SETIOS MIH,DEV=0411,TIME=00:15
```

As a result the MIH setting for device 0411 is deleted. Issuing DISPLAY IOS,MIH produces the following display:

```
IOS086I 13.07.28 MIH AND IOT TIMES 994
MOUNTMSG = NO,          HALT=00:05, MNTS=03:00, UREC=03:00,
DASD=00:15, TAPE=03:00, GRAF=03:00, CTC =03:00, COMM=03:00,
CHAR=03:00, IOTDASD=00:00,
US01=00:30 UDEV=0184, 02E0, 02E4, 02E5, 02E6, 02E7, 02E8, 02E9,
US02=00:31 UDEV=0412, 0413, 0414, 0415, 0416, 0417, 0710, 0711.
```

SETLOAD command

The SETLOAD command allows you to switch dynamically from one parmlib concatenation (logical parmlib) to another without having to initiate an IPL. The SETLOAD command also allows you to replace static system symbol definitions in your current system symbol table without an IPL. The SETLOAD command specifies the LOADxx member that contains the PARMLIB or IEASYM statements to use for the switch.

Syntax

The complete syntax for the SETLOAD command is:

```
SETLOAD {xx|IPL},{PARMLIB|IEASYM}[, {DSNAME|DSN}=dsn] [, {VOLUME|VOL|VOLSER}=vol]
```

Parameters

The parameters are:

xx Specifies the one or two character suffix used to identify the LOADxx member that you want to process.

SETLOAD command

IPL

Indicates that the information from the LOADxx member used during system IPL is to be used:

- Use the same LOADxx suffix that was used during IPL.
- Locate the member using the same data set on which LOADxx was located during IPL, unless overridden by the DSNNAME keyword.
- Locate the member using the same volume on which LOADxx was located during IPL, unless overridden by the DSNNAME and VOLUME keywords.

PARMLIB

Specifies that the system is to process the PARMLIB statements in the LOADxx member according to the filter parameters (HWNAME, LPARNAME, VMUSERID). For more information on filter parameters, see the LOADxx member in *z/OS MVS Initialization and Tuning Reference*.

IEASYM

Specifies that the system is to process the static system symbol definitions identified by the IEASYM statement of the LOADxx parmlib member located by the parmlib concatenation or by the optional dsname and volume specifications according to the filter parameters (HWNAME, LPARNAME, VMUSERID). The resulting system symbol table replaces the one that is in use by this system. No updates are sent to remote systems, so JES and ARM processing on remote systems on behalf of this system will continue to use the original system symbol table they received when this system was IPLed. If the IEASYM statement does not contain a valid suffix list, the system processes as if the member IEASYM?? had been specified, and issues a message that member IEASYM?? was not found. For more information on system symbols and the IEASYM statement, see the *z/OS MVS Initialization and Tuning Reference*.

DSNAME or DSN =dsn

Specifies the 1 to 44 character name of the data set where the LOADxx member resides.

- When xx is specified, the default is to locate the LOADxx member specified in a data set within the existing parmlib concatenation.
- When **IPL** is specified, the default is to use the data set that was used during IPL to locate the LOADxx member.

VOLUME or VOL or VOLSER =vol

Specifies the 1 to 6 character serial number identifier of the volume where the specified data set resides.

- When xx is specified, the default is to locate the data set by the volume information in the master catalog.
- When **IPL** is specified, the default is to use the volume that was used during IPL to locate the LOADxx member.

Notes:

1. After the parmlib changes, the DISPLAY PARMLIB command will no longer show either the master JCL or any errors that occurred during the IPL.
2. When a SETLOAD command fails, messages issued by IEFPRMLB (logical parmlib service) that contain job name and step name will contain Master's job name and the step name of the last step that ran under Master. This is because the SETLOAD command runs under Master but does not run as its own step. In this case the error is related to the SETLOAD processing, *not* the step whose name appears in the message.

Example 1

Dynamically change the parmlib concatenation, then:

```
SETLOAD 02,PARMLIB
```

This command tells the system to process the PARMLIB statements in member LOAD02, which resides in a data set in the existing parmlib concatenation.

Example 2

```
SETLOAD 03,PARMLIB,DSN=sys4.re1son
```

This command tells the system to process the PARMLIB statements in member LOAD03. Member LOAD03 resides in the data set sys4.re1son which is catalogued in the master catalog.

Example 3

```
SETLOAD 04,PARMLIB,DSN=sys5.re1son,VOL=123456
```

This command tells the system to process the PARMLIB statements in member LOAD04. Member LOAD04 resides in the data set sys5.re1son which can be located on volume 123456.

Example 4

```
SETLOAD 02,IEASYM,DSN=sys2.re1son,VOL=123456
```

This command tells the system to process the IEASYM statement in member LOAD02. Member LOAD02 resides in the data set sys2.re1son which can be located on volume 123456. These updates to the system symbol table will occur only on this system.

SETLOGR command

Use the SETLOGR command to control z/OS MVS system logger resources. Table 52 summarizes the information that the SETLOGR command provides. Use it to access the pages on which you can find details about a particular use of the SETLOGR command.

Table 52. Summary of the SETLOGR command

Command:	Topic:
SETLOGR CTRACE	"SETLOGR CTRACE command" on page 688
SETLOGR FORCE	"SETLOGR FORCE command" on page 689
SETLOGR MANAGE	"SETLOGR MANAGE command" on page 695
SETLOGR MONITOR	"SETLOGR MONITOR command" on page 697
SETLOGR ZAI	"SETLOGR ZAI command" on page 700

Scope in a Sysplex

The following table describes the conditions under which the SETLOGR command has sysplex scope. See "Using commands that have sysplex scope" on page 12 for an explanation of sysplex scope.

SETLOGR command

Table 53. Sysplex Scope for the SETLOGR Command

Command:	Topic:
SETLOGR FORCE, DELETE,LSNAME=	Has sysplex scope because it removes the named log stream from the LOGR couple data set (CDS).

Syntax

The syntax for each variation of the SETLOGR command is shown immediately preceding its respective parameter description.

SETLOGR CTRACE command

Use the SETLOGR CTRACE command to modify the system logger IXGCNFxx parmlib CTRACE parameter pertaining to the z/OS system logger component trace activities. The command is useful for providing tracing options for system logger other than those in default member CTILOG00.

As part of the SETLOGR command, system logger may issue a TRACE CT or a DISPLAY LOGGER command. See *z/OS MVS Setting Up a Sysplex Define* authorization for the system logger address space for required SAF authority.

Before changing the TRACE options, consider issuing a D TRACE,COMP=SYSLOGR command to see what options are currently in effect. Since logger converts the input to a TRACE CT,ON,COMP=SYSLOGR,PARAM=CTnLOGxx command, look at the syslog for IEE538I or other error messages to verify the options specified in the parmlib member are accepted. For more information about viewing (D TRACE) the current system logger trace settings and specifying new options for the system logger (SYSLOGR) component trace, see *z/OS MVS System Commands* and *z/OS MVS Diagnosis: Tools and Service Aids*.

Syntax

Table 54. SETLOGR CTRACE command

SETLOGR CTRACE(parmlib_member_name)

Parameters

The parameters for SETLOGR CTRACE are:

CTTRACE(parmlib_member_name)

Specifies the member of SYS1.PARMLIB that contains the options to be used by the z/OS system logger for (SYSLOGR) component tracing. You can specify a CTnLOGxx parmlib member name.

See *z/OS MVS Initialization and Tuning Reference* for more details on the system logger CTRACE statement in SYS1.PARMLIB member IXGCNFxx. For information about coding the component tracemember of SYS1.PARMLIB, see

Value Range: The 8 character member name must be in the format CTnLOGxx where:

- n** An alphanumeric character to specify the source of the member. IBM-supplied members will use "I".
- xx** Any two characters.

Example 1, SETLOGR CTRACE(CTILOGNO):

Modify the system logger (SYSLOGR) component trace as defined in SYS1.PARMLIB member CTILOGNO, and then check on the trace options being used with a Display TRACE command.

SETLOGR CTRACE (CTILOGNO):

```

SY1 IXG651I SETLOGR CTRACE COMMAND ACCEPTED
FOR LOGGER SYSTEM CONFIGURATION CHANGE
SY1 IXG731I LOGGER PARAMETER PROCESSING COMPLETED SUCCESSFULLY FOR
SETLOGR REQUEST
SY1 IXG607I 18.02.10  LOGGER DISPLAY 419 C
LOGGER PARAMETER OPTIONS
KEYWORD SOURCE VALUE
-----
CTRACE SETLOGR CTILOGNO
MONITOR OFFLOAD
WARNALLOC SET (N1) 00005
ACTIONALLOC SET (N1) 00015
WARNRECALL DEFAULT 00060
ACTIONRECALL SET (N2) 00026
SY1 ITT038I ALL OF THE TRANSACTIONS REQUESTED VIA THE TRACE CT COMMAND
WERE SUCCESSFULLY EXECUTED.
SY1 IEE839I ST=(ON,0001M,00004M) AS=ON BR=OFF EX=ON MO=OFF MT=(ON,024K)
ISSUE DISPLAY TRACE CMD FOR SYSTEM AND COMPONENT TRACE STATUS
ISSUE DISPLAY TRACE,TT CMD FOR TRANSACTION TRACE STATUS

SY1 d trace,comp=syslogr
SY1 IEE843I 18.02.40 TRACE DISPLAY 432 C
SYSTEM STATUS INFORMATION
ST=(ON,0001M,00004M) AS=ON BR=OFF EX=ON MO=OFF MT=(ON,024K)
COMPONENT MODE BUFFER HEAD SUBS
-----
SYSLOGR ON 0016M
ASIDS *NONE*
JOBNAMES *NOT SUPPORTED*
OPTIONS CONNECT,RECOVERY,SERIAL,LOGSTRM,STORAGE,DATASET
WRITER *NONE*
```

SETLOGR FORCE command

Use the SETLOGR FORCE command to clean up log stream or data set resources related to a system logger log stream. The command is useful for managing a log stream when a log stream becomes unusable. The command is also useful for causing Logger to no longer wait on a particular migrated data set being recalled. Logger will attempt to release all the related resources for the log stream or data set based on the request.

The following three cases exemplify the key situations when a log stream might be regarded as unusable:

1. If Logger is unable to recover failed-persistent connections, the log stream can be left in a failed-persistent connection state. As a result, IXCMIAPU DATA TYPE(LOGR) DELETE LOGSTREAM requests or IXGINVNT REQUEST=DELETE, TYPE=LOGSTREAM requests cannot remove the log stream and all associated resources from the logger inventory (LOGR CDS).

Symptoms to recognize this type of situation are:

- **D LOGGER,C,LSN=log-stream-name** shows number of connectors on this system equal to 0.
- **D LOGGER,L,LSN=log-stream-name** shows number of connectors to the log stream greater than 0.

SETLOGR command

If both of these symptoms are present, the log stream has failed-persistent connections and a SETLOGR FORCE,DELETE operation may be necessary to delete the log stream.

2. A log stream is left in a DISCONNECT PENDING state on a system.
Symptom to recognize this type of situation is: **D LOGGER,C,LSN=log-stream-name** shows log stream status in "disconnect pending" state.

If the log stream is in "disconnect pending" state, a SETLOGR FORCE,DISCONNECT operation may be necessary to disconnect the log stream.

3. A data set recall is held up for a significant amount of time.
Symptoms to recognize this type of situation are: message IXG281 is displayed on the console for production or test tasks, and **D LOGGER,ST,REC** shows data set recalls waiting for a significant number of seconds.

If the recall has been waiting too long, it can be forced so applications waiting on the recall request can continue. Recall requests can also hold up offloads and messages IXG310, IXG311, and IXG312 can be shown on the console. In these situations a SETLOGR FORCE,NORECALL request can be issued to stop waiting on the recall, as to allow the affected applications to continue processing.

Attention: To reduce the risk of losing data, do not force the disconnection of a logstream from a system or force the deletion of a log stream unless you understand its use in the sysplex by applications or subsystems. Note that forcing connections from a system can affect active connectors (subsystems, applications) to the named log stream.

See "SETXCF FORCE command" on page 781 to clean up resources related specifically to structures in a coupling facility. For additional information about the circumstances under which to issue the SETXCF or SETLOGR FORCE commands, see Coupling Facility Replacement and Reconfiguration Guidelines in *z/OS MVS Setting Up a Sysplex*.

Syntax

Table 55. SETLOGR FORCE command

```
SETLOGR FORCE, {DISCONNECT | DISC | DEL | DELETE | DEALLOCURDS | DEALLOC}
               ,{LSN | LSNNAME}=LogStreamName }
               {ZAIQUIESCE | ZAIQUI | ZAICONNECT | ZAICONN}
               ,{LSN | LSNNAME}=LogStreamName | ALL } }
               {NORECALL | NOREC } ,{DSN | DSNNAME}=datasetname
```

Parameters

The parameters for SETLOGR FORCE are:

DEALLOCURDS or DEALLOC

Directs the system to close and unallocate the current offload data set for the named log stream that is actively connected on the system from which you issued the command. Any advanced-current offload data sets that are allocated and/or opened on the system are also acted upon in the same manner.

The offload data sets are not deleted as part of this request. If the log stream LS_ALLOCAHEAD value is greater than zero (0), then the next log stream offload activity in the sysplex can cause the current and advanced-current offload data sets to be allocated share again.

Since the command takes effect on an actively connected log stream, any subsequent log stream offload activity that runs on the same system can cause this system to allocate (as shared) the current offload data set again and open it for moving log data from the primary/interim storage medium.

See “Managing logger log stream data sets” in *z/OS MVS Setting Up a Sysplex* for more information about offload data set handling.

DISCONNECT or DISC

Directs the system to remove (disconnect) all the connections to the named log stream on the system from which you issued the command. Note that the force connections from a system command can affect active connectors (subsystems, applications) to the named log stream. You can use the FORCE, DISCONNECT command before deleting the log stream resource from the LOGR CDS.

When active connectors exist for the log stream, on a system where the force disconnect command is directed, Logger will first quiesce the connectors' activity for the log stream and then disconnect the log stream from the system. If Logger is unable to complete the logstream disconnect on the system, it may be necessary to issue another SETLOGR FORCE,DISCONNECT command.

Issuing the SETLOGR FORCE,DISCONNECT command when an offload is being held up, or a task is not responding, and any of the following messages are present: IXG271I, IXG272E, IXG311I, IXG312E, IXG114A, IXG115A, may cause ABEND47B or other ABENDs. Respond to these messages before issuing the SETLOGR FORCE,DISCONNECT command. See *z/OS MVS Setting Up a Sysplex* for more information about these messages.

DELETE or DEL

Directs the system to force the deletion of a named log stream from the LOGR couple data set. You can use SETLOGR FORCE,DELETE only to delete a log stream with no connections or with only failed-persistent connections remaining. It may be necessary to use the SETLOGR FORCE,DISCONNECT command on systems where normal log stream disconnections are not responsive.

If you issue the SETLOGR FORCE,DELETE command and the operation is unable to continue after the log stream had already been marked in the LOGR CDS as started to be deleted, then future attempts to connect to the log stream will fail and the log stream delete operation will be re-attempted at that time.

There might be cases when FORCE DELETE completes successfully, but the system is unable to clean up the following resources:

Staging Datasets

Cleanup will be attempted if the logstream is connected to again.

Structure Connections

Cleanup will be attempted if the logstream is connected to again.

Offload Datasets

The dataset resources can be cleaned up manually, by deleting datasets identified as 'orphans' in the IXCMIAPU TYPE(LOGR) LIST Report.

LSNAME or LSN=logstreamname

Identifies the log stream resource to be acted upon.

NORECALL or NOREC

Directs system logger to stop waiting on an outstanding asynchronous recall request for the named data set. Consider using this command when any of the following messages are present: IXG281I, IXG271I, IXG272E, IXG311I, IXG312E, IXG114A, or IXG115A. Each of these messages indicates a Logger operation

SETLOGR command

(such as log stream offload) or a Logger service task may not be progressing properly. The DISPLAY LOGGER,STATUS,RECALLS command output in message IXG601I may also indicate data set recalls are not progressing. See "IXG Messages" in *z/OS MVS System Messages, Vol 10 (IXC-IZP)* for more information about these messages and commands.

If Logger is currently waiting on a recall request for the data set name when NORECALL option on the SETLOGR command is entered, then message IXG280I will not be issued indicating Logger stopped waiting for the data set recall to complete. The Logger operation that was waiting on the recall request will treat this condition as if DFSMSHsm had responded with an error for the data set recall.

Note: More than one recall request can exist for the same data set name, as revealed on the IXG601I output. For this case, each system logger operation waiting for a data set to be recalled will treat the condition as if DFSMSHsm had responded with an error.

The net result will depend upon which Logger operation was attempting to access the (migrated) data set. Log stream browse requests might receive "gap" type error conditions meaning not all the log data can be browsed (read). Log stream offload failures might also result if an offload data set was migrated and needed to continue moving log data from "interim" storage to "secondary" (DASD) storage. See *z/OS MVS System Messages, Vol 10 (IXC-IZP)* for more information.

After this command is issued, you should continue monitoring the Logger activities to ensure no unexpected behaviors occur. Particularly, watch for the log stream exploiter that may have been directly affected by the recall request not completing successfully.

If Logger is not currently waiting on a recall for the data set, then the appropriate messages will be issued indicating the command has been completed. The command will have no effect on Logger's processing.

DSNAME or DSN=datasetname

Identifies the target log stream data set name resource.

ZAIQUIESCE or ZAIQUI

Directs system logger to quiesce connection activity to the IBM zAware server for z/OS IBM zAware log stream client(s) on the target z/OS image. When a specific log stream is named on the LSN=keyword and when the log stream has the ZAI=YES specification, then the log stream will be marked as 'QUIESCED', and it will be disconnected from the IBM zAware server if connected. No z/OS IBM zAware log stream client data will be maintained for the log stream while in the quiesced (socket disconnected) state, meaning the buffers holding the log data for this purpose will be released (freed).

When the ALL keyword is specified with the ZAIQUIESCE option, then any log streams with the ZAI=YES specification that currently have log stream connections on the target z/OS image will be placed in the 'QUIESCED' state as described above. In addition, the z/OS IBM zAware log stream client manager state will be set as 'NOT AVAILABLE'. Any log streams subsequently connected on this system with the ZAI=YES specification will also be placed in the 'QUIESCED' state.

When the z/OS IBM zAware log stream client manager state changes to 'AVAILABLE', as a result of a SETLOGR FORCE,ZAICONNECT command, then any log streams that are newly connected to the z/OS image with the ZAI=YES specification will be allowed to attempt z/OS IBM zAware log

stream client connections with the IBM zAware server. However, any log streams that were affected by the ZAIQUIESCE,ALL command will not be allowed to connect to the IBM zAware server until the appropriate SETLOGR FORCE,ZAICONNECT command is issued for these log stream(s), or the log stream is disconnected from the z/OS image and is then newly connected after the z/OS IBM zAware log stream client manager state has been set to 'AVAILABLE'.

ZAICONNECT or ZAICONN

Directs system logger to attempt a socket connection from the z/OS image to the IBM zAware server as per the IXGCNFxx SYS1.PARMLIB ZAI specifications for the identified log stream(s). When the LSNAME keyword is used, then just the specifically named log stream will be acted upon. When the log stream's current definition for ZAI is YES, the z/OS IBM zAware log stream client manager state will be set as 'AVAILABLE' for the z/OS image along with the following actions.

When the ALL keyword is specified with the ZAICONNECT option, then the z/OS IBM zAware log stream client manager state will be set as 'AVAILABLE' for the z/OS image. Then any log stream that is connected and is currently using the ZAI=YES specification on the target z/OS image will be acted upon.

For each affected log stream, the current ZAI and ZAIDATA attributes will first be obtained from the log stream's definition (in the LOGR CDS), and then the necessary z/OS IBM zAware log stream client connect, disconnect (or a combination of both) actions will occur as follows:

When the log stream's current definition for ZAI is YES:

- and the socket connection to the IBM zAware server does not yet exist, then one will be attempted.
- and the socket connection to the IBM zAware server already exists, then logger will disconnect the z/OS IBM zAware log stream client and attempt a new socket connection to the IBM zAware server.

When the log stream's current definition for ZAI is NO:

- and the socket connection to the IBM zAware server already exists, then logger will disconnect the z/OS IBM zAware log stream client.
- and the socket connection to the IBM zAware server does not yet exist, then no additional action is required.

ALL

Identifies that all the appropriate log stream resources are to be acted upon for the command request. For the ZAIQUIESCE option, the z/OS IBM zAware log stream client manager state on the z/OS image will be set as 'NOT AVAILABLE' along with action being taken on each z/OS IBM zAware log stream client.

Examples

Example 1: SETLOGR FORCE,DISC,LSN=SYSPLEX.OPERLOG

Initial display shows the logstream is in Disconnect Pending State.

```
SY1  d logger,c,lsn=SYSPLEX.OPERLOG
SY1  IXG601I  12.42.53  LOGGER DISPLAY 459
CONNECTION INFORMATION BY LOGSTREAM FOR SYSTEM SY1
LOGSTREAM                STRUCTURE          #CONN  STATUS
```

SETLOGR command

```
-----
SYSPLEX.OPERLOG          LIST01          000001  DISCONNECT PENDING
```

```
NUMBER OF LOGSTREAMS: 000001
```

Force disconnect command is entered.

```
SY1 setlogr force,disc,lsn=SYSPLEX.OPERLOG
SY1 IXG651I SETLOGR FORCE DISCONNECT COMMAND ACCEPTED
FOR LOGSTREAM=SYSPLEX.OPERLOG
SY1 IXG661I SETLOGR FORCE DISCONNECT PROCESSED SUCCESSFULLY
FOR LOGSTREAM=SYSPLEX.OPERLOG
```

A final display command shows the logstream is no longer connected.

```
SY1 d logger,c,lsn=SYSPLEX.OPERLOG
SY1 IXG601I 12.43.15 LOGGER DISPLAY 466
CONNECTION INFORMATION BY LOGSTREAM FOR SYSTEM SY1
LOGSTREAM          STRUCTURE          #CONN  STATUS
-----
NO MATCHING INFORMATION FOUND.
```

Example 2: SETLOGR

```
FORCE,NOREC,DSN=IXGLOGR.TEST102.STREAM01.A0000000
```

Initial display shows Logger is waiting on an asynchronous data set recall for the PRODUCTION group and not waiting on any data sets for the TEST group.

```
SY1 d logger,st,rec
D LOGGER,ST,REC
IXG601I hh.mm.ss  LOGGER DISPLAY
SYSTEM  LOGGER STATUS
SYSTEM  SYSTEM  LOGGER STATUS
-----
SY1     ACTIVE
        LOGGER DATA SET RECALLS
        GROUP: PRODUCTION
        SECONDS  DATA SET NAME
        0000000024 IXGLOGR.TEST102.STREAM01.A0000000
        GROUP: TEST
        NO DATA SET RECALLS WAITING
```

Command is entered to force the norecall option for the data set.

```
SY1 setlogr force,norec,dsn=IXGLOGR.TEST102.STREAM01.A0000000
SY1 IXG601I SETLOGR FORCE NORECALL COMMAND ACCEPTED
FOR DSNAME=IXGLOGR.TEST102.STREAM01.A0000000
SY1 IXG280I IXGLOGR RECALL REQUEST STOPPED BY SETLOGR COMMAND
FOR DSN=IXGLOGR.TEST102.STREAM01.A0000000
SY1 IXG661I SETLOGR FORCE NORECALL PROCESSED SUCCESSFULLY
FOR DSNAME=IXGLOGR.TEST102.STREAM01.A0000000
```

A final display command shows that system logger is no longer waiting on an asynchronous data set recall.

```
SY1 d logger,st,rec
D LOGGER,ST,REC
IXG601I hh.mm.ss  LOGGER DISPLAY
SYSTEM  LOGGER STATUS
SYSTEM  SYSTEM  LOGGER STATUS
-----
SY1     ACTIVE
        LOGGER DATA SET RECALLS
        GROUP: PRODUCTION
        NO DATA SET RECALLS WAITING
        GROUP: TEST
        NO DATA SET RECALLS WAITING
```

Example 3: SETLOGR FORCE,ZAIQUI,ALL

Force all z/OS IBM zAware log stream clients on the system to quiesce, meaning disconnect and free buffers.

```
SY1 SETLOGR FORCE,ZAIQUI,ALL
SY1 IXG651I SETLOGR FORCE ZAIQUIESCE COMMAND ACCEPTED
FOR ALL LOGSTREAMS
SY1 IXG371E ZAI LOGSTREAM CLIENT MANAGER UNAVAILABLE.
REASON: SETLOGR COMMAND REQUEST.
SY1 IXG382I ZAI LOGSTREAM CLIENT QUIESCED
FOR LOGSTREAM SYSPLEX.OPERLOG
REASON: SETLOGR COMMAND REQUEST.
```

Example 4: SETLOGR FORCE,ZAICONN,LSN=SYSPLEX.OPERLOG

Force a z/OS IBM zAware log stream client socket connection attempt, if not already connected, for the SYSPLEX.OPERLOG log stream from the target system to the IBM zAware server for the current ZAI IXGCNFxx parmlib options.

```
SY1 SETLOGR FORCE,ZAICONN,LSN=SYSPLEX.OPERLOG
SY1 IXG651I SETLOGR FORCE ZAICONNECT COMMAND ACCEPTED
FOR LOGSTREAM=SYSPLEX.OPERLOG
SY1 IXG380I ZAI LOGSTREAM CLIENT ESTABLISHED
FOR LOGSTREAM SYSPLEX.OPERLOG
```

SETLOGR MANAGE command

Use the SETLOGR MANAGE command to modify specific system logger IXGCNFxx parmlib parameters that pertain to the z/OS system logger resource management policy on a system. The command is useful for providing options for system logger to manage log stream offload data sets. See *z/OS MVS Initialization and Tuning Reference* for more information about the system logger MANAGE statement in SYS1.PARMLIB member IXGCNFxx.

As part of the SETLOGR command, system logger might issue a DISPLAY LOGGER command. See “Define authorization for the system logger address space” in *z/OS MVS Setting Up a Sysplex* for required SAF authority.

Before changing the MANAGE options, consider issuing a D LOGGER,IXGCNF[,MANAGE] command to see what options are currently in effect. See each of the following parameter descriptions for any restrictions on or special considerations for changing the parameter value with the SETLOGR MANAGE command.

Syntax

Table 56. SETLOGR MANAGE command

SETLOGR MANAGE,	
{ OFFLOAD	}
{ [,ALLOCAHEAD(YES NO)]	}
{ LOGRCDS	}
{ [,ALLOWACCESS(YES)]	}

Parameters

The parameters for SETLOGR MANAGE are:

MANAGE

Identifies the system logger resource management policy on a system.

SETLOGR command

OFFLOAD

Identifies the system logger policy on the system that manages log stream offload activity. See “Offloading log data from interim storage by freeing and/or moving it to DASD” in *z/OS MVS Setting Up a Sysplex* for more information about logger offload processing.

ALLOCAHEAD(YES|NO)

Specifies whether the system will proactively manage advanced-current offload data sets for log streams that are defined with an LS_ALLOCAHEAD value that is greater than zero (0). See “Offloading log data from interim storage by freeing and/or moving it to DASD” in *z/OS MVS Setting Up a Sysplex* for more information about the logger behavior that is based on the ALLOCAHEAD and LS_ALLOCAHEAD parameters.

The following options are possible:

YES Indicates that the system will proactively manage advanced-current log stream offload data sets for log streams that are defined with an LS_ALLOCAHEAD value that is greater than zero (0) and are connected on the system in order to keep the log stream more readily available.

NO Indicates that the system will not proactively manage advanced-current log stream offload data sets for log streams that are connected on the system. Access to any new or existing offload data sets to be used to move log data from the primary/interim storage to DASD is managed on the system only as needed on an on-demand basis. This means that the system will only allocate and open the actual current offload data set when it is explicitly needed for an offload activity to move log data to DASD on this system.

You can use the Display `LOGGER,IXGCNF[,MANAGE]` command to view the system logger configuration parameter settings.

LOGRCDS

Specifies the system logger policy on the system that manages access to the LOGR couple data set (CDS). See “Prevent a z/OS image from accessing LOGR couple data sets” in *z/OS MVS Setting Up a Sysplex* for more information about LOGR CDS management.

ALLOWACCESS(YES)

Specifies whether the particular system will make use of LOGR couple data sets when they are presented to system logger by the Cross-system Coupling Facility (XCF) component. System logger requires the use of at least the primary LOGR couple data set to perform its operations. However, some z/OS images within the sysplex should not have any access to these couple data sets.

The following options are possible:

Note: The NO option is not supported on the SETLOGR command for the ALLOWACCESS keyword.

YES Indicates that system logger should make use of the LOGR couple data sets when they are presented by XCF on the z/OS image.

If the z/OS image was restarted with the `MANAGE LOGRCDS ALLOWACCESS(NO)` specification, then specifying `ALLOWACCESS(YES)` on the SETLOGR command allows system logger to make use of LOGR couple data sets when they are made available to the sysplex, for example with subsequent SETXCF

COUPLE,TYPE=LOGR,PCOUPLE... commands. When other systems in the sysplex were already using LOGR CDSs, then IBM recommends specifying on the PCOUPLE keyword the current primary LOGR CDS. The target system of the command will use the current primary and alternate LOGR CDSs.

If the original system restart option was specified as NO and then changed through a command to YES, and if the IXGLOGR address space is later restarted, then the YES specification remains in effect.

See “Prevent a z/OS image from accessing LOGR couple data sets” in *z/OS MVS Setting Up a Sysplex* for more information about using this option.

You can use the DISPLAY LOGGER,IXGCNF[,MANAGE] command to view the system logger configuration parameter settings.

SETLOGR MONITOR command

Use the SETLOGR MONITOR command to modify specific system logger IXGCNFxx parmlib parameters pertaining to the z/OS system logger monitoring activities. The command is useful for providing options for system logger to manage log stream offload delay intervals. See *z/OS MVS Initialization and Tuning Reference* for more details on the system logger MONITOR statement in SYS1.PARMLIB member IXGCNFxx.

As part of the SETLOGR command, system logger may issue a DISPLAY LOGGER command. See *z/OS MVS Setting Up a Sysplex* Define authorization for the system logger address space for required SAF authority.

Before changing the MONITOR options, consider issuing a DISPLAY LOGGER,IXGCNF[,MONITOR] command to see what options are currently in effect. See each of the following parameter descriptions for any restrictions or special considerations for changing the parameter value with the SETLOGR MONITOR command.

Syntax

Table 57. SETLOGR MONITOR command

```
SETLOGR MONITOR,
  {OFFLOAD
    { [,WARNALLOC(initial-delay-interval)]
      { [,ACTIONALLOC(secondary-delay-interval)]
        { [,WARNRECALL(initial-delay-interval)]
          { [,ACTIONRECALL(secondary-delay-interval)]
        }
      }
    }
  {LSPRIMARY
    [,CONSUMPTIONALERT(ALLOW|SUPPRESS))]
```

Parameters

The parameters for SETLOGR MONITOR are:

MONITOR

Provide system logger monitoring specifications.

OFFLOAD

Specify the initial and secondary delay intervals for monitoring system logger log stream offload activity. See *Offload and Service Task Monitoring in z/OS MVS Setting Up a Sysplex* for more information about the logger offload monitoring.

SETLOGR command

WARNALLOC(*initial-delay-interval*)

Specifies the amount of time, in seconds, allowed before the log stream offload monitor will start issuing warning message indicating an offload is delayed waiting for a data set allocation or deletion request to complete.

If the data set allocation and/or deletion request does not complete within this interval, system logger issues message IXG3101I to warn the operator or the log stream offload being delayed.

If this value is not less than the ACTIONALLOC *secondary-delay-interval*, then logger will not issue the IXG310I warning message as part of its log stream offload monitoring.

D LOGGER,IXGCNF[,MONITOR] system logger monitoring settings.

ACTIONALLOC(*secondary-delay-interval*)

Specifies the amount of time, in seconds, allowed before the log stream offload monitor will issue messages to allow possible action be taken by the installation because of an offload being delayed waiting for a data set allocation or deletion request to complete.

If the data set allocation and/or deletion request does not complete within this interval, system logger issues messages IXG311I to identify the log stream and data set resource and WTOR message IXG312I to allow action to be taken if necessary.

D LOGGER,IXGCNF[,MONITOR] system logger monitoring settings.

WARNRECALL(*initial-delay-interval*)

Specifies the amount of time, in seconds, allowed before the log stream offload monitor will start issuing warning messages indicating an offload is delayed waiting for a migrated data set recall request to complete.

If the migrated data set recall request does not complete within this interval, system logger issues message IXG310I to warn the operator of the log stream offload being delayed.

If this value is not less than the ACTIONRECALL *secondary-delay-interval*, then logger will not issue the IXG310I warning message as part of its log stream offload monitoring.

D LOGGER,IXGCNF[,MONITOR] system logger monitoring settings.

ACTIONRECALL(*secondary-delay-interval*)

Specifies the amount of time, in seconds, allowed before the log stream offload monitor will issue messages to allow possible action to be taken by the installation because of an offload being delayed waiting for a migrated data set recall request to complete.

If the migrated data set recall request does not complete within this interval, system logger issues messages IXG311I to identify the log stream and data resource and WTOR message IXG312E to allow action to be taken if necessary.

D LOGGER,IXGCNF[,MONITOR] system logger monitoring settings.

LSPRIMARY

Specify the system options related to log stream primary storage alerts and monitoring. See *z/OS MVS Setting Up a Sysplex* for additional details.

CONSUMPTIONALERT (ALLOW|SUPPRESS)

Specifies whether log streams defined with WARNPRIMARY(YES) will issue log stream primary storage consumption alert messages on this system when the imminent threshold is exceeded or an entry threshold occurs, or for any log stream when a primary storage full consumption point is reached.

ALLOW indicates that the primary storage consumption and offload messages will be issued if the log stream is defined with the correct parameters.

SUPPRESS indicates that this system will suppress any alerts or messages, regardless of the log stream definition.

D LOGGER,IXGCNF[,MONITOR] system logger monitoring settings.

Example 1, SETLOGR MONITOR,OFFLOAD,WARNALLOC(15):

Modify the system logger WARNALLOC(initial-delay-interval) to 15 seconds on the z/OS image before warning message IXG310I is issued indicating a delay exists for a particular log stream offload.

```

SY1 SETLOGR MONITOR,OFFLOAD,WARNALLOC(15)
SY1 IXG651I SETLOGR MONITOR COMMAND ACCEPTED
FOR LOGGER SYSTEM CONFIGURATION CHANGE
SY1 IXG731I LOGGER PARAMETER PROCESSING COMPLETED SUCCESSFULLY FOR
SETLOGR REQUEST
SY1 IXG607I 17.16.59 LOGGER DISPLAY 658
LOGGER PARAMETER OPTIONS
KEYWORD          SOURCE    VALUE
-----
CTRACE           DEFAULT  CTILOG00
MONITOR OFFLOAD
WARNALLOC        SETLOGR 00015
ACTIONALLOC      DEFAULT 00060
WARNRECALL       DEFAULT 00060
ACTIONRECALL     DEFAULT 00120
SERVER IPV4      IPL (AX) 129.42.38.1
PORT             IPL (AX) 5555
LOGBUFMAX        IPL (AX) 01
LOGBUFWARN       IPL (AX) 50
LOGBUFFULL       DEFAULT  MSG

```

Example 2, SETLOGR MONITOR,OFFLOAD,ACTIONALLOC(25):

Modify the system logger ACTIONALLOC (secondary-delay-interval) to 25 seconds on the z/OS image before messages IXG311I and IXG312E are issued indicating a delay exists for a particular log stream offload and action can be taken at this time, if desired.

```

SY1 SETLOGR MONITOR,OFFLOAD,ACTIONALLOC(25)
SY1 IXG651I SETLOGR MONITOR COMMAND ACCEPTED
FOR LOGGER SYSTEM CONFIGURATION CHANGE
SY1 IXG731I LOGGER PARAMETER PROCESSING COMPLETED SUCCESSFULLY FOR
SETLOGR REQUEST
SY1 IXG607I 17.17.44 LOGGER DISPLAY 664
LOGGER PARAMETER OPTIONS
KEYWORD          SOURCE    VALUE
-----
CTRACE           DEFAULT  CTILOG00
MONITOR OFFLOAD
WARNALLOC        SETLOGR 00015
ACTIONALLOC      SETLOGR 00025
WARNRECALL       DEFAULT 00060
ACTIONRECALL     DEFAULT 00120
MONITOR LSPRIMARY
CONSUMPTIONALERT DEFAULT  ALLOW
ZAI
SERVER IPV4      IPL (AX) 129.42.38.1
PORT             IPL (AX) 5555
LOGBUFMAX        IPL (AX) 01
LOGBUFWARN       IPL (AX) 50
LOGBUFFULL       DEFAULT  MSG

```

SETLOGR command

Example 3, SETLOGR MONITOR,LSPRIMARY,CONSUMPTIONALERT(ALLOW):

Modify the system logger CONSUMPTIONALERT setting to ALLOW on the z/OS image so that log stream primary storage consumption and offload messages can be issued when log streams are also defined with the correct parameters.

```
SETLOGR MONITOR,LSPRIMARY,CONSUMPTIONALERT(ALLOW)
IXG651I SETLOGR MONITOR COMMAND ACCEPTED
FOR LOGGER SYSTEM CONFIGURATION CHANGE
IXG731I LOGGER PARAMETER PROCESSING COMPLETED SUCCESSFULLY FOR SETLOGR
REQUEST
DISPLAY LOGGER,IXGCNF,MONITOR
IXG607I 12.13.35 LOGGER DISPLAY
LOGGER PARAMETER OPTIONS
KEYWORD          SOURCE    VALUE
-----
MONITOR OFFLOAD
WARNALLOC        DEFAULT  00030
ACTIONALLOC      DEFAULT  00060
WARNRECALL       DEFAULT  00060
ACTIONRECALL     DEFAULT  00120
MONITOR LSPRIMARY
CONSUMPTIONALERT SETLOGR  ALLOW
```

SETLOGR ZAI command

Use the SETLOGR ZAI command to modify specific system logger IXGCNFxx parmlib parameters pertaining to the z/OS IBM zAware log stream client options. The command is useful for providing options for system logger to manage z/OS IBM zAware log stream client socket communication and log data buffering in order to send log stream data to the IBM zAware server. See *z/OS MVS Initialization and Tuning Reference* for more details on the system logger ZAI statement in SYS1.PARMLIB member IXCNFxx.

As part of the SETLOGR command, system logger may issue a DISPLAY LOGGER command. See *z/OS MVS Setting Up a Sysplex Define authorization* for the system logger address space for required SAF authority.

Before changing the ZAI options, consider issuing a D LOGGER,IXGCNF[,ZAI] or D LOGGER,ST,ZAI commands to see what options are currently in affect. See each of the following parameter descriptions for any restrictions or special considerations for changing the parameter value with the SETLOGR ZAI command.

Syntax

Table 58. SETLOGR MONITORCommand

SETLOGR ZAI{,SERVER(NONE host_name) IP_addr) }
{,PORT(port_num) }
{,LOGBUFMAX(value) }
{,LOGBUFWARN(nn) }
{,LOGBUFFULL(MSG QUIESCE) }

Parameters

See *z/OS MVS Initialization and Tuning Reference* for details on the system logger ZAI statement and parameter settings in SYS1.PARMLIB member IXGCNFxx. Also see *Preparing for z/OS zAware log stream client usage in z/OS MVS Setting Up a Sysplex* for details on getting Operlog log data to the IBM zAware server.

The parameters for SETLOGGER ZAI are:

SERVER({NONE | *host_name* | *IP_addr*})

Specifies the host name (as defined by domain name system, DNS) or TCP/IP location where the IBM z Advanced Workload Analysis Reporter (IBM zAware) server is running and will receive the z/OS IBM zAware log stream client data. A value of NONE indicates no IBM zAware server is desired and does not indicate a server name.

ZAI SERVER and PORT changes are not honored if there are existing socket connections to the IBM zAware server. Disconnect the applicable log streams or quiesce any existing socket connect(s) via the SETLOGR FORCE,ZAIQUIESCE command.

D LOGGER,IXGCNF[,ZAI] and D LOGGER,STatus,ZAI commands display the details on the system logger z/OS IBM zAware log stream client information

PORT(*port_num*)

Identifies the port number associated with the SERVER specification for the IBM zAware server.

ZAI SERVER and PORT changes are not honored if there are existing socket connections to the IBM zAware server. Disconnect the applicable log streams or quiesce any existing socket connect(s) via the SETLOGR FORCE,ZAIQUIESCE command.

D LOGGER,IXGCNF[,ZAI] and D LOGGER,STatus,ZAI commands display the details on the system logger z/OS IBM zAware log stream client information.

LOGBUFMAX(*value*)

Identifies the maximum amount of storage buffers (in gigabytes) to be used by system logger for managing z/OS IBM zAware log stream client data being sent to the IBM zAware server. It allows clients the ability to set a threshold (for their environment) on the amount of (pageable, above the 2 gigabyte bar) storage that can be utilized on their z/OS IBM zAware system in the case of spiking or inhibited data flow.

If the maximum for these storage buffers are used, then any new log stream data needing to be sent to the IBM zAware server will be lost. If the *value* specified for the LOGBUFMAX parameter is less than the storage buffers currently in-use, then system logger will not buffer any new log data until the buffers available are less than the new designated value. Reducing this *value* below the current in-use buffers will cause system logger to put the LOGBUFFULL policy specification into effect.

D LOGGER,IXGCNF[,ZAI] and D LOGGER,STatus,ZAI commands display the details on the system logger z/OS IBM zAware log stream client buffer usage.

LOGBUFWARN(*nn*)

Specifies the z/OS IBM zAware log stream client manager buffer warning level percentage when system logger will start issuing message IXG375E.

When the z/OS IBM zAware log stream client manager is using this percent of overall buffer space (see LOGBUFMAZ), message IXG375E will be issued. As the buffer pool is expanded/extended by the next incremental amount, system logger will issue an updated instance of IXG375E with the new buffer storage percent in use indication.

As in-use system logger z/OS IBM zAware log stream client buffers are no longer needed, the buffers will be released and messages IXG375E will be

SETLOGR command

issued for the new percent in use. Once the overall percentage of buffers in use is at least 5% below the LOGBUFWARN value, system logger will DOM message IXG375E.

D LOGGER,IXGCNF[,ZAI] and D LOGGER,STatus,ZAI commands display the details on the system logger z/OS IBM zAware log stream client buffer usage.

LOGBUFFULL({MSG|QUIESCE})

Specifies the action to be taken by system logger when the z/OS IBM zAware log stream client manager buffers become full (see LOGBUFMAX).

MSG indicates system logger should continue attempting to send log data to the IBM zAware server and keep a count of the number of log blocks that could not be buffered and were lost. When buffers become available, then message IXG383I will be issued indicating that not all the log data was sent to the IBM zAware server.

QUIESCE indicates that when system logger reaches the full amount of buffers then disconnect the socket connection to the IBM zAware server. The socket connection will remain disconnected until either a SETLOGR command (for example, SETLOGR FORCE,ZAICONNECT,ALL) or SET IXGCNF= command that has specifications to connect to the IBM zAware server. No z/OS IBM zAware log stream client data will be maintained while in the quiesced state, meaning the buffers holding the log data for this purpose will be released (freed). Logger will issue message IXG382I for each log stream that is quiesced.

D LOGGER,IXGCNF[,ZAI] and D LOGGER,STatus,ZAI commands display the details on the system logger z/OS IBM zAware log stream client buffer usage.

Example 1, SETLOGR ZAI,LOGBUFMAX(2):

Modify the system logger z/OS IBM zAware log stream client maximum to 2 gigabytes of storage on the z/OS image for buffering log data to be sent to the IBM zAware server.

```
SY1 SETLOGR ZAI,LOGBUFMAX(2)
SY1 IXG651I SETLOGR ZAI COMMAND ACCEPTED
FOR LOGGER SYSTEM CONFIGURATION CHANGE
SY1 IXG731I LOGGER PARAMETER PROCESSING COMPLETED SUCCESSFULLY FOR
SETLOGR REQUEST
SY1 IXG607I 17.19.02 LOGGER DISPLAY 670
LOGGER PARAMETER OPTIONS
KEYWORD          SOURCE    VALUE
-----
CTRACE           DEFAULT  CTILOG00
MONITOR OFFLOAD
WARNALLOC        SETLOGR  00015
ACTIONALLOC      SETLOGR  00025
WARNRECALL       DEFAULT  00060
ACTIONRECALL     DEFAULT  00120
ZAI
SERVER IPV4      IPL (AX) 129.42.38.1
PORT             IPL (AX) 5555
LOGBUFMAX        SETLOGR  02
LOGBUFWARN       IPL (AX) 50
LOGBUFFULL       DEFAULT  MSG
```

Example 2, SETLOGR ZAI,SERVER(NONE):

Modify system logger to not allow any z/OS IBM zAware log stream clients on the z/OS image. First, quiesce any existing z/OS IBM zAware log stream client socket connections to the IBM zAware server, then update the IBM zAware server information.

1. SETLOGR FORCE,ZAIQUIESCE,ALL

2. SETLOGR ZAI,SERVER(NONE)

```

SY1 SETLOGR FORCE,ZAIQUIESCE,ALL
SY1 IXG371E ZAI LOGSTREAM CLIENT MANAGER UNAVAILABLE.
REASON: SETLOGR COMMAND REQUEST.
SY1 IXG651I SETLOGR FORCE ZAIQUIESCE COMMAND ACCEPTED
FOR ALL LOGSTREAMS
SY1 IXG382I ZAI LOGSTREAM CLIENT QUIESCED
FOR LOGSTREAM SYSPLEX.OPERLOG
REASON: SETLOGR COMMAND REQUEST.

```

```

SY1 SETLOGR ZAI,SERVER(NONE)
SY1 IXG651I SETLOGR ZAI COMMAND ACCEPTED
FOR LOGGER SYSTEM CONFIGURATION CHANGE
SY1 IXG731I LOGGER PARAMETER PROCESSING COMPLETED SUCCESSFULLY FOR
SETLOGR REQUEST

```

```

SY1 IXG607I 17.20.25  LOGGER DISPLAY 683

```

```

LOGGER PARAMETER OPTIONS

```

```

KEYWORD          SOURCE    VALUE
-----

```

```

CTRACE          DEFAULT  CTILOG00

```

```

MONITOR OFFLOAD

```

```

  WARNALLOC     SETLOGR  00015

```

```

  ACTIONALLOC   SETLOGR  00025

```

```

  WARNRECALL    DEFAULT  00060

```

```

  ACTIONRECALL  DEFAULT  00120

```

```

ZAI

```

```

  SERVER        SETLOGR  NONE

```

```

  PORT          IPL (AX) 5555

```

```

  LOGBUFMAX     SETLOGR  02

```

```

  LOGBUFWARN    IPL (AX) 50

```

```

  LOGBUFFULL    DEFAULT  MSG

```

SETLOGRC command

Use the SETLOGRC command to change the logrec error and environmental recording medium originally specified in the IEASYSxx parmlib member during initial program load (IPL). You can specify one of the following options for logrec error recording:

- LOGSTREAM
- DATASET
- IGNORE

Optionally, you can specify a new name for DATASET or LOGSTREAM parameters.

After the system processes the command, depending on the specified option, one of the following results will occur:

- If the change of medium is successful, the system issues message IFB097I to indicate the change and the new medium to the requesting console.
- If the change is to DATASET:
 - If the change of medium is to DATASET and the system was not originally initialized with a data set specified as the recording medium, the system now dynamically allocates and opens the specified data set. If no data set name is provided, then logrec defaults to using SYS1.LOGREC. If the system fails to open on the logrec data set, it issues messages IFB110I and IFB112I along with message IFB099I.

SETLOGRC command

- | – If the current medium is DATASET and DATASET is requested with a new data set name, logrec closes and deallocates the old data set, then allocates and opens the new data set for logrec recording.
- | – If the current medium is LOGSTREAM and DATASET is requested, logrec disconnects from the log stream, then allocates and opens the data set for logrec recording. If problems arise when allocating the data set, logrec attempts to revert to log stream recording.
- | • If the change is to IGNORE:

| **Note:** IBM recommends that you use the IGNORE setting in testing environments only.

- | – If the current setting is IGNORE and IGNORE is requested, logrec issues message IFB096I to the invoking console to indicate that the desired medium is the current setting.
- | – If the desired setting is to IGNORE, logrec error and environmental records are not recorded and are not provided in an ENF 36 signal.
- | – If the current medium is DATASET and IGNORE is requested, logrec closes and deallocates the logrec data set.
- | – If the current medium is LOGSTREAM and IGNORE is requested, logrec disconnects from the log stream.
- | • If the change is to LOGSTREAM:
 - | – If the desired setting is to LOGSTREAM and the connection to the log stream succeeds, the system issues message IFB094I to indicate the successful change of medium from LOGSTREAM to LOGSTREAM. If the change of medium is unsuccessful, the system issues message IFB099I. The system also issues message IFB100E to indicate that the system logger is unavailable. Logrec error and environmental records are internally buffered until the system logger becomes available. The buffer can hold only a certain number of records and will wrap when that number is exceeded.
 - | – If the connection is successful or when system logger and the log stream are available for writing, logrec writes records, including any buffered records, to the log stream.
 - | – If the current medium is DATASET and LOGSTREAM is requested, logrec closes and deallocates the logrec data set, then connects to the log stream.
 - | – If the current medium is LOGSTREAM and LOGSTREAM is requested, logrec disconnects from and then reconnects to the log stream. If a new log stream name is requested, logrec disconnects from the old log stream and connects to the new log stream.

Syntax

The complete syntax for the SETLOGRC command is:

```
SETLOGRC {LOGSTREAM|DATASET|IGNORE|LOGSTREAM=lsname|DATASET=dsname}
```

| **Note:** The SETLOGRC command does not have an abbreviation. An acceptable abbreviation for LOGSTREAM is LS and for DATASET is DS.

Parameters

The parameters are:

LOGSTREAM | LS

Indicates that the desired medium for recording logrec error and environmental records is a log stream. To use a log stream, the logrec log stream must be defined. See *z/OS MVS Setting Up a Sysplex* for information about logrec log stream definitions.

Optionally, you can specify a new log stream name by setting LOGSTREAM=*lname*, where *lname* is the log stream to which you want to record logrec entries.

DATASET | DS

Indicates that the desired medium for recording logrec error and environmental records is a data set. You can change the recording medium to and from dataset at any time. This setting instructs logrec to use dynamic allocation to find the logrec data set, as long as it is cataloged. Ensure that your data set meets the preconditions of a logrec data set and is initialized through EREP. For more information about preparing the logrec data set, see *z/OS MVS Diagnosis: Tools and Service Aids* .

Optionally, you can specify a new data set name by setting DATASET=*dsname*, where *dsname* is the data set to which you want to record logrec entries. If logrec is currently recording to DATASET, the system closes the old data set and opens the new data set for processing.

IGNORE

Indicates that recording logrec error and environmental records is to be disabled.

IGNORE closes LOGSTREAM connections, then closes and deallocates DATASET resources. You can use IGNORE to perform maintenance for the logrec medium; however, logrec records are not recorded when IGNORE is in use.

SETMF command

Use the SETMF command to manage the message flood automation processing:

- Enable or disable the message flood checking.
- Enable or disable the message rate monitoring.
- Change the message flood automation parameters.
- Change the message flood automation actions.

Note: The SETMF command is used to alter the message flood automation parameters or actions. If you want the change to be permanent, you must update the parameter in a MSGFLDxx parmlib member. Changes made by SETMF command persist only until the next SET MSGFLD= command or IPL.

Syntax

The complete syntax for the SETMF command is:

```
SETMF [ON|OFF]
      [MONITORON|MONITOROFF]
      [MSGTYPE=msgtype,keyword=value[,keyword=value]]
      [MSGTYPE=msgtype,DEFAULT=action[,action]]
      [MSGTYPE={REGULAR|ACTION},JOB=jobname[,action][,action]]
      [MSGTYPE=SPECIFIC,MSG=msgid[,action][,action]]
```

Parameters

ON Enables message flood checking. The enable switch is set on and processing resumes. Messages received while message flood checking is disabled are not processed and not counted.

OFF Disables message flood checking. No values are changed and when subsequently enabled, processing resumes with the values as set at the time of the disablement command.

MONITORON

Enables the collection of message rate information.

It is recommended that you gather message rate information for at least an hour before displaying it. In general, the longer the sample, the more accurate the results. Message rate monitoring incurs more overhead than standard (non-intensive mode) message flood processing and should probably not be run all of the time. A 24-hour sample taken during a busy period every few months is probably sufficient.

The largest interval between successive messages that will be recorded by Message Rate Monitoring is 2048 seconds, or approximately 33 minutes. The smallest interval that can be recorded is 250 picoseconds.

Note: Message rate monitoring is turned off and the counters are re-initialized whenever a SET MSGFLD=xx command is issued.

MONITOROFF

Disables the collection of message rate information. Disabling the collection of message rate information does not re-initialize the information already collected.

MSGTYPE=msgtype, keyword=value [, keyword=value]

Changes one or more of the parameters associated with the specified message type. You can specify more than one keyword value pair by separating them with a comma.

msgtype specification can be: REGULAR, ACTION and SPECIFIC.

keyword specification can be: MSGTHRESH, JOBTHRESH, INTVLTIME, SYSIMTIME, JOBIMTIME, MSGLIMIT and MSGIMTIME.

The valid combinations of *msgtype* and *keyword* are:

MSGTYPE=REGULAR	MSGTYPE=ACTION	MSGTYPE=SPECIFIC
INTVLTIME	INTVLTIME	INTVLTIME
JOBIMTIME	JOBIMTIME	
JOBTHRESH	JOBTHRESH	
		MSGIMTIME
		MSGLIMIT
MSGTHRESH	MSGTHRESH	MSGTHRESH
SYSIMTIME	SYSIMTIME	SYSIMTIME

The specification is checked for syntax. If there is any error, a message is issued and no values are updated.

MSGTYPE=msgtype,DEFAULT=action[,action]

Changes the default actions that are used by message flood automation. You can specify more than one actions with a comma separating them.

This command supports the same *msgtype* and *action* specifications as the DEFAULT parmlib statement, so you can use this command to set any action that can be specified by the DEFAULT parmlib statement.

The specification is checked for syntax. If there is any error, a message is issued and no actions are updated.

MSGTYPE={REGULAR|ACTION},JOB=jobname[,action][,action]

Changes the actions that message flood automation take against jobs producing REGULAR and ACTION messages. You can specify more than one action with a comma separating them.

You can also use this command to define a new job and define specific actions for it. If the jobname that you specify is not one that message flood automation recognizes, and space is available in the jobname table, then message flood automation will add the jobname to the jobname table and take the specified actions if that job produces a message flooding situation. You can remove a jobname from the jobname table only by loading a MSGFLDxx parmlib member.

This command supports the same *jobname* and *action* specifications as the JOB parmlib statement, so you can use this command to set any action that can be specified by the JOB parmlib statement. If the command is issued during a message flood, for a jobname involved in the message flood, any change to an action specification will occur immediately except for CMD actions, which are processed only at the beginning of a message flood. If the jobname specified contains generic match characters, changes to its action specifications are not propagated to any matching jobs involved in the flood.

The specification is checked for syntax. If there is any error, a message is issued and no actions are updated.

MSGTYPE=SPECIFIC,MSG=msgid[,action][,action]

Changes the actions that message flood automation take for SPECIFIC messages. You can specify more than one action with a comma separating them.

You can also use this command to define a new message and define specific actions for it. If the msgid that you specify is not one that message flood automation recognizes, and space is available in the msgid table, then message flood automation will add the msgid to the msgid table and take the specified actions if that message is involved in a message flooding situation. You can remove a msgid from the msgid table only by loading a MSGFLDxx parmlib member.

This command supports the same *msgid* and *action* specifications as the MSG parmlib statement, so you can use this command to set any action that can be specified by the MSG parmlib statement.

SETOMVS command

Use the SETOMVS command to change dynamically the options that z/OS UNIX System Services currently is using. These options are originally set in the BPXPRMxx parmlib member during initial program load (IPL). For more information on the BPXPRMxx parmlib member, see *z/OS UNIX System Services Planning*.

SETOMVS command

Changes to all of the system-wide limits take effect immediately. When a process limit is updated, all processes that are using the system-wide process limit have their limits updated. All process limit changes take effect immediately except those processes with a user-defined process limit (defined in the OMVS segment or set with a SETOMVS PID= command). Exceptions are MAXASSIZE and MAXCPUPTIME, which are not changed for active processes.

Note: If a process-level limit is lowered with the SETOMVS command, some processes may immediately hit 100% usage. Depending on the process limit specified and what the process is doing, this could cause some processes to fail.

Syntax

The complete syntax for the SETOMVS command is:

SETOMVS	SETOMVS EXTENSIONS (sysplex exclusive)
SETOMVS [AUTHPGMLIST='authprogramlist' NONE] [,AUTOCVT=ALL ON OFF] [,MAXIOBUFUSER=maxiobufsize] [,FORKCOPY=(COPY COW)] [,IPCSEMIDS=ipcsemids] [,IPCSEMNOPS=ipcsemnops] [,IPCSEMNSEMS=ipcsemnsems] [,IPCMSGQBYTES=ipcmsgqbytes] [,IPCMSGNIDS=ipcmsgnids] [,IPCshmPAGES=ipcshmpages] [,IPCshmNIDS=ipcshmnids] [,IPCshmNSEGS=ipcshmnsesg] [,IPCshmSPAGES=ipcshmspaces] [,IPCMSGQMMNUM=ipcmsgqmmnum] [,LIMMSG=[NONE SYSTEM ALL]] [,LOSTMSG=ON OFF] [,MAXASSIZE=maxassize] [,MAXCORESIZE=maxcoresize] [,MAXCPUPTIME=maxcpuptime] [,MAXFILEPROC=maxfileproc] [,MAXFILESIZE=(maxfilesize NOLIMIT)] [,MAXMMAPAREA=maxmmaparea] [,MAXPROCSYS=maxprocsys] [,MAXPROCUSER=maxprocuser] [,MAXPTYs=maxpty] [,MAXSHAREPAGES=maxsharepages] [,MAXTHREADS=maxthreads] [,MAXTHREADTASKS=maxthreadtasks] [,MAXUIDS=maxuids] [,MAXUSERMOUNTSYS=maxusermountsys] [,MAXUSERMOUNTUSER=maxusermountuser] [,NONEMPTYMOUNTPT=NOWARN WARN DENY] [,PID=pid,processlimitname=newvalue] [,PRIORITYGOAL=(n) NONE] [,PWT=SMF SMFENV ENV] [,RESET=(xx)] [,SERV_LPALIB=('dsname', 'volser')] [,SERV-LINKLIB=('dsname', 'volser')] [,SHRLIBRGNsize=shrlibrgnsize] [,SHRLIBMAXPAGES=shrlibmaxpages] [,STEPLIBLIST='stepliblist'] [,SUPERUSER=superuser] [,SYNTAXCHECK=(xx)] [,SYSCALL_COUNTS=(YES NO)] [,TTYGROUP=TTYgroup] [,USERIDALIAstable='useridaliastable'] [,VERSION='string']	SETOMVS FILESYS ,FILESYSTEM=filesystem ,AUTOMOVE=YES NO UNMOUNT indicator(sysname1 ,sysname2, ..., sysnameN) or SETOMVS FILESYS ,FILESYSTEM=filesystem ,SYSNAME=sysname * or SETOMVS FILESYS ,MOUNTPOINT=mountpoint ,AUTOMOVE=YES NO UNMOUNT indicator(sysname1 ,sysname2, ..., sysnameN) or SETOMVS FILESYS ,MOUNTPOINT=mountpoint ,AUTOMOVE=YES NO UNMOUNT indicator(sysname1 ,sysname2, ..., sysnameN) or SETOMVS FILESYS ,MOUNTPOINT=mountpoint ,SYSNAME=sysname * or SETOMVS FILESYS ,FROMSYS=sysname ,SYSNAME=sysname * Note: 1. FILESYSTEM , FROMSYS , and MOUNTPOINT are mutually exclusive parameters. When you specify FILESYS , you must supply one of these three parameters. 2. SETOMVS RESET=(xx) has been changed to allow SETOMVS RESET=xx as well as SETOMVS RESET=(xx). The parentheses are now optional.

Rather than defining parameter limit values in their full decimal or hexadecimal form, you can use the following 1-character multiplier (denomination values) suffix to specify them. The system also uses this value in displays when it returns responses to respective D OMVS commands.

Note:

1. Only those SETOMVS that support this C suffix specifically note that support and refer to Table 59.
2. Values that **contain** a multiplier are limited to 8 digits (nnnnnnnC) and those values are limited to X'00FF FFFF' (16 777 215 decimal). Limits that support values above the bar have a range of 1M-16383P. However, do not exceed a parameter-specific maximum value.
3. Values that **do not contain** a multiplier are limited to X'7FFF FFFF' (2 147 483 647 decimal).

Table 59. 1-Character parameter limit multipliers

Denomination value	1-character abbreviation	Bytes
null	n/a	1
Kilo	K	1,024
Mega	M	1,048,576
Giga	G	1,073,741,824
Tera	T	1,099,511,627,776
Peta	P	1,125,899,906,842,624

Parameters

AUTOMOVE = YES | NO | UNMOUNT | indicator(sysname1,sysname2,...,[sysnameN | *]), FILESYS=filesys, FILESYSTEM=filesystem, FROMSYS=sysname, MOUNTPOINT=mountpoint, SYSNAME=sysname | *, and VERSION='nnnn' are parameters that are used in a sysplex environment where systems are exploiting shared file system. For more information on sharing file system in a sysplex, see *z/OS UNIX System Services Planning*.

The parameters are:

AUTOMOVE=YES | NO | UNMOUNT | indicator(sysname1,sysname2,...,sysnameN)

AUTOMOVE applies only in a sysplex where systems are participating in shared file system. These parameters indicate what happens to the ownership of the file system when a shutdown, PFS termination, dead system takeover, or file system move occurs.

AUTOMOVE=YES allows the system to automatically move logical ownership of the file system as needed. AUTOMOVE=YES is the default; you can specify it as AUTOMOVE.

AUTOMOVE=NO prevents ownership movement in some situations.

AUTOMOVE=UNMOUNT unmounts the file system in some situations.

AUTOMOVE=indicator(sysname1,sysname2,...,sysnameN) specifies a list of systems to which the ownership of file system should or should not be moved when ownership of the file system changes.

SETOMVS command

- If indicator is specified as INCLUDE (or I), the list must provide a comma-delimited, priority-ordered list of systems to which ownership of the file system can be moved. For example, AUTOMOVE=INCLUDE(SYS1, SYS4, SYS9). You can specify an asterisk (*) as the last (or the only) system name to indicate any active system. For example, AUTOMOVE=INCLUDE(SYS1, SYS4, *).

Note: Do not use an asterisk in a mixed sysplex environment where any system is not at z/OS Version 1 Release 6 or later. Doing so will produce unpredictable results. The asterisk is not supported before z/OS Version 1 Release 6.

- If indicator is specified as EXCLUDE (or E), the system list must provide a comma-delimited list of systems to which the ownership of file system must not be moved. For example, AUTOMOVE=EXCLUDE(SYS3, SYS5, SYS7).

Restriction: The AUTOMOVE parameter is not permitted when using SETOMVS to move a file system.

Guideline: To ensure that the root file system is always available, use the default AUTOMOVE value (AUTOMOVE=YES).

For more information about the behavior of the AUTOMOVE option, see *z/OS UNIX System Services Planning*.

FILESYS=filesys

In a sysplex environment, this parameter alerts the parser that commands that change mount attributes are to follow.

For examples on the use of this parameter when making move or change requests, see *z/OS UNIX System Services Planning*.

FILESYSTEM=filesystem

In a sysplex environment, **FILESYSTEM** is the 44 character alphanumeric field that denotes the name of the filesystem to be changed or moved. This filesystem name must be in the following form: 'OMVS.USER.JOE'.

Note: The filesystem name must be in quotation marks, and mixed-case filesystem names are supported.

FILESYSTEM, **MOUNTPOINT**, and **FROMSYS** are mutually exclusive parameters. For examples on the use of this parameter when making move or change requests, see *z/OS UNIX System Services Planning*.

FROMSYS=sysname

In a sysplex environment, this parameter indicates the system where all the filesystems will be moved from. The filesystems will be moved to the system identified by the **sysname** keyword. **FILESYSTEM**, **MOUNTPOINT**, and **FROMSYS** are mutually exclusive parameters.

MOUNTPOINT=mountpoint

In a sysplex environment, **MOUNTPOINT** is the mountpoint specification. For example:

```
'/usr/d1'
```

It is case sensitive. This is the mountpoint where the filesystem is mounted. If specified, the filesystem associated with this mountpoint will be moved or changed. **FILESYSTEM**, **MOUNTPOINT**, and **FROMSYS** are mutually exclusive parameters.

For examples on the use of this parameter when making move or change requests, see *z/OS UNIX System Services Planning*.

AUTHPGMLIST='authprogramlist'|NONE

Points to a z/OS UNIX file containing a list of pathnames, MVS program names, or both that allow an additional level of authorization for program-controlled or for APF-authorized programs. See *z/OS UNIX System Services Planning* for information on constructing this file. The default is NONE.

AUTOCVT=ALL|ON|OFF

Enables Unicode Services conversion (ALL), Enhanced ASCII conversion (ON), or disables coded character set conversion for the z/OS UNIX environment (OFF). The default is OFF.

FORKCOPY = COPY | COW

Specifies how user storage is copied from the parent process to the child process during a `fork()` system call.

If you specify **FORKCOPY=COW**, all `fork()` calls are processed in copy-on-write (COW) mode if the suppression-on-protection hardware feature is available. Before the storage is modified, both the parent and child processes refer to the same view of the data. The parent storage is copied to the child as soon as storage is modified, either by the parent or the child.

Using copy-on-write causes the system to use the extended system queue area (ESQA) to manage page sharing.

If you specify **FORKCOPY=COPY**, `fork()` immediately copies the parent storage to the child, regardless of whether the suppression-on-protection feature is available. Use this option to avoid any additional ESQA use in support of `fork()`.

Follow these guidelines:

- If the run-time library is in the link pack area, specify **FORKCOPY=COPY**.
- If the run-time library is not in the link pack area, specify **FORKCOPY=COW**.

If you do not specify **FORKCOPY**, the default is **FORKCOPY=COW**.

IPCSEMNIDS = ipcsemnids

Specifies the maximum number of unique semaphore sets in the system. The range is from 1 to 20 000. The default is 500.

IPCSEMNOPTS = ipcsemnops

Specifies the maximum number of operations for each semaphore operation call. The range is from 0 to 32 767. The default is 25. This is a system-wide limit.

IPCSEMNSEMS = ipcsemnsems

Specifies the maximum number of semaphores for each semaphore set. The range is from 0 to 32 767. The default is 25.

IPCMSGQBYTES = ipcmsgqbytes

Specifies the maximum number of bytes in a single message queue. The range is from 0 to 2 147 483 647. The default is 2 147 483 647.

IPCMSGNIDS = ipcmsgnids

Specifies the maximum number of unique message queues in the system. The range is from 1 to 20 000. The default is 500.

IPCshmPAGES = ipcshmPAGES

Specifies the maximum number of pages for a shared memory segment. The range is from 1 to 4P. The default is 25600.

SETOMVS command

Note: You can set a denomination (or multiplier) value when defining this value. The C suffix can have a 1-character value as presented in Table 59 on page 709, but must not exceed the parameter-specific upper limit.

MVS retains the denomination value and uses it within a subsequent D OMVS command

IPCSHMNIDS = ipcshmnids

Specifies the maximum number of unique shared memory segments in the system. The range is from 1 to 20 000. The default is 500.

IPCSHMNSEGS = ipcshmnsegs

Specifies the maximum number of shared memory segments attached for each address space. The range is from 0 to 1 000. The default is 10.

IPCSHMSPAGES = ipcshmspages

Specifies the maximum number of pages for shared memory segments in the system. The range is from 0 to 2 621 440. The default is 262 144.

Note: You can set a denomination (or multiplier) value when defining this value. The suffix, "C" can have a 1-character value as presented in Table 59 on page 709, but must not exceed the parameter-specific upper limit.

MVS retains the denomination value and uses it within a subsequent D OMVS command

IPCMSGQMNUM = ipcmsgqmnum

Specifies the maximum number of messages for each message queue in the system. The range is from 0 to 20 000. The default is 10 000.

LIMMSG=(NONE|SYSTEM|ALL)

Specifies how console messages that indicate when system parmlib limits are reaching critical levels are to be displayed:

NONE

No console messages are to be displayed when any of the parmlib limits have been reached.

SYSTEM

Console messages are to be displayed for all processes that reach system limits. In addition, messages are to be displayed for each process limit of a process if:

- The process limit or limits are defined in the OMVS segment of the owning User ID
- The process limit or limits have been changed with a SETOMVS `PID=pid,process_limit`

ALL Console messages are to be displayed for the system limits and for the process limits, regardless of which process reaches a process limit.

Default: NONE

LOSTMSG=ON|OFF

Enables or disables the detecting of lost and duplicate XCF messages in a shared file system configuration. This parameter is used for diagnostic purposes. LOSTMSG is ignored when a shared file system does not exist.

MAXASSIZE = maxassize

Specifies the RLIMIT_AS hard limit resource value that processes receive when they are dubbed a process. RLIMIT_AS indicates the address space region size.

The soft limit is obtained from MVS. If the soft limit value from MVS is greater than the MAXASSIZE value, the hard limit is set to the soft limit.

This value is also used when processes are initiated by a daemon process using an **exec** after **setuid()**. In this case, both the RLIMIT_AS hard and soft limit values are set to the MAXASSIZE value.

Refer to the description of **setrlimit()** in *z/OS UNIX System Services Programming: Assembler Callable Services Reference* for more information about RLIMIT_AS.

The range is from 10 485 760 (10MB) to 2 147 483 647 ; the default is 41 943 040 (40MB).

Note: You can set a denomination (or multiplier) value when defining this value. The suffix, "C" can have a 1-character value as presented in Table 59 on page 709, but must not exceed the parameter-specific upper limit.

MVS retains the denomination value and uses it within a subsequent D OMVS command

MAXCORESIZE = maxcoresize

Specifies the RLIMIT_CORE soft and hard limit resource values that processes receive when they are dubbed a process. RLIMIT_CORE indicates the maximum core dump file size (in bytes) that a process can create. Also, it specifies the limit when they are initiated by a daemon process using an **exec** after **setuid()**.

Refer to the description of **setrlimit()** in *z/OS UNIX System Services Programming: Assembler Callable Services Reference* for more information about RLIMIT_CORE.

The range is from 0 to 2 147 483 647; the default is 4 194 304 (4MB).

Note: You can set a denomination (or multiplier) value when defining this value. The suffix, "C" can have a 1-character value as presented in Table 59 on page 709, but must not exceed the parameter-specific upper limit.

MVS retains the denomination value and uses it within a subsequent D OMVS command

MAXCPU TIME = maxcputime

Specifies the RLIMIT_CPU hard limit resource values that processes receive when they are dubbed a process. RLIMIT_CPU indicates the CPU time that a process is allowed to use, in seconds. The soft limit is obtained from MVS. If the soft limit value from MVS is greater than the MAXCPU TIME value, the hard limit is set to the soft limit. This value is also used when processes are initiated by a daemon process using an **exec** after **setuid()**. In this case, both the RLIMIT_CPU hard and soft limit values are set to the MAXCPU TIME value.

Refer to the description of **setrlimit()** in *z/OS UNIX System Services Programming: Assembler Callable Services Reference* for more information about RLIMIT_CPU.

The range is from 7 to 2 147 483 647. The default is 1 000.

Specifying a value of 2 147 483 647 indicates unlimited CPU time.

SETOMVS command

MAXFILEPROC = maxfileproc

Specifies the maximum number of files that a single user is allowed to have concurrently active or allocated. The range is 3 to 524287.

MAXFILESIZE = (maxfilesize | NOLIMIT)

Specifies the RLIMIT_FSIZE soft and hard limit resource values that processes receive when they are dubbed a process. RLIMIT_FSIZE indicates the maximum file size (in 4KB increments) that a process can create. Also, it specifies the limit when they are initiated by a daemon process using an **exec** after **setuid()**.

The range is from 0 to 524 228. If you specify 0, no files will be created by the process. Omitting this statement or specifying NOLIMIT indicates an unlimited file size.

Note: You can set a denomination (or multiplier) value when defining this value. The suffix, "C" can have a 1-character value as presented in Table 59 on page 709, but must not exceed the parameter-specific upper limit.

MVS retains the denomination value and uses it within a subsequent D OMVS command

MAXIOBUFUSER=maxiobufsize

Specifies the maximum amount in MB of persistent I/O virtual storage that z/OS UNIX obtains on behalf of a user when a process is performing I/O in a Unicode Services conversion environment is in effect; that is, when AUTOCVT(ALL) was specified.

Although most of this storage is above the 2 G bar, excessive use of such storage can cause significant below the bar z/OS UNIX storage, as well as paging storage, to be consumed. This storage remains allocated for the life of an open file. The amount that is allocated for each open is dependent on both the CCSID of the file and the size of a read or write requests that are used by the process. This limit does not apply to UID 0 processes.

The range is from 0 to 2147483647 in megabytes, representing 0 to 2P-1 (petabytes) of storage.

A character parameter limit multiplier is allowed.

MAXMAPAREA = maxmaparea

Specifies the maximum amount of data space storage (in pages) that can be allocated for memory mappings of z/OS UNIX files. Storage is not allocated until memory mappings are active.

The range is from 1 to 16 777 216. The default is 4 096.

Note: You can set a denomination (or multiplier) value when defining this value. The suffix, "C" can have a 1-character value as presented in Table 59 on page 709, but must not exceed the parameter-specific upper limit.

MVS retains the denomination value and uses it within a subsequent D OMVS command

MAXPROCSYS = maxprocsys

Specifies the maximum number of processes that z/OS UNIX System Services will allow to be active at the same time. The range is 5 to 32 767; the default and the value in BPXPRMXX is 200.

MAXPROCUSER = maxprocuser

Specifies the maximum number of processes that a single OMVS user ID (UID)

is allowed to have active at the same time, regardless of how the process became a z/OS UNIX process. The range is 3 to 32 767;

MAXPTYS = maxptys

Specifies the maximum number of pseudo-TTY (pseudoterminal) sessions that can be active at the same time. The range is 1 to 10 000; the default and the value in BPXPRMXX is 256.

MAXPTYS lets you manage the number of interactive shell sessions. When you specify this value, each interactive session requires one pseudo-TTY pair. You should avoid specifying an arbitrarily high value for MAXPTYS. However, because each interactive user may have more than one session, we recommend that you allow 4 pseudo-TTY pairs for each user (MAXUIDS * 4). The MAXPTYS value influences the number of pseudo-TTY pairs that can be defined in the file system.

MAXSHAREPAGES = maxsharepages

Specifies the maximum number of shared storage pages that can be concurrently in use by z/OS UNIX functions. This can be used to control the amount of ESQA consumed, since the shared storage pages cause the consumption of ESQA storage.

The range is from 0 to 32 768 000. The default is 131 072 pages.

Note:

1. You can set a denomination (or multiplier) value when defining the MAXSHAREPAGES value. The suffix, "C" can have a 1-character value as presented in Table 59 on page 709, but must not exceed the parameter-specific upper limit. MVS retains the denomination value and uses it within a subsequent D OMVS command
2. Use care when you adjust MAXSHAREPAGES on an active system. Dynamically decreasing the number of pages available to EQSA while there is a workload can cause errors, because the EQSA limit can be suddenly reached when the MAXSHAREPAGES limit is no longer as large. As a result, shared programs are not able to be loaded, and new forks are not able to be created. This situation can exist until the workload adjusts to the new lower limit.

MAXTHREADS = maxthreads

Specifies the maximum number of pthread_created threads, including those running, queued, and exited but not detached, that a single process can have currently active. Specifying a value of 0 prevents applications from using pthread_create. The range is 0 to 100 000; the default and the value in BPXPRMXX is 200.

MAXTHREADTASKS = maxthreadtasks

Specifies the maximum number of MVS tasks created with pthread_create (BPX1PTC) that a single user may have concurrently active in a process. The range is 1 to 32 768; the default and the value in BPXPRMXX is 50.

MAXTHREADTASKS lets you limit the amount of system resources available to a single user process.

- The minimum value of 1 prevents a process from performing any pthread_creates.
- A high MAXTHREADTASKS value may affect storage and performance. Each task requires additional storage for:
 - The control blocks built by the z/OS UNIX kernel
 - The control blocks and data areas required by the runtime library

SETOMVS command

- System control blocks such as the TCB and RB

Individual processes can alter these limits dynamically.

MAXUIDS = maxuids

Specifies the maximum number of unique OMVS user IDs (UIDs) that can use z/OS UNIX at the same time. The UID is for interactive users or for programs that requested z/OS UNIX. The range is 1 to 32 767; the default and the value in BPXPRMXX is 200.

MAXUIDS lets you limit the number of active UIDs. Select a MAXUIDS by considering:

- Each z/OS UNIX user is likely to run with 3 or more concurrent processes. Therefore, z/OS UNIX users require more system resources than typical TSO/E users.
- If the MAXUIDS value is too high relative to the MAXPROCSYS value, too many users can invoke the shell. All users may be affected, because forks may begin to fail.

For example, if your installation can support 400 concurrent processes — MAXPROCSYS(400) — and each UID needs an average of 4 processes, then the system can support 100 users. For this operating system, specify MAXUIDS(100).

In assigning a value to MAXUIDS, consider if the security administrator assigned the same OMVS UID to more than one TSO/E user ID.

MAXUSERMOUNTSYS=maxusermountsys

Specifies the maximum number of nonprivileged user mounts for the system or for the shared file system configuration environment. The MAXUSERMOUNTSYS limit only applies to the nonprivileged users and does not affect the privileged mounts. It is a decimal value from 0 to 35000. For those using a shared file system configuration, this value is the maximum number of nonprivileged user mounts allowed in the shared file system environment. The most recent specification will prevail for all of the systems participating in a shared file configuration.

MAXUSERMOUNTUSER=maxusermountuser

Specifies the maximum number of nonprivileged user mounts allowed for each nonprivileged user. The MAXUSERMOUNTUSER limit only applies to the nonprivileged users and does not affect the privileged mounts. It is a decimal value from 0 to 35000. For those using a shared file system configuration, this value is the maximum number of nonprivileged user mounts allowed for each nonprivileged user in the shared file system environment. The most recent specification will prevail for all of the systems participating in a shared file configuration.

MEMLIMIT = maxmemlimit

Specifies the maximum amount (*maxmemlimit*) of allocated, non-shared, 1-megabyte storage segments above the bar allowed for the address space. Both the hard and soft RLIMIT_MEMLIMIT values are set to this value, and the address space *memlimit* is modified to reflect this value.

Note: You can set a denomination (or multiplier) value when defining this value (nnnnnnnC), where nnnnnnn ranges from 1M — 16383P (noting values are rounded up) and C can have a 1-character value as presented in Table 59 on page 709. Also, be aware that SMF set override limits to the values you set here.

MVS retains the denomination value and uses it within a subsequent D OMVS command

NONEMPTYMOUNTPT=NOWARN|WARN|DENY

Specifies how the system is to mount any file system on a mount point when it is a non-empty directory.

NOWARN causes the system to mount any file system on mount point without any warning message when the mount point is a non-empty directory. The contents of that directory are hidden for the duration of the mount.

WARN causes the system to mount any file system on mount point with a warning message when the mount point is a non-empty directory. The contents of that directory are hidden for the duration of the mount.

DENY specifies that the system is not to mount any file system when the mount point is a non-empty directory.

PID=pid,processlimitname=value

Dynamically changes a process-level limit for the process represented by *pid*.

PRIORITYGOAL = (n) | NONE

Specify from 1 to 40 service classes. These classes can be from 1 to 8 characters. If you do not specify this statement, or if you specify NONE, no array is created for it. All service classes specified on the PRIORITYGOAL option must also be specified in your workload manager service policy.

Generally, we do not recommend that you set PRIORITYGOAL.

PWT=SMF|SMFENV|ENV

Process wait time (PWT) specifies whether to time out processes that are waiting for terminal input. When specified, the timeout value applies to all processes that are waiting on terminal activity. To override that value for a specific process, the **_BPXK_TIMEOUT** environment variable can be set for an individual process.

SMF

Specifies that processes are to be timed out according to values specified for **JWT**, **SWT**, and **TWT** in the SMFPRMxx parmlib member. The **_BPXK_TIMEOUT** environment variable is ignored. An individual process cannot override the system setting.

SMFENV

Specifies that processes are to be timed out according to the values specified in the SMFPRMxx member, and allows the **_BPXK_TIMEOUT** environment variable setting to override the SMFPRMxx settings.

ENV

Specifies that processes are to be timed out according to the **_BPXK_TIMEOUT** environment variable setting. Only processes that have set the **_BPXK_TIMEOUT** environment variable will be timed out.

For more information about the SMFPRMxx **JWT**, **SWT**, and **TWT** settings, see *z/OS MVS Initialization and Tuning Reference*. For more information about the **_BPXK_TIMEOUT** environment variable, see *z/OS UNIX System Services Planning*.

RESET = (xx)

Specifies the parmlib member containing parameters to apply immediately to the running z/OS UNIX System Services environment. The variable specifies the character suffix of the BPXPRMxx member to use to change the environment. It can be any properly constructed BPXPRMxx member. This

SETOMVS command

parameter accepts only the single keyword and parmfile specification. It does not accept additional keywords separated by commas.

The **SETOMVS RESET** command is similar to the **SET OMVS** command.

Note:

1. **SETOMVS RESET** accepts only a single parameter; **SET OMVS** accepts more than one parameter.
2. **SETOMVS RESET=(xx)** has been changed to allow **SETOMVS RESET=xx** as well as **SETOMVS RESET=(xx)**. The parentheses are now optional.

For more detailed information about the **RESET** parameter refer to *Managing Operations in z/OS UNIX System Services Planning*.

SERV_LPALIB=('dsname', 'volser')

Specifies the target service library where the z/OS UNIX System Services modules that are to be built into LPA are located. *dsname* is a 1-to-44 character value representing a valid MVS load library data set name. The alphabetic characters in the load library name must be uppercase. *volser* is a 1-to-6 character value representing a valid volume serial number for the volume that contains the specified MVS load library. The alphabetic characters in the volume serial number must be uppercase. The library data set must reside on the volume specified or the specification will not be accepted and an error will occur during the parsing of the statements.

SERV_LINKLIB=('dsname', 'volser')

Specifies the target service library where the z/OS UNIX System Services modules that are to be loaded into the private area of the OMVS address space are located. *dsname* is a 1-to-44 character value representing a valid MVS load library data set name. The alphabetic characters in the load library name must be uppercase. *volser* is a 1-to-6 character value representing a valid volume serial number for the volume that contains the specified MVS load library. The alphabetic characters in the volume serial number must be uppercase. The library data set must reside on the volume specified or the specification will not be accepted and an error will occur during the parsing of the statements.

SHRLIBRGNSIZE=shrlibrgnsize

Specifies the maximum size of the shared library region for address spaces that load system shared library modules.

SHRMAXPAGES=shrlibmaxpages

Specifies the maximum number of pages that can be allocated in the system to contain user shared library modules.

STEPLIBLIST = 'stepliblist'

Specifies the path name of a z/OS UNIX file. This file is intended to contain a list of data sets that are sanctioned by the installation for use as step libraries during the running of set-user-ID and set-group-ID executable programs.

SUPERUSER = superuser

This statement specifies a superuser name. You can specify a 1-to-8-character name that conforms to restrictions for a z/OS UNIX user ID. The user ID specified on **SUPERUSER** must be defined to the security product and should have a UID of 0 assigned to it. The user ID specified with **setuid(0)** is used when a daemon switches to an unknown identity with a UID of 0.

The default is **SUPERUSER(BPXROOT)**.

SYNTAXCHECK=(xx)

Specifies that the operator wishes to check the syntax of the designated parmlib member. For example, to check the syntax of BPXPRMZ1 the operator enters:

```
SETOMVS SYNTAXCHECK=(Z1)
```

The system returns a message indicating either that the syntax is correct or that syntax errors were found and written into the hard copy log. This command parses the parmlib member in the same manner, and with the same messages as during IPL.

Note: **SYNTAXCHECK** checks syntax as well as the existence of HFS and zFS data sets specified in the catalog. Mount points are not verified. The **PARM** keyword is not checked because this keyword is PSF-specific and is subject to change. It will not be checked by the LFS layer.

SYSCALL_COUNTS = (YES | NO)

Specifies whether to accumulate syscall counts so that the RMF data gatherer can record this information. The default is NO.

If you specify YES, the path length for the most frequently used kernel system calls increases by more than 150 instructions.

SYSNAME=sysname|*

sysname is the 1-8 alphanumeric name of a system participating in shared file system. This system must be IPLed with **SYSPLEX(YES)**. **sysname** specifies the particular system on which a mount should be performed. This system will then become the owner of the file system mounted. If *****(asterisk) is specified, it represents any other randomly selected system taking part in shared file system. The asterisk specification is not available with the **FROMSYS** parameter.

For examples of the use of this parameter when making move or change requests, see the topic on shared file systems in a sysplex in *z/OS UNIX System Services Planning*.

TTYGROUP = ttygroup

This specifies a 1-to-8-character name that must conform to the restrictions for a z/OS UNIX group name. Slave pseudoterminals (ptys) and OCS rtys are given this group name when they are first opened. This group name should be defined to the security product and have a unique GID. No users should be connected to this group.

The name is used by certain **setgid(0)** programs, such as **talk** and **write**, when attempting to write to another user's pty or rty.

The default is TTYGROUP(TTY).

USERIDALIASTABLE = 'useridaliastable'

Enables installations to associate alias names with MVS user IDs and group names. If specified, the alias names are used in z/OS UNIX System Services processing for the user IDs and group names listed in the table.

Specifying **USERIDALIASTABLE** causes performance to degrade slightly. The more names that you define, the greater the performance degradation. Installations are encouraged to continue using uppercase-only user IDs and group names.

The **USERIDALIASTABLE** statement specifies the pathname of a z/OS UNIX file. This file is intended to contain a list of MVS user IDs and group names with their associated alias names.

SETOMVS command

VERSION = 'nnnn'

The VERSION statement applies only to systems that are exploiting shared file systems. VERSION allows multiple releases and service levels of the binaries to coexist and participate in shared file systems. A directory with the value *nnnn* specified on VERSION is dynamically created at system initialization under the sysplex root that is used as a mount point for the version file system. This directory, however, is only dynamically created if the root file system for the sysplex is mounted read/write.

Note: *nnnn* is a case-sensitive character string no greater than 8 characters in length. It indicates a specific instance of the version file system. The most appropriate values for *nnnn* are the name of the target zone, &SYSR1, or another qualifier meaningful to the system programmer. For example, if the system is at V2R9, you can specify REL9 for VERSION. When SYSPLEX(YES) is specified, you must also specify the VERSION parameter.

The VERSION value is substituted in the content of symbolic links that contain \$VERSION. For scenarios describing the use of the version file system, see "Shared file system in a sysplex" in *z/OS UNIX System Services Planning*.

When testing or changing to a new Maintenance Level (PTF), you can change the VERSION value dynamically by using the SETOMVS command:

```
SETOMVS VERSION='string'
```

You can also change the settings of this parameter via SET OMVS=(xx) and SETOMVS RESET=(xx) parmlib specifications.

Note: We do not recommend changing version dynamically if you have any users logged on or running applications; replacing the system files for these users may be disruptive.

SETPROG command

Use the SETPROG command for:

- Updating the APF List (SETPROG APF)
 - Change the format of the authorized program facility (APF) list from static to dynamic, or dynamic to static
 - Add a library to a dynamic APF list
 - Delete a library from a dynamic APF list.
- Updating Dynamic Exits (SETPROG EXIT)
 - Add an exit routine to an exit
 - Replace an exit routine for an exit
 - Change the state of an exit routine
 - Delete an exit routine from an exit
 - Undefine an implicitly-defined exit
 - Change the attributes of an exit
- Updating LNKLIST Concatenations (SETPROG LNKLIST)
 - Define a LNKLIST set of data sets for the LNKLIST concatenation
 - Add data sets to or delete data sets from the LNKLIST set
 - Remove the definition of a LNKLIST set from the system
 - Test for the location of a specific module in the LNKLIST concatenation

- Activate a LNKLST set as the LNKLST concatenation for the system
- Update an address space for jobs to use a LNKLST set.
- Managing Dynamic LPA Content (SETPROG LPA)
 - Specify modules to add to the LPA after IPL
 - Specify modules to delete from the LPA after IPL
 - Specify the minimum amount of CSA storage that must remain available after an ADD operation.
- Enabling protection of REFR programs (SETPROG REFRPROT)
- Disabling protection of REFR programs (SETPROG NOREFRPROT)
- Enabling tracking of directed load modules (SETPROG TRACKDIRLOAD)
- Disabling tracking of directed load modules (SETPROG NOTRACKDIRLOAD)

Each subcommand of SETPROG (for example, SETPROG LNKLST,DEFINE) has a direct analog in the PROGxx parmlib member (such as the LNKLST DEFINE statement) activated by SET PROG=xx. You will get the same result whether you activate the function by SETPROG or by SET PROG=xx.

Syntax

The syntax for each variation of the SETPROG command is shown immediately preceding its respective parameter list.

SETPROG

Note:

1. The SETPROG command does not have an abbreviation.
2. The SETPROG command requires that comments be enclosed within /* */ characters. Refer to “System command formats” on page 168 for further information.

Updating the APF list

Use the SETPROG APF command to:

- Change the format of the authorized program facility (APF) list from static to dynamic, or static to dynamic
- Add a library to a dynamic APF list
- Delete a library from a dynamic APF list.

To use the SETPROG APF command to update the contents of the APF list during normal processing, the format of the APF list must be dynamic. SETPROG is a system control command and is issued from a console with system (AUTH(SYS)) or higher authority.

- To add or delete the APF list entry for library *libname*, you must have UPDATE authority to the RACF FACILITY resource class entity CSVAPF.*libname*, or there must be no FACILITY class profile that protects that entity.
- To change the format of the APF list to dynamic, you must have UPDATE authority to the RACF FACILITY resource class profile CSVAPF.MVS.SETPROG.FORMAT.DYNAMIC, or there must be no FACILITY class profile that protects that entity.

SETPROG command

- To change the format of the APF list back to static, you must have UPDATE authority to the RACF FACILITY resource class profile CSVAPF.MVS.SETPROG.FORMAT.STATIC, or there must be no FACILITY class profile that protects that entity.

If you authorize users to update the APF list using some other method, you must ensure that there is no FACILITY class profile that matches one of the previously listed profiles. If there is such a profile, the system uses it to determine if the requestor is authorized.

You can also use the SET PROG=xx command to update the APF list using parameters specified in the PROGxx parmlib member. See “SET command” on page 620 for more information about using SET PROG=xx. See *z/OS MVS Planning: Operations* for information about defining RACF profiles for the SETPROG and SET PROG=xx commands.

```
SETPROG APF{,FORMAT={DYNAMIC|STATIC}}  
  
        {,{ADD|DELETE},{DSNAME|LIBRARY}=libname,{SMS|VOLUME=volume} }
```

Note:

1. You can specify the DSNAME parameter as DSN, LIB, or LIBRARY, the VOLUME parameter as VOL, and the DYNAMIC parameter as DYN.
2. This command requires a /* */ around comments. Refer to “System command formats” on page 168 for further information.

FORMAT=[DYNAMIC or STATIC]

Indicates that the format of the APF list is to change (from static to dynamic, or vice versa). If the system processes FORMAT=DYNAMIC successfully, authorized users can update the dynamic APF list during normal processing.

Before you change the format of the APF list to dynamic, contact the system programmer to validate that all programs and vendor products are converted to use dynamic APF services and that the proper program products are installed. Also, see the restrictions associated with changing the format of the APF list in *z/OS MVS Initialization and Tuning Reference*.

ADD

Adds the library specified on the DSNAME parameter to the APF list. There is no restriction on the number of libraries you can specify in a dynamic APF list. You can only use this option if the format of the APF list is dynamic.

DELETE

Deletes the library specified on the DSNAME parameter from the APF list. You can only use this option if the format of the APF list is dynamic.

DSNAME|LIBRARY=libname

The 1-44 character name of the library that you want to add or delete. DSNAME can be an alias for the library name.

This function does not map an alias to the actual library name. Therefore, if you specify an alias, only the alias is added to, or deleted from, the APF list. Similarly, when you specify an actual library name as input, none of the library's aliases are added to, or deleted from, the APF list.

Do not define aliases in the APF list because IBM's data management services (for example, OPEN processing) map an alias to its actual library name and query the APF list by the actual library name. An alias in the APF list does not authorize anything.

VOLUME=volume

The volume identifier for the volume containing the library specified on the DSNNAME parameter, which is one of the following:

- The volume serial number
- Six asterisks (*****), indicating that the system is to use the volume serial number of the current system residence (SYSRES) volume.
- *MCAT*, indicating that the system is to use the volume serial number of the volume containing the master catalog.

SMS

Indicates that the library specified on the DSNNAME parameter is managed by the storage management subsystem (SMS), and therefore no volume is associated with the library. When you display the APF list entry for an SMS-managed library, the volume appears as *SMS*.

Example 1:

To change the format of the APF list from static to dynamic, enter:

```
SETPROG APF,FORMAT=DYNAMIC
```

Example 2:

To add library SYS1.ACCTG.DATA, on the current SYSRES volume, to the APF list, enter:

```
SETPROG APF,ADD,DSNAME=SYS1.ACCTG.DATA,VOLUME=*****
```

Example 3:

To add SMS-managed library SYS1.DSSET.LOG to the APF list, enter:

```
SETPROG APF,ADD,DSNAME=SYS1.DSSET.LOG,SMS
```

Example 4:

To delete library SYS1.ACCTG.DATA, on volume 617680, from the APF list, enter:

```
SETPROG APF,DELETE,DSNAME=SYS1.ACCTG.DATA,VOLUME=617680
```

Updating dynamic exits

Use the SETPROG EXIT command to:

- Add an exit routine to an exit
- Replace an exit routine for an exit
- Change the state of an exit routine
- Delete an exit routine from an exit
- Undefine an implicitly-defined exit
- Change the attributes of an exit

You can use the SETPROG EXIT command to control exits that have been defined to the dynamic exits facility. Dynamic exits services are implemented by:

SETPROG command

- The EXIT statement of the PROGxx parmlib member. The EXIT statement of PROGxx allows an installation to add exit routines to an exit, delete an exit routine for an exit, change the state of an exit routine, change the attributes of an exit, and undefine an implicitly defined exit.

The PROGxx EXIT statement interacts with the PROG=xx parameter of IEASYSxx and the SET PROG=xx command. At IPL, you can use PROG=xx to specify the particular PROGxx parmlib member the system is to use. During normal processing, you can use the SET PROG=xx command to set a current PROGxx parmlib member. See *z/OS MVS Initialization and Tuning Reference* for information about the PROGxx parmlib member.

- The SETPROG EXIT command.
- The CSVDYNEX macro. The CSVDYNEX macro can be used to define exits to the dynamic exits facility, control their use within a program, and associate one or more exit routines with those exits. It can also be used to associate exit routines with the existing SMF and allocation exits, which have been defined to the dynamic exits facility.

An installation can use any of these methods to control dynamic exits. An exit routine, for example, can be associated with an exit using the CSVDYNEX ADD request, the SETPROG EXIT,ADD operator command, or the EXIT statement of PROGxx.

The complete syntax for the SETPROG EXIT command is:

```
SETPROG EXIT, {ADD, EXITNAME=exitname, MODNAME=modname      }
                [, STATE={ACTIVE|INACTIVE}]
                [, DSNNAME=dsname]
                [, JOBNAME={jobname|*}]
                [, ABENDNUM=(n[, CONSEC])]
                [, FIRST|LAST]
                [, PARAM=param]
                [, DELETEFORCE={NO|YES}]
                [, SERVICEMASK=servicemask]

                {ATTRIB, EXITNAME=exitname, KEEPRC=(compare, kk) }

                {DELETE, EXITNAME=exitname, MODNAME=modname    }
                [, FORCE={YES|NO}]

                {MODIFY, EXITNAME=exitname, MODNAME=modname    }
                [, STATE={ACTIVE|INACTIVE}]
                [, JOBNAME={jobname|*}]

                {REPLACE, EXITNAME=exitname, MODNAME=modname,  }
                [, STATE={ACTIVE|INACTIVE}]
                [, DSNNAME=dsname]
                [, SERVICEMASK=servicemask]

                {UNDEFINE, EXITNAME=exitname                    }
```

Notes:

1. This command requires a /* */ around comments. Refer to "System command formats" on page 168 for further information.
2. The EXITNAME parameter must be the first parameter following the ADD, ATTRIB, DELETE, MODIFY, REPLACE, or UNDEFINE keywords.

ADD

Adds an exit routine to an exit.

ATTRIB

Changes the attributes of an exit.

DELETE

Deletes an exit routine from an exit.

MODIFY

Changes the state of an exit routine.

REPLACE

Replaces an exit routine for an exit.

UNDEFINE

Undefines an implicitly-defined exit. An exit is implicitly defined when:

- You add exit routines to an exit before the exit is defined
- You set attributes using the ATTRIB parameter before defining the exit.

EXITNAME=exitname or EX=exitname or EN=exitname

The 1-16 character name of the exit.

MODNAME=modname or MOD=modname

The 1-8 character name of the exit routine. If DSNNAME is not specified, the system tries to locate the exit routine using the LPA, the LNKLIST concatenation, and the nucleus.

DSNAME=dsname or DSN=dsname

The 1-44 character data set name of a load library in which the named exit routine resides. The data set must be cataloged, but does not need to be APF-authorized.

If the data set has been migrated, processing of the SETPROG command is delayed until the data set has been retrieved.

JOBNAME={jobname|*}

The 1-8 character name of the job(s) for which this exit routine is to get control. If some other job calls the exit, this exit routine does not get control.

You can use the JOBNAME parameter to limit most exit routines to processing a particular job. However, you cannot use this parameter to restrict processing of the IEFUJV exit routine to a particular job.

To indicate more than one job name, use an asterisk as the last character. A matching jobname is one that matches all characters preceding the asterisk.

Specify JOBNAME=* to request that the system *not* check for the jobname. The default for the ADD parameter is *. The default for the MODIFY parameter is to leave the jobname unchanged.

Based on the characteristics of the particular exit, the JOBNAME parameter might not be effective if the exit is driven before the job name has been set in a batch initiator.

STATE

Indicates the state of the exit routine. ACTIVE indicates that the exit routine is to be given control when the exit is called. INACTIVE indicates that the exit routine is not to be given control when the exit is called.

Note that the STATE parameter activates or deactivates the exit routine independently from other parameters, such as JOBNAME. For instance, STATE=INACTIVE,JOBNAME=jobname does *not* mean to make the exit routine

|
|
|

SETPROG command

| inactive for *jobname*; it means to make the exit routine inactive, and it defines
| *jobname* as the job for which the exit routine is to get control (when the exit
| routine is active).

The default for the ADD parameter is STATE=ACTIVE. The default for the MODIFY parameter is to leave the state unchanged.

PARAM=param

The 1 - 8 character parameter that is passed to the exit routine. If this parameter is less than 8 bytes, it is padded with blanks until it is 8 bytes. The first 4 bytes are passed to the exit routine in access register 0. The second 4 bytes are passed to the exit routine in access register 1. If you specify characters other than the following characters within the PARAM string you must enclose the parameter string within single quotes:

- uppercase alphabets A - Z
- numerics 0 - 9
- special characters @, \$, #
- period, asterisk, question mark, underscore, hyphen

ABENDNUM=(n [, CONSEC])

Indicates when the system should stop giving control to the exit routine in case of abends. ABENDNUM=*n* indicates that the exit routine is not to be given control after the *n*th abend. ABENDNUM=*n*,CONSEC indicates that there must be *n* consecutive abends before the system stops giving control to the exit routine. CONSEC is not supported if this exit has FASTPATH processing in effect, and either a PSW key 8 to 15 or ANYKEY processing in effect.

The default is to use the ABENDNUM characteristics that were specified (or defaulted) when the exit was defined. The ABENDNUM value must not exceed 8 decimal digits.

FIRST

Specifies that the system is to call the exit routine before all other exit routines associated with this exit, unless another exit routine, added after it, also specifies FIRST.

If you specify neither the FIRST nor the LAST parameter, the system may call the exit routines associated with this exit in any order.

LAST

Specifies that the system is to call the exit routine after all other exit routines associated with this exit, unless other exit routines are added after it.

If you specify neither the FIRST nor the LAST parameter, the system may call the exit routines associated with this exit in any order.

FORCE={NO|YES}

Indicates that the system is to delete the exit routine. The exit routine will no longer be given control. Specify FORCE=YES for an exit with FASTPATH processing in effect, and either a PSW key 8 to 15 or ANYKEY processing in effect. Assuming the exit has FASTPATH processing in effect, and the PSW key is 8 to 15, or ANYKEY processing is in effect:

- FORCE=NO, the default, changes the state of the exit routine to inactive. The system does not free the storage.
- FORCE=YES frees the storage of the exit routine immediately. Use FORCE=YES only if you are sure that no exit is running that exit routine.

For exits that are non-FASTPATH or whose PSW key is 0 to 7, and are not ANYKEY, the system frees the storage when it determines that no other exits are using the exit routine.

KEEPRC=(*compare*,*kk*)

Specifies a comparison and a return code which, if true, cause the information produced by this exit routine to be returned to the exit caller. The valid choices for *compare* are EQ, NE, GT, LT, GE, and LE. For example, with KEEPRC=(NE,4), if the exit routine produces a return code of 8, the compare for not-equal with 4 is true, and KEEPRC processing causes the information produced by this exit routine to be returned to the exit caller.

The default is not to perform KEEPRC processing. Do not enter more than 8 decimal digits when specifying a value for *kk*.

If return codes from more than one exit routine match the conditions specified, the system returns information from the exit routine that finished first.

DELETEDFORCE={NO|YES}

Specifies whether any deletion of the exit routine (by CSVDYNEX, SETPROG, or an EXIT DELETE statement in PROGxx) must specify FORCE=YES:

- DELETEDFORCE=NO, the default, specifies that exit routine deletion does *not* require FORCE=YES.
- DELETEDFORCE=YES specifies that exit routine deletion does require FORCE=YES. If the deletion request does not specify FORCE=YES, the request is rejected.

DELETEDFORCE can be abbreviated as DELFORCE.

SERVICEMASK=*servicemask*

Specifies a service mask for the exit routine that is used to determine whether the exit routine will be called for a given caller.

Specify *servicemask* as one of:

- *x1*
- (*x1*)
- (*x1*,*x2*)

where each *x1* and *x2* is a one to eight digit hexadecimal number. *x1* and *x2* are padded on the left with zeros to a length of 8 and thus each identifies 4 bytes of the service mask. *x1* represents bytes 0 to 3 of the mask, *x2* represents bytes 4 to 7 of the mask (when no *x2* is specified, those bytes are zeroes). For example, SERVICEMASK=(1,4003) will produce a mask of (hexadecimal) 0000000100004003.

The service mask is applied to the service ID of the exit caller. Only if the ANDed value of the service mask and the service ID is nonzero for a given call and a given exit routine will that exit routine be called.

SERVICEMASK can be abbreviated as SERVMASK

Example:

Associate exit routine MYMOD with the SMF exit known as SYS.IEFUJI, defined through the SYS statement in a SMFPRMxx parmlib member. The load module is in data set MY.DSN.

```
SETPROG EXIT,ADD,EXITNAME=SYS.IEFUJI,MODNAME=MYMOD,DSNAME=MY.DSN,
STATE=ACTIVE
```

Updating LNKLST concatenations

Use the SETPROG LNKLST command to:

- Define a LNKLST set of data sets for the LNKLST concatenation
- Add data sets to or delete data sets from the LNKLST set
- Remove the definition of a LNKLST set from the system
- Test for the location of a specific module in the LNKLST concatenation
- Activate a LNKLST set as the LNKLST concatenation for the system
- Update an address space for jobs to use a LNKLST set

PROGxx is the parmlib member used to define one or more LNKLST sets. You can use PROGxx to activate one of the LNKLST sets as the LNKLST concatenation at IPL. (You can also activate the LNKLST concatenation through LNKLSTxx, but IBM recommends that you use PROGxx.) See *z/OS MVS Initialization and Tuning Reference* for information about the PROGxx parmlib member.

SETPROG LNKLST allows you to modify the LNKLST concatenation dynamically after IPL. For example, it allows you to define a new LNKLST concatenation, set a new LNKLST as the current one (meaning that any subsequently started job will use this new LNKLST), or update a currently executing job that is using another LNKLST to switch to use a new one. Note that currently executing jobs do not automatically switch to use a new LNKLST when that LNKLST is activated, thus multiple LNKLST definitions may be in use on the system simultaneously. See "Changing the current LNKLST set" in *z/OS MVS Initialization and Tuning Reference*.

Attention: When using the SETPROG LNKLST command, be aware that some actions, such as ADD and ACTIVATE, may temporarily allocate all the data sets in the LNKLST concatenation to the master scheduler address space. The master scheduler address space has a TIOT size of 12 K, which allows for approximately 600 unit allocations. For data sets in the LNKLST concatenation that have an SMS data class assigned with a dynamic volume count greater than 1, additional TIOT space may be required, reducing the number of data sets that may be allocated within the master scheduler address space. Multi-volume data sets are not supported in the LNKLST concatenation. For this reason, IBM recommends that you not assign a data class that specifies a dynamic volume count greater than 1 to a data set in the LNKLST concatenation.

The complete syntax for the SETPROG LNKLST command is:

```
SETPROG LNKLST, {DEFINE, NAME=lnk1stname [, COPYFROM=lnk1stname] [, NOCHECK] }
                {ADD, NAME=lnk1stname,
                  DSNAME=dsname [, VOLUME=volser] [, ATBOTTOM      ]
                                                           [, ATTOP        ]
                                                           [, AFTER=dsname]
                                                           [, CONCAT (CHECK | NOCHECK)]}
                {DELETE, NAME=lnk1stname, DSNAME=dsname }
                {UNDEFINE, NAME=lnk1stname }
                {TEST, NAME=lnk1stname, MODNAME=name }
                {ACTIVATE, NAME=lnk1stname }
                {UPDATE, {{JOBNAME | JOB}=jobname} [, DELAY=nn] }
                       {ASID=asid } [DELAY=delay]
                {UNALLOCATE }
                {ALLOCATE }
```

Note: This command requires a /* */ around comments. See “System command formats” on page 168 for further information.

LNKLST

Indicates that an action is to be performed for a LNKLST set. LINKLIST, LINKLST, LNK, or LNKLIST can be specified as an alternative to LNKLST.

DEFINE

Specifies that you want to define a LNKLST set (a set of ordered data sets for the LNKLST concatenation).

NAME=*lnklstname*

The name of the LNKLST set that you want to specify. Naming conventions are as follows:

- You can specify from 1 to 16 characters for name.
- You can use alphanumerics, underscores, periods, and \$, #, or @.
- Do not use imbedded blanks.
- Do not use the name CURRENT. The system uses CURRENT to mean the current LNKLST set.
- For all options except TEST, do not use the name IPL. The system uses IPL to mean LNKLST information specified in parmlib member LNKLSTxx. However, you can specify

```
SETPROG LNKLST,TEST,NAME=IPL
```
- Do not begin the name with SYS. SYS is reserved for IBM use.

COPYFROM=*lnklstname*

Specifies the name of an existing LNKLST set from which to initialize the LNKLST set you are defining. If you specify CURRENT for the name, the system uses the current LNKLST set.

NOCHECK

Indicates that the system does not check to determine if the specified LNKLST set contains SYS1.LINKLIB, SYS1.MIGLIB, SYS1.CSSLIB, SYS1.SIEALNKE and SYS1.SIEAMIGE before allocating the LNKLST concatenation.

Note: Use NOCHECK with caution. You might use NOCHECK after you have modified SYS1.LINKLIB and want to compress SYS1.LINKLIB. For a procedure, see the description of the PROGxx NOCHECK parameter in *z/OS MVS Initialization and Tuning Reference*.

ADD

Indicates that you want to add a data set to the specified LNKLST set.

You cannot add a data set to either the current or the active LNKLST set. If a data set has been migrated, the request waits until the data set is available. For information about the maximum number of data sets you can define to a LNKLST set, see *z/OS MVS Initialization and Tuning Reference*.

Note that you cannot specify in a SETSSI ADD command a subsystem initialization routine that is added via a SETPROG LNKLST,ADD command. That is because the new LNKLST library will not be picked up until the end of the job that is running. However, the SETSSI command runs in the MASTER ASID, which never ends (until the next IPL). Therefore, the SETSSI command can never pick up a new LNKLST. To correct this problem, you must issue the UPDATE command; however, use caution when you do that. See the “UPDATE” on page 731 for considerations and restrictions.

DSNAME=*dsname*

The 44-character name of a data set or library that you want to add to the

SETPROG command

specified LNKLST set or delete from the specified LNKLST set. DSN, LIB, and LIBRARY are accepted synonyms for this parameter.

The data set can be a PDS or a PDSE. IBM recommends that you use PDSEs because of the limitations on the number of extents for a LNKLST concatenation. See *z/OS MVS Initialization and Tuning Reference*.

Data sets to be added can be SMS-managed or non SMS-managed. After the system determines the volume and the SMS status of the data set, the following actions result in an error when the system tries to allocate the LNKLST set:

- If the data set in the LNKLST set changes status from SMS-managed to non SMS-managed, or from non-SMS managed to SMS-managed.
- If a non SMS-managed data set in the LNKLST set is deleted and moved to another volume.

In either case, to add the data set after the change has occurred, you must first delete the data set from the LNKLST set and add it again.

VOLUME=volser

Specifies the name of the volume on which the data set resides. The data set must be cataloged. If the volume does not match the name in the catalog, the ADD request fails. The name can be from 1 to 6 characters.

Cataloged data sets must be defined using the standard search order for requests as outlined in the *z/OS DFSMS Managing Catalogs*. Variations in the standard search order might result in data sets not being found during LNKLST processing.

ATBOTTOM

ATTOP

AFTER=dsname

Indicates where in the LNKLST set you want to place the data set. The default is ATBOTTOM.

ATBOTTOM indicates that you want to place the data set specified on the DSNNAME parameter at the bottom of the list of data sets in the LNKLST set.

ATTOP indicates that you want to place the data set specified on the DSNNAME parameter at the beginning of the LNKLST set. The system places the LINKLIB, MIGLIB, CSSLIB, LINKLIBE and MIGLIBE data sets in that order at the beginning of every LNKLST set in the LNKLST concatenation. If you use ATTOP, the system always places the data set after the CSSLIB data set.

AFTER =dsname indicates that the system places the data set specified on the DSNNAME parameter after the data set specified by *dsname*. You cannot use this parameter to place a data set after the LINKLIB, MIGLIB, CSSLIB, LINKLIBE, or MIGLIBE data set in the LNKLST set. Instead, use ATTOP if you want to place the data set immediately after the CSSLIB data set.

Default Value: If you omit ATBOTTOM, ATTOP, or AFTER, the system adds the data set to the bottom of the LNKLST set.

CONCAT(CHECK | NOCHECK)

Specifies whether or not to check if the concatenation defined by the LNKLST set is full. The parameter is optional. CONCAT(NOCHECK) is the default.

CONCAT(CHECK) specifies that the system *is* to check if the concatenation is full. This requires that all data sets in the LNKLST be allocated and concatenated together, and will require more processing time than the default.

CONCAT(NOCHECK), the default option, specifies that the system is *not* to check whether the concatenation is full. (If the concatenation actually is full, it will be detected when the LNKLST set is activated.)

DELETE

Indicates that you want to delete a data set from the specified LNKLST set.

You cannot delete a data set from either the current or the active LNKLST set.

UNDEFINE

Removes the definition of the LNKLST set specified by `NAME=lnklstname` from the system. You cannot remove the definition of the current LNKLST set, another LNKLST set that is being actively used by a job or address space, or the LNKLST defined at IPL through LNKLSTxx and the LNK parameter of IEASYSxx. See "Removing or Compressing a Data Set in an Active LNKLST Set" in *z/OS MVS Initialization and Tuning Reference* for information about LLA management of the LNKLST data set.

TEST

Indicates that you want to locate a specific routine associated with a data set in the LNKLST set. If the system locates the data set, the system indicates the name of the data set. If a data set has been migrated, the request waits until the data set is available.

MODNAME=name

MODNAME specifies the name of a module to be located in the LNKLST set. MODULE and MOD can be used as synonyms for MODNAME.

ACTIVATE

Indicates that you want to activate the specified LNKLST set as the current LNKLST concatenation. When you use SETPROG LNKLST to activate the LNKLST set after IPL, jobs or address spaces that are still active continue to use the previous current LNKLST set. To associate a job in an address space to the current LNKLST set after IPL, see UPDATE. See "Removing or Compressing a Data Set in an Active LNKLST Set" in *z/OS MVS Initialization and Tuning Reference* for information about LLA management of the LNKLST data set.

If a data set in the LNKLST set has been migrated before the LNKLST set is activated, the request waits until the data set is available.

When the ACTIVATE request completes, the system issues an event (ENF) signal (event code 52). Depending on the options specified in SMFPRMxx, whenever a LNKLST set is activated, the system records SMF record type 90 subtype 29. See "SETSMF command" on page 740.

UPDATE

Indicates that the system is to update an address space so that a specified job or jobs associated with that space can use the current LNKLST set. If the job is using another LNKLST set when the current LNKLST set is activated, it will continue to use the original LNKLST set until it completes operations. When the job completes and restarts, it then uses the data sets defined in the new currently active LNKLST set. See "Removing or Compressing a Data Set in an Active LNKLST Set" in *z/OS MVS Initialization and Tuning Reference* for information about LLA management of the LNKLST data set.

Be careful when you use UPDATE. Updating an address space while a program in that address space is fetching a module can cause the fetch to fail or to locate an incorrect copy of the module. The system does not attempt to verify the validity of the data for UPDATE.

SETPROG command

JOBNAME | JOB=*jobname*

Specifies the name of the job or jobs to update. You can use wildcard characters (? or *) for *jobname*. UPDATE updates any job whose name matches the specified criteria. The system compares *jobname* to the name of any initiated job or jobs that match, or to the name of the address space.

ASID=*asid*

Specifies the address space id for the job.

DELAY=*nn*

Indicates the number of seconds to delay the completion of the UPDATE operation.

UNALLOCATE

Indicates that you want to undo all existing allocations obtained while processing active LNKST sets. This also releases the SYSDSN ENQ.

Note:

1. Make sure that you do not delete or move the LNKST data sets while the allocations are not in effect (from the time that you use the UNALLOCATE request until the time that you use the ALLOCATE request).
2. Once you have completed everything associated with the UNALLOCATE, you must specify LNKST ALLOCATE to re-obtain the remaining ENQs.

ALLOCATE

Indicates that you want to re-obtain the allocation (and SYSDSN ENQ) for every data set in every active LNKST.

Example 1:

Add the data set DATA.SET.A to the LNKST set MY.LNKST.SET. The system places the data set after the MIGLIBE data set in the LNKST set.

```
SETPROG LNKST,ADD,NAME=MY.LNKST.SET,DSNAME=DATA.SET.A,ATTOP
```

Example 2:

Change the job MY.JOB to use the current LNKST set:

```
SETPROG LNKST,UPDATE,JOB=MY JOB
```

Managing dynamic LPA content

Use the **SETPROG LPA** command anytime after IPL to specify:

- Modules to add to the LPA
- Modules to delete from the LPA
- The minimum amount of CSA storage that must remain available after an ADD operation.

You can also initiate a change to the LPA from a program via the CSVDYLP macro, or by an operator using the **SET PROG** command. You can use the **PROG** system parameter to specify CSA threshold values, but not to request ADD or DELETE operations.

You can exercise certain controls over the modules to be loaded:

- You specify a data set from which the system is to load the modules. You must be authorized to make the request.
- You can request that the modules be placed into fixed common storage.

- You can request that only the full pages within a load module be page-protected. This does leave the likelihood of the beginning and/or end of a load module not being page protected. By default, each module is individually page-protected. This is, however, wasteful of common storage, as each module needs then to occupy a whole number of 4096-byte pages. In all cases the module will be in key 0 storage.
- You can specify that the module being replaced is the routine for a specific SVC. The system then updates the SVC table with the new entry point address.
- You can specify that the system must process aliases of the specified modules even if the aliases are not explicitly specified.

The system considers LPA modules as coming from an authorized library. As part of its LPA search, the system will find modules that had been added dynamically. It will find a module that had been added dynamically before it finds one of the same name that had been added during IPL.

Use the **SETPROG LPA** command to replace modules only where the owning product verifies the replacement. Otherwise, replacement could result in partial updates. If the owning product has already saved the module address, the system will not conduct an LPA search and will not find the updated module. Also, the addresses of all modules that are accessed via a program call (PC) instruction are stored in the PC table. That table is not updated by the **SETPROG LPA** command. Therefore, these modules cannot be replaced using the **SETPROG LPA** command. You must IPL for the updates to take effect.

Note: If you specify the **SVCNUMDEC** keyword, dynamic LPA can update the SVC table. Specifying **SVCNUMDEC** can be used to replace an SVC routine. To add an SVC routine however, the user of the **SETPROG LPA** command, or the owner of the SVC, must write a program that gets control as the CSVDYLPA exit routine, looks for a given routine name, and then issues the appropriate SVCUPDTE service call to update the SVC table. For more information about the CSVDYLPA exit routine, see "Monitoring Dynamic LPA Processing" in *z/OS MVS Programming: Authorized Assembler Services Guide*.

It is sometimes necessary to re-IPL the system to replace LPA modules. For example, many service updates of LPA modules will require a re-IPL.

The complete syntax for the **SETPROG LPA** command is:

```
SETPROG LPA, {ADD, MODNAME=(modname... ,modname) | MASK=mask}
              [, DSNNAME=dsname | LNKLST]
              [, PAGEABLE | FIXED]
              [, PAGEPROTALL | PAGEPROTPAGE]
              [, SVCNUMDEC=svcnum | ,SVCNUMDEC=(svcnum,routcode)]
              [, ADDALIAS | ,NOADDALIAS]

              {DELETE, MODNAME=(modname... ,modname)           }
              FORCE=YES [CURRENT | OLDEST]

              {CSAMIN=(below, above)                           }
```

Note:

1. You may alternatively express the parameters associated with the keywords **MASK**, **DSNAME**, and **FORCE** in the preceding syntax diagram using parentheses rather than equals signs, as shown in the descriptions below.

SETPROG command

- This command requires a `/* */` around comments. See “System command formats” on page 168 for further information.

LPA

Statement type indicating that an action may be performed on the LPA.

ADD

Specifies that one or more modules be added to the LPA.

Default value: None

Attention: Modules added to the system by dynamic LPA processing are placed into CSA or ECSA storage. Therefore, it is important to ensure that the system CSA and ECSA sizes are adequately defined to handle the additional consumption of CSA storage resulting from the issuance of the dynamic LPA request. Further protection can be gained through the use of the **CSAMIN** parameter described below.

DELETE

Specifies that one or more modules be deleted from the LPA. Only modules added to the LPA after an IPL are eligible for dynamic deletion.

Default value: None

CSAMIN

Specifies the minimum amount of CSA and ECSA that must remain after a module is added to the LPA. If the requested ADD operation would reduce the CSA or ECSA below the defined minimum, the system rejects the operation.

Default value: (0,0)

below

The minimum amount of below-16M CSA storage that must remain after the ADD operation. The value can be expressed as *n*, *nK*, and *nM*.

above

The minimum amount of above-16M CSA storage that must remain after the ADD operation. The value can be expressed as *n*, *nK*, and *nM*.

MODNAME(modname, . . . , modname) | MODNAME=(modname, . . . , modname)

modname is the 1-8 character LPA module name or alias. If a *modname* has aliases, you must specify the module name and all of its aliases. If the last character of the *modname* is an asterisk (*), it will be treated as X'CO' — which lets you specify the name of a load module that ends with that non-printable character. You cannot use wildcard characters within *modname*. You can submit up to 128 module names, and you can use **MOD** or **MODULE** as synonyms of **MODNAME**.

Default value: None

MASK(mask) | MASK=mask

mask is the 1-8 character mask that is to be applied to all the members of the specified data set. It can contain wildcard characters * and ?, and all members that match will be processed.

Default value: None

DSNAME(dsname) | DSNAME=dsname

dsname is the 1-44 character data set name that contains the module(s) or alias(es). When **MODNAME** is specified, you can specify **DSNAME(LNKST)** if you want the system to search the lnkfst instead of a particular data set. The data set must be cataloged. It may be allocated as a PDS or PDSE program library.

The attribute of the CSA for each module is assigned as OWNER=SYSTEM. **DSN**, **LIB**, and **LIBRARY** can be used as synonyms of **DSNAME**.

Default value: None

PAGEABLE | FIXED

Indicates whether the modules are to be placed in pageable or fixed storage. **PAGE** can be used as a synonym for **PAGEABLE**.

Default value: PAGEABLE

PAGEPROTALL | PAGEPROTPAGE

Indicates whether or not to page protect entire modules. The default is to page protect the entire module (**PAGEPROTALL**). Be aware that when this default is taken, storage utilization for the modules increases because each module is allocated a number of whole pages (so that they can be page protected) rather than just the amount of storage that is necessary to load the module. **PPALL** and **PPA** can be used as synonyms for **PAGEPROTALL**.

When **PAGEPROTPAGE** is requested, only the whole pages within each load module are page protected, which minimizes storage use but also allows the possibility that a storage overlay of the beginning or end of the load module can occur. **PPPAGE** and **PPP** can be used as synonyms for **PAGEPROTPAGE**.

Default value: PAGEPROTALL

SVCNUMDEC=*svcnum* | SVCNUMDEC=(*svcnum*,*route*)

Identifies the entry to update within the SVC table. The SVC number, *svcnum*, must be in the range 0 - 255. For an extended SVC (109, 116, 122, 137), you must also specify *route*, which is the extended SVC routing code. The routing code must be within the range that is supported by the SVC. The routing code for SVC 109 must be in the range 0 - 255. The routing code for other extended SVCs depends on the z/OS release. Use the **SVCNUMDEC** function to update already-defined SVC table entries. Do not use it to create new entries because you might not get all of the attributes that you need. **SVCDEC** can be used as a synonym for **SVCNUMDEC**.

Default value: This is not an SVC routine. The SVC table is not updated.

ADDALIAS | NOADDALIAS

ADDALIAS (or **ALIAS**) indicates to process provided names and aliases of the provided names. **NOADDALIAS** (or **NOALIAS**) indicates to process only the names provided. You can use **NOADDALIAS** to override the default values set by **DEFAULTS LPA ADDALIAS**.

Default value: **NOADDALIAS**, or the value set by **DEFAULTS LPA ADDALIAS | NOADDALIAS**.

FORCE(YES) | FORCE=YES

Confirms that the delete requestor understands the ramifications of deleting a module from the LPA, when the system can have no knowledge of whether any code is currently executing within the specified module.

Default value: None. This is a required parameter.

CURRENT | OLDEST

CURRENT specifies to delete the current copy. **OLDEST** specifies to delete the oldest dynamic copy. You can use **CUR** as a synonym of **CURRENT**, and **OLD** as a synonym of **OLDEST**.

Default value: CURRENT

SETPROG command

Protecting REFR programs

Use the SETPROG REFRPROT command anytime after IPL to specify that REFR programs should be protected from modification. The complete syntax for the SETPROG REFRPROT command is:

```
SETPROG REFRPROT
```

Use the SETPROG NOREFRPROT command anytime after IPL to specify that REFR programs should not be protected. The complete syntax for the SETPROG NOREFRPROT command is:

```
SETPROG NOREFRPROT
```

For more information on protection of REFR programs, see *z/OS MVS Program Management: User's Guide and Reference*.

Tracking directed load modules

Use the SETPROG TRACKDIRLOAD command to enable system-wide tracking of directed load modules. A directed load module is a module that is directly loaded to a specified storage address. When enabled, mapping information about directed load modules is included in the maps produced by hardware instrumentation services (HIS). Directed load tracking is enabled by default. The complete syntax for the SETPROG TRACKDIRLOAD command is:

```
SETPROG TRACKDIRLOAD
```

Use the SETPROG NOTRACKDIRLOAD command to disable system-wide tracking of directed load modules. Any tracking information about directed load modules that was collected before issuing the SETPROG NOTRACKDIRLOAD command is preserved in the buffer and included in maps produced by HIS. The complete syntax for the SETPROG NOTRACKDIRLOAD command is:

```
SETPROG NOTRACKDIRLOAD
```

SETRRS command

Use the SETRRS command to control the RRS processing. Table 60 summarizes the information that the SETRRS command provides. Use it to access the pages on which you can find details about a particular use of the SETRRS command.

Table 60. Summary of the SETRRS command

Command	Topic
SETRRS ARCHIVELOGGING	"SETRRS ARCHIVELOGGING command" on page 737
SETRRS CANCEL	"SETRRS CANCEL command" on page 738
SETRRS SHUTDOWN	"SETRRS SHUTDOWN command" on page 739

Syntax

The syntax for each variation of the SETRRS command is shown immediately preceding its respective parameter list.

SETRRS ARCHIVELOGGING command

RRS writes to the archive log stream for each completed UR. RRS never uses the information written to the RRS archive log; the information is intended for the installation to use if a catastrophic problem occurs. Because of the performance impact of running RRS with the archive log stream, you can choose to run without it. This can be accomplished by deleting the archive log before starting any RRS image in the logging group, or, when RRS is operational, by using the SETRRS ARCHIVELOGGING command. Issuing the SETRRS ARCHIVELOGGING,DISABLE command should be done during a lull in transaction processing to prevent damage to chained sysplex cascaded records. If the overall goal is to delete the archive log, the DISABLE command can be issued at anytime.

Observations:

1. DISABLE/ENABLE is a flag setting within RRS and does not represent the actual state of the archive log stream. A DISABLE setting indicates that RRS on that system will not connect to or use the log, but the log stream might still be present. Conversely, starting RRS with an ENABLE setting and a deleted archive log stream will cause RRS to try to connect to the log stream, which will fail, resulting in the following message:

```
ATR132I RRS LOGSTREAM CONNECT HAS FAILED FOR OPTIONAL LOGSTREAM
ATR.PLEX1.ARCHIVE. RC=00000008, RSN=0000080B
```

2. To find the current status of the archive log stream, issue the following command:

```
D LOGGER,CONNECTION,JOBNAME=RRS,LSNAME=ATR.groupname.ARCHIVE
```

where *groupname* is the RRS logging group name. This will show the log streams currently connected to RRS on that system. The archive log will only appear in the list when it is connected.

Other DISPLAY LOGGER commands, such as:

```
D LOGGER,LOGSTREAM,LSNAME=ATR.groupname.ARCHIVE
```

show the status of the archive log stream connection anywhere in the sysplex. For instance, if system SY1 is disconnected and system SY2 is connected to the log stream, when the command is issued on SY1, the status shows IN USE because it is in use on SY2. The message text also indicates the systems that are connected to the log stream.

Syntax

The complete syntax for the SETRRS ARCHIVELOGGING command is:

```
SETRRS ARCHIVELOGGING[,DISABLE|ENABLE]
```

Note: The SETRRS command does not have an abbreviation.

SETRRS ARCHIVELOGGING command

Parameters

DISABLE

Indicates that the system is to disable the RRS archive logging for the subsequent transactions. RRS will stop writing the transaction completion records to the archive log and disconnect from the archive log stream.

ENABLE

Indicates that the system is to enable the RRS logging for the subsequent transactions. RRS will connect to the archive log stream and start writing the transaction completion records to the archive log. The **ENABLE** request is done by asynchronous processing and might take as long as 15 seconds before the Archive Log Stream is connected and the connection message (ATR175I) is issued.

SETRRS CANCEL command

Use the SETRRS CANCEL command to end resource recovery services (RRS) abnormally.

Use this command only at the direction of the system programmer. (Normally, you will not use this command because RRS should be running at all times; stopping RRS can cause application programs to abend or wait until RRS is restarted.)

While stopping, RRS abends incomplete commit and backout requests and passes return codes to the requesting application programs.

If SETRRS CANCEL does not work, the system programmer might suggest you use `FORCE jobname,ARM`, where *jobname* is that specified on the START command for RRS.

Note: You can also use the CANCEL command to stop RRS, but you cannot request a dump or specify any parameters except the jobname ATRRRS (or the name your installation has chosen).

Syntax

The complete syntax for the SETRRS CANCEL command is:

```
SETRRS CANCEL[,DUMP|NODUMP]
```

Note: The SETRRS command does not have an abbreviation.

Parameters

DUMP | NODUMP

Specify whether or not the system is to request an SVC dump of the RRS address space before RRS is stopped. If you omit the parameter, the default is NODUMP.

Example:

To stop RRS from running and request an SVC dump, enter:
SETRRS CANCEL,DUMP

SETRRS SHUTDOWN command

Issuing SETRRS SHUTDOWN provides a normal shutdown command to bring down RRS without resulting in a X'058' abend. In order to notify RRS resource managers that RRS is terminating, all the currently active resource managers will be unset. After the unset processing is completed, the RRS jobstep task and all of its subtasks will normally be terminated to clean up the address space. In addition to the RRS infrastructure tasks, there are also timed process tasks and server tasks running in the RRS address space. These tasks are also shut down normally as well.

Use this command only at the direction of the system programmer. (RRS should be running at all times; stopping RRS might cause application programs to abend or wait until RRS is restarted.)

Syncpoint processing for the outstanding work will be stopped by unsetting exits of resource manager. Resource manager will need to reset its exits and restart with RRS after RRS is restarted.

Unset resource managers:

As part of the RRS shutdown processing, it will queue any AtrRMUnset synchronous server request to perform the resource manager (RM) unset processing. The RM unset processing consists of the following:

1. Transitions the RM to UnsetInProgress state to prevent further RM requests.
2. Performs URI failed processing for all of the RM's interests.
3. Transitions RM to the unset state. RM will need to reset its exits with RRS when RRS comes back up.
4. Notifies the RM that its exits have been unset, and drives RM's notification exit with a specific ATR_RM_EXIT_UNSET reason code. A new reason code "Exit Manager Unavailable" will be returned to further explain why the RM's exits are unset.

If SETRRS SHUTDOWN does not work, the system programmer might suggest you use FORCE *jobname*,ARM, where *jobname* is that specified on the START command for RRS.

Note: You can also use the CANCEL RRS, SETRRS CANCEL and FORCE commands. Each has a different outcome. For more information on these commands, see *z/OS MVS System Commands*.

Syntax

The complete syntax for the SETRRS SHUTDOWN command is:

```
SETRRS SHUTDOWN
```

Note: The SETRRS command does not have an abbreviation.

Parameters

There are no parameters for this command.

Example:

SETRRS SHUTDOWN command

To stop RRS from running, enter:

```
SETRRS SHUTDOWN
```

SETSMF command

In contrast to the SET command, which allows an installation to specify a different SMFPRMxx parmlib member or restart SMF, the SETSMF command allows an installation to add a SUBPARM parameter or replace any previously-specified parameter in the active SMF parmlib member except the ACTIVE, PROMPT, SID, EXITS or AUTHSETSMF parameters. The SETSMF command cannot add a parameter to the active SMF parmlib member. To avoid possible confusion with the SET SMF command, use the abbreviation SS for the SETSMF command.

The SETSMF command is not authorized under either of the following conditions:

- The NOAUTHSETSMF SMFPRMxx parmlib option is specified.
- The PROMPT(IPLR) or NOPROMPT SMFPRMxx parmlib options are specified, and the AUTHSETSMF parmlib option is NOT specified.

The SETSMF command is authorized under either of the following conditions:

- The AUTHSETSMF SMFPRMxx parmlib option is specified.
- The PROMPT(LIST) or PROMPT(ALL) SMFPRMxx parmlib options are specified.

For details, refer to the SMFPRMxx parameters in *z/OS MVS Initialization and Tuning Reference*.

Syntax

The complete syntax for the SETSMF command is:

```
SETSMF parameter(value[,value]...)
```

Parameters

parameter

Specifies any SMF parameter in the SMFPRMxx member except ACTIVE, PROMPT, SID, EXITS or AUTHSETSMF. For more details about the SMFPRMxx member, refer to *z/OS MVS Initialization and Tuning Reference*.

value[,value]

Specifies the new value for the specified parameter.

Note:

1. More than one parameter can be changed as long as the length of the command does not exceed 124 characters.
2. Both the SUBSYS and SUBPARM specifications can be changed on the same SETSMF command as long as the subsystem name is the same.
3. SET SMF, SETSMF, and DISPLAY SMF commands cannot run simultaneously. One waits for the other to complete before starting.
4. The new values for STATUS or MAXDORM do not take effect until the old ones, if any, expire.
5. On z/OS V1R13 or earlier systems, you cannot use this command to dynamically change the value of the DSPSIZMAX parameter as either a global

option or as a suboption on the LSNAME or DEFAULTLSNAME parameters. You will receive either message IFA760I or IFA761I.

Example 1:

To set the SMF parameters for started tasks so that only system records are collected and checkpoint accounting records are taken every 30 minutes, enter:

```
SETSMF SUBSYS(STC,TYPE(0:127),INTERVAL(003000))
```

Example 2:

To set the SMF parameter NOMULCFUNC, which indicates that users of the IFAUSAGE service that registered specifying SCOPE=FUNCTION do not need to use IFAUSAGE with the REQUEST=FUNCTIONxxx parameters, enter:

```
SETSMF NOMULCFUNC
```

This allows a measured usage program using SCOPE=FUNCTION, such as DB2, to record only its registration data and omit recording the usage data.

Example 3:

To enable or disable the SMF Record Flood Automation facility, which resets all counts and any active flood situations, enter:

```
SETSMF FLOOD(ON)
```

or

```
SETSMF FLOOD(OFF)
```

Example 4:

To change the size of SMF logstream buffers, using DSPSIZMAX as a global option, enter the following command:

```
SETSMF DSPSIZMAX(1024M)
```

To change the value of DSPSIZMAX as a suboption of LSNAME or DEFAULTLSNAME, respectively, enter one of the following commands:

```
SETSMF LSNAME(lname,DSPSIZMAX(1024M))
```

```
SETSMF DEFAULTLSNAME(lname,DSPSIZMAX(1024M))
```

SETSMS command

Use the SETSMS command when the Storage Management Subsystem (SMS) is active (running) to change a subset of SMS parameters from the console without changing the active IGDSMSxx member of SYS1.PARMLIB. Changes that you make with the SETSMS command persist until a subsequent SETSMS command is run for the same option, until the next SET SMS=xx command is run, or until the next system IPL.

Use the SETSMS command to:

- Activate a new SMS configuration by specifying an active configuration data set (ACDS), a source control data set (SCDS), or both data sets. This action affects all MVS systems in the SMS complex.
- Replace the active configuration data set (ACDS) by specifying an ACDS different from the one that SMS is currently using. This action affects all MVS systems in the SMS complex.

SETSMS command

- Replace the communications data set. This action affects all MVS systems in the SMS complex.
- Save the active configuration in a data set.
- Override (but do not physically change) the specifications of the keyword CA_RECLAIM in IGDSMSxx and data classes.
- Change the synchronization interval (INTERVAL). This change applies only to the system on which you issue the SETSMS command.
- Change the interval (DINTERVAL) that SMS waits between reading device statistics from the 3990-3 control unit (applicable only if the 3990-3 is installed and has at least one SMS-controlled volume). This change applies only to the system on which you issue the SETSMS command.
- Change the number of seconds that the dss component of DFMSMS will wait during backup processing for quiesce data set requests to complete (DSSTIMEOUT).
- Change the interval that SMS waits between recording cache control unit summaries (applicable only if the 3990-3 is installed and has at least one SMS-controlled volume). This change applies only to the system on which you issue the SETSMS command.
- Change the interval that SMS waits between recording of BMF (buffer management facility) statistics. This change applies only to the system on which you issue the SETSMS command.
- Change the maximum number of times that the buffer management facility (BMF) least recently used (LRU) routine will pass over inactive buffers before making them available for reuse (LRUCYCLES).
- Change the number of seconds that the buffer management facility (BMF) will wait between calls to the BMF data space cache LRU (least recently used) routine (LRUTIME).
- Specify trace options for SMS. This change applies only to the system on which you issue the SETSMS command.
- Specify deadlock detection intervals.
- Change the SMF interval time for recording SMF type 42 records.
- Change the new log of logs name, used by DFSMStvs.
- Change the maximum number of unique lock requests that a single unit of recovery can make.
- Change the quiesce exit timeout value to specify the amount of time the DFSMStvs quiesce exits will allow to elapse before concluding that a quiesce cannot be completed successfully.
- Change the maximum time that a VSAM RLS or DFSMStvs request is to wait for a required lock before the request is assumed to be in deadlock.
- Change the virtual storage size that is used to cache PDSE directory buffers in the SMSPDSE1 restartable address space. The directory buffers reside in 64-bit addressable virtual memory. The PDSE1_DIRECTORY_STORAGE parameter allows a change of the PDSE1_DIRECTORY_STORAGE that is either defaulted at IPL, or specified in the IGDSMSxx parameter in SYS1.PARMLIB. You must restart the SMSPDSE1 address space in order for this change to become effective.
- Change the hiperspace storage size that is used for PDSE member caching in the SMSPDSE1 restartable address space. The PDSE1_HSP_SIZE parameter allows a change of the PDSE1_HSP_SIZE that is either defaulted at IPL or specified in the IGDSMSxx parameter in SYS1.PARMLIB. You must restart the SMSPDSE1 address space in order for this change to become effective.

- Change the buffer-beyond-close option that is used to manage the cache of PDSE directory and member buffers in the SMSPDSE1 restartable address space. The directory buffers reside in 64-bit addressable virtual memory and optionally member data resides in a hiperspace. The PDSE1_BUFFER_BEYOND_CLOSE parameter allows a change of the PDSE1_BUFFER_BEYOND_CLOSE that is either defaulted at IPL, or specified in the IGDSMSxx parameter in SYS1.PARMLIB. You must restart the SMSPDSE1 address space in order for this change to become effective.
- Suppress DELETE/RENAME messages issued to hardcopy and job logs. See “SUPPRESS_DRMSGS({YES|NO})” on page 751.
- Change the values of the automatic class selection (ACS) read-only variable &USER_ACSVAR. The values for &USER_ACSVAR are specified in the IGDSMSxx parameter in SYS1.PARMLIB.

For more information about the ACDS, SCDS, and COMMDS data sets, see *z/OS DFSMSdfp Storage Administration* and *z/OS DFSMSdfp Diagnosis*.

If you are not sure about the differences between SET SMS and SETSMS, see Table 61.

Table 61. Comparison of SET SMS with SETSMS

Difference	SET SMS Command	SETSMS Command
When and how to use the command	Initializes SMS parameters and starts SMS if it has been defined but not started at IPL time. Changes SMS parameters if SMS is already running.	Changes SMS parameters only when SMS is running.
Where the parameters are entered	In the IGDSMSxx member of SYS1.PARMLIB.	At the console.
What default values are available	Default values are used for unspecified parameters except for BLOCKTOKENSIZE. If you omit BLOCKTOKENSIZE, the previous value in effect remains in effect. In z/OS 1.7, the original value of BLOCKTOKENSIZE is REQUIRE and in z/OS 1.8 and later the original value of BLOCKTOKENSIZE is NOREQUIRE.	No default values. Unspecified parameters remain unchanged.

Some combinations of SETSMS parameters are not valid. Table 62 on page 744 shows these incorrect combinations.

Requirement: The SCDS is a required parameter if the ACDS does not contain a valid configuration.

Note: The SCDS is a required parameter if the ACDS does not contain a valid configuration.

SETSMS command

Table 62. Incorrect Combinations of SETSMS Parameters

Parameter	ACDS	SCDS	COMMDS	SAVEACDS
ACDS	N/A		Not Valid	Not Valid
SCDS		N/A	Not Valid	Not Valid
COMMDS	Not Valid	Not Valid	N/A	Not Valid
SAVEACDS	Not Valid	Not Valid	Not Valid	N/A

Scope in a sysplex

The SETSMS command has sysplex scope only if you are changing the SCDS, ACDS, or COMMDS, and only if all systems in the sysplex are in the same SMS complex. See “Using commands that have sysplex scope” on page 12 for an explanation of sysplex scope.

Other parameters that have sysplex scope are as follows:

- RLSABOVETHEBARMAXPOOLSIZE
- RLSFIXEDPOOLSIZE
- RLSTMOUT
- DEADLOCK

Syntax

The complete syntax for the SETSMS command is:

```
SETSMS parameter(value) [,parameter(value)] ...
```

Note: No imbedded blanks are allowed between parameters on this command.

Parameters

parameter(value) is one of the following:

Configuration Parameters

ACDS(*dsname*)

The *dsname* specifies a data set that has been defined as an active control data set. The information in the data set is copied into the SMS address space to create (or replace) the active configuration. This parameter affects all MVS systems in the SMS complex. The command format is:

```
SETSMS ACDS(dsname)
```

AKP({*nnn* [,*nnn* [...,*nnn*]] | 1000})

Specifies one or more activity keypoint trigger (AKP) values. Each AKP value (*nnn*) is the number of logging operations between the taking of keypoints. You can specify up to 32 activity keypoint values. AKP values must be specified in the same order as DFSMStvs instance names. Valid values are from 200 to 65535. The default is 1000.

The command format follows:

```
SETSMS AKP(1000)
```

BreakPointValue(*nnnnn*)

The BreakPointValue (BPV) specifies the disk space request (primary or secondary), expressed as the number of cylinders (0-65520), where the system should prefer the cylinder-managed space (CMS) on an extended address volume (EAV).

The BPV is only applicable to data sets that are extended address space (EAS) eligible. Data sets that are not EAS-eligible must reside in the track-managed region of a volume.

When a disk space request is equal to or greater than the BPV, the system will prefer to use the CMS for that extent. If not enough CMS is available, the system will use track-managed space (TMS), or both CMS and TMS.

If the requested disk space is less than the BPV, the system will prefer to use TMS. If not enough TMS is available, the system will use CMS, or both TMS and CMS.

BreakPointValue is an optional parameter. If not specified at the storage group level, the system will use the value specified in the IGDSMSxx member of parmlib, or a default value of 10 cylinders if no BPV is specified in the IGDSMSxx member.

CA_RECLAIM(NONE | {DATACLAS | DATACLASS})

Overrides the specifications of the keyword CA_RECLAIM in IGDSMSxx and data classes. SETSMS CA_RECLAIM has no default. When NONE is specified, no KSDS will do CA reclaim, regardless of the data classes and SYS1.PARMLIB specifications. Specifying DATACLAS or DATACLASS enables CA reclaim for data classes with CA Reclaim=Y.

The SETSMS command takes effect on SMS-managed and non-SMS-managed KSDSs immediately, regardless of which system defined the KSDS, though the CA reclaim already in progress will not be interrupted by the command.

Systems earlier than V1R12 will not do CA reclaim, and will reject the new SETSMS options with an existing message.

If a CA reclaim is interrupted because of Cancel or ABENDs, the other requests running on z/OS V1R12 systems might complete the CA reclaim, regardless of the SETSMS command.

For VSAM and VSAM RLS, the SETSMS command is system-wide. To make the SETSMS command sysplex-wide, route the command to the other systems with the ROUTE option RO *ALL, SETSMS.

COPYSCDS(*scds_dsn*, *acds_dsn*)

Specifies that SMS is to copy an SCDS (specified by *scds_dsn*) into an ACDS (specified by *acds_dsn*). Although typically the only way to create an ACDS is to activate an SCDS, you might not want to activate an SCDS for this purpose. For example, you might have a production system that creates and maintains an SCDS for a disaster recovery system, and you want the corresponding ACDS to be available during the IPL of the disaster recovery system. However, you do not want to activate the SCDS on the production system. Without using COPYSCDS, activating the SCDS was the only way to create the disaster recover ACDS. COPYSCDS provides an alternate way to create a copy of a SCDS as an ACDS without having to activate the SCDS. Do not specify COPYSCDS in the same command as ACDS, SCDS, SAVESCDS or SAVEACDS.

SCDS(*dsname*)

SMS is to use the specified source control data set (SCDS) to activate a new configuration. This parameter affects all MVS systems in the SMS complex.

If the ACDS is empty or does not contain a valid configuration (possibly because of a damaged data set), use the SCDS parameter to specify a source control data set. The command format is:

```
SETSMS ACDS(dsname),SCDS(dsname2)
```

SETSMS command

If the ACDS is empty and no SCDS is specified, SMS issues a message that identifies the specified control data set as non-valid.

Note: Do not specify the SCDS parameter if the ACDS *does* contain a valid configuration; the SCDS will overlay the ACDS. To recover from such accidental loss, it is a good idea to maintain a backup copy of the current ACDS to be activated in case of damage to the main copy.

SAVEACDS(dsname)

Specifies the ACDS that SMS is to use to save to DASD the active configuration from the SMS address space. SAVEACDS is one way to create a backup ACDS. Do not specify SAVEACDS in the same command as ACDS, SCDS, or SAVESCDS.

SAVESCDS(dsname)

Specifies the SCDS that SMS is to use to save to DASD the active configuration from the SMS address space. SAVESCDS is one way to create a backup SCDS. Do not specify SAVESCDS in the same command as ACDS, SCDS, or SAVEACDS.

COMMDS(dsname)

SMS is to use the named data set as the new communications data set.

If the replacement COMMDS is empty, SMS primes it with information from the active configuration. If the data set is not empty, SMS determines which ACDS was used to prime the new data set. If the ACDS named on COMMDS is the same as the one that is active, processing continues with the new COMMDS. Otherwise, SMS prompts the operator (by message IGD076D) to decide whether SMS should use the ACDS named on COMMDS or continue to use the current ACDS.

Note:

1. If SMS cannot re-access the previously active communications data set, the operator must issue the command to change the COMMDS on each MVS system in the SMS complex.
2. The COMMDS parameter is mutually exclusive with ACDS, SCDS, and SAVEACDS.

FAST_VOLSEL(ON|OFF)

Specifies whether to use the 'fast' approach during SMS volume selection.

If you specify ON, SMS first selects volumes typically until DADSM rejects 100 volumes for insufficient free space. SMS issues message IGD17294I to indicate that 'fast' volume selection has been entered and then excludes volumes that do not have sufficient free space in the volume statistics. This 'fast' approach can inadvertently exclude volumes that have sufficient free space but for which SMS volume statistics indicates that they do not. SMS volume statistics can occur for the following events:

- The VTOC index is broken.
- OEM products bypass CVAF processing.
- In an SMSplex when the SMS synchronization time interval has not yet been driven to update the SMS configuration with the most current space statistics. These statistics are based on updates that can occur on another system in the SMSplex

If you specify OFF, SMS uses the 'normal' approach to select volumes.

The default is OFF.

HONOR_DSNTYPE_PDSE(YES|NO)

Specifies whether DSNTYPE of LIBRARY or HFS will be honored during the data set creation, regardless of what DSORG is specified and regardless of whether directory blocks have been specified. If YES is specified, then DSNTYPE of LIBRARY or HFS will be honored even if the DSORG is not set to PO and there are no directory blocks specified. If NO is specified, DSNTYPE of LIBRARY or HFS will be honored only when the DSORG is set to PO or directory blocks are specified; otherwise, a physical sequential data set will be created.

Default: NO

MAXLOCKS({max|0},{incr|0})

Specifies a pair of values in the range of 0 to 999999. The two values are the maximum number of unique lock requests that a single unit of recovery can make, and an increment value. Once the maximum number of unique lock requests is reached, warning messages are issued every time the number of unique lock requests over and above the maximum increases by a multiple of the increment. When the maximum number is reached, warning message IGW859I is issued to the system console, and message IGW10074I is issued to the job log. The messages include the name of the job that is holding the locks. This information will help you to determine whether the job should be canceled, in which case the unit of recovery will be backed out, and the locks will remain held until the backout completes. Specifying a value of 0 indicates that warning messages IGW859I and IGW10074I should not be issued.

This parameter applies across all systems.

Note:

1. Lock requests are considered unique if they lock different records within the base cluster. Repeated requests for the same base cluster records will not result in the count being incremented.
2. Warning messages IGW859I and IGW10074I are not issued for units of recovery that are in backout. This is because a unit of recovery that is in backout cannot obtain locks on any additional records.
3. Messages IGW859I and IGW10074I are issued until the unit of recovery reaches commit. Once the unit of recovery reaches commit, no additional messages will be issued.
4. To avoid flooding the system console with messages, messages IGW859I and IGW10074I are issued by an asynchronous timer driven task that wakes up every 10 seconds. This means that the messages will not necessarily reflect the exact values specified for the maximum and the increment, but rather will reflect the values which represent the state of the unit of recovery at the time the task awakens.
5. MAXLOCKS takes into account the number of unique lock requests. It does not count the actual number of locks obtained. The number of locks requested will differ from the number of locks held when alternate indexes are used. If an update modifies alternate keys, a lock is obtained for the base record, for each old alternate key, and for each new alternate key. Therefore, if n alternate keys are modified, a single lock request can result in obtaining $(2n+1)$ locks.

Some examples of how this parameter can be specified are:

MAXLOCKS(0,0)

Valid - messages IGW859I and IGW10074I will never be issued.

SETSMS command

MAXLOCKS(,)

Valid - this is the equivalent of specifying MAXLOCKS(0,0); messages IGW859I and IGW10074I will never be issued.

MAXLOCKS(5000,0)

Valid - messages IGW859I and IGW10074I will be issued when the asynchronous task wakes up and a unit of recovery has made its 5000th lock request.

MAXLOCKS(0,2000)

Not valid

MAXLOCKS(4500,1000)

Valid - messages IGW859I and IGW10074I will be issued when the asynchronous task wakes up and a unit of recovery has made its 4500th lock request and again every 1000 unique lock requests thereafter.

MAXLOCKS(1000,2300)

Valid - messages IGW859I and IGW10074I will be issued when the asynchronous task wakes up and a unit of recovery has made its 1000th lock request and again every 2300 unique lock requests thereafter.

MAXLOCKS(3200,)

Valid - this is the equivalent of specifying MAXLOCKS(3200,0); messages IGW859I and IGW10074I will be issued when the asynchronous task wakes up and a unit of recovery has made its 3200th lock request.

MAXLOCKS(,2000)

Not valid

The default for both values is 0.

PDSE1_BUFFER_BEYOND_CLOSE (YES | NO)

For the SMSPDSE1 address space, specifies whether to keep directory and member data in memory beyond the last close on this system of a PDSE data set. For the NO option, a PDSE directory and member data will be purged from the in-memory cache when the last close of the data set occurs. If you specify the YES option, the system retains the PDSE directory and member data in the in-memory cache beyond the last close of the data set. You must restart the SMSPDSE1 address space in order for this change to become effective.

PDSE1_DIRECTORY_STORAGE (nnn)

The operand size values are defined with nnnM for megabytes, or nnnG for gigabytes. For example, to request a 500 megabytes size for the SMSPDSE1 restartable address space 64-bit virtual directory cache, specify SETSMS PDSE1_DIRECTORY_STORAGE(500M). You must restart the SMSPDSE1 address space in order for this change to become effective.

Maximum: 16 Gigabytes

Minimum: 64 Megabytes

PS_EXT_VERSION(1|2)

Indicates the format in which the system should create sequential extended format data sets. The default is to make no change to the current value for PS_EXT_VERSION. A value of 1 denotes the version 1 format. If you specify PS_EXT_VERSION(2), it means that when anyone creates a sequential extended format data set, it will be version 2.

If DFSMSdss processes an extended format multivolume, non-striped data set that is version 1, it cannot use FlashCopy. This results in reduced performance

for the copying or the back up. If the data set is version 2, DFSMSDss can use FlashCopy. That generally results in improved performance for the operation.

If you do not wish to exploit this version 2 capability, you do not need to take any action. The associated catalog entry will indicate whether the data set is version 1 or version 2. You can display the data set version via IDCAMS LISTCAT and DCOLLECT.

PDSE1_HSP_SIZE(*nnnn*)

Requests up to 2047 megabytes for the PDSE1 hiperspace. You can also indicate that the hiperspace is not to be created by setting PDSE1_HSP_SIZE to 0. If the hiperspace is not created, the system does not cache PDSE member data. You must restart the SMSPDSE1 address space in order for this change to become effective.

PDSE_SYSEVENT_DONTSWAP (YES | NO)

Specifies whether the task that enters the SMSPDSE or SMSPDSE1 address space is placed in DONTSWAP to prevent the task from being swapped out while holding internal PDSE latches or locks. Specifying this parameter can delay the system from being swapped out, but prevents PDSE processing from being delayed by a swapped address space. The default value is NO.

QTIMEOUT({*nnn*|300})

Specifies the quiesce exit timeout value in seconds. The quiesce timeout value specifies the amount of time the DFSMSStvs quiesce exits will allow to elapse before concluding that a quiesce cannot be completed successfully. Specify a value between 60 to 3600. Changing the value of QTIMEOUT affects only those quiesce requests that are submitted after the change is made; it has no effect on quiesce requests that are already in progress. The default is 300.

The command format is:

```
SETSMS QTIMEOUT(300)
```

RLS_MAXCFFEATURELEVEL({*A*|*Z*})

Specifies the method that VSAM RLS uses to determine the size of the data that is placed in the CF cache structure. If you specify A, caching proceeds using the RLSCFCACHE keyword characteristics that are specified in the SMS data class that is defined for the VSAM sphere. If you do not specify a value, or if you specify Z, then only VSAM RLS data that have a Control Interval (CI) value of 4K or less are placed in the CF cache structure. The default is Z.

Restrictions:

- If A is specified for the RLS_MAXCFFEATURELEVEL parameter, systems lower than V1R3 will not be able to connect to the CF cache structure.
- If a lower-level system is the first system activated in the sysplex, RLS_MAXCFFEATURELEVEL defaults to Z, and all systems will be able to connect to the CF cache structure.
- If the SETSMS command is used to change the RLS_MAXCFFEATURELEVEL value to A on a mixed-level system, the command is rejected and message IGW500I is issued.

RLS_MAX_POOL_SIZE

Specifies the maximum size in megabytes of the SMSVSAM local buffer pool. SMSVSAM attempts to not exceed the buffer pool size you specify, although more storage might be temporarily used. Because SMSVSAM manages buffer pool space dynamically, this value does not set a static size for the buffer pool.

Use SMF 42, subtype 19 records to help you determine the maximum size of the SMSVSAM local buffer pool.

SETSMS command

You can specify a two to four-digit numeric value, with 10 as the minimum value. If you specify a value less than 10, the field is set to 10. If you specify a value greater than 1500, SMSVSAM assumes there is no maximum limit. IBM recommends that you limit the size of the local buffer pool.

The default is 100.

RLSINIT({NO|YES})

Specifies whether you want the SMSVSAM address space started. Specify YES if you want the SMSVSAM address space started as part of system initialization or the V SMS,SMSVSAM,ACTIVE command.

RLSTMOUT({nnn|0})

Specifies the maximum time, in seconds, that a VSAM RLS or DFSMStvs request is to wait for a required lock before the request is assumed to be in deadlock and ended with VSAM return code 8 and reason code 22 (X'16'). Specify a value in seconds between 0 to 9999. A value of 0 means that the VSAM RLS or DFSMStvs request has no time out value; the request will wait for as long as necessary to obtain the required lock.

VSAM RLS detects deadlocks within VSAM and DFSMStvs. VSAM RLS cannot detect deadlocks across other resource managers, and uses the timeout value to determine when such deadlocks might have occurred. You can specify a global timeout value in the IGDSMSxx member of SYS1.PARMLIB, a step level timeout value on the JCL, or a timeout value on the RPL passed for each VSAM request.

For a particular VSAM RLS or DFSMStvs request, the value used for timeout is:

1. The value specified in the RPL, if any.
2. The value specified in the JCL at the step level, if any.
3. The value specified in the IGDSMSxx member of SYS1.PARMLIB, if any.

RLSTMOUT is a valid parameter for either VSAM RLS or DFSMStvs. If you specify RLSTMOUT but do not specify the TVSNAME parameter, the value is used only by RLS. For DFSMStvs, the first instance of DFSMStvs brought up within the sysplex determines the value. Subsequent DFSMStvs instances use the value established by the first system, regardless of what might be specified in their members of SYS1.PARMLIB.

RLSTMOUT can be specified only once in a sysplex and applies across all systems in the sysplex.

The default is 0.

RLSABOVETHEBARMAXPOOLSIZE(ALL,size)

RLSABOVETHEBARMAXPOOLSIZE(sysname1,size1;sysname2,size2;... sysname32,size32)

Specifies the total size of the BMF buffer pool that resides above the bar for either of the following:

- All systems
- Each system referenced in the parameter

Valid values are between 500MB and 2,000,000MB (2 Terabytes).

The default is 0.

RLSFIXEDPOOLSIZE(ALL,size)

RLSFIXEDPOOLSIZE(sysname1,size1;sysname2,size2;...sysname32,size32)

Specifies the amount of the total real storage, both above and below the 2 gigabyte bar, that will be permanently fixed (pinned) on either of the following:

- All systems
- Each system referenced in the parameter

The default is 0.

SAM_USE_HPF({YES|NO})

Specifies whether or not you want BAM to use HPF when it is available. HPF can be enabled by specifying ZHPF=YES on the ZHPF statement in the IECIOSxx parmlib member.

- YES specifies that you want BAM to use HPF when it is available and enabled. If you specify or default to SAM_USE_HPF(YES), SMS sets on a new bit in the DFA, DFASAMHPF.
- NO specifies that BAM should not use HPF. If you specify SAM_USE_HPF(NO), the DFASAMHPF bit in the DFA control block is set off and BAM does not use HPF.

Default: YES

SUPPRESS_DRMSG({YES|NO})

Specifies whether SMS suppresses DELETE/RENAME messages issued to the hardcopy log and job log.

- Specifying YES suppresses DELETE/RENAME messages to the hardcopy log and job log.
- Specifying NO does not suppress DELETE/RENAME messages to the hardcopy log and job log.

Note that this parameter does not suppress callers from issuing the DELETE/RENAME messages. Some callers of SMS issue these messages and some do not.

The SCOPE of this parameter is the entire system.

The default is NO.

SUPPRESS_SMSMSG({YES|NO,IGD17054I,IGD17227I,IGD17395I})

Specifies whether SMS messages, IGD17054I, IGD17227I, and/or IGD17395I are to be issued or suppressed. If YES is specified, these specific messages are to be suppressed. If NO is specified, these messages will be issued. The user may specify one or more of the applicable messages in this parameter.

Default: NO

Interval Parameters

INTERVAL(*nnn*)

SMS on the command-issuing system is to allow *nnn* seconds (1 to 999) to pass before synchronizing with the other SMS subsystems running on other MVS systems in the complex. The default value from SMS initialization is 15 seconds. This parameter applies only to the system issuing the command.

DINTERVAL(*nnn*)

Directs SMS to allow *nnn* seconds (1 to 999) to elapse between reading device statistics from a 3990-3 control unit. The default is 150 seconds.

DSSTIMEOUT(*nnnn*)

Specifies the number of seconds that the dss component of DFMSMS will wait during backup processing for quiesce data set requests to complete. Specify a

SETSMS command

value from zero to 65536 seconds (which is more than 18 hours). If you specify a value between 1 and 299 seconds, the system uses a value of 300 seconds (which equals 5 minutes). The default is 0 seconds.

The value specified in the DSSTIMEOUT parameter value is activated when the first instance of the SMSVSAM address becomes active in the sysplex. All subsequent SMSVSAM instances will use the same value.

CACHETIME(*nnnnn*)

Directs SMS to allow *nnnnn* seconds (1 to 86399) to elapse between recording SMS cache control unit summaries for 3990-3 control units. The default is 3600 seconds.

BMFTIME(*nnnnn*)

Specifies that SMS is to allow *nnnnn* seconds (1 to 86399) to elapse between the production of SMS BMF SMF type 42 subtype 1 records and SMFtype 42 subtype 6 interval records. The default is 3600 seconds. This change will take effect at the expiration of the current interval or, for SMSPDSE1, when it is restarted, whichever comes first. The default is 3600 seconds.

DEADLOCK_DETECTION(*iiii, kkkk*)

Specifies the deadlock detection intervals used by SMSVSAM.

iiii 1 to 4 digit numeric value in the range 1-9999 that specifies the length in seconds of the local deadlock detection interval. The default for *iiii* is 15 seconds.

kkkk 1 to 4 digit numeric value in the range 1-9999 that specifies the number of local deadlock cycles that must expire before global deadlock detection is performed. The default for *kkkk* is 4 local cycles.

LRUCYCLES(*cycles*)

Specifies the maximum number of times (5 to 240) that the buffer management facility (BMF) least recently used (LRU) routine will pass over inactive buffers before making them available for reuse. This parameter sets the *maximum* value, and BMF dynamically changes the *actual* number of times that it passes over inactive buffers.

LRUCYCLES is related to LRUTIME. A change to the LRUCYCLES value introduced by this parameter will take effect on the next execution of the LRU routine. Most installations should use the default value. In some very high data rate situations you may want to tune this value. You should monitor the SMF 42 type 1 record to determine the amount of caching activity in the BMF data space. See *z/OS MVS System Management Facilities (SMF)* for information about the buffer management statistics recorded in SMF record type 42. The default value is 240 BMF LRU cycles.

LRUTIME(*seconds*)

Specifies the number of seconds (5 to 60) that the buffer management facility (BMF) will wait between calls to the BMF data space cache LRU (least recently used) routine. That routine releases inactive buffers in the BMF data space that are used to cache PDSE (partitioned data set extended) directory data.

LRUTIME is related to LRUCYCLES. A change to the LRUTIME value introduced by this parameter will take effect on the next execution of the LRU routine. Most installations should use the default value. In some very high data rate situations you may want to tune this value. You should monitor the SMF 42 type 1 record to determine the amount of caching activity in the BMF data space. See *z/OS MVS System Management Facilities (SMF)* for information about the buffer management statistics recorded in SMF record type 42. The default value is 15 seconds.

SMF_TIME(YES or NO)

When SMF_TIME(YES) is specified, DFSMS type 42 SMF records are created at the SMF interval time. This parameter overrides all other DFSMS interval time parameters which relate to SMF type 42 records. SMF_TIME(YES) applies to SMF 42 subtypes 1, 2, 15, 16, 17, 18 and 19.

SMF_TIME(NO) specifies that SMF records will not be synchronized at the SMF interval time.

CF_TIME(*nnn* or 3600)

Specifies the interval (in seconds) for recording SMF record 42 (subtypes 15, 16, 17, 18 and 19) for the SMSVSAM address space's use of the coupling facility.

If you record these subtypes, you can use CF_TIME to synchronize SMF type 42 data with SMF and RMF data intervals.

Valid values are from 1 to 86399 (23 hours, 59 minutes, 59 seconds). The default is 3600 (one hour).

The SMF_TIME parameter, if set to YES, overrides the CF_TIME parameter.

CICSVR Option Parameters**CICSVR_INIT(YES or NO)**

When CICSVR_INIT(YES) is specified, the CICSVR address space will be started as part of system initialization or by the operator issuing V SMS,CICSVR,ACTIVE command.

CICSVR_DSNAME_PREFIX(*user_prefix*)

Defines a prefix for all CICSVR data set names, excluding RCDS data sets, DWWCON1, DWWCON2, and DWWCOM3 that are created by CICSVR. This allows users to change the naming convention used by CICSVR.

CICSVR_RCDS_PREFIX(*cicsvr_rcds_prefix*)

Allows operators to change the prefix of CICSVR Recovery Control Data Set (RCDS) names from the console without changing the active IGDSMSxx parmlib member.

CICSVR_ZZVALUE_PARM(*zzvalue_string*)

Allows operators to change ZZVALUE strings from the operator console without changing the active IGDSMSxx parmlib member.

Trace and VOLSELMSG Option Parameters**TRACE (ON or OFF)**

SMS tracing is to be turned on or off.

The following parameters specify the size of the trace table, the type of errors to be traced, the jobname or ASID to be traced, and the particular events that are to be selected (turned on) for tracing or deselected (turned off). The TRACE, SELECT, and DESELECT parameters apply only to the system on which the operator issues the SETSMS command.

Default values, if no trace values are specified in SYS1.PARMLIB, consist of TRACE (ON), SIZE (128K), TYPE (ERROR), JOBNAME (*), which means all jobs, ASID (*), which means all address spaces, and SELECT (ALL). Final values consist of the sum of the defaults (where not overridden), the values in SYS1.PARMLIB, and those added by SETSMS SELECT or removed by SETSMS DESELECT.

SETSMS command

SIZE(*nnnnnn*, or *nnnnnnK*, or *nnnM*)

Specifies the size of the trace table in kilobytes. If you omit K or M, the default unit is K. The default value is 128K. The maximum is 255000K or 255M. This value is rounded up to the nearest 4K.

Note: If you specify a size that is different from the previously-used value, a new trace data area is built, the old trace data area is deleted, and no trace data is saved. If, however, the size you specify is the same as the previously-used size, no new trace data area is built. If you specify zero, the existing trace data area is deleted without being replaced.

TYPE(ERROR|ALL[(TRACE|T|VOLSELMSG|V)[,ALL|ERROR(TRACE|T|VOLSELMSG|V)])

Specifies how you want to trace events and issue volume selection analysis messages.

ERROR

Specify ERROR to trace error events (TRACE(ON)) and issue volume selection analysis messages (VOLSELMSG(ON)) on failure allocations. The default value from SMS initialization is ERROR.

ALL

Specify ALL to trace all events (TRACE(ON)) and issue volume selection analysis messages (VOLSELMSG(ON)) on all allocations.

[(TRACE|T|VOLSELMSG|V)[,ALL|ERROR(TRACE|T|VOLSELMSG|V)])

These are optional sub-parameters. TRACE|T or VOLSELMSG|V associated with the first sub-parameter specifies whether the required value specified in the first sub-parameter applies to TRACE or VOLSELMSG facility. The second sub-parameter specifies another value and facility after the first sub-parameter is specified. When none of these optional sub-parameters are specified, the value specified in the first sub-parameter applies to both TRACE and VOLSELMSG. For example, if you want to set a TYPE value of ERROR for the SMS TRACE facility, and a TYPE value of ALL for the VOLSELMSG facility, you could code: TYPE(ERROR(TRACE),ALL(VOLSELMSG)).

USEEAV (YES|NO)

Specifies, at the system level, whether SMS can select an Extended Address Volume during volume selection processing. This check applies to new allocations and when extending data sets to a new volume.

YES

This means that Extended Address Volumes can be used to allocate new data sets or to extend existing data sets to new volumes.

NO This is the default and means that SMS does not select any Extended Address Volumes during volume selection. Note that data sets might still exist on Extended Address Volumes in either the track-managed or cylinder-managed space of the volume.

When SMS is not active in the system, USEEAV is not available and the installation must use alternate means to control the usage of Extended Address Volumes.

VOLSELMSG(ON|OFF,0|*nnnnn*|ALL)

Allows you to control volume selection analysis messages issued when you create or extend a SMS-managed data set to a new volume. These analysis messages are written to the hardcopy log and the joblog.

ON|OFF

Controls whether or not SMS volume selection analysis messages are being issued. The default is OFF.

0|nnnn|ALL

Controls whether or not detailed analysis messages are being issued and the number of volumes to be included in them. The default is 0.

0 Only summarized analysis messages are issued.

nnnn

Indicate the number of volumes to be included in the message with a range of 0 to 65535.

ALL

Indicates that all volumes used for volume selection will be included in detailed analysis messages.

If you specify VOLSELMSG(nnnn|ALL), with nnnn having a value greater than 0 along with TYPE(ALL), you must also specify one of the following parameters to limit the number of detailed analysis messages issued:

- JOBNAME
- ASID
- STEPNAME
- DSNNAME

When all volumes are to be included, volumes are listed by storage group. If only a subset of volumes is to be included, volumes are listed in volume selection preference order with no association to storage group.

The system can issue an excessive number of analysis messages to the spool when the following conditions occur:

- The job or address space creates or extends numerous SMS-managed data sets
- Many volumes are to be included in the analysis messages

JOBNAME(*jobname* | * [(TRACE|T|VOLSELMSG|V) [, *jobname* | *(TRACE|T|VOLSELMSG|V)]])

Specify JOBNAME to limit tracing (TRACE(ON)), issue volume selection messages (VOLSELMSG(ON)), or both, to particular jobs. Specify *, to select *all* jobs. If you specify JOBNAME, omit ASID.

[(TRACE|T|VOLSELMSG|V)[*jobname* | *(TRACE|T|VOLSELMSG|V)]] are optional sub-parameters. TRACE|T or VOLSELMSG|V associated with the first sub-parameter specifies whether the required value specified in the first sub-parameter applies to TRACE or VOLSELMSG facility. The second sub-parameter specifies another value and facility after the first sub-parameter is specified. When none of these optional sub-parameters are specified, the value specified in the first sub-parameter applies to both TRACE and VOLSELMSG. For example, if you want to have all jobs for the SMS TRACE facility, and a particular job, JOB111, for the VOLSELMSG facility, you could code: JOBNAME(*(TRACE),JOB111(VOLSELMSG)).

ASID(*asid* | * [(TRACE|T|VOLSELMSG|V) [, *asid* | *(TRACE|T|VOLSELMSG|V)]])

Specify ASID to limit tracing (TRACE(ON)) and/or issue volume selection messages (VOLSELMSG(ON)) to particular address spaces. The default is to permit them for all address spaces. Specify *, to select *all* address spaces. If you specify ASID, omit JOBNAME.

[(TRACE|T|VOLSELMSG|V)[*asid* | *(TRACE|T|VOLSELMSG|V)]] are optional sub-parameters. TRACE|T or VOLSELMSG|V associated with the

SETSMS command

first sub-parameter specifies whether the required value specified in the first sub-parameter applies to TRACE or VOLSELMSG facility. The second sub-parameter specifies another value and facility after the first sub-parameter is specified. When none of these optional sub-parameters are specified, the value specified in the first sub-parameter applies to both TRACE and VOLSELMSG as today. For example, if you want to have ASID 0010 for the SMS TRACE facility, and ASID 0020 for the VOLSELMSG facility, you could code: ASID(10(TRACE),20(VOLSELMSG)) .

STEPNAME(*stepname* | *)

Limits the number of issued volume selection analysis messages activated by VOLSEGMSG(ON) to either a certain stepname or all stepnames. The default is to issue volume selection analysis messages on all stepnames.

DSNAME(*dsname* | *)

Limits the number of issued volume selection analysis messages activated by VOLSEGMSG(ON) to either a certain data set or all data set names. The default is to issue volume selection analysis messages on all data set names. For a VSAM data set, this is the cluster's entry name.

SELECT(*option* [, *option*] ...)

SMS is to add one or more specific events to those that are to be traced. If tracing had been turned off for these events, SMS turns it back on for the specified events. The default is SELECT(ALL). See "Individual trace options" for a complete list of the options.

SELECT only adds events; it does not delete any events. Use DESELECT to turn off one or more events.

Both SELECT and DESELECT affect only the system on which you issue the SETSMS command.

DESELECT(*option* [, *option*] ...)

SMS is to delete one or more events from the list of traced events. There is no default for DESELECT. See "Individual trace options" for a complete list of the options.

ACS Parameters

USER_ACSVAR([[*value1*] [, [[*value2*] [, [*value3*]]]])

Specifies the new values for the ACS read-only variable &USER_ACSVAR. The values can be accessed in ACS routines with the variables &USER_ACSVAR(1), &USER_ACSVAR(2), and &USER_ACSVAR(3) respectively.

The values can be 1 to 8 alphanumeric or national characters (\$, #, @) or period (.) or dash (-).

Any positional value that is not specified is blank. For example, USER_ACSVAR() or USER_ACSVAR(,,) set all 3 positional values to blank. Specify a single dash (-) for any positional value to keep the current value as is. For example, specify USER_ACSVAR(-,-,ABC) to keep the first and second values as they are but change the third value to be ABC.

Individual trace options

The individual trace options and associated events that you can specify with SELECT or DESELECT are:

MODULE

Module entry or exit

SMSSJF

Storage management subsystem/scheduler JCL facility interfaces

SMSSSI	Storage management subsystem/SSI interfaces
ACSINT	Automatic class selection services interfaces
OPCMD	Operator commands
CONF C	Configuration changes
CDSC	Control data set changes
CONF S	Configuration services
MSG	Message services
DCF	Trace SMS read statistics, Cache maintenance and attribute selection
DPN	IDAX device pool
ERR	Error recovery and recording services
CONF R	Return data from an active configuration
CONF A	Activate a new configuration
ACSPRO	Perform automatic class selection processing
IDAX	SMS interpreter or dynamic allocation
DISP	DISP processing exit
CATG	SMS catalog services
VOLREF	SMS VOLREF services
SCHEDP	Scheduling services (pre-locate catalog orientation)
SCHED S	Scheduling services (system-select)
TVR	Tape volume record update SSI
VTOCL	VTOC or data set services (allocate existing data set)
VTOCD	VTOC or data set services (delete existing data set)
VTOCR	VTOC or data set services (rename existing data set)
VTOCC	VTOC or data set services (create new data set)
VTOCA	VTOC or data set services (add a volume to a data set)
RCD	SMS recording services or SMS fast VTOC/VVDS access

SETSMS command

DSTACK

Trace execution of the SMS data set stacking SSI

UAFF Unit affinity exit SSI

DEBUG

Debug service

ALL All of the options

Examples

Example 1:

You find that a system with higher I/O capability is locking out slower systems from accessing the communications data set. After checking the value of the interval, currently set at 15 seconds, you decide the interval should be 20 seconds. To make this change, you enter:

```
SETSMS INTERVAL(020)
```

Example 2:

Assume that on system MVS3 you want to set the SMS trace table size to 16KB, deselect all trace options, then select three options. To make these changes, enter:

```
SETSMS DESELECT(ALL),TRACE(ON),SIZE(16K)
SETSMS SELECT(ACSINT,CDSC,CONF)
```

To determine the current tracing status on MVS3, enter:

```
DISPLAY SMS,TRACE
```

The following display would show the trace table size of 16KB and the ON/OFF status of each of the individual trace entries. In this example only the ACS, CDS, and CONF options would show the ON status.

```
10.24.04 DISPLAY SMS
```

```
IGD002I 11:08:57 DISPLAY SMS 056
TRACE = ON SIZE = 128K TYPE = ERROR
JOBNAME = * ASID = *
TRACING EVENTS:
MODULE = ON SMSSJF = ON SMSSSI = ON ACSINT = ON
OPCMD = ON CONF = ON CDSC = ON CONFS = ON
MSG = ON ERR = ON CONFR = ON CONFA = ON
ACSPRO = ON IDAX = ON DISP = ON CATG = ON
VOLREF = ON SCHEDP = ON SCHEDS = ON VTOCL = ONVTOCD = ON
VTOCR = ON VTOCC = ON VTOCA = ON
RCD = ON DCF = ON DPN = ON TVR = ON
DSTACK = ON UAFF = ON
VOLSELMSG = (OFF,0) TYPE = ERROR JOBNAME = *
ASID = * STEPNAME = *
DSNAME = *
```

Example 3:

You can use the SETSMS command to turn on tracing for SMS data set stacking and other events:

```
SETSMS SELECT(MODULE,DSTACK,VTOCC)
```

Example 4:

You can use the SETSMS command to change the activity keypoint value.

```
SETSMS AKP(300)
```

This results in the following output:

```
SETSMS AKP(300)
IGW467I DFSMS TVS ACTIVITY KEY POINT PARMLIB VALUE 959
CHANGED ON SYSTEM: SYSTEM1
OLD VALUE: 200
NEW VALUE: 300
```

Example 5:

You can use the SETSMS command to change the quiesce timeout value.

```
SETSMS QTIMEOUT(500)
```

This results in the following output:

```
SETSMS QTIMEOUT(500)
IGW467I DFSMS TVS QTIMEOUT PARMLIB VALUE 962
CHANGED ON SYSTEM: SYSTEM1
OLD VALUE: 400 1
NEW VALUE: 500 1
```

Example 6:

You can use the SETSMS command to change the MAXLOCKS maximum and increment values.

```
SETSMS MAXLOCKS(200,100)
```

This results in the following output:

```
SETSMS MAXLOCKS(200,100)
IGW467I DFSMS TVS MAXLOCKS PARMLIB VALUE 965
CHANGED ON SYSTEM: SYSTEM1
OLD VALUE: 100 50 1
NEW VALUE: 200 100 1
```

These MAXLOCKS values are for example only. In practice, you might want to set the minimum and increment values higher to avoid generating too many messages.

Example 7:

You can use the SETSMS command to control how to issue the volume selection analysis messages. Assume you want to issue detailed analysis messages for all volumes on failure allocations, enter:

```
SETSMS VOLSELMSG(ON,ALL) TYPE(ERROR)
```

After the processing completes, check the parameter settings, enter:

```
DISPLAY SMS,VOLSELMSG
```

This results the following report:

```
IGD002I 08:14:24 DISPLAY SMS 488
VOLSELMSG = (ON,ALL) TYPE = ERROR JOBNAME = *
ASID = * STEPNAME = *
DSNAME = *
TRACE = ON SIZE = 128K TYPE = ERROR
JOBNAME = * ASID = *
```

SETSMS command

Note that because the TYPE parameter value is shared by SMS trace facility and volume selection analysis messages, changing it for volume selection analysis messages will therefore affect SMS tracing.

SETSSI command

Use the SETSSI to add, activate, deactivate, or delete a subsystem dynamically. You can issue the SETSSI command from one of the following:

- A console that has master authority
- A console to which an operator with sufficient RACF authority has logged on.

Each subsystem determines whether it can process the SETSSI command by issuing the options request of the IEFSSI macro. See *z/OS MVS Programming: Authorized Assembler Services Reference EDT-IXG* for more information about the IEFSSI macro.

If you issue a SETSSI ACTIVATE or DEACTIVATE command for a subsystem that does not allow SETSSI commands, the system ignores the command and issues an error message to the console.

You can use the SETSSI ADD command to define dynamically any subsystem except the primary subsystem.

Attention: Once a subsystem name is defined to the system, any attempt to start that subsystem (or any started task with the same name as that subsystem) via a START command which does not explicitly specify SUB=JES2 (or JES3) will result in that subsystem or started task being started under the Master subsystem rather than under the Job Entry subsystem. Then, because the only procedure libraries available to the Master subsystem are those specified in the MSTJCLxx's IEFPSI data set, any procedures being started that are defined in the Job Entry subsystem's PROC00 data set but not in the MSTJCLxx's IEFPSI data set will be unavailable and will therefore not be found; the system will issue message IEF612I.

Syntax

The complete syntax for the SETSSI command is:

```
SETSSI {ADD,{SUBNAME|SUB|S}=subname
      [, {CONSNAME|C}=consname]
      [, {INITRTN|I}=initrtn[, {INITPARM|P}=initparm]] }

      {DEACTIVATE|DEACT},{SUBNAME|SUB|S}=subname      }

      {ACTIVATE|ACT},{SUBNAME|SUB|S}=subname          }

      {DELETE},{SUBNAME|SUB|S}=subname,FORCE          }
```

Parameters

The parameters are:

ADD

Directs that a subsystem be added dynamically.

Note that with the exception mentioned in the next paragraph, you cannot specify in a SETSSI ADD command a subsystem initialization routine in a library added in a new LNKLIST that was activated after IPL. A job that is

already running does not normally use a new LNKLST. Because the SETSSI command runs in the MASTER address space, which started at IPL, it does not normally use a new LNKLST.

Exception: You could use a SETPROG LNKLST,UPDATE,ASID=1 command to update the LNKLST prior to issuing the SETSSI ADD command. **However, you should use that SETPROG command with caution**, because you would be depending on it to complete execution prior to the running job accessing the updated LNKLST.

DEACTIVATE | DEACT

Specifies that a subsystem is to be dynamically deactivated. DEACTIVATE stops any new requests from being passed to the subsystem's function routines. Function requests that are already processing are allowed to complete. Note that a subsystem is still defined to the system, even if you issued the DEACTIVATE parameter.

Only subsystems with **SSI-managed** vector tables can be reactivated with the SETSSI command. SSI-managed vector tables are vector tables that were created with the IEFSSVT macro. See *z/OS MVS Programming: Authorized Assembler Services Reference EDT-IXG* for more information on the IEFSSVT macro.

Note: You can only issue the DEACTIVATE command if the target subsystem is dynamic and permits the use of the SETSSI command.

ACTIVATE | ACT

Specifies that a subsystem is to be dynamically activated. You can also use the ACTIVATE command to reactivate a previously deactivated subsystem provided a vector table managed by the SSI is available.

Note: You can only issue the ACTIVATE command if the target subsystem is dynamic and permits the use of the SETSSI command.

DELETE

Specifies that a subsystem is to be dynamically deactivated and deleted.

DELETE first deactivates the subsystem, stopping new requests from being passed to the subsystem's function routines. Function requests that are already in progress are allowed to complete.

Note: Unlike other SETSSI functions, the DELETE function does not require that the target subsystem be dynamic.

SUBNAME | SUB | S=subname

A required parameter that specifies the 1- to 4-character subsystem name to be dynamically added, deactivated, activated, or deleted.

Subsystem names that are not enclosed in single quotation marks may contain any character that is valid for operator commands, with the following exceptions:

- , (comma)
- ((left parenthesis)
-) (right parenthesis)
- / (slash)
- = (equals sign)

Subsystem names containing these characters must be enclosed in single quotation marks.

SETSSI command

Subsystem names that contain any character that is not valid for operator commands must be enclosed in single quotation marks. See Chapter 4, "MVS system commands reference," on page 153 for a list of characters supported by commands.

Note that the SUBNAME parameter applies to the SETSSI ADD, SETSSI DEACTIVATE, SETSSI ACTIVATE, and SETSSI DELETE commands.

- For the SETSSI ADD command, note the following when selecting subsystem names:
 - If you specify a subsystem name with the characters '*' and '?', the DISPLAY SSI command or the IEFSSI REQUEST=QUERY service specifying that subsystem name may return information about subsystems other than this one. The '*' and '?' are treated as wildcard characters for these services.
 - If you specify a subsystem name of '!PRI', the DISPLAY SSI command or the IEFSSI REQUEST=QUERY service specifying that subsystem name returns information about the primary subsystem, even though there is already a subsystem named '!PRI'.
- For the SETSSI DELETE command only, the SUBNAME value can also be specified as 8 hexadecimal digits (0-9, A-F) enclosed in single quotation marks, followed by the letter X (for instance, 'F1F2F3F4'X).

CONSNAME | C=consname

Specifies the name of the console to which SSI issued messages are routed. CONSNAME is an optional parameter. It can be 2- to 8-bytes long and is also passed to the routine named on the INITRTN keyword (if specified).

INITRTN | I=initrtn

Specifies the name of the subsystem initialization routine. INITRTN is an optional parameter. It can consist of at most eight characters, beginning with an alphabetic or national (\$, #, or @) character. The remaining characters can be either alphanumeric or national (\$, #, or @). The routine receives control in supervisor state key 0. It must be a program that is accessible through a LINKLIB or the LPALIB.

INITPARM | P=initparm

Specifies the input parameter that is passed to the subsystem initialization routine. INITPARM is an optional parameter. It can be no more than 60 characters long. If you use delimiters such as blanks, commas, apostrophes, equal signs, or parentheses or a '/' in the parameter data, you must enclose the entire field in apostrophes. You must code two consecutive apostrophes to pass an apostrophe as part of the parameter data.

Note: The INITPARM parameter must be specified with the INITRTN parameter. If the INITRTN is not specified, the system issues a syntax error message and the command is not processed.

FORCE

For the SETSSI DELETE command, a required parameter that specifies that the subsystem is to be removed. This command should be used with care, as removing a subsystem may result in loss of system function.

Notes:

1. In the command invocation, anything after the first blank is treated as a comment.

2. The command invocation cannot be more than 126 characters long. You may need to use the 1-character keyword abbreviations to keep the length of the command invocation within this limit.

Example 1: To define the CAW subsystem to the system, call its initialization routine and pass the specified parameter to the initialization routine, enter:

```
SETSSI ADD,SUBNAME=CAW,INITRTN=CAWINIT,INITPARM=HELLO
```

Example 2: To temporarily stop new function requests to the subsystem to see if one of the function routines in the 'CAW' subsystem is causing abends, enter:

```
SETSSI DEACTIVATE,SUBNAME=CAW
```

Example 3: To deactivate and delete a subsystem named CAW, enter:

```
SETSSI DELETE,SUBNAME=CAW,FORCE
```

SETUNI command

Use the SETUNI command to dynamically set the Unicode environment from the console. Use the SETUNI command to add, delete, and replace Unicode resources in storage.

SETUNI command

Syntax

The complete syntax for the SETUNI command is:

```
SETUNI {ADD[,FROM(xxxxx),TO(yyyyy)[,TECHNIQUE|TECH(zzzzzzz)]
      [,PAGEFIX(YES|NO)][,DSNAME|DSN(dsname)][,VOLSER|VOL(volser)]
      [,CASE([LOCAL|SPECIAL|NORMAL])[,UNIVER(univer)][,PAGEFIX(YES|NO)]
      [,DSNAME|DSN(dsname)][,VOLSER|VOL(volser)]
      [,NORMALIZE|NORM(normver)][,PAGEFIX(YES|NO)][,DSNAME|DSN(dsname)]
      [,VOLSER|VOL(volser)]
      [,COLLATE|COLL([UCAver)][,PAGEFIX(YES|NO)][,DSNAME|DSN(dsname)]
      [,VOLSER|VOL(volser)]
      [[,LOCALE(locale)[,DSNAME(dsname)][,VOLUME|VOL(volser)]]|
      [,COLRULES(colrules)[,DSNAME(dsname)][,VOLUME|VOL(volser)]]]
      [,IMAGE(zzzzzzz)][,PAGEFIX(YES|NO)][,DSNAME|DSN(dsname)]
      [,VOLSER|VOL(volser)]
      [,STRPROFILE=NAME[,PAGEFIX(YES|NO)][,DSNAME|DSN(dsname)]
      [,VOLSER|VOL(volser)]]
      [,BLDLOCALE|BLDLOC=locname
      [,CCSID(nnnnn)][,TECHNIQUE|TECH(zzzzzzz)][,PAGEFIX(YES|NO)]
      [,DSNAME|DSN(dsname)]
      [,VOLSER|VOL(volser)]
      }

{DELETE[,FROM(xxxxx),TO(yyyyy)[TECHNIQUE|TECH(zzzzzzz)],FORCE(YES)]
      [,CASE([LOCAL|SPECIAL|NORMAL])[,UNIVER(univer)],FORCE(YES)]
      [,NORMALIZE|NORM([normver]),FORCE(YES)]
      [,COLLATE|COLL([UCAver)][[,LOCALE(locale)]|
      [,COLRULES(colrules)]]],FORCE(YES)]
      [,STRPROFILE=NAME[,DSNAME|DSN(dsname)][,VOLSER|VOL(volser)]
      [,BLDLOCALE|BLDLOC=locname[,CCSID(nnnnn)]
      [,TECHNIQUE|TECH(zzzzzzz)]]
      }

{REPLACE[,FROM(xxxxx),TO(yyyyy)[,TECHNIQUE|TECH(zzzzzzz)]
      [,PAGEFIX(YES|NO)][,DSNAME|DSN(dsname)]
      [,FREE(YES,FORCE)]
      [,CASE([LOCAL|SPECIAL|NORMAL])[,UNIVER(univer)][,PAGEFIX(YES|NO)]
      [,DSNAME|DSN(dsname)][,FREE(YES,FORCE)]]
      [,NORMALIZE|NORM([normver)][,PAGEFIX(YES|NO)]
      [,DSNAME|DSN(dsname)][,VOLSER|VOL(volser)]
      [,FREE(YES,FORCE)]]
      [,COLLATE|COLL([UCAver)][,PAGEFIX(YES|NO)]
      [,DSNAME|DSN(dsname)][,VOLSER|VOL(volser)]
      [[,LOCALE(locale)[,DSNAME(dsname)][,VOLUME|VOL(volser)]]|
      [,COLRULES(colrules)[,DSNAME(dsname)][,VOLUME|VOL(volser)]]]
      [,FREE(YES,FORCE)]]
      [,STRPROFILE=NAME[,PAGEFIX(YES|NO)][,DSNAME|DSN(dsname)]
      [,VOLSER|VOL(volser)]]
      [,BLDLOCALE|BLDLOC=locname
      [,CCSID(nnnnn)][,TECHNIQUE|TECH(zzzzzzz)][,PAGEFIX(YES|NO)]
      [,DSNAME|DSN(dsname)][,VOLSER|VOL(volser)]
      }

{REALSTORAGE [(|)nnnnn[K|M|G]()] }

{DELETE INACTIVE}

{DELETE ALL,FORCE(YES)}
```

Parameters

The parameters are:

**ADD, FROM(*xxxxx*), TO(*yyyyy*) [, TECHNIQUE | TECH(*zzzzzzzz*)]
 [, PAGEFIX(YES|NO)] [, DSNAME | DSN(*dsname*)] [, VOLSER | VOL(*volser*)]**

Adds specific conversion resources to the Unicode environment.

xxxxx

Specifies the source CCSID of the character conversion table to be added.
xxxxx is a five-character name that identifies the table.

yyyyy

Specifies the target CCSID of the character conversion table to be added.
yyyyy is a five-character name that identifies the table.

zzzzzzzz

Specifies the technique search order for the character conversion table to be added. *zzzzzzzz* is an eight-character alphanumeric field. Possible values are one or more of the following:

- R** Roundtrip conversion
- E** Enforced subset conversion
- C** Customized conversion
- L** Language Element-behavior conversion
- M** Modified for special use conversion

0-9

User-defined conversions

See *z/OS Unicode Services User's Guide and Reference* for additional information on techniques.

Note: You may get different results for different orders of the techniques placed in the *zzzzzzzz* field.

dsname

Specifies the name of the data set that contains the specific tables.

The specified *dsname* must have similar characteristics as the SYS1.SCUNTBLL data set provided. The size of the data set can be unequal.

If no *dsname* is specified, SYS1.SCUNTBLL is used as the default.

volser

Specifies the volume serial number of the device on which the tables are to be loaded. *volser* can be from one- to six-characters.

Example:

```
SETUNI ADD, FROM=1200, TO=37, TECH=ER, DSN=SYS1.SCUNTBLL, VOL=XLAD01
```

**ADD, CASE([LOCAL | SPECIAL |
 NORMAL]) [, UNIVER(*univer*)] [, PAGEFIX(YES|NO)] [, DSNAME | DSN(*dsname*)] [, VOLSER
 | VOL(*volser*)]**

Adds the character case conversion tables to the Unicode environment. Local, Special, and Normal are optional and can be defined in the same statement only once.

univer

Specifies the Unicode standard version to be loaded. Valid values are:

- UNI300
- UNI301
- UNI320
- UNI401

SETUNI command

UNI410
UNI500
UNI600

dsname

Specifies the name of the data set that contains the specific tables.

The specified *dsname* must have similar characteristics as the SYS1.SCUNTBLS data set provided. The size of the data set can be unequal.

If no *dsname* is specified, SYS1.SCUNTBLS is used as the default.

volser

Specifies the volume serial number of the device on which the tables are to be loaded. *volser* can be from one- to six-characters.

Example:

```
SETUNI ADD,CASE,DSN=SYS1.SCUNTBLS,VOL=XLAD01
```

```
ADD,NORMALIZE | NORM ([normver]) [,PAGEFIX(YES|NO)] [,DSNAME |  
DSN(dsname)] [,VOLSER | VOL(volser )]
```

Adds the normalization tables to the Unicode environment.

normver

Specifies the Unicode standard table version to be loaded. Possible values are one of the following:

UNI301
UNI320
UNI401
UNI410
UNI600

dsname

Specifies the name of the data set that contains the specific tables.

The specified *dsname* must have similar characteristics as the SYS1.SCUNTBLS data set provided. The size of the data set can be unequal.

If no *dsname* is specified, SYS1.SCUNTBLS is used as the default.

volser

Specifies the volume serial number of the device on which the tables are to be loaded. *volser* can be from one- to six-characters.

```
ADD,COLLATE | COLL([UCAver]) [,PAGEFIX(YES|NO)] [,DSNAME | DSN(dsname)]  
[,VOLSER | VOL(volser )] [[,LOCALE(locale) [,DSNAME(dsname)]  
[,VOLUME|VOL(volser)]] | [,COLRULES(colrules) [,DSNAME(dsname)]  
[,VOLUME|VOL(volser)]]
```

Adds the collation tables to the Unicode environment.

UCAver

Specifies the Unicode Collation Algorithm (UCA) versions . Possible values are one or more of the following:

UCA301
UCA400R1
UCA410
UCA600

dsname

Specifies the name of the data set that contains the specific tables.

The specified *dsname* must have similar characteristics as the SYS1.SCUNTBLS data set provided. The size of the data set can be unequal.

If no *dsname* is specified, SYS1.SCUNTBLL is used as the default.

volser

Specifies the volume serial number of the device on which the tables are to be loaded. *volser* can be from one- to six-characters.

locale

Specifies the local member name where collation rules are to be loaded.

colrules

Specifies the User Collation Rules (UCR) member name where collation rules are to be loaded.

ADD, IMAGE=zzzzzzzz [, PAGEFIX(YES|NO)] [, DSNAME | DSN(*dsname*)] [, VOLSER | VOL(*volser*)]

Adds an image to the Unicode environment, whether the image is a member of the parmlib concatenation. If the image specified already exists in storage, the table is not added.

zzzzzzzz

Specifies the name of the conversion image to be added. The image member specified must be present in SYS1.PARMLIB or in another data set in the logical parmlib concatenation. *zzzzzzzz* is an eight-character alphanumeric field.

Value Range: any valid z/OS member name

Example: IMAGE=CUNUNI01

Note: When an image is loaded with the IMAGE statement, the existing table in the Unicode environment are not replaced; only those tables that are not currently available in the Unicode environment are loaded from the Image.

dsname

Specifies the name of the data set that contains the specific tables.

The specified *dsname* must have similar characteristics as the SYS1.SCUNTBLL data set provided. The size of the data set can be unequal.

If no *dsname* is specified, SYS1.SCUNTBLL is used as the default.

volser

Specifies the volume serial number of the device on which the tables are to be loaded. *volser* can be from one- to six-characters.

ADD, STRPROFILE=NAME [, PAGEFIX(YES|NO)] [, DSNAME | DSN(*dsname*)] [, VOLSER | VOL(*volser*)]

Adds the profile to the Unicode environment.

dsname

Specifies the name of the data set that contains the specific locale source file.

The specified *dsname* must have similar characteristics as the SYS1.SCUNTBLL data set provided. The size of the data set can be unequal.

If no *dsname* is specified, SYS1.SCUNTBLL is used as the default.

volser

Specifies the volume serial number of the device on which the tables are to be loaded. *volser* can be from one- to six-characters.

SETUNI command

**ADD, BLDLOCALE | BLDLOC=locname [, CCSID(nnnnn)] [, TECHNIQUE | TECH(zzzzzzz)]
[, PAGEFIX(YES | No)] [, DSNAME | DSN(dsname)] [, VOLSER | VOL(volser)]]**

Adds locales to the Unicode environment.

locname

Specifies the locale name to be added. The locale name is case sensitive and is converted to uppercase unless it is specified inside single quotes, as in the following example:

```
SETUNI ADD, BLDLOC='en_US'
```

nnnnn

Specifies the CCSID of the locale to be added.

zzzzzzz

Specifies the technique search order for the character conversion table to be added. *zzzzzzz* is an eight-character alphanumeric field. Possible values are one or more of the following:

- R** Roundtrip conversion
- E** Enforced subset conversion
- C** Customized conversion
- L** Language Element-behavior conversion
- M** Modified for special use conversion

0-9

User-defined conversions

See *z/OS Unicode Services User's Guide and Reference* for additional information on techniques.

Note: You may get different results for different orders of the techniques placed in the *zzzzzzz* field.

dsname

Specifies the name of the data set that contains the specific tables.

The specified *dsname* must have similar characteristics as the SYS1.SCUNTBLS data set provided. The size of the data set can be unequal.

If no *dsname* is specified, SYS1.SCUNTBLS is used as the default.

volser

Specifies the volume serial number of the device on which the tables are to be loaded. *volser* can be from one- to six-characters.

DELETE, FROM(xxxxx), TO(yyyyy) [, TECHNIQUE | TECH(zzzzzzz)] , FORCE(YES)

Remove specific tables from the Unicode environment.

xxxxx

Specifies the source CCSID of the character conversion table to be removed. *xxxxx* is a five-character name that identifies the table to be removed.

yyyyy

Specifies the target CCSID of the character conversion table to be removed. *yyyyy* is a five-character name that identifies the table to be removed.

zzzzzzzz

Specifies the technique search order for the character conversion table to be removed. *zzzzzzzz* is an eight-character alphanumeric field. Possible values are one or more of the following:

- R** Roundtrip conversion
- E** Enforced subset conversion
- C** Customized conversion
- L** Language Element-behavior conversion
- M** Modified for special use conversion

0-9

User-defined conversions

See *z/OS Unicode Services User's Guide and Reference* for additional information on techniques.

If no technique search order is specified, the default is RECLM.

Note: You may get different results for different orders of the techniques placed in the *zzzzzzzz* field.

FORCE(YES)

Specifies that the system will not check whether applications are currently using the tables. The storage occupied by the tables will be returned to the system.

FORCE(YES) is a required parameter.

DELETE, CASE ([LOCAL | SPECIAL | NORMAL]) [, UNIVER(*univer*)] , FORCE(YES)

Removes the character case conversion tables from the Unicode environment. Local, Special, and Normal are optional and can be defined in the same statement only once.

univer

Specifies the Unicode standard version to be loaded. Valid values are:

- UNI300
- UNI301
- UNI320
- UNI401
- UNI410
- UNI500
- UNI600

FORCE(YES)

Specifies that the system will not check whether applications are currently using the tables. The storage occupied by the tables will be returned to the system.

FORCE(YES) is a required parameter.

DELETE, NORMALIZE | NORM([*normver*]) , FORCE(YES)

Removes the normalization tables from the Unicode environment.

normver

Specifies the Unicode standard table version to be deleted. Possible values are one of the following:

SETUNI command

UNI301

UNI320

UNI401

UNI410

UNI600

FORCE(YES)

Specifies that the system will not check whether applications are currently using the tables. The storage occupied by the tables will be returned to the system.

FORCE(YES) is a required parameter.

**DELETE, COLLATE | COLL ([UCAver])
[[, LOCALE(*locale*)] | [, COLRULES(*colrules*)]], FORCE(YES)**

Removes the collation tables from the Unicode environment.

UCAver

Specifies the Unicode Collation Algorithm (UCA) versions . Possible values are one or more of the following:

UCA301

UCA400R1

UCA410

UCA600

locale

Specifies the local member name where collation rules are to be loaded.

colrules

Specifies the User Collation Rules (UCR) member name where collation rules are to be loaded.

FORCE(YES)

Specifies that the system does not check whether applications are currently using the tables. The storage occupied by the tables is returned to the system.

FORCE(YES) is a required parameter.

DELETE, STRPROFILE=NAME [, DSNAME | DSN(*dsname*)] [, VOLSER | VOL(*volser*)]

Removes the profile from the Unicode environment.

dsname

Specifies the name of the data set that contains the specific locale source file.

The specified *dsname* must have similar characteristics as the SYS1.SCUNTBLL data set provided. The size of the data set can be unequal.

If no *dsname* is specified, SYS1.SCUNTBLL is used as the default.

volser

Specifies the volume serial number of the device on which the tables are to be loaded. *volser* can be from one- to six-characters.

DELETE, BLDLOCALE | BLDLOC=1ocname[, CCSID(*nnnnn*)] [, TECHNIQUE | TECH(*zzzzzzzz*)]

Deletes locales from the Unicode environment.

locname

Specifies the locale name to be deleted.

nnnnn

Specifies the CCSID of the locale to be deleted.

ZZZZZZZZ

Specifies the technique search order for the character conversion table to be deleted. *zzzzzzzz* is an eight-character alphanumeric field. Possible values are one or more of the following:

- R** Roundtrip conversion
- E** Enforced subset conversion
- C** Customized conversion
- L** Language Element-behavior conversion
- M** Modified for special use conversion

0-9

User-defined conversions

See *z/OS Unicode Services User's Guide and Reference* for additional information on techniques.

Note: You may get different results for different orders of the techniques placed in the *zzzzzzzz* field.

**REPLACE, FROM(*xxxxx*), TO(*yyyyy*) [, TECHNIQUE | TECH(*zzzzzzzz*)]
 [, PAGEFIX(YES | NO)] [, DSNAME | DSN(*dsname*)]
 [, VOLSER | VOL(*volser*)] [, FREE(NO | YES, FORCE)]**

Replaces specific tables that might be currently in the Unicode environment. If a table to be replaced is not in storage, the system adds the table.

xxxxx

Specifies the source CCSID of the conversion table to be replaced. *xxxxx* is a five-character name that identifies the conversion table.

yyyyy

Specifies the target CCSID of the conversion table to be replaced. *yyyyy* is a five-character name that identifies the conversion table.

ZZZZZZZZ

Specifies the technique search order for the conversion table to be replaced. *zzzzzzzz* is an eight-character alphanumeric field. Possible values are one or more of the following:

- R** Roundtrip conversion
- E** Enforced subset conversion
- C** Customized conversion
- L** Language Element-behavior conversion
- M** Modified for special use conversion

0-9

User-defined conversions

See *z/OS Unicode Services User's Guide and Reference* for additional information on techniques.

If no technique search order is specified, the default is RECLM.

Note: You may get different results for different orders of the techniques placed in the *zzzzzzzz* field.

SETUNI command

dsname

Specifies the name of the data set that contains the specific tables.

The specified *dsname* must have similar characteristics as the SYS1.SCUNTBLS data set provided. The size of the data set can be unequal.

If no *dsname* is specified, SYS1.SCUNTBLS is used as the default.

volser

Specifies the volume serial number of the device on which the tables are to be loaded. *volser* can be from one- to six-characters.

FREE

Specifies whether the storage associated with the table is to be released.

NO Unicode will not release the storage associated with the table.

YES, FORCE

Release the storage associated with the table. The system does not check whether applications are currently using the tables.

When FREE is not specified, the default is NO.

**REPLACE, CASE ([LOCAL | SPECIAL | NORMAL]) [, UNIVER (*univer*)] [, PAGEFIX (YES | NO)]
[, DSNAME | DSN (*dsname*)] [, VOLSER | VOL (*volser*)] [, FREE (NO | YES, FORCE)]**

Replaces the character case conversion tables currently in the Unicode environment. Local, Special, and Normal are optional and can be defined in the same statement only once.

univer

Specifies the Unicode standard version to be loaded. Valid values are:

UNI300
UNI301
UNI320
UNI401
UNI410
UNI500
UNI600

dsname

Specifies the name of the data set that contains the specific tables.

The specified *dsname* must have similar characteristics as the SYS1.SCUNTBLS data set provided. The size of the data set can be unequal.

If no *dsname* is specified, SYS1.SCUNTBLS is used as the default.

volser

Specifies the volume serial number of the device on which the tables are to be loaded. *volser* can be from one- to six-characters.

FREE

Specifies whether the storage associated with the table is to be released.

NO Unicode will not release the storage associated with the table.

YES, FORCE

Release the storage associated with the table. The system does not check whether applications are currently using the tables.

When FREE is not specified, the default is NO.

REPLACE, NORMALIZE | **NORM**([*normver*]) [, **PAGEFIX**(**YES** | **NO**)] [, **DSNAME** | **DSN**(*dsname*)]
 [, **VOLSER** | **VOL**(*volser*)] [, **FREE**(**NO** | **YES** , **FORCE**)]

Replaces the normalization tables currently in the Unicode environment.

normver

Specifies the Unicode standard table version to be replaced. Possible values are one of the following:

UNI301
 UNI320
 UNI401
 UNI410
 UNI600

dsname

Specifies the name of the data set that contains the specific tables.

The specified *dsname* must have similar characteristics as the SYS1.SCUNTBLS data set provided. The size of the data set can be unequal.

If no *dsname* is specified, SYS1.SCUNTBLS is used as the default.

volser

Specifies the volume serial number of the device on which the tables are to be loaded. *volser* can be from one- to six-characters.

FREE

Specifies whether the storage associated with the table is to be released.

NO Unicode will not release the storage associated with the table.

YES, FORCE

Release the storage associated with the table.

When FREE is not specified, the default is NO.

REPLACE, COLLATE | **COLL**([*UCAver*]) [, **PAGEFIX**(**YES** | **NO**)] [, **DSNAME** | **DSN**(*dsname*)]
 [, **VOLSER** | **VOL**(*volser*)] [[, **LOCALE**(*locale*)] [, **DSNAME**(*dsname*)]
 [, **VOLUME** | **VOL**(*volser*)]] | [, **COLRULES**(*colrules*) [, **DSNAME**(*dsname*)]
 [, **VOLUME** | **VOL**(*volser*)]]] [, **FREE**(**NO** | **YES** , **FORCE**)]

Replaces the collation tables currently in the Unicode environment.

UCAver

Specifies the Unicode Collation Algorithm (UCA) versions . Possible values are one or more of the following:

UCA301
 UCA400R1
 UCA410
 UCA600

dsname

Specifies the name of the data set that contains the specific tables.

The specified *dsname* must have similar characteristics as the SYS1.SCUNTBLS data set provided. The size of the data set can be unequal.

If no *dsname* is specified, SYS1.SCUNTBLS is used as the default.

volser

Specifies the volume serial number of the device on which the tables are to be loaded. *volser* can be from one- to six-characters.

locale

Specifies the local member name where collation rules are to be loaded.

SETUNI command

colrules

Specifies the User Collation Rules (UCR) member name where collation rules are to be loaded.

FREE

Specifies whether the storage associated with the table is to be released.

NO Unicode will not release the storage associated with the table.

YES, FORCE

Release the storage associated with the table.

When FREE is not specified, the default is NO.

**REPLACE, STRPROFILE=NAME [, PAGEFIX(YES|NO)] [, DSNAME|DSN(*dsname*)]
[, VOLSER|VOL(*volser*)]**

Replaces the current profile in the Unicode environment.

dsname

Specifies the name of the data set that contains the specific locale source file.

The specified *dsname* must have similar characteristics as the SYS1.SCUNTBLS data set provided. The size of the data set can be unequal.

If no *dsname* is specified, SYS1.SCUNTBLS is used as the default.

volser

Specifies the volume serial number of the device on which the tables are to be loaded. *volser* can be from one- to six-characters.

**REPLACE, BLDLOCALE|BLDLOC=*locname* [, CCSID(*nnnnn*)] [, TECHNIQUE|TECH(*zzzzzzzz*)]
[, PAGEFIX(YES|No)] [, DSNAME|DSN(*dsname*)] [, VOLSER|VOL(*volser*)]**

Replaces locales in the Unicode environment.

locname

Specifies the locale name to be replaced.

nnnnn

Specifies the CCSID of the locale to be replaced.

zzzzzzzz

Specifies the technique search order for the character conversion table to be replaced. *zzzzzzzz* is an eight-character alphanumeric field. Possible values are one or more of the following:

- R** Roundtrip conversion
- E** Enforced subset conversion
- C** Customized conversion
- L** Language Element-behavior conversion
- M** Modified for special use conversion

0-9

User-defined conversions

See *z/OS Unicode Services User's Guide and Reference* for additional information on techniques.

Note: You may get different results for different orders of the techniques placed in the *zzzzzzzz* field.

dsname

Specifies the name of the data set that contains the specific tables.

The specified *dsname* must have similar characteristics as the SYS1.SCUNTBLL data set provided. The size of the data set can be unequal.

If no *dsname* is specified, SYS1.SCUNTBLL is used as the default.

volser

Specifies the volume serial number of the device on which the tables are to be loaded. *volser* can be from one- to six-characters.

REALSTORAGE nnnnn[K | M | G] [;]

Defines the upper storage limit, in pages, to be used by the conversion environment. For information about the amount of storage required for a conversion environment, see *z/OS Unicode Services User's Guide and Reference*.

Value Range: 0 to 524287

Example:

```
REALSTORAGE 0;      /* no explicit limit */
REALSTORAGE 12800; /* 50 MB limit */
```

Note:

1. The request to load a new conversion environment will be rejected when the value of the REALSTORAGE keyword is lower than the amount of storage needed.
2. The selection of '0' results in no limit (=524287).

DELETE mode

Deletes partially or completely the Unicode environment.

INACTIVE

Deletes all the unreferenced control entries within the current Unicode environment and reorganizes the Unicode environment to eliminate storage gaps in it.

The string literal INACTIVE must be specified.

Note: Unreferenced control entries are entities that contain data of the current supported tables and can be obtained while replacing or deleting tables from the Unicode environment.

ALL

Deletes the whole Unicode environment. This deletes all control structures and resources. In addition, the ENQ of SYS1.SCUNTBLL and SYS1.SCUNLOCL will also be released, if they were enqueued.

Note: FORCE(YES) is required for this keyword.

FORCE(YES)

Specifies that the system will not check whether applications are currently using the tables. The storage occupied by the tables will be returned to the system.

FORCE(YES) is a required parameter.

Example 1:

SETUNI command

DELETE INACTIVE;

Example 2:

DELETE ALL,FORCE(YES)

Note: DELETE mode commands are intended for Unicode environment maintenance only. No Unicode calls should be running in the Unicode environment during the execution of these commands.

SETXCF command

Use the SETXCF command to control the cross-system coupling facility (XCF). Table 63 summarizes the information that the SETXCF command provides. Use it to access the pages on which you can find details about a particular use of the SETXCF command.

Table 63. Summary of the SETXCF Command

Command	Topic
SETXCF COUPLE	"SETXCF COUPLE command" on page 777
SETXCF DUMPCF	"SETXCF DUMPCF command" on page 780
SETXCF FORCE	"SETXCF FORCE command" on page 781
SETXCF FUNCTIONS	"SETXCF FUNCTIONS command" on page 784
SETXCF MODIFY	"SETXCF MODIFY command" on page 784
SETXCF PRSMPOLICY	"SETXCF PRSMPOLICY command" on page 788
SETXCF START	"SETXCF START command" on page 788
SETXCF STOP	"SETXCF STOP command" on page 798

Scope in a sysplex

The following table describes the conditions under which the SETXCF command has sysplex scope. See "Using commands that have sysplex scope" on page 12 for an explanation of sysplex scope.

Table 64. Sysplex Scope for the SETXCF Command

Command	Conditions
SETXCF COUPLE	Has sysplex scope only when you specify PSWITCH, ACOUPLE, or PCOUPLE, and all systems have access to the specified couple data set.
SETXCF FORCE	Has sysplex scope only when all systems are connected to the same coupling facility.
SETXCF START STOP	Has sysplex scope only when you specify POLICY, REBUILD, REALLOCATE, MSGBASED, or MAINTMODE.
SETXCF MODIFY	Has sysplex scope only when used to modify CF structure alter permission (ALTER=DISABLED or ALTER=ENABLED).

Syntax

The syntax for each variation of the SETXCF command is shown immediately preceding its respective parameter list.

SETXCF COUPLE command

Use the SETXCF COUPLE command to:

- Switch a current alternate couple data set to a primary couple data set. The switch can be for either sysplex couple data sets or other types of couple data sets.
- Specify a primary non-sysplex couple data set, such as CFRM, SFM, WLM.
- Specify an alternate couple data set.
- Change options specified in the COUPLExx parmlib member.

For more information about the SETXCF COUPLE parameters see *z/OS MVS Setting Up a Sysplex* and *z/OS MVS Initialization and Tuning Reference*.

```

SETXCF {COUPLE|CPL},{PSWITCH                                }
                                     {ACOUPL=(alternatedsname[,alternatevolume]) }
                                     {INTERVAL=timeinterval                       }
                                     {OPNOTIFY=timeinterval                       }
                                     {CLEANUP=timeinterval                       }
                                     {MAXMSG=defaultmaxmsgbuffers                 }
                                     {RETRY=defaultretrylimit                     }
                                     {CLASSLEN=defaultclasslength                 }
                                     {TYPE=(name[,name]...),                       }
                                       {PCOUPLE=(primarydsname[,primaryvolume]) }
                                       {ACOUPL=(alternatedsname[,alternatevolume])}
                                       {PSWITCH                                    }

```

The parameters are:

PSWITCH

Switches the current alternate sysplex couple data set to become the primary sysplex couple data set. The command is complete when systems in the sysplex acknowledge the switch. This command removes the current primary sysplex couple data set from service.

Note: If the new primary sysplex couple data set has been formatted to support greater than eight systems in the sysplex, the following occurs:

- If the current RMAX value is less than 99, the system automatically increases the RMAX value to 99. The system issues message IEA403I to indicate this change. You cannot lower the value of RMAX. A minimum RMAX value of 99 is enforced for performance reasons.

ACOUPL=(*alternatedsname*,*alternatevolume*)

Specifies the data set to use as an alternate sysplex couple data set. This data set must be defined and formatted with the XCF format utility and for each parameter specified in the utility, the parameter values must be equal to or

SETXCF command

greater than the parameter values that were used to format the current primary couple data set. See *z/OS MVS Setting Up a Sysplex* for additional information about planning for couple data sets.

Specify the volume only when the data set is not cataloged. You need to use parentheses only when you specify the volume. Once the command completes, any previous alternate sysplex couple data set is removed from service. The specified alternate sysplex couple data set must be accessible and usable from all systems in the sysplex.

The data set named *alternatedsname* can have one or more name segments, separated by periods, and cannot exceed a total length of 44 characters. Each name segment is one to eight alphanumeric, hyphen (-), and national (\$,#,@) characters, but must begin with an alphabetic or national character.

The volume *alternatevolume* must be specified as one to six alphanumeric or national characters, and may begin with any of these characters.

INTERVAL=*timeinterval*

Specifies the length of the failure detection interval for the system. *timeinterval* is specified in seconds and ranges from 3 to 86400 (24 hours).

IBM suggests that the default value (the derived spin failure detection interval) be used. If you specify the INTERVAL value explicitly, it should be no more than twice the derived spin failure detection interval based on the following considerations: the user-specified INTERVAL must be greater or equal to the derived spin failure detection interval so that the system can have a chance to recover before XCF initiates system failure processing; however, if the value is too large, it might allow sympathy sickness to spread throughout the sysplex.

The default INTERVAL value is derived from the excessive spin processing parameters in EXSPATxx. For more information about how the default INTERVAL value is computed, see *z/OS MVS Initialization and Tuning Reference*.

OPNOTIFY=*timeinterval*

Specifies in seconds how long a system must appear to be inoperative before XCF notifies the operator. Either an absolute value (in the form of *xxx*) or a relative value (in the form of *+xxx*) is accepted. The absolute value ranges from 3 to 86400 (24 hours); the relative value ranges from 0 to 86400.

- When an absolute value is specified, the OPNOTIFY value must be greater than or equal to the INTERVAL value if INTERVAL is specified. The effective OPNOTIFY value used by the system is the greater one of the indicated OPNOTIFY value and the effective failure detection interval.
- When a relative value is specified, the effective OPNOTIFY value used by the system is the sum of the effective failure detection interval plus the relative OPNOTIFY value.
- When this parameter is omitted, the default value is a relative value of +3. Thus the effective OPNOTIFY value used by the system equals three plus the effective failure detection interval.

CLEANUP=*timeinterval*

Specifies the time interval that XCF waits for multisystem applications to complete cleanup functions. The interval begins after XCF sends notification to group members that the system on which they are running is being removed from the sysplex. *timeinterval* is specified in seconds and ranges from 0 to 86400 (24 hours).

MAXMSG=*defaultmaxmsgbuffers*

Specifies the default value used if the MAXMSG keyword is not specified on

the SETXCF START command. The MAXMSG value must be a number from 1 to 999999. See *z/OS MVS Setting Up a Sysplex* for further information about determining message buffer space.

RETRY=defaultretrylimit

Specifies the default value used if the RETRY keyword is not specified on the SETXCF START command. It is the number of failures that XCF tolerates before it marks a path as inoperative. Specify a value between 3 and 255.

CLASSLEN=defaultclasslength

Specifies the default message length for the transport classes, used if the CLASSLEN keyword is not specified on the SETXCF START command. XCF uses this length to optimize its processing for messages sent in a transport class. Specify a value between 0 and 62464.

TYPE=(name,name...)

Specifies the type of data stored in this couple data set.

The supported names include:

- SYSPLEX for sysplex (XCF) types
- ARM for automatic restart management
- CFRM for coupling facility resource management
- LOGR for system logger
- SFM for sysplex failure management
- WLM for workload management
- BPXMCDS for z/OS UNIX System Services

Other TYPEs might exist for other components. Please check the component documentation for information on what to specify for TYPE in this and other XCF operator commands and the XCF COUPLExx parmlib member.

The name or names specified must correspond to the name or names used when the couple data set was formatted with the couple data set format utility, IXCL1DSU. See *z/OS MVS Setting Up a Sysplex* for a description of the couple data set format utility.

The following keywords all refer to the couple data sets that support the service specified by the TYPE keyword.

PCOUPLE=(primarydsname,primaryvolume)

Specifies the data set to use as the primary couple data set for the type of service specified by TYPE=. Note that you cannot specify PCOUPLE to identify the sysplex couple data set (which is initially specified in the COUPLExx parmlib member).

The data set must be defined and formatted with the XCF format utility.

If the service is already operational in the sysplex, the system ignores the data set specified by PCOUPLE. Instead, the system attempts to make the service available to the system by using the couple data set that is currently supporting the service on other systems in the sysplex.

If the service is not already operational in the sysplex, the system attempts to use the specified data set as the primary couple data set for the service specified.

When TYPE=(CFRM) is specified and the CFRM couple data set is added to the sysplex, it **MUST NOT BE REMOVED OR DELETED**. If the CFRM

SETXCF command

couple data set is removed from the sysplex, the sysplex system will enter a non-restartable WAIT STATE. This is true even if no CFRM policies were activated.

ACOUPLE=(*alternatedsname,alternatevolume*)

Specifies the data set to use as the alternate couple data set for the type of service specified by TYPE=. The data set must already be allocated on the volume specified. The data set must be defined and formatted with the XCF format utility.

For each parameter specified in the format utility, the parameter values must be equal to or greater than the parameter values that were used to format the current primary couple data set. See "Planning the Couple Data Sets" in *z/OS MVS Setting Up a Sysplex* for additional information.

When you add a new alternate couple data set to the sysplex, the system copies the policies on the primary couple data set to that new alternate couple data set. The policies it copies from the primary couple data set replace any policies that existed on the alternate couple data set.

You do not need to specify the *alternatevolume*. If the volume is not specified, the data set must be cataloged. If the volume is specified, the system does not use the catalog to locate the data set.

If the system can use the specified couple data set for the service specified, then the data set becomes the alternate couple data set for that service. The system deallocates the data set that the system had been using as the alternate couple data set for the service at the time the SETXCF command was issued if the data set is no longer in use for any service in the sysplex.

PSWITCH

Specifies that the current alternate couple data set for the type of service defined is to become the primary couple data set. The system stops using the current primary couple data set and deallocates it if it is no longer in use by any service in the sysplex.

Using the TYPE Keyword: Remember the following when using the TYPE keyword:

- If you use PSWITCH with the TYPE keyword, the couple data set switched is the one containing the type of data specified (ARM, BPXMCDS, CFRM, LOGR, SFM or WLM).

If you use PSWITCH without the TYPE keyword, the sysplex couple data set is switched.

- If you use ACOUPLE with the TYPE keyword, the alternate couple data set is the one containing the type of data specified (ARM, BPXMCDS, CFRM, LOGR, SFM or WLM). The specified alternate couple data set must be accessible and usable from all systems in the sysplex that are using the policy for that service.

If you use ACOUPLE without the TYPE keyword, the alternate couple data set is the sysplex couple data set and, as such, must be accessible and usable from all systems in the sysplex.

SETXCF DUMPCF command

Use the SETXCF DUMPCF command to request a CF dump. The CF dump request is sent from the system on which the command is issued.

For more information about the SETXCF DUMPCF command parameters, see *z/OS MVS Setting Up a Sysplex* and *z/OS MVS Initialization and Tuning Reference*.

```
SETXCF DUMPCF, {CFNAME=cfname [, TYPE={NONDISRUPTIVE|DISRUPTIVE}] [, UNCOND={NO|YES}] }
                {STRNAME=strname }
```

The parameters are:

CFNAME=*cfname*

Specifies the CF to be dumped.

TYPE={NONDISRUPTIVE|DISRUPTIVE}

Optionally, when set to DISRUPTIVE, requests a disruptive CF dump. Default value: NONDISRUPTIVE

UNCOND={NO|YES}

Optionally, when set to YES, bypasses a confirmation when a disruptive CF dump is requested. Default value: NO

STRNAME=*strname*

Requests a nondisruptive dump of the CFs in which the specified structure, *strname*, resides.

SETXCF FORCE command

Use the SETXCF FORCE command to clean up coupling facility structures without connections, persistent connections to coupling facility structures, coupling facility structure dumps, coupling facility structure dump serialization, Automatic Restart Management (ARM) elements, or structures pending-deallocation from a coupling facility that is no longer connected to any systems in the sysplex.

A structure is identified by its structure name, which can be up to 16 characters long. The name can contain numeric characters, uppercase alphabetic characters, national characters (\$, @, #), or an underscore (_). The structure name must begin with an uppercase alphabetic character. Structure names provided by IBM begin with SYS or the letters A through I.

Note that if you issue the SETXCF FORCE command for a coupling facility resource (that is not already pending deletion) from a system that does not have connectivity to the coupling facility that contains the resource, the system accepts the command; however, the command remains pending until either the system establishes connectivity with the coupling facility or another system processes the deletion.

When forcing deregistration of an ARM element, you must issue the command from the system on which the element registered. If the system on which the element registered is no longer active, issue the command from any system in the sysplex. The system will respond to a valid ARMDEREGISTER command with a message indicating whether the command was completed or rejected — IXC393I. If the element might be in use by the system, you must reply to the IXC394A message issued before getting the IXC393I.

Attention: To reduce the risk of losing data, do not force the deletion of structures, connections, or ARM elements unless you understand their use in the sysplex by applications or subsystems.

SETXCF command

For additional information about the circumstances under which to issue the SETXCF FORCE command, see "Coupling Facility Replacement and Reconfiguration Guidelines" in *z/OS MVS Setting Up a Sysplex*.

For more information about the SETXCF FORCE parameters see both *z/OS MVS Setting Up a Sysplex* and *z/OS MVS Initialization and Tuning Reference*.

```
SETXCF FORCE,  
  {STRUCTURE,STRNAME=(strname[,strname]...)}  
  {CONNECTION,STRNAME=strname,CONNNAME={(conname[,conname]...)|ALL}}  
  {STRDUMP,STRNAME=strname[,STRDUMPID=strdumpid]}  
  {STRDUMPSERIAL,STRNAME=strname[,STRDUMPID=strdumpid]}  
  {ARMDEREGISTER,ELEMENT=element}  
  {PNDSTR,CFNAME=cfname}
```

STRUCTURE or STR

Directs the system to force the deletion of a named coupling facility structure. If a dump for the specified structure is in progress, deallocation of the structure remains pending until either the dump is complete or the dump is forced using the STRDUMP option. The system notifies the operator that the command is accepted but that the structure is pending deallocation.

STRNAME or STRNM=(strname[,strname]...)

Identifies one or more persistent coupling facility structures to delete. In order to delete the structure with the SETXCF FORCE command, the structure must have no active connections. If only failed-persistent connections to the structure exist, the structure can be deleted with the SETXCF FORCE command.

CONNECTION or CON

Directs the system to force the deletion of a failed-persistent connection. The system will not force failed-persistent connections to a persistent lock or serialized list structure because of the possibility of an undetected loss of data. The system will reject such a FORCE,CONNECTION request with message IXC354I or IXC363I.

STRNAME or STRNM=strname

Specifies the name of an active structure that contains the connection to be deleted. *strname* can be up to 16 alphanumeric characters long and must begin with an uppercase alphabetic character.

CONNNAME= or CONNM=(conname[,conname]...) or ALL

Directs the system to delete one or more connections to the named structure. You can use SETXCF FORCE only to delete a failed-persistent connection.

When you specify CONNNAME=ALL, you request the system to delete all failed-persistent connections to the specified structure.

STRDUMP or STRD

Specifies the system is to force the deletion of a structure dump. The structure is either actively in use by the sysplex or pending deallocation. Under normal operating conditions when a structure dump is associated with a structure in the coupling facility, the structure dump identifier is recorded in the active

CFRM policy. However, if a situation arises where the structure dump identifier does not get recorded in the active CFRM policy, the SETXCF FORCE,STRDUMP command can still be used to delete the structure dump. To force the structure dump in this case, omit the STRDUMPID= keyword and the system will determine the structure dump identifier.

STRNAME= or STRNM=*strname*

Specifies the name of the structure for which to delete the structure dump.

STRDUMPID= or STRDID=*strdumpid*

Identifies the structure dump to be deleted, where *strdumpid* is the structure dump identifier. Use the DISPLAY XCF,STRUCTURE command to determine the structure dump identifier. The structure dump identifier can be up to four hexadecimal digits.

The structure dump identifier uniquely differentiates between a structure dump associated with a structure actively in use in the sysplex and a structure dump associated with a structure pending deallocation.

- If you omit this parameter, the structure dump associated with the named structure actively in use in the sysplex is the one that is deleted.
- You must specify this parameter when deleting a structure dump associated with a structure that is pending deallocation.

STRDUMPSERIAL or STRDSER

Specifies that the system is to release its dumping serialization for a coupling facility structure. The structure must be actively in use in the sysplex. Under normal operating conditions when a structure dump is associated with a structure in the coupling facility, the structure dump identifier is recorded in the active CFRM policy. However, if a situation arises where the structure dump identifier does not get recorded in the active CFRM policy, the SETXCF FORCE,STRDUMPSERIAL command can still be used to release the structure dump serialization. To force the structure dump serialization in this case, omit the STRDUMPID= keyword and the system will determine the structure dump identifier.

STRNAME= or STRNM=*strname*

Identifies the structure for which to release dump serialization.

STRDUMPID= or STRDID=*strdumpid*

Identifies the structure dump associated with the structure for which to release dump serialization.

ARMDEREGISTER

Directs the system to force deregistration of an ARM element.

ELEMENT

Identifies the name of the ARM element to be deregistered.

PNDSTR

Specifies the system is to remove structures that are pending-deallocation from the CFRM active policy because of the loss of connectivity to the coupling facility. Structures pending-deallocation because of a structure dump will not be removed.

CFNAME

Identifies the name of the coupling facility. The coupling facility specified should be a coupling facility that is not connected to any systems in the sysplex and is going to remain inaccessible for an extended period of time (because of permanent removal for example) or a coupling facility that will

SETXCF command

be brought back online with all structures removed (because of a CF deactivate/reactivate or reboot for example).

SETXCF FUNCTIONS command

Use the SETXCF FUNCTIONS command to enable or disable optional functions provided by the XCF and XES components of z/OS. The SETXCF FUNCTIONS command is effective only on the system where the command was issued (system scope only).

```
SETXCF FUNCTIONS,{ENABLE=(function[,function ...]) }  
                {DISABLE=(function[,function ...])}
```

ENABLE=(function[,function ...])

Enables one or more optional functions. The parentheses can be omitted if only one function is specified.

DISABLE=(function[,function ...])

Disables one or more optional functions. The parentheses can be omitted if only one function is specified.

See topic "The FUNCTIONS Statement" in *z/OS MVS Setting Up a Sysplex* for a description of the optional functions currently defined.

SETXCF MODIFY command

Use the SETXCF MODIFY command to change current XCF parameters. The system changes only those parameters explicitly provided on the SETXCF MODIFY command; all other parameters associated with the resource remain the same.

- Modify inbound paths
- Modify outbound paths
- Modify local message space
- Modify transport classes
- Modify CF structure alter permission
- Modify thresholds for converting synchronous CF requests to run asynchronously.

The complete syntax for the SETXCF MODIFY command is:

```

SETXCF MODIFY, {PATHIN, {DEVICE=([/]indevnum[, [/]indevnum]...)} }
                {STRNAME=(strname[, strname]...)} }
                [, MAXMSG=maxmsgbuffers]
                [, RETRY=retrylimit]

                {PATHOUT, {DEVICE=([/]outdevnum[, [/]outdevnum]...)} }
                {STRNAME=(strname[, strname]...)} }
                [, CLASS=classname]
                [, MAXMSG=maxmsgbuffers]
                [, RETRY=retrylimit]

                {STRNAME or STRNM={strname|ALL},
                ALTER={DISABLED|ENABLED}}

                {LOCALMSG, MAXMSG=maxmsgbuffers }
                [, CLASS=class-name]

                {CLASSDEF, CLASS=classname }
                [, CLASSLEN=classlength]
                [, MAXMSG=defaultmaxmsgbuffers]
                [, ADDGROUP=(groupname[, groupname]...)]
                [, DELGROUP=(groupname[, groupname]...)]

                {SYNCA SYNC }
                [, SIMPLEX={nnnn|DEFAULT}]
                [, DUPLEX={nnnn|DEFAULT}]
                [, LOCKSIMPLEX={nnnn|DEFAULT}]
                [, LOCKDUPLEX={nnnn|DEFAULT}]

```

The parameters are:

PATHIN or PI, DEVICE= or DEV=([/]indevnum[, [/]indevnum]...)
[, RETRY=retrylimit]

Specifies the device number of one or more inbound signalling paths. A device number, *indevnum*, is 3 or 4 hexadecimal digits, optionally preceded by a slash (/). If you specify only one device, you do not need to enter the parentheses.

Use the RETRY keyword to modify the retry limit and the MAXMSG keyword to modify the amount of message buffer space. You must specify at least one of the MAXMSG or RETRY keywords. The MAXMSG value must be a number from 1 to 999999.

PATHIN or PI, STRNAME or STRNM=(strname[, strname]...)

Specifies the name of one or more coupling facility structures that are associated with defined XCF inbound signalling paths and that are to be modified.

The structure name can be up to 16 alphanumeric characters long, and must begin with an uppercase alphabetic character. If you specify only one structure name, you do not need to enter the parentheses.

PATHOUT or PO, DEVICE or DEV=([/]outdevnum[, [/]outdevnum]
[, MAXMSG=maxmsgbuffers] [, RETRY=retrylimit]

Specifies the device number of one or more outbound signalling paths. A device number, *outdevnum*, is 3 or 4 hexadecimal digits, optionally preceded by a slash (/). If you specify only one device, you do not need to enter the parentheses.

Use the RETRY keyword to modify the retry limit, the CLASS keyword to modify the transport class assignment, and the MAXMSG keyword to modify

SETXCF command

the amount of message buffer space. You must specify at least one of the MAXMSG, CLASS, or RETRY keywords. The MAXMSG value must be a number from 1 to 999999.

PATHOUT or PO,STRNAME or STRNM=(*strname*[,*strname*]...)

Specifies the name of one or more coupling facility structures that are associated with defined XCF outbound signalling paths and that are to be modified.

The structure name can be up to 16 alphanumeric characters long, and must begin with an uppercase alphabetic character. If you specify only one structure name, you do not need to enter the parentheses.

STRNAME or STRNM={*strname*|ALL}

Specifies a structure name pattern identifying the name of one or more coupling facility structures that are to be modified. The structure name pattern can be up to 16 characters long. ALL or * can be specified to modify all structures, or a valid structure name followed by an optional wildcard (*) suffix can be specified. A valid structure name begins with an uppercase alphabetic character (A – Z) and can also contain numeric characters and the four special characters: \$, @, #, _.

ALTER=DISABLED

CF structure alter processing is to be disabled for matching structures. Starting CF structure alter processing for such structures are not permitted.

ALTER=ENABLED

CF structure alter processing is to be enabled for matching structures.

LOCALMSG or LM,MAXMSG=*maxmsgbuffers* [,CLASS=*classname*]

Within a particular transport class, you can modify the amount of message buffer space made available for local message traffic after the creation of the class definition. The total amount of buffer space for the transport class (indicated by the optional keyword CLASS) is *maxmsgbuffers* plus the value specified or defaulted to on the MAXMSG parameter on the CLASSDEF statement of the COUPLExx parmlib member. The MAXMSG value must be a number from 1 to 999999.

If you omit CLASS, the change affects the default transport class, named DEFAULT.

CLASSDEF or CD,CLASS=*classname*

Specifies the transport class to be modified. You must specify at least one of the CLASSLEN, MAXMSG, ADDGROUP, or DELGROUP keywords.

[,CLASSLEN=*classlength*]

Use the CLASSLEN keyword to modify the message length.

MAXMSG=*defaultmaxmsgbuffers*

Use the MAXMSG keyword to modify the message buffer space. By changing the MAXMSG value, you change the amount of message buffer space initially allotted to each system for the indicated transport class. However, changing the MAXMSG value does not affect it for any existing resource — such as an outbound XCF path — in the class. The MAXMSG value must be a number from 2 to 999999. See *z/OS MVS Setting Up a Sysplex* for further information about determining message buffer space.

ADDGROUP=(*groupname*[,*groupname*]...)

Specifies one or more groups to be added to the set of groups assigned to the transport class. Groups, possibly including undesigned groups, were

assigned to this class when it was created. Explicitly assigning a group to this class does not delete the UNDESIG group from the class.

The group name *groupname* must be specified as one to eight alphanumeric and national (\$,#,@) characters, and may begin with any of these characters.

DELGROUP=(*groupname* [,*groupname*] . . .)

One or more groups to be deleted from the set of groups assigned to the transport class. If this command deletes the last assigned group from a transport class, XCF automatically assigns the undesigned groups to the class. If a transport class has no groups explicitly assigned to it, undesigned groups cannot be deleted from the class.

The group name *groupname* must be specified as one to eight alphanumeric and national (\$,#,@) characters, and may begin with any of these characters.

SYNCASYNC

Specifies the thresholds at which the system will convert synchronous CF requests to run asynchronously.

Synchronous CF requests spin while waiting for a request to complete at the CF. This activity consumes CPU resources. If the projected synchronous service time exceeds the defined threshold, z/OS converts the request to run asynchronously. A lower threshold causes more requests to run asynchronously, which reduces CPU consumption but also potentially elongates overall service time. A higher threshold causes more requests to execute synchronously, which increases CPU consumption but also potentially improves throughput.

You must specify one and only one of the following keywords with SYNCASYNC:

SIMPLEX={*nnnnn* | DEFAULT}

Specifies, in microseconds, the synchronous or asynchronous conversion threshold for all simplex requests for structures other than lock structures. Specify any number from 1 to 10000, or specify DEFAULT to use the system determined threshold.

DUPLEX={*nnnnn* | DEFAULT}

Specifies, in microseconds, the synchronous or asynchronous conversion threshold for all duplex requests for structures other than lock structures. Specify any number from 1 to 10000, or specify DEFAULT to use the system determined threshold.

LOCKSIMPLEX={*nnnnn* | DEFAULT}

Specifies, in microseconds, the synchronous or asynchronous conversion threshold for all simplex requests for lock structures. Specify any number from 1 to 10000, or specify DEFAULT to use the system determined threshold.

LOCKDUPLEX={*nnnnn* | DEFAULT}

Specifies, in microseconds, the synchronous or asynchronous conversion threshold for all duplex requests for lock structures. Specify any number from 1 to 10000, or specify DEFAULT to use the system determined threshold.

SETXCF PRSMPOLICY command

Use the SETXCF PRSMPOLICY (or PRSMPOL) command to either:

- Activate an XCF PR/SM policy, or
- Deactivate a current active XCF PR/SM policy.

In a multisystem sysplex on PR/SM, the XCF PR/SM policy provides a way for the installation to obtain high availability for multisystem applications on the MVS systems in the sysplex. See *z/OS MVS Initialization and Tuning Reference* and *z/OS MVS Setting Up a Sysplex* for information about the XCF PR/SM policy.

Note: When an active Sysplex Failure Management policy is in effect in the sysplex, the system rejects the SETXCF PRSMPOLICY command.

```
SETXCF PRSMPOLICY,{DEACTIVATE|ACTIVATE=memname}
```

The parameters are:

ACTIVATE=memname

Specifies the member in SYS1.PARMLIB that contains the XCF PR/SM policy to be activated. If an error occurs while processing the member, the current XCF PR/SM policy, if any, remains in effect.

DEACTIVATE

Specifies that all XCF PR/SM policy processing is to be stopped.

Example:

To activate the XCF PR/SM policy contained in member XCFPOL03 parmlib member, enter:

```
SETXCF PRSMPOLICY,ACTIVATE=XCFPOL03
```

SETXCF START command

Use the SETXCF START command to:

- Start new inbound signalling paths or restart inoperative inbound signalling paths
- Start outbound signalling paths or restart inoperative outbound signalling paths
- Define transport classes
- Start using a new administrative policy as an active policy
- Start rebuilding one or more coupling facility structures either in the same coupling facility or in another coupling facility
- Start populating a coupling facility that has been newly brought into service or returned to service in a sysplex with structures selected from the set of those defined in the active CFRM policy. The structures selected are those that list the coupling facility to be populated as higher in the structure's preference list than the coupling facility in which the structure already is allocated
- Start duplexing of one or more structures in a coupling facility.
- Start altering the size of a coupling facility structure
- Start the REALLOCATE process. The REALLOCATE process uses the XCF structure allocation algorithm and the structure definition in the active or pending CFRM policy to evaluate each allocated structure. When this evaluation

indicates that adjustments can be made for an allocated structure, then REALLOCATE processing makes the appropriate adjustments.

- Transition from a policy-based event and confirmation management protocol to a message-based event and confirmation management protocol.
- Place a specific coupling facility or a list of coupling facilities into maintenance mode. When a coupling facility is in maintenance mode, the XCF structure allocation algorithm prevents the allocation of a coupling facility structure in the coupling facility.

An inoperative signalling path remains defined to XCF but is not in use. DISPLAY XCF lists inoperative as well as active signalling paths. When you restart an inoperative signalling path with SETXCF START, you can alter MAXMSG, RETRY, and CLASS. These values take effect when XCF restarts the signalling path.

The complete syntax for the SETXCF START command is:

```

SETXCF START, {CLASSDEF, CLASS=classname }
                [, CLASSLEN=classlength]
                [, MAXMSG=maxmsgbuffers]
                [, GROUP=(groupname[, groupname]...)]
    {MSGBASED}
    {PATHIN, {DEVICE=([/]indevnum[, [/]indevnum]...)} }
                {STRNAME=(strname[, strname]...)}
                [, MAXMSG=maxmsgbuffers]
                [, RETRY=retrylimit]

    {PATHOUT, {DEVICE=([/]outdevnum[, [/]outdevnum]...)} }
                {STRNAME=(strname[, strname]...)}
                [, MAXMSG=maxmsgbuffers]
                [, RETRY=retrylimit]
                [, CLASS=classname]

    {POLICY, TYPE=name, POLNAME=polname }

    {REBUILD, {POPULATECF=cfname} }
                {DUPLEX, }
                {STRNAME=(strname[, strname]...)}
                {CFNAME=(cfname[, cfname]...)}
                [, LOCATION={NORMAL|OTHER}}
                [, LESSCONN={TERMINATE|CONTINUE}]

    {ALTER, STRNAME=strname, SIZE=size[u] }
    {REALLOCATE }
    {MAINTMODE, CFNAME=(cfname[, cfname]...)} }

```

CLASSDEF or CD, CLASS=classname

Specifies a definition for a new transport class. You must specify the *classname* as one to eight alphanumeric and national (\$, #, @) characters, and may begin with any of these characters. The DEFAULT transport class always exists. If you specify only one class, you do not need to enter the parentheses.

CLASSLEN=classlength

Specifies the message length for this transport class, where *classlength* must be a number between 0 and 62464. If you omit this keyword, the system uses the current CLASSLEN value (specified either on the SETXCF COUPLE command or in the COUPLExx parmlib member).

MAXMSG=maxmsgbuffers

Specifies the default amount of message buffer space allotted for messages

SETXCF command

sent in this transport class, where MAXMSG value must be a number between 2 and 999999. See *z/OS MVS Setting Up a Sysplex* for further information about determining message buffer space.

If you omit this keyword, the system uses the MAXMSG value specified on either the SETXCF COUPLE command or in the COUPLE statement in the COUPLExx parmlib member).

GROUP or GRP =(*groupname* [, *groupname*] . .)

Assigns one or more groups to the transport class. The order in which groups are specified is unimportant; all groups have equal access to the signalling services. If you omit this keyword, XCF assigns all groups not currently assigned (the UNDESIG groups), to the classname specified on the CLASSDEF parameter.

You must specify the group name *groupname* as one to eight alphanumeric and national (\$, #, @) characters, and may begin with any of these characters.

MSGBASED

Switch to a message-based event and confirmation management protocol from a policy-based event and confirmation protocol. The sysplex must be running with a version of the CFRM couple data set that supports message-based event and confirmation processing in order for this command to execute successfully. The system chooses the system where the SETXCF START,MSGBASED command was issued as the new event managing system.

PATHIN or PI, DEVICE or DEV=(*[/]* *indevnum* [, *[/]* *indevnum*] . . .)

Specifies the device number of one or more inbound signalling paths that XCF can use. A device number, *indevnum*, is 3 or 4 hexadecimal digits, optionally preceded by a slash (/). If you specify only one device, you do not need to enter the parentheses.

The specified device must be unallocated. The system at the other end of a signalling path must be inactive or part of the sysplex, and the other end of the path must be defined to XCF as an outbound path.

Once the command completes, the other systems in the sysplex can begin to send signalling traffic on the path to this system. For a signalling path device that is not online, MVS can vary the device online when you use this command to start the signalling path. The device remains defined to XCF until the definition is deleted through the SETXCF STOP command.

PATHIN or PI, STRNAME or STRNM=(*strname* [, *strname*] . . .)

Specifies the name of one or more coupling facility structures that XCF can use as inbound signalling paths. The designated structure is defined as a signalling path only to this system and not to every system in the sysplex. Other systems that are connected to the structure must also define the structure for use as a signalling path.

The structure name *strname* can be up to 16 alphanumeric characters long and must begin with 'IXC'. The remaining characters can be numeric, uppercase alphabetic, national characters (\$, @, #), or an underscore (_). If you specify only one structure name, you do not need to enter the parentheses.

MAXMSG=*maxmsgbuffers*

Specifies the maximum amount of message buffer space, in kilobytes, that XCF can use to receive messages through the inbound signalling path. If you omit this keyword, the system uses the current MAXMSG value

(specified on either the SETXCF COUPLE command or the COUPLE statement of the COUPLExx parmlib member). The MAXMSG value must be a number from 1 to 999999.

RETRY=retrylimit

Specifies the *retrylimit* for the inbound signalling paths. If you omit this keyword, the system uses the RETRY value, a number between 3 and 255 specified on either the SETXCF COUPLE command or the COUPLE statement of the COUPLExx parmlib member.

PATHOUT or PO,DEVICE or DEV=([/]outdevnum[,[/]outdevnum)..

Specifies the device number of one or more outbound signalling paths that XCF can use. A device number, *outdevnum*, is 3 or 4 hexadecimal digits, optionally preceded by a slash (/). If you specify only one device, you do not need to enter the parentheses.

The specified device must be unallocated. The system at the other end of the path must be inactive or part of the sysplex, and the other end of the path must be defined to XCF as an inbound path. Once the command completes successfully, the other system in the sysplex can begin to receive signalling traffic on the path from this system. For a signalling path device that is not online, MVS can vary the device online when you use this command to start the signalling path. The device remains defined to XCF until the definition is deleted through the SETXCF STOP command.

PATHOUT or PO,STRNAME or STRNM=(strname[,strname]...)

Specifies the name of one or more coupling facility structures XCF can use as outbound signalling paths. The designated structure is defined only to this system, not to every system in the sysplex. Other systems connected to the structure must also define the structure for use as a signalling path.

The structure name *strname* can be up to 16 alphanumeric characters long and must begin with 'IXC'. The remaining characters can be numeric, uppercase alphabetic, national characters (\$, @, #), or an underscore (_). If you specify only one structure name, you do not need to enter the parentheses.

MAXMSG=maxmsgbuffers

Specifies the amount of message buffer space contributed by this signalling path. If you omit this keyword, the system uses the current MAXMSG value for the transport class that this path is assigned. The MAXMSG value must be a number between 1 and 999999.

RETRY=retrylimit

Specifies the *retrylimit* for the outbound signalling path. If you omit this keyword, the system uses the current RETRY value, a number between 3 and 255 specified on either the SETXCF COUPLE command or the COUPLE statement of the COUPLExx parmlib member.

CLASS=classname

Specifies the name of the transport class to which the outbound signalling paths are assigned. If you omit this keyword, the system uses the DEFAULT transport class. The classname must be previously defined. You must specify the *classname* as one to eight alphanumeric and national (\$,#,@) characters, and may begin with any of these characters.

POLICY or POL,TYPE=name,POLNAME or POLNM=polname

Specifies that the administrative policy named is to be made active in the sysplex or that the active policy is to be changed. The system from which the SETXCF command is issued must have access to the couple data set supporting the service.

SETXCF command

See *z/OS MVS Setting Up a Sysplex* for information about transitioning to a new administrative policy.

TYPE=*name*

Specifies the *name* of the service that is using the couple data set for policy data. The supported services are:

- ARM for automatic restart management
- CFRM for coupling facility resource management
- SFM for sysplex failure management

POLNAME or POLNM=*polname*

Specifies the name of the administrative policy to be made active.

Note: When TYPE=ARM is specified, POLNAME is optional. If no policy name is specified, the policy defaults will be used.

REBUILD or RB, POPULATECF or POPCF=*cfname*

Specifies the name of the coupling facility that is to be populated with structures selected from the set of allocated structures in the active CFRM policy.

A structure rebuild will be attempted for each allocated structure in the policy that contains the specified coupling facility in its preference list, if the specified coupling facility is at a higher position in the preference list than the coupling facility in which the structure currently is allocated. If the structure is allocated in a more preferable coupling facility already, the rebuild will not continue.

POPULATECF rebuild processing assumes LOCATION=OTHER. LOCATION and LESSCONN options cannot be specified.

Each structure that contains the specified coupling facility at a higher position in its preference list will be processed serially to completion (either stopped or completed) before the next structure is selected. The serial nature of this processing allows even XCF signalling structures to be selected for coupling facility population.

The coupling facility name can be up to 8 alphanumeric characters long and must begin with an uppercase alphabetic character. The name can contain numeric characters, uppercase alphabetic characters, national characters (\$, @, #), or an underscore (_).

REBUILD or RB, DUPLEX, STRNAME or STRNM=(*strname* [, *strname*] ...)

Specifies the name of one or more coupling facility structures that are to be duplexed in another coupling facility.

If structure duplexing is not supported for the target structure, the duplexing operation will not be started and the system issues a message to the operator.

Duplexing rebuild processing assumes LOCATION=OTHER and LESSCONN=TERMINATE. Other LOCATION and LESSCONN options cannot be specified.

The structure name can be up to 16 characters long and can contain numeric characters, uppercase alphabetic characters, national characters (\$, @, #), or an underscore (_). The name must begin with an uppercase alphabetic character. IBM names begin with SYS, or letters A-I.

If you specify only one structure name, you do not need to enter the parentheses.

REBUILD or RB,DUPLEX,CFNAME=(*cfname* [, *cfname*] ...)

Specifies the name of one or more coupling facilities for which all structures are to be duplexed in a different coupling facility.

The system attempts to start a duplexing operation for each structure that is currently allocated in the specified coupling facility.

If structure duplexing is not supported for a particular structure, the system issues a message to the operator.

The coupling facility name can be up to 8 alphanumeric characters long and can contain numeric characters, uppercase alphabetic characters, national characters (\$, @, #), or an underscore (_). It must begin with an uppercase alphabetic character.

If you specify only one coupling facility name, you do not need to enter the parentheses.

REBUILD or RB,STRNAME or STRNM=(*strname* [, *strname*] ...)

Specifies the name of one or more coupling facility structures that are to be rebuilt in the same coupling facility or another coupling facility. The structure name can be up to 16 alphanumeric characters long and must begin with an uppercase alphabetic character. IBM names begin with SYS, or letters A-I. If you specify only one structure name, you do not need to enter the parentheses.

REBUILD or RB,CFNAME or CFNM=(*cfname* [, *cfname*] ...)

Specifies the name of one or more coupling facilities for which all structures other than XCF signalling structures are to be rebuilt. The coupling facility name can be up to 8 alphanumeric characters long and must begin with an uppercase alphabetic character. If you specify only one coupling facility name, you do not need to enter the parentheses.

For any given structure, the system might not start rebuild. *z/OS MVS Programming: Sysplex Services Guide* lists the requirements for rebuild initiation. For example, if the named coupling facility contains one or more XCF signalling structures, the system does not start rebuild for them. To rebuild an XCF-signalling structure, issue the SETXCF START,REBUILD,STRNAME=... command for one structure at a time.

LOCATION=NORMAL or OTHER

Specifies the location where the new structure or structures can be rebuilt. If you specify LOCATION=NORMAL, the new structure can be allocated in any coupling facility in the preference list, following the normal allocation rules. If you specify LOCATION=OTHER, the new structure cannot be allocated for rebuild in the same coupling facility as the original structure. The new structure can be allocated in any other coupling facility in the preference list, following the normal allocation rules.

Duplexing rebuild and POPULATECF processing assume LOCATION=OTHER.

Note that before the rebuild process begins, you might need to change the administrative policy to specify where the structure can reside and then activate the policy. The CFRM administrative policy contains the preference list that specifies coupling facilities where a structure can reside.

LESSCONN or LC=TERMINATE or CONTINUE

Specifies the action the system is to take when rebuilding the structure results in a new structure that has poorer connectivity relative to the set of active structure connectors than the old structure does.

SETXCF command

- With LESSCONN=TERMINATE, the system stops the rebuild processing for the new structure if connectivity relative to the set of active connectors to the structure is not equal or better than it was to the current structure.

LESSCONN=TERMINATE is the default system action. This protects active connectors against inadvertently losing connectivity to the structure as a result of rebuilding the structure.

Duplexing rebuild processing assumes LESSCONN=TERMINATE.

- With LESSCONN=CONTINUE, the system allows the rebuild processing for the new structure even if connectivity relative to the set of active connectors to the structure is poorer than it was to the current structure.

Attention: Because this might cause active connectors to lose connectivity to the structure, do not use this keyword unless you understand the impact to the application or subsystem.

Some connectors stop the rebuild if a loss of connectivity is observed, but most connectors disconnect from the structure to allow the rebuild to complete. For many exploiters, disconnecting from the structure is likely to result in losing the sysplex-related functionality (for example, loss of data sharing capability) on that system. For critical system exploiters, this may result in a system wait state. See the application or subsystem documentation for recommendations.

ALTER,STRNAME or STRNM=*strname*,SIZE=*size* [*u*]

Specifies that structure alter processing is to be initiated.

STRNAME or STRNM=*strname*

Specifies the name of the coupling facility structure to be altered. You can specify only one structure name. The name can be up to 16 alphanumeric characters long and must begin with an uppercase alphabetic character. The name can contain numeric characters, uppercase alphabetic characters, national characters (\$,@,#) or an underscore(_). IBM names begin with SYS, or letters A-I.

SIZE=*size* [*u*]

Specifies the target size of the structure to be altered in an integer unit of *u*, where *u* is specified as K (kilobytes), M (megabytes), G (gigabytes), or T (terabytes). If a size unit value is not specified, the default is K (kilobytes). Size is bounded by the minimum and maximum sizes determined when the structure was allocated. The minimum size of a structure is determined by the coupling facility; the maximum size of a structure is established by the installation in the CFRM policy. (Use the DISPLAY XCF,STRUCTURE,STRNAME=*strname* command to determine the maximum structure size allowed.)

Note: For report and for the purpose of messages, the size unit specified may be converted to the largest size unit that can be used to represent the size and avoids any rounding. For example, specifying SIZE=1048576K may cause SIZE to be converted to SIZE=1G for the purpose of messages. Specifying SIZE=120000K will not cause SIZE to be converted because it is not an even multiple of megabytes, gigabytes, or terabytes.

REALLOCATE or REALLOC

Specifies that the REALLOCATE process is to be initiated.

The REALLOCATE process evaluates each allocated structure to recognize the need to make the following adjustments:

- Relocate the structure instance or instances
- Complete a pending policy change
- Trigger MVS-initiated duplexing

The evaluation of each allocated structure uses the XCF structure allocation algorithm and either the active or pending CFRM policy definition for the structure. Message IXC574I is written to the hardcopy log to show the current location of instances allocated in coupling facilities, the policy information used, and the evaluation result. Then it compares the current location with the location identified by evaluation to determine what if any adjustments are needed.

By evaluating the allocated structure, the REALLOCATE process can recognize that the structure is optimally located and immediately complete a change to the policy definition for the structure when the change does not affect the size. In addition, REALLOCATE processing is a triggering event for MVS-initiated duplexing rebuild when it finds the structure is not duplexed and DUPLEX(ENABLED) is specified for the structure in the CFRM policy.

The REALLOCATE process recognizes the need to relocate structure instances when one of the following conditions is detected:

- There is a change to the policy definition for the structure affecting the structure size or location.
- The structure is not optimally located.

To control the relocation of a specific structure by the REALLOCATE process, you can specify the ALLOWREALLOCATE(YES|NO) keyword for the structure in the CFRM policy.

- If you specify or default to ALLOWREALLOCATE(YES) for the structure in the CFRM policy:

When the REALLOCATE process recognizes the need to relocate structure instances (see the preceding description of such conditions), the structure is selected as the target of the REALLOCATE process and the structure rebuild process is used to make the adjustments. Structure rebuild process supports the following:

- User-managed rebuild
- User-managed duplexing rebuild
- System-managed rebuild
- System-managed duplexing rebuild

Multiple steps may need to be taken to complete the relocation of a selected structure. The steps are accomplished using structure rebuild processing (for example, user-managed rebuild) to adjust the location or activate a pending policy change for the structure that is the target of the REALLOCATE process. Messages to the operator document the steps being taken for each structure that is examined.

- For a simplex structure, one step (rebuild) is used to adjust the location or to activate a pending policy change.
- For a duplexed structure, two or three steps are used. The first step stops duplexing and one or more subsequent steps are used as needed to adjust the location, activate a pending policy change, and to reduplex the structure. If a subsequent step cannot be started, the system issues message IXC546I with an explanation.
- A duplexed structure can also be converted to simplex structure when one of the duplexed structure instances is allocated in a coupling facility

SETXCF command

that does not permit structure allocation (for example, maintenance mode) and it is not possible to reduplex the structure. In this case, one or two steps are used. The first step stops duplexing and a second step might be needed to relocate the simplex structure or activate a pending policy change.

- If you specify `ALLOWREALLOCATE(NO)` for the structure in the CFRM policy:
The `REALLOCATE` process evaluates the allocated structure but does not select the structure as the target of the `REALLOCATE` process. However, when `NO` is specified it is still possible for the `REALLOCATE` process to do the following adjustments if applicable:
 - Complete a pending policy update when the pending change does not affect the size or location.
 - Trigger an MVS-initiated duplexing rebuild when `DUPLEX(ENABLED)` is specified for the structure and the structure is not duplexed.

When the `REALLOCATE` process does not select an allocated structure, message `IXC544I` is issued with an explanation.

When the start request is accepted, the `DISPLAY XCF,STR` or the `DISPLAY XCF,CF` command shows `THE REALLOCATE PROCESS IS IN PROGRESS`. For a summary of allocated structure status, use the `DISPLAY XCF,STR,STATUS=ALLOCATED` command:

- The structure that is the current target indicates `TARGET OF REALLOCATE PROCESS`.
- Allocated structures which have not been evaluated indicate `REALLOCATE EVALUATION PENDING`.
- Structures which have been processed do not have additional status indicators displayed but the log can be examined to determine the action taken.

When the entire process completes for all structures, the processing provides a report (message `IXC545I`) summarizing the actions that were taken as a whole. The `REALLOCATE` process evaluates all allocated structures, in a serial (one structure at a time) fashion. Each selected structure is processed to completion before the next structure is evaluated. The serial nature of this processing allows even `XCF` signalling structures to be selected for relocation.

`REALLOCATE` processing evaluates a structure based on the CFRM policy and on the current conditions (for example, available coupling facilities, coupling facility attributes, and connection attributes), and for each structure selected for processing, takes the necessary steps to adjust the location of the structure's allocated instances. From the time a structure is evaluated to the time when the steps using structure rebuild processing cause a new instance to be allocated, it is possible for the conditions to have changed. The result is that the current conditions are used when the structure allocation algorithm is applied. The `REALLOCATE` process does not validate the resulting location of the allocated instances but relies on the result of applying the `XCF` allocation criteria. Because of this, it is possible that the coupling facilities shown as preferred when message `IXC574I` was written to the hardcopy log with the evaluation information are not the coupling facilities containing the allocated instances when the necessary steps finish. Where `REALLOCATE` processing intersects with other environmental changes (for example, starting or stopping a structure rebuild process due to a policy change, a coupling facility failure, or loss of connectivity to a coupling facility), the other ongoing process will take precedence with `REALLOCATE` processing issuing messages `IXC544I` or

IXC546I as appropriate. For some environmental changes (for example, a coupling facility failure), the installation may choose to stop the REALLOCATE process.

Consider the following when you use the SETXCF START,REALLOCATE command:

- Move structures out of a coupling facility following a CFRM policy change that deletes/changes that coupling facility (for example, in preparation for a coupling facility upgrade).
- Move structures back into a coupling facility following a CFRM policy change that adds/restores the coupling facility (for example, following a coupling facility upgrade/add).
- Clean up pending CFRM policy changes that may have accumulated for whatever reason, even in the absence of any need for structure "relocation" per se.
- Clean up simplex or duplexed structures that were allocated in or moved into the "wrong" coupling facilities, for whatever reason (for example, the "right" coupling facility was inaccessible at the time of allocation).
- Clean up duplexed structures that have primary and secondary "reversed" because of a prior condition which resulted in having duplexing stopped with KEEP=NEW and the structure reduplexed.

Note:

1. The REALLOCATE process is mutually exclusive with the POPULATECF function, which can be started either by the SETXCF operator command or the IXLREBLD programming interface.
2. The REALLOCATE process can only be started or stopped using the SETXCF command.
3. Support for the REALLOCATE process is provided by APAR OA03481.
 - The REALLOCATE process cannot be started if there exists an active system in the sysplex that does NOT have the APAR installed. The SETXCF START,REALLOCATE command is rejected.
 - An in-progress REALLOCATE process is stopped immediately when an active system without the APAR installed is discovered in the sysplex. The SETXCF START,REALLOCATE command was accepted but subsequently an active system without the APAR installed was discovered by an up-level system which immediately stopped the process.

In both cases, message IXC543I is issued with explanatory text.
4. Enhancements for the REALLOCATE process are provided by APAR OA08688.
 - A structure-level control is provided to prevent REALLOCATE processing from selecting particular structures while allowing it to initiate structure rebuilds for others. This control is achieved by providing an option on the CFRM STRUCTURE parameter to the XCF Administrative Policy Utility (IXCMIAPU). The option is ALLOWREALLOCATE. See *z/OS MVS Setting Up a Sysplex*, Appendix C under section Coding the Administrative Data Utility for topic CFRM Parameters for Administrative Data Utility.
 - For a simplex structure with DUPLEX(ENABLED) specified, the REALLOCATE process is a triggering event. Message IXC536I is issued when MVS is able to initiate a duplexing rebuild for the structure identified by REALLOCATE processing.

SETXCF command

- When a pending policy change does not affect size, REALLOCATE processing avoids structure rebuild processing when evaluation with the pending policy shows that the structure does NOT need relocating. It completes the pending change. Message IXC544I is issued indicating ALLOCATED IN PREFERRED CF AND POLICY CHANGE MADE.
- With this enhancement, REALLOCATE processing will ignore a specified exclusion list in some cases, so as to avoid anomalies when honoring the exclusion list would have precluded structures from relocating to the optimal location.

MAINTMODE, CFNAME=(*cfname*, [*cfname* . . .])

Sets the specified coupling facility or facilities into maintenance mode. When in maintenance mode, a CF is not eligible for CF structure allocation purposes. The XCF structure allocation algorithm modifies the CF selection processing accordingly. You can use the SETXCF STOP command to turn off MAINTMODE. This setting is kept in control blocks in the storage of the ACTIVE sysplex. It is not saved across sysplex wide IPLs, so a sysplex wide IPL will clear the setting.

SETXCF STOP command

Use the SETXCF STOP command to:

- Stop one or more inbound signalling paths.
- Stop one or more outbound signalling paths.
- Delete the definition of a transport class.
- Stop using an administrative policy.
- Stop rebuilding one or more coupling facility structures.
- Stop populating a coupling facility that had been newly brought into service in a sysplex with structures selected from the set of those defined in the active CFRM policy.
- Stop duplexing of one or more structures in a coupling facility and specify the structure that is to remain in use.
- Stop altering a coupling facility structure.
- Stop an in-progress REALLOCATE process.
- Transition from a message-based event and confirmation management protocol to a policy-based event and confirmation management protocol.
- Remove a specific coupling facility or a list of coupling facilities from maintenance mode. When the coupling facility is out of maintenance mode, the XCF allocation algorithm can select the CF for allocating a coupling facility structure.

The complete syntax for the SETXCF STOP command is:

```

SETXCF STOP, {PATHIN, {DEVICE=([/] indevnum[, [/] indevnum]...)} }
                {STRNAME=(strname[, strname]...)} }
                [, UNCOND=NO|YES]

                {PATHOUT, {DEVICE=([/] outdevnum[, [/] outdevnum]...)} }
                {STRNAME=(strname[, strname]...)} }
                [, UNCOND=NO|YES]

                {CLASSDEF, CLASS=classname }
                {MSGBASED}
                {POLICY, TYPE=name }

                {REBUILD, {POPULATECF=cfname} }
                {DUPLEX, }
                {STRNAME=(strname[, strname]...)}
                {, KEEP=NEW|OLD}
                {CFNAME=(cfname[, cfname]...)} }

                {ALTER, STRNAME=strname }
                {REALLOCATE, [, FORCE] }
                {MAINTMODE, CFNAME=(cfname[, cfname]...)} }

```

ALTER, STRNAME or STRNM=*strname*

Specifies that structure alter processing should be stopped for the named structure. (Use the DISPLAY XCF,STRUCTURE command to determine which structures are being altered.)

The SETXCF STOP,ALTER command can be used to stop an alter in progress that was initiated either with a SETXCF START,ALTER command or with the IXLALTER programming interface.

STRNAME or STRNM=*strname*

Identifies the structure for which to stop structure alter processing.

CLASSDEF or CD, CLASS=*classname*

Deletes the definition for the specified transport class and frees the space allocated for message buffers. The transport class must be defined to XCF. You can delete a transport class only when no signalling paths are currently assigned to the class. You cannot delete the DEFAULT transport class definition.

MSGBASED

Switch to a policy-based protocol from the current message-based event and confirmation management protocol.

PATHIN or PI, DEVICE=([/] *indevnum*[, [/] *indevnum*]...)

Specifies the device number of one or more inbound signalling paths that XCF should no longer use. A device number, *indevnum*, is 3 or 4 hexadecimal digits, optionally preceded by a slash (/). If you specify only one device, you do not need to enter the parentheses.

A specified device must be defined to XCF as an inbound path.

Once the command completes successfully, XCF stops receiving signalling traffic along these paths and deallocates the device. The device is no longer defined to XCF as a signalling path. If a specified signalling path is the last path from another system in the sysplex, XCF rejects the command.

PATHIN or PI, STRNAME or STRNM=(*strname*[, *strname*]...)

Specifies the name of one or more coupling facility structures that XCF should no longer use. The specified structure must be defined to XCF as an inbound path.

SETXCF command

The structure name can be up to 16 alphanumeric characters long and must begin with an uppercase alphabetic character. If you specify only one structure name, you do not need to enter the parentheses.

UNCOND=NO or YES

UNCOND=NO stops a signalling path when no other stop commands are active against that path. UNCOND=YES stops a signalling path even when another stop command is active against that path. This operand stops an outstanding stop request and initiates a new one, recovering path resources so they are not lost for the duration of the IPL. Because a STOP command with the UNCOND=YES option might cause loss of signals, the system accepts the command only when an outstanding stop is active against a path.

Note: Use UNCOND=YES only at the direction of the system programmer.

PATHOUT or PO,DEVICE=([/]outdevnum[,[/]outdevnum]...)

Specifies the device number of one or more outbound signalling paths that XCF should no longer use to send messages. A device number, *outdevnum*, is 3 or 4 hexadecimal digits, optionally preceded by a slash (/). If you specify only one device, you do not need to enter the parentheses.

XCF stops sending signalling traffic along these paths, leaving the devices unallocated. The device is no longer defined to XCF as a signalling path. If a specified path is the last path to another system in the sysplex, XCF rejects the command.

PATHOUT or PO,STRNAME or STRNM=(strname[,strname]...)

Identifies one or more coupling facility structures that XCF should no longer use. The specified structure must be defined to XCF as an outbound path.

The structure name can be up to 16 alphanumeric characters long and must begin with an uppercase alphabetic character. If you specify only one structure name, you do not need to enter the parentheses.

UNCOND=NO or YES

UNCOND=NO stops a signalling path when no other stop commands are active against that path. UNCOND=YES stops a signalling path even when another stop command is active against that path. This operand stops an outstanding stop request and initiates a new one, recovering path resources so they are not lost for the duration of the IPL. Because a STOP command with the UNCOND=YES option could cause loss of signals, the system accepts the command only when an outstanding stop is active against a path.

Note: Use UNCOND=YES only at the direction of the system programmer.

POLICY or POL,TYPE=name

Directs the system to deactivate the active policy for the type of service named.

TYPE=name

Specifies the name of the service that is using the couple data set for policy data. The supported service names are:

- ARM for automatic restart management
- CFRM for coupling facility resource management
- SFM for sysplex failure management

REBUILD or RB,POPULATECF or POPCF=cfname

Specifies the name of the coupling facility in which structure population is to

stop. All structure rebuilds that were initiated by a SETXCF START,REBUILD,POPULATECF command will be stopped.

Note that you also can use the SETXCF STOP,REBUILD,CFNAME or SETXCF STOP,REBUILD,STRNAME to stop structure rebuilds that were initiated by a SETXCF START,REBUILD,POPULATECF command.

REBUILD or RB,DUPLEX,STRNAME or STRNM=(*strname* [, *strname*] ...)

Specifies the name of one or more coupling facility structures for which duplexing is to be stopped. You must also specify with the KEEP keyword which of the duplexed structures should remain after the duplexing operation has stopped.

The structure name can be up to 16 alphanumeric characters long and must begin with an uppercase alphabetic character. IBM names begin with SYS, or letters A-I. If you specify only one structure name, you do not need to enter the parentheses.

KEEP=NEW|OLD

Specifies which of the duplexed structures should remain after duplexing has stopped.

KEEP=NEW specifies that processing should switch to the new structure.

KEEP=OLD specifies that processing should fall back to the old structure.

Note:

1. If the CFRM active policy specifies DUPLEX(ENABLED) for the structure and IXLREBLD IGNOREDUPLEX=YES is not used, the system might immediately reduplex the structure after the completion of the stop processing. There might be a delay before reduplexing when only two coupling facilities are available for duplexing the structure. Reduplexing will occur immediately in configurations with three or more coupling facilities available for duplexing the structure.
2. To prevent the system from immediately reduplexing the structure or reduplexing the structure at a later time, change the DUPLEX specification for the structure to DUPLEX(ALLOWED) or DUPLEX(DISABLED). Change the DUPLEX setting for the structure in the CFRM policy to DUPLEX(ALLOWED) before stopping duplexing, or change the DUPLEX setting for the structure to DUPLEX(DISABLED), which will cause XCF to initiate the stop processing. Change the DUPLEX setting back to DUPLEX(ENABLED) when you no longer need to prevent the system from reduplexing.

REBUILD or RB,DUPLEX,CFNAME=(*cfname* [, *cfname*] ...)

Specifies the name of one or more coupling facilities in which structure duplexing is to stop.

Duplexing will be stopped for each structure in each specified coupling facility so that no structures involved in structure duplexing processing remain in the coupling facility. When more than one coupling facility is specified, a separate request is made to stop duplexing for each coupling facility specified. The order of making the requests is the same order as the coupling facilities are listed in the command.

- If the specified coupling facility contains the new structure in the duplexed pair of structures, the system will fall back to the old structure.
- If the specified coupling facility contains the old structure in the duplexed pair of structures, the system will switch to the new structure.

SETXCF command

The coupling facility name can be up to 8 alphanumeric characters long and must begin with an uppercase alphabetic character. If you specify only one coupling facility name, you do not need to enter the parentheses.

See the same notes in the REBUILD *or* RB,DUPLEX,STRNAME *or* STRNM=(*strname*[,*strname*]...) parameter.

REBUILD *or* RB,STRNAME *or* STRNM=(*strname*[,*strname*]...)

Specifies the name of one or more coupling facility structures for which rebuild processing is to stop. The structure name can be up to 16 alphanumeric characters long and must begin with an uppercase alphabetic character. IBM names begin with SYS, or letters A-I. If you specify only one structure name, you do not need to enter the parentheses.

REBUILD *or* RB,CFNAME *or* CFNM=(*cfname*[,*cfname*]...)

Specifies the name of one or more coupling facilities for which rebuild processing is to stop for all structures. The coupling facility name can be up to 8 alphanumeric characters long and must begin with an uppercase alphabetic character. If you specify only one coupling facility name, you do not need to enter the parentheses.

ALTER,STRNAME *or* STRNM=*strname*

Specifies that structure alter processing should be stopped for the named structure. (Use the DISPLAY XCF,STRUCTURE command to determine which structures are being altered.)

The SETXCF STOP,ALTER command can be used to stop an alter in progress that was initiated either with a SETXCF START,ALTER command or with the IXLALTER programming interface.

STRNAME *or* STRNM=*strname*

Identifies the structure for which to stop structure alter processing.

REALLOCATE[,FORCE] *or* REALLOC[,FORCE]

Specifies that an in-progress REALLOCATE process is to be stopped.

When stopping without specifying FORCE, REALLOCATE processing completes the steps for the current target structure then finishes. The status of the REALLOCATE processing will be "STOPPING" as shown by either the DISPLAY XCF,STR or the DISPLAY XCF,CF operator command.

When stopping with FORCE specified, REALLOCATE processing finishes immediately AND the step(s) for the current target structure might NOT be completed. Use the FORCE option when structure rebuild processing for the structure which is the target of the REALLOCATE process is not making progress.

When the process finishes, for the structures selected prior to the operator stopping the process, the processing provides a report (message IXC545I) summarizing the actions that were taken up to the time that processing was stopped.

To stop the REALLOCATE process does NOT require issuing the command without FORCE specified before issuing with FORCE specified.

MAINTMODE,CFNAME=(*cfname*, [*cfname*...])

Removes the maintenance mode indication from the specified coupling facility or facilities. When in maintenance mode, a CF is not eligible for CF structure allocation purposes. When the coupling facility is out of maintenance mode, the XCF allocation algorithm can select the CF for allocating a coupling facility structure.

SLIP command

The SLIP command controls SLIP (serviceability level indication processing), a diagnostic aid that intercepts or traps certain system events and specifies what action to take. Using the SLIP command, you can set, modify, and delete SLIP traps.

Table 65. Summary of the SLIP Command

Command:	Topic:
SLIP SET	"Setting a SLIP trap" on page 811
SLIP MOD	"Modifying an existing SLIP trap" on page 879
SLIP DEL	"Deleting an existing SLIP trap" on page 880

General information about the SLIP command is in the following topics:

- "Syntax"
- "Using SLIP commands" on page 804
- "Processing of SLIP commands" on page 805
- "Coding SLIP command parameters" on page 805

Syntax

The following introductory syntax gives you an overview of the entire command.

SLIP or SL	Description
SLIP SET[,options],END	Command for an error event trap (non-PER)
SLIP SET,IF[,options],END	Command for an instruction fetch PER trap
SLIP SET,SBT[,options],END	Command for a successful branch PER trap
SLIP SET,SA SAS[,options],END	Commands for a storage alteration PER trap
SLIP SET,ZAD[,options],END	Commands for a zero address detection PER trap
SLIP MOD[,options]	Command to modify an existing trap
SLIP DEL[,options]	Command to delete an existing trap

Notes:

- You must specify SET, MOD, or DEL immediately following SLIP.
- If you specify IF, SBT, SA, it must immediately follow SET.
- You must specify END at the end of all SLIP SET commands.

More detailed syntax is presented in the following:

- "Syntax for an error event SLIP SET command" on page 822
- "Syntax for an instruction fetch or successful branch SLIP SET PER command" on page 823
- "Syntax for a storage alteration SLIP SET PER command" on page 824
- "Syntax for a zero address detection SLIP SET PER command" on page 825
- "Syntax for the ACTION parameters for the SLIP SET command" on page 826
- "Modifying an existing SLIP trap" on page 879
- "Deleting an existing SLIP trap" on page 880

Using SLIP commands

Use a SLIP command only at the direction of the system programmer. You can enter a SLIP command:

- On a console with MVS master authority.
- On a TSO terminal in OPERATOR mode.
- In a TSO CLIST.

In the CLIST, use the line continuation character at the end of each line and the END parameter at the end of the last line.

- In an IEACMD00, COMMNDxx, or IEASLPxx parmlib member.

While you can enter a SLIP command in any of these members, IBM recommends that you place your SLIP commands in IEASLPxx and enter a SET SLIP=xx command to activate the member. IEACMD00 and COMMNDxx require that a command be on a single line. Also, SLIP may process commands in IEACMD00 and COMMNDxx in any order, but processes commands in IEASLPxx in the order in which they appear.

- The security FACILITY class entity IEASLP.REFRESH is provided for using the REFBEFOR and REFAFTER keywords on the SLIP command. When the IEASLP.REFRESH FACILITY class profile is defined, the SLIP command issuer must have UPDATE access to that profile to use the REFAFTER and REFBEFOR keywords.

SLIP traps in systems in a sysplex

For a sysplex containing similar systems, certain problems might require identical SLIP traps on those similar systems. To set up these traps, do the following:

1. Assign similar names to identical jobs on different systems. The names should form a pattern, such as JOB1, JOB2, JOB3, and so on.
2. Create one IEASLPxx member containing the trap you need for the problem.

Use a REMOTE parameter in the SLIP command so that, the first time a trap matches on a system, the action will also be taken on other systems in the sysplex. For example, the SLIP command could request a dump on its system and, through REMOTE, on all the similar systems.

Use an IDGROUP parameter so that, after the match, the identical traps on the other systems will be disabled.

Use wildcards in parameters so that the command will process in all systems in the sysplex. For example, JOB? would indicate JOB1, JOB2, JOB3, and so on.

3. Place the member in the shared parmlib data set or in the parmlib data set for each of the similar systems.
4. In systems using JES2 or JES3, activate the member or members with the following command entered on one of the systems:

```
ROUTE *ALL,SET SLIP=xx
```

If only some systems in the sysplex are similar, use a ROUTE command specifying a named subset of systems; see "ROUTE command" on page 606 for details.

When a SLIP trap results in SVC dumps from multiple systems, each dump contains the same incident token. You can use the incident token to correlate the multiple dumps to one problem.

Processing of SLIP commands

For an error event, the system gives control to SLIP before giving control to ESTAE or FRR recovery routines. This sequence allows SLIP to capture information before recovery routines change it, thus providing the advantage of working with the original problem data.

When you have defined more than one SLIP trap and SLIP gets control, SLIP first examines the most-recently defined trap. If SLIP does not find a match condition, it proceeds to the previously defined trap.

Any SLIP trap affects system performance, but PER traps can have a measurable effect on performance. Therefore, use conditions to filter the events being checked for matches, especially for PER traps. Improper use of PER traps can cause severe performance problems. See “Setting effective SLIP PER traps” on page 813.

Coding SLIP command parameters

The parameters can contain:

- Wildcard characters. See “Using wildcards in commands” on page 19.
- Indirect addresses.

Indirect Addresses

An indirect address is the address of a location or a general purpose register that contains another address. You can use indirect addressing with the following SLIP command parameters: DATA, LIST, REFAFTER, REFBEFOR, RANGE, STDATA, SUMLIST, SYSLIST and TRDATA.

Note: Indirect addresses used with SLIP are similar to those used with the TEST command in TSO except that:

- Unlimited levels of indirect addressing are permitted.
- Symbols are not used.
- Absolute addresses are not followed by a period.
- Address modifiers must be hexadecimal.

The elements of an indirect address used by SLIP are:

1. A *direct address*, which consists of 1 to 8 hexadecimal digits optionally followed by one or more displacements.
2. A *32-bit register* (or the low half of a 64-bit register), in the form nR, where n is a decimal number from 0 to 15.
3. A *64-bit register*, in the form nG, where n is a decimal number from 0 to 15. Note, if the G suffix is used on an ESA/390 system, it is translated to R.
4. *Symbolics*, which include the following forms:
 - BEAR (breaking event address register). Use the BEAR symbolic to access the address from where the last successful branch occurred, before the event that caused the SLIP action processor to receive control. When SLIP receives control for a MEMTERM, the value of the BEAR symbolic is 0.
 - BPER (beginning PER range). Use the BPER symbolic wherever an indirect address is used to refer to the beginning PER range. The BPER symbolic is most useful when using dynamic PER traps where the PER range of a subsequently activated trap is unknown when the traps are set. BPER is not applicable to ZAD PER traps.

SLIP command

Note: When using REFBEFOR or REFAFTER, the value of BPER cannot be changed. For example, REFBEFOR (BPER,EQ,01) is not allowed.

5. An *indirection indicator*, which can be a percent sign (%), a question mark (?), or an exclamation point (!). The indirection indicator says that the information at the direct address or in the register is a fullword pointer to the data. A percent sign means that the pointer is a 24-bit address. A question mark means that the pointer is a 31-bit address. An exclamation point means that the pointer is a 64-bit address.
6. A *displacement*, which begins with a plus or minus sign and consists of 1 to 8 hexadecimal digits. The maximum displacement allowed is 7FFFFFFF.

In the expression 128%+4%+8%+C 128 is a direct address. % signs indicate 24-bit indirect addressing. +4, +8, and +C are displacements.

In the expression

2R??+4?+8?+C

2R is the register (general purpose register 2).

?? and ? indicate 31-bit indirect addressing.

2R?? is equivalent to 2R?+0?.

+4, +8, and +C are displacements.

To refer to data when the address of the data is located at A24, specify A24?. Graphically:

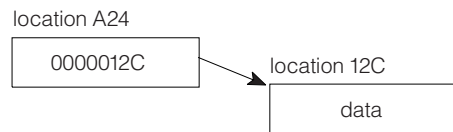

To refer to data when the address of the data is in general purpose register 2, specify 2R%. Graphically:

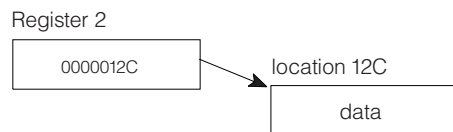

You can indicate as many levels of indirect addressing as necessary by following the initial indirect address with a corresponding number of percent signs or question marks. You can also include plus or minus displacement values. For instance, you can specify. 5R%%+4?. Graphically:

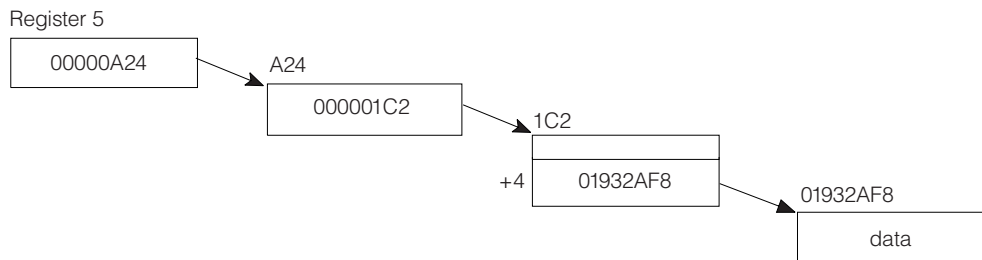

Shorthand method for specifying addresses: When specifying more than one address in a SLIP parameter, you can use a shorthand method to specify any address after the first. The first address is written out completely and defines the base. The base consists of everything in the first address **except the last displacement**. (If no displacement is specified, SLIP assumes a displacement of zero.) When you specify subsequent addresses, you can omit the base.

The following example shows two ways of specifying a range from 2R%+4 through 2R%+7. In the shorthand method, the base is 2R% and SLIP adds the base to the displacement you specify.

Regular Method

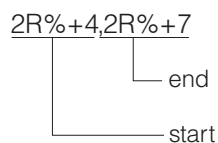

Shorthand Method

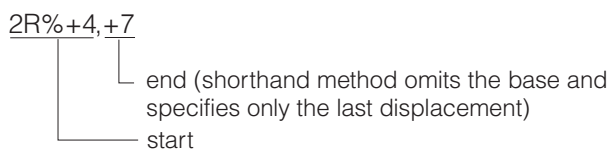

When you are using shorthand to specify an address range, make sure that the ending address is greater than the starting address. Because SLIP does not consider the base to include the last displacement, the displacement you specify for the ending address must be greater than the displacement you specify for the starting address.

For example, it **would be incorrect** to specify a range as 2R%+4,+3. An error condition exists because the ending address is less than the starting address.

Indirect Addressing with the DATA, REFBEFOR, and REFAFTER Parameters:

The following discussion applies to the DATA, REFBEFOR and REFAFTER parameters when you specify multiple targets and use base/displacement shorthand.

The first direct or indirect address is written out completely and establishes the base. Subsequent addresses are written as plus or minus displacements from the base. For example,

SLIP command

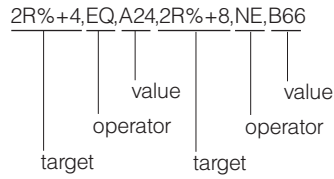

is written using shorthand form as

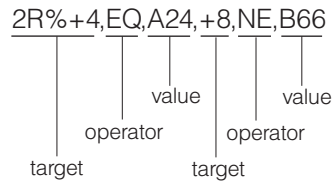

You must establish a direct or indirect base address before using displacements. In the following example, 2R specifies the contents of general purpose register 2, not an address. Therefore, the example using a +6 displacement is incorrect.

`2R,EQ,C12,+6,NE,D01`

Indirect addressing with the LIST, RANGE, SUMLIST and TRDATA

parameters: When indirect addressing is used with the LIST, SUMLIST, RANGE or TRDATA parameters, the indirect addresses point to the beginning and end of a field of data. The following example shows a starting and ending address:

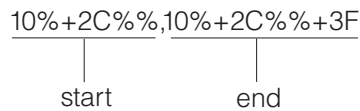

The same example in shorthand is:

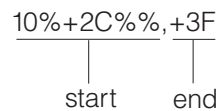

Graphically:

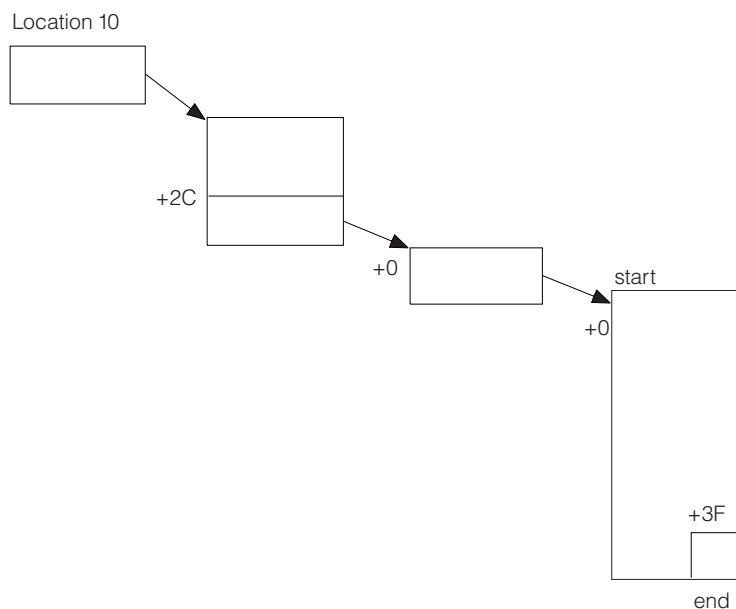

Qualifying direct or indirect addresses to address spaces: You can qualify direct or indirect addresses in the DATA, REFBEFOR, REFAFTER, LIST, RANGE, SUMLIST, and TRDATA parameters of the SLIP command. The qualifier can be the address space name or the job name of the job associated with the address space. If you omit an address space or job name qualifier, SLIP processing uses the current address space. The formats of the qualifiers are:

```
asid.addr
'jobname'.addr
```

asid

Is an explicit or symbolic address space qualifier. An explicit *asid* is a 1- to 4-digit hexadecimal ASID number. A symbolic *asid* is one of the following:

CURRENT or CU

Current address space

HASID or H

Home address space

I

Address space where the instruction executed

PASID or P

Primary address space

SA

SA stands for storage access. For storage alteration, it is the space being altered. For ZAD, it is the space of the zero-address operand.

SASID or S

Secondary address space

jobname

Is the job name that is associated with the address space. A *jobname* can be 1 to 8 alphanumeric and national (\$, #, @) characters and is enclosed in single quotation marks. You can specify wildcards in *jobname* with the following exception: an * must be a suffix and cannot appear alone.

See “Using wildcards in commands” on page 19. When a *jobname* with wildcards qualifies an address, the system selects one job, whose corresponding address space has the lowest address space identifier (ASID).

SLIP command

addr

Is either a direct address of 1 to 8 hexadecimal digits or an indirect address.

Example: To list 8 bytes of data from address space 3 and 32 bytes of data from the primary address space at the time of interrupt or error, enter:

```
LIST=(3.3FC210,3FC217,P.3R%,+1F)
```

Indirect addressing using a register: When you specify a register, SLIP normally uses the contents of the general purpose register to calculate an address. It uses the address space or data space associated with the related access register when all the following conditions are true:

- CURRENT is specified, or defaulted to
- The processor is in access register (AR) ASC mode
- The indirect address starts with a register indirection.

SLIP will continue to use that space until changed explicitly by a qualifier.

CURRENT can reset the space by negating the space previously found through an access register. The LIST value shown in the following example provides three storage ranges, in pairs. In AR ASC mode, the first two ranges are associated with access register 3. The third range is associated with location 8000 in the primary space.

When no register indirection is specified, SLIP will use the current address space.

```
LIST=(CU.3R%,+3,+6,+9,CU.8000,+4)
```

The LIST parameter value shown in the following example, also provides three storage ranges. In AR ASC mode the first range, 3R% to 4R%, is associated with the space indicated by access register 3. The second range, 5R% to 6R%, is also associated with the space indicated by access register 3.

The associated space changes only when the symbolic CURRENT is explicitly specified for the third pair, 7R% to 8R%. The symbolic CURRENT in this example changes the associated space to that indicated by access register 7.

```
LIST=(CU.3R%,4R%,5R%,6R%,CU.7R%,8R%)
```

You can use the BEAR symbolic to capture data about a wild branch as follows:

```
SLIP SET,C=0C1,DATA=(BEAR,EQ,nn),A=SVCD,E
```

In this example, if SLIP were entered to process an ABEND 0C1 and if the last successful branch occurred from *nn* (for example a possible branch to low storage from *nn*), an SVC dump is to be taken. The value of the BEAR symbolic is contained within SDWABEA in the dump.

You can use the BPER symbolic in conjunction with a dynamic PER trap where the range for an activated trap can be unknown.

```
SLIP SET,IF,LPAMOD=(MYMOD,60),A=TARGETID,TI=TRP2,ID=TRP1,E  
SLIP SET,SA,A=SVCD,RA=(1R?),DATA=(BPER?,EQ,00),ID=TRP2,E
```

In this example, these two traps constitute a dynamic PER activation chain. The author is interested in taking an SVC dump when the first byte of the storage buffer that register 1 points to at offset 60 into MYMOD becomes zero. Without the use of the symbolic, you can not reference the address of this buffer in the trap.

Setting a SLIP trap

The SLIP commands used to set SLIP traps are described in the following topics:

- “Structure of a SLIP SET command”
 - Events
 - Conditions
 - Actions
 - Types of SLIP SET Parameters
- “Setting effective SLIP PER traps” on page 813
 - Keeping PER Traps from Slowing System Performance
 - PSWs Disabled for PER
 - Ignored PER Traps
 - Recursive Traps
 - PER Monitoring and Checkpoint/Restart
 - Dynamic PER Traps
- “Syntax for an error event SLIP SET command” on page 822
- “Syntax for an instruction fetch or successful branch SLIP SET PER command” on page 823
- “Syntax for a storage alteration SLIP SET PER command” on page 824
- “Syntax for a zero address detection SLIP SET PER command” on page 825
- “Syntax for the ACTION parameters for the SLIP SET command” on page 826
- “SLIP SET parameters” on page 830

Structure of a SLIP SET command

In SLIP SET traps, you can indicate what kinds of **events** you want trapped and the system **conditions** for the trap, then specify what **action** the system is to take when the event occurs during the specified conditions.

Events: The kinds of events you can intercept are:

- **Error event:** This is also called a *non-PER* event. The trap is set by the command:
`SLIP SET[,options],END`
 The error events are:
 - An ABEND macro issued by a task
 - Dynamic address translation error
 - Software error caused by a machine check
 - Abnormal end of an address space
 - Paging I/O error
 - Program check interruption
 - Restart interruption
 - SVC error

Note: SLIP does not trap errors that are intercepted by SPIE or ESPIE routines.

- **Program event recording (PER) event:** The PER events are:
 - **Instruction fetch:** The trap is set by the command:
`SLIP SET,IF[,options],END`
 - **Successful branch:** The trap is set by the command:
`SLIP SET,SBT[,options],END`
 - **Storage access:** A storage access trap can be:

SLIP command

- A storage alteration trap set by one of these commands:
SET SET,SA[,options],END
SET SET,SAS[,options],END
- A zero address detection trap set by this command:
SET SET,ZAD[,options],END

Note:

1. The parameters IF, SA, SAS, SBT, and ZAD are positional. If you specify any one of them, it must directly follow a comma immediately after SLIP SET.
2. It is not possible to set a SLIP trap for the storage alteration of a hiperspace.

Conditions: The error and PER events you can trap are quite general, and you probably would not want to take an action each time such an event occurs. To narrow the scope of SLIP processing, you can qualify the event by requesting exactly what condition the system must be in when the error or PER event happens in order for the action to occur. The system checks each specified condition to see if it corresponds to the system condition at the time of the error or PER interruption.

The conditions you specify serve as filters to screen out those events in which you are not interested. A *match* for the trap occurs when the specified conditions are the same as the system conditions. A *no-match* occurs when the specified conditions are not the same as the system conditions. Only when all the conditions you specify match the system conditions will your action be taken.

Among the conditions you can specify are:

- The system mode at the time of the error or PER interruption
- A user or system completion code and reason code associated with an error
- The name of a job that must be in control at the time of the error or PER interruption
- The name of the job step program that must be in control at the time of the error or PER interruption
- The module name, entry point name, or address range where the error or PER interruption must occur
- The address space that must be in control at the time of the error or PER interruption
- The contents of specific storage locations and/or registers at the time of the error or PER interruption

If you omit a particular condition, the system does not check for that condition.

Actions: When one of these events occurs, you can take one of the following actions:

- Request an SVC dump tailored specifically to your needs
- Cause a system trace record to be written (PER only)
- Cause a generalized trace facility (GTF) trace record to be written
- Cause a logrec record to be written
- Put the system in a wait state
- Suppress system or problem program dumps (for error events only)
- Cause the recovery routines of the interrupted program to get control (PER only)
- Ignore the event
- Issue system commands

You can also request an additional action to be taken before or after the main action.

Types of SLIP SET parameters: SLIP SET parameters are in five functional groups: event, condition, action, trap control, and specialized.

Table 66. Summary of the SLIP SET parameters

Function:	Parameters:
Event parameters: Indicate the event to be monitored and trapped.	IF SAS SBT ZAD
Condition parameters: To narrow the scope of the trap, the condition parameters specify system conditions that qualify the event.	ADDRESS JOBNAME NUCMOD ASID JSPGM PSWASC ASIDSA LPAEP PVTEP COMP LPAMOD PVTMOD DATA MODE RANGE DSSA MSGID REASON ERRTYP NUCEP
Action parameters: These parameters specify what the system is to do when the trap matches.	IGNORE RECORD SUBTRAP NODUMP RECOVERY SVCD NOSUP REFAFTER SYNCVCD NOSVCD REFBEFOR TARGETID NOSYSA STDUMP TRACE NOSYSM STOPGTF TRDUMP NOSYSU STRACE WAIT CMD The following parameters are options to tailor the action that the system is to do. ASIDLST LIST SDATA TRDATA DSPNAME REMOTE STRLIST GTFID REFAFTER SUMLIST JOBLIST REFBEFOR TARGETID CMD DESC
Trap control parameters: These parameters control the operation of the trap.	DISABLE IDGROUP PRCNTLIM ENABLE MATCHLIM
Specialized parameters:	DEBUG ID RBLEVEL END OK

Setting effective SLIP PER traps

This topic describes where to place SLIP PER traps and how to keep SLIP PER traps from affecting system performance.

Notes:

1. Only one PER trap with an action other than IGNORE can be eligible for checking at any one time, *but also see "Multiple PER traps" on page 817.*
2. The SLIP PER support is designed not to disrupt processing, even though this means that a trap might fail to collect data or might not cause a requested action.

Performance considerations for designing a SLIP trap: An important consideration when designing a SLIP trap is its possible impact on system performance. SLIP traps designed to trap abends, messages, and other software events have a fairly small risk of system performance impact as long as the targeted software event is not occurring with high frequency. However, a SLIP trap that exploits the PER hardware by monitoring instruction fetch (IF), storage alteration (SA), or successful branch (SBT) hardware events does carry a risk. If a PER SLIP trap results in an impact to system performance, the reason is the design

SLIP command

of the trap itself. There are several considerations to take into account when designing a SLIP trap for both effectiveness and efficiency:

PRCNTLIM

SLIP offers a safety net for PER traps in the form of the PRCNTLIM (PL) parameter. This parameter defines the maximum percentage of system time that can be consumed by SLIP processing associated with PER interruptions and monitoring of cross-memory activity. If the percentage of system time consumed exceeds the specified limit, the PER trap is automatically disabled. The default for PRCNTLIM is 10%, although it can be set as low as 1%.

It is important to be aware that the protection offered by PRCNTLIM is enforced only when PER interrupts are occurring. This means that SLIP PRCNTLIM will not offer protection if a SLIP trap is enabled but inactive, or if the SLIP trap is enabled but there is no instruction execution or storage alteration within the targeted range.

Scope

You can control the scope of a SLIP trap in the following ways:

- **Range**

To avoid unnecessary PER interrupts, limit the range of the SLIP PER trap to as small an area as is practical for the event being trapped. The range of a SLIP PER trap is specified as follows:

- For instruction fetch or successful branch PER traps: RANGE, LPAMOD, LPAEP, NUCMOD, NUCEP, PVTMOD, or PVTEP parameters
- For storage alteration PER traps: RANGE parameter

Also be sensitive to the frequency with which instructions in the specified range will be executed. For more information about understanding and controlling the frequency of PER interrupts, see “Frequency of PER interrupts.”

- **Address spaces**

SLIP processing provides you with the power and flexibility to monitor PER events in one address space, in a set of address spaces, or even across every address space on the system. The more units of work that SLIP must monitor, the more system resource it is likely to require. Whenever practical, use the JOBNAME or ASID parameter to limit the scope of a SLIP trap. For more information about the use of these parameters, see “Special parameter considerations.”

- **Cross-memory environment**

The JOBNAME and ASID parameters, optionally combined with MODE=HOME, define the cross-memory environment to be monitored by a SLIP PER trap. Certain combinations of these parameters require additional SLIP processing in order to actively monitor cross-memory activity. This additional processing begins at the time that the SLIP PER trap is enabled, and it takes place regardless of whether PER interrupts are occurring. For example, even if a SLIP PER trap is inactive (meaning that the module being monitored for instruction fetch or successful branch has not been loaded yet), it is still possible for performance to be impacted by the SLIP monitoring of cross-memory events. Fortunately, there are guidelines for designing a PER SLIP trap to minimize the overhead caused by this monitoring. These guidelines are discussed under “Special parameter considerations.”

Frequency of PER interrupts

The ability to filter the conditions for which a SLIP trap is monitoring is one of the most powerful and effective features of SLIP. However, it is important to realize that SLIP processing increases instruction path length and, therefore, can cause performance impacts, even when the SLIP filters prevent the trap from matching. This is a concern especially when monitoring for a PER event to occur.

A PER trap may monitor an instruction that executes frequently, but be designed to match only when a register or data area holds a particular value. Alternatively, a PER trap may monitor an area of storage that is frequently altered, but only match when the alteration is to a specific value. On such traps, the instruction fetch or storage alteration event being monitored by the PER hardware may occur many times, only to be filtered out by the SLIP software as it processes the trap's other parameters. Although the trap is not matching, each PER interrupt represents a path through SLIP processing. For this reason, it is important to consider how frequently the hardware event that your PER trap is monitoring will occur.

Avoid monitoring instructions that are in performance paths or that are executed with a very high frequency. Avoid monitoring storage locations that are frequently updated. Avoid monitoring very large ranges unless you know that there will be a low volume of PER interrupts within that range. If such a situation is unavoidable, then strongly consider including a conservative PRCNTLIM on your PER trap to protect the system from potential impact.

SLIP offers an IGNORE capability which sometimes leads a SLIP user into a sense of false security. Consider the case where a SLIP is needed to monitor the entry and exit points of a module. Since only one SLIP PER range can be monitored on the system at a time, this scenario is typically handled by monitoring instruction fetch across the range of the module, then using a related SLIP trap to IGNORE all instructions between the entry point and the exit point. For example, consider the following SLIP traps:

```
SLIP SET,IF,NUCMOD=(MYCODE,0,100),A=TRACE,ID=SLP1,END
SLIP SET,IF,NUCMOD=(MYCODE,1,FF),A=IGNORE,ID=SLP2,END
```

The PER hardware will be set up to monitor instruction fetch over the entire range specified on SLP1, so a PER interrupt will occur for every instruction between offset +0 and +100 in module MYCODE. SLIP software, which receives control under the PER interrupt, will apply the SLP2 filters. If the software determines that the PER interrupt occurred within the range that is to be ignored, it will not take the action of TRACE indicated on SLP1. It is important to realize that even though the SLIP is taking action only on the first and last instructions of the range, every instruction in the range is being monitored by PER and when executed will trigger a PER interrupt to drive SLIP software. Therefore, coding A=IGNORE is a way to limit the volume of data produced by the SLIP trap to a subset of the targeted range, but it does not reduce the number of PER interrupts that occur and their potential for performance impact.

Special parameter considerations

The JOBNAME, ASID, and MODE parameters are designed to work together to allow control of the cross-memory environment for which a PER interrupt occurs. When designing a PER trap, it is important to be

SLIP command

aware of performance benefits and impacts that may result from various combinations of these parameters. Consider the following guidelines when designing a non-IGNORE PER trap:

- JOBNAME should be used whenever feasible. Specifying JOBNAME limits PER monitoring to only those work units dispatched under the specified job.
- JOBNAME and ASID are not identical in function. Whenever feasible, specify JOBNAME rather than ASID. Specifying ASID requires SLIP to monitor changes to the execution environment relative to the specified ASID. For example, SLIP will need to monitor for PC instructions that cause execution to switch into the specified ASID, and it will need to monitor for PR instructions that change the execution environment from the specified ASID to another ASID.
- Do not specify MODE=HOME unless your PER trap requires it, or unless using PVTMOD (discussed in the next point). When you specify MODE=HOME, additional SLIP processing is necessary to monitor changes to the cross-memory environment. If you must specify MODE=HOME, pair the parameter with either JOBNAME or ASID to limit the scope of the cross-memory monitoring required of SLIP.
- When using PVTMOD or PVTEP in an IF or SBT PER trap for a module that is not loaded with GLOBAL=YES, specify JOBNAME or ASID, **and** MODE=HOME, whenever possible. Failure to specify both parameters along with PVTMOD can lead to significant performance impact. More information about this impact is provided in the following discussion of parameter combinations.

There are some SLIP parameter combinations that have a significantly increased potential for system overhead. IBM strongly advises that you **avoid** these combinations:

- MODE=HOME with neither JOBNAME nor ASID specified
Specifying MODE=HOME indicates that the SLIP trap will only match when executing in the home address space. When MODE=HOME is specified, additional SLIP processing is required to monitor for the correct environment. When MODE=HOME is paired with the JOBNAME or ASID parameter, this monitoring is limited to processing associated with the specified address spaces. However, if MODE=HOME is specified without JOBNAME nor ASID, the additional monitoring required will affect processing in every address space on the system and could significantly impact system performance. Note that PRCNTLIM offers protection in this case, provided that PER interrupts are occurring.
- PVTMOD/PVTEP without JOBNAME/ASID and MODE=HOME
This consideration pertains to the PVTMOD and PVTEP parameters when specified in an IF or SBT PER trap for a module that was not loaded with GLOBAL=YES. PVTMOD and PVTEP are used for monitoring execution in modules that reside in private storage. Whenever possible, specify JOBNAME or ASID, and MODE=HOME, when you use PVTMOD or PVTEP in order to avoid performance impact due to PER interrupts occurring within the range of the specified private load module but in another address space. Using this parameter combination communicates the following information:
 - JOBNAME or ASID tells SLIP to match only when the PER interrupt occurs under the indicated job.
 - MODE=HOME tells SLIP to match only when the PER interrupt occurs while executing in the home (dispatched) address space.

- JOBNAME or ASID in combination with MODE=HOME tells SLIP to set the PER range only when the private module is loaded into storage in the specified address space. If this parameter combination is not specified, SLIP sets the PER range the first time the private module is loaded into storage, regardless of which address space performs the load.

There are times when coding JOBNAME or ASID along with MODE=HOME on a PVTMOD or PVTEP SLIP would make it too restrictive to trap the desired environment. Consider the case where the PER trap is intended to monitor a cross-memory environment where the module is loaded into private storage of an address space and then executed by a job with cross-memory access. Specifying MODE=HOME would be incorrect as it would prevent the SLIP trap from matching in such an environment. However, omitting the MODE=HOME parameter means that SLIP may potentially take additional PER interrupts and require additional processing in order to determine whether the PER interrupt occurred within the range of the specified private load module within the correct address space.

In cases where specifying MODE=HOME is too restrictive, try to at least specify JOBNAME or ASID. Remember to use a conservative PRCNTLIM if you are concerned about potential performance impact from your SLIP trap.

PSWs disabled for PER: Certain processing cannot tolerate PER interrupts. For that processing, the PSW PER bit is set off to prevent interrupts. PER is disabled in the new PSWs for:

- Program check
- Machine check
- Restart

PER remains disabled in such critical paths until processing reaches a point where a PER interrupt can be accepted.

Ignored PER traps: SLIP ignores — that is, does not process — PER events if:

- The PER interrupt occurred while DAT was off. SLIP PER support applies only to virtual addresses.
- The PER interrupt is redundant. See *Principles of Operation* for a description of redundant PER interrupts.
- The PER interrupt occurred, but an enabled non-IGNORE PER trap does not exist. SLIP does the following:
 - Ignores a PER interrupt caused by a non-SLIP tool that set up the PER control registers.
 - Turns off the PER bit in the resume PSW before returning to the first level interrupt handler (FLIH) for program checks. When the PER bit is off, the SLIP trap will not match.

Multiple PER traps: It is not necessary to set SLIP traps individually and run a failing job multiple times, using one trap for each execution until a dump is taken. You can set SLIP PER traps at multiple points in a load module as follows: use a non-IGNORE PER trap to monitor the range that encompasses all of the points in which you are interested, followed by several IGNORE PER traps to prevent the SLIP action from being taken on the intervening instructions in which you are not interested. For example:

SLIP command

```
SLIP SET,IF,DISABLE,ACTION=SYNCSVCD,LPAMOD=(load_module_name,58CA4,85440),ID=JW01,
      JOBNAME=jjjjjjjj,END
SLIP SET,IF,DISABLE,ACTION=IGNORE,LPAMOD=(load_module_name,58CA5,5C80B),ID=JW02,END
SLIP SET,IF,DISABLE,ACTION=IGNORE,LPAMOD=(load_module_name,5C80D,5D0B3),ID=JW03,END
SLIP SET,IF,DISABLE,ACTION=IGNORE,LPAMOD=(load_module_name,5D0B5,5DD9D),ID=JW04,END
SLIP SET,IF,DISABLE,ACTION=IGNORE,LPAMOD=(load_module_name,5DD9F,8543F),ID=JW05,END
SLIP MOD,EN,ID=JW0*
```

In the previous example, SLIP ID=JW01 would be set (disabled) first, followed immediately by SLIP IDs JW02, JW03, JW04, and JW05, all of which would also be set disabled. The final SLIP command (SL MOD,EN,ID=JW0*) would then enable all five of the SLIPs, but in reverse order, which is exactly what is required. Thus, the messages issued would be:

```
IEE727I SLIP TRAP ID=JW01 SET
IEE727I SLIP TRAP ID=JW02 SET
IEE727I SLIP TRAP ID=JW03 SET
IEE727I SLIP TRAP ID=JW04 SET
IEE727I SLIP TRAP ID=JW05 SET

IEE727I SLIP TRAP ID=JW05 ENABLED
IEE727I SLIP TRAP ID=JW04 ENABLED
IEE727I SLIP TRAP ID=JW03 ENABLED
IEE727I SLIP TRAP ID=JW02 ENABLED
IEE727I SLIP TRAP ID=JW01 ENABLED
```

When the failing job was then executed (only one execution would be necessary) a PER (hardware) interruption would be taken on the execution of every instruction in the specified range (58CA4,85440). At each of those interruptions, the software PER routines would gain control; they would run the chain of enabled SLIP traps to see if there were any IGNORE traps encompassing the specific address at which that particular interruption had occurred.

If the system *does* find an IGNORE trap, PER processing for that interruption would then be complete and control would return to the application program to continue executing. However, if the system *does not* find an IGNORE trap, it will take the action specified in the non-IGNORE trap (JW01). This is a dump at exactly the desired point, that is, at the instruction beginning at one of the locations 58CA4, 5C80C, 5D0B4, 5DD9E, or 85440.

For convenience you can enter all of these SLIP traps in an IEASLPxx member and then set (SET SLIP=xx) to that member. That way, if you've made an error in one of the SLIPs you need only correct that one error, add five SLIP DEL, ID=JWxx statements to the beginning of the IEASLPxx member, and then reset to that member. This process is easier than reentering every SLIP trap from the console. If you do this, the IEE727I message would be preceded by

```
SET SLIP=xx

IEE252I MEMBER IEASLPxx FOUND IN PARMLIB
```

and followed by

```
IEE536I SLIP VALUE xx NOW IN EFFECT
```

Recursive traps: Do not specify a recursive trap, that is, do not place a PER trap in a function and then specify an action that causes SLIP to use the function. Some system services that SLIP uses check for recursion and prevent it.

For example, suppose a SLIP trap is placed in generalized trace facility (GTF) entry code and the trap specifies ACTION=TRACE. When the trap matches, GTF does not write a trace record because of the recursive checks within GTF.

A similar situation exists with other trace actions, dump actions, and wait. In general, recursions result in the action not being taken. Avoid recursions by choosing an appropriate SLIP action.

PER monitoring and checkpoint/restart: Checkpoint/restart does not include support for SLIP PER monitoring. The effects of PER on restarting a checkpointed program follow:

- **No PER monitoring before checkpoint, no PER monitoring after restart:** A program is running in an address space not monitored for PER interrupts; the program is checkpointed. If the program is restarted in an address space monitored for PER interrupts, SLIP does not monitor the restarted program.
- **PER monitoring before checkpoint, no PER monitoring after restart:** A program is running in an address space monitored for PER interrupts; the program is checkpointed. If it is restarted in an address space not monitored for PER interrupts, but other address spaces are being monitored, unwanted PER interrupts may occur, depending on the PER control register settings.

If unwanted PER interrupts occur in the restarted program, SLIP disables the PSW PER bit in the restarted program. This action can eventually remove all performance problems because of the unwanted PER interrupts from the restarted program.

- **PER monitoring before checkpoint, no PER monitoring after restart:** A program is running in an address space monitored for PER interrupts; the program is checkpointed. If the program is restarted and PER monitoring is not active in the system, the system performance might slow down because the PSW PER bit is enabled in the restarted program.

Dynamic PER traps: TARGETID, along with indirect addressing on the RANGE parameter, allows you to activate a new PER trap dynamically once the previous trap has been deactivated as a result of MATCHLIM. In the next example, specifying TARGETID=TR2 on the first PER trap will cause the second PER trap, ID=TR2, to activate when the first trap deactivates. The address range of the second PER trap is determined by the contents of register 1 when the MATCHLIM occurs.

First PER trap:

```
SLIP SET,IF,RANGE=10000,TARGETID=TR2,ACTION=TARGETID,END
```

Second PER trap:

```
SLIP SET,SA,DISABLE,RANGE=1R?,ID=TR2,ACTION=SVCD,END
```

The second PER trap can specify a third trap and so on. There is no limit to the number of traps in a chain of dynamic traps, which is called a dynamic PER activation chain.

Each PER trap can be of any kind and have its own unique set of matching criteria or filters. However, PER traps will be active only for address spaces specified in the initial trap by the JOBNAME, ASID, and MODE=HOME parameters. Therefore IBM recommends that an ASID parameter specified in the initial trap must include all address spaces for the subsequent traps. For example, it makes sense to specify ASID=(1,2,3) on the initial trap and ASID=(1,2) on the second trap, but not the reverse, because no units of work would be monitored in ASID=3.

Rules for dynamic PER traps:

- TARGETID can be used with all PER traps except IGNORE.

SLIP command

- When TARGETID is one of the parameters, you must also specify it as one of the actions. Otherwise the TARGETID parameter will be ignored.
- Each of the PER traps can have its own independent action.
- When TARGETID is specified the default value for MATCHLIM is 1.
- The RANGE parameter on all PER traps support indirect addressing.
- A dynamic PER activation chain is defined when every TARGETID can be associated with some PER trap. SLIP does not allow the traps of the chain to be enabled unless the definition is complete.
 - A PER trap within a dynamic PER activation chain cannot target itself or a preceding trap in the chain. In other words, a dynamic PER activation chain cannot be a circular chain.
 - Members of the chain cannot be deleted. Any attempt to delete a member will result in message IEE408I being issued.
 - You can disable any trap in the chain in order to delete the chain. This can aid in tracking down the currently active trap.
- SLIP allows specification of NUCMOD or NUCEP, PVTMOD or PVTEP, and LPAMOD or LPAEP on the trap. However for PVTMOD or PVTEP, the cross memory lock (CML) of the primary address space that existed at the time of the PER interrupt must be immediately obtainable in order to search for the specified load module. If the CML is obtainable, the system will search for the specified private load module only in the primary address space. If the system does not find the specified load module, it puts the target trap into an enabled but inactive state.

SLIP zero address detection (ZAD): A Zero Address Detection (ZAD) event is a PER program interrupt caused by execution of an instruction that accesses (stores or fetches) storage using an operand address that was formed from a general register containing zero, when the PSW PER bit is on and Zero Address Detection is enabled. You enable Zero Address Detection by a SLIP PER trap of type ZAD. A ZAD trap can help to detect errors that involve unintentionally referencing the PSA. All instruction ranges are monitored for ZAD events; you can limit ZAD events only by limiting the address spaces and jobs for which PER is active. You can limit the ZAD events that match your SLIP traps by using other SLIP filtering keywords.

A SLIP PER ZAD trap must be used with caution. Due to normal system processing, many expected ZAD events in IBM modules can occur, which do not represent problems and are not defects. Due to these expected ZAD events, there can be noticeable system overhead when using a SLIP ZAD trap. More efficient use of ZAD events could be achieved on a test system rather than a production system, assuming the test system can tolerate higher system overhead from a SLIP trap.

To produce as few PER interrupts as possible, use the following methods:

- Use filtering keywords with a SLIP ZAD trap.
- Avoid unwanted matching of the SLIP ZAD trap.
- Limit the address spaces and jobs that SLIP monitors by using the ASID and JOBNAME keywords.

The following methods use filtering keywords to avoid unwanted matches:

- Limit the address range of the instruction that causes the ZAD interrupt, by using the ADDRESS, NUCMOD, LPAMOD/LPAEP or PVTMOD/PVTEP keywords.

- Limit the address ranges by using IGNORE ZAD traps that specify the ADDRESS keyword, so that matches occur only within your modules. For example, if you have two address ranges to monitor for ZAD events you could use IGNORE ZAD traps to filter out everything else. As a specific example, to monitor addresses 10000000-20000000 and 30000000-40000000, you could set IGNORE ZAD traps for addresses 0-FFFFFFF, 20000001-2FFFFFFF and 40000001-7FFFFFFF. The non-IGNORE trap only matches if the event occurs outside of the three IGNORE ranges, which in turn is within the two ranges that you are focusing on. When setting IGNORE traps, you must follow the documented protocol for setting them after setting the non-IGNORE trap, and enable the non-IGNORE trap only after the IGNORE traps are enabled.
- Use ASIDSA=SA to filter the expected ZAD events when page 0 of a data space is referenced using a base register with a 0 value, which would occur when using the ORIGIN returned by DSPSERV CREATE.
- Use other filtering keywords, such as DATA, when appropriate.

The following user actions are common responses to a ZAD slip trap match. For the first three actions, ensure that your filtering keywords only match events within your product code.

1. Taking an SVC Dump
2. Creating a GTF record
3. Creating a system trace record
4. Collecting data and getting a report of all ZAD events.

Even a properly limited trap can still collect many ZAD events. As with any PER trap, the PRCNTLIM keyword limits the amount of system processing that the trap can use. If that amount is exceeded, SLIP automatically disables the trap. If using the default or a lower PRCNTLIM value resulted in SLIP automatically disabling the trap, and your system can tolerate the additional overhead, you can try a higher PRCNTLIM value. If the SLIP still automatically disables the trap, then you cannot use a SLIP ZAD trap to monitor that particular event on that system.

When testing, look for ZAD events only within your own product code. If you see a ZAD event that is outside of your product code, and you do not suspect that it is an error, do not report it. If your product code only runs in a limited set of address spaces or jobs, you can limit the address spaces or jobs in which PER events can occur.

To use ZAD, you must be running z/OS on a z196, z114 or later server model. ZAD is not supported on z/OS under z/VM.

To collect data and get a report of all ZAD events, complete the following steps:

1. Set up a procedure named IEAVTSZR, as shown in Figure 36 on page 822.
2. START IEAVTSZR, which initializes an area to record the information.
3. Run SETPROG LPA,ADD,DSN=SYS1.LINKLIB,MOD=IEAVTSZE,FIXED.
Alternatively, you could use the FLPA system parameter with an IEAFIXxx parmlib member to complete this step during IPL.
4. Issue the following system command, which sets a SLIP trap named ZAD1:
SLIP SET,ZAD,A=AEXIT,AEXIT=IEAVTSZE,ID=ZAD1,PL=50,OK,END.
Although A=AEXIT and the AEXIT keyword are not otherwise documented, this specific use is permitted. You can change the PL value, use a different ID and add other SLIP filtering keywords prior to END when setting this SLIP trap.

SLIP command

5. Run your programs.
6. Run START IEAVTSZR. In this instance, the command writes a report for all ZAD events to SYSPRINT, and then resets to continue.
7. If necessary, run additional iterations of the running programs and the START IEAVTSZR command.
8. Run START IEAVTSZR,OP=FREE. You can skip this step if you are doing an IPL.

To the extent possible, the report identifies where the event occurred (by address and by module name, if available), how many times the event occurred, and the instruction that was issued. This facilitates locating the particular module and determining if the event is an error. If you find non-error events within your product code, you could modify the code to avoid reporting the non-error event. You could also add ASIDSA=SA to the SLIP trap to avoid hits for data space stores. The report flags data space stores with a "D", however, so they can be ignored.

You can add further modifiers to your SLIP trap to avoid reporting additional events, using LPAMOD, NUCMOD, ASID and ADDRESS, for example. The ZAD events will still occur, but SLIP will filter them out and the trap will not match.

The following code shows an example IEAVTSZR procedure:

```
//*****  
/** SIZE may be nK, nnK, nnnK, nM, nnM, nnnM. It is the amount of *  
/** fixed, common storage to be used for individual instruction *  
/** data. It is added to the amount needed to capture data for *  
/** every address space. *  
/** * *  
/** OP=FREE indicates that you're done *  
/** OP=DATA indicates *  
/** - Allocate if not yet allocated *  
/** - Produce a report based on the current data *  
/** - After producing a report, clear the data *  
/** Do not specify STATS. Leave it as YES *  
//*****  
//IEAVTSZR PROC SIZE=1M,OP=DATA,STATS=YES,SYSOUT=*  
//IEAVTSZR EXEC PGM=IEAVTSZR,TIME=1440,REGION=0M,  
// PARM='OP=&OP,SIZE=&SIZE,STATS=&STATS'  
//SYSPRINT DD SYSOUT=&SYSOUT
```

Figure 36. IEAVTSZR procedure example

Syntax for an error event SLIP SET command

The following considerations apply:

- Do not enter a SLIP trap that uses all the defaults (SLIP SET,END). The defaults (ENABLE, RBLEVEL=ERROR, ACTION=SVCD, and MATCHLIM=1) cause the system to issue message IEA412I and request an SVC dump for a non-error condition.
- If you specify only one *nodump* value on the ACTION parameter, you do not need to enclose it in parentheses.
- The COMP= and MSGID= keywords are mutually exclusive. Specifying both of them on the SLIP SET command will result in the error message IEE836D being issued.

SLIP SET

SLIP SET

```
[,ADDRESS=(start[,end]) ]
  [,LPAEP=(name[,start[,end]]) ]
  [,LPAMOD=(name[,start[,end]]) ]
  [,NUCEP=(name[,start[,end]]) ]
  [,NUCMOD=(name[,start[,end]]) ]
  [,PVTEP=(name[,start[,end]]) ]
  [,PVTMOD=(name[,start[,end]]) ]
[,ASID=(asid[,asid]...) ]
[,COMP=code[,REASON=code] ]
  [,MSGID=message-id ]
[,DATA=(comparison[,comparison]...) ]
[,TXIGD | NOTXIGD] ]
[,ERRTYP=(type[,type]...) ]
[,JOBNAME={userid | jobname} ]
[,JSPGM=name ]
[,MODE= (mode[,mode]...[,ANY | EVERY]) ]
[,PSWASC=(mode[,mode]...) ]
```

```
[,ACTION=[IGNORE[,option]] ]
  [(nodump[,nodump]...)[,option] ]
  [NOSUP[,option] ]
  [RECORD ]
  [SVCD[,options] ]
  [TRACE[,options] ]
  [TRDUMP[,options] ]
  [STOPGTF[,options] ]
  [WAIT[,options] ]
  [CMD[,options] ]
```

```
[,ENABLE | ,DISABLE]
```

```
[,IDGROUP=idgroup]
```

```
[,MATCHLIM=m ]
  [,MATCHLIM=1 for ACTION=SVCD or ACTION=SYNCSVCD
```

```
[,DEBUG]
```

```
[,ID=trapid]
```

```
[,OK]
```

```
[,RBLEVEL={ERROR | NOTSVRB | PREVIOUS}]
```

```
,END
```

Syntax for an instruction fetch or successful branch SLIP SET PER command

The following considerations apply:

- Only one PER trap with an action other than IGNORE can be eligible for checking at any one time.
- Except when ACTION=IGNORE is specified, one of the following parameters is required: LPAEP, LPAMOD, NUCEP, NUCMOD, PVTEP, PVTMOD, or RANGE. With ACTION=IGNORE, these parameters are optional.
- If you specify only one value in the ACTION parameter, you do not need to enclose it in parentheses.

```
SLIP SET,IF or SET,SBT
```

SLIP command

```
SLIP SET,{IF|SBT}

[,LPAEP=(name[,start[,end]]) ]
[,LPAMOD=(name[,start[,end]]) ]
[,NUCEP=(name[,start[,end]]) ]
[,NUCMOD=(name[,start[,end]]) ]
[,PVTEP=(name[,start[,end]]) ]
[,PVTMOD=(name[,start[,end]]) ]
[,RANGE=(start[,end]) ]

[,ASID=(asid[,asid]...)]

[,DATA=(comparison[,comparison]...)]
[,TXIGD | NOTXIGD ]

[,JOBNAME={userid | jobname}]

[,JSPGM=name]

[,MODE= (mode[,mode]...[,ANY | EVERY])]

[,PSWASC=(mode[,mode]...)]

[,ACTION=
  [(IGNORE[,RECOVERY])] ]
  [(RECOVERY[,REFAFTER] [,REFBEFOR] [,STOPGTF] [,TARGETID])[,options] ]
  [(STDUMP[,REFAFTER] [,REFBEFOR] [,STOPGTF] [,TARGETID])[,options] ]
  [(STRACE[,REFAFTER] [,REFBEFOR] [,STOPGTF] [,TARGETID])[,options] ]
  [(SVCD[,RECOVERY] [,REFAFTER] [,REFBEFOR] [,STOPGTF] [,TARGETID])[,options] ]
  [(SYNCSVCD[,REFAFTER] [,REFBEFOR] [,STOPGTF] [,TARGETID])[,options] ]
  [(STOPGTF[,REFAFTER] [,REFBEFOR] [,TARGETID])[,options] ]
  [(TRACE[,RECOVERY] [,REFAFTER] [,REFBEFOR] [,STOPGTF] [,TARGETID])[,options] ]
  [(TRDUMP[,RECOVERY] [,REFAFTER] [,REFBEFOR] [,STOPGTF] [,TARGETID])[,options] ]
  [(WAIT[,RECOVERY] [,REFAFTER] [,REFBEFOR] [,STOPGTF] [,TARGETID])[,options] ]
  [(CMD[,RECOVERY] [,REFAFTER] [,REFBEFOR] [,STOPGTF] [,TARGETID])[,options] ]

[,ENABLE | ,DISABLE]

[,IDGROUP=idgroup]

[,MATCHLIM=m ]
  [,MATCHLIM=1 for ACTION=SVCD or ACTION=SYNCSVCD
  [,MATCHLIM=50 for ACTION=STDUMP or ACTION=STRACE

[,PRCNTLIM=p | ,PRCNTLIM=10]

[,DEBUG]

[,ID=trapid]

[,OK]

,END
```

Syntax for a storage alteration SLIP SET PER command

Use the SLIP SET,SA command to set a PER storage alteration trap.

Use the SLIP SET,SAS command to set a PER storage alteration trap pertaining to the STURA assembler instruction. The command traps a store into the virtual address range as well as a store done by STURA. The trap can use other parameters to check changes to the virtual range.

The following considerations apply:

- Only one PER trap with an action other than IGNORE can be eligible for checking at any one time.
- Except when ACTION=IGNORE is specified, the RANGE parameter is required. With ACTION=IGNORE, RANGE must not be specified.
- If you specify only one value in the ACTION parameter, you do not need to enclose it in parentheses.

```

SLIP SET,{SA|SAS}
    [,ADDRESS=(start[,end])          ]
    [,LPAEP=(name[,start[,end]])]
    [,LPAMOD=(name[,start[,end]])]
    [,NUCEP=(name[,start[,end]])]
    [,NUCMOD=(name[,start[,end]])]
    [,PVTEP=(name[,start[,end]])]
    [,PVTMOD=(name[,start[,end]])]

    [,RANGE=(start[,end])]
    [,ASID=(asid[,asid]...)]
    [,ASIDSA=(asid | 'jobname'[,asid | 'jobname']...)]
    [,DATA=(comparison[,comparison]...)]
    [,DSSA=(asid.name | 'jobname'.name[,asid.name | 'jobname'.name]...)]
    [,JOBNAME={userid | jobname}]
    [,JSPGM=name]
    [,MODE=(mode[,mode]...[,ANY | EVERY])]
    [,PSWASC=(mode[,mode]...)]

    [,ACTION=
        [(IGNORE[,RECOVERY])] ]
        [(RECOVERY[,REFAFTER] [,REFBEFOR] [,STOPGTF] [,TARGETID])[,options] ]
        [(STDUMP[,REFAFTER] [,REFBEFOR] [,STOPGTF] [,TARGETID])[,options] ]
        [(STOPGTF[,REFAFTER] [,REFBEFOR] [,TARGETID])[,options] ]
        [(STRACE[,REFAFTER] [,REFBEFOR] [,STOPGTF] [,TARGETID])[,options] ]
        [(SVCD[,RECOVERY] [,REFAFTER] [,REFBEFOR] [,STOPGTF] [,TARGETID])[,options] ]
        [(SYNCSVCD[,REFAFTER] [,REFBEFOR] [,STOPGTF] [,TARGETID])[,options] ]
        [(TRACE[,RECOVERY] [,REFAFTER] [,REFBEFOR] [,STOPGTF] [,TARGETID])[,options] ]
        [(TRDUMP[,RECOVERY] [,REFAFTER] [,REFBEFOR] [,STOPGTF] [,TARGETID])[,options] ]
        [(WAIT[,RECOVERY] [,REFAFTER] [,REFBEFOR] [,STOPGTF] [,TARGETID])[,options] ]
        [(CMD[,RECOVERY] [,REFAFTER] [,REFBEFOR] [,STOPGTF] [,TARGETID])[,options] ]

    [,ENABLE | ,DISABLE]

    [,IDGROUP=idgroup]

    [,MATCHLIM=m ]
    [,MATCHLIM=1     for ACTION=SVCD or ACTION=SYNCSVCD
    [,MATCHLIM=50    for ACTION=STDUMP or ACTION=STRACE

    [,PRCNTLIM=p | ,PRCNTLIM=10]
    [,DEBUG]
    [,ID=trapid]
    [,OK]

,END

```

Syntax for a zero address detection SLIP SET PER command

Use the SLIP SET,ZAD command to set a PER zero address detection trap. For additional details, see “SLIP zero address detection (ZAD)” on page 820.

The following considerations apply:

SLIP command

- Only one PER trap with an action other than IGNORE can be eligible for checking at any one time.
- If you specify only one value in the ACTION parameter, you do not need to enclose it in parentheses.

There is no need to report to IBM service personnel the SLIP ZAD events that occur within IBM code. They are to be treated as expected and valid.

```
SLIP SET,ZAD

[,ADDRESS=(start[,end])          ]
[,LPAEP=(name[,start[,end]])]
[,LPAMOD=(name[,start[,end]])]
[,NUCEP=(name[,start[,end]])]
[,NUCMOD=(name[,start[,end]])]
[,PVTEP=(name[,start[,end]])]
[,PVTMOD=(name[,start[,end]])]

[,ASID=(asid[,asid]...)]
[,ASIDSA=(asid | 'jobname'[,asid | , 'jobname']...)]
[,DATA=(comparison[,comparison]...)]
[,DSSA=(asid.name | 'jobname'.name[,asid.name | , 'jobname'.name]...)]
[,JOBNAME={userid | jobname}]
[,JSPGM=name]
[,MODE= (mode[,mode]...[,ANY | EVERY])]
[,PSWASC=(mode[,mode]...)]
[,ACTION=
  [(IGNORE[,RECOVERY])]
  [(RECOVERY[,REFAFTER] [,REFBEFOR] [,STOPGTF] [,TARGETID])[,options] ]
  [(STDUMP[,REFAFTER] [,REFBEFOR] [,STOPGTF] [,TARGETID])[,options] ]
  [(STOPGTF[,REFAFTER] [,REFBEFOR] [,TARGETID])[,options] ]
  [(STRACE[,REFAFTER] [,REFBEFOR] [,STOPGTF] [,TARGETID])[,options] ]
  [(SVCD[,RECOVERY] [,REFAFTER] [,REFBEFOR] [,STOPGTF] [,TARGETID])[,options] ]
  [(SYNCSVCD[,REFAFTER] [,REFBEFOR] [,STOPGTF] [,TARGETID])[,options] ]
  [(TRACE[,RECOVERY] [,REFAFTER] [,REFBEFOR] [,STOPGTF] [,TARGETID])[,options] ]
  [(TRDUMP[,RECOVERY] [,REFAFTER] [,REFBEFOR] [,STOPGTF] [,TARGETID])[,options] ]
  [(WAIT[,RECOVERY] [,REFAFTER] [,REFBEFOR] [,STOPGTF] [,TARGETID])[,options] ]
  [(CMD[,RECOVERY] [,REFAFTER] [,REFBEFOR] [,STOPGTF] [,TARGETID])[,options] ]
[,ENABLE | ,DISABLE]
[,IDGROUP=idgroup]
[,MATCHLIM=m ]
  [,MATCHLIM=1      for ACTION=SVCD or ACTION=SYNCSVCD
  [,MATCHLIM=50    for ACTION=STDUMP or ACTION=STRACE]
[,PRCNTLIM=p | ,PRCNTLIM=10]
[,DEBUG]
[,ID=trapid]
[,OK]
,END
```

Syntax for the ACTION parameters for the SLIP SET command

ACTION for SLIP SET:

```
ACTION=CMD[,options]
ACTION=(CMD[,RECOVERY] [,REFAFTER] [,REFBEFOR] [,STOPGTF] [,TARGETID])[,options]
```

Where the *options* are:

```
CMD='MVS COMMAND'
COMMAND='MVS COMMAND'
CMD=('MVS COMMAND')
CMD=('MVS COMMAND','MVS COMMAND')
CMD=('MVS COMMAND','MVS ','COMMAND')
```

ACTION=IGNORE[,option]
 ACTION=(IGNORE[,RECOVERY])

Where *option* is:

[,RECORD]

ACTION=(nodump[,nodump]...)[,option]

Where *nodump* is:

NODUMP
 NOSVCD
 NOSYSA
 NOSYSM
 NOSYSU

Where *option* is:

[,RECORD]

ACTION=NOSUP[,option]

Where *option* is:

[,RECORD]

ACTION=RECORD

ACTION=RECOVERY

ACTION=(RECOVERY[,REFAFTER][,REFBEFOR][,TARGETID])[,options]

Where the *options* are:

[,REFAFTER=(*triplet* [, *triplet*]...)]

[,REFBEFOR=(*triplet* [, *triplet*]...)]

[,TARGETID=(*trapid*)]

ACTION=REFAFTER,REFAFTER=(*triplet* [, *triplet*]...)

ACTION=REFBEFOR,REFBEFOR=(*triplet* [, *triplet*]...)

ACTION=STDUMP[,options]

ACTION=(STDUMP[,REFAFTER][,REFBEFOR][,STOPGTF][,TARGETID])[,options]

Where the *options* are:

[,ASIDLST=(*asid* [, *asid*]...)]

[,DSPNAME=(*asid.name* | '*jobname*'.*name* [, *asid.name* | '*jobname*'.*name*]...)]

[,DESC='description']

[,LIST=(*start*,*end* [, *start*,*end*]...)]

[,REFAFTER=(*triplet* [, *triplet*]...)]

[,REFBEFOR=(*triplet* [, *triplet*]...)]

[,SDATA=(*area* [, *area*]...)]

[,SDATA=(NOALLPSA, NOALLSQA, NOSUM, TRT)]

[,SUMLIST=(*start*,*end* [, *start*,*end*]...)]

[,TARGETID=(*trapid*)]

ACTION=STOPGTF

ACTION=STRACE

ACTION=(STRACE[,REFAFTER][,REFBEFOR][,STOPGTF][,TARGETID])[,options]

Where the *options* are:

[,REFAFTER=(*triplet* [, *triplet*]...)]

SLIP command

```
[,REFBEFOR=(triplet [, triplet]...)]  
[,TARGETID=(trapid)]  
[,STDATA=(start,end [, start,end]...)]
```

```
ACTION=SVCD [,options]  
ACTION=(SVCD [,RECOVERY] [,REFAFTER] [,REFBEFOR] [,STOPGTF] [,TARGETID]) [,options]
```

Where the *options* are:

```
[,ASIDLST=(asid [, asid]...)]  
[,DESC='description']  
[,DSPNAME=(asid.name | 'jobname'.name [, asid.name | 'jobname'.name]...)]  
[,JOBLIST=(jobname [, jobname]...)]  
[,LIST=(start,end [, start,end]...)]  
[,RECORD]  
[,REFAFTER=(triplet [, triplet]...)]  
[,REFBEFOR=(triplet [, triplet]...)]  
[,REMOTE= { (UNCOND | COND, remote) } ]  
            { (UNCOND | COND, (remote) [, (remote)]... ) }  
            { (remote) }  
            { ((remote) [, (remote)]... ) }  
[,SDATA=(area [, area]...)]  
    [,SDATA=(ALLPSA, CSA, HCSABYASID, HCSANoOwner, HCSASysOwner, LPA, NUC, RGN, SQA, SUM, TRT) ]  
[,STRLIST=(s-option [, s-option]... ) ]  
[,SUMLIST=(start,end [, start,end]...)]  
[,TARGETID=(trapid)]
```

Where *remote* in the REMOTE parameter is:

```
[,SYSLIST=(sysname,group.member,group.*, (start),...)]  
[,ACTION=SVCD | WAIT]  
[,ASIDLST=(asid [, asid]...)]  
[,DSPNAME=(asid.name | 'jobname'.name [, asid.name | 'jobname'.name]...)]  
[,JOBLIST=(jobname [, jobname]...)]  
[,LIST=(start,end [, start,end]...)]  
[,SDATA=(area [, area]...)]  
[,STRLIST=(s-option [, s-option]... ) ]
```

Where *s-option* in the STRLIST parameter is:

```
STRNAME=strname  
[,CONNAME=conname]  
[,ACCESSTIME={ENFORCE | NOLIMIT}]  
[,LOCKENTRIES]  
[,USERCNTLS]  
[,EVENTQS]  
[,EMCONTROLS={ALL | (list)}]  
[,({COCLASS | STGCLASS | LISTNUM})={ALL | (list)}]  
{ [,ADJUNCT={CAPTURE|DIRECTIO}] [,ENTRYDATA={UNSERIALIZE|SERIALIZE}] }  
{ [,SUMMARY] }
```

```
ACTION=SYNCSVCD [,options]  
ACTION=(SYNCSVCD [,REFAFTER] [,REFBEFOR] [,STOPGTF] [,TARGETID]) [,options]
```

Where the *options* are:

```
[,ASIDLST=(asid [, asid]...)]  
[,DSPNAME=(asid.name | 'jobname'.name [, asid.name | 'jobname'.name]...)]  
[,DESC='description']  
[,LIST=(start,end [, start,end]...)]
```

```
[,REFAFTER=(triplet[,triplet]...)]
[,REFBEFOR=(triplet[,triplet]...)]
[,REMOTE= { (UNCOND | COND,remote)
            { (UNCOND | COND,(remote) [,(remote)]...)}
            { (remote)
            { ((remote) [,(remote)]...)}
            ]
[,SDATA=(area[,area]...)]
[,SDATA=(ALLPSA,CSA,LPA,NUC,RGN,SQA,SUM,TRT)
[,STRLIST=(s-option[,s-option]... )
[,SUMLIST=(start,end[,start,end]...)]
[,TARGETID=(trapid)
```

Where *remote* in the REMOTE parameter is:

```
[,SYSLIST=(sysname,group.member,group.*,(start),...)]
[,ACTION=SVCD | WAIT
[,ASIDLST=(asid[,asid]...)]
[,DSPNAME=(asid.name | 'jobname'.name [,asid.name | 'jobname'.name]...)]
[,JOBLIST=(jobname[,jobname]...)]
[,LIST=(start,end[,start,end]...)]
[,SDATA=(area[,area]...)]
[,STRLIST=(s-option[,s-option]... )
```

Where *s-option* in the STRLIST parameter is:

```
STRNAME=strname
[,CONNAME=conname]
[,ACCESSTIME={ENFORCE | NOLIMIT}}
[,LOCKENTRIES]
[,USERCNTLS]
[,EVENTQS]
[, (EMCONTROLS={ALL | (list)})]
[, ({COCLASS | STGCLASS | LISTNUM)={ALL | (list)}}]
[, {ADJUNCT={CAPTURE|DIRECTIO}} [,ENTRYDATA={UNSERIALIZE|SERIALIZE}}]
{ [,SUMMARY] }
```

```
ACTION=TARGETID,TARGETID=(trapid)
```

```
ACTION=TRACE[,options]
```

```
ACTION=(TRACE[RECOVERY] [,REFAFTER] [,REFBEFOR] [,STOPGTF] [,TARGETID]) [,options]
```

Where the *options* are:

```
[,RECORD]
[,REFAFTER=(triplet[,triplet]...)]
[,REFBEFOR=(triplet[,triplet]...)]
[,TARGETID=(trapid)
[,TRDATA=({STD[REGS] [,list]})
           {REGS[list]
           {list
           }
```

```
ACTION=TRDUMP[,options]
```

```
ACTION=(TRDUMP[RECOVERY] [,REFAFTER] [,REFBEFOR] [,STOPGTF] [,TARGETID]) [,options]
```

Where the *options* are:

```
[,ASIDLST=(asid[,asid]...)]
[,DSPNAME=(asid.name | 'jobname'.name [,asid.name | 'jobname'.name]...)]
[,DESC='description']
[,LIST=(start,end[,start,end]...)]
[,RECORD]
[,REFAFTER=(triplet[,triplet]...)]
```

SLIP command

```
[,REFBEFOR=(triplet [, triplet]...)]  
[,SDATA=(area [, area]...)]  
[,SDATA=(NOALLPSA,NOALLSQA,NOSUM,TRT)  
[,STRLIST=(s-option [, s-option]... ) ]  
[,SUMLIST=(start,end [, start,end]...)]  
[,TARGETID=(trapid)]  
[,TRDATA={({STD [, REGS] [, list]})}  
          {REGS [, list] }  
          {list }  
          }
```

Where *s-option* in the STRLIST parameter is:

```
STRNAME=strname  
[,CONNAME=conname]  
[,ACCESSTIME={ENFORCE | NOLIMIT}]  
[,LOCKENTRIES]  
[,USERCNTLS]  
[,EVENTQS]  
[, (EMCONTROLS={ALL | (list)})]  
[, ({COCLASS | STGCLASS | LISTNUM)={ALL | (list)}]  
  { [, ADJUNCT={CAPTURE | DIRECTIO}] [, ENTRYDATA={UNSERIALIZE | SERIALIZE}] }  
  { [, SUMMARY] }  
  }
```

```
ACTION=WAIT [, options]  
ACTION=(WAIT [, RECOVERY] [, REFAFTER] [, REFBEFOR] [, STOPGTF] [, TARGETID] [, options]
```

Where the *options* are:

```
[,DESC='description']  
[,RECORD]  
[,REFAFTER=(triplet [, triplet]...)]  
[,REFBEFOR=(triplet [, triplet]...)]  
[,REMOTE= { (UNCOND | COND, remote) } ]  
           { (UNCOND | COND, (remote) [, (remote)]... ) }  
           { (remote) }  
           { ((remote) [, (remote)]... ) }  
[,TARGETID=(trapid)]
```

Where *remote* in the REMOTE parameter is:

```
[,SYSLIST=(sysname,group.member,group.*, (start),...)]  
[,ACTION=SVCD | WAIT]  
[,ASIDLST=(asid [, asid]...)]  
[,DSPNAME=(asid.name | 'jobname'.name [, asid.name | , 'jobname'.name]...)]  
[,JOBLIST=(jobname [, jobname]...)]  
[,LIST=(start,end [, start,end]...)]  
[,SDATA=(area [, area]...)]  
[,STRLIST=(s-option [, s-option]... ) ]
```

Where *s-option* in the STRLIST parameter is:

```
STRNAME=strname  
[,CONNAME=conname]  
[,ACCESSTIME={ENFORCE | NOLIMIT}]  
[,LOCKENTRIES]  
[,USERCNTLS]  
[,EVENTQS]  
[, (EMCONTROLS={ALL | (list)})]  
[, ({COCLASS | STGCLASS | LISTNUM)={ALL | (list)}]  
  { [, ADJUNCT={CAPTURE | DIRECTIO}] [, ENTRYDATA={UNSERIALIZE | SERIALIZE}] }  
  { [, SUMMARY] }  
  }
```

SLIP SET parameters

The parameters are presented alphabetically.

ACTION=*value*

ACTION=(value[,value]...)

Specifies what you want the system to do when the trap matches system conditions. The *value* is:

- IGNORE
- *nodump*, which is NODUMP, NOSVCD, NOSYSA, NOSYSM, and/or NOSYSU
- NOSUP
- RECORD
- RECOVERY
- REFAFTER
- REFBEFOR
- STOPGTF
- STDUMP
- STRACE
- SUBTRAP
- SVCD
- SYNCVCD
- TARGETID
- TRACE
- TRDUMP
- WAIT
- CMD

If you omit the ACTION parameter, the default is ACTION=SVCD. If you specify more than one value, enclose the values in parentheses and separate them by commas.

Abbreviation: A**ACTION=CMD**

When the trap matches for an error or PER event, issue the MVS system commands entered on the CMD= parameter.

This action is valid with any other action, except for WAIT and IGNORE. This action is not allowed as a REMOTE option. Consider using the ROUTE command in the command text to target commands to other systems.

ACTION=IGNORE

When the trap matches for an error or PER event, requests that the system resume normal processing.

You can use IGNORE in a narrowly defined trap to exclude a subset of events from being trapped by a more general trap. For PER traps, the IGNORE trap must be the same type (IF, SA, SAS, SBT, or ZAD) as the more general trap or it will not be tested. For IF and SBT PER traps, use IGNORE traps to simulate multiple ranges for monitoring.

An IGNORE trap does not prevent PER interrupts from occurring in the range specified in the IGNORE trap; consider this fact when you set a percent time limit (PRCNTLIM) for a more general IF or SBT PER trap.

Use MATCHLIM on an IGNORE trap to ignore a specified number of events before SLIP takes the action on an associated non-IGNORE trap.

SLIP command

Note: If a recovery routine requests a dump, ACTION=IGNORE on a SLIP trap matching the error event will not suppress the dump. Specify NODUMP to suppress the dump.

Example:

```
ACTION=IGNORE
```

ACTION=nodump

ACTION=(nodump[,nodump]...)

When the trap matches for an error event, suppresses any dumps for the error requested by the system or a program.

This ACTION value is not valid for a PER trap.

The *nodump* is one of the following. If you specify only one value, omit the parentheses.

NODUMP

Suppresses SVC, SYSABEND, SYSUDUMP, or SYSMDUMP dumps requested while the system processes the error. NODUMP is useful for preventing dumps that may not be needed because accompanying messages provide all the needed problem data.

Note: NODUMP may not be effective for abend codes of 13E, 222, 33E, and 922.

NOSVCD

Suppresses all SVC dumps requested while the system processes the error.

NOSYSA

Suppresses all SYSABEND dumps requested while the system processes the error.

NOSYSM

Suppresses all SYSMDUMP dumps requested while the system processes the error.

NOSYSU

Suppresses all SYSUDUMP dumps requested while the system processes the error.

Example:

```
ACTION=(NOSYSA,NOSYSM)
```

When you specify ACTION=NODUMP, make sure the SLIP trap is specific. If your SLIP trap is too general, you might suppress dumps needed for other problems. For example, if you specify only a system completion code, all dumps for that code are suppressed. However, if you specify both a completion code and a job name, other jobs that abend with that completion code still produce dumps. The following example shows a specific SLIP definition with a completion code and job name:

```
SLIP SET,ACTION=NODUMP,COMP=806,JOBNAME=D10AXH1A,END
```

If a second error occurs during system processing for an event with ACTION=NODUMP specified, any dump requested for the second error is also suppressed. You can determine if a second error has occurred by checking both the job output messages and the logrec output. If either contains more than one abend, a second error occurred. If you need a dump for the second error, disable the SLIP trap that specifies ACTION=NODUMP and rerun the failing job.

ACTION=NOSUP

When the trap matches for an error event, prevents suppression by dump analysis and elimination (DAE) of any dumps requested for the error by the system or a program.

This ACTION value is not valid for a PER trap.

Example:

```
ACTION=NOSUP
```

ACTION=RECORD

When the trap matches for an error event, forces logrec data set recordings for every recovery routine, regardless of what the recovery routine specifies.

This ACTION value is not valid for a PER trap.

You can specify RECORD as the only ACTION value or as an option of the ACTION parameter in an error event trap. RECORD is not valid for a PER trap.

Example: To force a logrec recording for a X'0C6' abend by function recovery routines (FRRs) and ESTAE routines, enter:

```
SLIP SET,C=0C6,ACTION=RECORD,END
```

ACTION=RECOVERY

Initiates recovery processing for the interrupted process when the trap matches for a PER event. Any other action you specify is done before the recovery processing begins. Recovery processing initially causes the system to issue an X'06F' abend, but the recovery routines might change the abend code.

This ACTION value is not valid for an error event trap.

You can specify RECOVERY as the only ACTION value or with an ACTION value of IGNORE, SVCD, TRACE, TRDUMP, or WAIT in a PER trap.

Use the RECOVERY value carefully to avoid unexpected results. Before using RECOVERY, familiarize yourself thoroughly with the MVS recovery principles. In particular, ensure that recovery procedures have been established at the point where you are forcing recovery processing, and know what the recovery routines will do under the circumstances in which you are forcing recovery processing. See *z/OS MVS Programming: Authorized Assembler Services Guide* for more information about recovery processing.

ACTION=REFAFTER**ACTION=REFBEFOR**

When the trap matches for a PER event, refreshes the contents of storage locations or registers.

This ACTION value is not valid for an error event trap or when the action is IGNORE.

When another action value is specified, REFAFTER or REFBEFOR specifies the time when SLIP performs the refresh. For example:

- ACTION=(SVCD,REFAFTER) causes the refresh to occur after the dump has been requested.
- ACTION=(SVCD,REFBEFOR) causes the refresh to occur before the dump is requested.

When you specify REFAFTER or REFBEFOR as an ACTION value, you must also specify the REFAFTER or REFBEFOR parameter as an option.

ACTION=STDUMP

Writes a SLIP system trace record when the trap matches for a PER event, and

SLIP command

schedules an SVC dump when the trap is disabled or deleted. This SVC dump includes the registers and PSW for the current task.

This ACTION value is not valid for an error event trap. The ACTION=STDUMP parameter overrides DAE suppression.

Consider the following in selecting parameters to appear with ACTION=STDUMP:

- The following parameters require less SLIP processing to find a matching trap for an IF or SBT trap:
 - ASIDLST
 - ENABLE/DISABLE
 - END
 - ID
 - LIST
 - LPAEP/LPAMOD/NUCEP/NUCMOD/RANGE
 - MATCHLIM
 - SDATA
 - SUMLIST
- The following parameters require less SLIP processing to find a matching trap for an SA or SAS trap:
 - ASIDLST
 - ENABLE/DISABLE
 - END
 - ID
 - LIST
 - MATCHLIM
 - RANGE
 - SDATA
 - SUMLIST
- If you use parameters other than these with ACTION=STDUMP, SLIP processing uses more system resources.
- The default match limit for STDUMP is 50 when the only parameters specified are those listed here. Otherwise there is no default.
- Use the DESC parameter to give the resulting dump a unique title.

ACTION=STRACE

When the trap matches for a PER event, writes at least one SLIP system trace record.

This ACTION value is not valid for an error event trap.

Considerations in selecting parameters to appear with ACTION=STRACE are:

- The following parameters require less SLIP processing to find a matching trap for an IF or SBT trap:
 - ENABLE/DISABLE
 - END
 - ID
 - LPAEP/LPAMOD/NUCEP/NUCMOD/RANGE
 - MATCHLIM

- The following parameters require less SLIP processing to find a matching trap for an SA or SAS trap:
 - ENABLE/DISABLE
 - END
 - ID
 - MATCHLIM
 - RANGE
- If you use parameters other than these with ACTION=STDUMP, SLIP processing uses more system resources.
- If the STDATA keyword is omitted, no variable data will be recorded in the system trace record.
- The default match limit for STRACE is 50 when the only parameters specified are those listed here. Otherwise there is no default.

ACTION=STOPGTF

Turns off GTF tracing when the SLIP trap becomes disabled (or deleted). This can happen either by operator command (for example the SLIP MOD or SLIP DEL command) or when the MATCHLIM or PRCNTLIM parameters on the SLIP command take effect. Using STOPGTF helps prevent the trace buffer from wrapping once the trap matches.

You can use STOPGTF with the GTFID, TRACE, and TRDUMP keywords. For example, if you specify ACTION=(STOPGTF,TRACE), SLIP produces GTF trace records until the trap becomes disabled.

You can use ACTION=STOPGTF with IDGROUP=idgroup to stop GTF in a sysplex. When a trap is disabled on reaching the MATCHLIM or PRCNTLIM for the trap, the identical traps on the other systems will be disabled and thus the GTF tracing for the trap in the sysplex is turned off too.

ACTION=SUBTRAP

When the trap matches for a PER event, allows the SLIP user to request different sets of actions depending upon system conditions at the time of the PER interrupt.

You can use the SUBTRAP action much the same way as the IGNORE action, except that most other actions are permissible on the trap. The SUBTRAP action imposes no default MATCHLIM value, but other specified ACTION keywords can impose one.

This ACTION value is not valid for an error event trap and when the action is TARGETID.

Example:

```
ACTION=SUBTRAP
```

ACTION=SVCD

When the trap matches for an error or PER event, schedules an SVC dump for the current or failing address space and issues an SPER system trace record to record exactly when the match occurred. For more information about SVC dumps, see the SVC dump chapter of *z/OS MVS Diagnosis: Tools and Service Aids*.

The SVCD value overrides DAE suppression but does not override suppression specified in a CHNGDUMP NODUMP operator command. If the dump cannot be written, perhaps because another SVC dump is in progress, SLIP issues message IEA412I, continues processing, and does not reschedule the dump.

SLIP command

The ASIDLST, DSPNAME, JOBLIST, LIST, SDATA, and SUMLIST parameters specify the data to be included in the dump. The SVC dump the system schedules includes the registers and PSW for the current or failing task.

If you omit an ASIDLST parameter, the dump includes the following address spaces. Note that the home address space is the space of the issuer of the CALLRTM TYPE=MEMTERM macro.

- RTM1: Failing address space, which is identified in SDWAFMID, or the home address space
- RTM2: Failing address space, which is identified in RTM2FMID, or the home address space
- MEMTERM: Master address space for the scheduled dump and the home address space for the summary dump.
- PER: Home address space
- REMOTE: For a dump on a remote system as requested by the REMOTE parameter, the XCF address space (XCFAS)

If dumping of a failing address space fails, that is, the SDUMP macro returns a nonzero return code, SLIP schedules a dump in the home address space but puts no problem data in the SDUMP 4K SQA buffer. If the second dump fails, SLIP issues message IEA412I.

Use the DESC parameter to give the resulting dump a unique title.

Attention: Avoid using a general trap, such as, SLIP SET,COMP=0C4,ACTION=SVCD,END. The system normally has many expected program interrupts, each resulting in a 0C4 completion code.

SLIP has a default match limit of 1 on all traps that specify, or default to, ACTION=SVCD. The match limit can be changed by the MATCHLIM parameter when setting the SLIP trap. You can further qualify the SLIP trap by using other parameters, such as DATA and PVTMOD. These additional parameters prevent unwanted matches.

Example:

```
ACTION=SVCD,SDATA=(SQA,PSA,SUM)
```

ACTION=SYNCSVCD

When the trap matches for a PER event, schedules a synchronous SVC dump (SYNCSVCD) for the current or failing address space and issues an SPER system trace record to record exactly when the match occurred. The SYNCSVCD parameter overrides DAE suppression.

This ACTION value is not valid for an error event trap.

The ASIDLST, DSPNAME, JOBLIST, LIST, SDATA, and SUMLIST parameters indicate the data to be included in the dump. The SVC dump the system schedules includes the registers and PSW for the current or failing task.

SLIP will stop the unit of work before starting the dump to ensure that the restart occurs after the dump has completed. SLIP stops the work only when all of the following conditions exist when the PER interrupt occurs:

- The system is enabled and unlocked
- The system is in task mode

Because the PER interrupt occurs on completion of the instruction, an instruction type such as SVC will cause the system not to meet the previously stated criteria. If the system is disabled or locked when the PER interrupt occurs, a regular SVC dump will be taken instead.

SLIP has a default match limit of 1 on all traps that specify, or default to, ACTION=SYNCSVCD. You can change the match limit by the MATCHLIM parameter when setting the SLIP trap. You can further qualify the SLIP trap by using other parameters, such as DATA and PVTMOD. These additional parameters prevent unwanted matches.

Use the DESC parameter to give the resulting dump a unique title.

Examples:

```
ACTION=SYNCSVCD
ACTION=SYNCSVCD,SDATA=(SQA,PSA,SUM)
```

ACTION=TARGETID

When the trap matches for a PER event, specifies that another PER trap is to be activated once the trap specified in this SLIP command has been deactivated as a result of MATCHLIM.

This ACTION value is not valid for an error event trap or when the action is IGNORE.

When you specify TARGETID as an ACTION value, you must also specify the TARGETID parameter as an option.

The default match limit for ACTION=TARGETID is 1.

ACTION=TRACE

When the trap matches for an error or PER event, writes at least one generalized trace facility (GTF) SLIP trace record. Use a TRDATA parameter to specify the type and content of the GTF SLIP trace record.

For the record to be built and recorded, GTF with the SLIP option must be active. Be sure to stop GTF after the SLIP trap completes.

ACTION=TRACE can record small or large amounts of data. It is useful when you need a small amount of data each time a trap matches, such as when checking the path through a module.

Two problems can cause fields to be unavailable:

- The system uses the registers at the time of the event to resolve indirect addresses specified for trace record fields. If circumstances cause the registers to be unavailable, indirect addresses using a register value cannot be resolved, and related fields cannot be collected.
- The field is paged out or one of the pointers to the field is paged out.

If using indirect addresses, specify the REGS option of TRDATA to see the general purpose registers and the access registers used to resolve the addresses.

Example:

```
ACTION=TRACE
```

ACTION=TRDUMP

When the trap matches for an error or PER event, writes at least one generalized trace facility (GTF) SLIP trace record and, when the trap is disabled or deleted, schedules an SVC dump.

For the record to be built and recorded, GTF with the SLIP option must be active. Be sure to stop GTF after the SLIP trap completes.

The ASIDLST, DSPNAME, LIST, SDATA, and SUMLIST parameters are used to tailor the dump and TRDATA is used to tailor the trace records. The SVC dump the system schedules includes the registers and PSW for the current or failing task.

SLIP command

The ACTION=TRDUMP parameter overrides DAE dump suppression.

Use the DESC parameter to give the resulting dump a unique title.

Example:

```
ACTION=TRDUMP, TRDATA=(STD,REGS),SDATA=(TRT,SQA)
```

ACTION=WAIT

When the trap matches for an error or PER event, issues an SPER system trace record to record exactly when the match occurred and displays the following information in message IEE844W and places the system in a wait:

- SLIP identifier
- Type of trap and related information:
 - RTM1: The address of the system diagnostic work area (SDWA)
 - RTM2: The address of the RTM2 work area (RTM2WA)
 - MEMTERM: The address of the address space control block (ASCB)
 - PER: The address and code of PER
- PSW at the time of error event or PER interruption
- Control registers 3 and 4 contents, which indicate the primary (PASID) and secondary (SASID) address spaces
- Contents of general registers 0 to 15

When SLIP processes an ACTION=WAIT trap, it also places information in an area pointed to by PSA location X'40C'. On a z/Architecture[®] system, a 7th word at offset X'18' is added to that information. The 7th word contains the address of a 64-byte area that contains the high halves (bits 0–31) of the 64-bit GPRs in order GPR0 to GPR15. The second word, at offset X'04', contains the address of a 64-byte area that contains the low halves (bits 32–63) of the 64-bit GPRs in order GPR0 to GPR15.

The system instructs you to restart the system when you are finished looking at the message. The system restarts unless you did something during the wait to prevent a restart. Generating a stand-alone dump, for example, prevents a restart.

If the system cannot display the message, for example, because the console is unavailable, the system enters a restartable wait state (code 01B). You can then restart the system, if a restart is possible, depending on your actions during the wait.

Use the DESC parameter to describe the resulting wait state for the operator.

Note: If the SLIP command is entered from a TSO terminal in OPERATOR mode, the system does not accept this parameter.

Example:

```
ACTION=WAIT
```

ADDRESS=start

ADDRESS=(start[,end])

For a storage access (storage alteration or zero address detection), PER trap specifies the virtual address or range of addresses that must contain the instruction that causes the storage alteration.

For an error event trap, specifies the virtual address or range of addresses in which the error must occur. The RBLEVEL parameter controls the PSW address

that is used to decide if ADDRESS matches, for an enabled, unlocked, task mode error that is matched against an error event trap.

Each address is 1 to 16 hexadecimal digits. The starting address must be less than or equal to the ending address.

ADDRESS is not valid for an instruction fetch (SLIP SET,IF) or successful branch (SLIP SET,SBT) PER trap.

Abbreviation: AD

Example:

ADDRESS=(CD300,CD400)

ASID=*asid*

ASID=(*asid*[,*asid*]...)

For an error event or PER trap, specifies the address space identifier (ASID) for the primary address space that is in control when the error event or PER interruption occurs.

Each *asid* is 1 to 4 hexadecimal digits. You can specify one to 16 ASIDs. If you specify one ASID, you can omit the parentheses.

For PER traps with an action of IGNORE, you can limit the address spaces being monitored by the following:

- ASID parameter
- JOBNAME parameter
- MODE=HOME parameter

If you omit all of these parameters, PER monitoring is active in all address spaces and may cause performance problems.

If you omit MODE=HOME, PER monitoring will be active only for the address space(s) specified by the ASID parameter for the job specified by the JOBNAME parameter. If you omit MODE=HOME and ASID but specify JOBNAME, PER monitoring will be active for any address space(s) in which the job runs.

The ASID parameter is useful when monitoring storage alteration of an address range that falls in the private area.

Note: For PER traps that do not specify ACTION=IGNORE and for which the ASIDs to be monitored are known, but for which no extra PER interrupts will occur if all ASIDs are monitored, it is best not to specify the ASID parameter or MODE=HOME.

Abbreviation: AS

Example 1:

ASID=(1,7,1A)

Example 2: Consider the case of a unit of work belonging to JOB ABC (ASID 100), a PC to ASID 200, and then an abend of ABEND0C6. Therefore, at the time of the ABEND0C6, the job name is ABC, the home ASID is 100, and the primary ASID is 200.

Note: The home address is the space where a unit of work starts. The primary address space is the space where a unit of work is presently executing and fetching instructions. When a program does a space switching PC, this causes the unit of work's primary address space to change. However, its home address space never changes.

SLIP command

SLIP SET,C=0C6,JOBNAME=ABC

This example will trap this ABEND0C6 because at the time of the error JOBNAME=ABC.

SLIP SET,C=0C6,ASID=200

This example will trap this ABEND0C6 because at the time of the error the primary ASID=200.

SLIP SET,C=0C6,ASID=100

This example will not trap this ABEND0C6 because at the time of the error the primary ASID=200.

If you specify both ASID and JOBNAME, both filters must match the execution environment in order for the SLIP to match.

ASIDLST=asid

ASIDLST=(asid[,asid]...)

As an option of an ACTION or REMOTE parameter, specifies the address space or spaces to dump.

The *asid* is 1 to 4 hexadecimal digits or a symbolic ASID. You can specify one to 15 ASIDs. If you specify only one ASID, you can omit the parentheses. The symbolic values are:

CURRENT or CU

Current address space.

HASID or H

Home address space.

I Address space where the instruction ran.

LLOC Address space that is locked.

PASID or P

Primary address space.

SA SA stands for storage access.

- For an SA trap, it is the current alteration space used by an SA trap. If the alteration space is a data space, the data space will be dumped.
- For a ZAD trap, it is the current zero address detection space used by a ZAD trap. If the zero address detection space is a data space, the data space will be dumped.

SASID or S

Secondary address space.

Note: Zero indicates the current address space.

Abbreviation: AL

Example:

ASIDLST=(0,C)

ASIDSA=asid

ASIDSA='jobname'

ASIDSA=(asid | 'jobname'[, asid |,'jobname']...)

For a storage access trap, specifies up to 16 address spaces to be monitored. If neither ASIDSA nor DSSA is specified, the trap applies to all storage access events in all address spaces, data spaces, and hiperspaces in the address range in the RANGE parameter.

A storage access trap can be either a storage alteration (SLIP SET,SA or SAS) trap, or a zero address detection (SLIP SET,ZAD) trap.

ASIDSA eliminates data spaces and hiperspaces from being monitored and restricts the trap to one or more address spaces or jobs. You can specify an address space name in two forms:

- *asid*
- '*jobname*'

asid

Specifies the address space identifier (ASID) of an address space to be monitored. The *asid* can be an explicit hexadecimal ASID or a symbolic ASID. The symbolic values are:

CURRENT or CU

Current address space.

HASID or H

Home address space.

I

Address space where the instruction executed.

PASID or P

Primary address space.

SA

SA stands for storage access. For storage alteration, it is the space being altered. For ZAD, it is the space of the zero-address operand. It must be an address space.

SASID or S

Secondary address space.

jobname

Specifies the job name associated with an address space that is being altered. The *jobname* is 1 to 8 alphanumeric and national characters (\$, #, @) and is enclosed in single quotation marks. You can specify wildcards in the *jobname* with the following exception: an * must be a suffix and cannot appear alone. See "Using wildcards in commands" on page 19.

Abbreviation: ASA

Examples:

Example 1: When the PER2 hardware feature is present and the address space is known explicitly (not symbolically), it is particularly beneficial to specify ASIDSA.

```
ASIDSA=(5,3A,17B,24E,'JOB1','JOB*')
```

Example 2: A storage alteration of the word at common location 600 in the prefix storage area (PSA) results in a trap for which SLIP performs match processing. Because ASIDSA=SA is specified, SLIP will not check for a match for a storage alteration event that occurs in either a data space or a hiperspace.

```
RANGE=(600,603),ASIDSA=SA
```

```
CMD='MVS COMMAND'
COMMAND='MVS COMMAND'
CMD=('MVS COMMAND')
CMD=('MVS COMMAND','MVS COMMAND')
CMD=('MVS COMMAND','MVS ','COMMAND'))
```

CMD is a required parameter when ACTION=CMD is specified. It contains the console commands to issue when the SLIP error event or PER trap is hit.

SLIP command

Up to 8 commands can be entered, The first parentheses allows more than one command to be entered.

Commands can be broken into parts with a second set of parenthesis.

Commands can be up to 126 characters long. Because most consoles restrict the number of characters entered on a console to less than this, you will have to use SET SLIP=xx to enter longer commands.

If a desired command has a single quotation character (') in it, enter two single quotation characters (") into the slip command input. SLIP will issue the command with a single quotation character in place of the two single quotation characters. The extra single quotation character will not count against the 126 character limit.

In order for commands to be issued, the user entering an enabled SLIP with ACTION=CMD or the user enabling a disabled SLIP that was previously created with ACTION=CMD must have the authority to issue the entered commands.

Under the cover SLIP performs the MGCRC service and passes relevant console information to allow consoles to check for authorization.

There is no guarantee on the order of the completion of the commands.

If multiple matches in close time proximity occur for a single ACTION=CMD slip trap, there is no guarantee that commands will be issued for each match. However, SLIP will issue the commands at least once.

IBM strongly recommends using MATCHLIM or PRCNTLIM when using A=CMD with other actions that do not enforce MATCHLIM. There is no default MATCHLIM for A=CMD. If the commands specified can cause the trap to be hit again, the sequence could recursively continue indefinitely. This can have a serious impact on system performance.

Examples:

Example 1:

```
SLIP SET,C=071,SDATA=(ALLNUC,SQA,CSA,LPA,LSQA,ALLPSA,RGN,SUM,
    TRT),REASON=20,ID=SS71,CMD=('command 1',(command 2 part 1,',
    'command 2 part 2'),('command 3 part 1',
    'command 3 part 2',
    'command 3 part 3')),A=(SVCD,CMD),END
```

Example 2: USER1 has authority for the SLIP command but not the CHNGDUMP command, and enters:

```
SLIP SET,ID=UAC1,MSGID=IEE852I,DISABLE,ACTION=(CMD),
    CMD=('CHNGDUMP SET,SDUMP=(HCSABYASID,HCSY)'),END
```

USER2 has authority for the SLIP and CHNGDUMP command and enters:

```
SLIP MOD,ID=UCA1,ENABLE
```

When IEE852I is seen, the CHNGDUMP command is executed (as USER2 has authority to issue CHNGDUMP)

```
IEA992I SLIP TRAP ID=UA1A MATCHED. JOBNAME=*MASTER*,
ASID=0001.CHNGDUMP SET,SDUMP=(HCSABYASID,HCSY)
IEE712I CHNGDUMP PROCESSING COMPLETE
```

IF USER1 enabled UCA1, then when IEE852I is seen, the CHNGDUMP command would not be issued

```
IEA992I SLIP TRAP ID=UAC1 MATCHED.
JOBNAME/ASID NOT AVAILABLE.
IEE345I CHNGDUMP AUTHORITY INVALID,
FAILED BY SECURITY PRODUCT
```

COMP=code

For an error event trap, specifies a system or user completion code that is associated with the error.

For a system completion code, the form is *hhh*, three hexadecimal digits. You can indicate a set of codes by substituting *x*'s for one or more of the digits. For example, *x23* means 123, 223, 323, 423, and so forth. You can use an *x* in any position.

For a user completion code, the form is *Udddd*, where *U* indicates a user code followed by four decimal numbers. Use an *x* for any of the numbers to specify a set of codes. For example, *U102x* means U1021, U1022, U1023, and so forth.

Note:

1. The SLIP action is not taken when the abend completion code is originally a program check (code 0C4) that the system converts to a new value. The following abend completion codes may be originally a program check and converted ones: 11A, 12E, 15D, 15F, 200, 212, 25F, 279, 282, 42A, 430, 57D, 700, 72A, A00, B00, and E00. Note that the SLIP action is taken when the abend is not converted, even for these completion codes. For example, the action is taken for SLIP C=15F,RE=190,A=.
2. For abend completion codes 201, 202, 402, 6FC and 702, the SLIP action might not be taken. In certain paths, each of these codes is originally a program check, as described in Note 1. In other paths, the abend is issued directly. To cover fully such a case, you should set, for example, one SLIP trap specifying COMP=201 and another specifying COMP=0C4 or ERRTP=PROG.
3. SLIP cannot trap the 922 and 13E abend codes used to purge subtasks.
4. If any completion code is changed by a recovery routine with the SETRP macro, specify the original completion code in the SLIP command. For example, if a code of 800 was originally a code of 171, specify a code of 171 on the COMP parameter.
5. Avoid setting a general trap, such as:

```
SLIP SET,COMP=0C4,ACTION=SVCD,END
```

The system normally has many expected program interrupts, each resulting in a 0C4 completion code.

Abbreviation: C**Example:**

```
COMP=U123x,REASON=8
```

DATA=(comparison)**DATA=(comparison[,comparison]...)**

For an error event or PER trap, specifies logical comparison of a target location to a value. The *comparisons* represents a triplet or group of triplets, where each **triplet** consists of a target, operator, and value, as follows:

SLIP command

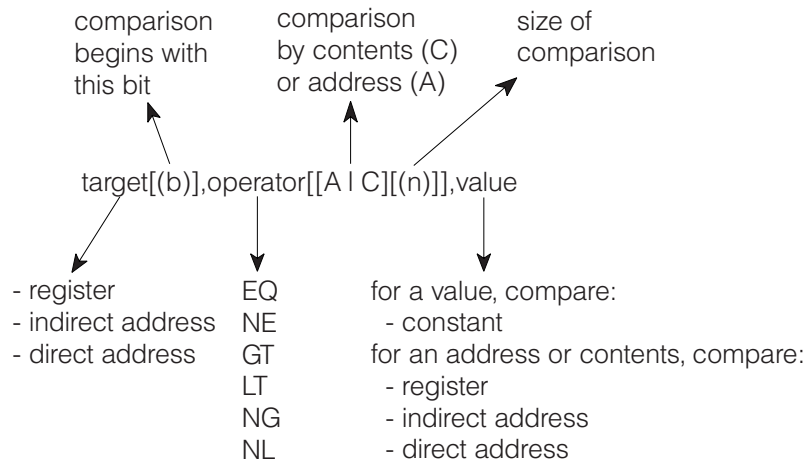

You can specify any number of DATA triplets. You can use AND (&) and OR (|) to logically combine the DATA triplets. Use parentheses to group and order your comparisons. You can specify any number of parentheses, up to a nested depth of 16 parentheses. Some rules for coding the DATA parameter are:

- Either a comma or a parenthesis must precede and follow each AND and OR.
- The symbols & and | do not need to be preceded and followed by a comma or a parenthesis. The commas and parentheses are optional.
- If two DATA triplets are separated by only a comma (without a parenthesis on either side of the comma), AND is the default for the logical comparison. This is the only default on the DATA parameter.

The parts of a triplet are:

target

Specifies the address of a storage location or a general purpose register (GPR) whose contents SLIP compares against the value supplied. The target can be:

- A direct address of 1 to 16 hexadecimal digits using the G suffix, or 1 to 8 hexadecimal digits using the R suffix. (See “Qualifying direct or indirect addresses to address spaces” on page 809.)
- A GPR in the form xG or xR where x is 0 – 15.
- An indirect address (see “Indirect Addresses” on page 805)

If SLIP cannot establish addressability to the target location, SLIP issues message IEA413I and increments the counter for the trap.

b – binary compare

If specified, *b* modifies the target address by indicating the bit position where a binary comparison is to start. For 64-bit registers, *b* can be 0 – 63. The starting bit position plus the bit size for 64-bit register comparison must not exceed 63. For 31-bit registers, *b* can be 0 – 31. The starting bit position plus the bit size for 31-bit register comparison must not exceed 31.

operator

Specifies the relationship that must exist between the contents of the target location and the value for the comparison to be successful.

- EQ – equal
- NE – not equal
- GT – target greater than value

- LT – target less than value
- NG – target not greater than value
- NL – target not less than value

If you do not include either *C* or *A* with the operator, SLIP does a *value compare*. In a value compare, SLIP compares the contents of the target address to the specified value.

C – contents compare

SLIP processing is to compare the contents of the address specified as the target with the contents of the address specified as the value.

A – address compare

SLIP processing is to compare the contents of the address specified as the target with the address specified as the value. Do not request a binary compare with an address compare. For example, (1R(0),EQA,2R%) is not a valid combination of binary compare (1R(0)) and address compare (EQA). In a 4-byte compare, bit 0 is ignored; bits 1 - 31 are compared.

- n* The number of bytes or bits that SLIP processing is to compare for a contents or address compare. When you request a binary compare, the range is 1 to 8 bits, with the default being one bit. Otherwise, the range is 1 to 4 bytes with the default being 4 bytes.

Note: When SLIP does either a contents compare or an address compare, it looks at the first *n* bytes of storage, but the last *n* bytes of a register.

value

Specifies the value to which the contents of the target are to be compared.

If you omit *A* or *C* as part of the operator, the value can be a constant, with the length determining the number of bytes or bits SLIP processing compares with the target.

If *b* is specified, the value is binary digits. If *b* is not specified, the value is hexadecimal digits. For example, 5R,EQ,01 is hexadecimal; 5R(0),EQ,01 is binary.

For binary comparisons, the length of the value establishes the length of the comparison. The maximum length for a binary comparison is 8 bits. The binary comparison can cross a byte boundary but not a register boundary.

For hexadecimal comparisons when the target is not a register, the length of the value establishes the length of the comparison. The maximum length of the comparison is 8 bytes. The value can be 1 - 16 hexadecimal digits. For example, A24,EQ,3CA79 compares two and a half bytes of data starting at location A24.

For hexadecimal comparisons when the target is a register in the form xR, the length of the comparison is 4 bytes, and the value is right-justified. For example, 2R,EQ,4 and 2R,EQ,00000004 are equivalent.

For hexadecimal comparisons when the target is a register in the form xG, the length of the comparison is 8 bytes, and the value is right-justified. For example, 2G,EQ,4 and 2G,EQ,00000000_00000004 are equivalent.

Underscores ('_') may be used at any point within the hexadecimal specification to make entering 64-bit data easier. Underscores are ignored during processing and do not count towards the limit on the number of hexadecimal digits.

SLIP command

If you specify A or C as part of the operator, the value can be:

- A direct address of 1 to 16 hexadecimal digits
- A GPR in the form xG or xR where x is 0 - 15
- An indirect address

Abbreviation: DA

Examples: Examples of DATA parameters follow.

Example 1:

The following expression is true if general purpose register 2 contains either 0 or 4:

```
DATA=(2R,EQ,0,OR,2R,EQ,4)
where 2R is the target (general purpose register 2)
      EQ is the operator (equal)
      0 and 4 are the values in hexadecimal
```

Example 2:

The following expression groups triplets for SLIP to evaluate.

```
DATA=(3R,EQ,8,AND(4R,EQ,0,OR(4R,EQ,4,AND,5R,NE,0)OR,4R,EQ,8))
```

Example 3:

The following expression is true if the contents of register 1 are the same as the address that is 6 bytes beyond the location that register 3 is pointing to:

```
DATA=(1R,EQA(4),3R?+6)
```

Note that SLIP compares bits 1 - 31 of register 1 to the address that is 6 bytes beyond the location to which register 3 is pointing.

Example 4:

The following expression is true if the contents of register 1 is the same as the contents of register 2:

```
DATA=(1R,EQC,2R)
```

Example 5:

The following expression is true if the contents of register 1 is the same as the contents at location 224:

```
DATA=(1R,EQC,224)
```

Example 6:

The following expression is true if the contents of register 1 is 224.

```
DATA=(1R,EQ,224)
```

Example 7:

The following expression is true if the first two bytes at the location pointed to by register 1 are equal to the first two bytes at the location determined by adding 150 to the contents of the word at location X'10'.

```
DATA=(1R?,EQC(2),10?+150)
```

Example 8:

The following expression is true if the first two bits at the location pointed to by register 1 are equal to the first two bits at the location determined by adding X'150' to the contents of the word at location 10.

```
DATA=(1R?(0),EQC(2),10?+150)
```

Example 9:

The following expression is true if the last 3 bytes (bits 8 — 31) of the address in register 1 are the same as the address that is 4 bytes beyond the location that register 3 is pointing to:

```
DATA=(1R,EQA(3),3R?+4)
```

Example 10:

The following expression is true if the last 3 bytes of register 1 are the same as the first 3 bytes at the location pointed to by register 2:

```
DATA=(1R,EQC(3),2R?)
```

Example 11:

The following expression is true if the 64-bit contents of GPR 11 equal the hexadecimal value X'0123456799999999':

```
DATA=(11G,EQ,01234567_99999999)
```

TXIGD**NOTXIGD**

Transactional Execution Ignore Data. Specifies that if there is a DATA filter, the filter is not to be applied if the event occurred during transactional execution.

DEBUG

For a SLIP SET trap, allows you to determine why a trap that you set is not working as you expected by indicating which of the conditions you established is not being met. DEBUG provides trap information each time the trap is tested rather than just when it matches.

The generalized trace facility (GTF) and its trace option for SLIP records must be active. Each DEBUG trace record contains SLIP information plus two bytes: the first byte contains a value indicating the failing parameter and the second byte contains zero.

For a description of the DEBUG values, see the SLIP debug trace record for GTF in *z/OS MVS Diagnosis: Tools and Service Aids*.

Example:

```
DEBUG
```

DESC='dump or wait state description'

An optional parameter of the STDUMP, SVCD, SYNCVCD, TRDUMP, and WAIT actions, DESC allows the issuer to add text to the dump title or wait state description text.

The text can be from 1 to 65 characters.

DISABLE

For a SLIP SET trap, indicates that the trap set is to be initially inactive, that is, ineligible for checking. If DISABLE is omitted, ENABLE is the default.

SLIP command

Abbreviation: D

Example:

DISABLE

DSPNAME=*asid.name*

DSPNAME='*jobname*'.*name*

DSPNAME=(*asid.name* | '*jobname*'.*name* [, *asid.name* | '*jobname*'.*name*]...)

As an option of an ACTION or REMOTE parameter, specifies the data space or spaces to be included in an SVC dump.

Specify from 1 to 15 data space names in the parameter. When you specify more than one name, enclose the data space names in parentheses and separate them by commas. When you specify only one name, you can omit the parentheses. You can specify a data space name in two forms:

- *asid.name*
- '*jobname*'.*name*

asid

Specifies the address space identifier (ASID) of the address space related to a data space to be monitored. The *asid* can be an explicit hexadecimal ASID or a symbolic ASID. The symbolic values are:

CURRENT or CU

Current address space.

HASID or H

Home address space.

HOME

Home address space.

I

Address space where the instruction executed.

LLOC

Address space that is locked.

PASID or P

Primary address space.

SA

SA stands for storage access. For storage alteration, it is the space being altered. For ZAD, it is the space of the zero-address operand.

SASID or S

Secondary address space.

jobname

The name of the job associated with the data space. The *jobname* is 1 to 8 alphanumeric and national (\$, #, @) characters and must be enclosed in single quotation marks. You can specify *jobname* in a DSPNAME parameter:

- With ACTION=SVCD
- On the REMOTE parameter for an ACTION=SVCD trap

You can specify wildcards in the *jobname*. See "Using wildcards in commands" on page 19.

name

Specifies the 1 to 8 character *name* associated with the data space at its creation. You can specify wildcards in the *name* on the DSPNAME option. See "Using wildcards in commands" on page 19.

The *name* must be specified, unless the trap event is SA. For an SA trap event, the data space of the storage being altered is dumped.

When the interrupted unit of work holds a lock higher than the RSM lock, the system cannot determine the specific data spaces. In this case, no data spaces are included in the dump.

Abbreviation: DN

Examples:

```
DSPNAME=(0006.SDUMPCSA)
DSPNAME=('*'.SPD*,'*ABC*'.S?P?,0012.SPD20)
```

DSSA=*asid.name*

DSSA='*jobname*'.*name*

DSSA=(*asid.name* | '*jobname*'.*name* [, *asid.name* | '*jobname*'.*name*]...)

For a storage access trap, specifies one or more data spaces to be monitored.

A storage access trap can be a storage alteration (SLIP SET,SA or SAS) trap, or a zero address detection (SLIP SET,ZAD) trap.

You can specify 1 to 16 data space names. You can specify a data space name in two forms:

- *asid.name*
- '*jobname*'.*name*

asid

Specifies the address space identifier (ASID) of the address space related to a data space to be monitored. The *asid* can be an explicit hexadecimal ASID or a symbolic ASID. The symbolic values are:

CURRENT or CU

Current address space.

HASID or H

Home address space.

I

Address space where the instruction executed.

PASID or P

Primary address space.

SA

SA stands for storage access. For storage alteration, it is the space being altered. For ZAD, it is the space of the zero-address operand.

SASID or S

Secondary address space.

jobname

The name of the job associated with the data space. The *jobname* is 1 to 8 alphanumeric and national (\$, #, @) characters and must be enclosed in single quotation marks. You can specify wildcards in the *jobname* with the following exception: an * must be a suffix and cannot appear alone. See "Using wildcards in commands" on page 19.

name

Specifies the 1 to 8 character *name* associated with the data space at its creation.

Note:

1. When SA is specified with *name*, the storage alternation must occur in the named data space for the trap to match.
2. When *name* is not specified, the trap will match on a storage alternation into any data space owned by the specified address space.

SLIP command

3. When SA is specified without *name* and the storage alternation is in an address space, no match will result for that address space.
4. When the PER2 hardware feature is present and you can specify the data space explicitly (not symbolically), it is particularly beneficial to specify DSSA.

Example:

```
DSSA=(ASID.DSPACE1,I.DSPACE2)
```

ENABLE

For a SLIP SET trap, indicates that the trap defined is to be initially active, that is, eligible for checking. If DISABLE is omitted, ENABLE is the default.

Abbreviation: EN

Example:

```
ENABLE
```

END

For a SLIP SET trap, marks the end of the SLIP SET command. If you omit this parameter, the system prompts you for additional parameters.

Abbreviation: E

ERRTYP=type

ERRTYP=(type[,type]...)

For an error event trap, specifies one or more error events, which satisfy the match test. If you specify ALL or more than one error type, the occurrence of any one of them satisfies the match test. If you omit ERRTYP, the omission has the same effect as specifying ERRTYP=ALL,

The *type* is one of the following:

ABEND

An ABEND macro issued by a task

ALL All of the error conditions

DAT Dynamic address translation error

MACH

Software error caused by a machine check

MEMTERM

Abnormal end of an address space

PGIO Paging I/O error

PROG Program check interruption

REST Restart interruption

Note: The system intercepts restart interruptions only when both of the following conditions are true:

- The operator initiated the restart.
- The operator requested that the system abnormally end a program running on the restarted processor.

SVCERR

SVC error caused by issuing an SVC instruction while locked, disabled, or in SRB mode

TXPROG

SLIP trap matches only on a transactional execution event.

Abbreviation: ER

Example:

```
ERRTYP=(MACH,DAT)
```

GTFID=*id*

GTFID=(*id*[,*id*]. . .)

For a SLIP SET trap, specifies a GTF identifier (GFTID) to selectively stop a subset of GTF tracing. The *id* is 1 to 8 characters. You can specify one to a maximum of 15 IDs.

You must use the GTFID parameter in conjunction with ACTION=STOPGTF. When the SLIP trap matches, the GTF instances associated with the specified IDs are stopped. If you do not specify GTFID, the default is that all GTF instances are stopped.

Example:

```
GTFID=(HM1)
```

ID=*trapid*

For a SLIP SET trap, specifies a trap identifier. The *trapid* is 1 to 4 alphanumeric or national (\$, #, @) characters. If ID is not indicated in a SLIP SET command, the system assigns a unique id.

Example:

```
ID=PER1
```

IDGROUP=*idgroup*

For a SLIP SET trap, specifies the name of a group of related traps. The *idgroup* name is 1 to 16 alphanumeric or national (\$, #, @) characters. An *idgroup* is self-defining, that is, it consists of all SLIP traps that specify the same *idgroup* name.

In a sysplex, the traps in the group can be on the same or different systems. More than one *idgroup* can be defined at the same time on a system or sysplex.

When a system disables one trap on reaching the MATCHLIM or PRCNTLIM for the trap, the system or systems disable all the traps in the group. If you specify any action to be taken after the traps are disabled, the action can have a sysplex scope. For example, if you specify ACTION=STOPGTF, the GTF tracing for that trap will be turned off on all systems in the sysplex.

Note: If the operator deletes or disables one trap in a group, only that trap is disabled; the other traps in the group continue.

Set up a group when you are trying to diagnose a problem that can occur on several or all of the systems in a sysplex. After the trap occurs and is disabled on one system, the IDGROUP parameter disables the traps on the other systems, so that manual operator intervention is not needed.

Abbreviation: IG

Example:

```
IDGROUP=TRAPGROUP3
```

IGNORE

See the ACTION=IGNORE parameter.

IF

Specifies the event as an instruction fetch. This parameter is positional; it must appear following SET and a comma.

JOBLIST=*jobname*

SLIP command

JOBLIST=(*jobname* [,*jobname*] . . .)

As an option of an ACTION or REMOTE parameter, identifies the names of jobs whose address spaces are to be dumped when the action is SVCD or SYNCSVCD in:

- The system in a sysplex that consists of one system
- The local system in a sysplex
- Another system in a sysplex, if REMOTE is specified

Specify from 1 to 15 job names. When you specify more than one name, enclose the names in parentheses and separate them by commas. When you specify only one name, you can omit the parentheses.

A *jobname* is 1 to 8 alphanumeric and national (\$, #, and @) characters. You can specify wildcard characters in a *jobname*. If you specify a wildcard character, the number of address spaces that will be dumped is limited to 15; refer to "Using wildcards in commands" on page 19.

Abbreviation: JL

Examples:

```
JOBLIST=(job1)
JOBLIST=(job?,TRAN*,A??XYZ)
JOBLIST=(job1,job2,job3)
```

JOBNAME=*userid*

JOBNAME=*jobname*

For an error event or PER trap, specifies the user ID of a TSO/E user or the job name of the job or started task to be monitored. This allows filtering of an event to only those units of work running under a particular job. Use JOBNAME whenever feasible.

The *userid* is 1 to 7 characters and the *jobname* is 1 to 8 characters. You can specify wildcards in the *userid* or *jobname* with the following exception: an * must be a suffix and cannot appear alone. For example, JOBNAME=*MASTER* is NOT valid, while JOBNAME=?MASTER? is valid. See "Using wildcards in commands" on page 19.

For a trap to match, the specified job name must be for the home (dispatched) address space. Because the JOBNAME is always associated with a work unit that is associated with the home address space, when you are in a cross-memory environment, JOBNAME= will only match if the home address space is that of the JOBNAME= specification.

For non-IGNORE PER traps, JOBNAME limits PER monitoring to the address spaces in which the specified job runs. If the unit of work runs in an address space other than the one in which it was dispatched, PER monitoring will also be active in that address space for that particular job.

For PER traps that do not specify ACTION=IGNORE, you can limit the address spaces being monitored by the following:

- ASID parameter
- JOBNAME parameter
- MODE=HOME parameter

If you omit all of these parameters, PER monitoring is active in all address spaces and may cause performance problems.

If you omit MODE=HOME, PER monitoring will be active only for the address space(s) specified by the ASID parameter for the job specified by the

JOBNAME parameter. If you omit MODE=HOME and ASID but specify JOBNAME, PER monitoring will be active for any address space(s) in which the job runs.

If you specify both ASID and JOBNAME, both filters must match the execution environment in order for the SLIP to match. For example, the executing job must match what is specified on the JOBNAME parameter and the primary ASID must match what is specified on the ASID parameter.

Abbreviation: J

Example:

JOBNAME=D10AXX1

JSPGM=*name*

For an error event or PER trap, specifies the 1 to 8 character name of the job step program that is to be monitored for a match. On error event traps, JSPGM causes a no-match if ERRTYF specifies MEMTERM.

Abbreviation: JS

Example:

JSPGM=IFOX00

LIST=(*start, end*)

LIST=(*start, end* [, *start, end*] ...)

As an option of an ACTION or REMOTE parameter, specifies one or more storage areas to be included in an SVC dump. Each area is defined by a set of starting and ending addresses, which can be either direct or indirect. (See "Indirect Addresses" on page 805.) A starting address must be less than or equal to the ending address.

LIST is similar to the SUMLIST parameter; the area specified by LIST is in a scheduled SVC dump while the area specified by SUMLIST is in a disabled summary dump.

Abbreviation: LS

Example:

ACTION=SVCD,LIST=(152,155,10%+2C%,+3F)

LPAEP=*name*

LPAEP=(*name* [, *start* [, *end*]])

For an error event or PER trap, monitors modules in the link pack area (LPA). The values are:

name

The entry point name or alias. The *name* is 1 to 8 characters. If the last character is an asterisk (*), SLIP interprets the asterisk as X'C0'. (Certain module names end with the character X'C0'.) If only *name* is specified, the range of monitoring is from the entry point or alias to the end of the module.

start

end

Offsets from the entry point or alias; they indicate the start and end of the range to be monitored. The *start* must be less than or equal to the *end*. For more information, see the notes for the RANGE parameter. If you specify only *start*, the range consists of that single address.

For an error event trap and an IF or SBT PER trap, LPAEP establishes the range of addresses to be monitored.

SLIP command

For an SA or SAS PER trap, LPAEP indicates that the storage alteration must be caused by an instruction within the specified range.

For a ZAD PER trap, LPAEP indicates that the zero address detection must be caused by an instruction within the specified range.

For an enabled, unlocked, task mode error that is matched against an error event trap, the RBLEVEL parameter controls the PSW address that is used to decide if LPAEP matches.

Example:

```
LPAEP=IEECB907, ...
```

If the system does not find the module in the LPA when processing the SLIP command, it assumes that you may later add the module dynamically to the LPA, and issues message IEE101I.

LPAMOD=name

LPAMOD=(name[,start[,end]])

For an error event or PER trap, monitors modules in the link pack area (LPA). The values are:

name

The module name or alias. The *name* is 1 to 8 characters. If the last character is an asterisk (*), SLIP interprets the asterisk as X'CO'. (Certain module names end with the character X'CO'.) If *name* is the alias, SLIP processing uses the load module name. If only *name* is specified, the range of monitoring is the entire module.

start

end

Offsets from the start of the module; they indicate the start and end of the range to be monitored. The *start* must be less than or equal to the *end*. For more information, see the notes for the RANGE parameter. If you specify only *start*, the range consists of that single address.

For an error event trap and an IF or SBT PER trap, LPAMOD establishes the range of addresses to be monitored.

For an SA or SAS PER trap, LPAMOD indicates that the storage alteration must be caused by an instruction within the specified range.

For a ZAD PER trap, LPAMOD indicates that the zero address detection must be caused by an instruction within the specified range.

For an enabled, unlocked, task mode error that is matched against an error event trap, the RBLEVEL parameter controls the PSW address that is used to decide if LPAMOD matches.

If the system does not find the module in the LPA when processing the SLIP command, it assumes that you may later add the module dynamically to the LPA, and issues message IEE101I.

Abbreviation: L

Examples:

Example 1:

```
LPAMOD=(IEAVTXYZ,2C)
```

Example 2: To monitor events in a load module for occurrences of SVC60, enter:

```
LPAMOD=IGC0006*
```

MATCHLIM=*m*

For an error event or PER trap, specifies that the SLIP trap is to be disabled after *m* matches, where *m* is an integer from 1 to 65535. The default values for MATCHLIM are:

- If you specify TARGETID the default for MATCHLIM is 1.
- If you omit MATCHLIM but specify ACTION=SVCD or ACTION=SYNCSVCD, the trap is disabled after one match.
- If you omit MATCHLIM for a PER trap with ACTION=STRACE or ACTION=STDUMP, see the documentation of those keywords regarding MATCHLIM processing.
- If you omit MATCHLIM for any other type of trap, the trap can match any number of times. No other parameters are considered in determining the default for MATCHLIM.
- If you specify multiple action parameters that each have a default match limit, the system selects the lowest default.

Use a DISPLAY operator command to display the number of times that the conditions for a SLIP trap are met since the last time the trap was enabled.

Note: Between the instant matchlim is reached and when the trap is actually disabled, a small amount of time elapses. It is possible for the trap to match on another CPU during this small time interval. If this occurs, matchlim will actually be exceeded, with unexpected results. Therefore, use caution in setting a trap in a heavily used module as, for example, the dispatcher.

Abbreviation: ML

Example:

MATCHLIM=50

MODE=*mode*

MODE= (*mode* [,*mode*] ... [, ANY | EVERY])

For an error event or PER trap, specifies the mode the system must be in for the trap to match. You can specify more than one mode. You can indicate how many modes are needed to cause a match by one of the following.

ANY Any one of the listed modes

EVERY
Every one of the listed modes

ANY and EVERY cannot appear alone without one or more modes and cannot appear together.

The modes are:

DIS Physically disabled for I/O and external interruptions

GLOC Holding any global lock

GLOCSD
Holding a global suspend lock

GLOCSP
Holding a global spin lock

HOME
Executing in the home (dispatched) address space

LLOC Holding a local lock

LOCK Holding any lock

SLIP command

PKEY Problem program key (8 or more)
PP Problem program state
RECV Recovery routine in control
SKEY System key (7 or less)
SRB SRB mode
SUPER
Supervisor state
SUPR Supervisor control mode (any bit set in PSASUPER)
TCB TCB mode
TYP1 Type 1 SVC in control
ALL All of the listed modes, except HOME

Notes:

1. Specifying the LLOC, LOCK, or ALL option of the MODE parameter automatically includes the cross memory local lock (CML).
2. Like ASID and JOBNAME, MODE=HOME limits PER monitoring. For non-IGNORE PER traps, specifying MODE=HOME indicates that PER monitoring is to be active only when the unit of work executes in the address space in which it was dispatched.
3. For an enabled, unlocked, task mode error that is matched against an error event trap, the RBLEVEL parameter controls the PSW address that is used to decide if MODE matches.
4. Whenever you specify HOME, regardless of the ANY/EVERY option you specify or default to, the unit of work must be executing in the home (dispatched) address space. If you specify or default to the ANY option, at least one of the other modes you specify must be the same as the system mode for a match to occur.
5. The RECV mode cannot be specified on a PER trap.

Abbreviation: M

Example:

MODE=(LLOC,SRB,EVERY)

MSGID=message-id

Causes control to be passed to the SLIP action processor under the unit of work issuing the WTO when the MSGID of the WTO matches the message ID specified on the MSGID parameter. The slip action processor gets control after SSI and MPF processing.

The input MSGID can be a maximum of 10 characters. When the MSGID is not contained within single quotation marks, only alphanumeric characters are accepted. The character immediately following the MSGID in the WTO must be blank for the trap to match. When a quoted MSGID is specified, the MSGID might contain any characters. The character immediately following the MSGID in the WTO need not be blank. For example, MSGID='AMSGID' will match a WTO whose first characters are AMSGIDX, but MSGID=AMSGID will not.

Except in the case of connected branch entry WTOs, SLIP will perform match processing on each line of the multiline messages. For example, if a SLIP is set on the IEE852I message with a MATCHLIM=5 and ACTION=SVCD, five dumps will be produced for the same issuance of the message since it has multiple lines of output.

SLIP does not get control:

- For messages that are reissued, for example, messages that are issued on one system and appear on another, or branch entry WTOs that are reissued.
- For branch entry WTO if the NLCKS, LOADWAIT, or SYNCH=YES parameter is specified on the WTO invocation.
- For branch entry WTO in certain situations where abending the unit of work may cause system problems.
- For branch entry WTOs that are issued when FRRs do not use the normal stack. For example, when FRR is on the supervisor stack. (All user programs use the normal stack.)
- For minor lines associated with a branch entry WTO.

When the SLIP action processor gets control these registers are set:

- Register 2 — contains the address of the SLIP message data area, found in mapping macro IHASLMSG.
- Register 3 — contains the address of the text (or the major line if there are minors associated with the major).
- Register 4 — contains the address of the SLIP message data area, associated with the minor line, or 0 if there is no minor line (applicable for SVC WTO only).
- Register 5 — contains the address of the text for the minor line or 0 if there is no minor line (applicable for SVC WTO only).

Once in the SLIP action processor, the MSGID filter along with all other SLIP keywords that may have been specified (for example, DATA or JOBNAME) apply in determining whether the trap will match.

NODUMP

NOSVCD

NOSYSA

NOSYSM

NOSYSU

See the ACTION=*nodump* parameter.

NOSUP

See the ACTION=NOSUP parameter.

NUCEP=*name*

NUCEP=(*name* [, *start* [, *end*]])

NUCMOD=*name*

NUCMOD=(*name* [, *start* [, *end*]])

For an error event or PER trap, monitors modules in the nucleus. There is no difference between the NUCMOD and NUCEP parameters. The values are:

name

The module name. The *name* is 1 to 8 characters. If the last character is an asterisk (*), SLIP interprets the asterisk as X'C0'. (Certain module names end with the character X'C0'.) If only *name* is specified, the range of monitoring is the entire module.

start

end

Offsets from the start of the module; they indicate the start and end of the range to be monitored. The *start* must be less than or equal to the *end*. For more information, see the notes for the RANGE parameter. If you specify only *start*, the range consists of that single address.

SLIP command

For an error event trap or IF,SBT PER trap, NUCMOD or NUCEP establishes the range of addresses to be monitored.

For an SA or SAS PER trap, NUCMOD or NUCEP indicates that the storage alteration must be caused by an instruction within the nucleus module or within the specified range.

For a ZAD PER trap, NUCMOD or NUCEP indicates that the zero address detection must be caused by an instruction within the specified range.

For an enabled, unlocked, task mode error that is matched against an error event trap, the RBLEVEL parameter controls the PSW address that is used to decide if NUCMOD or NUCEP matches.

Abbreviation: N

Example:

```
NUCMOD=(IEAVTRTS,C4)
```

- OK** For a SLIP SET trap, omits checking that could result in WTOR messages IEE088D, IEE604D and IEE831D. IBM recommends that you use the OK parameter only when issuing SLIP from a parmlib member.

PRCNTLIM=*p*

For a PER trap, specifies a software limit for PER processing by indicating a maximum percentage of system time that can be devoted to processing caused by PER interruptions. At least 33.55 seconds must have elapsed since the first PER interruption before a trap will be disabled because of this limit.

The range of integers for *p* is 1 to 99. You should use caution in specifying 99 because it means that no percent limit checking is done.

Use PRCNTLIM to tell SLIP processing to disable a SLIP trap when both of the following occur:

- A PER interrupt occurs.
- SLIP determines that the specified PRCNTLIM value has been reached.

The value computed to test PRCNTLIM is an approximation. SLIP makes this calculation only when a PER interrupt occurs, so the PRCNTLIM parameter does not cause the trap to be disabled until a PER interrupt occurs.

If you omit PRCNTLIM, the default is 10.

Abbreviation: PL

Example:

```
PRCNTLIM=20
```

PSWASC=*mode*

PSWASC=(*mode*[,*mode*]...)

For an error event or PER trap, specifies the PSW address space control (PSWASC) mode the system must be in for the trap to match. The *mode* is:

HOME

Home ASC mode

PRIMARY

Primary ASC mode

SECONDARY

Secondary ASC mode

AR

Access register ASC mode

One or more modes can be specified; the trap will match if the PSWASC mode is one of the specified values.

Allowable Abbreviations:

- PA for PSWASC
- H for HOME
- P for PRIMARY
- S for SECONDARY

Example:

PSWASC=(AR,S)

PVTEP=*name*

PVTEP=(*name* [, *start* [, *end*]])

For an error event or PER trap, requests that SLIP monitor modules in the private area. The values are:

name

The entry point name or alias. The *name* is 1 to 8 characters. If the last character is an asterisk (*), SLIP interprets the asterisk as X'C0'. (Certain module names end with the character X'C0'.) If only *name* is specified, the range of monitoring is from the entry point or alias to the end of the module.

'*name*'

The last characters of a posix executable file. The '*name*' is 1 to 80 characters. It may contain any characters, and it is case sensitive. PVTMOD or PVTEP may be used interchangeably with the same results.

Note: If entering the slip trap through a parmlib member (such as ieaslpxx) then you may not be able to enter 80 characters because the PVTMOD/EP parameter must fit on a line.

All the rules that apply to PVTMOD/PVTEP processing apply here, except that only the last characters of posix executable files are compared with the specified '*name*' to determine whether a match has occurred. For example, if PVTMOD='n/sh' and the path name of the file being matched with is /bin/sh, a match will occur.

start

end

Offsets from the entry point or alias; they indicate the start and end of the range to be monitored. The *start* must be less than or equal to the *end*. For more information, see the notes for the RANGE parameter. If you specify only *start*, the range consists of that single address.

For an error event trap and an IF or SBT PER trap, PVTEP establishes the range of addresses to be monitored.

For an SA or SAS PER trap, PVTEP indicates that the storage alteration must be caused by an instruction within the specified range.

For a ZAD trap, PVTEP indicates that the zero address detection must be caused by an instruction within the specified range.

For an enabled, unlocked, task mode error that is matched against an error event trap, the RBLEVEL parameter controls the PSW address that is used to decide if PVTEP matches.

When an error event or PER interruption occurs, SLIP searches for the private module first in the current primary address space and then in the dispatched

SLIP command

address space. A match occurs only when the address of the instruction with the error or interrupt is found within the boundaries of this copy of the module.

Note:

1. To check in a private area module, SLIP must obtain the local lock when PVTEP or PVTMOD is specified for any trap other than a PER SBT trap or a PER IF trap.
2. SLIP is capable of monitoring a single PER range. When a duplicate module is found, SLIP will recognize only the first module and will not notify the user of the possible conflict.

Example:

```
PVTEP=(MYEP,10,40)
```

PVTMOD=*name*

PVTMOD=(*name* [, *start* [, *end*]])

PVTMOD (or PVTEP) = '*name*'

PVTMOD (or PVTEP) = ('*name*' [, *start* [, *end*]])

For an error event or PER trap, monitors modules in the private area. The values are:

name

The module name or alias. The *name* is 1 to 8 characters. If the last character is an asterisk (*), SLIP interprets the asterisk as X'C0'. (Certain module names end with the character X'C0'.) If *name* is an alias, SLIP processing uses the load module name. If only *name* is specified, the range of monitoring is the entire module.

'*name*'

The last characters of a posix executable file. The '*name*' is 1 to 80 characters. It may contain any characters, and it is case sensitive. PVTMOD or PVTEP may be used interchangeably with the same results. All the rules that apply to PVTMOD/PVTEP processing apply here, except that only the last characters of posix executable files are compared with the specified '*name*' to determine whether a match has occurred. For example, if PVTMOD='n/sh' and the path name of the file being matched with is /bin/sh, a match will occur.

start

end

Offsets from the start of the module; they indicate the start and end of the range to be monitored. The *start* must be less than or equal to the *end*. For more information, see the notes for the RANGE parameter. If you specify only *start*, the range consists of that single address.

Private area modules can reside (starting at different addresses) in several address spaces. To resolve the range of addresses to be monitored for PVTMOD to a particular address space, use either the JOBNAME parameter with MODE=HOME or the ASID parameter. If neither parameter is specified and the module is loaded into several address spaces, the system might resolve the PER range to any one of those address spaces.

For an error event trap and an IF or SBT PER trap, PVTMOD establishes the range of addresses to be monitored.

For an SA or SAS PER trap, PVTMOD indicates that the storage alteration must be caused by an instruction within the specified range.

For a ZAD PER trap, PVMOD indicates that the zero address detection must be caused by an instruction within the specified range.

For an enabled, unlocked, task mode error that is matched against an error event trap, the RBLEVEL parameter controls the PSW address that is used to decide if PVTMOD matches.

To check for a private area module, SLIP must obtain the local lock. SLIP cannot obtain the local lock, it cannot check the private area module, and the trap will not match.

On an error or interrupt, SLIP searches for the private module first in the current primary address space and then in the dispatched address space. A match occurs only when the address of the instruction with the error or interrupt is found within the boundaries of this copy of the module.

Note:

1. To check in a private area module, SLIP must obtain the local lock when PVTEP or PVTMOD is specified for any trap other than a PER SBT trap or a PER IF trap.
2. SLIP is capable of monitoring a single PER range. When a duplicate module is found, SLIP will recognize only the first module and will not notify the user of the possible conflict.
3. PVTMOD processing does not support modules brought into storage using the LOAD macro with the ADDR parameter. To monitor those modules, use the RANGE parameter instead of PVTMOD.

Abbreviation: P

Example:

```
PVTMOD=(MYMOD,1C,1F)
```

RANGE=*start*

RANGE=(*start,end***)**

For a PER trap, specifies the starting and ending addresses of virtual storage to be monitored. The addresses can be either direct or indirect. For indirect addressing, see "Indirect Addresses" on page 805.

If you specify only *start*, the range consists of that 1 byte. If the starting address is greater than the ending address, the addresses wrap around.

RANGE is not valid for error event traps. RANGE cannot be specified on an ACTION=IGNORE storage alteration PER trap. RANGE is not valid for a ZAD PER trap.

The following notes apply to all SLIP parameters that have *start[.end]* options to indicate a range.

Note:

1. Consider the range carefully on any PER trap. A wide range could cause performance to degrade because of the processing overhead for many PER interrupts. For example, for an address range that wraps storage, such as (700,600), PER events might occur too fast for the system to disable the trap. If this happens, manually reset control registers 9, 10, and 11 to zero. This disables PER and also defines a minimum address range.
2. For successful branch monitoring, hardware PER processing does not check the address range specified on the LPAEP, LPAMOD, NUCEP, NUCMOD,

SLIP command

PVTEP, PVTMOD, and RANGE parameters. Therefore, a branch taken by an instruction anywhere in the system would cause a successful branch PER interrupt.

To simulate successful branch monitoring for an address range, SLIP initially sets up instruction fetch monitoring for the desired address range. Then, when the processor gets to an instruction within the requested range (indicated by an instruction fetch PER interrupt), SLIP automatically switches PER monitoring to successful branch mode. Thus, the branch into the range does not cause a PER interrupt and does not match the trap for that instruction.

You should be aware that the first PER event that occurs when the processor enters the requested range may not be a successful branch event. This *extra* instruction fetch event might affect values you supplied for other parameters, such as MATCHLIM. When the processor leaves the requested range, PER monitoring returns to instruction fetch monitoring on the range, thus avoiding unnecessary PER interrupts. If the instructions being monitored are enabled for I/O and/or external interrupts, control may leave and then re-enter the monitored range due to normal interrupt processing.

3. Mode switching does not occur for successful branch PER traps with ACTION=IGNORE specified. This means that if the initial entry into a monitored area matches an IGNORE trap, the mode remains instruction fetch and the *extra* event is delayed.

For successful branch monitoring, if an Execute instruction has a successful branch target, the location of the Execute instruction is used to determine whether or not the branch was within the monitored area without regard to the location of the executed branch.

4. If a RANGE address string is long, one or more displacements can be moved to the next line. In this case the new line must start with either + or -.
5. The RANGE parameter must end with a comma or a closing parenthesis at the same line.

For an SAS PER trap, a storage alteration by a STURA instruction at any address is accepted.

Abbreviation: RA

Examples:

```
RANGE=(600,700)
```

```
RANGE=(10?+4C0?+2C?+E8?+24?+150?+7C?+350?+24?+7FFF  
+7FFF,10?+4C0?+2C?+E8?+24?+150?+7C?+350?+24?+7FFF+7FFF  
+7FFF+7000)
```

```
RANGE=(10?+4C0?+2C?+E8?+24?+150?+7C?+350?+24?+7FFF+7FFF,  
+7FFF+7FFF+7000)
```

RBLEVEL=ERROR

RBLEVEL=NOTSVRB

RBLEVEL=PREVIOUS

For an error event trap, indicates the request block (RB) that contains the registers and PSW of interest for a particular error. SLIP uses the following identified by RBLEVEL:

- PSW when processing the ADDRESS, LPAEP, LPAMOD, PVTEP, PVTMOD, MODE, NUCEP, and NUCMOD parameters
- Registers when processing the DATA, TRDATA, LIST, SUMLIST, and TRDATA parameters

RBLEVEL applies only to unlocked, task mode errors.

ERROR

The PSW is obtained from the request block (RB) prior to the ABEND RB.
The registers are obtained from the ABEND RB.

PREVIOUS

The RBs used are each one RB prior to the RBs used for ERROR.

NOTSVRB

The PSW is obtained from the most recent non-SVRB and the registers are obtained from the associated SVRB.

Abbreviation: RB

Example:

RBLEVEL=NOTSVRB

REASON=*code*

For an error event trap, specifies a user or system reason code to be associated with the error in the accompanying COMP parameter. The REASON parameter cannot be coded without the COMP parameter.

For the reason code, enter 1 to 8 hexadecimal digits. If the code is fewer than 8 digits, the system pads it on the left with zeroes. For example, REASON=4 means a reason code of 00000004.

You can indicate a set of reason codes by substituting x's for up to 7 digits. For example, REASON=44XXXX means any reason code that begins with the digits 0044; the last 4 digits can be any hexadecimal value. You can use x's in any position.

Note: To match the REASON parameter, the reason code must have been specified via the REASON parameter of the ABEND, SETRP, or CALLRTM macro.

Abbreviation: RE

Example:

COMP=U123x, REASON=8

RECORD

See the ACTION=RECORD parameter.

RECOVERY

See the ACTION=RECOVERY parameter.

REFAFTER

See the ACTION=REFAFTER parameter.

REFBEFOR

See the ACTION=REFBEFOR parameter.

REFAFTER=(*triplet*)

REFAFTER=(*triplet* [, *triplet*] ...)

REFBEFOR=(*triplet*)

REFBEFOR=(*triplet* [, *triplet*] ...)

As an option of an ACTION parameter, specifies the refresh to be taken after or before the action specified for the SLIP trap. The parameter must be specified if the ACTION parameter includes REFAFTER or REFBEFOR.

The following syntax for a triplet is identical for REFAFTER and REFBEFOR.
target [(*b*)] , EQ | EQA | EQC [(*n*)], *value*

SLIP command

The parameters in a *triplet* are:

target

Specifies the first triplet operand, which could be the address of a storage location or a general purpose register (GPR), to be refreshed with the supplied value. The target can be:

- A direct address (virtual address) of 1 to 8 hexadecimal digits
- A general purpose register, xR, where x is 0 through 15
- An indirect address (see “Indirect Addresses” on page 805)

b

If specified, *b* modifies the target address by indicating the starting bit for a binary refresh. For registers, *b* can be 0 through 31. The starting bit position plus the bit size for the refresh must not exceed 31.

EQ

Specifies the second triplet operand, which refreshes the contents of the target address with a binary or hexadecimal value.

EQA

Refreshes the target address with the address specified in the *value* parameter. A binary refresh must not be specified with EQA.

EQC

Refreshes the contents of the address specified as the target with the contents of the address specified in the *value* parameter.

n

Specifies the number of bytes or bits processed for a contents (EQC) or address (EQA) refresh. When *b* is specified with the target, the range is from 1 to 8 bits with the default being 1 bit. Otherwise, the range is 1 to 4 bytes with the default being 4 bytes.

Note: When SLIP does a contents or an address refresh, it refreshes the first *n* bytes of storage and the last *n* bytes of a register.

value

Specifies the third triplet operand. The *value* refreshes the target address. When the **EQ** parameter is specified without A or C, the value can be:

- A constant, whose length determines the number of bytes or bits to be refreshed.
- Binary digits, if *b* is specified with the target address. If *b* is not specified, the value is in hexadecimal digits. For example, 6R(0),EQ,01 is binary and 6R,EQ,01 is hexadecimal. For binary refreshes, the length of the value establishes the length of the refresh.
 - The maximum length for a binary refresh is 8 bits.
 - Binary refreshes can cross byte boundaries but not register boundaries.
- Hexadecimal digits, whose length determines the number of bytes to be refreshed, when the target is not a register. However, the maximum length of the value is 4 bytes. If you specify B36,EQ,8AD62, two and a half bytes of data are refreshed starting at location X'B36'.

If the target address is a register, the length of the refresh is 4 bytes, and the value is right-justified. For example, 4R,EQ,8 is equivalent 4R,EQ,00000008.

If **EQA** or **EQC** is specified, the value can be:

- A direct address (virtual address) of 1 to 8 hexadecimal digits
- A general purpose register, xR or xG , where x is 0 to 15
- An indirect address (see “Indirect Addresses” on page 805)

Considerations for storage refreshes:

- SLIP processes the PER interrupt after the instruction has fully completed, except possibly for MVCL or CLCL instructions. The refresh will occur at that time.
- Storage being modified **must** be paged in when the modification occurs.
- Refreshes are processed one triplet at a time until one fails, at which time the refreshing processing stops.
- Use REFBEFOR when you need to refresh storage on which some subsequent SLIP action may depend; use REFAFTER otherwise.
- Low storage refreshes, for addresses 0 to X'1FF', are allowed if direct addressing is used.

Note: Do not use the REFBEFOR or REFAFTER parameters to refresh system-protected areas like the PSA, nucleus, reentrant programs, and so on. Doing so will cause SLIP to receive an abend X'0C4'.

Abbreviation: RFA or RFB

Examples:

Example 1: In the following trap, every time the contents of locations X'10000' to X'10003' in the address space for a job named CONS is modified, the trap causes the current contents to be recorded in a trace record and then stores X'00000A24' into location X'10000'.

```
SLIP SET,SA,RANGE=(10000,+3),ACTION=(REFAFTER,TRACE),
TRDATA=('CONS'.10000,+3),
REFAFTER=('CONS'.10000,EQ,00000A24),ASIDSA=('CONS'),END
```

Example 2: When the trap matches, an SVC dump is requested the storage will contain the value of X'3000' in address space A, then storage locations X'3000' and X'3001' are modified and register 1 is set to 0.

```
SLIP SET,IF,LPAMOD=(MYMOD,40,42),ACTION=(SVCD,REFAFTER),
SUMLIST=(0FC.3000,4000),REFAFTER=(0FC.3000,EQ(2),
0FD.4000,1R,EQ,00000000),END
```

Example 3: The following trap sets the first 3 bits of location '3000'X in the home address space of DUMPSRV to '101'B.

```
SLIP SET,IF,LPAMOD=(MYMOD,40,42),ACTION=(SVCD,REFBEFOR),
REFBEFOR=('DUMPSRV'.2R?(0),EQ,101),END
```

Example 4: The low-order 3 bytes of the virtual address are generated by adding X'30' to the value in general purpose register (GPR) 2 will be stored in DUMPSRV at location X'3001'.

```
SLIP SET,IF,LPAMOD=(MYMOD,40,42),A=(SVCD,REFBEFOR),
REFBEFOR=('DUMPSRV'.3001,EQA(3),2R?+30),END
```

```
REMOTE=(UNCOND | COND,remote)
REMOTE=(UNCOND | COND,(remote)[,(remote)]...)
REMOTE=(remote)
REMOTE=((remote)[,(remote)]...)
```

As an option of an ACTION parameter, allows SLIP to specify actions to be taken within the sysplex, on systems other than the system on which the trap matches. A SLIP trap on one system can initiate an SVC dump or load a wait state on another system. The REMOTE parameter values specify other

SLIP command

system(s) in the sysplex, actions for those systems, and options for dumps on those systems. The REMOTE parameter can be specified only when the ACTION for the local system is SVCD, SYNCVCD, or WAIT.

The parameters within the REMOTE parameter are: UNCOND, COND, SYSLIST, ACTION, ASIDLST, DSPNAME, JOBLIST, LIST, SDATA, and STRLIST.

For a system running z/OS V1R2 or higher in z/Architecture mode, the remote LIST parameter can contain 64-bit addresses. However, if the LIST parameter is sent to either a pre-z/OS V1R2 system, or to a z/OS V1R2 system running in ESA mode, the entire remote LIST specification is ignored.

UNCOND

COND

On a REMOTE parameter, indicates if the remote actions should be performed conditionally or unconditionally when the trap matches. COND or UNCOND must be the first value specified on the REMOTE parameter. If you omit UNCOND, you do not need to code a comma in its place.

You can specify COND only on a PER trap when the action for the local system is ACTION=WAIT. Use COND when it is more important that a unit of work be stopped than for the action on the remote system to occur. When COND is specified:

- When the SLIP trap matches for a PER interrupt and the task is enabled, unlocked, and in task mode, then the task is stopped, the actions on the other systems in the sysplex are scheduled, and the local system is put into a restartable wait state.
- When the SLIP trap matches for a PER interrupt and the task cannot be safely stopped, the actions on the other systems are ignored and the local system is put into a restartable wait state.

When UNCOND is specified and the SLIP trap matches for a PER interrupt:

- The actions on the other systems in the sysplex are scheduled.

SYSLIST=([sysname,group.member,group.*, (start),...])

On a REMOTE parameter, identifies systems in the sysplex on which the actions specified in *remote* will be performed. You can specify any combination of system names and/or member specifications. When group.* is specified, all systems where any member of the group is running are affected. If you omit SYSLIST, the default is all systems. When a system is identified more than once, implicitly or explicitly, the first occurrence is used, the others are ignored.

You can also specify a (*start*) address in place of any or all system names. The address can be either direct or indirect (see "Indirect Addresses" on page 805.) When specified, the address will be resolved when the trap matches, and the 8 byte remote system name retrieved from the specified storage.

Any trailing blanks found after the system name will be ignored.

Examples:

```
SYSLIST=(sys1)
SYSLIST=(sys1,sys2,sys3)
SYSLIST=(mygroup.member1,hisgrp.*)
SYSLIST=(sys1,group1.memberA,thegroup.member2)
SYSLIST=(sys1,group1.*, (2R?), (2R?+8))
```

ACTION=SVCD

ACTION=WAIT

On a REMOTE parameter, identifies the action to be taken by the systems identified in SYSLIST: to initiate an SVC dump or load a wait state. The dump options are ASIDLST, JOBLIST, DSPNAME, LIST, and SDATA. Dump options are processed only when the action is specified as SVCD or is the default.

When ACTION is not specified within the REMOTE parameter:

- If the local action is WAIT, the default action is WAIT.
- If the local action is SVCD or SYNCVCD, the default action is SVCD. All systems identified in SYSLIST use the default SLIP SVCD parameters as their default dump options.

ASIDLST, DSPNAME, JOBLIST, LIST, SDATA, and STRLIST

On a REMOTE parameter, the syntax is identical to the parameters for the dump option on the local system. When specified without an equal sign (=) and value, the options specified for the local system are used for the systems identified in SYSLIST.

Note: The only symbolic ASIDs accepted for the ASIDLST parameter are PRIMARY or CURRENT.

If no options are specified for the subparameters in the REMOTE parameter, the systems identified in SYSLIST use the options of the local system. For example, if you issue the SLIP SET,...,SDATA=(SQA),RM=(SDATA),END command, the systems identified in SYSLIST would dump SQA for SDATA.

Allowable Abbreviations:

- RM for REMOTE
- SY for SYSLIST

Examples:

```
REMOTE=(COND,(SYSLIST=MYGROUP.*,ACTION=WAIT))
REMOTE=((SYSLIST=(SYS1,SYS2),ACTION=WAIT),(SYSLIST=SYS3,ACTION=SVCD))
REMOTE=(COND,ACTION=SVCD,JL=(J1,J2),AL=(5,6),SDATA=COUPLE)
REMOTE=(ACTION=SVCD,SDATA,DSPNAME)
```

SA Specifies the event as a storage alteration. This parameter is positional; it must appear following SET and a comma. See “ASIDSA=asid” on page 840 for further information.

SAS

Specifies the event as a storage alteration caused by a STURA instruction. This parameter is positional; it must appear following SET and a comma. See “ASIDSA=asid” on page 840 for further information.

SBT

Specifies the event as a successful branch caused by a branch instruction into the specified range or a branch within the specified range. This parameter is positional; it must appear following SET and a comma.

SDATA=area**SDATA=(area[,area]...)**

As an option of an ACTION or REMOTE parameter, specifies the kind of system areas to dump. You can specify any combination of the following, enclosed in parentheses and separated by commas:

- ALLNUC
- ALLPSA
- COUPLE

SLIP command

- CSA
- GRSQ
- HCSAByASID
- HCSANoOwner
- HCSASysOwner
- LPA
- LSQA
- NOALLPSA
- NOSQA
- NOSUMDUMP
- NUC
- PSA
- RGN
- SQA
- SUMDUMP
- SWA
- TRT
- WLM
- XESDATA

If you specify only one area, you can omit the parentheses. See the CHNGDUMP command for descriptions of these dump options. Note, however, that the CHNGDUMP command does not affect SLIP processing of the SDATA parameter.

If you specify SDATA, the default SDATA options are:

- For ACTION=SVCD or SYNCVCD: SQA.
- For ACTION=STDUMP or TRDUMP: NOSQA.

If you do not specify SDATA, the default SDATA options are:

- For ACTION=SVCD or SYNCVCD: ALLPSA, CSA, LPA, NUC, RGN, SQA, SUMDUMP, and TRT.
- For ACTION=STDUMP or TRDUMP: NOALLPSA, NOSQA, NOSUM, and TRT.

SDATA options are added and overridden according to installation-defined defaults.

SDATA options override the installation-defined defaults set by the CHNGDUMP command for any parameters that can be specified. Also, although it can not be specified via the SLIP command, SDATA=SERVERS is always used for SLIP.

Allowable Abbreviations:

- HCAS for HCSAByASID
- HCNO for HCSANoOwner
- HCSY for HCSASysOwner
- NOALL for NOALLPSA
- NOSUM for NOSUMDUMP
- SD for SDATA
- SUM for SUMDUMP

Example 1:

ACTION=SVCD,SDATA=(SQA,TRT,SUM)

Example 2:

ACTION=SVCD,SD=(SQA,HCSABYASID,TRT,SUM)

Example 3:

ACTION=SVCD,SD=HCNO

STDATA=(start,end[,start,end])

As an option of the STRACE or STDUMP parameter, specifies one or more storage areas to be included in the system trace record. Each area is defined by a set of starting and ending addresses, which can be either direct or indirect (see "Indirect Addresses" on page 805.) A starting address must be less than or equal to the ending address.

The variable data included in the system trace record is limited to 20 bytes. The length of each range will be rounded up to the nearest multiple of 4 bytes.

SET

Specifies that the SLIP command sets a trap. This parameter is positional; it must appear following a blank after SLIP.

STDUMP

See the ACTION=STDUMP parameter.

STRACE

See the ACTION=STRACE parameter.

STRLIST=(s-option)**STRLIST=(s-option[,s-option]...)**

As an option of an ACTION or REMOTE parameter, includes in the dump one or more coupling facility structures. A structure is identified in a *s-option* value, which consists of the following parameters; STRNAME is required in STRLIST, the other parameters are optional.

STRNAME=strname

In the STRLIST parameter, designates a coupling facility list or cache structure. The *strname* is the name of the structure to be included in the dump. The *strname* is 1 to 15 characters and must begin with a letter.

Any dump options for this structure are replaced when you issue this SLIP command.

Abbreviation: STRNM

CONNNAME=connname

In the STRLIST parameter for a coupling facility cache structure, requests the user registry information for this user be included in the dump. The *connname* is the name of a connected user. If the connected user represented by the *connname* does not exist, the dump will not contain user registry information.

Abbreviation: CONNM

ACCESSTIME=ENFORCE**ACCESSTIME=NOLIMIT**

In the STRLIST parameter, indicates whether the dump time limit specified on the ACCESSTIME parameter of the IXLCONN macro is in effect.

When ACCESSTIME=ENFORCE is specified, the system holds structure dump serialization no longer than the time interval specified on the IXLCONN macro. This is the default. If ACCESSTIME=0 is specified on the

SLIP command

IXLCONN macro and ACCESSTIME=ENFORCE is specified on the SLIP command, the structure will not be included in the dump.

When ACCESSTIME=NOLIMIT is specified, the dump time limit is not in effect and the system will hold structure dump serialization until processing is completed.

Allowable Abbreviations:

- ACC for ACCESSTIME
- ENF for ENFORCE
- NOLIM for NOLIMIT

LOCKENTRIES

In the STRLIST parameter for a coupling facility list structure, the system includes in the dump the lock table entries for the requested structure. Because coupling facility cache structures do not have lock table entries, this parameter is ignored when specified for a coupling facility cache structure.

Abbreviation: LOCKE

USERCNTLS

In the STRLIST parameter, requests that the user attach controls be included in the dump.

Abbreviation: UC

COCLASS=ALL

COCLASS=(*list*)

In the STRLIST parameter for a coupling facility cache structure, specifies which cast-out classes are included in the dump. For each cast-out class, the cast-out class controls are dumped and the directory information for each of the entries within the requested cast-out classes are dumped (if SUMMARY is not specified).

COCLASS is not valid for a coupling facility list structure.

When COCLASS=ALL is specified, the cast-out class controls for all cast-out classes are dumped along with the directory information for all entries within the classes (if SUMMARY is not specified).

When COCLASS=(*list*) is specified, the cast-out class controls for (*list*) are dumped along with the directory information for the entries in the requested cast-out classes (if SUMMARY is not specified). The values specified in a range are the decimal cast-out class values in the range 0 to 65535. When a requested class does not exist, it is not dumped.

The *list* represents a list of values, ranges of values, or values and ranges of values, in any combination. For example:

(start1-end1,value2,start3-end3, ...)

Abbreviation: COC

STGCLASS=ALL

STGCLASS=(*list*)

In the STRLIST parameter for a coupling facility cache structure, specifies which storage classes are included in the dump. For each storage class, the storage class controls are dumped and the directory information for each of the entries within the requested storage classes are dumped (if SUMMARY was not specified).

COCLASS is not valid for a coupling facility list structure.

When STGCLASS=ALL is specified, the storage class controls for all storage classes are dumped along with the directory information for all entries within the classes (if SUMMARY is not specified).

When STGCLASS=(*list*) is specified, the storage class controls for (*list*) are dumped along with the directory information for the entries in the requested storage classes (if SUMMARY is not specified). The values specified are the decimal storage class values, 0 to 255. When a requested class does not exist, it is not dumped.

The *list* represents a list of values, ranges of values, or values and ranges of values, in any combination. For example:

(start1-end1,value2,start3-end3, ...)

Abbreviation: SC

LISTNUM=ALL

LISTNUM=(*list*)

In the STRLIST parameter for a coupling facility list structure, specifies which lists are included in the dump. The list controls are dumped along with the entry controls for the entries on each requested list (if SUMMARY is not specified).

LISTNUM is not valid for a coupling facility cache structure.

When LISTNUM=ALL is specified, the list controls for all lists in the coupling facility list structure are dumped along with the entry controls (if SUMMARY is not specified).

When LISTNUM=(*list*) is specified, the list controls for (*list*) are included in the dump along with the entry controls for those lists. The values specified are the decimal list values, 0 to 4294967295. The system ignores a zero, but does not treat a zero as an error. When a requested list does not exist, it is not dumped.

The *list* represents a list of values, ranges of values, or values and ranges of values, in any combination. For example:

(start1-end1,value2,start3-end3, ...)

Abbreviation: LNUM

ADJUNCT=CAPTURE

ADJUNCT=DIRECTIO

In the STRLIST parameter, requests that the adjunct data for each entry specified by the range be included in the dump. When this parameter is not specified or when adjunct data does not exist for this structure, the adjunct data is not included in the dump.

ADJUNCT may not be specified with SUMMARY.

When ADJUNCT=CAPTURE is specified, the adjunct data is captured in the facility dump space along with the directory information while dumping serialization is held.

When ADJUNCT=DIRECTIO is specified, the adjunct data is written directly to the dump data set after the directory information is captured. The adjunct data is not captured in the structure dump table. Note that the adjunct data may be changing as dumping proceeds.

Allowable abbreviations:

- ADJ for ADJUNCT
- CAP for CAPTURE

SLIP command

- DIO for DIRECTIO

ENTRYDATA=UNSERIALIZE

ENTRYDATA=SERIALIZE

In the STRLIST parameter, indicates that the entry data for each entry within the requested range is included in the dump. When this parameter is not specified or when entry data does not exist for the structure, entry data is not included in the dump.

ENTRYDATA may not be specified with SUMMARY.

When ENTRYDATA=UNSERIALIZE is specified, the entry data is dumped after structure dump serialization is released. Note that the entry data may be changing relative to the entry controls that were captured while structure dump serialization was held.

When ENTRYDATA=SERIALIZE is specified, the entry data is dumped while serialization is held. If ACESSTIME=ENFORCE is specified and the dump time limit expires before the entry data is written to the dump data set, the system continues to write the entry data to the dump data set even though serialization is not held.

Allowable abbreviations:

- EDATA for ENTRYDATA
- UNSER for UNSERIALIZE
- SER for SERIALIZE

SUMMARY

In the STRLIST parameter, requests a summary of the range of classes or lists that is dumped. The directory information for the entries is excluded from the dump.

SUMMARY may not be specified with ADJUNCT or ENTRYDATA.

Abbreviation: SUM

Note the following details for the STRLIST parameter:

1. A syntax error message is issued if STRNAME is not the first parameter in STRLIST.
2. If CONNAME and ACESSTIME are specified more than one time for a structure, the first CONNAME and the last ACESSTIME are used.
3. When a list number, a storage class, a cast-out class, or an entry is specified in the STRLIST more than once, it will be dumped more than once. An example of this is when STGCLASS=ALL is specified with COCLASS=ALL. All entries in the coupling facility cache structure are dumped twice. Once grouped by storage class and again grouped by cast-out class.
4. When LISTNUM, STGCLASS, or COCLASS is **not** specified, no list or class controls are dumped and no entries are dumped.
5. If a large amount of data is requested to be dumped, the system may not be able to dump all the data completely. You can expect to dump up to a maximum of 47 structures, if you specify no more than six ranges. If you must specify more than six ranges, you must specify fewer structures. For each structure less than 47 that you specify, you can specify another 10 ranges, as follows:

Number of Structures	Number of Ranges
47	6

Number of Structures	Number of Ranges
46	16
45	26
44	36
⋮	⋮

6. If the system cannot dump all the data you requested, it prioritizes the data according to your specifications on the command, as follows:

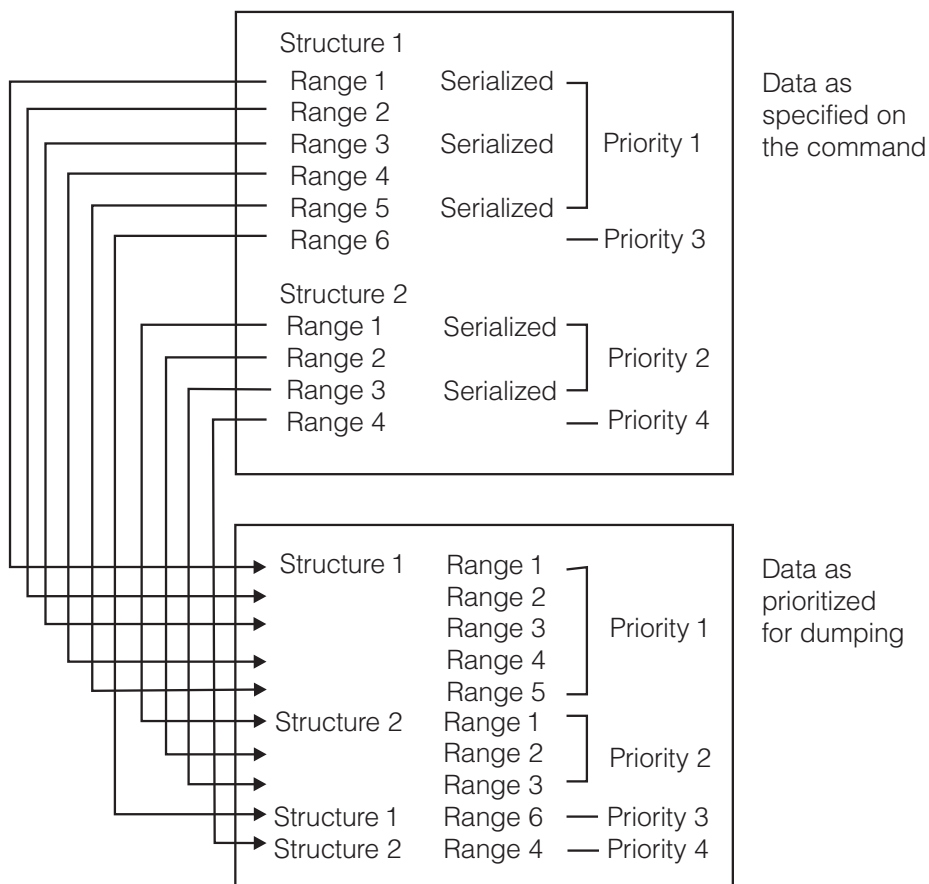

- a. The system will attempt to dump the first requested structure first.
 - Within that structure, the system processes the LOCKENTRIES, USERCNTLS, COCLASS, STGCLASS, and LISTNUM parameters in the order that they are specified. COCLASS, STGCLASS, and LISTNUM may be specified more than once for a single structure.
 - The system dumps requested serialized data before requested unserialized data, starting with the first requested data in the structure and proceeding through the last data that was requested as *serialized*.
- b. The system then dumps the next-requested structure data, starting with the first requested data in the structure and proceeding through the last data that was requested as *serialized*.
- c. The system continues in this manner until all *serialized* data in all requested structures has been prioritized for dumping.

SLIP command

- d. The system then dumps any remaining data that was requested as *unserialized* and that may not have been dumped, beginning with the first-requested structure.

SUMLIST=(start,end)

SUMLIST=(start,end[,start,end]...)

As an option of an ACTION parameter, specifies one or more storage areas to be included in a disabled summary dump. Each area is defined by a set of starting and ending addresses, which can be either direct or indirect. (See "Indirect Addresses" on page 805.) A starting address must be less than or equal to the ending address.

Specify SUMLIST with ACTION=SVCD or ACTION=TRDUMP when the SUNDUMP option is specified or is the default in the SDATA parameter.

SUMLIST is similar to the LIST parameter; the area specified by LIST is in a scheduled SVC dump while the area specified by SUMLIST is in a disabled summary dump.

Abbreviation: SL

Example:

```
ACTION=SVCD,SUMLIST=(152,155,2R%,+3)
```

SVCD

See the ACTION=SVCD parameter.

SYNCSVCD

See the ACTION=SYNCSVCD parameter.

TARGETID

See the ACTION=TARGETID parameter.

TARGETID=trapid

As an option of an ACTION parameter, specifies the trap to be activated when the current trap is deactivated as a result of MATCHLIM. The *trapid* identifies the next PER trap to be activated, where 1 to 4 alphanumeric or national (\$, #, @) characters specifies the trap identifier. For example:

```
TARGETID=PER2.
```

Specifying TARGETID=*trapid* on the first PER trap associates the trap with the SLIP trap ID of the second trap. The second PER trap can specify a third trap and so on. There is no limit to the number of traps in a chain of dynamic traps, called a *dynamic PER activation chain*. The range of the target trap is evaluated in the matching environment of the prior trap in the activation chain. Storage areas associated with RANGE **must** be paged in when the match occurs.

Indirect addressing on the RANGE parameter allows storage locations and registers to be resolved when their values are known.

When TARGETID is used as a parameter, it must also be specified as one of the ACTION values. Failure to do so will result in the TARGETID parameter being ignored.

Abbreviation: TI

Example 1:

The following dynamic per trap example can do alterations on the first X'20' bytes of the storage obtained by the GETMAIN command. Assume that the GETMAIN command is issued prior to location X'100' in module MYMOD, such that the address of the obtained storage is in GPR 1.

```
SLIP SET,IF,PVTMOD=(MYMOD,100),DISABLE,ACTION=(TARGETID,TRACE),
      TARGETID=H2,ID=H1,ASID=(0FC),END
```

```
SLIP SET,SA,ASIDSA=(0FC),RANGE=(1R?,+20),
      ACTION=WAIT,ID=H2,DISABLE,END
```

Example 2:

This example uses indirect addressing on the RANGE keyword to trap on alterations to one byte of storage. The address is found at offset X'50' into the CVT. See "Dynamic PER traps" on page 819 for more details.

```
SLIP SET,SA,RANGE=10?+50?,A=WAIT,JOBNAME=CONS,END
```

TRACE

See the ACTION=TRACE parameter.

TRDATA=(STD[,REGS][,list])

TRDATA=(REGS[,list])

TRDATA=(list)

As an option of an ACTION=TRACE or ACTION=TRDUMP parameter, indicates the type and contents of the generalized trace facility (GTF) records to be collected in the requested GTF trace.

STD

Indicates that GTF is to write a SLIP standard trace record, as described in *z/OS MVS Diagnosis: Tools and Service Aids*.

REGS

Indicates that the SLIP trace records are to contain the contents of the 16 general purpose registers at the time of the error event or PER interruption.

list

Specifies one or more sets of addresses for one or more storage areas to dump. Each area cannot exceed 65535 bytes. The addresses can be direct or indirect. For each set, the starting address must be less than or equal to the ending address. (See "Indirect Addresses" on page 805.)

Abbreviation: TD**Example:**

```
SLIP ACTION=TRACE,TRDATA=(STD,REGS,152,155)
```

TRDUMP

See the ACTION=TRDUMP parameter.

WAIT

See the ACTION=WAIT parameter.

ZAD

Specifies the event as a zero address detection. This parameter is positional; it must appear following SET and a comma. See "ASIDSA=asid" on page 840 for further information.

Example:

```
SLIP SET,ZAD,ADDRESS=(CB200,CB400),ASIDSA=SA,END
```

SLIP SET examples**Example 1:**

SLIP command

This example establishes an enabled SLIP trap with an ID of 0002. It requests an SVC dump (by default) if there is an OC4 program check interruption while module MOD01 and job JOBXYZ are in control.

```
SLIP SET,ENABLE,ID=0002,COMP=OC4,ERRTYP=PROG,JOBNAME=JOBXYZ,  
LPAMOD=MOD01,END
```

Example 2:

This example sets up an error event (non-PER) trap with an ID of DUM1 that suppresses all SYSABEND dumps for the 806 system completion code.

```
SLIP SET,COMP=806,ID=DUM1,ACTION=NOSYSA,END
```

Example 3:

This command sets an instruction fetch PER trap that will cause an SVC dump when the instruction at CD3100 is executed. PER monitoring will be active in all address spaces in the system because neither ASID nor JOBNAME was specified.

```
SLIP SET,IF,ENABLE,ACTION=SVCD,RANGE=CD3100,END
```

Example 4:

This example sets up a trap for a successful branch trace of the path taken through the LPA module MOD01 starting at offset 108 (hex) through 4FC during the execution of JOBX. After 20 standard SLIP records have been written the trap is automatically disabled.

```
SLIP SET,SBT,ENABLE,ID=PER1,LPAMOD=(MOD01,108,4FC),JOBNAME=JOBX,  
ACTION=TRACE,MATCHLIM=20,END
```

Example 5:

This command defines a trap that will cause an SVC dump when storage location CD3010 is altered. MATCHLIM is 1 and PRCNTLIM is 10 by default.

```
SLIP SET,SA,ENABLE,ACTION=SVCD,RANGE=CD3010,END
```

Example 6:

This example sets up two SLIP traps, both initially disabled, and then enables them both with a SLIP MOD command. The second trap prevents the first trap from matching for the subset of instructions specified by LPAMOD.

```
SLIP SET,IF,DISABLE,LPAMOD=(MODX,110,1FB),JOBNAME=JOB1,MATCHLIM=500,  
ACTION=TRACE,TRDATA=(STD,REGS),END  
SLIP SET,IF,DISABLE,LPAMOD=(MODX,1C4,1D7),ACTION=IGNORE,END  
SLIP MOD,ENABLE,ALL
```

Note: The IGNORE trap is specified after the non-IGNORE trap because traps are processed for match tests in last-in, first-out order.

Example 7:

The SLIP trap will match on a branch instruction into LPA module MODZ starting at offset 220 (hex) through 240. When the trap is matched, the actions specified in the REMOTE parameter will be performed unconditionally. Systems SYS1 and SYS2 will be placed into a restartable wait state. System SYS3 will schedule an SVC dump. The dump for system SYS3 will include address spaces 3 and 4. The local system will also schedule an SVC dump. The dump for this system will include address spaces 0 and C.

```
SLIP SET,SBT,ACTION=SVCD,ASIDLST=(0,C),LPAMOD=(MODZ,220,240),
REMOTE=(UNCOND,(SYSLIST=(SYS1,SYS2),ACTION=WAIT),
(SYSLIST=(SYS3),ACTION=SVCD,ASIDLST=(3,4))),END
```

Example 8:

The SLIP trap does not contain the parameters ASIDSA or DSSA. Normally, message IEE604D would be issued; however, because the OK parameter is also specified, SLIP will continue processing without issuing the WTOR.

```
SLIP SET,SA,OK,RANGE=(1000,2000),END
```

Example 9:

This example and the next show how to use the STOPGTF parameter. This one stops GTF tracing when the instruction at offset 50 in module MYMOD is executed. In this case, the GTF records originate from some source, perhaps other than SLIP:

```
SLIP SET,IF,PVTMOD=(MYMOD,50),ACTION=STOPGTF,END
```

Example 10:

Like the previous example, this example shows how to use the STOPGTF parameter. This example stops GTF tracing when the instruction at offset 50 into module MYMOD is executed. With ML=100 specified, only 100 trace records are written, after which the SLIP trap is disabled, and all GTF tracing is stopped:

```
SLIP SET,IF,PVTMOD=(MYMOD,50),ACTION=(STOPGTF,TRACE),ML=100,END
```

Example 11:

This example shows how to use the GTFID parameter. In this example, the operator starts two GTF instances HM1 and HM2. When a unit of work takes an abend with code FFFx, the SLIP trap deactivates the instance HM1, leaving HM2 active:

```
START GTFX.HM1
START GTFX.HM2
SLIP SET,C=FFF,A=STOPGTF,GTFID=(HM1),E
```

Example 12:

This example shows how to use the SUBTRAP parameter. When the first instruction in IEFBR14 is executed, a PER interrupt occurs and the SLIP action processor tries to determine whether trap TRP1 is a match. If it matches, a trace record is generated and no further action is taken; otherwise, the SLIP action processor checks whether TRP2 matches:

```
SLIP SET,IF,LPAMOD=(IEFBR14,0),A=SVCD,ID=TRP2,E
SLIP SET,IF,DATA=(1R,EQ,0),A=(SUBTRAP,TRACE),ID=TRP1,E
```

Example 13:

This example shows how to use the MSGID parameter. This trap matches on the command response from the DISPLAY TIME command:

```
IEE136I LOCAL: TIME=16.37.02 DATE=2001.102...
```

where the significant time is hour 16 (meaning the time is between 4:00 and 4:59 p.m.):

```
SLIP SET,MSGID=IEE136I,DATA=(3R?+14,EQ,F1F6),ACTION=WAIT,ML=1,END
```

SLIP command

Example 14:

This example shows how to use 64-bit addresses on the RANGE parameter. It requests a dump when the first above-the-bar page is modified by job TEMP5:

```
SLIP SET,SA,ASIDSA=(SA),RANGE=(1_00000000,+FFF),ACTION=SVCD,JOBNAME=TEMP5,END
```

Example 15:

This example shows how to include a small amount of above-the-bar virtual storage as part of the summary dump capture phase, which is captured synchronously under the unit of work that took the PER interrupt, and a larger portion as part of the non-summary dump phase. Note that there is a limit on the amount of storage that can be captured in the summary dump phase:

```
SLIP SET,IF,PVTMOD=(MYMOD,13E),SUMLIST=(6G!,+FFF),LIST=(1_00000000,2_00000000),END
```

Example 16:

This is an example of a REMOTE LIST, which can be used to dump storage in the address space whose jobname is TEMP5:

```
SLIP SET,IF,PVTMOD=(MYMOD,13E),  
REMOTE=(ACTION=SVCD,LIST=('TEMP5'.1_00000000,2_00000000,100000,+FFF)),  
ACTION=SVCD,END
```

Example 17:

This is an example of using 64-bit operands in the TRDATA keyword. Eight bytes of data are fetched from address 1_00000000; the resulting address is used to fetch another 8 bytes, which is used as the starting address to capture X'10' bytes of storage in a trace buffer:

```
SLIP SET,IF,PVTMOD=(MYMOD,13E),ACTION=TRACE,TRDATA=(1_00000000!,+10),ML=1,END
```

Example 18:

This example shows how to compare data in bits 32–64 of register 6 (the default), but ensures that bits 0–31 of register 6 are zero:

```
SLIP SET,IF,PVTMOD=(MYMOD,1A6),DATA=(1_00100000,EQC,6G),ACTION=WAIT,END
```

Example 19:

This example is similar to the previous example, except that the order of the values specified on EQC is reversed. This SLIP trap compares data in all 8 bytes of register 6 (the default):

```
SLIP SET,IF,PVTMOD=(MYMOD,1A6),DATA=(6G,EQC,1_00100000),ACTION=WAIT,END
```

Example 20:

This example compares four bits of data starting at bit 10 in register 6 with the data at address 1_00101000 starting at bit 10:

```
SLIP SET,IF,PVTMOD=(MYMOD,1B2),DATA=(6G(10),EQC(4),1_00101000),ACTION=WAIT,END
```

Example 21:

This example compares two bits of data starting at bit 2 at the specified address with a constant:

```
SLIP SET,IF,PVTMOD=(MYMOD,1B2),DATA=(1_00101001(2),EQ,10),ACTION=WAIT,END
```

Example 22:

This example stores eight bytes from 1_00000000 into the buffer addressed by register 7:

```
SLIP SET,IF,PVTMOD=(MYMOD,1B2),REFBEFOR=(7G!,EQC(8),1_00000000),
ACTION=(REFBEFOR),END
```

Example 23:

This example moves eight bits starting from bit position 4 at 1_00101000 to bit position 4 of register 6:

```
SLIP SET,IF,PVTMOD=(MYMOD,1B2),REFBEFOR=(6G(4),EQC(8),1_00101000),
ACTION=(REFBEFOR),END
```

Modifying an existing SLIP trap

Use the SLIP MOD command to modify an existing SLIP trap.

Syntax

```
SLIP MOD{,ENABLE | ,DISABLE}{,ALL | ,ID=trapid}{,TXIGD | NOTXIGD}
```

Parameters

MOD

Specifies that the SLIP command modifies one or all existing SLIP traps. This parameter is positional; it must appear following a blank after SLIP.

ENABLE

The specified SLIP trap is to be made active.

Abbreviation: EN

DISABLE

The specified SLIP trap is to be made inactive.

Abbreviation: D

ALL

Every SLIP trap present in the system is to be modified. To find out what SLIP traps are in the system, issue DISPLAY SLIP.

Attention: The ALL parameter is extremely powerful because it modifies the traps of *every* SLIP user *and* the traps the system uses to suppress unnecessary dumps. Issue the SLIP MOD,ENABLE,ALL or SLIP MOD,DISABLE,ALL command only if you understand all its consequences for your system.

ID=trapid

Only the SLIP trap with the identifier *trapid* is to be modified.

Where asterisks (*) replace any or all of the 4 characters of the identifier, all SLIP traps whose IDs match the non-asterisk characters are to be modified. If you specify fewer than 4 characters, the ID is padded on the right with blanks. A matching identifier must have blanks in those positions.

The asterisks allow you to group your SLIP traps by common characters in their IDs and enable and disable them as a group.

TXIGD

SLIP command

NOTXIGD

Transactional Execution Ignore Data. Specifies that if there is a DATA filter, the filter is not to be applied if the event occurred during transactional execution.

Examples

Example 1:

The following SLIP command is used to deactivate the SLIP trap associated with identifier 0024. This SLIP trap can be activated again with the SLIP MOD,ENABLE,ID=0024 command.

```
SLIP MOD,DISABLE,ID=0024
```

Example 2:

Disable all SLIP traps with an identifier having 'A' as the first character and 'B' as the third character.

```
SLIP MOD,DISABLE,ID=A*B*
```

Deleting an existing SLIP trap

Use the SLIP DEL command to delete a SLIP trap.

Syntax

```
SLIP DEL{,ALL | ,ID=trapid}
```

Parameters

DEL

Specifies that the SLIP command remove one or all SLIP traps from the system. This positional parameter must appear following a blank after SLIP.

ALL

Every SLIP trap in the system is to be deleted. To find out what SLIP traps are in the system, issue DISPLAY SLIP.

ID=*trapid*

Only the SLIP trap with the identifier *trapid* is to be deleted.

Note: To delete more than one, but not all SLIP traps, you must enter a separate SLIP DEL command for each ID.

Attention: The ALL parameter is extremely powerful because it deletes both the traps of *every* SLIP user and the traps the system uses to suppress unnecessary dumps. Issue SLIP DEL,ALL, therefore, only if you understand all its consequences for your system.

Example

Use the following SLIP command to delete the SLIP trap with identifier 0008. This SLIP trap cannot be reactivated by a SLIP MOD command.

```
SLIP DEL,ID=0008
```

START command

Use the START command to start started tasks, which support system functions such as IMS, CICS, and RACF. Started tasks are defined in cataloged procedures (residing in procedure libraries) or through jobs residing in a partitioned data set defined in master JCL.

Note: In general, IBM recommends that when you start a subsystem, you make the subsystem name specified in the IEFSSNxx parmlib member the same as that of the member you use from SYS1.PROCLIB. If the names do not match, you may receive error messages when you start the subsystem.

The following figure lists the tasks the START command can perform. Use it as an index to details about particular uses of the command.

Table 67. Summary of the START command

Topic:	Command:
"Starting a system task from a console" on page 882	START <i>membername</i>
"Starting the APPC/MVS address space" on page 886	START APPC
"Starting the APPC/MVS transaction scheduler address space" on page 887	START ASCH
"Starting the Common Event Adapter address space" on page 887	START CEA
"Starting the Generalized Trace Facility" on page 888	START GTF
"Starting IBM Generic Tracker for z/OS" on page 890	START GTZ,SUB=MSTR
"Starting hardware instrumentation services (HIS)" on page 890	START <i>hisproc</i>
"Starting the Base Control Program internal interface (BCPii) address space after BCPii has been terminated" on page 891	START HWISTART
"Starting IBM Health Checker for z/OS" on page 892	START <i>hzsproc</i> ,HZSPRM=PREV
"Starting the library lookaside (LLA) address space" on page 892	START LLA
"Starting the Object Access Method (OAM)" on page 893	START OAM
"Starting Resource Recovery Services (RRS)" on page 893	START RRS
"Starting the System Object Model (SOM) subsystem" on page 895	START SOM
"Starting TSO/VTAM time-sharing" on page 895	START <i>membername</i>
"Starting the virtual lookaside facility or data lookaside facility" on page 897	START VLF or START DLF
"Starting an external writer" on page 898	START XWTR

Syntax

The syntax for each variation of the START command is shown immediately preceding its respective parameter list.

START or S

START command

Note: For any variation of the START command, if you specify *volumeserial* and omit *devicetype* (or *devnum*), you must supply a comma for the missing *devicetype* (or *devnum*). Do not supply any commas, however, after the last parameter you specify.

Starting a system task from a console

Use the START command to start a system task from a console.

Naming Considerations for Started Tasks: The job name or identifier of the started task is important for the following reasons:

- The name or identifier is used on DISPLAY, MODIFY, RESET, CANCEL, FORCE, and STOP commands for the started task
- The job name or identifier is part of the RACF resource name passed to the SAF interface
- The job name and member name are passed to a security product (such as RACF) to give the task a user identification
- The job name is used in SMF records to identify the task.

The job name for a given started task can be assigned based on a variety of inputs. These inputs are examined in the following order, so that if item #1 is not specified, item #2 is used. If neither #1 nor #2 is specified, then #3 is used, and so on.

1. The job name specified in the JOBNAME= parameter of the START command
or
The identifier specified on the START command.
2. The job name specified on the JOB JCL statement within the member.
3. The device number specified on the START command, or the device number associated with the device type specified on the START command
or
The device number associated with the device type specified on the START command.
4. The device number associated with the IEFORDER DD statement within the member.
5. The member name.

IBM recommends that you use the JOBNAME parameter rather than an identifier. If you use the JOBNAME parameter, SMF records, messages, and automated programs can reflect or react to job status; identifiers can only be viewed at a console.

Note: JOBNAME and *identifier* are mutually exclusive; you cannot specify both parameters on the START command.

```
S membername[.identifier]
  [, [devicetype| [/]devnum] [,volumeserial]]
  [,parameters]
  [,JOBNAME=jobname]
  [,JOBACCT=acct_info]
  [,SUB=subsystemname]
  [,REUSASID=YES]
  [,keyword=option[,keyword=option]...]
```

membername

The 1 to 8 character name of a member of a partitioned data set that contains the source JCL for the task to be started. The member may be either a job or a cataloged procedure. The subsystem that selects the job determines which JCL procedure library is called, usually MSTR, JES2 or JES3.

identifier

The name identifying the task to be started. This name can be up to 8 characters long. The first character must be alphabetical. If you omit an identifier and the started task does not have an IEFORDER DD statement, the system uses the job name as the identifier.

If you omit an identifier and the started task has an IEFORDER DD statement, the device allocated to that started task becomes the identifier name.

Note: The system allows multiple started tasks with the same *membername* and *identifier* to execute concurrently.

JOBNAME=jobname

The name that will be assigned to the job.

- If the source JCL is a procedure and you omit the **JOBNAME** keyword, the member name will be assigned as the job name.
- If the source JCL is a job and you omit the **JOBNAME** keyword, the system will use the job name assigned on the JOB statement in the JCL.

If you specify the **JOBNAME** keyword, the member name will be used only to identify the member that contains the JCL for the started task.

If you specify the **JOBNAME** keyword, you cannot specify *identifier*.

JOBACCT=acct_info

An account number, and any other accounting information that your installation requires, such as your department and room number.

The **JOBACCT** parameter specifies accounting data in the JCL JOB statement for the started task. If the source JCL was a job and already specified accounting data, the value specified on the **JOBACCT** parameter overrides the accounting data in the source JCL.

For a detailed description of the accounting information format and syntax rules, see *z/OS MVS JCL Reference*.

The length of *acct_info* cannot exceed 55 characters.

devicetype

The device type of the output device (if any) associated with the task.

Note: *devicetype* and *devnum* are mutually exclusive. You cannot specify both parameters on a START command.

[/]*devnum*

The device number of the device to be started. A device number is 3 or 4 hexadecimal digits. A slash (/) must precede a 4-digit number and is optional before a 3-digit number.

Note: *devnum* and *devicetype* are mutually exclusive. You cannot specify both parameters on a **START** command.

volumeserial

If *devicetype* is a tape or direct access device, the volume serial number of the volume mounted on the device.

START command

parameters

Program parameters passed to the started program. This might be a list in parentheses or a string in single quotation marks. The documentation for the started program should state which of the following techniques the program supports:

- The fourth positional parameter on the START command. The program uses the QEDIT macro to get access to this parameter.
- The **PARM** keyword value. Register 1 at entry to the started program points to it.

If you are starting VTAM, see *z/OS Communications Server: SNA Operation*.

SUB=*subsystemname*

The name of the subsystem that selects the task for processing. The name must be one to four characters, defined in the IEFSSNxx parmlib member, and the subsystem must be active. If **SUB** is not specified, the primary subsystem, as specified in IEFSSNxx, will select the task.

Exception: If the name of the task being started is the same as that of a subsystem, the task will be started under the Master subsystem (MSTR). Then, because the only procedure libraries available to the Master subsystem are those specified in the MSTJCLxx's IEFPSI data set, any procedures being started that are defined in the Job Entry subsystem's PROC00 data set but not in the MSTJCLxx data set, will be unavailable and will therefore not be found; the system will issue message IEFC612I.

When the task being started is a subsystem and you omit **SUB**, it is started under the master subsystem (MSTR) unless the subsystem itself asks to start under the Job Entry subsystem or the SSCTUPSS bit in the subsystem's SSCVT is on.

When you specify **SUB**, you override the subsystem's request as to the subsystem under which the task should be started.

Note: Do not specify SUB=MSTR unless the program specifically documents that it is supported. Using SUB=MSTR in a situation where it is not supported will have ramifications on the proper execution of the program.

REUSASID=YES

When REUSASID=YES is specified on the **START** command and REUSASID(YES) is specified in the DIAGxx parmlib member, a reusable ASID is assigned to the address space created by the **START** command. If REUSASID=YES is not specified on the **START** command or REUSASID(NO) is specified in DIAGxx, an ordinary ASID is assigned.

You can use REUSASID=YES for address spaces that result in message IEF352I ADDRESS SPACE UNAVAILABLE when they terminate. Before specifying REUSASID=YES, ensure that the program being started supports running with a reusable ASID. Otherwise, specifying REUSASID=YES might result in system abend S0D3. For more information about reusing ASIDs, see *z/OS MVS Programming: Extended Addressability Guide*.

keyword=option

Any appropriate keyword parameter you specify to override the corresponding parameter in the cataloged procedure. The maximum length of each *keyword=option* is 66 characters. No individual value within this field may be longer than 44 characters in length. You can specify:

- JCL JOB statement keyword parameters, to modify the JOB statement for the started task

- JCL EXEC statement keyword parameters, to override EXEC statements in the procedure being started (if the target of the START command is a procedure)
- JCL DD statement keyword parameters, to modify the IEFORDER DD statement (if it exists)
- JCL symbol names, to provide values for use in the started task

Parameters on JOB Statements

JOB statement keyword parameters are accepted for both started jobs and started procedures. For started jobs, the keyword specified on the **START** command overrides or nullifies the corresponding keyword in the source JCL.

You can specify the following job-level keywords:

- **ADDRSPC**
- **BYTES**
- **CARDS**
- **COND**
- **JESLOG**
- **LINES**
- **MSGCLASS**
- **MSGLEVEL**
- **NOTIFY**
- **PAGES**
- **PERFORM**
- **PRTY**
- **REGION**
- **TIME**

You *cannot* specify the following job-level keywords, unless you code them with no values (to nullify the same keywords in the source JCL):

- **USER**
- **GROUP**
- **PASSWORD**
- **RESTART**
- **SECLABEL**
- **SYSAFF**
- **SYSTEM**
- **TYPRUN**

The system ignores the following keywords when they are specified on the START command, unless you code them with no values (to nullify the same keywords in the source JCL):

- **RD**
- **CLASS**

Note: For a started task:

- In a JES2 environment the system ignores the **CLASS** keyword.
- In a JES3 environment the system ignores all **CLASS** related attributes and functions except for device fencing, SPOOL partitioning, and track group

START command

allocation. For more information about **CLASS** attributes and functions, see *z/OS JES3 Initialization and Tuning Guide*.

Parameters on EXEC Statements

EXEC statement keywords that have the same name as JOB statement keywords (for example, **COND**, **REGION**, and **TIME**), are treated as JOB statement keywords.

Note:

1. If you specify an option that must have lower case characters, enclose it within apostrophes.
2. If you specify an option within apostrophes, for example, 'DUMMY', use the correct case letters within the apostrophes. **START** command processing does not convert lower case characters to uppercase. Thus, entering lower case letters might cause a JCL error or an abend. Similarly, entering upper case letters where lower case is required (in z/OS UNIX System Services, for example) may cause incorrect results.
3. If you are overriding a data set name in the cataloged procedure and the name of the data set is 44 characters long, use *DSN=name*. If you specify *DSNAME=name*, the **START** procedure stops and returns message IEF640I.
4. If you need information on started task considerations or use of overrides and symbols, see *z/OS MVS JCL Reference*.

Example 1

To start JES2, enter:

```
S jes2
```

Example 2

To start JES2 with a job name of JES2 from a procedure named JESNOW, with an account number and other accounting information, enter:

```
S JESNOW,JOBNAME=JES2,JOBACCT=(D548-8686,'12/8/85',PGMBIN)
```

Starting the APPC/MVS address space

Use the **START APPC** command to start the Advanced Program-to-Program Communication/MVS (APPC/MVS) address space.

```
S APPC,SUB=MSTR[,APPC=(nn[,nn]...[,L])]
```

The parameters are:

APPC, SUB=MSTR

Invokes the APPC/MVS procedure and creates the APPC/MVS address space.

APPC=

Indicates which APPCPMxx parmlib members APPC/MVS is to use. The default member is APPCPM00. If you specify only one parmlib member, you do not need to enter the parentheses.

The APPCPMxx members can reside in SYS1.PARMLIB or any other parmlib data set that is specified on an //IEFPARM DD statement in the master scheduler JCL. However, APPC/MVS cannot process data sets specified in the

master scheduler JCL until the operator enters a SET APPC command. For information about how to specify configuration information in a parmlib data set other than SYS1.PARMLIB, see the description of starting APPC and ASCH in *z/OS MVS Planning: APPC/MVS Management*.

- L The system will display parmlib statements on the operator's console as it processes them.

Example 1:

START the APPC/MVS address space with parmlib member APPCPM00.
S APPC,SUB=MSTR

Example 2:

START the APPC/MVS address space with parmlib member APPCPM01.
S APPC,SUB=MSTR,APPC=01

Example 3:

START the APPC/MVS address space with parmlib members APPCPM03 and APPCPM06, and list the parmlib statements as the system processes them.
S APPC,SUB=MSTR,APPC=(03,06,L)

Starting the APPC/MVS transaction scheduler address space

Use the START ASCH command to start the ASCH (APPC/MVS transaction scheduler) address space.

```
S ASCH,SUB=MSTR[,ASCH=(nn[,nn]...[,L])]
```

The parameters are:

ASCH, SUB=MSTR

Invokes the ASCH procedure and creates the ASCH address space.

ASCH=

Indicates which ASCHPMxx parmlib members APPC/MVS is to use. The default member is ASCHPM00. If you specify only one parmlib member, you do not need to enter the parentheses.

The ASCHPMxx members can reside in SYS1.PARMLIB or any other parmlib data set that is specified on an //IEFPARM DD statement in the master scheduler JCL. However, APPC/MVS cannot process data sets specified in the master scheduler JCL until the operator enters a SET ASCH command. For information about how to specify configuration information in a parmlib data set other than SYS1.PARMLIB, see the description of starting APPC and ASCH in *z/OS MVS Planning: APPC/MVS Management*.

- L The system will display the parmlib statements on the operator's console as it processes them.

Starting the Common Event Adapter address space

Common Event Adapter (CEA) address space is started automatically during system initialization.

START command

If the CEA address space terminates, all clients are disconnected and all subscriptions are unsubscribed.

After the CEA address space is restarted:

- The CEA address space becomes operational.
- New connections with clients are accepted.
- Subscription requests are honored.
- Callers need to reconnect and re-subscribe.

```
S CEA
```

There are no parameters.

Example:

To start CEA, enter:

```
S CEA
```

After the initialization is complete, the system returns the following information:
CEA0102I COMMON EVENT ADAPTER INITIALIZATION COMPLETE.

Starting the Generalized Trace Facility

Use the START GTF command to start the generalized trace facility.

```
S {GTF|membername}[.identifier][,devicetype|,[/]devnum][,volumeserial]
  ([,MODE={INT|DEFER|EXT}][,TIME=YES][,DEBUG=YES]
  [,BLOK={numpages|nnnk|nnM}][,MEMBER=xxxxxxx][,REGION=nnnnK]
  [,{SADMP|SA}={nnM|nnnk}][,{SDUMP|SD}={nnM|nnnk}][,
  [,{NOPROMPT|NP}][,{ABDUMP|AB}={nnM|nnnk}])
  [,keyword=option[,keyword=option]...]
```

The parameters are:

GTF

The name of the IBM-supplied cataloged procedure that invokes GTF.

membername

The name of the member that contains the source JCL that invokes GTF. The source JCL can be either a cataloged procedure (for example, residing in SYS1.PROCLIB) or a job residing in a partitioned data set. The name can be either the IBM-assigned name (GTF) or a user-assigned name.

identifier

The user-determined name identifying this specific GTF session. If you omit an identifier, the system automatically uses the job name as the identifier.

devicetype

The device type, such as 3211, of the writer to be started. The device type provided in the IBM-supplied cataloged procedure for GTF is used unless overridden by this command.

Note: *devicetype* and *devnum* are mutually exclusive.

[/]devnum

The device number of the writer to be started. A device number is 3 or 4 hexadecimal digits. A slash (/) must precede a 4-digit number and is optional before a 3-digit number.

Note: *devicetype* and *devnum* are mutually exclusive.

volumeserial

The serial number of a magnetic tape or direct access volume to receive the trace data.

MODE=INT

Trace data is to be maintained in the GTF address space.

MODE=DEFER

Trace data is to be maintained in the GTF address space until the operator enters STOP GTF. Then, during end processing GTF will transfer the data from its address space to the output data set.

MODE=EXT

Trace data is to be maintained in an external data set.

BLOK=

Reserves common storage buffers to collect GTF data.

nnnK or nnM

The decimal number for the amount of storage in kilobytes(K) or megabytes(M). The minimum amount, also the default amount, is 40K.

numpages

The decimal number for the amount of 4096-byte pages of storage.

TIME=YES

Each logical trace record is to be time-stamped. If this parameter is omitted, individual records will be time-stamped. TIME=NO is not supported.

DEBUG=YES

GTF stops whenever an error is encountered while a trace record is being created. If this parameter is not specified, GTF attempts to recover from the error condition but might not be able to record future events of the same type.

MEMBER=xxxxxxx

The parmlib member to be accessed by this invocation of GTF. If this parameter is omitted, GTFPARM is used.

REGION=nnnnK

The maximum size of the GTF address space in bytes. You can specify any number from 832K to 2880K.

keyword=option

Any appropriate keyword specified to override the corresponding parameter in the cataloged procedure. The maximum length of each keyword=option is 66 characters. No individual value within this field may be longer than 44 characters in length. If you are overriding a symbolic parameter, do not use any of the DD keywords. For example, do not use UNIT= to override the devicetype positional parameter in the cataloged procedure.

SADMP= or SA={nnnK or nnM}

The number of bytes of GTF data that will appear in a stand alone dump. The default is 40K.

START command

SDUMP= or SD={nnnK or nnM}

The number of bytes of GTF data that will appear in an SVC dump (SDUMP). The default is 40K.

NOPROMPT or NP

If specified, indicates that the operator will not be prompted to specify trace options. Message AHL125A and AHL100A will not be issued. Use this parameter when you have a parmlib member set up with the desired GTF options and you want to avoid multiple replies in a sysplex environment.

ABDUMP= or AB={nnnK or nnM}

The number of bytes of GTF data that will appear in a SNAP or ABEND dump. The default is 0 K, which means that no GTF output data will appear in a SNAP or ABEND dump.

Example 1:

This example starts a GTF session with the identifier EXAMPLE and with trace data maintained in the GTF address space. The DSN keyword is entered to override a symbolic parameter defined in the cataloged procedure.

```
S GTF.EXAMPLE,,(MODE=INT),DSN=NULLFILE
```

Example 2:

This example starts a GTF session with the trace data recorded on an external device. Because it is not apparent which is the GTF recording device, you have to display active jobs with the D A,LIST command before you can stop GTF. The GTF session started in this example could run in an address space of a maximum of one megabyte.

```
S GTF,,(MODE=EXT),REGION=1000k
```

Starting IBM Generic Tracker for z/OS

Use the START GTZ command to start the generalized tracking facility, IBM Generic Tracker for z/OS.

The syntax is:

```
S GTZ,SUB=MSTR
```

The parameters are:

GTZ, SUB=MSTR

Invokes the GTZ procedure that starts the tracking facility.

Starting hardware instrumentation services (HIS)

For IBM System z10 or later machines, use the START *hisproc* command to:

- Start the hardware instrumentation services (HIS) address space
- Create a new instrumentation started task, *hisproc*

Hardware instrumentation services (HIS) is a function that collects hardware event data for processors in SMF records type 113, as well as a z/OS UNIX System Services output files. You can only use HIS for IBM System z10 or later machines.

You must start the HIS address space on each system where you want to collect data. Then you must configure and activate the HIS Profiler (hardware event counters and sampling facilities) for each system by issuing the MODIFY *hisproc*, BEGIN command. See the following references:

- “Setting up hardware event data collection” on page 40 for more information about setting up hardware event data collection services.
- “Starting, configuring, and stopping hardware event data collection” on page 561 for information about the MODIFY *hisproc* command.

Note that it is important to assign a sufficiently high dispatch priority to the instrumentation started task *hisproc*. This will allow the HIS Profiler to write the sampling data to the .SMP output files in a timely manner.

```
S hisproc
```

The parameters are:

hisproc

The name of the HIS catalogued startup procedure. You can use the HIS member in PROCLIB as your *hisproc* procedure.

Example:

To start the HIS address space, enter:

```
S hisproc
```

After the initialization is complete, the system returns the following message:

```
HIS002I hisproc INITIALIZATION COMPLETE
```

Starting the Base Control Program internal interface (BCPii) address space after BCPii has been terminated

Use the START HWISTART command to restart the base control program internal interface (BCPii) address space after the operator stops or cancels the HWIBCPII address space, or after the address space terminates on its own. The system restarts the HWIBCPII address space and all BCPii interfaces become available. The system then issues event notification facility (ENF) signal 68 to signal that BCPii APIs can now be issued. See Base Control Program internal interface (BCPii) services in *z/OS MVS Programming: Callable Services for High-Level Languages*.

The name of the cataloged procedure that IBM supplies in SYS1.PROCLIB for starting the BCPii address space is HWISTART.

```
S HWISTART
```

The parameter is:

HWISTART

The name of the IBM-supplied cataloged procedure that calls BCPii.

See “Stopping the Base Control Program internal interface (BCPii) address space” on page 903 for information about the STOP HWIBCPII command.

START command

Starting IBM Health Checker for z/OS

Use the `START hzsproc` command to start IBM Health Checker for z/OS.

Although IBM Health Checker for z/OS starts automatically when you start z/OS, you can still manually stop and start IBM Health Checker for z/OS, such as to apply service.

Use the following syntax to start or restart IBM Health Checker for z/OS:

```
S hzsproc[,HZSPRM={PREV|SYSPARM|NONE|xx|(xx,...,zz)}]
```

The parameters are:

hzsproc

The name of the started procedure used to start IBM Health Checker for z/OS. The default procedure ships with the name HZSPROC.

HZSPRM=PREV

Specifies that your *hzsproc* procedure is to use the HZSPRMxx suffixes, if any, that were used by the previous instance of IBM Health Checker for z/OS within the current IPL. HZSPRM=PREV is used as the default in the standard HZSPROC procedure. HZSPRM=PREV behaves like HZSPRM=SYSPARM when the system encounters it at initial IPL time (the first use of the *hzsproc* procedure) because there is no previous instance of IBM Health Checker for z/OS to use at that time.

HZSPRM=SYSPARM

Specifies that your *hzsproc* procedure is to use the HZSPRMxx suffixes specified on the HZS system parameter in the IEASYSxx member of parmlib.

HZSPRM=NONE

Specifies that the *hzsproc* procedure is to use no HZSPRMxx parmlib members.

HZSPRM={xx|(xx...zz)}

Specifies that one or more specific suffixes for the HZSPRMxx parmlib members that you want the *hzsproc* procedure to use.

Starting the library lookaside (LLA) address space

Use the `START LLA` command to start the LLA address space.

```
S LLA[,SUB=MSTR][,REUSASID=YES][,LLA=xx]
```

The parameters are:

LLA

Invokes the LLA procedure and creates the LLA address space.

The `START LLA` command is initially issued by the system from the logical parmlib member IEACMD00. Use this command if LLA stops, either because of an error or as a result of a `STOP LLA` command.

SUB=MSTR

Indicates that the master subsystem will process the task. If you omit this

parameter, the system issues message CSV209I indicating that the request to start LLA is ended and the system re-issues the command with SUB=MSTR.

REUSASID=YES

Indicates that a reusable ASID should be assigned to the LLA address space.

LLA=xx

Indicates which CSVLLAnn parmlib member LLA is to use. If you do not supply a CSVLLAxx member by the LLA=xx parameter of the LLA procedure on the first starting of LLA for this IPL, or if you specify a parameter of LLA=NONE, LLA will, by default, manage only the libraries that are accessed through the LNKST concatenation. If you have started LLA successfully with a CSVLLAxx member and then stop LLA, a subsequent start of LLA will use that CSVLLAxx member unless you supply another CSVLLAxx member. If you want to get back to the default settings, specify LLA=NONE in a subsequent start of LLA.

Note:

1. System performance is degraded if LLA stops.
2. LLA provides better performance when VLF services are available, so it is better (although not necessary) to start VLF before starting LLA. However, the operation of LLA does not depend upon VLF.
3. Place the S LLA and S VLF commands in either the IEACMD00 or COMMANDxx members of the logical parmlib data set.
4. If F LLA, UPDATE=xx command is done in between start and stop, the update is not honored by the restarted LLA which is brought up without specifying LLA=xx.

Starting the Object Access Method (OAM)

Use the START OAM to start the object access method.

```
S {OAM|membername}[.identifier][,OAM=xx][,environment-dependent parameters]
```

The START OAM command has environment-dependent parameters that vary depending on whether OAM is supporting only a tape library or is also storing and managing objects in the OAM storage hierarchy. For a detailed discussion of the START OAM command and the parameters valid in each environment, refer to the *z/OS DFSMS OAM Planning, Installation, and Storage Administration Guide for Object Support*, and *z/OS DFSMS OAM Planning, Installation, and Storage Administration Guide for Tape Libraries*.

Starting Resource Recovery Services (RRS)

Use the START RRS command to start resource recovery services (RRS). To start RRS during system initialization, add a START RRS command to the COMMNDxx parmlib member.

Before you can start RRS, your installation must have defined RRS as a subsystem in the IEFSSNxx parmlib member. For RRS to process requests for resources, system logger must be active.

The name of the cataloged procedure that IBM supplies in SYS1.SAMPLIB for starting the RRS subsystem is ATRRRS. Your installation should copy SYS1.SAMPLIB(ATRRRS) to SYS1.PROCLIB(RRS). If your installation replaces

START command

membername RRS with its own procedure for starting RRS, it should ensure that the name of its procedure matches the name of the subsystem specified in the IEFSSNxx parmlib member it uses. Otherwise, you may receive error messages when you start the subsystem.

You can **cold start** RRS/MVS when the RRS resource manager data log is empty. Cold start processing clears all active log streams except the RRS archive log, which is never cleared.

When the RRS data log contains resource manager data you can **warm start** RRS/MVS. Warm start processing restores the status of all incomplete backout or commit requests.

Only one copy of RRS can be running on a system. The system will reject an attempt to start a second RRS, even if you specify a different procedure as the first parameter of the START command.

```
S RRS |membername[,CTMEM=CTnRRSxx] [,GNAME=1grpname] [,JOBNAME=jobname]
```

The parameters are:

RRS |membername

Invokes the RRS procedure and creates the RRS address space. If your installation has created a different procedure for starting RRS, use the member name of your procedure.

CTMEM=CTnRRSxx

Identifies the CTnRRSxx parmlib member that contains the options RRS component trace is to use when RRS starts the trace. If you omit this optional parameter, RRS traces only unexpected events until a time when the TRACE CT command specifies different trace options.

GNAME=1grpname

Specifies the log group name. A log group is a group of systems that share an RRS workload. Specify a value if your installation has multiple RRS workloads. Otherwise, the name defaults to the sysplex name. If you specify a name, it must be 1-8 characters long. The first character must be alphabetic or one of the national characters (\$, #, or @), while the remaining characters may be alphanumeric or \$, #, or @.

You can find additional information about RRS logging in *z/OS MVS Programming: Resource Recovery*.

JOBNAME=jobname

Specifies the subsystem name defined in the IEFSSNxx parmlib member corresponding to RRS. The issuer of FORCE jobname,ARM must use this name to bring RRS down, if that proves necessary. If you omit this parameter, the system uses the started JCL procedure name.

Example:

The following example starts RRS with the CTWRRS01 parmlib member:

```
START RRS,JOBNAME=RRS,CTMEM=CTWRRS01
```

Starting the System Object Model (SOM) subsystem

Use the START SOM command to start the distributed system object model (SOM) subsystem. This is the extension to the SOMobjects® product that allows programs to communicate with objects in other processes that reside in other address spaces or on other systems. Your installation may place this command in a COMMNDxx member of the logical parmlib data set.

Note: You must activate the OMVS address space before you issue a START SOM command. See "Configuring Your SOMobjects Environment" in *SOMobjects Configuration and Administration Guide*, GC28-1851, for more information on what things you must do before starting SOM.

```
S {SOM | procedure-name} [,SUB={MSTR,JES2,JES3}]
```

The parameters are:

SOM

The name for the SOM subsystem. It corresponds to the cataloged procedure in SYS1.PROCLIB that starts SOM.

procedure_name

Your installation's name for the SOM subsystem. The name must correspond to a procedure cataloged in SYS1.PROCLIB or to a data set concatenated to SYS1.PROCLIB. IBM recommends that an installation use the name **SOM**. If your installation uses a different name, that name must be one to four characters long, begin with an alphabetic character (A-Z), contain only alphanumeric characters (A-Z or 0-9), and not conflict with any other subsystem name in the same system, or with the name of any system command.

SUB=*subsystem name*

Specifies the subsystem you designate to process the task, such as MSTR (the master subsystem) or JES2 or JES3 to specify that subsystem's scheduler. (Make sure to send all your output to a data set if you specify MSTR.)

If you omit this parameter, the JES subsystem scheduler starts SOM. The resulting dependency on JES requires SOM to be stopped when stopping JES.

Example:

The following command starts the SOM subsystem:

```
S SOM
```

Starting TSO/VTAM time-sharing

Use the START command to start TSO once VTAM is active. This command creates the terminal control address space (TCAS), which accepts requests by terminal users for logon to TSO.

```
S membername[.identifier][,devicetype|,[/]devnum]
   [,volumeserial][([,MEMBER={name|nn}][,USERMAX=nnnnn]
   [,GNAME=[name|NONE]])]
   [,keyword=option[,keyword=option]...]
```

START command

The parameters are:

membername

The name of the member that contains the source JCL for the started task. The member can be a cataloged procedure (for example, residing in SYS1.PROCLIB) or a job that starts TSO/VTAM time-sharing. Many installations use TCAS as the membername.

identifier

The user-determined name identifying this specific time-sharing session. If you omit an identifier, the system automatically uses the job name as the identifier.

devicetype

The device type of an output device where time-sharing parameters from SYS1.PARMLIB are listed. This operand is useful only if the PRINTOUT DD statement of the cataloged procedure invoked by the START command specifies DDNAME=IEFRDER. If the PRINTOUT DD statement specifies a SYSOUT device, the parameter values are listed on that device.

Note: *devicetype* and *devnum* are mutually exclusive.

[/]devnum

The device number of an output device where time-sharing parameters from SYS1.PARMLIB are listed. A device number is 3 or 4 hexadecimal digits. A slash (/) must precede a 4-digit number and is optional before a 3-digit number.

Note: *devicetype* and *devnum* are mutually exclusive.

volumeserial

If *devicetype* is a tape or direct access device, the volume serial number of the volume mounted on the device.

MEMBER=name

The name of the member in Parmlib that contains TSO/VTAM time-sharing parameters.

MEMBER=nn

A two-digit decimal number that forms the suffix for specifying the name of the member in Parmlib that contains TSO/VTAM time-sharing parameters, where the name has the form TSOKEYnn.

USERMAX=nnnnn

The maximum number (0 to 32,767) of users that can be logged on to TSO/VTAM time-sharing at any one time. If USERMAX is not specified here or in the parmlib member that contains TSO/VTAM time-sharing parameters, a value of 40 is used.

GNAME=name

The generic resource name for TSO/VTAM to use while operating in a sysplex environment. You may specify this keyword only when TSO/VTAM is operating within a sysplex.

GNAME=NONE

Specifies that TSO/VTAM will not use a generic resource name. If you specify this value on the START command, the system will ignore any GNAME value in the TSOKEY00 parmlib member.

keyword=option

Any appropriate keyword specified to override the corresponding parameter in the cataloged procedure. The maximum length of each keyword=option is 66

characters. No individual value within this field may be longer than 44 characters in length. If you are overriding a symbolic parameter, do not use any of the DD keywords. For example, do not use UNIT= to override the device type positional parameter in the cataloged procedure.

If more than one Parmlib name is specified, or if no name is specified, the order of priorities that determines which time-sharing parameters are used is:

1. The member name coded on the PARMLIB DD statement.
2. The MEMBER operand of the START command.
3. The keyword operand of the START command.
4. The default member TSOKEY00 if a member is not specified but a Parmlib (that contains TSOKEY00) is.
5. The default values in the TCAS program if neither a member nor a parmlib is specified.

Starting the virtual lookaside facility or data lookaside facility

Use the START VLF command to start the virtual lookaside facility (VLF) and the START DLF command to start data lookaside facility (DLF). VLF is an MVS service that enables applications to minimize I/O operations for frequently retrieved objects. DLF is an MVS service that provides the capability for multiple jobs to share access to large data objects in storage. It enables QSAM and VSAM applications to minimize I/O operations.

VLF and DLF will not start if already active on the system; the START command will be rejected. Also, they will not start if the parmlib is not allocated to the appropriate started task; if the specified parmlib member is not found, or is empty; or if there is no valid class found in the specified parmlib member.

```
S {VLF|DLF},SUB=MSTR[,REUSASID=YES][,NN=xx]
```

The parameters are:

VLF, SUB=MSTR

Invokes the VLF procedure that starts the virtual lookaside facility (VLF).

DLF, SUB=MSTR

Invokes the DLF procedure that starts DLF.

REUSASID=YES

Indicates that a reusable ASID should be assigned to the VLF or DLF address space.

NN=xx

Indicates that the system is to start VLF using the COFVLFxx member of the logical parmlib or that the system is to start DLF using the COFDLFxx member of the logical parmlib. In each case, replace xx with two alphanumeric characters that match the suffix of the parmlib member.

If you do not identify a parmlib member, VLF uses the COFVLF00 default parmlib member and DLF uses the COFDLF00 default parmlib member. See *z/OS MVS Initialization and Tuning Reference* for more information about the use of the COFVLFxx or COFDLFxx member.

Starting an external writer

Use the START XWTR command to start an external writer.

```
S {XWTR|membername} [.identifier] [,devicetype|, [/]devnum  
  [,volumeserial] [,classes] [,keyword=option[,keyword=option]...]
```

The parameters are:

XWTR

The name of the IBM-supplied cataloged procedure that invokes the external writer.

membername

The name of the member that contains the source JCL that starts and defines the external writer. The member can contain a cataloged procedure (for example, residing in SYS1.PROCLIB) or a job residing in a partitioned data set. The name can be either the IBM-assigned name (XWTR) or a user-assigned name.

identifier

The identifier of the writer to be started. This name consists of up to eight characters. The first one must be alphabetical. If you do not assign an identifier, the system uses the device number of the device allocated to the writer as the identifier.

devicetype

The device type, such as 3211, of the writer to be started.

Note: *devicetype* and *devnum* are mutually exclusive.

[/]*devnum*

The device number of the writer to be started. A device number is 3 or 4 hexadecimal digits. A slash (/) must precede a 4-digit number and is optional before a 3-digit number.

Note: *devicetype* and *devnum* are mutually exclusive.

volumeserial

The serial number, up to six characters, of the magnetic tape or direct access volume the writer is to use.

classes

The output classes, in priority sequence, the writer is to process. You can specify up to eight output classes, naming them in sequence without separating them by commas.

keyword=option

Any appropriate keyword specified to override the corresponding keyword in the cataloged procedure. The maximum length of each keyword=option is 66 characters. No individual value within this field may be longer than 44 characters in length. If you are overriding a symbolic parameter, do not use any of the DD keywords. For example, do not use UNIT= to override the devicetype positional parameter in the cataloged procedure.

Example:

To start an external writer with the identifier A, enter:

STOP command

Use the STOP command to stop system functions and jobs in execution. Note that you can communicate with the currently running program only if it was designed to recognize the STOP command. If the program does not recognize the STOP command, MVS issues message IEE342I STOP REJECTED--TASK BUSY.

Note to Programmers: For more information, see the section on communicating with a program using EXTRACT and QEDIT in *z/OS MVS Programming: Authorized Assembler Services Guide*.

The following figure lists tasks the STOP command can perform. Use it as an index to details about particular uses of the command.

Table 68. Summary of the STOP Command

Topic:	Command:
"Stopping a running program"	STOP jobname.identifier
"Stopping an ASCH initiator" on page 902	STOP ASCHINT
"Stopping the data lookaside facility (DLF)" on page 902	STOP DLF
"Stopping the generalized tracking facility" on page 903	STOP GTZ
"Stopping the hardware instrumentation services (HIS)" on page 903	STOP <i>hisproc</i>
"Stopping the Base Control Program internal interface (BCPii) address space" on page 903	STOP HWIBCPII
"Stopping IBM Health Checker for z/OS" on page 904	STOP <i>hzsproc</i>
"Stopping the library lookaside (LLA) address space" on page 904	STOP LLA
"Stopping the Object Access Method (OAM) Address Space" on page 905	STOP OAM
"Stopping a System Object Model (SOM)" on page 905	STOP SOM
"Stopping a temporary file system (TFS)" on page 905	STOP TFS
"Stopping the virtual lookaside facility (VLF)" on page 906	STOP VLF

Syntax

The syntax for each variation of the STOP command is shown immediately preceding its respective parameter list.

STOP or P

Stopping a running program

You can use the STOP command to stop a running program when that program was designed to listen for the STOP command. If the program does not recognize the input specified on the STOP command, MVS issues message IEE342I STOP REJECTED--TASK BUSY.

Note to Programmers: For more information, see the section on communicating with a program using EXTRACT and QEDIT in *z/OS MVS Programming: Authorized Assembler Services Guide*.

STOP command

```
P [jobname.]identifier[,A=asid]
```

Parameters

The parameters are:

jobname

The name of the batch job, started task, or APPC/MVS transaction program to be stopped.

The job name for a given started task can be assigned based on a variety of inputs. These inputs are examined in the following order, so that if item #1 is not specified, item #2 is used. If neither #1 nor #2 is specified, then #3 is used, and so on.

1. The jobname specified in the JOBNAME= parameter of the START command
or
The identifier specified on the START command.
2. The jobname specified on the JOB JCL statement within the member.
3. The device number specified on the START command, or the device number associated with the device type specified on the START command
or
The device number associated with the device type specified on the START command.
4. The device number associated with the IEFRDER DD statement within the member.
5. The member name.

identifier

The identifier assigned to the job or address space. (Refer to “Displaying started task status” on page 353 for information about determining the jobname and identifier of currently active address spaces.)

The following types of identifiers can be used:

- The identifier that was specified on the START command.
- *[/]*devnum**, the device number specified on the START or MOUNT command. A device number is 3 or 4 hexadecimal digits, optionally preceded by a slash (/). You can precede the device number with a slash to prevent ambiguity between the device number and a device type or identifier.
- *devicetype*, the type of device specified when the START or MOUNT command was issued.

If no identifier was specified, the identifier “STARTING” is temporarily assigned until the system can assign another according to the following order of precedence:

1. If an identifier was not specified on the START command, the identifier is the device type (for example, 3410) or device number (for example, X'0000') specified on the START or MOUNT command.
2. If an identifier, a device type, or a device number was not specified on the START or MOUNT command, the identifier is the device type specified on an IEFRDER DD statement (invoking a cataloged procedure) in the JCL.
3. If none of these was specified, the identifier defaults to the job name.

When (and only when) you specify *jobname* with *identifier*, the identifier can be represented by any of the following:

- An asterisk
- One or more characters from the beginning of the identifier,
- The entire identifier

When you use the asterisk format, the command takes effect on *all* address spaces that begin with the specified characters. Device numbers are assumed to be 4-digit numbers; for example, */13** would match on **1301**, **1302**, and so on, but would not match on **13C**.

Specifying both the job name and the entire identifier causes the command to take effect on *all* the work units running with that combination of job name and identifier. If you are uncertain of an identifier or device number:

- Use the DISPLAY A,LIST command to display active jobs
- Use the DISPLAY ASCH,A command to display active TP jobnames.
- Use the DISPLAY A,A command to display active initiator address spaces.

A=asid

The address space identifier, in hexadecimal, of the job, started task, writer, transaction program, or initiator address space to be stopped.

If you issue a STOP command with a non-unique identifier, device name, or device type, multiple tasks might be stopped. To make sure that the STOP command stops only one task, add a unique job name to the START command membername; use that same unique job name on the STOP command.

If you enter the STOP command and one or more terminals are still active, you are asked to respond to the following message:

```
* id IKT010D nn USERS ACTIVE - REPLY 'SIC' or 'FSTOP'
```

Reply *'*SIC'* to cancel the active users normally. This reply allows them to receive any messages queued for them, and it allows TSO/VTAM to perform its normal termination processing. Reply *'FSTOP'* to force immediate cancellation of the active users. The users do not receive any messages queued for them, and TSO/VTAM does not perform its normal termination processing (that is, task resource manager processing is bypassed). Use FSTOP only if 'SIC' is ineffective.

Example 1:

If the job SYSDA has been written to accept a STOP command, it stops. Otherwise, the following command has no effect.

```
P SYSDA
```

Example 2:

To stop writer 00E after it processes the current data set, enter:

```
P XWTR.00E
```

or

```
P 00E
```

Example 3:

To stop the GTF session started with an identifier of ABCD, enter:

STOP command

```
P ABCD
```

Example 4:

To stop writer ABCD after it processes the current data set, enter:

```
P XWTR./ABCD
```

or

```
P /ABCD
```

Example 5:

To stop the GTF session with an identifier of EXAMPLE, enter:

```
P EXAMPLE
```

Stopping an ASCH initiator

Use the following form of the STOP command to stop an ASCH initiator.

```
P {ASCHINT,A=asid}
```

ASCHINT,A=asid

ASCHINT is the generic name for the ASCH initiator and A=asid is the address space identifier, in hexadecimal, of the ASCH initiator to be stopped.

Example:

To stop the ASCH initiator address space, whose asid is E, enter:

```
P ASCHINT,A=E
```

Stopping the data lookaside facility (DLF)

Use the STOP DLF command to stop the data lookaside facility (DLF). Before entering STOP DLF, you must enter the MODIFY DLF,MODE=DRAIN or QUIESCE command.

```
P DLF
```

The parameter is:

DLF

The job name assigned to the data lookaside facility (DLF) address space. Using this parameter will stop DLF as soon as all DLF objects are disconnected for all users.

This command activates the address space termination process. You can use the MODIFY DLF,MODE=NORMAL command to end the DLF shutdown process. To restart DLF after the shutdown process has completed, you can use the START DLF command.

Stopping the generalized tracking facility

Use the following form of the STOP command to stop the generalized tracking facility. Before stopping the tracking facility, consider extracting any recorded tracking data for later analysis by using the GTZPRINT utility, the DISPLAY GTZ command, or a program using the GTZQUERY service.

```
P GTZ
```

The parameter is:

GTZ

Specifies that you want to stop the generic tracking facility.

Stopping the hardware instrumentation services (HIS)

For IBM System z10 or later machines, use the STOP *hisproc* command to:

- Stop the hardware instrumentation services (HIS) address space
- Stop an active hardware event data collection run by terminating the HIS started task, *hisproc*

To begin a hardware event data collection run after you have issued the STOP *hisproc* command, you must restart the HIS address space by issuing the START *hisproc* command and then start collection using the F *hisproc*, BEGIN command. See “Starting, configuring, and stopping hardware event data collection” on page 561.

```
P hisproc
```

The parameters are:

hisproc

The name of the HIS catalogued startup procedure.

Example:

To stop the HIS address space and an active hardware event data collection run, enter:

```
P hisproc
```

When you enter the STOP *hisproc* command, the system displays the following message:

```
HIS012I hisproc DATA COLLECTION ENDED
```

Stopping the Base Control Program internal interface (BCPii) address space

Use the STOP HWIBCPII command to shut down the Base Control Program internal interface (BCPii) address space. You may choose to issue this command to stop BCPii for maintenance updates or repeated failures of BCPii services. The system stops the HWIBCPII address space, and BCPii interfaces are no longer available.

STOP command

After the STOP HWIBCPPII command has been issued, address space cleanup begins. The system will issue event notification facility (ENF) signal 68 to communicate when BCPii is no longer available. The system also cleans up all currently running BCPii work, and does not honor any subsequent BCPii API calls.

```
P HWIBCPPII
```

The parameter is:

HWIBCPPII

The name of the BCPii address space.

See the following references for additional BCPii information:

- “Starting the Base Control Program internal interface (BCPii) address space after BCPii has been terminated” on page 891 for information about the START HWISTART command that restarts the BCPii address space.
- Base Control Program internal interface (BCPii) services in *z/OS MVS Programming: Callable Services for High-Level Languages* for a description of BCPii and its associated services.
- “CANCEL command” on page 174 for information about the CANCEL command that you might issue if the STOP HWIBCPPII command does not result in the BCPii address space completely terminating.

Stopping IBM Health Checker for z/OS

Use the following form of the STOP command to stop IBM Health Checker for z/OS:

```
P hzsproc
```

The parameter is:

hzsproc

The name of the started procedure used to start IBM Health Checker for z/OS. The default procedure ships with the name HZSPROC.

Stopping the library lookaside (LLA) address space

Use the STOP LLA command to stop the LLA address space.

```
P LLA
```

The parameter is:

LLA

The job name assigned to the LLA address space.

Stopping LLA might be done when two or more systems have shared access to the same LLA directories and modifications are to be made to these shared directories. After stopping LLA and modifying the shared LLA data sets as needed, the operator can use the START LLA command to restart LLA. System performance

will be degraded until you restart LLA, but this procedure allows that the updates will be made simultaneously on all of the sharing systems.

Stopping the Object Access Method (OAM) Address Space

Use the STOP OAM command to stop the OAM address space.

For a detailed discussion of the STOP OAM command, refer to *z/OS DFSMS OAM Planning, Installation, and Storage Administration Guide for Object Support*, and *z/OS DFSMS OAM Planning, Installation, and Storage Administration Guide for Tape Libraries*.

Stopping a System Object Model (SOM)

Use the STOP SOM command to stop the distributed SOM subsystem. This is the extension to the SOMobjects product that allows programs to communicate with objects in other processes that reside in other address spaces or other systems. Executing this command causes the SOM subsystem to wait for all servers to end, and then to stop. See *SOMobjects Configuration and Administration Guide*, GC28-1851, for more information on stopping the SOM subsystem.

```
P SOM
```

The parameter is:

SOM

The name for the SOM subsystem. It corresponds to the cataloged procedure in SYS1.PROCLIB that starts SOM. A sample cataloged procedure is located in MVSDSOM.DR03.SGOSJCL(PROCDSVR).

Note: In order for this command to be effective, the SOM daemon address space must be active.

Example:

To stop the SOM daemon address space, enter:

```
P SOM
```

When you enter the STOP SOM command, the system displays these messages:

```
GOS041I SOM/MVS SOMI WAITING FOR SERVERS TO END.
GOS010I SOM/MVS SOMI ENDED.
```

The system might also display the following message:

```
IEF352I ADDRESS SPACE UNAVAILABLE
```

This is normal and you should not report it as a problem. The consequence of purging SOM is that it makes the address space identifier (ASID) permanently unusable, for system integrity reasons.

Stopping a temporary file system (TFS)

Use the STOP TFS command to stop a TFS running in a colony address space. If no file TFS systems are mounted, executing this command causes TFS to exit. A WTOR is issued, allowing TFS to be restarted. This command is not supported if TFS runs in the z/OS Unix kernel address space.

STOP command

```
P TFS
```

The parameter is:

TFS

The name of the TFS colony address space to be stopped.

Stopping the virtual lookaside facility (VLF)

Use the STOP VLF command to stop the virtual lookaside facility (VLF).

```
P VLF
```

The parameter is:

VLF

The jobname assigned to the virtual lookaside facility (VLF). Using this parameter stops VLF with message number COF033I.

Performance Implication: Stopping VLF can degrade system performance.

STOPMN command

Use the STOPMN command to stop the continual display of job status, data set status, or time-sharing user session activity initiated in response to the MONITOR command or MONITOR parameters on the CONSOLE and INIT statements in the CONSOLxx parmlib member.

Scope in a sysplex

The STOPMN command has sysplex scope only when you specify L=. See “Using commands that have sysplex scope” on page 12 for an explanation.

Syntax

The complete syntax for the STOPMN command is:

```
PM {JOBNAMES[,L={a|name|name-a}]}  
   {DSNAME                               }  
   {SPACE                               }  
   {STATUS[,L={a|name|name-a}] }  
   {SESS[,L={a|name|name-a}] }
```

Parameters

The parameters are:

JOBNAMES

Stop the jobname display specified in the MONITOR JOBNAMES command.

DSNAME

Stop the display of non-temporary data set names specified in the MONITOR DSNAME command.

SPACE

Stop the display of available space on direct access volumes specified in the MONITOR SPACE command.

STATUS

Stop the display of data set names, volume serial numbers, and status specified in the MONITOR STATUS command.

SESS

Stop the display of time-sharing user identifiers.

L=*a*, *name*, or *name-a*

The display area (*a*), name of the console (*name*), or both (*name-a*) where the display is to be stopped unless routing instructions are in effect. If you omit this keyword, the display is stopped at the console at which you enter the PM command.

Example: To discontinue the display of job name information that appears when a job is initiated or stopped, enter:

```
PM JOBNAMES
```

SWAP command

Use the SWAP command to initiate an operator request for dynamic device reconfiguration (DDR) and to activate or deactivate system-initiated DDR. DDR is described in "Responding to failing devices" on page 54.

Because a system-initiated DDR swap is automated in an IBM 3495 Tape Library Dataserver, the operation usually completes without operator intervention. Messages that do not require operator intervention are not sent to the console but are sent to the hardcopy log, where they are available for tracing and debugging. Note that the operator can still initiate swaps in an IBM 3495 Tape Library Dataserver. Table 69 summarizes the information that the SWAP command provides. Use it to access the pages on which you can find details about a particular use of the SWAP command.

Table 69. Summary of the SWAP Command

Command:	Topic:
SWAP devnum1,devnum2	"Operator-requested DDR"
SWAP OFF SWAP ON	"System-initiated DDR" on page 908

Syntax

The syntax for each variation of the SWAP command is shown immediately preceding its respective parameter list.

```
SWAP or G
```

Operator-requested DDR

Use the following form of the SWAP command when it is necessary to move a volume to another device, for example, when the device requires maintenance.

```
G [/]devnum1, [/]devnum2
```

SWAP command

[/] *devnum1*

The device number of the device from which the volume is to be swapped.

[/] *devnum2*

The device number of the device to which the volume is to be swapped.

devnum1 and *devnum2* must be of the same device type and have compatible features. A device number is 3 to 4 hexadecimal digits, optionally preceded by a slash (/).

To perform a dynamic device reconfiguration, enter a SWAP command. Then:

1. Wait for system message IGF500D or IGF509D and reply with one of the following:

YES The system is to proceed as indicated.

NO The swap request is to be canceled.

devnum2

An alternate "to" device is to be used.

2. After replying YES or *devnum2*, wait for the following message before proceeding with the swap:

```
* id IGF502E PROCEED WITH SWAP OF devnum1 TO devnum2
```

Note:

1. When the alternate "to" (*devnum2*) device is offline, the system takes the 'from' device offline:
IEF880I *devnum1* NOW OFFLINE BY DDR
2. The system never requests DDR for readers, printers, or punches, but you can request a swap of these devices. Unit record devices must be in a not-ready state when you enter the SWAP command. Devices with mounts pending cannot be swapped.
3. If you are using a 3348 Model 70F Data Module, make sure that the "to" 3340 device has the fixed-head feature installed.
4. A device with a 3-digit device number can be swapped to a device with a 4-digit device number, but not the reverse.

Example 1:

To move a volume from a device with device number 183 to a device with device number 283, enter:

```
swap 183,283
```

Example 2:

To move a volume from a device with device number 183 to a device with device number 3330, enter:

```
swap 183,/3330
```

System-initiated DDR

If a permanent I/O error occurs on a DDR-supported device, and it is an error that DDR recognizes, the system requests that the volume be moved.

Use the following form of the SWAP command to activate or deactivate system-initiated DDR.

```
G {OFF | ON}
```

The parameters are:

OFF

System-initiated DDR is to be deactivated. Any further swapping of devices must be done by operator-initiated DDR.

ON System-initiated DDR is to be activated for any further swapping of devices.

Note: If a system-initiated DDR is in progress, the swap will be completed before system-initiated DDR can be deactivated. Entering G=OFF will not effect any swap already in progress.

Example:

To deactivate system-initiated DDR, enter:

```
g off
```

SWITCH command

Use the SWITCH command as follows:

- If you are using SMF data sets to record SMF records, the SWITCH SMF command manually switches the recording of SMF data from one data set to another. The SWITCH SMF command also passes control to the IEFU29 dump exit, if one exists.
- If you are using log streams to record SMF (system management facilities) records, the SWITCH SMF command writes data from an SMF buffer to a log stream in preparation for running the dump program to dump SMF data. The SWITCH SMF command also passes control to the IEFU29L dump exit, if one exists.

Syntax

The complete syntax for the SWITCH command is:

```
I {SMF          }
```

Parameters

The parameters are:

SMF

If you use SMF data set recording, this parameter specifies that the recording of SMF data is transferred from one SMF data set to another. All SMF data in storage is to be written out before the transfer is made.

If you use SMF log stream recording, this parameter specifies that all the SMF log stream data be transferred from the buffers into the corresponding SMF log streams.

TRACE command

Use the TRACE command to:

- Start, stop, or modify system trace
- Start, stop, or modify master trace
- Start, stop, or modify component trace
- Start, stop, or modify transaction trace
- Display the current status of system trace, master trace, component trace, and transaction trace

During system initialization, or whenever you reactivate system trace after a system trace failure, the system creates a TRACE address space. That address space contains the system trace table. When the TRACE address space is created, the initial status of system trace (address space and explicit tracing functions) is **on**, the initial status of the branch tracing function of system trace is **off**, and the initial space set aside for system trace entries for each processor is **64K**.

You can issue TRACE ST, TRACE MT, TRACE CT, and TRACE TT from any console with master authority. You can issue TRACE STATUS from any console.

Syntax

The complete syntax for the TRACE command is:

```
TRACE [STATUS ]
      [ST[,nnnK|nnnM|nG] [,BR={ON|OFF}] [,MODE={ON|OFF}] ]
      [ST[,BUFSIZE|BUFSIZ=nnnnK|nnnnM|nnnG] [,BR={ON|OFF}] [,MODE={ON|OFF}] ]
      [ST[,OFF] ]
      [MT[,nnnK] ,OFF] ]
      [CT{,WTRSTART=membername [,WRAP|NOWRAP] } ]
      [CT{,WTRSTOP=jobname [,FLUSH|NOFLUSH] } ]
      [CT{ [,ON ] ,COMP=name [,SUB=(subname)] [,PARM=mem] } ]
          ,nnnK
          ,nnnM
          ,OFF
      [TT{ [,COLL|C=collection name } ]
          { ,CON=connection type }
          { ,COR=correlation info }
          { ,LU=logical unit name }
          { ,LVL=level }
          { ,NET=netid }
          { ,PKG=package name }
          { ,PLAN=|PL=plan name }
          { ,PROC|PR=proc name }
          { ,PRS=process }
          { ,SUB=subsystem }
          { ,TC=transaction class }
          { ,TRAN|T=transaction name }
          { ,USER|U=userid }
          [,WTR=membername|STOP ]
          [,LATENT=Y|N ]
          [,BUFSIZ=nnnK|nnM] ]
          [,OFF={nn|ALL} ]
```

Parameters

STATUS

The system is to display the current status of master trace. Status information includes the current size of the master trace table.

The display tells the operator to use the DISPLAY TRACE command to obtain status for system and component trace.

- ST** The system is to change the on or off status of system trace, the size of the system trace table, or the on or off status of the branch tracing function of system trace. Unless you specify **ST,OFF**, the system assumes you want to re-create the TRACE address space if it has terminated and turn system trace on if it is not on already.

nnnK

The amount of preferred, central storage in K bytes set aside for system trace table entries for each processor. You can specify for *nnn* any decimal number from 1 to 999. As the minimum trace table size for a processor is 1M, any request between 1-999K is interpreted as a request for 1M.

nnnM

The amount of preferred, central storage in M bytes set aside for system trace table entries for each processor. You can specify for *nnn* any decimal number from 1 to 999.

- nG** The amount of preferred, central storage in G bytes set aside for system trace table entries for each processor. You can specify for *n* any decimal number from 1 to 9.

Remember: Supply a reasonable value to the nnnM or nG parameter after considering the available central storage and the actual storage required for system trace. Supplying a large value for nnnM or nG might cause a shortage of pageable storage in the system.

If you omit the nnnM or nG parameter, the system assumes 1M for each processor, or the size established by the last TRACE command that specified a table size during the IPL. If the value specified exceeds a system determined safe amount, the command will be rejected and message IEA135I will display the maximum amount allowed per processor. The maximum value depends on real frame usage at the time the TRACE command is issued, and can vary each time the TRACE command is issued.

BR=ON or OFF

The system is to turn on or turn off the branch tracing function of system trace. The address space and explicit tracing functions remain on as long as system trace remains on. If you omit this parameter, the system assumes that the status of branch tracing remains unchanged.

BR=ON is intended for use in system software problem determination and diagnosis situations only. Branch tracing consists of tracing these four types of branches:

- Branch and stack (BAKR)
- Branch and link (BALR)
- Branch and save (BASR)
- Branch and save and set mode (BASSM)

Restriction: You cannot specify the BR= parameter if you specify ST=OFF.

TRACE command

Attention: Turning branch tracing ON tends to affect your system performance and use very large amounts of storage. Do not use branch tracing as the default for system tracing on your system. Only use it for short periods of time to solve a specific problem. The default system tracing does not include branch instructions.

You can run the SYSTRACE_BRANCH check to make sure that your installation does not run with BR=ON for longer than desired. See SYSTRACE_BRANCH in *IBM Health Checker for z/OS User's Guide*.

MODE=ON or OFF

The system is to turn on or turn off the mode tracing function of system trace. Mode tracing consists of recording occurrences of entering and leaving 64-bit mode. The specification of branch tracing and mode tracing is separated. Therefore, the BR= parameter will not have any effect on mode tracing.

Restriction: You cannot specify the MODE= parameter if you specify ST=OFF.

Attention: Turning mode tracing ON tends to affect your system performance and use very large amounts of storage. Do not use mode tracing as the default for system tracing on your system. Only use it for short periods of time to solve a specific problem. The default system tracing does not include mode tracing.

You can run the SYSTRACE_MODE check to make sure that your installation does not run with MODE=ON for longer than desired. See SYSTRACE_MODE in *IBM Health Checker for z/OS User's Guide*.

BUFSIZE|BUFSIZ=nnnnnK or nnnnnM or nnnG

The system is to specify the total storage for all trace buffers in kilobytes (K), megabytes (M), or gigabytes (G). The size specified is divided by the number of installed CPUs and rounded up to the next megabyte to arrive at trace storage required per CPU.

Note: The total trace buffer size allocated can exceed the BUFSIZE specified in the TRACE command because of this rounding.

Remember: Supply a reasonable value to the BUFSIZE parameter after considering the available central storage and the actual storage required for system trace. Supplying a large value for BUFSIZE can cause shortage of pageable storage in the system.

OFF

The system is to stop system trace and free the system trace table. The system does not terminate the TRACE address space. Therefore, if you start system trace again while the TRACE address space is still active, the on or off status of the different system trace functions and the size of the system trace table return to the values they had the last time system trace was on.

MT The system is to change the on or off status of master trace or the size of the master trace table. Unless you specify **MT,OFF**, the system assumes you want to turn master trace on if it is not on already.

nnnK

The master trace table size you want the system to use. You can specify for

nnn any decimal number from 16 to 999. If a master trace table already exists, this new table replaces it. If you omit this parameter, the system assumes a table size of 24K.

OFF

The system is to stop master trace.

- CT** Specifies the component tracing options for an MVS component or an application. The system programmer will supply the trace parameters. To determine if the component to be traced allows the following parameters, see "component traces" in *z/OS MVS Diagnosis: Tools and Service Aids*.

WTRSTART=membername

Identifies the name of the member that contains the source JCL that invokes a component trace external writer. The *membername* is 1 to 7 characters. The system also opens the data sets the writer uses. The member can be a SYS1.PROCLIB cataloged procedure or a job. Many installations use a cataloged procedure in SYS1.PROCLIB.

After you enter a TRACE CT,WTRSTART command, you should turn the trace on and connect the writer with a WTR parameter in the reply for a TRACE CT command or in a parmlib member, if specified.

WRAP or NOWRAP

If you specify WRAP, when the system reaches the end of the data set or group of data sets, it writes over the oldest data at the start of the data set or the start of the first data set. If you specify NOWRAP, the system stops writing to the data set or sets when the data set or sets are full.

If the WTRSTART parameter on the CTnccccx parmlib member or TRACE CT command specifies NOWRAP, the system uses the primary and secondary extents of the data set or sets. If the WTRSTART parameter specifies WRAP or omits the parameter, the system uses only the primary extent or extents.

WTRSTOP=jobname

Identifies the name of the job for a currently running component trace external writer that the system is to stop. The *jobname* is 1 to 7 characters. The system also closes the data sets the writer used.

The *jobname* is either:

- Member name, if the source JCL is a procedure
- Job name, if provided on a JOB statement within the source JCL

If you specify or default FLUSH, the writer will stop when it has finished writing out its current buffers. If you specify NOFLUSH, the writer stops immediately.

Before you enter a TRACE CT,WTRSTOP command, you must either:

- Turn the trace off, or
- Disconnect the component trace external writer from the trace leaving the trace on.

To disconnect the external writer while leaving the trace on enter the TRACE CT,ON command with WTR=DISCONNECT in the reply or in a CTnccccx parmlib member, if specified.

If the trace is not turned off or disconnected from the writer, message ITT121I informs the operator of the condition and the writer will not stop.

TRACE command

ON If the component trace is currently off, a TRACE CT,ON command turns it on. If the component trace is currently on and can be changed, a TRACE CT,ON command changes the trace options. An installation-supplied application trace can also have head level and sublevel traces, if specified in the CTRACE DEFINE macro that defined the trace.

Whenever a trace that has sublevel traces is changed, all sublevel traces currently in the LIKEHEAD state will also be changed. Therefore, a change may cascade down a number of levels.

A head trace may have been defined so that it is not allowed to be changed (HEADOPTS=NO on the CTRACE DEFINE macro). If this is the case, the trace is really just a place holder for options for other traces.

nnnnK

nnnnM

Specifies the size, in kilobytes (K) or megabytes (M), of the trace buffer you want the system to use. Specifying the buffer size also turns the trace on.

nnnnK is the buffer size in kilobytes, where *nnnn* is a decimal number from 1 to 9999. *nnnnM* is the buffer size in megabytes, where *nnnn* is a decimal number from 1 to 2047.

When the size is not specified, the system uses the component-defined default or the size specified in a CTncccx parmlib member.

The size specified for an installation-supplied application trace must be within the range specified on the CTRACE DEFINE macro for the trace; see the programmer for the size value.

OFF

The system is to turn off tracing for the component. If the component is connected to a component trace external writer, the trace will be implicitly disconnected from the writer.

Some components do not turn tracing completely off. Instead, they reduce the tracing activity to the minimum required for serviceability data in a dump. If the CTRACE DEFINE macro that defined the trace specified the MINOPS parameter, tracing is reduced to a minimum and component trace writes a message to the operator.

If a component level trace has sublevel traces that are defined with the LIKEHEAD parameter on the CTRACE DEFINE macro, the sublevel traces will either be reduced to the minimal tracing or turned off, in the same manner as their head level component trace.

COMP=*name*

Identifies the component trace affected by the command. *name* is the external name for the component trace; it is provided for an IBM-supplied component and must be provided by a system programmer for an installation-supplied application trace. This parameter is required.

SUB=(*subname*)

Identifies a sublevel trace for a component or application with multiple traces. *Subname* is defined by the component or installation-supplied application.

The SUB parameter is limited to a single *subname*; multiple *subnames* are not supported.

If the sublevel trace name contains any national characters (\$ # @), you must enclose the name in quotation marks. Otherwise, quotation marks are not required. In all cases you may specify the alphabetic characters in upper or lower case.

If *subname* is a head level, all of the head's sublevel traces that are defined with a LIKEHEAD=YES parameter inherit the options specified in the reply to this command. Therefore, the options you specify for a head level can affect many sublevel traces.

Omitting the SUB parameter for a head level that is defined with HEADOPTS=YES affects all sublevel traces with the LIKEHEAD attribute.

PARM=mem

Identifies a parmlib member that contains the options to be used for tracing. Using a parmlib member allows the operator to initiate the trace, change it, or stop it without a message prompting for options.

Any option specified on the TRACE command overrides the option specified in the parmlib member.

- TT** Specifies the transaction trace options. The system programmer will supply the trace parameters. To determine which trace parameters to use, see "Specifying TRACE TT Options." For further information, see "Transaction Trace" in *z/OS MVS Diagnosis: Tools and Service Aids*.

Specifying TRACE CT options

In response to a TRACE CT,ON command without the PARM parameter, the system prompts you to specify the component trace options you want with message ITT006A. Use the REPLY command to respond to that message. You can specify each option, ASID, JOBNAME, OPTIONS, or WTR only if the component or application supports it. You can enter the DISPLAY TRACE command before entering a TRACE CT command to verify which options are supported.

The REPLY command syntax for specifying TRACE CT options is:

```
R id[,ASID=(nnnn[,nnnn]...)]
    [,JOBNAME=(name[,name]...)]
    [,OPTIONS=(name[,name]...)]
    [,WTR={membername|DISCONNECT}]
    [,CONT|,END ]
```

Note: When you specify CONT or END, it must be the last parameter on the input line.

id The identification number (0-9999), as specified on the prompting message.

ASID=(nnnn[,nnnn]...)

Specifies the address space identifiers (ASIDs) of address spaces to be used as a filter for tracing. Events in these ASIDs are to be recorded by the component trace.

The parameter contains a list of 0 to 16 hexadecimal ASIDs separated by commas. An empty ASID list, ASID=(), turns off filtering by address spaces. In the ASID parameter, list all address spaces to be traced; address spaces specified for previous traces will not be traced unless listed.

TRACE command

JOBNAME=(*name* [,*name*] ...)

Specifies the names of jobs to be used as a filter for tracing. Events in these jobs are to be recorded by the component trace.

The parameter contains a list of 0 to 16 job names separated by commas. An empty job list, JOBNAME=(), turns off filtering by jobs. In the JOBNAME parameter, list all jobs to be traced; jobs specified for previous traces will not be traced unless listed.

OPTIONS=(*option* [,*option*] ...)

Specifies component-specific options for tracing. See *z/OS MVS Diagnosis: Tools and Service Aids* for the options for an IBM-supplied component that supports component tracing. Refer to the installation-supplied application for the options for the application.

The options for some IBM-supplied component traces can be changed while the trace is running; to change the options for others, stop the trace and restart it with the new options. An installation-supplied application trace defined with MOD=YES in the CTRACE DEFINE macro can be changed while running.

The options for a head level defined with HEADOPTS=NO cannot be changed. When you change a head level that was defined with HEADOPTS=YES, all of the sublevel traces currently in LIKEHEAD status will also be changed. Therefore, a change may cascade down a number of levels.

Omit OPTIONS to allow the component to use its default options.

WTR=*membername*

WTR=DISCONNECT

Connects or disconnects the component trace external writer and the trace. *membername* identifies the name of the member that contains the source JCL that invokes the external writer. The member can be a SYS1.PROCLIB cataloged procedure or a job. The *membername* in the WTR parameter must match the *membername* in a previous TRACE CT,WTRSTART command.

WTR=DISCONNECT disconnects the writer and the trace. The component continues tracing and placing the trace records in the address-space buffer, but stops passing trace records to the external writer.

You must also specify a TRACE CT,WTRSTART or TRACE CT,WTRSTOP command to start or stop the writer.

CONT or END

Specifies that the reply continues on another line. The system reissues the same prompting message. You then can continue the reply. You can repeat any parameters on the continuation line, except END. Repeated parameters are strung together. They do not overlay each other. You must specify END to complete the response. END identifies the end of the REPLY.

Example 1:

To turn off system trace, enter:

```
TRACE ST,OFF
```

Example 2:

System trace is off. The last time system trace was on, 16K of storage was set aside for system trace table entries for each processor. To turn on system trace, turn on the branch tracing function of system trace, and increase the space for system trace table entries to 250K for each processor, enter:

```
TRACE ST,250k,BR=ON
```

Example 3:

To turn on master trace, if it is not already on, and to define a master trace table of 100K, enter:

```
TRACE MT,100k
```

Example 4:

To modify component trace for the GRS component by specifying a different parmlib member, enter:

```
TRACE CT,ON,COMP=SYSGRS,PARM=CTYGRS02
```

Specifying TRACE TT options

The TRACE TT command specifies the definition of a transaction trace (TTrace) filter set, definition or change in the TTrace processing options, removal of a TTrace filter set, or stopping of TTrace in the sysplex.

COLL | C=collection

specifies a collection name to be used as a filter for tracing. Collection name identifies the customer-defined name for a group of associated packages.

The collection name consists of 1 through 18 characters.

CON=connection type

specifies a connection type to be used as a filter for tracing. Connection type identifies the type associated with the environment creating the work request, which may reside anywhere within the network.

The connection type consists of 1 through 8 characters.

COR=correlation info

specifies correlation information to be used as a filter for tracing. Correlation information identifies the name associated with the user or program creating the work request, which may reside anywhere within the network.

The correlation information consists of 1 through 18 characters.

LU=logical unit name

specifies the LUNAME to be used as a filter, allowing work related to this logical unit to be traced.

The luname consists of 1 through 8 characters.

LVL=level

specifies the trace level indicator to be assigned to this filter set. Valid trace level indicators are 1, 2, 3, and 128-255.

The level consists of 1 through 3 numeric characters.

The default trace level value is 2.

Trace level indicators 0, and 4 through 127 are reserved.

NET=netid

specifies a NETID name to be used as a filter, allowing work related to this network ID to be traced.

The netid consists of 1 through 8 characters.

Specifying NET requires the specification of the LU keyword.

TRACE command

PKG=package

specifies a package name to be used as a filter for tracing. The package name identifies a set of associated SQL statements.

The package name consists of 1 through 8 characters.

PLAN|PL=plan name

specifies a name to be used as a filter for tracing. The plan name identifies the access plan name for a set of associated SQL statements.

The plan name consists of 1 through 8 characters.

PROC|PR=proc name

specifies the proc name to be used as a filter for tracing. Proc name identifies the DB2-stored SQL Procedure name associated with the work request.

The proc name consists of 1 through 18 characters.

PRS=process

specifies process information to be used as a filter for tracing. Process information identifies the process name associated with the work request.

The process information consists of 1 through 32 characters.

SUB=subsystem

specifies subsystem information to be used as a filter for tracing. Subsystem information identifies character data related to the work request that is passed by the work manager for use in WLM classification.

The subsystem information consists of 1 through 18 characters.

TC=transaction class

specifies the transaction class to be used as a filter for tracing. Transaction class identifies a class name within the subsystem.

The transaction class information consists of 1 through 8 characters.

TRAN|T=transaction_name

specifies a transaction name to be used as a filter for tracing.

Although the transaction name has specific meaning to many subsystems (those that exploit WLM classify), the transaction name identifies the name of the work request desired to be traced across the set of components that may handle it. See *z/OS MVS Planning: Workload Management* for information on transaction name and jobname.

The transaction name consists of 1 through 8 characters.

USER|U=userid

specifies a userid to be used as a filter for tracing.

userid is the name of a single userid for whom the tracing is to be done.

The userid consists of 1 through 8 characters.

WTR=membername | STOP

indicates that the external writer is to be started for recording transaction trace entries in a data set, or stopped if it was already started. This is an optional keyword.

membername

identifies the member that contains the source JCL that invokes the component trace external writer. The system opens the data sets that the writer uses. The member can be a SYS1.PROCLIB catalogued procedure or a job.

If WTR= is not specified, the trace data is saved in the TTRACE data space and can be obtained by dumping the data space.

The external writer may be started on the first invocation of the TRACE TT command or on any subsequent TRACE TT command prior to the TRACE TT,OFF command. Only one external writer may be started on any instance of transaction trace.

The external writer proc name **must** be the same on every system in the sysplex that is participating in transaction trace. Each system may define a proc with the same name or share a common writer proc.

If trace is already running, the writer may be started with a TRACE TT,WTR= command without specifying any filter parameters.

Trace entries are recorded in the external writer data set from the time the external writer is started until the external writer is stopped with a TRACE TT,WTR=STOP or trace is turned off with a TRACE TT,OFF,ALL. When the end of the data set is reached, it starts writing from the top of the data set, overlaying the oldest entries. Specifying a "membername" when transaction trace is not active (that is, no filter has been specified) results in an error message.

STOP

indicates that the external writer that was previously started needs to be stopped. No more trace entries are recorded in the external writer data set.

Any trace records currently in the buffers are written prior to stopping the external writer. An error message is issued if WTR=STOP is issued when no external writer is active.

BUFSIZE|BUFSIZ=*nnnK* or *nnM*

specifies the size of the TTrace data space the system is to use, in kilobytes (K) or megabytes (M).

nnnK is the buffer size in kilobytes, where *nnn* is a decimal number from 16 to 999.

nnM is the buffer size in megabytes, where *nn* is a decimal number from 1 to 32.

The buffer size may be changed anytime when trace is active. This includes when the initial TRACE TT command is issued. Specifying a buffer size when transaction trace is not active (that is, no filter has been specified) results in an error message. The default size is 1M.

The scope of this buffer size change affects TTrace processing until the buffer size is changed on a subsequent command or after a system IPL. That is, the buffer size persists if TTrace is turned off and turned on at a later time.

The buffer size is rounded up to a page boundary (that is, multiples of 4K).

This is an optional keyword.

LATENT=(Y|N)

specifies whether latent transactions need to be traced.

A *latent transaction* is defined by *all* of the following:

- The transaction is currently active in the system.
- The transaction is marked for tracing.
- The filter value used to mark the transaction eligible for tracing is no longer active, that is, TRACE TT,OFF=*nn* was issued to turn that filter off.

TRACE command

Y specifies that latent transactions, if any, can continue to be traced. Y is the default value.

N specifies to not trace latent transactions. Any current active transactions that do not have an active filter will not be traced from this point on.

The scope of the latent parameter setting affects TTrace processing until the parameter is changed on a subsequent command or after a system IPL. That is, the parameter value persists if TTrace is turned off and then turned on at a later time.

OFF=(nn|ALL)

turns the specified active transaction trace OFF across the sysplex.

nn specifies the filter set number of the trace to be turned off.

nn is an integer from 1-99 that identifies a particular transaction trace filter set. Use DISPLAY TRACE,TT to display the active TTrace filter sets.

ALL

specifies that all the active transaction traces should be turned off across the sysplex.

No additional trace entries are recorded. Any data in the trace buffers is written out to the data space and external writer data set. The external writer, if it was started, is also stopped.

A message is issued to the operator console to indicate that transaction trace is no longer active on the system and a DUMP command may be issued to access the trace in the data space.

UNLOAD command

Use the UNLOAD command to unload mounted tape or DASD volumes.

In a JES3 complex, use the UNLOAD command carefully. When you request that a volume be removed from a JES3-managed direct access device, you must enter an UNLOAD command on each system in the complex that has access to the device. In addition, if you are requesting that a volume be removed from a JES3-managed unit, you must also enter a JES3 unload command (*MODIFY,S,U=...). See *z/OS JES3 Commands*.

Scope in a sysplex

The UNLOAD command has sysplex scope only when you issue the command against an automatically switchable tape device. See "Using commands that have sysplex scope" on page 12 for an explanation of sysplex scope.

Syntax

The complete syntax for the UNLOAD command is:

U [/]devnum

Parameters

[/]devnum

The device number of the device to be unloaded. A device number is 3 or 4 hexadecimal digits, optionally preceded by a slash (/).

VARY command

Table 70 summarizes the information that the VARY command provides. Use it to access the pages on which you can find details about a particular use of the VARY command.

Uses of the VARY command for TCPIP activity and functions are described in *z/OS Communications Server: IP Configuration Reference*.

Uses of the VARY command for VTAM network activity and functions are described in *z/OS Communications Server: IP System Administrator's Commands*.

Note: To change the online or offline status of processors, channel paths, ESTOR elements, and central storage sections, see the CONFIG command.

Table 70. Summary of the VARY Command

Command:	Topic:
VARY CN,ACTIVATE	"Controlling problem determination mode for the system console" on page 923
VARY CN,DEACTIVATE	"Controlling problem determination mode for the system console" on page 923
VARY CN,AUTOACT=	"Controlling problem determination mode for the system console" on page 923
VARY CN,ONLINE OFFLINE	"Placing a console online or offline" on page 938
VARY CN	"VARY CN command" on page 926
VARY ...,CONSOLE	"VARY CONSOLE command" on page 932
VARY ...,HARDCPY	"Controlling hardcopy processing" on page 935
VARY conspec...,ONLINE VARY conspec...,OFFLINE	"Placing a console online or offline" on page 938
VARY CU	"Processing devices or a path to devices attached to a control unit" on page 939
VARY devspec...,AUTOSWITCH	"Defining a tape device as automatically switchable" on page 940
VARY devspec...,ONLINE VARY devspec...,OFFLINE	"Placing an I/O device or a range of I/O devices online or offline" on page 941
VARY devspec...,AVAILABLE AVAIL VARY devspec...,UNAVAILABLE UNAVAIL	"Allowing or preventing allocation from using an offline tape device" on page 946
VARY GRS	"Controlling a global resource serialization complex" on page 946
VARY PATH	"Placing an I/O Path or Paths Online or Offline" on page 948
VARY SMS CFCACHE VARY SMS CFLS VARY SMS CFVOL VARY SMS FALLBACK VARY SMS, MONDS VARY SMS,SHCDS VARY SMS,SHCDS CFRESET VARY SMS,SMSVSAM	"Changing the state of coupling facility cache structures and volumes" on page 951

VARY command

Table 70. Summary of the VARY Command (continued)

Command:	Topic:
VARY SMS,DRIVE VARY SMS,LIBRARY	"Placing an optical drive or library online or offline" on page 954
VARY SMS,LIBRARY	"Placing a system-managed tape library online or offline" on page 955
VARY SMS,PDSE,ANALYSIS	"Analyzing the state of the PDSE subsystem" on page 955
VARY SMS,PDSE,FREELATCH	"Releasing PDSE latches" on page 955
VARY SMS,PDSE,MONITOR,...	"Modifying processing of PDSE monitor" on page 955
VARY SMS,PDSE,MONITOR	"Display current state of the PDSE monitor" on page 956
VARY SMS,PDSE1,[,QUIESCE(duration 3), XQUIESCE(duration 5)] VARY SMS,PDSE1,ACTIVATE[,COMMONPOOLS(NEW REUSE)] VARY SMS,{PDSE PDSE1},REFRESH,DSN(dsname) [,VOL(volser)] VARY SMS,PDSE1,RESTART[,QUIESCE(duration 3), XQUIESCE(duration 5)] VARY SMS,PDSE1,RESTART[,QUIESCE(duration 3), COMMONPOOLS(NEW REUSE)]	<i>z/OS DFSMSdfp Diagnosis</i>
VARY SMS,STORGRP VARY SMS,VOLUME	"Changing the SMS status of a storage group or volume" on page 956
VARY SMS,STORGRP...,SPACE VARY SMS,VOLUME...,SPACE	"Updating space statistics for volumes in the SMS configuration" on page 958
VARY SMS,TRANVSAM	"Controlling DFSMStvs processing" on page 959
VARY SWITCH	"Placing a switch port online or offline" on page 969
VARY WLM,APPLENV	"Controlling an application environment" on page 970
VARY WLM,POLICY	"Activating a service policy" on page 973
VARY XCF	"Removing a System from the XCF Sysplex" on page 974

You cannot specify the names of extended MCS, HMCS or system consoles in the following VARY commands:

- VARY CONSOLE
- VARY OFFLINE
- VARY ONLINE

You cannot specify the names of SMCS consoles in the following VARY commands:

- VARY CONSOLE
- VARY ONLINE

Scope in a sysplex

The following table describes the conditions under which the VARY command has sysplex scope. See "Using commands that have sysplex scope" on page 12 for an

explanation of sysplex scope. If a command has no entry under “Conditions”, then the command has sysplex scope under all circumstances and for all variations.

Table 71. Sysplex Scope for VARY Command

Command	Conditions
VARY CN	Has sysplex scope unless all of the following are true: <ul style="list-style-type: none"> • You issue VARY CN(<i>conspec</i>),ONLINE without specifying SYSTEM=. • You do not specify SYSTEM= in the CONSOLxx member of Parmlib that defines this console. • The console has never been active in the sysplex.
VARY SMS, STORGRP VOLUME	Has sysplex scope under these conditions only: <ul style="list-style-type: none"> • You specify (<i>storgrp volume,ALL</i>) and all systems in the sysplex are in the same SMS complex. • You specify (<i>storgrp volume, system</i>) where <i>system</i> is a system group, and the system group exactly matches the sysplex (that is, none of the systems in the sysplex is explicitly defined to SMS).
VARY SWITCH	Logical partition cluster scope — see the “Intelligent Resource Director” chapter in <i>z/OS MVS Planning: Workload Management</i> for more information.
VARY XCF	All
VARY WLM	All

Syntax

The syntax for each variation of the VARY command is shown immediately preceding its respective parameter list.

VARY or V

Controlling problem determination mode for the system console

Use this form of the VARY command to control problem determination mode for the system console. You can place the system console in problem determination mode by entering the VARY CN,ACTIVATE command. If you are not sure of the system console names, enter the DISPLAY CONSOLES command with KEY=SYSCONS.

Problem determination mode allows you to receive messages on the system console to debug hardware and software problems. After initialization, the system console is NOT in problem determination mode and receives a minimal set of messages. In addition, problem determination mode allows the system console to be able to send commands in the same manner as specifying ALLOWCMD(Y) in the CONSOLxx definition of the system console. See *z/OS MVS Initialization and Tuning Reference* for information about the CONSOLxx parmlib member.

The first time the system console is placed into problem determination mode, it receives its attributes from its CONSOLE statement in CONSOLxx. On subsequent ACTIVATEs, it receives the attributes it had when it was last DEACTIVATED. (Use the DISPLAY CONSOLES command to see if the system console is in problem determination mode. If it is, the display will show COND=(A,PD).)

VARY command

Use the DISPLAY CONSOLES command to see which attributes are in effect for the system console when it is in problem determination mode. Use the VARY, CONTROL, or MONITOR commands to change console attributes for the system console when in problem determination mode.

If the system console is already in problem determination mode, the system rejects the command.

VARY CN,ACTIVATE command

The syntax of the VARY CN,ACTIVATE command is:

```
VARY CN(conspec1|*),{ACTIVATE|ACT}
```

CN(*conspec1* or *)

Change the mode of the specified system console to problem determination mode. *conspec1* is the system console name. An asterisk (*) indicates the system console from which you enter the command. You must enter the command from the system console that you want to activate.

ACTIVATE or ACT

The system is to activate problem determination mode for the specified system console.

Note: If you did not specify message level for the system console in CONSOLxx, the system console receives all messages except broadcast messages.

For information on the effect of issuing a VARY CN(syscons),ACTIVATE command while an AUTOACT group is defined, see “Suspending AUTOACT processing” on page 925.

Restrictions:

1. The VARY CN,ACTIVATE command affects only the system console on which you enter the command. You cannot enter multiple system console names.
2. If you enter an asterisk (*) on the CN parameter of the VARY CN,ACTIVATE command, do not specify system symbols in the command. The system will not substitute text for the system symbols.

VARY CN,DEACTIVATE command

You can remove the system console from problem determination mode by entering the VARY CN,DEACTIVATE command. When the command takes effect, the system console receives a minimal set of messages.

MVS commands can be issued from the system console regardless of its operating mode.

The VARY CN,DEACTIVATE command can affect any system console in the sysplex. Thus, you can route the command from any console with the proper authority to the target system console.

For information on the effect of issuing a VARY CN(syscons),DEACTIVATE command while an AUTOACT group is defined, see “Suspending AUTOACT processing” on page 925.

The syntax of the VARY CN, DEACTIVATE command is:

```
VARY CN(conspec1|*),{DEACTIVATE|DEACT}
```

CN(*conspec1* or *)

Remove the specified system console from problem determination mode. *conspec1* is the system console name. An asterisk (*) indicates the system console on which the command is entered. You can enter the command from any authorized console (master authority) for the designated system console you want to deactivate.

DEACTIVATE or DEACT

The system is to deactivate problem determination mode for the specified system console.

VARY CN,AUTOACT= command

You can configure the system console so that the commands VARY CN,ACTIVATE and VARY CN,DEACTIVATE are issued automatically to ensure that messages are sent to the system console when no other consoles are available. If you specify an automatic activate group (AUTOACT) for the system console, the VARY,CN AUTOACT= command uses the name of a console group from CNGRPxx.

If an AUTOACT group is defined and not suspended:

- When all of the consoles in AUTOACT are inactive, the system console will automatically be placed into PD mode.
- If any console in AUTOACT becomes active after the system console has automatically been placed into PD mode, the system console will then automatically be removed from problem determination (PD) mode.
- The consoles in the AUTOACT group can be of any type (MCS, HMCS, SMCS or EMCS).
- In a sysplex environment, the consoles in the AUTOACT group can be attached to any system in the sysplex.

Suspending AUTOACT processing: If a VARY CN(*syscons*),ACTIVATE or a VARY CN(*syscons*),DEACTIVATE command is issued while an AUTOACT group is defined, and the command was NOT issued automatically by the AUTOACT processing, then AUTOACT processing will be suspended. This suspension means that the system console's mode will not be changed automatically by MVS. When the opposite (ACTIVATE or DEACTIVATE) command is issued, AUTOACT processing will resume.

VARY CN,AUTOACT syntax: The syntax of the VARY CN,AUTOACT= command is:

```
VARY CN(conspec1|*),{AUTOACT=console group name|*NONE*}
```

CN(*conspec1* or *)

Add, change, or remove the specification of an automatic activate group for the specified system console. *conspec1* is the system console name. An asterisk (*) indicates the same console from which you enter the command. You can enter the command from any authorized console (master authority) for the designated system console you want to change.

Note: This command will not work if *conspec1* is not a system console.

console group name* or *NONE

console group name indicates the new or changed group name which is to be the

VARY command

automatic activate group for the system console. *console group name* must be defined in the current CNGRPxx. *NONE* indicates that the automatic activate group specification is to be removed from the system console. The system console will not be activated or deactivated automatically.

Controlling MCS, HMCS and SMCS consoles

Use the following forms of the VARY command to:

- Change the authority of a console
- Define or change the routing codes that send system messages to a console

The consoles specified on these commands must be defined as consoles in the CONSOLxx Parmlib member. Extended MCS consoles can also be accepted.

VARY CN command

The VARY CN command is used to set attributes for MCS, HMCS, SMCS and extended MCS consoles. The command can also be used to change the state of a console.

The command only changes the attributes of the console when the console is active. If the console is not active, message IEE871I is issued, and the attributes are not changed. LU and LOGON are two attribute exceptions and they can be changed for inactive SMCS consoles. The syntax of the VARY CN command is:

```
V CN({*|conspc1[,conspc1]...})
    [,AMSCOPE=([*][,name[,name]...])]
    [,AUTH={ALL|INFO|MASTER|([SYS][,IO][,CONS])}]
    [,AROUT=(rtcode[,rtcode]...)]
    [,DMSCOPE=([*][,name[,name]...])]
    [,DROUT=(rtcode[,rtcode]...)]
    [,INTIDS={Y|N}]
    [,LOGON={OPTIONAL|REQUIRED|AUTO|DEFAULT}]
    [,LU={!uname|*NONE*}]
    [,MSCOPE=(*ALL|([*][,name[,name]...])}]
    [,OFFLINE[,FORCE]|,ONLINE[,SYSTEM=sysname][,FORCE][[,STANDBY]]]
    [,ROUT={ALL|NONE|(rtcode[,rtcode]...)}]
    [,SUPSBY={Y|N}]
    [,TIMEOUT=timeo]
    [,UNKNIDS={Y|N}]
```

Note:

1. You do not have to put a single AUTH=operand, or a single MSCOPE=operand, or a single routing code in parentheses. You must put a single console in parentheses.
2. Active MCS/HMCS/SMCS/EMCS consoles can have their attributes changed. If the console is inactive, message IEE871I CN=consname NOT ACTIVE. CAN NOT CHANGE CONSOLE ATTRIBUTES is issued. Only the LU and LOGON attributes can be changed for a SMCS console that is inactive.
3. When LU=*NONE* is specified, the VARY command no longer requires the LOGON keyword to be specified with the LU keyword.
4. If the OFFLINE keyword was specified, then the following keywords cannot be specified:
 - LU
 - LOGON

Syntax error message ASA103I is issued for this incorrect combination of keywords.

5. If the OFFLINE keyword was specified, with other attribute keywords besides LU or LOGON, the OFFLINE will deactivate the console, but the attribute keywords will not execute. Message IEE871I will be issued.
 6. In console services shared mode, the effect of the VARY attribute command lasts for the duration of the IPL. In distributed mode, the effect of the command lasts only for the duration of the console being active.
- CN** Change the indicated authority for the specified console name(s). When you are uncertain of the current console names, enter a DISPLAY CONSOLES command; see “Displaying console status information” on page 282 for further information on this command.

conspec1

Represents one of the following:

nnnnnnnn

The name of the console device.

- * The console that you are currently issuing commands from.

AMSCOPE

Adds one or more system names to the list of systems from which the console can receive messages. If you specify more than one system name, separate the names with commas.

You can also specify an asterisk (*), which means that the console is to receive messages from the system to which it is attached. If the console is later attached to a different system, the console will start receiving message from that different system. For example, specifying AMSCOPE(SYS1,SYS2,*) causes a console to receive messages from systems SYS1, SYS2, and the system to which the console is attached.

AUTH

Specifies the system command groups that the console is authorized to enter. This command requires MASTER authority and might be protected with a security product OPERCMDS resource class with the MVS.VARYAUTH.CN profile, which requires CONTROL authority. In addition, the MVS.VARY.CN profile, which requires UPDATE authority, must also be specified. Table 10 on page 125 lists the commands and their associated groups.

ALL

One or more specified consoles are authorized to enter INFO, SYS, IO, and CONS commands.

INFO

One or more specified consoles are authorized to enter only INFO commands.

MASTER

One or more specified consoles are authorized to enter all system operator commands.

([SYS] [, IO] [, CONS])

One or more specified consoles are authorized to enter INFO commands as well as SYS, IO, or CONS commands (depending on which commands you include). Enter them in any order.

AROUT

The system is to add one or more specified routing codes or the routing codes

VARY command

in the specified range(s) to the routing codes already defined for the console. You can specify single routing codes (*rtcode*), ranges of routing codes (*rtcode-rtcode*), or a combination of single routing codes and ranges of routing codes on the same AROUT operand. For example, specifying AROUT(2,11-14,28) adds routing codes 2, 11, 12, 13, 14, and 28.

DMSCOPE

Deletes one or more system names from the list of systems from which the console can receive messages. If you specify more than one system name, separate the names with commas.

If the console currently is defined to receive messages from the system to which it is attached, you can also remove that definition. To do this, specify an asterisk on the DMSCOPE parameter.

For example, if you have issued VARY CN AMSCOPE(SYS1,SYS2,*), the console receives messages from SYS1, SYS2, and whatever system the console is currently attached to.

- If the console is attached to SYS1, it receives messages from SYS1 and SYS2. Issuing VARY CN DMSCOPE(*) has no effect on the console until the console is moved to a system other than SYS1 or SYS2. When it is moved to the other system, the console does not receive messages from that system.
- If the console is attached to SYS3, it receives messages from SYS3 as well as SYS1 and SYS2. When you issue VARY CN DMSCOPE(*), the console immediately stops receiving messages from SYS3.

DROUT

The system is to remove the specified routing code(s) or the routing codes in the specified range(s) from the routing codes already defined for the console. You can specify single routing codes (*rtcode*), ranges of routing codes (*rtcode-rtcode*), or a combination of single routing codes and ranges of routing codes on the same DROUT operand. For example, specifying DROUT(2,11-14,28) deletes routing codes 2, 11, 12, 13, 14, and 28.

INTIDS

Whether the specified console can receive messages which are directed to console ID zero. These messages are usually the command responses for internally issued commands.

Y The specified console is to receive these messages.

N The specified console is not to receive these messages. This is the default value.

LOGON=*value*

This allows the operator to change the unique LOGON value of the specified console. The LOGON attribute can also be changed for inactive SMCS consoles. The LOGON keyword cannot be specified when the OFFLINE keyword is specified.

The LOGON *value* is one of the following:

OPTIONAL

Indicates that this console does not require LOGON

REQUIRED

Indicates that this console requires an operator to logon before issuing commands

AUTO

Indicates that this console is automatically logged on

DEFAULT

Indicates that this console is to use the LOGON specification on the DEFAULT statement

OPTIONAL, REQUIRED, AUTO and DEFAULT all mean the same as they do on the LOGON keyword of the CONSOLE statement in CONSOLxx. See *z/OS MVS Initialization and Tuning Reference* for more information.

This command requires MASTER authority and might be protected with a security product OPERCMDS resource class with the MVS.VARYLOGON.CN profile, which requires CONTROL authority. In addition, the MVS.VARY.CN profile, which requires UPDATE authority, must also be specified.

LU

Luname OR *NONE*

Allows the operator to change or turn off the predefined LU name of a SMCS console. See *z/OS MVS Planning: Operations* for more information on predefined LUs. This command is only valid for SMCS consoles. If the command is issued for a non-SMCS console, then message IEE044I is issued. If the console is active, the only LU value that would be accepted is the LU that the console is active on or *NONE*. If a different LU is specified for an active console, then message IEE045I is issued. The LU keyword cannot be specified if the OFFLINE keyword is specified. If the console is not active, any LU can be specified. This command requires MASTER authority. It might be protected with the RACF OPERCMDS resource class with the MVS.VARYLU.CN profile, which requires CONTROL authority. In addition, the MVS.VARY.CN profile, which requires UPDATE authority, must also be specified.

Value Range: Is from 2 to 8 characters. The first character must begin with the letters A through Z or with a #, \$, or @; the remaining characters can be A through Z, 0 through 9, or #, \$, or @.

MSCOPE

In a sysplex, specifies which systems the console is to receive messages from.

***ALL**

The console will receive system messages from all active systems in the sysplex.

* The console will receive system messages from the system it is attached to.

name

The console will receive system messages from the specified system name or system names in the sysplex.

OFFLINE

Deactivates an MCS, HMCS or SMCS console and places the device in offline status (has the same effect as VARY device,OFFLINE for the device, when VARY device,OFFLINE is issued on the system where the console is attached). VARY CN(...),OFFLINE is sysplex-wide in scope, and does not have to be issued from the system where the console is active. Attributes specified with the OFFLINE keyword will not be changed. The OFFLINE will deactivate the console, but the attribute changes will be ignored. If LU or LOGON were specified, then message ASA103I will be issued (and the OFFLINE will not execute). Any other keywords, message IEE871I will be issued, but the OFFLINE keyword will deactivate the console.

Note: For an HMCS console, VARY CN(consolename),OFFLINE is supported, but OFFLINE,FORCE is not supported.

VARY command

ONLINE

Activates a device defined in the CONSOLxx parmlib member as an MCS console. MVS determines the system on which to activate the console in the following order:

1. The system specified on the SYSTEM keyword (if you specify SYSTEM on the VARY CN command)
2. The system on which this console was last active (if the console was previously active)
3. The system specified on the SYSTEM keyword in CONSOLxx (if you specified SYSTEM on the CONSOLE statement in CONSOLxx for this device)
4. The system on which the command is processed.

VARY CN(...),ONLINE does not accept extended MCS or SMCS console names as input.

Note: Using the VARY CN(*consolename*),ONLINE command to activate an HMCS console is not supported.

If you specify a list of consoles, MVS attempts to process each console specified in the list:

- If a console is already active, MVS issues the same message (the DISPLAY C output - message CNZ4100I) as when activating a console.
- If a console is already active on another system (for example, if you specify SYSTEM=SYS1 and the console is already active on SYS2), then MVS issues message CNZ0005I.
- If the console cannot be activated, MVS issues a message appropriate to the situation. There are a number of such messages, including:
 - IEE025I (the console device has no logical paths)
 - IEE274I (the console name is not defined as a console in the sysplex)
 - IEE420I (the console is an extended MCS console)
 - IEE606I (the console name is not defined on this system)

FORCE

Activates an MCS console even when the console is being kept offline by a configuration manager. If you issue the VARY CN,ONLINE command and receive a message indicating that the device is being kept offline by a configuration manager, you can issue the VARY CN,ONLINE,FORCE command if necessary.

The FORCE keyword can only be specified if ONLINE is also specified.

When specified with the OFFLINE keyword, it acts just like a VARY dev,OFFLINE,FORCE command.

STANDBY

Deactivates an MCS or HMCS console and places the device in standby mode. VARY CN(...),STANDBY is sysplex-wide in scope, and does not have to be issued from the system where the console is active. If the MCS console is offline, STANDBY will attempt to bring the device online and place it in standby.

If you specify STANDBY, no other operands are accepted. STANDBY is not accepted for SMCS consoles, the system console, EMCS consoles, printer consoles, subsystem consoles or consoles in status display (SD) or message stream (MS) mode.

SYSTEM

Specifies the system on which the console is to be activated. SYSTEM overrides any default system specification (for example, the SYSTEM keyword on the CONSOLE statement). SYSTEM is valid only if you specify the ONLINE keyword.

The SYSTEM value applies to all values in the list of console names. If the system specified as the SYSTEM keyword value is not active in the sysplex, you will receive an error message.

ROUT

The routing codes of messages the console(s) can receive. These codes replace those previously assigned. See Table 12 on page 139 for a list of routing codes.

You can specify single routing codes (*rtcode*), ranges of routing codes (*rtcode-rtcode*), or a combination of single routing codes and ranges of routing codes on the same ROUT operand. For example, specifying ROUT(2,11-14,28) assigns routing codes 2, 11, 12, 13, 14, and 28.

Note: The system processes the ROUT, AROUT, and DROUT operands in the order that you specify them in the command.

ALL

The console receives all system-to-operator messages.

NONE

The console does not receive any system-to-operator messages.

rtcode

The console receives all messages with the specified routing codes. You can specify single routing codes (*rtcode*) or ranges of routing codes (*rtcode-rtcode*) on the same ROUT operand.

SUPSBY

Specifies if the specified console can be placed in standby mode:

Y The specified console can enter standby mode.

N The specified console should not enter standby mode. If the console is currently in standby mode, the command is rejected.

SUPSBY is not accepted for SMCS consoles, the system console, EMCS consoles, printer consoles, subsystem consoles or consoles in status display (SD) or message stream (MS) mode.

TIMEOUT

Specifies the automatic timeout value (*timeo*) for a console. The automatic timeout value is the time a console can have no input activity before any logged on user will be logged off.

timeo

Any value between 0 (meaning timeout processing for this console is turned off) to 99 (meaning the user will be logged off after 99 minutes of inactivity). For example, a value of 2 indicates a LOGOFF command will be issued for the console if there is no console input activity for at least 2 minutes (the LOGOFF command will be issued when the inactivity time is more than *timeo* minutes but less than (*timeo* + 1) minutes).

TIMEOUT is not accepted for the system console, EMCS consoles, printer consoles, subsystem consoles, or consoles in status display (SD) or message stream (MS) mode.

VARY command

UNKNIDS

Whether the specified console can receive messages which are directed to "unknown" console IDs. These IDs are one-byte IDs which the system cannot resolve.

Y The specified console is to receive these messages.

N The specified console is not to receive these messages. This is the default value.

Examples

Example 1: To assign master level authority to an active console named REMOTE, enter:

```
VARY CN(REMOTE),AUTH=MASTER
```

Example 2: To limit active console CON3 to receiving unsolicited messages from only systems SY3 and SY4, enter:

```
VARY CN(CON3),MSCOPE=(SY3,SY4)
```

Example 3: To add SY2 to the list of systems which will send unsolicited messages to active console CON3, enter:

```
VARY CN(CON3),AMSCOPE=SY2
```

Example 4: To activate consoles FRED and STAN, enter:

```
V CN(FRED,STAN),ONLINE
```

Example 5: To activate consoles ABLE and BAKER for use on system SYS1, enter:

```
V CN(ABLE,BAKER),ONLINE,SYSTEM=SYS1
```

Example 6: To activate console FRED, and at the same time to authorize FRED to enter informational, console control and system control commands, and receive messages for the primary operator, the tape pool, and the tape library, enter:

```
V CN(FRED),ONLINE,AUTH=(CONS,SYS),ROUT=(1,3,5)
```

Example 7: To set the automatic timeout value to 10 minutes for users on console NITTANY, enter:

```
VARY CN(NITTANY),TIMEOUT=10
```

VARY CONSOLE command

The VARY CONSOLE command is used to activate and set attributes for MCS consoles. This command is not used for extended MCS, HMCS or SMCS consoles.

Note: VARY CN is the recommended command to activate and change attributes of a console, because it has more features and it has sysplex scope. The VARY CONSOLE command only has system scope.

The syntax of the VARY CONSOLE command is:

```
V {conspec2|(conspec2[,conspec2]...)},CONSOLE
  [,AROUT=(rtcode[,rtcode]...)]
  [,AUTH={ALL|MASTER|INFO}([SYS][,IO][,CONS])}]
  [,DROUT=(rtcode[,rtcode]...)]
  [,ROUT={ALL|NONE|(rtcode[,rtcode]...)}]
```

Note: If you specify one device number, one AUTH=operand, or one routing code, you can omit the parentheses.

conspec2

conspec2 is one of the following:

[/]devnum

The device number of the console device.

0-[/]devnum

The device number of the console device preceded by the literal 'O-' to designate a device with output-only capability.

nnnnnnnn

The name of the console device as specified in the CONSOLxx Parmlib member CONSOLE statement (for example, 'TAPECNTL')

0-nnnnnnnn

The name of the console device as specified in the CONSOLxx Parmlib member CONSOLE statement preceded by the literal 'O-' and designates an output-only device (for example, 'O-TAPEPRNT').

The various types of *conspec* can be specified in any combination. If you specify only one *conspec*, you do not need to enter the parentheses.

A device number is 3 or 4 hexadecimal digits, optionally preceded by a slash (/). You can precede the device number with a slash to prevent ambiguity between the device number and a console name.

CONSOLE

The unit is to be an active console.

AUTH=

Specifies the system command groups that the console is authorized to enter. This command requires MASTER authority and might be protected with a security product OPERCMDS resource class with the MVS.VARYAUTH.CONSOLE profile, which requires CONTROL authority. In addition, the MVS.VARY.CONSOLE profile, which requires UPDATE authority, must also be specified. Table 10 on page 125 lists the commands and their associated groups.

ALL

The specified console(s) are authorized to enter INFO, SYS, IO, and CONS commands.

MASTER

The specified console(s) are authorized to enter all system operator commands.

INFO

The specified console(s) are authorized to enter only INFO commands.

(SYS, IO, CONS)

The specified console(s) are authorized to enter INFO commands as well as SYS, IO, or CONS commands (depending on which commands you include). Enter them in any order.

ROUT=

The routing codes of messages the console(s) can receive. These codes replace those previously assigned.

VARY command

Note: The system processes the ROUT, AROUT, and DROUT operands in the order that you specify them in the command.

ALL

The console receives all system-to-operator messages.

NONE

The console does not receive any system-to-operator messages.

rtcode

The console receives all messages with the specified routing codes. You can specify single routing codes (*rtcode*) or ranges of routing codes (*rtcode-rtcode*) on the same ROUT operand.

AROUT=*rtcode*

The system is to add the specified routing code(s) or the routing codes in the specified range(s) to the routing codes already defined for the console. You can specify single routing codes (*rtcode*) or ranges of routing codes (*rtcode-rtcode*) on the same AROUT operand.

DROUT=*rtcode*

The system is to remove the specified routing code(s) or the routing codes in the specified range(s) from the routing codes already defined for the console. You can specify single routing codes (*rtcode*) or ranges of routing codes (*rtcode-rtcode*) on the same DROUT operand.

Example 1:

To make consoles with device numbers 00C and 009 active, enter:

```
v (00c,009),console
```

Example 2:

To make the console with device number 01FA an active console authorized to enter informational, system control, and console control commands and to receive messages for the primary operator, the tape pool, and the tape library, enter:

```
v /01fa,console,auth=(cons,sys),rout=(1,3,5)
```

Example 3:

To remove routing codes 8, 31, 32, 33, 34, and 35 from the existing routing codes for the console with device number 2B0, enter:

```
v 2b0,console,dROUT=(8,31-35)
```

Example 4:

To vary a console named TAPE online, add routing codes 7 through 12 to the current routing codes the console receives, enter:

```
VARY TAPE,CONSOLE,AROUT=(7-12)
```

Example 5:

01F is to become an active console that is authorized to enter informational, system control, and console control commands and that receives messages for the primary operator, the tape pool, and the tape library.

```
V 01f,console,auth=(cons,sys),rout=(1,3,5)
```

Example 6:

To remove routing codes 8, 31, 32, 33, 34, and 35 from the existing routing codes for console CON2, enter:

```
v con2,console,dROUT=(8,31-35)
```

Example 7:

To vary a console named TAPE online, add routing codes 7 through 12 to the current routing codes the console receives, enter:

```
VARY TAPE,CONSOLE,AROUT=(7-12)
```

Controlling hardcopy processing

Use the HARDCPY form of the VARY command to do the following:

- Change the set of messages included in the hardcopy message set
- Assign either SYSLOG or OPERLOG to be the hardcopy medium
- Stop the hardcopy medium.

The system establishes hardcopy processing during system initialization based on the HARDCOPY statement in the CONSOLxx member of Parmlib. The ROUTCODE and CMDLEVEL parameters define messages that are included in the hardcopy message set.

The syntax of the VARY HARDCPY command is:

```
V [OPERLOG],HARDCPY[,CMDS|,NOCMDS|,STCMDS|,INCMDS]
  |SYSLOG          [,AROUT=(rtcode[,rtcode]...)]
                  [,DROUT=(rtcode[,rtcode]...)]
                  [,ROUT={ALL|NONE          }]
                  { (rtcode[,rtcode]...)}
                  [,OFF[,UNCOND]]
```

OPERLOG

The operations log is to be activated or deactivated.

When you omit the SYSLOG or OPERLOG operands, the system changes what goes into the hardcopy log, rather than the hardcopy log medium.

SYSLOG

The system log is to become the hardcopy medium.

HARDCPY

The system changes the hardcopy medium or the hardcopy message set, or both, depending on the options specified.

The following NOCMDS, INCMDS, STCMDS, and CMDS options correspond to the CMDLEVEL specifications of the HARDCOPY statement:

NOCMDS

The system is not to include operator commands or their responses in the hardcopy message set.

Note: If hardcopy support is required and you specify NOCMDS, the system will not allow NOCMDS and will choose CMDLEVEL=CMDS. (Hardcopy support is required when one or more display consoles are defined in a system.)

VARY command

INCMDS

The system is to include operator commands and their responses, excluding any status displays, in the hardcopy message set.

STCMDS *or* CMDS

The system includes all operator and system commands, their responses, and status displays in the hardcopy message set. As of z/OS V1R8, STCMDS and CMDS are equivalent.

Note: The following descriptor codes are associated with the listed options:

Options	Descriptor Codes
NOCMDS	None
INCMDS	5
STCMDS	5, 8, 9
CMDS	5, 8, 9

OFF

The system is to stop the hardcopy medium.

If you do not specify SYSLOG or OPERLOG, the system defaults to the hardcopy medium (SYSLOG) if it is active; otherwise, the system rejects the command. The system will not deactivate the operations log unless OPERLOG is specified. If you specify OPERLOG, the operations log must be active.

The system rejects this command if it would result in both the hardcopy log and the operations log becoming inactive.

When OFF is specified without UNCOND, it must be the last parameter.

UNCOND

Use UNCOND with OFF to specify that the system is to stop the hardcopy medium. The system saves messages depending on the hardcopy medium status:

Hardcopy medium and state	Whether messages are saved
Only SYSLOG is active and is varied off with UNCOND	Yes
Only OPERLOG is active and is varied off with UNCOND	No
Both SYSLOG and OPERLOG are active and SYSLOG is varied off with UNCOND	Yes
Both SYSLOG and OPERLOG are active and OPERLOG is varied off with UNCOND	No

Note:

1. Messages are saved for SYSLOG until the LOGLIM value is reached, after which the messages will then be discarded.
2. If the hardcopy medium is SYSLOG, and SYSLOG has never been activated in the system, messages will not be saved.

The use of UNCOND should be a temporary measure, and should be done only as a last resort in order to repair hardcopy functions. The installation

might lose messages from hardcopy if too long a period elapses before the hardcopy medium is restored. The system issues message IEE012A when messages are no longer being saved.

When UNCOND is specified with OFF, UNCOND must be the last parameter.

ROUT=

The system is to include messages with the specified routing code or codes in the hardcopy message set. In addition to the routing codes you specify, the hardcopy message set also includes messages with the minimum set of routing codes (1,2,3,4,7,8,10, and 42) established at initialization by the HARDCOPY statement of CONSOLxx.

ALL

All routing codes (1-128) are used to select messages for the hardcopy message set.

NONE

No routing codes are used to select messages for the hardcopy message set.

rtcode***rtcode – rtcode***

The specified routing code or codes are used to select messages for the hardcopy message set. *rtcode* is a decimal number from 1 to 128. You can specify a single routing code, a range of routing codes, or a combination of both.

AROUT

The system is to include messages with the specified routing code or codes in the hardcopy message set, in addition to any messages included because of prior routing code specifications.

rtcode***rtcode – rtcode***

The specified routing code or codes, in addition to currently used routing codes, are used to select messages for the hardcopy message set. *rtcode* is a decimal number from 1 to 128. You can specify a single routing code, a range of routing codes, or a combination of both.

DROUT

The system is to stop including messages with the specified routing code or codes in the hardcopy message set.

rtcode***rtcode – rtcode***

The specified routing code or codes are no longer used to select messages for the hardcopy message set. *rtcode* is a decimal number from 1 to 128. You can specify a single routing code, a range of routing codes, or a combination of both.

Note: At system initialization, processing of the HARDCOPY statement of the CONSOLxx member of Parmlib sets up a minimum set of routing codes (1,2,3,4,7,8,10, and 42) in addition to any other specified for the hardcopy message set.

The system processes the ROUT, AROUT, and DROUT operands in the order that you specify them.

Example 1:

VARY command

To include all operator commands, responses, and status displays (except dynamic status displays) in the hardcopy message set, enter:

```
V ,HARDCPY,STCMDS
```

Example 2:

To have the hardcopy message set recorded on the system log, enter:

```
V SYSLOG,HARDCPY
```

Example 3:

To add routing codes 11, 12, 13, 17, and 44 to the routing codes already defined for the hardcopy message set, enter:

```
V ,HARDCPY,AROUT=(11-13,17,44)
```

Example 4:

To have the hardcopy message set recorded on the operations log, enter:

```
V OPERLOG,HARDCPY
```

Placing a console online or offline

Use the following form of the VARY command to make a secondary console either online as an I/O device or offline. As a device, it will become inactive as a console. This command can be used to make an SMCS console offline, however, it cannot be used to make an SMCS console online.

Note: The VARY CN command is the recommended command to deactivate a console because it has sysplex scope. This VARY command only has system scope.

```
V (conspec[,conspec]...),{OFFLINE|ONLINE}
```

conspec

conspec is the console device to be moved online or offline and is specified as one of the following:

[/]devnum

The device number of the console device.

0-[/]devnum

The device number of the console device preceded by the literal 'O-' to designate a device with output-only capability.

nnnnnnnn

The name of the console device as specified in the CONSOLxx Parmlib member CONSOLE statement (for example, 'TAPECNTL')

0-nnnnnnnn

The name of the console device as specified in the CONSOLxx Parmlib member CONSOLE statement preceded by the literal 'O-' to designate an output-only device (for example, 'O-TAPEPRNT').

[/]lowdevnum-[/]highdevnum

The *lowdevnum* is the device number of an input/output device that is the lower bound of a range of device numbers and *highdevnum* is the device number of an input/output device that is the upper bound of the range.

The various types of *conspec* can be specified in any combination. If you specify only one *conspec*, you do not need to enter the parentheses.

A device number is 3 or 4 hexadecimal digits, optionally preceded by a slash (/). You can precede the device number with a slash to prevent ambiguity between the device number and a console name.

ONLINE

The system is to bring the specified device(s) online. If the specified device is a console, this command will de-activate it as a console.

OFFLINE

The system is to take the specified device(s) offline. If the specified device is a console, this command will de-activate it as a console.

Example 1:

To take consoles 003 and 001 offline, enter:

```
V (003,001),OFFLINE
```

Example 2:

To take consoles 3322,340A offline, enter:

```
V (/3322,/340A),OFFLINE
```

Processing devices or a path to devices attached to a control unit

Use the VARY CU command to process devices or a path to devices attached to a control unit. For example, you can:

- Vary all devices attached to a control unit online or offline.
- Define all tape devices attached to a control unit as automatically switchable.
- Make all tape devices attached to a control unit unavailable or available.
- Vary a CHPID to all devices attached to a control unit online or offline.

Note: Because the VARY CU command starts VARY DEVICE or VARY PATH operations, you need to be familiar with VARY DEVICE and VARY PATH command operations, restrictions, warnings and the functions of the keywords for these commands. For more information on VARY DEVICE and VARY PATH, see:

- “Placing an I/O device or a range of I/O devices online or offline” on page 941
- “Defining a tape device as automatically switchable” on page 940
- “Allowing or preventing allocation from using an offline tape device” on page 946
- “Placing an I/O Path or Paths Online or Offline” on page 948

For one of the error cases listed in message IEE902I, an error message is issued to the console. Otherwise, VARY DEVICE or VARY PATH operations are initiated on devices attached to a control unit. For details about message IEE902I, see *z/OS MVS System Messages, Vol 7 (IEB-IEE)*.

Note: VARY DEVICE or VARY PATH operations started as a result of a VARY CU command cause individual messages to be generated for each device or path being processed. Because no message consolidation or message suppressing is done, a large number of messages may be issued to the console. You need to ensure that the VARY CU command is not excessively issued.

VARY command

The syntax of the VARY CU command is:

```
V CU {(cunumber)}, {ONLINE[,UNCOND[,FORCE] | ,SHR | ,RESET]}
      {OFFLINE[,FORCE]
      {AUTOSWITCH | AS [,ON | OFF]
      {UNAVAILABLE | UNAVAIL
      {AVAILABLE | AVAIL
V CU {(cunumber, chpid)}, {ONLINE[,FORCE]
      {OFFLINE[,UNCOND | ,FORCE]}
```

Default: None

Notes:

1. Only one control unit or one channel path can be specified at a time.
2. When issued on a console, the VARY CU command keywords propagate to each device, device pair, or *chpid* pair to be processed. They perform the same functions when used with a VARY DEVICE or a VARY PATH command.
3. Certain keywords or parameters are valid for certain requests or for certain device types only. For example, OFFLINE,UNCOND is acceptable for a VARY PATH request, but is not acceptable for a VARY DEVICE request. AUTOSWITCH can only be used for tape devices. The VARY CU syntax checker also recognizes these cases and issues error messages.

cunumber

The control unit number. When a VARY CU command is issued with *cunumber* only, VARY DEVICE operations are performed on all the devices attached to the control unit.

chpid] The channel path associated with the devices attached to the control unit. When a VARY CU command is issued with a CU number and a CHPID, VARY PATH operations are performed on the specified *chpid* of all devices attached to the control unit.

Defining a tape device as automatically switchable

Use the following form of the VARY command to change the automatically switchable characteristic (or the AUTOSWITCH attribute) of a tape device. The setting does not persist beyond the duration of the IPL.

VARY AUTOSWITCH is not valid for tape devices that are:

- Online. For a device that is online, issue the VARY OFFLINE command before you issue VARY AUTOSWITCH.
- Managed by JES3.

```
V {(devspec[,devspec]...)}, { [AUTOSWITCH|AS] [,ON|OFF] }
```

devspec

devspec is one of the following:

[/]devnum

The device is not assign capable.

lowdevnum-highdevnum

lowdevnum is the lower bound of a range of device numbers. *highdevnum* is the upper bound of the range.

A device number is 3 or 4 hexadecimal digits.

AUTOSWITCH or AS

The system is to turn on or off the AUTOSWITCH attribute of the tape device or range of tape devices you specified.

If you specify the VARY AUTOSWITCH command for a tape device that is online or managed by JES3, the system alerts you to the error.

- If you specify a list of devices (for example, VARY (281,282,283),AS,ON), the system returns a message for each device that is not valid.
- If you specify a range of devices (for example, VARY (281-283),AS,ON), you receive a DISPLAY command response that lists the status (including the AUTOSWITCH status) for devices in the specified range.

For more information about automatically switchable tape devices, see *z/OS MVS Setting Up a Sysplex*.

ON The system is to turn on the AUTOSWITCH attribute for the device or devices you specified.

OFF

The system is to turn off the AUTOSWITCH attribute for the device or devices you specified.

Example 1:

To turn on the AUTOSWITCH attribute for tape devices 282, 283, and 287, enter:
VARY (282,283,287),AS,ON

Placing an I/O device or a range of I/O devices online or offline

Use the following form of the VARY command to place I/O devices online or offline.

```
V { (devspec[,devspec]...), { ONLINE[,UNCOND] [,FORCE] }
  { devspec } | ,SHR
                | ,RESET
                { OFFLINE[,FORCE] } }
```

In a JES2 environment, use this command to specify that a cartridge tape device (such as a 3490) is to be shared among more than one system.

Use this form of the VARY command with care in a JES3 environment. For devices managed by JES3, issue a *VARY command instead of the MVS VARY command to change online or offline status. See “Placing Devices Online or Offline to JES3” in *z/OS JES3 Commands*.

devspec

devspec is one of the following:

[/]devnum

The device number of an I/O device.

0-[/]devnum

The device number of a console device preceded by the literal ‘O-’ to designate a device with output-only capability.

VARY command

nnnnnnnn

The name of a console device as specified in the CONSOLxx Parmlib member CONSOLE statement.

0-nnnnnnnn

The name of a console device as specified in the CONSOLxx Parmlib member CONSOLE statement preceded by the literal 'O-' to designate an output-only device.

[/]lowdevnum-[/]highdevnum

lowdevnum is the device number of an I/O device that is the lower bound of a range of device numbers. *highdevnum* is the device number of an I/O device that is the upper bound of the range.

The various types of *devspec* can be specified in any combination, either a valid console name or a valid device number. The console name check will be made first and valid console names accepted. If you specify only one *devspec*, you do not need to enter the parentheses.

A device number is 3 or 4 hexadecimal digits, optionally preceded by a slash (/). You can precede the device number with a slash to prevent ambiguity between the device number and a console name.

RESET, UNCOND and SHR keywords are ignored for console-capable devices. VARY of a range of devices is supported for console-capable devices.

ONLINE

The system is to bring the specified devices or ranges of devices online, that is, make the devices or ranges of devices available for allocation to problem programs and system tasks, if there is an online path to the devices. In a system-managed tape library, if the file tape drives within the library were placed offline with both the VARY device and VARY SMS commands, then you must issue both commands to place those devices online. If you bring a device online and you want the system to recognize a volume mounted while the device was offline, enter a MOUNT command for the device.

Note:

1. Varying an UNAVAILABLE device online will cause it to be marked both AVAILABLE and ONLINE.
2. If you specify a device that is not physically attached to its control unit, the system might consider the device operational and online. If an attempt is later made to allocate the device to a job, the attempt might fail, in which case the job would have to be canceled.
3. Bringing a device online cannot bring online I/O paths that have been taken offline with a VARY PATH command.
4. Switch actions that restrict a channel's access to devices or control units might cause the command to be unsuccessful. If this is the case, adjust your switch configuration to make sure there is an online path to the device.
5. If you issue a VARY device ONLINE command for a device whose last path has been taken offline with a VARY PATH OFFLINE command, the system issues the following message:
IEE025I UNIT ddd HAS NO LOGICAL PATHS
6. If you specify a range of devices and any or all of them are not valid, you receive message IEE313I indicating the device numbers that are not valid.

7. For an automatically switchable tape device, the VARY ONLINE command brings the device online to the issuing system. This makes the device available to be allocated to that system. The device will be assigned when it is allocated.

UNCOND

The system is to bring the specified devices or range(s) of devices online, even if there are no paths to the devices or if the devices are pending offline and boxed. The system ignores this operand if you specify it for a tape or direct access device that does not have a path. Use the UNCOND operand carefully because it causes inaccessible devices to appear accessible to some system components.

You can use the VARY bbbb,ONLINE,UNCOND command to correct problems when HyperPAV aliases are not properly used. Such an error condition occurs when non-FICON channels are configured online to a HyperPAV-capable control unit. Because MVS operates on base devices within that logical subsystem in base only mode, MVS cannot use alias devices for bases in the logical control unit. You can detect this condition by outstanding message IOS166E or by using the D M=DEV(bbbb) command, where bbbb is a base device in the logical control unit. MVS can use the HyperPAV aliases only after the non-FICON channels are removed from the HyperPAV configuration or these channels are configuring offline. However, it may be necessary under this or other conditions to force MVS to rediscover aliases that were not discovered previously. Use the VARY bbbb,ONLINE,UNCOND command where bbbb is an online base device in the logical control unit.

SHR

The system permits the sharable tape device you bring online to be shared among other processors. The system ignores the SHR keyword when specified for a device that is not assign capable. Share a tape device between processors only at the direction of the system programmer.

Do not use this keyword:

- For devices managed by JES3. JES3-managed devices are automatically sharable within the JES3 complex.
- For automatically switchable devices. If you use the SHR keyword, the system rejects the command because it is incompatible with automatic tape switching.

Do not confuse the sharing of tape devices (through the SHR keyword) with automatically switchable tape devices. The SHR keyword allows many systems sharing a key to access a single tape device at one time. Although automatically switchable devices are varied online to many systems at one time, only one system can actually access a device at one time.

RESET

The system is to bring online a device that is being kept offline because of a control-unit-initiated reconfiguration (C.U.I.R.).

OFFLINE

The system is to take the specified device(s) or range(s) of devices offline, that is, make the device(s) or range(s) of devices unavailable for allocation to application programs or system tasks. The system takes offline any device that is currently in use only after all the tasks to which it is allocated terminate.

Note:

1. When you issue a VARY OFFLINE command, the system immediately places the specified device(s) in the "pending offline" state. A device in the

VARY command

pending offline state cannot be allocated — even if the job specifically requests the volume mounted on the device — unless the allocated/offline device installation exit is used to allow allocation or the operator selects the device in response to message IEF238D.

2. If a WTOR message IEF238D is outstanding, that is, has not yet been replied to, VARY OFFLINE activity cannot take place.
3. Also, while a message IEF238D remains outstanding, no other allocations can proceed for any devices in the same group as the device(s) waiting for the IEF238D response. For example, if a job is in allocation recovery trying to allocate a 3490 device (UNIT=3490), no other D/T3490 allocation will take place until the message IEF238D is satisfied. Similarly, if a job is trying to allocate a device in a device group named, say, CARTNY (UNIT=CARTNY), then no devices in CARTNY will be allocated until message IEF238D is satisfied.

The VARY device OFFLINE command takes effect immediately if the resources are available and the device is not allocated or when a system task starts.

When the specified device(s) is offline, you receive message IEF281I and, if you have not specified FORCE, the system rewinds and unloads all specified tape drives except for JES3-managed tape drives. All devices taken offline remain offline until you enter VARY device ONLINE commands for them or specify them in response to a system request for devices.

Note: When you specify VARY OFFLINE for a range of devices:

- If some or all of the devices are valid, you receive a status display of those devices in each range.
- If some or all of the devices are valid and are alternate path device numbers, or do not have device names assigned to their UCBs, you receive message IEE712I, stating that VARY processing has finished.
- If any of the devices are not syntactically valid, you receive message IEE313I indicating the device numbers that are invalid.

Make sure, when you specify a range of devices to be taken offline, that the range does not include any console device numbers.

CAUTION:

Never take any device offline if that device holds SYS1.DUMPxx data sets unless you first remove the SYS1.DUMPxx data sets from the system's list of SYS1.DUMPxx data sets with a DUMPDS DEL,DSN= command.

FORCE

You can specify FORCE with ONLINE or OFFLINE. The effect on the system is quite different, as described in the following.

FORCE specified with OFFLINE: When specified with the OFFLINE keyword, FORCE puts the specified device or devices immediately in pending offline status, even if they are currently active, allocated, reserved or assigned. The system stops I/O in progress on the devices and rejects future I/O requests to the devices as permanent I/O errors.

You can issue VARY device,OFFLINE,FORCE only from the master authority console.

If JES3 manages a device, VARY device,OFFLINE with FORCE still marks the device as pending offline to MVS. Any allocated device put into pending offline status with FORCE remains allocated to the user who owns it when you issue the VARY command. The system actually takes the device offline when

all users have deallocated it. (The system does not allocate a device put into pending offline status with FORCE to any new job, regardless of how the job requests the device.)

You can also use VARY device,OFFLINE,FORCE to take any console.

When the system takes a device offline as a result of a VARY device,OFFLINE,FORCE command, you can usually bring the device online and make it available for I/O again by issuing a VARY device,ONLINE command. If, however, there are no physical paths to the device or the device is non-operational, you can place the device online only with a VARY device,ONLINE,UNCOND command. (Note that the system ignores the UNCOND operand if you specify it for a tape or direct access device.) A device brought online with UNCOND remains unavailable for I/O until you either supply it with a physical I/O path or make it fully operational again.

Note:

1. Use VARY device,OFFLINE,FORCE only with great care in situations where the system is in serious trouble. Even if a specified device is already offline, the command immediately terminates all I/O in progress on the device; future I/O requests to the device are rejected as permanent I/O errors. Thus, the command might cause the loss of data, as well as a data integrity problem if the command prematurely releases a reserved device or unassigns an assigned device.
2. If you issue VARY device,OFFLINE,FORCE for a CTC adapter used by global resource serialization, be sure that you issue the command from both of the systems attached to that CTC adapter.
3. When you issue VARY ctc,OFFLINE,FORCE for a CTC adapter used by global resource serialization, you will be prompted by message ISG186D. Reply KEEP to take the CTC offline normally, allowing GRS to use the CTC when it is brought back online. Reply FREE to take the CTC away from GRS permanently. This will allow the installation to allocate the CTC to XCF signalling. See *MVS System Messages* for more information about message ISG186D.

FORCE specified with ONLINE: When specified with the ONLINE keyword, FORCE places the specified device or devices online even if they are being kept offline by a configuration manager.

Example 1:

To make devices 282, 283, and 287 available for system use, enter:

```
vary (282,283,287),online
```

Example 2:

To take offline any devices in the range 283 through 287 and the range 130 through 135, enter:

```
V (283-287,130-135),OFFLINE
```

Example 3:

To make device 282 available for system use even if there is no path to the device, enter:

```
V 282,ONLINE,UNCOND
```

VARY command

Example 4:

To terminate I/O to device 282, enter:

```
V 282,OFFLINE,FORCE
```

Message IEE800D asks you to confirm this command, which would cause the system to stop I/O in progress on device 282 and reject future I/O requests to the device as permanent I/O errors. Reply NO to message IEE800D to terminate the command and leave the status of the device unchanged. Reply YES to have the system stop I/O on the device, reject future I/O requests to the device, and mark the device pending offline (if device 282 is not already offline).

Allowing or preventing allocation from using an offline tape device

Use the following form of the VARY command to allow or prevent offline tape devices from being eligible for use by Allocation.

```
V {(devspec[,devspec]...),{AVAILABLE|AVAIL  }  
  {devspec          } {UNAVAILABLE|UNAVAIL}
```

devspec

devspec is one of the following:

[/]devnum

The device number of an I/O device.

[/]lowdevnum-[/]highdevnum

lowdevnum is the device number of an I/O device that is the lower bound of a range of device numbers. *highdevnum* is the device number of an I/O device that is the upper bound of the range.

The various types of *devspec* can be specified in any combination. If you specify only one *devspec*, you do not need to enter the parentheses.

A device number is 3 or 4 hexadecimal digits, optionally preceded by a slash (/).

AVAILABLE or AVAIL

The specified device or devices are marked available for allocation.

UNAVAILABLE or UNAVAIL

The specified device or devices are marked unavailable and cannot be used by MVS Allocation for device requests.

Note:

1. Using VARY xxxx, UNAVAILABLE causes MVS Device Allocation and DDR SWAP processing to ignore the offline device when selecting a device for use by a program. Thus, operators see fewer devices in the IEF877E message. More failed allocations for subsystems do not allow Recovery Allocation in environments that are already device constrained.
2. To display the devices in the UNAVAILABLE state, use the D U, TAPE, UNAVAIL command.

Controlling a global resource serialization complex

Use the VARY GRS command to:

- Temporarily remove a system from the global resource serialization ring complex.
- Restore a quiesced system to the global resource serialization ring complex.
- Remove a system from the global resource serialization ring complex.
- Rebuild a disrupted global resource serialization ring complex. (that is, a group of inactive or quiesced systems)

Note: Because the VARY GRS command is not valid when all of the systems in a global resource serialization complex are in the same sysplex, use the V XCF,*sysname*,OFFLINE command.

For more information on GRS and the sysplex, refer to *z/OS MVS Planning: Global Resource Serialization* and *z/OS MVS Setting Up a Sysplex*.

The following table shows the support for the VARY GRS commands during that time when an installation is migrating to a cross-system coupling facility sysplex.

Command	COMPLEX=SYSPLEX	Mixed Complex
VARY GRS,QUIESCE	Command rejected; message ISG153I issued	Command accepted
VARY GRS,RESTART	Command rejected; message ISG153I issued	Command accepted
VARY GRS,PURGE	Command rejected; message ISG153I issued	Command accepted:

Note: If the target system of a VARY GRS,PURGE command is a member of a sysplex with more than one system, it will be put into a non-restartable wait state.

Use the VARY GRS command mainly for recovery situations.

```
V GRS({(sysname|*|ALL)},{RESTART|R})
      {(sysname|*)},{QUIESCE|Q}  }
      {(sysname)},{PURGE|P}      }
```

sysname

The name of the system (specified on the SYSNAME system parameter). This name can be up to eight characters long and can contain any characters except commas and blanks.

- * The name of the current system (the system on which you enter the command). Specifying an asterisk means you want to change the current system's status in the global resource serialization ring.

ALL

You want to change the status of all systems in the global resource serialization ring.

RESTART or R

You want to restore a quiesced (or inactive) system to the global resource serialization ring or rebuild a global resource serialization ring that has been disrupted. (When rebuilding a disrupted ring, you can specify ALL with RESTART.) Once this command takes effect, the system processes all previously-suspended requests for global resources. Restarting a system or

VARY command

restarting the ring requires an active system. An inactive system can make itself active and restart the ring. If, however, all systems are quiesced, issuing VARY GRS with RESTART invokes the reactivate function. Reactivating the ring avoids a complex wide re-IPL but can introduce data integrity exposures. Allow the reactivate function to proceed only on instructions from your system programmer.

QUIESCE or **Q**

You want to temporarily remove a system from the global resource serialization ring. Requesters of global resources on the quiesced system hold on to all global resources they own and hold their position in the queues for those resources they do not own. Global resource serialization suspends processing of all new requests for global resources.

PURGE or **P**

You want to remove a quiesced system from the global resource serialization complex.

If the system specified on the purge command is active, global resource serialization issues messages that describe the situation. Depending on your response, GRS will quiesce the system and then continue with the purge. All global resources owned by the system you purge are released and all outstanding requests for global resources made by the system you purge are deleted. Use this option when a system is no longer running and needs a re-IPL.

Note: Indiscriminate use of the VARY GRS,PURGE command can cause resource integrity problems and can put the system in a non-restartable wait state. Notify the system programmer if the system you are purging holds any resources.

Placing an I/O Path or Paths Online or Offline

Use the following form of the VARY command to place online or offline a path to a device or a range of devices. A path is the logical route between a processor and a device. A path can be offline if:

- One or more of the path components is offline
- A VARY PATH OFFLINE command has been entered

Note:

1. Path(s) taken offline with a VARY PATH command can only be brought online again with another VARY PATH command.
2. In a JES3 environment, if a device is being used by JES3, or allocated to a job by JES3, the system will not take offline the last path to that device.
3. When MVS takes the last path to a device offline, the device is also taken offline. In a JES3 environment, it also takes the device offline to JES3.
4. When MVS brings the first path to a device online, the device is also brought online (if it is not in use). In a JES3 environment, the device is also brought online to JES3.
5. The VARY PATH command cannot be used on paths that are defined as managed. To manipulate managed paths, use the VARY SWITCH command. (See "Placing a switch port online or offline" on page 969.)

```

V PATH
{ ([/]devnum, chp[, [/]devnum, chp]...) }
{ (([/]devnum[, [/]devnum]...), chp
  [, ([/]devnum[, [/]devnum]...), chp]...) }
{ (([/]lowdevnum-[/]highdevnum), [/]lowdevnum-[/]highdevnum)...), chp }
  [, ([/]lowdevnum-[/]highdevnum[, chp]...)]
{ (cfname, chp[, cfname, chp]...) }
{ ((cfname[, cfname]...), chp
  [, (cfname[, cfname]...), chp]...) }
{ , ONLINE[, FORCE] }
{ , OFFLINE[, UNCOND | , FORCE] }

```

PATH

The system is to move the specified path(s) online or offline.

[/]devnum

The device number of a device associated with the path the system is to move online or offline.

[/]lowdevnum-[/]highdevnum

The device numbers of a range of devices associated with the paths the system is to move online or offline. The lower device number of each range is *lowdevnum* and the higher device number of each range is *highdevnum*.

cfname

The name of a single coupling facility associated with the path(s) the system is to logically move online or offline. *cfname* can be up to 8 alphanumeric characters long.

chp

The channel path associated with the path(s) the system is to move online or offline. You can specify for *chp* any number from 00 to FF.

Device numbers and coupling facility names can be specified in any combination. If you specify only one device number or coupling facility name, you do not need to enter the parentheses.

A device number is 3 to 5 hexadecimal digits, optionally preceded by a slash (/). You can precede the device number with a slash to prevent ambiguity between the device number and a coupling facility name. Five-digit logical device numbers consist of a one-digit subchannel set ID plus a four-digit device number. If a 3-digit or 4-digit device number is entered in the command, then the device information representing subchannel set 0 is used for the display even if the actual subchannel connected to the device is in subchannel set 1. If a 5-digit device number is entered, the device information representing the specified subchannel set is displayed. If a range of device numbers is found and the first number is 5 digits, the second number in the range must be 5 digits and vice-versa.

ONLINE

The system is to bring the path(s) online.

VARY command

If a path is offline for port decommissioning reasons when the VARY PATH(*devnum, chpd*), ONLINE command is issued, the system does not attempt to bring the path online and the setting of the flag offline by switch remains unchanged.

FORCE

The system is to bring back online the path previously taken offline.

If the path was taken offline by Enterprise System Connection Manager (ESCM), then use ESCM to bring the path back online. Use the VARY PATH, ONLINE, FORCE command only if ESCM is not available and the path is physically available.

If the path is quiesced by Control Unit Initiated Reconfiguration (C.U.I.R.), the VARY PATH, ONLINE, FORCE command can be used to bring the path back online.

If FORCE is specified and the path is offline for port decommissioning reasons, the system attempts to bring the path online and clear the conditions for which the path is offline. However, the path cannot be brought online if either the ingress or egress switch ports used by this path are still offline (for example, blocked, in maintenance mode, or service required).

OFFLINE

The system is to take the specified path(s) offline. The system rejects this command if the specified path is the last available path to a device that is any one of the following:

- Online (either allocated or unallocated)
- Allocated (either online or offline)
- In use by the system
- A console
- Assigned to JES3
- A coupling facility

UNCOND

The system is to take the path offline. The system rejects the VARY PATH, OFFLINE, UNCOND command if the specified path is the last available path to a device that is any one of the following:

- Allocated
- In use by the system
- A console
- Assigned to JES3
- A coupling facility, and one or more structures are in use by an active XES connection on the system offline

In other words, adding the UNCOND keyword to the VARY PATH, OFFLINE command requests that the system take offline those last paths to devices that are online but unallocated.

FORCE

The system is to take the specified path(s) offline. If Dynamic Pathing (DPS) Validation is invoked, the system will issue DISBAND/REGROUP Set Path Group ID (SPID) commands on the paths that are remaining online, instead of RESIGN SPIDs on the path

that is coming offline. The system rejects this command if the specified path is the last available path to a device that is any one of the following:

- Allocated (either online or offline)
- In use by the system
- A console
- Assigned to JES3
- A coupling facility

Example :

Enter the following command to take offline the paths through channel path 2 leading to devices 130, 133, 134, 135, and 140.

```
V PATH((130,133-135,140),2),OFFLINE
```

The system issues a message describing the path status for each device.

Assume that channel path 2 represents the last paths to device 134, which is online and allocated, and device 135, which is online and unallocated. A VARY PATH((134,135),2),OFFLINE,UNCOND command would remove the last path to device 135 but not 134. The jobs using device 134 must end or be terminated before the last path can be removed.

Changing the state of coupling facility cache structures and volumes

Use the VARY SMS command to control SMSVSAM processing. The scope of most of these commands is sysplex wide. Some, however, such as VARY SMS,SMSVSAM,ACTIVE is not sysplex wide. For more information, see *z/OS DFSMSdfp Storage Administration*.

The syntax of the VARY SMS command is:

```
V SMS,{CFCACHE(cachename),{ENABLE|E }      }
      {                                     }
      {QUIESCE|Q}                          }
      {CFLS(lockstructurename),{ENABLE|E }  }
      {                                     }
      {QUIESCE|Q}                          }
      {CFVOL(volid),{ENABLE|E }             }
      {                                     }
      {QUIESCE|Q}                          }
      {MONDS(dsname[,dsname...]),{ON|OFF}   }
      {SHCDS(shcdsname),{NEW                }
      {                                     }
      {NEWSPARE}                            }
      {DELETE }                             }
      {SMSVSAM,{ACTIVE                      }
      {SPHERE(spherename),{ENABLE|E}       }
      {QUIESCE|Q}                          }
      {FALLBACK                             }
      {TERMINATESERVER                      }
      {FORCEDELETELOCKSTRUCTURE(lockstructurename)}
```

CFCACHE(cachename)

To change the state of a cache structure, specify the name of the cache structure (structurename).

If you specify ENABLE, VSAM RLS data can be stored in cache structure. This is the normal state of operations and the state the coupling facility cache structure is in after sysplex IPL.

VARY command

If you specify QUIESCE, you cannot store any VSAM RLS data in the cache structure.

The QUIESCE operation is not complete until the state of the volume is quiesced. Use the D SMS,CFVOL to determine the state of the volume.

CFLS(lockstructurename)

To change the state of a secondary lock structure, specify the name of the lock structure (lockstructurename).

If you specify ENABLE, VSAM RLS secondary lock structures can be accessed. When the lock structure is enabled, SMSVSAM attempts to connect to the structure. This structure is marked available when a SMSVSAM sphere is opened. This structure might be selected to hold the sphere record locks if it is in the lock set that is specified in the storage class for the VSAM sphere.

If you specify QUIESCE, VSAM RLS secondary lock structures cannot be accessed. Any spheres that open for VSAM RLS access are not allowed to select the specified lock structure name. All existing usage of this secondary lock structure are not affected. When all spheres across all systems that are assigned to this secondary lock structure close, the secondary lock structure transitions from Quiescing to Quiesced.

All DFSMS lock structures are defined as persistent connections and persistent structures. When the secondary lock structure transitions to Quiesced state, SMSVSAM does not issue the MVS command to have the lock structure UNALLOCATED in the coupling facility. The secondary lock structure can only be unallocated using the operator command:

```
V SMS,FORCEDELETELOCKSTRUCTURE(lockstructurename)
```

V SMS,CFLS(IGWLOCK00), Enable|Quiesce is rejected. IGWLOCK00 cannot be quiesced.

CFVOL(void)

To change the state of a volume as it relates to coupling facility cache structures, specify the volume (void).

If you specify ENABLE, data contained on this volume can be stored in a coupling facility cache structure. This is the normal state of operations.

If you specify QUIESCE, you cannot store any data from the volume on the coupling facility cache structure.

Note: If you specify QUIESCE, SMS might still select the volume during data set allocation. To stop SMS from selecting this volume, see "Changing the SMS status of a storage group or volume" on page 956.

MONDS(dsname[,dsname...]),ON|OFF

To specify the data set name (dsname) or data set names (dsname[,dsname...]) you want to be eligible for coupling facility statistical monitoring, specify ON.

To indicate that the specified data set is no longer eligible for statistical monitoring, specify OFF.

Monitoring is tracked through SMF record 42 subtype 16.

You can specify a full or partial data set name with at least one high level qualifier. An asterisk (*) cannot be followed by other qualifiers; "*" and "**" can only be specified at the last qualifier, such as xxx.* or xxx.**. You can specify up to 16 data set names with each command.

However, for MONDS(IGWVSAM.BASE.DATA.TRAP), the following rules apply:

- The maximum length for the entire data set mask is 44 characters.
- You can specify an asterisk (*) or percent sign (%) anywhere except in the first position.
- A "%" represents a single character position. For instance, "%%" represents three character positions.
- A single "*" by itself indicates that at least one qualifier must occupy that position. A "*" within a qualifier means that zero or more characters can be present.
- A qualifier can be a single "*".
- A "**" means that zero or more qualifiers can be present.
- A "**" cannot appear with any other characters within a qualifier.
- Three or more adjacent "*" characters are not allowed within a qualifier.

This command affects activity for the specified data sets across all systems in the sysplex.

SHCDS

To add or delete a sharing control data set (SHCDS), specify the name of the SHCDS.

If you specify NEW, a new active SHCDS named (shcdsname) will be added.

If you specify NEWSPARE, a new spare SHCDS named (shcdsname) will be added.

If you specify DELETE, a SHCDS named (shcdsname) will be deleted. This SHCDS can be either an active or a spare SHCDS.

Note: The sharing control data set (SHCDS) is identified by the dsname SYS1.DFPSHCDS.qualifier.Vvolser. When specifying its name (shcdsname) in this command, do not use the fully-qualified name. Use only qualifier.Vvolser as the shcdsname, without the SYS1.DFPSHCDS prefix.

SMSVSAM

To manage SMSVSAM data sets or the SMSVSAM server, specify one of the following parameters:

ACTIVE

Restarts the SMSVSAM server and re-enables the automatic restart facility for the server. This command will not function if the SMSVSAM address space was terminated with a FALLBACK command.

SPHERE

Clears the VSAM-quiesced state for the specified sphere. Normally, this operation is done under application program control. This command is required only in rare circumstances.

FALLBACK

Is used as the last step in the disablement procedure to fall back from SMSVSAM processing. For the SMSVSAM fallback procedure, see *z/OS DFSMSdfp Storage Administration*.

FORCEDELETELOCKSTRUCTURE(lockstructurename)

Deletes the lock structure from the coupling facility and deletes any data in the lock structure at the time the command is issued.

VARY command

You must reply to the confirmation message with the response `FORCEDELETELOCKSTRUCTURESMSVSAMYES` before the command takes effect.

`V SMS,SMSVSAM,FORCEDELETESTRUCTURE(lockstructurename)` deletes only the specified DFSMS CF lock structure. When the secondary lock structures have been quiesced, they can be deleted by using the `V SMS,FORCEDELETELOCKSTRUCTURE(lockstructurename)` command.

Use this command only in the event of a volume loss.

Example 1:

The following command tells SMS not to allow allocation of new data sets from storage group `SG1` on system `MVS2`:

```
VARY SMS,STORGRP(SG1,MVS2),DISABLE,N
```

Tip: This command works only if the specified system is defined explicitly to SMS. If the system is defined to SMS as part of a system group, the command fails.

Example 2:

The following command tells SMS to allow allocation of both new and old data sets from storage group `SG1` on all MVS systems:

```
VARY SMS,STORGRP(SG1,ALL),ENABLE
```

Tip: This command works only if the specified system is defined explicitly to SMS. If the system is defined to SMS as part of a system group, the command fails.

Example 3:

The following command tells SMS to allow allocation of both new and old data sets from volume `SMS001` on system `MVS3`, enter:

```
VARY SMS,VOLUME(SMS001,MVS3),ENABLE
```

Example 4:

The following command tells a JES3 system to prevent scheduling a job that requires volume `SMS001` on `MVS3` and after a job is scheduled, tells SMS to select volume `SMS001` on `MVS3` for a new data set only if there are no other choices:

```
VARY SMS,VOLUME(SMS001,MVS3),QUIESCE
```

Tip: This command works only if the specified system is defined explicitly to SMS. If the system is defined to SMS as part of a system group, the command fails.

Placing an optical drive or library online or offline

Use the `VARY SMS` command to vary optical drives and optical libraries online or offline.

For a detailed description of the `VARY SMS,DRIVE` command parameters, refer to the *z/OS DFSMS OAM Planning, Installation, and Storage Administration Guide for Object Support*.

Placing a system-managed tape library online or offline

Use the VARY SMS,LIBRARY command to place a system-managed tape library online or offline.

For a detailed description of the VARY SMS,LIBRARY command parameters, refer to the *z/OS DFSMS OAM Planning, Installation, and Storage Administration Guide for Object Support*, and the *z/OS DFSMS OAM Planning, Installation, and Storage Administration Guide for Tape Libraries*.

Analyzing the state of the PDSE subsystem

Use the VARY SMS,PDSE,ANALYSIS command to determine the state of the PDSE (partitioned data set extended) subsystem. You can run the analysis on all the PDSEs that are open, or you can specify a specific PDSE by dsname and optionally the volser.

Consult *z/OS DFSMSdfp Diagnosis* for specific information about how to use this command, including the command syntax.

Releasing PDSE latches

Use the VARY SMS,PDSE,FREELATCH command to release a latch that the V SMS,PDSE,ANALYSIS command has determined is frozen.

Consult *z/OS DFSMSdfp Diagnosis* for specific information about how to use this command, including the command syntax.

Modifying processing of PDSE monitor

Use the following form of the VARY command to specify how the processing for the PDSE monitor should be modified:

```
V SMS,{PDSE|PDSE1},MONITOR{,ON[,interval[,duration]] }
                                {,DISPLAY }
                                {,DUMPNEXT}
                                {,OFF }
                                {,RESTART }
```

PDSE|PDSE1,MONITOR

Displays the status of the PDSE or PDSE1 monitor.

PDSE

Specifies that the command should be sent to the SMSPDSE address space.

PDSE1

Specifies that the should be sent to the SMSPDSE1 address space.

ON[,interval[,duration]]

Turns monitor processing on or off.

interval

The number of seconds between successive scans of the monitor.

duration

The number of seconds an possible error condition must exist before it is treated as an error.

DISPLAY

Turns monitor processing on. Displays all possible errors found in the IGW031I message.

VARY command

DUMPNEXT

Turns monitor processing on. Takes a dump and issues message IGW031I message for the next possible PDSE message.

OFF

Turns monitor processing off.

RESTART

Resets the state at which the monitor, due to an unexpected error in its processing, is shut down.

Note: The default values for interval and duration are not necessarily the optimum values for your system. Observation and adjustment will probably be necessary to attain the right values. Over time, even your chosen values might need to be re-adjusted.

Display current state of the PDSE monitor

Use the VARY SMS,PDSE,MONITOR command to display the current status of the PDSE monitor. See message IGW043I for details on the information displayed.

Changing the SMS status of a storage group or volume

Use the VARY SMS command to change the status of a storage group or volume that the storage management subsystem (SMS) controls. The command allows data sets in the storage group or volume to be allocated/accessed, or not allocated/accessed, to jobs. If the system you issue the command from is defined as part of a system group, but you did not specify the system or system group parameter, then the default is the current system and the command fails.

The possible states of a volume or storage group are:

ENABLE

Allows the system or system group to allocate and access data sets.

DISABLE

Prevents the system or system group from allocating or accessing existing data sets.

DISABLE,NEW

Prevents the system or system group from allocating new data sets; existing data sets can be accessed.

Note: For DISABLE and DISABLE,NEW, jobs needing the denied data sets can potentially fail during execution.

QUIESCE

Prevents JES3 from scheduling a job that creates new data sets or accesses existing data sets.

Once a job has been scheduled on either JES2 or JES3, SMS only selects the volume or storage group for a new data set if there are no other choices. There is no effect on the allocating or accessing of existing data sets.

Note: The QUIESCE state is not valid for object or object backup storage groups.

QUIESCE,NEW

Prevents JES3 from scheduling jobs that create new data sets or modify (DISP=MOD) existing data sets.

Once the job has been scheduled on either JES2 or JES3, SMS only selects the volume or storage group for a new data set if there are no other choices. There is no effect on the allocating or accessing of existing data sets.

Note: The QUIESCE state is not valid for object or object backup storage groups.

The syntax of the VARY SMS command is:

```
V SMS,{{STORGRP|SG}(storgrp,[*|ALL|system[,system]...)}},{QUIESCE|Q}{[,NEW|,N]
      {
      {VOLUME|VOL}(volume,[*|ALL|system[,system]...)} {ENABLE|E }
      {DISABLE|D}{[,NEW|,N]
```

STORGRP or SG(storgrp[,system,...])

Identifies the storage group and, optionally, the system or system group that the SMS status change is to affect. If you omit *system* or specify an *, the command affects only the system on which you issue the command. If the system you issue the command from is defined to SMS as part of a system group, then the command fails.

If you specify ALL, the command affects all systems and system groups in the complex. With ALL, the command is effective directly on the issuing system, and the sharing systems in the SMSPLEX see the updates in the COMMDS at the regular interval processing. Rapid use of several commands might overlap in updates of the COMMDS, increasing delay in the propagation through the sharing systems active configuration due to serialization timing.

To specify a storage group named "ALL", you must enclose the name in parentheses ((ALL)) to distinguish it from *all* storage groups.

VOLUME or VOL(volume[,system,...])

Identifies the volume and, optionally, the system or system group that the SMS status change is to affect. If you omit *system* or specify an *, the command affects only the system on which you issue the command. If the system you issue the command from is defined to SMS as part of a system group, then the command fails.

If you specify ALL, the command affects all systems and system groups in the complex. With ALL, the command is effective directly on the issuing system, and the sharing systems in the SMSPLEX see the update in the COMMDS at the regular interval processing. Rapid use of several commands might overlap in updates of the COMMDS, increasing delay in the propagation through the sharing systems active configuration due to serialization timing.

To specify a volume named "ALL", you must enclose the name in parentheses ((ALL)) to distinguish it from *all* volumes.

ENABLE or E

SMS is to permit allocation of new and old data sets from the specified storage group or volume on the designated system(s) or system group(s).

QUIESCE or Q[,NEW or ,N]

For QUIESCE, a JES3 system prevents the scheduling of jobs that create new data sets or accessing existing data sets from the specified storage group or volume. For QUIESCE,NEW a JES3 system prevents the scheduling of jobs that create new data sets or modify (DISP=MOD) existing data sets from the specified storage group or volume.

VARY command

Once the job has been scheduled on JES2 or JES3, SMS only selects the volume or storage group for a new data set if there are no other choices. There is no effect on the allocating or accessing of existing data sets.

DISABLE or **D[,NEW or ,N]**

For **DISABLE**, SMS is *not* to allow allocation or accessing of existing data sets in the specified storage group or volume.

For **DISABLE,NEW**, SMS is not to select the volume or storage group for a new data set.

Note: For **DISABLE** and **DISABLE,NEW**, jobs needing the denied data sets can potentially fail during execution. You should specify these parameters *only* under the direction of your storage administrator.

Example 1:

To tell SMS not to allow allocation of new data sets from storage group SG1 on system MVS2, enter:

```
VARY SMS,STORGRP(SG1,MVS2),DISABLE,N
```

Note: This command works only if the specified system is defined explicitly to SMS. If the system is defined to SMS as part of a system group, the command fails.

Example 2:

To tell SMS to allow allocation of both new and old data sets from storage group SG1 on all MVS systems, enter:

```
VARY SMS,STORGRP(SG1,ALL),ENABLE
```

Note: This command works only if the specified system is defined explicitly to SMS. If the system is defined to SMS as part of a system group, the command fails.

Example 3:

To tell SMS to allow allocation of both new and old data sets from volume SMS001 on system MVS3, enter:

```
VARY SMS,VOLUME(SMS001,MVS3),ENABLE
```

Example 4:

To (1) tell a JES3 system to prevent scheduling a job required volume SMS001 on MVS3, and (2) tell SMS, once a job is scheduled, to only select volume SMS001 on MVS3 for a new data set if there are no other choices, enter:

```
VARY SMS,VOLUME(SMS001,MVS3),QUIESCE
```

Note: This command works only if the specified system is defined explicitly to SMS. If the system is defined to SMS as part of a system group, the command fails.

Updating space statistics for volumes in the SMS configuration

SMS maintains space statistics for each SMS-managed DASD volume in the IGDVLD control block in the active configuration data set (ACDS). SMS also provides a **VARY SMS,...,SPACE** command to update the space values for volumes in a pool storage group or a specific SMS-managed DASD volume. With this **VARY**

command, you no longer need to allocate a small data set or use other approaches to ensure that the IGDVLD volume entry contains accurate space statistics.

The syntax of the VARY SMS,...,SPACE command is:

```
V SMS,{{STORGRP|SG}(storgrp)},{SPACE|S}
      {{VOLUME|VOL}(volser) }
```

STORGRP(storgrp) or SG(storgrp)

Identifies the name of a pool storage group.

VOLUME(volser) or VOL(volser)

Identifies the volume serial number of a SMS-managed DASD volume.

SPACE or S

Requests SMS to update the active configuration with the most current space statistics for the online volumes in the specified pool storage group or the specified SMS-managed online DASD volume.

A new variant of IGD010I will be issued as shown in the following examples if the command is valid and successfully processed:

Example 1:

```
V SMS,SG(S1P03),SPACE
IGD010I STORAGE GROUP (S1P03) VARY SPACE COMMAND PROCESSED
```

Example 2:

```
V SMS,VOL(1P0301),S
IGD010I VOLUME (1P0301) VARY SPACE COMMAND PROCESSED
```

A new variant of IGD005I will be issued as shown in the following examples if the command is rejected because the specified storage group is not a pool storage group or the specified volume is not in a pool storage group.

Example 1:

```
V SMS,SG(ATLSG1),S
IGD005I COMMAND REJECTED
STORAGE GROUP ATLSG1 IS NOT A POOL STORAGE GROUP
```

Example 2:

```
V SMS,VOL(TAPE01),SPACE
IGD005I COMMAND REJECTED
VOLUME TAPE01 IS NOT IN A POOL STORAGE GROUP
```

Controlling DFSMStvs processing

Use the VARY SMS command to control DFSMS Transactional VSAM Services (DFSMStvs) processing. For information about DFSMStvs, see *z/OS DFSMStvs Planning and Operating Guide* and *z/OS DFSMStvs Administration Guide*.

You can use the VARY SMS command to change the status for DFSMStvs in these ways:

- Change the state of a DFSMStvs instance or of all DFSMStvs instances in the sysplex
- Change the state of a log stream to which DFSMStvs has access
- Change the state of a data set for VSAM record-level sharing (RLS) and DFSMStvs access

VARY command

- Start or stop peer recovery processing for a DFSMStvs instance

Restriction:You cannot use the VARY SMS command to change the state of a DFSMStvs instance while it is initializing. Any attempt to do so is suspended until the initialization completes.

The possible states of a DFSMStvs instance follow:

ENABLE

Enables DFSMStvs to begin accepting new units of recovery for processing.

DISABLE

Prevents DFSMStvs from processing new work requests. DFSMStvs does not process new work requests from units of recovery that are currently in progress.

QUIESCE

Prevents DFSMStvs from accepting any new units of recovery for processing. DFSMStvs completes the processing of any units of recovery in progress.

The possible states of a data set follow:

ENABLE

Unquiesces a data set for VSAM RLS and DFSMStvs access.

QUIESCE

Quiesces a data set for VSAM RLS and DFSMStvs access.

The syntax of the VARY SMS command for DFSMStvs follows.

```
V SMS,{TRANVSAM({tvname|ALL})},{QUIESCE|Q}}
      {
      {,{ENABLE|E }}
      {,{DISABLE|D}}
      }
      {LOG(logstreamid){,{QUIESCE|Q}}
      {,{ENABLE|E }}
      {,{DISABLE|D}}
      }
      {SMSVSAM,SPHERE(sphere){,{QUIESCE|Q}}
      {,{ENABLE|E }}
      }
      {TRANVSAM(tvname),PEERRECOVERY{,{ACTIVE|A }}
      {,{ACTIVEFORCE }}
      {,{INACTIVE|I}}
```

TRANVSAM({ *tvname* or ALL})

Enables, quiesces, or disables the specified DFSMStvs instance or all DFSMStvs instances in the sysplex. The command is routed to all systems in the sysplex and affects either all DFSMStvs instances or the DFSMStvs instance with the specified name.

QUIESCE or Q

DFSMStvs completes processing of any units of recovery that are in

progress but does not accept any new ones. DFSMStvs completes its quiesce processing when the last data set that is open for DFSMStvs access is closed. Then DFSMStvs is unavailable until a VARY SMS,TRANVSAM,ENABLE command is issued.

DISABLE or D

DFSMStvs immediately stops processing new work requests, including units of recovery that are currently in progress. When the last data set that is open for DFSMStvs access is closed, DFSMStvs retains locks, unregisters with RRS, and is unavailable until a VARY SMS,TRANVSAM,ENABLE command is issued. No further DFSMStvs requests can complete until DFSMStvs is enabled. However, commit and backout requests that were already in progress at the time the disable command was received could be successful.

ENABLE or E

DFSMStvs begins accepting new units of recovery for processing.

LOG(logstreamid)

Enables, quiesces, or disables DFSMStvs access to the specified log stream (*logstreamid*). Quiescing the DFSMStvs undo or shunt log stream is equivalent to quiescing DFSMStvs processing.

Disabling the DFSMStvs undo or shunt log stream is equivalent to disabling DFSMStvs. Although the two log streams are physically separate, they are treated as a single entity by DFSMStvs logging services.

Quiescing or disabling the log of logs has no effect on DFSMStvs processing because records are written to the log of logs only as an optimization for forward recovery products. However, disabling the log of logs can cause a mismatch of tie-up records written at data set OPEN with file-close records.

Quiescing a forward recovery log stream will cause a quiesce of processing for any data sets that use that log stream. Disabling a forward recovery log stream causes all processing that attempts to use that log stream to fail. DFSMStvs will be unable to commit or back out any units of recovery that were using the log stream because it will be unable to write the necessary records to the log stream.

QUIESCE or Q

DFSMStvs completes the processing of any in-progress units of recovery using the log stream but does not accept any new ones that would require the log stream, with the exception of the log of logs. If the log is a DFSMStvs system log (undo or shunt log), it becomes quiesced when all units of recovery that are using DFSMStvs complete and any open data sets are closed. If the log is a forward recovery log, it becomes quiesced when the last data set that is open for output in DFSMStvs mode is closed. If the log is a log of logs, it becomes quiesced when the last forward-recoverable data set that is open for output in DFSMStvs mode, for which a tie-up record was written to the log of logs, is closed. New work can start, but DFSMStvs does not write tie-up records or file-close records to the log of logs.

DISABLE or D

DFSMStvs immediately stops using the log stream. This can prevent completion of commit or backout for units of recovery. Those units of recovery are shunted, as long as shunting them does not require reading or writing the now disabled log.

VARY command

Recommendation: Do not use this command without first quiescing the log stream unless the log stream is damaged or errors occur that cannot be corrected.

If the log is a DFSMStvs system log (undo or shunt log), DFSMStvs does not allow any further work to be done. All OPENS and VSAM record management requests are failed. The log becomes disabled when all units of recovery that are using DFSMStvs complete. DFSMStvs then retains locks, unregisters with RRS and the lock manager, and is unavailable until the log is enabled. No further DFSMStvs requests can complete until the system log is made available, including commit and backout requests.

If the log is a forward recovery log, any new OPENS that require the use of the log are failed. The log will become disabled when the last data set that uses it, and is OPEN for output in DFSMStvs mode, is closed.

If the log is a log of logs, it will become disabled when the last forward recoverable data set that is open for output in DFSMStvs mode, for which a tie-up record is written to the log of logs, is closed. New work can start, but DFSMStvs does not write tie-up records or file-close records to the log of logs.

ENABLE or E

DFSMStvs begins accepting new units of recovery that use the log stream for processing. If DFSMStvs work was left incomplete when DFSMStvs processing was stopped, DFSMStvs completes that work as part of its restart processing.

SMSVSAM, SPHERE (*sphere*)

Quiesces or unquiesces the data set *sphere* for VSAM RLS and DFSMStvs access. Use this command to ensure that users do not access the data set while it is being recovered. A data set can be quiesced to allow it to be accessed in a mode other than VSAM RLS or DFSMStvs. Before attempting to quiesce a data set, ensure that all jobs that were accessing the data set using DFSMStvs are either finished or canceled.

When you specify data sets for a VARY SMS,SMSVSAM,SPHERE command, they are not necessarily quiesced in the order in which you specified them or in any other order. The same is true for asterisk notation (*); the data sets are not necessarily quiesced alphabetically or in any other order. So, when the last data set you specified is quiesced, you cannot assume that the other data sets you specified have been quiesced.

TRANSAM(*tvname*), PEERRECOVERY

Starts or stops peer recovery processing for a failed instance of DFSMStvs. This command applies only to the system on which it is issued. That system is responsible for performing all peer recovery processing for the failed DFSMStvs instance.

ACTIVE or A

This system should begin peer recovery processing on behalf of the specified failed instance of DFSMStvs. If the failed instance of DFSMStvs was not disabling or disabled due to an operator command, the system will perform the necessary initialization and then start tasks to perform any work that was left incomplete by a system failure. Because a large amount of work could be outstanding, the system will start tasks in groups of ten and then begin more work as those tasks complete. Controlling the amount of work in progress at any given time allows a quiesce of peer recovery processing by varying it INACTIVE, in the event that the failed system comes back up.

ACTIVEFORCE

The system begins peer recovery processing on behalf of the specified failed instance of DFSMStvs, regardless of the failed instance's status.

INACTIVE or I

This system should stop processing peer recovery work on behalf of the specified instance of DFSMStvs. This command does not take effect immediately. Instead, peer recovery processing that is already in progress is allowed to complete before peer recovery processing stops.

Example 1:

This example show how to vary a DFSMStvs instance and quiesce it. At the time this command was issued, no jobs were using DFSMStvs services, nor were there any active DFSMStvs opens. As a result, DFSMStvs was able to transition from quiescing to quiesced.

```
V SMS,TRANVSAM(001),Q
```

This will result in:

```
V SMS,TRANVSAM(001),Q
IGW471I DFSMS VSAM RLS REQUEST TO QUIESCE 834
TRANSACTIONAL VSAM INSTANCE IGWTV001 IS ACCEPTED
QUIESCE REASON: VARY SMS TRANSACTIONAL VSAM OPERATOR COMMAND
IGW471I DFSMS VSAM RLS COMMAND PROCESSOR 835
ON SYSTEM: SYSTEM1
IS WAITING FOR A RESPONSE
FROM TRANSACTIONAL VSAM: IGWTV001
COMMAND REQUESTED:

QUIESCE TRANSACTIONAL VSAM: IGWTV001
IGW473I DFSMS VSAM RLS COMMAND PROCESSOR 836
ON SYSTEM: SYSTEM1
IS WAITING FOR A RESPONSE FROM TRANSACTIONAL VSAM: IGWTV001
COMMAND REQUESTED: DISCONNECT FROM LOGSTREAM: IGWTVS1.LOG.OF.LOGS
IGW473I DFSMS VSAM RLS COMMAND PROCESSOR 837
ON SYSTEM: SYSTEM1
IS WAITING FOR A RESPONSE FROM TRANSACTIONAL VSAM: IGWTV001
COMMAND REQUESTED: QUIESCE LOGSTREAM: IGWTV001.IGWLOG.SYSLOG
IGW474I DFSMS VSAM RLS IS DISCONNECTING FROM 838
TRANSACTIONAL VSAM LOGSTREAM IGWTV001.IGWLOG.SYSLOG
SYSTEM NAME: SYSTEM1
TRANSACTIONAL VSAM INSTANCE NAME: IGWTV001
IGW474I DFSMS VSAM RLS IS DISCONNECTING FROM 839
TRANSACTIONAL VSAM LOGSTREAM IGWTV001.IGWSHUNT.SHUNTLOG
SYSTEM NAME: SYSTEM1
TRANSACTIONAL VSAM INSTANCE NAME: IGWTV001
IGW474I DFSMS VSAM RLS IS DISCONNECTING FROM 840
TRANSACTIONAL VSAM LOGSTREAM IGWTVS1.LOG.OF.LOGS
SYSTEM NAME: SYSTEM1
TRANSACTIONAL VSAM INSTANCE NAME: IGWTV001
IGW473I DFSMS VSAM RLS COMMAND PROCESSOR 841
ON SYSTEM: SYSTEM1
HAS BEEN POSTED BY TRANSACTIONAL VSAM: IGWTV001
COMMAND REQUESTED: QUIESCE LOGSTREAM: IGWTV001.IGWLOG.SYSLOG
IGW473I DFSMS VSAM RLS COMMAND PROCESSOR 842
ON SYSTEM: SYSTEM1
HAS BEEN POSTED BY TRANSACTIONAL VSAM: IGWTV001
COMMAND REQUESTED: QUIESCE LOGSTREAM: IGWTV001.IGWSHUNT.SHUNTLOG
IGW471I DFSMS VSAM RLS COMMAND PROCESSOR 843
ON SYSTEM: SYSTEM1
HAS BEEN POSTED BY TRANSACTIONAL VSAM: IGWTV001
COMMAND REQUESTED:
```

VARY command

```
QUIESCE TRANSACTIONAL VSAM: IGWTV001
IGW471I DFSMS VSAM RLS COMMAND PROCESSOR 844
ON SYSTEM: SYSTEM1
HAS CALLED THE DFSMS COMMAND COMPLETE PROCESSOR
COMMAND REQUESTED:
```

```
QUIESCE TRANSACTIONAL VSAM: IGWTV001
IGW473I DFSMS VSAM RLS COMMAND PROCESSOR 845
ON SYSTEM: SYSTEM1
IS WAITING FOR A RESPONSE FROM TRANSACTIONAL VSAM: IGWTV001
COMMAND REQUESTED: QUIESCE LOGSTREAM: IGWTV001.IGWSHUNT.SHUNTLOG
IGW471I DFSMS VSAM RLS REQUEST TO QUIESCE 846
TRANSACTIONAL VSAM INSTANCE IGWTV001 COMPLETED.
```

TRANSACTIONAL VSAM INSTANCE IGWTV001 IS NOW QUIESCED.

```
TRANSACTIONAL VSAM LOGSTREAM IGWTV001.IGWLOG.SYSLOG      IS NOW QUIESCED
HAS BEEN POSTED BY TRANSACTIONAL VSAM: IGWTV001
COMMAND REQUESTED:
```

```
QUIESCE TRANSACTIONAL VSAM: IGWTV001
IGW471I DFSMS VSAM RLS COMMAND PROCESSOR 844
ON SYSTEM: SYSTEM1
HAS CALLED THE DFSMS COMMAND COMPLETE PROCESSOR
COMMAND REQUESTED:
```

```
QUIESCE TRANSACTIONAL VSAM: IGWTV001
IGW473I DFSMS VSAM RLS COMMAND PROCESSOR 845
ON SYSTEM: SYSTEM1
IS WAITING FOR A RESPONSE FROM TRANSACTIONAL VSAM: IGWTV001
COMMAND REQUESTED: QUIESCE LOGSTREAM: IGWTV001.IGWSHUNT.SHUNTLOG
IGW471I DFSMS VSAM RLS REQUEST TO QUIESCE 846
TRANSACTIONAL VSAM INSTANCE IGWTV001 COMPLETED.
```

TRANSACTIONAL VSAM INSTANCE IGWTV001 IS NOW QUIESCED.

```
TRANSACTIONAL VSAM LOGSTREAM IGWTV001.IGWLOG.SYSLOG      IS NOW QUIESCED
```

Example 2:

This example shows how to vary a DFSMStvs instance disabled. At the time this command was issued, no jobs were using DFSMStvs services, nor were there any active DFSMStvs opens. As a result, DFSMStvs was able to transition from disabling to disabled.

This will result in:

```
V SMS,TRANVSAM(002),D
IGW471I DFSMS VSAM RLS REQUEST TO DISABLE 849
TRANSACTIONAL VSAM INSTANCE IGWTV002 IS ACCEPTED.
```

```
DISABLE REASON: VARY SMS TRANSACTIONAL VSAM OPERATOR COMMAND
IGW471I DFSMS VSAM RLS REQUEST TO DISABLE 850
TRANSACTIONAL VSAM INSTANCE IGWTV002 IS COMPLETED.
```

TRANSACTIONAL VSAM INSTANCE IGWTV002 IS NOW DISABLED.

```
TRANSACTIONAL VSAM LOGSTREAM IGWTV002.IGWLOG.SYSLOG      IS NOW DISABLED
TRANSACTIONAL VSAM LOGSTREAM IGWTV002.IGWSHUNT.SHUNTLOG IS NOW DISABLED
```

Example 3:

This example shows how to vary all DFSMStvs instances and enable them. At the time this command was issued, the two DFSMStvs instances in the sysplex were quiesced and disabled, respectively.

This will result in:

V SMS,TRANVSAM(ALL),E
 IGW472I DFSMS VSAM RLS REQUEST TO ENABLE 853
 TRANSACTIONAL VSAM INSTANCE IGWTV001 ACCEPTED.

ENABLE REASON: VARY SMS TRANSACTIONAL VSAM OPERATOR COMMAND
 IGW472I DFSMS VSAM RLS REQUEST TO ENABLE 854
 TRANSACTIONAL VSAM INSTANCE IGWTV002 ACCEPTED.

ENABLE REASON: VARY SMS TRANSACTIONAL VSAM OPERATOR COMMAND
 IGW471I DFSMS VSAM RLS COMMAND PROCESSOR 855
 ON SYSTEM: SYSTEM1
 IS WAITING FOR A RESPONSE
 FROM TRANSACTIONAL VSAM: IGWTV001
 COMMAND REQUESTED:

ENABLE TRANSACTIONAL VSAM: IGWTV001
 IGW473I DFSMS VSAM RLS COMMAND PROCESSOR 856
 ON SYSTEM: SYSTEM1
 IS WAITING FOR A RESPONSE FROM TRANSACTIONAL VSAM: IGWTV001
 COMMAND REQUESTED: ENABLE LOGSTREAM: IGWTV001.IGWLOG.SYSLOG
 IGW473I DFSMS VSAM RLS COMMAND PROCESSOR 857
 ON SYSTEM: SYSTEM1
 IS WAITING FOR A RESPONSE FROM TRANSACTIONAL VSAM: IGWTV001
 COMMAND REQUESTED: ENABLE LOGSTREAM: IGWTV001.IGWSHUNT.SHUNTLOG
 IGW860I TRANSACTIONAL VSAM HAS SUCCESSFULLY REGISTERED WITH RLS
 IGW848I 10312000 13.38.51 SYSTEM UNDO LOG IGWTV001.IGWLOG.SYSLOG 859
 INITIALIZATION HAS STARTED
 IXL014I IXLCONN REQUEST FOR STRUCTURE TVS_LOG001 860
 WAS SUCCESSFUL. JOBNAME: IXGLOGR ASID: 0015
 CONNECTOR NAME: IXGLOGR_SYSTEM1 CFNAME: FACIL02
 IXL015I STRUCTURE ALLOCATION INFORMATION FOR 861
 STRUCTURE TVS_LOG001, CONNECTOR NAME IXGLOGR_SYSTEM1

CFNAME	ALLOCATION STATUS/FAILURE REASON
FACIL02	STRUCTURE ALLOCATED
FACIL01	PREFERRED CF ALREADY SELECTED

 TRANSACTIONAL VSAM LOGSTREAM IGWTV001.IGWLOG.SYSLOG
 SYSTEM NAME: SYSTEM1
 TRANSACTIONAL VSAM INSTANCE NAME: IGWTV001
 IGW848I 10312000 13.39.21 SYSTEM UNDO LOG IGWTV001.IGWLOG.SYSLOG 869
 INITIALIZATION HAS ENDED
 IGW848I 10312000 13.39.21 SYSTEM SHUNT LOG IGWTV001.IGWSHUNT.SHUNTLOG
 INITIALIZATION HAS STARTED
 IGW474I DFSMS VSAM RLS IS CONNECTING TO 877
 TRANSACTIONAL VSAM LOGSTREAM IGWTV001.IGWSHUNT.SHUNTLOG
 SYSTEM NAME: SYSTEM1
 TRANSACTIONAL VSAM INSTANCE NAME: IGWTV001
 IGW848I 10312000 13.39.50 SYSTEM SHUNT LOG IGWTV001.IGWSHUNT.SHUNTLOG
 INITIALIZATION HAS ENDED
 IGW848I 10312000 13.39.50 LOG OF LOGS IGWTVS1.LOG.OF.LOGS 879
 INITIALIZATION HAS STARTED
 IGW474I DFSMS VSAM RLS IS CONNECTING TO 886
 TRANSACTIONAL VSAM LOGSTREAM IGWTVS1.LOG.OF.LOGS
 SYSTEM NAME: SYSTEM1
 TRANSACTIONAL VSAM INSTANCE NAME: IGWTV001
 IGW848I 10312000 13.40.18 LOG OF LOGS IGWTVS1.LOG.OF.LOGS 887
 INITIALIZATION HAS ENDED
 IGW865I TRANSACTIONAL VSAM INITIALIZATION IS COMPLETE.

IGW471I DFSMS VSAM RLS COMMAND PROCESSOR 897
 ON SYSTEM: SYSTEM1
 HAS BEEN POSTED BY TRANSACTIONAL VSAM: IGWTV001
 COMMAND REQUESTED:

ENABLE TRANSACTIONAL VSAM: IGWTV001
 IGW473I DFSMS VSAM RLS COMMAND PROCESSOR 898

VARY command

```
ON SYSTEM: SYSTEM1
HAS BEEN POSTED BY TRANSACTIONAL VSAM: IGWTV001
COMMAND REQUESTED: ENABLE LOGSTREAM: IGWTV001.IGWLOG.SYSLOG
IGW473I DFSMS VSAM RLS COMMAND PROCESSOR 899
ON SYSTEM: SYSTEM1
HAS BEEN POSTED BY TRANSACTIONAL VSAM: IGWTV001
COMMAND REQUESTED: ENABLE LOGSTREAM: IGWTV001.IGWSHUNT.SHUNTLOG
IGW473I DFSMS VSAM RLS COMMAND PROCESSOR 900
ON SYSTEM: SYSTEM1
HAS CALLED THE DFSMS COMMAND COMPLETE PROCESSOR
COMMAND REQUESTED: ENABLE LOGSTREAM: IGWTV001.IGWSHUNT.SHUNTLOG
IGW886I 0 RESTART TASKS WILL BE PROCESSED DURING TRANSACTIONAL VSAM
RESTART PROCESSING
IGW472I DFSMS VSAM RLS REQUEST TO ENABLE 902
TRANSACTIONAL VSAM INSTANCE IGWTV001 IS COMPLETED.

TRANSACTIONAL VSAM INSTANCE IGWTV001 IS NOW ENABLED.

TRANSACTIONAL VSAM LOGSTREAM IGWTV001.IGWLOG.SYSLOG IS NOW ENABLED.

TRANSACTIONAL VSAM LOGSTREAM IGWTV001.IGWSHUNT.SHUNTLOG IS NOW ENABLED.

TRANSACTIONAL VSAM IGWTV001 WILL NOW ACCEPT NEW WORK
IGW866I TRANSACTIONAL VSAM RESTART PROCESSING IS COMPLETE.

IGW467I DFSMS TVSNAME PARMLIB VALUE SET DURING 904
SMSVSAM ADDRESS SPACE INITIALIZATION ON SYSTEM: SYSTEM1
TVSNAME: IGWTV001
CURRENT VALUE: ENA-ED 1
IGW467I DFSMS TVS UNDO LOG PARMLIB VALUE SET DURING 905
SMSVSAM ADDRESS SPACE INITIALIZATION ON SYSTEM: SYSTEM1
UNDO LOGSTREAM NAME: IGWTV001.IGWLOG.SYSLOG
CURRENT VALUE: ENA-ED 1
IGW467I DFSMS TVS SHUNT LOG PARMLIB VALUE SET DURING 906
SMSVSAM ADDRESS SPACE INITIALIZATION ON SYSTEM: SYSTEM1
SHUNT LOGSTREAM NAME: IGWTV001.IGWSHUNT.SHUNTLOG
CURRENT VALUE: ENA-ED 1
IGW472I DFSMS VSAM RLS REQUEST TO ENABLE 907
TRANSACTIONAL VSAM INSTANCE IGWTV002 IS COMPLETED.

TRANSACTIONAL VSAM INSTANCE IGWTV002 IS NOW ENABLED.

TRANSACTIONAL VSAM LOGSTREAM IGWTV002.IGWLOG.SYSLOG IS NOW ENABLED.

TRANSACTIONAL VSAM LOGSTREAM IGWTV002.IGWSHUNT.SHUNTLOG IS NOW ENABLED.

TRANSACTIONAL VSAM IGWTV002 WILL NOW ACCEPT NEW WORK
```

Example 4:

This example shows how to vary a log stream quiesced. At the time this command was issued, no jobs were using the log stream, nor were there any active DFSMStvs opens. As a result, DFSMStvs was able to transition the log stream from quiescing to quiesced.

This results in the following output:

```
V SMS,LOG(IGWTVS.FR.LOG001),Q
IGW473I DFSMS VSAM RLS REQUEST TO QUIESCE 910
TRANSACTIONAL VSAM LOGSTREAM IGWTVS.FR.LOG001 IS ACCEPTED
QUIESCE REASON: VARY SMS TRANSACTIONAL VSAM OPERATOR COMMAND
IGW473I DFSMS VSAM RLS REQUEST TO QUIESCE 911
TRANSACTIONAL VSAM LOGSTREAM IGWTVS.FR.LOG001 COMPLETED.

TRANSACTIONAL VSAM LOGSTREAM IGWTVS.FR.LOG001 IS NOW QUIESCED
```

If any data sets were open in DFSMStvs mode, transitioning the log stream from quiescing to quiesced could take much longer. DFSMStvs would need to wait until the data sets were closed.

Example 5:

This example shows how to vary a log stream disabled. At the time this command was issued, no jobs were using the log stream, nor were there any active DFSMStvs opens. As a result, DFSMStvs was able to transition the log stream from disabling to disabled.

This will result in:

```
V SMS,LOG(IGWTVS1.LOG.OF.LOGS),D
IGW473I DFSMS VSAM RLS REQUEST TO DISABLE 917
TRANSACTIONAL VSAM LOGSTREAM IGWTVS1.LOG.OF.LOGS          IS ACCEPTED
IGW473I DFSMS VSAM RLS COMMAND PROCESSOR 918
ON SYSTEM: SYSTEM1
IS WAITING FOR A RESPONSE FROM TRANSACTIONAL VSAM: IGWTV001
COMMAND REQUESTED: DISABLE LOGSTREAM: IGWTVS1.LOG.OF.LOGS
IGW474I DFSMS VSAM RLS IS DISCONNECTING FROM 919
TRANSACTIONAL VSAM LOGSTREAM IGWTVS1.LOG.OF.LOGS
SYSTEM NAME:          SYSTEM1
TRANSACTIONAL VSAM INSTANCE NAME: IGWTV001
IGW473I DFSMS VSAM RLS COMMAND PROCESSOR 920
ON SYSTEM: SYSTEM1
HAS BEEN POSTED BY TRANSACTIONAL VSAM: IGWTV001
COMMAND REQUESTED: DISABLE LOGSTREAM: IGWTVS1.LOG.OF.LOGS
IGW473I DFSMS VSAM RLS COMMAND PROCESSOR 921
ON SYSTEM: SYSTEM1
HAS CALLED THE DFSMS COMMAND COMPLETE PROCESSOR
COMMAND REQUESTED: DISABLE LOGSTREAM: IGWTVS1.LOG.OF.LOGS
IGW473I DFSMS VSAM RLS REQUEST TO DISABLE 922
TRANSACTIONAL VSAM LOGSTREAM IGWTVS1.LOG.OF.LOGS          IS COMPLETED.

TRANSACTIONAL VSAM LOGSTREAM IGWTVS1.LOG.OF.LOGS          IS NOW DISABLED
```

Example 6:

This example shows how to vary a log stream enabled.

```
V SMS,LOG(IGWTVS1.LOG.OF.LOGS),E
IGW474I DFSMS VSAM RLS REQUEST TO ENABLE 929
TRANSACTIONAL VSAM LOGSTREAM IGWTVS1.LOG.OF.LOGS          IS ACCEPTED
IGW473I DFSMS VSAM RLS COMMAND PROCESSOR 930
ON SYSTEM: SYSTEM1
IS WAITING FOR A RESPONSE FROM TRANSACTIONAL VSAM: IGWTV001
COMMAND REQUESTED: ENABLE LOGSTREAM: IGWTVS1.LOG.OF.LOGS
IGW848I 10312000 13.44.20 LOG OF LOGS IGWTVS1.LOG.OF.LOGS 931
INITIALIZATION HAS STARTED
IGW474I DFSMS VSAM RLS IS CONNECTING TO 938
TRANSACTIONAL VSAM LOGSTREAM IGWTVS1.LOG.OF.LOGS
SYSTEM NAME:          SYSTEM1
TRANSACTIONAL VSAM INSTANCE NAME: IGWTV001
IGW848I 10312000 13.44.48 LOG OF LOGS IGWTVS1.LOG.OF.LOGS 939
INITIALIZATION HAS ENDED
IGW473I DFSMS VSAM RLS COMMAND PROCESSOR 940
ON SYSTEM: SYSTEM1
HAS BEEN POSTED BY TRANSACTIONAL VSAM: IGWTV001
COMMAND REQUESTED: ENABLE LOGSTREAM: IGWTVS1.LOG.OF.LOGS
IGW473I DFSMS VSAM RLS COMMAND PROCESSOR 941
ON SYSTEM: SYSTEM1
HAS CALLED THE DFSMS COMMAND COMPLETE PROCESSOR
COMMAND REQUESTED: ENABLE LOGSTREAM: IGWTVS1.LOG.OF.LOGS
IGW474I DFSMS VSAM RLS REQUEST TO ENABLE 942
```

VARY command

```
TRANSACTIONAL VSAM LOGSTREAM IGWTVS1.LOG.OF.LOGS      IS COMPLETED.  
TRANSACTIONAL VSAM LOGSTREAM IGWTVS1.LOG.OF.LOGS      IS NOW ENABLED
```

Example 7:

This example shows how to vary a VSAM sphere quiesced. At the time this command was issued, no jobs were using the data set, nor were there any active opens for the data set. As a result, DFSMStvs was able to transition the data set from quiescing to quiesced.

```
V SMS,SMSVSAM,SPHERE(SYSPLEX.SHCD.S.UND01.KSDS01),Q  
IGW522I SMSVSAM QUIESCE REQUEST FOR SPHERE 945  
SYSPLEX.SHCD.S.UND01.KSDS01 IS COMPLETED.
```

If any jobs were using the data set while it is open in DFSMStvs mode, transitioning the data set from quiescing to quiesced could take much longer. DFSMStvs would need to wait until the jobs were complete.

Example 8:

This example shows how to vary a VSAM sphere enabled.

```
V SMS,SMSVSAM,SPHERE(SYSPLEX.SHCD.S.UND01.KSDS01),E  
IGW522I SMSVSAM ENABLE REQUEST FOR SPHERE 948  
SYSPLEX.SHCD.S.UND01.KSDS01 IS COMPLETED.
```

Controlling CICSVR processing

Use the VARY SMS command to control CICS VSAM Recovery services (CICSVR) processing.

You can use the VARY SMS command to:

- Control the CICSVR address space startup and shutdown.
- Add or delete a Recovery Control Data Set (RCDS) in the CICSVR address space.

The syntax of the VARY SMS command to control CICSVR startup and shutdown follows.

```
V SMS,CICSVR{,ACTIVE          |  
              ,TERMINATESERVER}
```

ACTIVE

The command creates or activates the CICSVR address space and allows work to be started. This command only executes on the system where the command was entered or on the target system as a result of the MVS ROUTE command.

The syntax of the VARY SMS command to add or delete the RCDS follows.

```
V SMS,CICSVR,RCDS(rcds_name),{ADD|DELETE}
```

rcds_name

The name of the RCDS, which follows the DDNAME syntax rules.

ADD

The command adds the RCDS specified to the CICSVR address space.

DELETE

The command deletes the RCDS specified from the CICSVR address space.

Placing a switch port online or offline

Use the VARY SWITCH(*ssss,pp[-pp][,pp[-pp]]...*),{DCM=OFFLINE[,UNCOND]|ONLINE} command to place a switch port online or offline to dynamic channel path management. Invoking this command for a switch port will also cause the specific managed device paths to be varied online or offline. An offline request will cause the managed channel paths to be removed from the control units connected to the managed CHPIDs at the specified ports. The VARY SWITCH command is routed to all systems in the logical partition cluster to ensure that all systems run with the same configuration of managed channel paths.

This command affects only managed device paths. Nonmanaged paths must be varied online or offline separately.

Note: If you specify DCM=OFFLINE or =ONLINE for a logical partition cluster spanning multiple logical channel subsystems, you must issue the command from a system at the z990 V1R4 exploitation support level or higher. For example, if systems A and B have z990 V1R4 compatibility support and are running in CSS 0, while systems C and D have exploitation support and are running in CSS 1, you must issue the DCM= command from system C or system D.

The format of the VARY SWITCH command is:

```
V SWITCH(ssss,pp[-pp][,pp[-pp]]...),DCM=OFFLINE[,UNCOND]
                                     ,DCM=ONLINE
```

ssss

specifies the switch device number.

pp[-pp] [,pp[-pp]]

specifies the switch port address or address list.

DCM=OFFLINE[,UNCOND]

specifies that the switch port is to be varied offline to dynamic channel path management. If UNCOND is specified, then the UNCOND option will be passed to the VARY PATH commands that are invoked as a result of this VARY SWITCH command. See "Placing an I/O Path or Paths Online or Offline" on page 948.

DCM=ONLINE

specifies that the switch port is to be varied online to dynamic channel path management.

Example 1:

To vary port 60 of switch B000 offline on the two systems in a logical partition cluster, enter on system MVS1:

```
VARY SWITCH(b000,60),DCM=OFFLINE
```

The response from this command will show how it ran on both systems, MVS1 and MVS2:

```
MVS1 IEE633I SWITCH B000, PORT 60, DCM STATUS=OFFLINE
      ATTACHED NODE = 003990.0CC.IBM.XG.000000000006
      THE FOLLOWING DEVICE PATHS ARE ONLINE THROUGH THIS PORT:
```

VARY command

(0220,58)

```
MVS2 IEE633I SWITCH B000, PORT 60, DCM STATUS=OFFLINE
ATTACHED NODE = 003990.0CC.IBM.XG.0000000000006
THE FOLLOWING DEVICE PATHS ARE ONLINE THROUGH THIS PORT:
(0220,58)
```

These messages show that the command ran on both system MVS1 and MVS2. The fact that these messages are identical shows that these systems are configured identically — the preferred configuration when using dynamic channel path management.

Controlling an application environment

Use the VARY WLM,APPLENV=*applenvname*, or VARY WLM,DYNAPPL=*applenvname* command to control an application environment. You can perform the following:

- Request that the server address spaces for an application environment be terminated and start new ones in their place (REFRESH). This is useful if you have updated resources such as load modules which might have been cached by the servers.
- Request that the server address spaces for an application environment be terminated and that any additional work requests be queued but not selected (QUIESCE or Q).
- Restart the server address spaces for an application environment that was previously quiesced, or was stopped by workload management when it detected an error condition (RESUME).

You can use the DISPLAY WLM command to check the status of the VARY WLM command for the application environments that are affected. See the “Defining Application Environments” chapter in *z/OS MVS Planning: Workload Management* for more information on operational considerations for application environments and the role of the VARY WLM,APPLENV=*applenvname*, or VARY WLM,DYNAPPL=*applenvname* command.

Command Scope

The VARY WLM,APPLENV=*applenvname* command has a sysplex scope and so affects all servers of an application environment on all the systems in the sysplex. For subsystems that can have multiple instances, all the subsystem instances are affected.

If you need to stop application environment activity on just one system in a sysplex, use the subsystem-specific interface to stop the activity on that system.

The VARY WLM,APPLENV command is processed on the coordinator system, which is determined dynamically and may not be the local system where the command was issued. The command output is routed to the console from which the command has been issued, but the command hardcopy is logged on the system on which the command has been processed. Therefore, the message may not appear in the SYSLOG on the system where the command was entered.

The VARY WLM,DYNAPPL=*applenvname* has a single system scope and affects only servers of an application environment on the system where the command is issued or to where it is routed.

You can enter the VARY WLM,APPLENV=*applenvname* command on any system in the sysplex. In this case, the installation is responsible for starting and terminating

servers. For example, if VARY WLM,APPLENV=*applenvname*,QUIESCE is issued, the application environment enters the quiescing state on all systems in the sysplex.

Note that workload management starts servers only if a JCL procedure has been defined in the service definition for the application environment. This is known as “automatic” control for the application environment. If a JCL procedure is not defined, the application environment is under “manual” control, and the installation is responsible for starting the servers.

Table 72 summarizes how the QUIESCE, RESUME, and REFRESH options of the VARY WLM,APPLENV command are acted on by systems:

- Under “Automatic” control, that is, goal mode when a JCL procedure is defined for the application environment
- Under “Manual” control, that is, goal mode when a JCL procedure is *not* defined for the application environment

Table 72. Actions for VARY WLM,APPLENV

Operation	Automatic Control: JCL Procedure Defined to WLM	Manual Control: No JCL Procedure Defined to WLM
QUIESCE	WLM stops the server address spaces.	WLM stops the server address spaces.
RESUME	WLM starts the server address spaces.	Operator must start the server address spaces.
REFRESH	WLM stops the server address spaces, and starts new ones.	WLM stops the server address spaces. The operator must start new ones.

Command Syntax

The syntax of the VARY WLM,APPLENV command is:

```
V WLM,APPLENV=applenvname, {REFRESH}
                             {QUIESCE|Q}
                             {RESUME}
                             ,DYNAPPL=applenvname, {SNODE=nodename},
                                                     {SNAME=subsystemname},
                                                     {STYPE=subsystemtype},
```

WLM,APPLENV=*applenvname*

Specifies the 1 to 32 character name of the application environment for the command.

The VARY WLM command is rejected if the named application environment does not exist in the workload management service definition. To list all the application environment names, use the DISPLAY WLM,APPLENV=* command.

WLM,DYNAPPL=*applenvname*

Specifies the name (length=1–32 characters) of the dynamic application environment for the command. The VARY WLM,DYNAPPL command is rejected if the named dynamic application environment was not defined to the system. To list all the dynamic application environment names, use the DISPLAY WLM,DYNAPPL=* command. The following keywords are valid:

VARY command

SNODE=*nodename*

When **SNODE=*nodename*** is used, the VARY WLM,DYNAPPL command specifically applies to the dynamic application environments with the specified node name.

SNAME=*subsystemname*

When **SNAME=*subsystemname*** is used, the VARY WLM,DYNAPPL command specifically applies to the dynamic application environments with the specified subsystem name.

STYPE=*subsystemtype*

When **STYPE=*subsystemtype*** is used, the VARY WLM,DYNAPPL command specifically applies to the dynamic application environments with the specified subsystem type.

REFRESH

Specifies that the application environment server address spaces be terminated after completion of the currently executing request and new ones started in their place.

QUIESCE | Q

Specifies that the application environment server address spaces be terminated after completion of the currently executing request. No new server address spaces can be started for the application environment by either WLM or an operator. Additional work requests for an application environment that supports queueing, are queued but not selected.

When an application environment is quiesced, changes can be made to libraries, procedures, and other items for the application environment.

To restart the application environment, use the VARY WLM,APPLENV=*applenvname*,RESUME command; any other VARY WLM,APPLENV action is rejected by the system.

To restart a dynamic application environment, use the VARY WLM,DYNAPPL=*applenvname*,RESUME command; any other VARY WLM,DYNAPPL action is rejected by the system.

RESUME

Specifies that the application environment be restarted. After this command is executed, server address spaces are allowed to start. Work requests that are queued are eligible for selection.

Example 1:

To quiesce application environment db2pay, enter:

```
V WLM,APPLENV=db2pay,Q
```

The system responds with:

```
IWM032I VARY QUIESCE FOR DB2PAY COMPLETED
```

Example 2:

To quiesce dynamic application environment websphere in node *testnode*, enter:

```
V WLM,APPLENV=websphere,snode=testnode,Q
```

The system responds with:

```
IWM032I VARY QUIESCE FOR WEBSPPHERE COMMAND COMPLETED
```

Activating a service policy

Use the VARY WLM command to activate a named service policy for a sysplex. The service policy must be defined in the workload management service definition and must have been previously installed on the WLM couple data set. In addition, each system in the sysplex must have connectivity to the WLM couple data set in order to participate in the service policy activation.

To activate a new policy, issue a VARY WLM command with the name of the policy you want to make active. This in effect makes the previous policy inactive.

You can also activate a workload management service policy by using the online ISPF administrative application. Refer to *z/OS MVS Planning: Workload Management* for more information or see your service administrator.

You can enter the VARY command on any system in the sysplex. This command activates the named service policy on all systems in the sysplex.

You can use the DISPLAY WLM command to check the service policy currently active for the sysplex. For example, before you activate a service policy, check which, if any, policy is active using the DISPLAY WLM command. After activating a service policy using the VARY command, you can confirm that the VARY command has taken effect by using the DISPLAY WLM command.

If you routinely activate service policies based on time-of-day or day-of-week, you can update automation packages with the commands.

Only one service policy can be in effect throughout all systems in a sysplex at any one time.

```
V WLM,POLICY=policyname[,REFRESH]
```

WLM,POLICY=*policyname*

Specifies the 1 to 8 character name of the service policy to be activated.

REFRESH

Specifies that WLM is to discard historical workload characterization data, reset to begin data collection anew, and activate the named policy.

Note: Use REFRESH only when directed to do so by IBM Level 2 personnel.

The VARY WLM command is rejected if the named service policy does not exist. Contact your service administrator to determine the name of the desired service policy.

Example 1:

To activate a service policy named SHIFT1, enter:

```
V WLM,POLICY=shift1
```

The system responds with:

```
IWM001I WORKLOAD MANAGEMENT POLICY SHIFT1 NOW IN EFFECT
```

Example 2:

VARY command

If you activate a service policy that does not exist, the command is rejected. If service policy WEEKEND does not exist and you enter:

```
V WLM,POLICY=weekend
```

The system responds with:

```
IWM003I VARY WLM FAILED, POLICY NAME WEEKEND NOT DEFINED
```

Removing a System from the XCF Sysplex

Use the following form of the VARY command to remove a system from the XCF sysplex.

```
V XCF,systemname,{OFFLINE|OFF}[,RETAIN={YES|NO}][,FORCE][,REIPL][,SADMP]
```

XCF,systemname,OFFLINE or OFF

Specifies the name of a system that XCF is to remove from the sysplex. The system that is removed is put into a wait state. The system to be brought offline should be shut down completely, including the issuance and completion of the HALT EOD command, before the VARY XCF,sysname,OFFLINE command is issued.

RETAIN=YES or NO

Indicates whether or not XCF, on the remaining systems in the sysplex, is to retain the signalling path resources used to communicate with the system that's removed. If you specify YES, the XCF signalling paths used to communicate with the removed system remain allocated. They are reinitialized so that they are ready to reestablish communications with a new system if the removed system joins the sysplex or another system takes its place. If you specify NO, XCF stops the signalling path to stop the XCF paths that had communicated with the removed system.

If a replacement for the removed system later joins the sysplex, after RETAIN=NO, you must issue the SETXCF START path command on the remaining systems. This procedure guarantees that each signalling path can communicate with the replacement system.

FORCE

Indicates that XCF will immediately remove the specified system from the sysplex. The FORCE option is only accepted after XCF has failed to remove the system with the VARY command. The VARY command with the FORCE option must be issued on the same MVS image where the original VARY command was issued.

Note:

1. Use FORCE only at the direction of the system programmer.
2. Before using FORCE: to avoid damage to sysplex resources ensure that the target system has been through a SYSTEM RESET.

REIPL

Indicates that when the target system image has been successfully partitioned out of the sysplex, it is to be re-IPLed using the MVS IPL parameters specified in the DIAGxx parmlib member that is in effect on the target system.

Note: the REIPL option cannot be specified on the same VARY XCF command that specifies the FORCE or RETAIN=NO options.

SADMP

Indicates that when the target system image has been successfully partitioned out of the sysplex, SADMP is to be IPLed using the SADMP IPL parameters specified in the DIAGxx parmlib member that is in effect on the target system.

Note: The SADMP option cannot be specified on the same VARY XCF command that specifies the FORCE option.

Note:

By default, when neither the REIPL nor the SADMP parameter is specified, the target system image that is partitioned out of the sysplex is not subject to any AutoIPL-related processing.

When both REIPL and SADMP are specified in combination, this indicates that a combination of both actions should take place; first, SADMP should be IPLed, followed by a re-IPL of the z/OS system, both using the respective options defined in the DIAGxx parmlib member for those specific actions.

Example 1:

To vary the system named FRED out of the sysplex, enter:

```
VARY XCF,FRED,OFFLINE
```

At the conclusion of this processing, FRED is not subject to any AutoIPL-related processing.

Example 2:

To vary the system named RALPH out of the sysplex, enter:

```
VARY XCF,RALPH,OFFLINE,REIPL
```

At the conclusion of this processing, RALPH is re-IPLed using the MVS IPL parameters specified in the DIAGxx member that is in effect on that system.

Example 3:

To vary the system named BOB out of the sysplex, enter:

```
VARY XCF,BOB,OFFLINE,SADMP
```

At the conclusion of this processing, SADMP is IPLed using the SADMP IPL parameters specified in the DIAGxx member that is in effect on that system.

Example 4:

To vary the system named RINGO out of the sysplex, enter:

```
VARY XCF,RINGO,OFFLINE,SADMP,REIPL
```

At the conclusion of this processing, SADMP is IPLed using the SADMP IPL parameters specified in the DIAGxx member that is in effect on that system. After the SADMP completes, RINGO is re-IPLed using the MVS IPL parameters specified in the DIAGxx member that is in effect on that system.

WRITELOG command

Use the WRITELOG command to control the system log. Using WRITELOG, you can start, stop, or print the system log, or modify the output class of the system log.

Syntax

The complete syntax for the WRITELOG command is:

```
W [class|CLOSE|START]
```

Note: Specifying WRITELOG without any operands schedules the system log to be printed with the default output class specified at system installation. If no default output class was specified at system installation, specifying WRITELOG without any operands schedules the system log to be printed with output class A.

Parameters

class

The one-character output class (A-Z, 0-9) to be used when printing the contents of the system log. This command is in effect only for the current scheduling of the system log output. All subsequent scheduling is to the default output class unless the class parameter is again entered.

CLOSE

The system log is closed and the log function is discontinued. This command is rejected if the system log is the hardcopy medium.

START

The system log is to be restarted.

Example:

To schedule the system log to the class D output queue, enter:

```
WRITELOG d
```

Appendix A. HIS MAP format

The following tables describe the format of the HIS MAP file. First a general format description is provided, which describes format information that is consistent across the various record types. Then the formats of the various record types which are included in the MAP file are provided. The map file consists of the following record types:

- Information records which provide basic information about the system and the MAP file.
- Boundary records which provide information about various virtual storage boundary areas (Private, LPA, CSA, SQA, etc.).
- Address space records which describe the various address spaces on the system.
- Module records which describe the various modules loaded on the system.
- CSECT records which describe Control Sections found within a module.
- Entry Point records which describe the Entry Points within a Nucleus CSECT.

HIS MAP format general description

Table 73. General map record header format

General map record header format				
Field Name	Offset	Length	Format	Description
MapRecordType	0	1	Text	I=Information, A=AddressSpace, B=Boundary, M=Module, C=CSECT, E=EntryPoint
MapMemoryArea	1	1	Text	N=Nucleus, M= MLPA, P=PLPA, F=FLPA, X=Private area, C=Common area
MapType / MapASID	2	4	Printable Hex	ASID (for Private area) or Record Type (for other records)
MapName	6	8	Text	Short name (may be blank, may not be unique)
MapStartAddress	14	16	Printable Hex	Start address (Record types B, M, C and E only)
MapEndAddress	30	16	Printable Hex	End address (Record types B, M, and C only)

HIS MAP format by record type

Table 74. Type I - Information record

Type I - Information record				
Field Name	Offset	Length	Format	Description
MapRecordType	0	1	Text	"I"=Information
MapMemoryArea	1	1	Text	Blank (x'40' in EBCDIC)

Appendix A. HIS MAP format

Table 74. Type I - Information record (continued)

Type I - Information record				
Field Name	Offset	Length	Format	Description
MapType	2	4	Text	"SYS", "SMFI", "OS", "FMID", "DATE", "TIME", "MAP", "LPID", "MACH", "MODE"
MapName	6	8	Text	Value
Information record names and values:				
	Name	Value	Example	Description
	SYS	ttttttt	SYS1	System name
	SMFI	tttt	SYS1	SMFID
	OS	ttttttt	z/OS	Operating System name
	FMID	ttttttt	HBB7790	Field Maintenance ID (FMID)
	z/OS	vv.rr.mm	02.01.00	z/OS version.release.mod (from ECVTPVER, ECVTPREL, ECVTP=MOD)
	DATE	yyddd	13206	Date for this map, Julian format, yyddd
	TIME	hhmmssh	20262609	Time for this map, hhmmssh format hours, minutes, seconds, hundredths of a second
	MAP	xx.yy	02.01	Map version number
	MODE	64-BIT	64-BIT	Indicates 64-bit addresses
	LPID	nnnn	0001	LPAR ID number
	MACH	tttt	2817	Machine model (e.g. 2817)

Table 75. Type B = Boundary record

Type B = Boundary record				
Field Name	Offset	Length	Format	Description
MapRecordType	0	1	Text	"B"=Boundary
MapMemoryArea	1	1	Text	Blank (x'40' in EBCDIC, x'20' in ASCII)
MapType	2	4	Text	"BDY "
MapName	6	8	Text	Memory area (PRIVATE, CSA, CSAALLOC, CSACONVT, MLPA, FLPA, PLPA, SQA, SQAALLOC, RWNUC, RON, ERON, ERWN, ESQA, EPLPA, EFLPA, EMLPA, ECSA, EPRV, DONUC)

Table 75. Type B = Boundary record (continued)

Type B = Boundary record				
Field Name	Offset	Length	Format	Description
MapStartAddress	14	16	Printable Hex	Start address for this memory area
MapEndAddress	30	16	Printable Hex	End address for this memory area

Table 76. Type A = Address Space record

Type A = Address Space record				
Field Name	Offset	Length	Format	Description
MapRecordType	0	1	Text	"A"=Address Space
MapMemoryArea	1	1	Text	"X"=Private area
MapASID	2	4	Printable Hex	ASID for this address space
MapName	6	8	Text	JOB name for this address space

Table 77. Type M = Module record

Type M = Module record				
Field Name	Offset	Length	Format	Description
MapRecordType	0	1	Text	"M"=Module
MapMemoryArea	1	1	Text	"N"=Nucleus, "M"=MLPA, "P"=PLPA, "F"=FLPA, "X"=Private area, "C"=Common area including Dynamic LPA
MapType / MapASID	2	4	Printable Hex	ASID (if loaded from an address space to Private area or Common area) or Record Type (NUC, MLPA, FLPA, PLPA, COMM (other Common area modules, Dynamic LPA))
MapName	6	8	Text	Module name
MapStartAddress	14	16	Printable Hex	Module Start address
MapEndAddress	30	16	Printable Hex	Module End address
Note: Module record may end here				
Module record - self-describing section				
Field Name	Offset	Length	Format	Description

Appendix A. HIS MAP format

Table 77. Type M = Module record (continued)

Type M = Module record				
Field Name	Offset	Length	Format	Description
MapModSDSlength	46	2	Printable Hex	"12" - Length of the module record self-describing section
MapModLocOffset	48	4	Printable Hex	Offset of module location section (0000 if no section)
MapModLocLength	52	4	Printable Hex	Length of module location section (0000 if no section)
MapModTimeOffset	56	4	Printable Hex	Offset of module load time section (0000 if no section)
MapModTimeLength	60	4	Printable Hex	Length of module load time section (0000 if no section)
Module record - module location section				
Field Name	Offset	Length	Format	Description
MapModLocType	MapModLocOffset	1	Text	Type of module location section, "D"=Dataset, "P"=Pathname, "C"=Concatenation
MapModByType	MapModLocOffset	MapModLocLength	Text	Format based on MapModLocType
Module record - module location section (Type=D)				
Field Name	Offset	Length	Format	Description
MapModLocType	MapModLocOffset	1	Text	"D"=Dataset
MapModLocVOLSER	1	6	Text	Volume Serial for this Dataset
MapModLocDSNLen	7	2	Printable Hex	Length of the MapModLocDSN value
MapModLocDSN	9	MapModLocDSNLen	Text	Dataset Name
Module record - module location section (Type=P)				
Field Name	Offset	Length	Format	Description
MapModLocType	MapModLocOffset	1	Text	"P"=Pathname
MapModLocPathLen	1	4	Printable Hex	Length of the LocPathname field
MapModLocPathname	5	MapModLocPathLen	Text	Pathname
Module record - module location section (Type=C)				
Field Name	Offset	Length	Format	Description
MapModLocType	MapModLocOffset	1	Text	"C"=Concatenation
MapModLocConcat	1	8	Text	Concatenation Name, "LPALST"

Table 77. Type M = Module record (continued)

Type M = Module record				
Field Name	Offset	Length	Format	Description
Module record - module load time section				
Field Name	Offset	Length	Format	Description
MapModTimeTOD	MapModTimeOffset	16	Printable Hex	Time in TOD format

Table 78. Type C= CSECT record

Type C= CSECT record				
Field Name	Offset	Length	Format	Description
MapRecordType	0	1	Text	"C"=CSECT
MapMemoryArea	1	1	Text	"N"=Nucleus, "M"=MLPA, "P"=PLPA, "F"=FLPA, "X"=Private area, "C"=Common area
MapType / MapASID	2	4	Printable Hex	ASID (if loaded from private area) or Record Type (NUC, MLPA, FLPA, PLPA, COMM)
MapName	6	8	Text	CSECT name up to 8 bytes (may be blank, may not be unique)
MapStartAddress	14	16	Printable Hex	CSECT Start address
MapEndAddress	30	16	Printable Hex	CSECT End address
Note: CSECT record may end here				
CSECT record - self-describing section				
Field Name	Offset	Length	Format	Description
MapCsectSDSlength	46	2	Printable Hex	"0A" - Length of the CSECT record self-describing section
MapCsectLongNmOffset	48	4	Printable Hex	Offset of CSECT Long Name section
MapCsectLongNmLength	52	4	Printable Hex	Length of CSECT Long Name section (0 indicates no section)
CSECT record - CSECT Long Name section				

Appendix A. HIS MAP format

Table 78. Type C= CSECT record (continued)

Type C= CSECT record				
Field Name	Offset	Length	Format	Description
Field Name	Offset	Length	Format	Description
MapCsectLongName	MapCsectLongNmOffset	MapCsectLongNmLength	Text	CSECT Long Name (if longer than 8 bytes)

Table 79. Type E = Entry Point

Type E= Entry Point				
Field Name	Offset	Length	Format	Description
MapRecordType	0	1	Text	E=Entry Point
MapMemoryArea	1	1	Text	N=Nucleus
MapType	2	4	Printable Hex	"NUC"=Nucleus
MapName	6	8	Text	Entry Point name
MapStartAddress	14	16	Printable Hex	Entry Point address

Appendix B. Accessibility

Accessible publications for this product are offered through IBM Knowledge Center (<http://www.ibm.com/support/knowledgecenter/SSLTBW/welcome>).

If you experience difficulty with the accessibility of any z/OS information, send a detailed message to the "Contact us" web page for z/OS (<http://www.ibm.com/systems/z/os/zos/webqs.html>) or use the following mailing address.

IBM Corporation
Attention: MHVRCFS Reader Comments
Department H6MA, Building 707
2455 South Road
Poughkeepsie, NY 12601-5400
United States

Accessibility features

Accessibility features help users who have physical disabilities such as restricted mobility or limited vision use software products successfully. The accessibility features in z/OS can help users do the following tasks:

- Run assistive technology such as screen readers and screen magnifier software.
- Operate specific or equivalent features by using the keyboard.
- Customize display attributes such as color, contrast, and font size.

Consult assistive technologies

Assistive technology products such as screen readers function with the user interfaces found in z/OS. Consult the product information for the specific assistive technology product that is used to access z/OS interfaces.

Keyboard navigation of the user interface

You can access z/OS user interfaces with TSO/E or ISPF. The following information describes how to use TSO/E and ISPF, including the use of keyboard shortcuts and function keys (PF keys). Each guide includes the default settings for the PF keys.

- *z/OS TSO/E Primer*
- *z/OS TSO/E User's Guide*
- *z/OS V2R2 ISPF User's Guide Vol I*

Dotted decimal syntax diagrams

Syntax diagrams are provided in dotted decimal format for users who access IBM Knowledge Center with a screen reader. In dotted decimal format, each syntax element is written on a separate line. If two or more syntax elements are always present together (or always absent together), they can appear on the same line because they are considered a single compound syntax element.

Each line starts with a dotted decimal number; for example, 3 or 3.1 or 3.1.1. To hear these numbers correctly, make sure that the screen reader is set to read out

punctuation. All the syntax elements that have the same dotted decimal number (for example, all the syntax elements that have the number 3.1) are mutually exclusive alternatives. If you hear the lines 3.1 USERID and 3.1 SYSTEMID, your syntax can include either USERID or SYSTEMID, but not both.

The dotted decimal numbering level denotes the level of nesting. For example, if a syntax element with dotted decimal number 3 is followed by a series of syntax elements with dotted decimal number 3.1, all the syntax elements numbered 3.1 are subordinate to the syntax element numbered 3.

Certain words and symbols are used next to the dotted decimal numbers to add information about the syntax elements. Occasionally, these words and symbols might occur at the beginning of the element itself. For ease of identification, if the word or symbol is a part of the syntax element, it is preceded by the backslash (\) character. The * symbol is placed next to a dotted decimal number to indicate that the syntax element repeats. For example, syntax element *FILE with dotted decimal number 3 is given the format 3 * FILE. Format 3* FILE indicates that syntax element FILE repeats. Format 3* * FILE indicates that syntax element * FILE repeats.

Characters such as commas, which are used to separate a string of syntax elements, are shown in the syntax just before the items they separate. These characters can appear on the same line as each item, or on a separate line with the same dotted decimal number as the relevant items. The line can also show another symbol to provide information about the syntax elements. For example, the lines 5.1*, 5.1 LASTRUN, and 5.1 DELETE mean that if you use more than one of the LASTRUN and DELETE syntax elements, the elements must be separated by a comma. If no separator is given, assume that you use a blank to separate each syntax element.

If a syntax element is preceded by the % symbol, it indicates a reference that is defined elsewhere. The string that follows the % symbol is the name of a syntax fragment rather than a literal. For example, the line 2.1 %OP1 means that you must refer to separate syntax fragment OP1.

The following symbols are used next to the dotted decimal numbers.

? indicates an optional syntax element

The question mark (?) symbol indicates an optional syntax element. A dotted decimal number followed by the question mark symbol (?) indicates that all the syntax elements with a corresponding dotted decimal number, and any subordinate syntax elements, are optional. If there is only one syntax element with a dotted decimal number, the ? symbol is displayed on the same line as the syntax element, (for example 5? NOTIFY). If there is more than one syntax element with a dotted decimal number, the ? symbol is displayed on a line by itself, followed by the syntax elements that are optional. For example, if you hear the lines 5 ?, 5 NOTIFY, and 5 UPDATE, you know that the syntax elements NOTIFY and UPDATE are optional. That is, you can choose one or none of them. The ? symbol is equivalent to a bypass line in a railroad diagram.

! indicates a default syntax element

The exclamation mark (!) symbol indicates a default syntax element. A dotted decimal number followed by the ! symbol and a syntax element indicate that the syntax element is the default option for all syntax elements that share the same dotted decimal number. Only one of the syntax elements that share the dotted decimal number can specify the ! symbol. For example, if you hear the lines 2? FILE, 2.1! (KEEP), and 2.1 (DELETE), you know that (KEEP) is the

default option for the FILE keyword. In the example, if you include the FILE keyword, but do not specify an option, the default option KEEP is applied. A default option also applies to the next higher dotted decimal number. In this example, if the FILE keyword is omitted, the default FILE(KEEP) is used. However, if you hear the lines 2? FILE, 2.1, 2.1.1! (KEEP), and 2.1.1 (DELETE), the default option KEEP applies only to the next higher dotted decimal number, 2.1 (which does not have an associated keyword), and does not apply to 2? FILE. Nothing is used if the keyword FILE is omitted.

*** indicates an optional syntax element that is repeatable**

The asterisk or glyph (*) symbol indicates a syntax element that can be repeated zero or more times. A dotted decimal number followed by the * symbol indicates that this syntax element can be used zero or more times; that is, it is optional and can be repeated. For example, if you hear the line 5.1* data area, you know that you can include one data area, more than one data area, or no data area. If you hear the lines 3* , 3 HOST, 3 STATE, you know that you can include HOST, STATE, both together, or nothing.

Notes:

1. If a dotted decimal number has an asterisk (*) next to it and there is only one item with that dotted decimal number, you can repeat that same item more than once.
2. If a dotted decimal number has an asterisk next to it and several items have that dotted decimal number, you can use more than one item from the list, but you cannot use the items more than once each. In the previous example, you can write HOST STATE, but you cannot write HOST HOST.
3. The * symbol is equivalent to a loopback line in a railroad syntax diagram.

+ indicates a syntax element that must be included

The plus (+) symbol indicates a syntax element that must be included at least once. A dotted decimal number followed by the + symbol indicates that the syntax element must be included one or more times. That is, it must be included at least once and can be repeated. For example, if you hear the line 6.1+ data area, you must include at least one data area. If you hear the lines 2+, 2 HOST, and 2 STATE, you know that you must include HOST, STATE, or both. Similar to the * symbol, the + symbol can repeat a particular item if it is the only item with that dotted decimal number. The + symbol, like the * symbol, is equivalent to a loopback line in a railroad syntax diagram.

Notices

This information was developed for products and services offered in the U.S.A. or elsewhere.

IBM may not offer the products, services, or features discussed in this document in other countries. Consult your local IBM representative for information on the products and services currently available in your area. Any reference to an IBM product, program, or service is not intended to state or imply that only that IBM product, program, or service may be used. Any functionally equivalent product, program, or service that does not infringe any IBM intellectual property right may be used instead. However, it is the user's responsibility to evaluate and verify the operation of any non-IBM product, program, or service.

IBM may have patents or pending patent applications covering subject matter described in this document. The furnishing of this document does not give you any license to these patents. You can send license inquiries, in writing, to:

IBM Director of Licensing
IBM Corporation
North Castle Drive
Armonk, NY 10504-1785
U.S.A

For license inquiries regarding double-byte character set (DBCS) information, contact the IBM Intellectual Property Department in your country or send inquiries, in writing, to:

Intellectual Property Licensing
Legal and Intellectual Property Law
IBM Japan, Ltd.
19-21, Nihonbashi-Hakozakicho, Chuo-ku
Tokyo 103-8510, Japan

The following paragraph does not apply to the United Kingdom or any other country where such provisions are inconsistent with local law: INTERNATIONAL BUSINESS MACHINES CORPORATION PROVIDES THIS PUBLICATION "AS IS" WITHOUT WARRANTY OF ANY KIND, EITHER EXPRESS OR IMPLIED, INCLUDING, BUT NOT LIMITED TO, THE IMPLIED WARRANTIES OF NON-INFRINGEMENT, MERCHANTABILITY OR FITNESS FOR A PARTICULAR PURPOSE. Some states do not allow disclaimer of express or implied warranties in certain transactions, therefore, this statement may not apply to you.

This information could include technical inaccuracies or typographical errors. Changes are periodically made to the information herein; these changes will be incorporated in new editions of the publication. IBM may make improvements and/or changes in the product(s) and/or the program(s) described in this publication at any time without notice.

Any references in this information to non-IBM Web sites are provided for convenience only and do not in any manner serve as an endorsement of those Web sites. The materials at those Web sites are not part of the materials for this IBM product and use of those Web sites is at your own risk.

IBM may use or distribute any of the information you supply in any way it believes appropriate without incurring any obligation to you.

Licensees of this program who wish to have information about it for the purpose of enabling: (i) the exchange of information between independently created programs and other programs (including this one) and (ii) the mutual use of the information which has been exchanged, should contact:

Site Counsel
IBM Corporation
2455 South Road
Poughkeepsie, NY 12601-5400
USA

Such information may be available, subject to appropriate terms and conditions, including in some cases, payment of a fee.

The licensed program described in this information and all licensed material available for it are provided by IBM under terms of the IBM Customer Agreement, IBM International Program License Agreement, or any equivalent agreement between us.

Information concerning non-IBM products was obtained from the suppliers of those products, their published announcements or other publicly available sources. IBM has not tested those products and cannot confirm the accuracy of performance, compatibility or any other claims related to non-IBM products. Questions on the capabilities of non-IBM products should be addressed to the suppliers of those products.

All statements regarding IBM's future direction or intent are subject to change or withdrawal without notice, and represent goals and objectives only.

If you are viewing this information softcopy, the photographs and color illustrations may not appear.

COPYRIGHT LICENSE:

This information might contain sample application programs in source language, which illustrate programming techniques on various operating platforms. You may copy, modify, and distribute these sample programs in any form without payment to IBM, for the purposes of developing, using, marketing or distributing application programs conforming to the application programming interface for the operating platform for which the sample programs are written. These examples have not been thoroughly tested under all conditions. IBM, therefore, cannot guarantee or imply reliability, serviceability, or function of these programs. The sample programs are provided "AS IS", without warranty of any kind. IBM shall not be liable for any damages arising out of your use of the sample programs.

Policy for unsupported hardware

Various z/OS elements, such as DFSMS, HCD, JES2, JES3, and MVS, contain code that supports specific hardware servers or devices. In some cases, this device-related element support remains in the product even after the hardware devices pass their announced End of Service date. z/OS may continue to service element code; however, it will not provide service related to unsupported hardware devices. Software problems related to these devices will not be accepted

for service, and current service activity will cease if a problem is determined to be associated with out-of-support devices. In such cases, fixes will not be issued.

Minimum supported hardware

The minimum supported hardware for z/OS releases identified in z/OS announcements can subsequently change when service for particular servers or devices is withdrawn. Likewise, the levels of other software products supported on a particular release of z/OS are subject to the service support lifecycle of those products. Therefore, z/OS and its product publications (for example, panels, samples, messages, and product documentation) can include references to hardware and software that is no longer supported.

- For information about software support lifecycle, see: IBM Lifecycle Support for z/OS (<http://www.ibm.com/software/support/systemsz/lifecycle/>)
- For information about currently-supported IBM hardware, contact your IBM representative.

Trademarks

IBM, the IBM logo, and [ibm.com](http://www.ibm.com) are trademarks or registered trademarks of International Business Machines Corp., registered in many jurisdictions worldwide. Other product and service names might be trademarks of IBM or other companies. A current list of IBM trademarks is available at "Copyright and trademark information".

Index

Special characters

- * (asterisk)
 - specified on identifier of system command 534
 - specified on jobname.identifier of system command 176, 901
 - specified on parameter of system command 19, 349, 537, 538, 539, 540, 583, 584, 585, 586

Numerics

- 3277-2 display station
 - in message stream mode 137
 - illustration 137
- PFK
 - displaying number 221
 - selector pen 112
- 3490 tape device 941
- 3990-3
 - SETSMS command
 - DINTERVAL parameter 751

A

- ACBNAME parameter in APPCPMxx 649
- accessibility 983
 - contact IBM 983
 - features 983
- ACDS parameter
 - SETSMS command 744
- ACR (alternate CPU recovery) 59
 - machine check 529
- action
 - action for a SLIP trap 812
- action message
 - backup 136
 - deleting
 - eventual action 219
 - immediate action 219
 - retained immediate 219
 - displaying information 143
 - retained
 - deleting 219
 - retained by action message retention facility 139, 143
 - retention facility 219
 - activating 224
 - cancelling 224
 - changing 224
 - deactivating 224
 - deleting 220
 - displaying status 224
- action message retention facility
 - cancelling 143
 - deactivating 143
 - description 143
 - displaying action messages not retained 145

- action message retention facility
 - (continued)
 - retrieving an action message 143
- ACTION parameter
 - SLIP command 831
- ACTIVATE command 170
 - example 173
 - specifying FORCE 172
 - summary table 154
 - syntax 170
- ACTIVATE parameter
 - SETSSI command 761
- ACTIVATE=SERVICE on DISPLAY command 384
- activating a workload management service policy
 - controlling 21
- activation
 - action message retention facility 143
 - general WTO installation exit IEAVMXIT 144
- ACTIVE parameter
 - DISPLAY SMS command 434
- ADD dump mode 179
- ADD parameter
 - SETSSI command 760
- address
 - direct 805
 - indirect 805
 - wraparound 861
- address compare in SLIP
 - definition 845
- address space
 - qualifying direct or indirect address 809
- Advanced Program-to-Program Communication/MVS (APPC/MVS)
 - address space information changing 620
- AFTER parameter
 - in PROGxx parmlib member 730
- AKP parameter
 - SETSMS command 744
- ALLC_OFFLN statement in SETALLOC 641
- alternate nucleus
 - load 6
- alternate path 211, 944
 - recovery 73
- ALTLU parameter in APPCPMxx 652
- APF (authorized program facility)
 - listing authorized libraries 629
- APF list
 - updating 721
- apostrophe
 - use 153
- ARM (automatic resource management)
 - switching couple data containing ARM information 779
- ASID|A on DISPLAY command 381

- assign
 - command group 927, 933
 - HMCS console 926
 - MCS (multiple support console) console 926
 - routing code 927, 933
 - SMCS console 926
- assignment
 - message level 140
 - routing code 140
- assistive technologies 983
- ATBOTTOM parameter
 - in PROGxx parmlib member 730
- ATTOP parameter
 - in PROGxx parmlib member 730
- authorization
 - changing console 135
 - authorization to system commands 124
- AUTOACT 925
- automatic
 - AVR (automatic volume recognition) 31
- automatic message deletion
 - assigning 233
- automatic restart 23
- automatic restart management
 - DISPLAY XCF command 479
- automatically switchable tape devices
 - change the AUTOSWITCH attribute 940
 - definition 28
 - obtain the status of 29, 461
 - operational considerations 28
- auxiliary storage
 - adding 591
 - deleting 593
 - draining 593
 - replacing 593
- AVR (automatic volume recognition) 31

B

- base address 807
- BASE parameter in APPCPMxx 650
- base/displacement shorthand in SLIP command 807
- BCPII
 - starting 891
 - stopping 903
- binary compare in SLIP
 - definition 844
- blank screen
 - error response 115
 - response 116
- BLKLNTH parameter in SETALLOC 637
- BMFTIME parameter
 - SETSMS command 752
- box a device 32
- BPXPRMxx parmlib member
 - changing, with SETOMVS 707

- branch
 - SLIP trap 823
- BreakPointValue parameter
 - SETSMS command 745
- BRL on DISPLAY command 382
- broadcast
 - message
 - level 238
 - routing 238
- broadcast data set 22
- broadcast message
 - description 140
- buffer shortage 116, 119

C

- C command 174
- CA_RECLAIM parameter
 - SETSMS command 745
- cache
 - subsystem 592
- CACHE parameter
 - DISPLAY SMS command 435
- CACHETIME parameter
 - SETSMS command 752
- cancel
 - job 174
 - status display for an inactive console 115
- CANCEL action
 - how to perform 107
 - perform 107, 111, 113, 115
- CANCEL command 23, 174
 - example 175
 - summary table 154
 - syntax 175
- CAPS|C on DISPLAY command 383
- catalog address space 532
 - information
 - displaying 549
 - service
 - requesting 549
- CATLG_ERR statement in SETALLOC 643
- CD command 179
- central storage
 - job 24
 - moving online or offline 206
 - physical view 95
 - reconfiguring 98
 - specifying configuration 3
 - specifying RSU parameter
 - example 96
- CF command 202
- CFCACHE parameter
 - DISPLAY SMS command 435
- CFRM (coupling facility resource management)
 - switching couple data containing CFRM information 779
- change
 - dump mode and option 180
 - status
 - of secondary console 938
 - system commands a console can receive 926
- change information in the entry area 113

- changing authorization
 - console 135
- changing resource states
 - MODIFY command 582
- channel path
 - alert condition 65
 - initialized condition 65
 - outstanding reserve 63
 - permanent error 65
 - placing online or offline 208
 - reconfiguring 98, 208
 - recovery 62
 - terminating error 62
- channel path errors
 - recovery 71
- channel subsystem
 - error 62, 68
 - missing interrupt 66
 - monitoring facility
 - recovery 66
- characters
 - valid command 153
- checkpoint/restart 23, 25
 - effect on SLIP PER trap 819
- CHNGDUMP command 179
 - DEL operand
 - syntax 180
 - RESET operand
 - syntax 188
 - scope in a sysplex 180
 - SET operand
 - syntax 190
 - summary table 154
- CICSVR
 - VARY SMS command 968
- CICSVR,RCDS
 - VARY SMS command 968
- class C1 commands 39
- class C2 commands 39
- class M1 commands 36
- class M2 commands 37
- clock
 - setting 598
- CLOCKxx member of SYS1.PARMLIB
 - OPERATOR PROMPT parameter 8
- CLOCKxx parmlib member
 - OPERATOR PROMPT parameter 599
- CLPA (create link pack area)
 - option 591
- CMD5 command 200
- CNS example
 - SETGRS 661
- COFDLFxx member
 - keyword
 - MAXEXPB 560
 - PCTRETB 560
- color
 - description 103
- color options
 - displayed 145
- command
 - check PFK command 110
 - enter
 - using PFK (program function key) 109
 - using selector pen 112
 - enter with selector pen 113

- command (*continued*)
 - entry error correction 108
 - formats 168
 - how to enter
 - using keyboard 107
 - MODIFY
 - example 228
 - routing 606
 - select for hardcopy message set 149
 - syntax conventions 167
- command authority 124
- command characters
 - valid 153
- command delimiter 108
- command entry 108
- command entry error correction 108
- command example
 - CONTROL A 219
 - CONTROL C,A 220
 - CONTROL C,E 220
 - CONTROL C,I 220
 - CONTROL D 222
 - CONTROL M,AMRF 143, 224
 - CONTROL M,LOGLIM 225
 - CONTROL M,MLIM 226
 - CONTROL M,RLIM 226
 - CONTROL M,UEXIT 145, 228
 - CONTROL N,PFK 146, 147
 - CONTROL Q 233
 - CONTROL S 142, 236
 - CONTROL V,LEVEL 141
 - CONTROL V,USE 137
 - DEVSERV P 254
 - DEVSERV SMS 254
 - DISPLAY 343, 403, 404, 405, 465, 469, 470, 471
 - DISPLAY PFK 146
 - DUMP 502
 - FORCE 27, 520
 - IEEE094D 503
 - LOG 524
 - LOGOFF 525
 - MODE 530, 532
 - MODIFY 536, 538, 548, 576, 582, 586
 - MONITOR 588
 - MOUNT 590
 - PAGEADD 593
 - PAGEDEL 595
 - REPLY 598
 - ROUTE 611
 - SEND 615, 619, 620
 - SET 146, 632, 634
 - SETCEE 656
 - SETETR 658
 - SETGRS 661
 - SETIOS 683
 - SETLOAD 687
 - SETLOGR 689, 693, 694, 695, 699, 700, 702
 - SETPROG EXIT 723, 727
 - SETPROG LNKLST 732
 - SETSMT 741
 - START 882, 890, 898
 - STOP 901
 - STOPMN 907
 - SWAP 908
 - TRACE 916

- command example (*continued*)
 - VARY 140, 149, 150, 932, 939, 951, 972, 973
 - VARY HARDCPY 149, 937
 - WRITELOG 976
- command flooding 36
- command group 124
 - assigning 927, 933
 - figure showing 124
 - summary 125
- COMMNDxx parmlib member 804
- common storage tracking
 - SET command 625
- communication
 - operator-to-operator 615
 - terminal user 617
 - time-sharing user 616
- component trace 27, 913
 - option
 - replying 600
 - specifying 600
- CONFIG command 202
 - example 212, 215, 216
 - reconfiguration 91
 - summary table 154
- configuration
 - changing 24
- configuration properties
 - modification 538
 - modification, planned 539
- configure
 - core 204
- CONFIGxx member
 - SYS1.PARMLIB
 - reconfiguration 91
- CONS command authority 125
- console 538, 539
 - activity
 - lack 115
 - activity, lack 115
 - changing authorization 135
 - console use 136
 - control command 124
 - description 102
 - device 101
 - error condition 115
 - hardware at IPL 2
 - hardware error 115
 - inactivity
 - cause 115
 - response 115
 - MCS (multiple console support)
 - definition 102
 - use 102
 - MCS at IPL 3
 - NIP at IPL 2
 - operation 101
 - recovery 115
 - response to an inactive 115
 - varying offline 119
- console area
 - L= operand 105
- console assignment
 - making 124
- console characteristics
 - changing 120
 - defining 120
- console characteristics (*continued*)
 - displaying 123
- console in error condition 115
- console inactivity
 - cause 115
- console message backup
 - response 116
- console operating mode
 - definition 136
 - setting up message stream
 - console 136
 - setting up status display console 136
- console operation
 - full-capability mode
 - changing 237
 - displaying 237
 - output-only mode
 - changing 237
 - displaying 237
- console operation mode
 - effect on display screen 103
- console screen
 - information
 - removing 222
- console specification
 - altering 233
 - changing 233
 - current 233
 - displaying 233
- CONSOLxx member of Parmlib
 - CMDLEVEL parameter 935
 - ROUTCODE parameter 935
- CONSOLxx member of SYS1.PARMLIB
 - AMRF parameter 121
 - example 143
 - AREA parameter 120
 - AUTH parameter 120
 - CMDELIM parameter 121
 - CMDLEVEL parameter 122
 - CON parameter 120
 - DEL parameter 120
 - DEVNUM parameter 122
 - general description 102
 - HARDCOPY statement 122
 - INIT statement 121
 - LEVEL parameter 120
 - example 141
 - MFORM parameter 120
 - MLIM parameter 116, 121
 - MONITOR parameter on the
 - CONSOLE statement 120
 - MONITOR parameter on the
 - INIT statement 121
 - MPF parameter 121
 - PFK (program function key)
 - parameter 121
 - PFKTAB parameter 120, 147
 - relationship with CONTROL
 - command 120
 - RLIM parameter 116, 121
 - RNUM parameter 120
 - ROUTCODE parameter 120, 122
 - RTME parameter 120
 - SEG parameter 120
 - UEXIT parameter 121
 - USE parameter 120
 - UTME parameter 120
- CONSOLxx parmlib member
 - MLIM parameter 118
 - RLIM parameter 118
- contact
 - z/OS 983
- contents compare in SLIP
 - definition 845
- control
 - message format 106, 141
 - message processed by message
 - processing facility (MPF) 142
 - status displays on a status display
 - console 136
 - system message 139
- CONTROL command 217
 - A
 - example 219
 - syntax 219
 - C,A
 - example 220
 - syntax 219
 - C,CE
 - syntax 219
 - C,D
 - syntax 221
 - C,E
 - example 220
 - C,I
 - example 220
 - syntax 219
 - D
 - example 222
 - syntax 221
- duplicate line
 - K Q 233
- E
 - example 223
 - syntax 222
- example 112
- extended MCS console
 - limitation 218
- M,AMRF
 - example 143, 224
 - syntax 224
- M,LOGLIM
 - example 225
 - syntax 224
- M,MLIM
 - example 226
 - syntax 225
- M,RLIM
 - example 226
- M,UEXIT
 - example 145, 228
 - syntax 227
- N,PFK
 - example 146, 147, 232
 - syntax 230, 232
- Q
 - example 233
 - syntax 232, 233
- relationship to CONSOLE statement
 - in CONSOLxx 120
- S
 - example 142, 236
 - syntax 233
- scope in a sysplex 218

- CONTROL command (*continued*)
 - SMCS APPLID
 - SMCS 228
 - status display
 - framing 221
 - summary table 154
 - V,LEVEL
 - example 141, 238
 - syntax 238
 - V,USE
 - example 137
 - syntax 237
 - controlling
 - system 10
 - conversational mode
 - enter command assigned to PFK 111
 - enter command with selector
 - pen 113
 - message deletion 233
 - cancelling 234
 - PFK 230
 - PFK (program function key) 145, 146
 - COPYFROM parameter
 - in PROGxx parmlib member 729
 - core
 - configuring 204
 - placing online or offline 204
 - taking offline 205
 - coupling facility
 - reconfiguration 100
 - coupling facility resource management
 - DISPLAY XCF command 479
 - CPU
 - error 57
 - hard 58
 - soft 57
 - terminating 58
 - hard error 58
 - placing online or offline 203
 - reconfiguring 203
 - recovery
 - hard error 58
 - restart 90
 - soft error 57
 - terminating error 58
 - restart 90
 - soft error 57
 - terminating error 58
 - critical action
 - message
 - level 238
 - routing 238
 - critical eventual action
 - message
 - level 238
 - routing 238
 - critical eventual action message
 - description 140
 - cross system coupling facility (XCF)
 - displaying information 473
 - cross-system coupling facility (XCF) 776
 - active configuration
 - saving 776
 - alternate data set couple
 - defining 776
 - data set couple
 - controlling 776
 - cross-system coupling facility (XCF)
 - (*continued*)
 - dumping 776
 - SETXCF command 788
 - signal path
 - modifying 776
 - starting 776
 - stopping 776
 - transport class
 - defining 776
 - deleting 776
 - modifying 776
 - XCF PR/SM policy 788
 - CRW (channel report word)
 - describing error 62
 - cursor
 - description 103
 - move 107
 - cursor detect action
 - perform 107
 - CVIO (clear virtual I/O)
 - option 591
- D**
- D command 261
 - DAE (dump analysis and elimination)
 - parameter 620, 625
 - suppression of the dump 833
 - DASD (direct access storage device)
 - maintenance 75
 - recovery 75
 - data lookaside facility (DLF)
 - starting data lookaside facility (DLF) 897
 - data removal
 - data from entry area 114
 - data set
 - clearing 513
 - dump
 - adding 507, 509
 - allocation of, automatic 507
 - clearing 507
 - deleting 513
 - disable automatic allocation 512
 - enable automatic allocation 512
 - name-pattern 516
 - DATASET parameter in APPCPMxx 653
 - date
 - setting 598, 625
 - DD (data definition) statement 30
 - DDR (dynamic device reconfiguration) 54, 907
 - failing device
 - recovery 69
 - operator-requested DDR 907
 - DEACTIVATE parameter
 - SETSSI command 761
 - dedicated tape device
 - definition 28
 - DEFAULT statement 123
 - deferred restart 24
 - define
 - routing codes for console 931, 933
 - definition
 - command for PFK (program function key) 145, 146
 - (*continued*)
 - routing codes for a console 139
 - status display console 136
 - degradation interruption
 - machine check
 - controlling recording 527
 - recording 527
 - delete
 - SLIP trap 880
 - DELETE parameter
 - SETSSI command 761
 - DELETE parameter in CUNUNIxx 775
 - deletion
 - message
 - from message stream console 136
 - delimiter of command 108
 - device
 - allocation 30
 - assignment 30
 - boxing 32
 - failing
 - recovery 69
 - hung
 - recovery 69
 - I/O device online or offline 941
 - place online or offline 941
 - supported and not supported by DDR 55
 - device status
 - displaying 11
 - Device Support Facilities 75
 - devices or a path to devices attached to a control unit
 - process devices or a path 939
 - DEVSERV command 239
 - channel path status
 - displaying 239
 - complete syntax 239
 - device status
 - displaying 239
 - example 254
 - SMS-managed device status
 - displaying 239
 - summary table 154
 - use 11
 - DFSMSStvs
 - VARY SMS command 959
 - DINTERVAL parameter
 - SETSMS command 751
 - direct address in indirect addressing 805
 - DIRECTORY parameter in
 - SETALLOC 636
 - disable status
 - meaning 956
 - DFSMSStvs instance 960
 - disabled loop 20
 - displacement in indirect addressing 806
 - display
 - action messages awaiting action 143
 - action messages not retained 145
 - active job 24
 - color options 145
 - console characteristics 123
 - console operating mode 123
 - console specifications 123
 - console status 123
 - current system status 11

- display (*continued*)
 - device status 11
 - hardcopy information 151
 - highlighting options 145
 - information about system log 141
 - intensity options 145
 - job information 11
 - logged-on TSO/E (Time Sharing Option/Extension) users 22
 - message deletion specifications 123
 - message levels not assigned to any console 141
 - message processing facility (MPF)
 - message processing 145
 - message processing facility (MPF)
 - verbose message production 145
 - number of allowed WTO message buffers 123
 - number of allowed WTOR message buffers 123
 - PFK (program function key)
 - definition 123
 - routing codes not assigned to any console 141
 - status of installation exit 145
 - system activity 11
 - time and date 115
 - DISPLAY AXR command
 - summary table 154
 - DISPLAY command 261
 - ACTIVATE=SERVICE operand 384
 - ASID|A operand 381
 - BRL operand 382
 - CAPS|C operand 383
 - CONSOLES
 - example 141, 151
 - displaying active service policy 467
 - displaying general IPL information
 - used by the system 342
 - displaying IOS RECOVERY
 - options 341
 - displaying IPL information 342
 - displaying PARMLIB
 - information 403
 - displaying PCIE information 402
 - displaying the logical parmlib setup
 - for a system 403
 - example 465, 469, 470, 471
 - EXCEPTION|E operand 382
 - FILE|F operand 382
 - LIMITS|L operand 383
 - M 11
 - NAME|N operand 382
 - OMVS operand 380
 - OPTIONS|O operand 383
 - OWNER|O operand 382
 - PF
 - example 146
 - PFK (program function key)
 - example 110
 - PID operand 382
 - PIPES operand 382
 - R
 - example 220
 - RESET operand 384
 - scope in a sysplex 263
 - SER operand 384
 - DISPLAY command (*continued*)
 - summary table 154
 - SUMMARY|S operand 381
 - TYPE|T operand 383
 - U
 - use 11
 - U operand 381
 - use 11
 - VSERVER|V operand 383
 - DISPLAY Command
 - MIDAW facility status 337
 - display console
 - features 103
 - DISPLAY CONSOLES command
 - example 118
 - sample 118
 - sample output 118
 - Display ICSF command 326
 - DISPLAY IPLINFO command
 - example 343
 - DISPLAY PARMLIB command
 - example 403, 404, 405
 - display screen area
 - on console 103
 - DISPLAY SMFLIM command
 - description 429
 - DISPLAY SMS command
 - ACTIVE parameter 434
 - CACHE parameter 435
 - CFCACHE parameter 435
 - description 432
 - SHCDS parameter 440
 - SMS parameter 434
 - STATUS parameter 440
 - DISPLAY SSI command
 - ALL parameter 452
 - DYNAMIC parameter 453
 - FUNC parameter 453
 - LIST parameter 452
 - SSI parameter 452
 - STATUS parameter 453
 - SUBSYS parameter 453
 - syntax 452
 - DISPLAY WLM command
 - syntax 467
 - DISPLAY XCF command
 - syntax 473
 - displaying device status and allocation
 - the IPL volume 461
 - displaying SMS information 432
 - displaying storage limit information 429
 - DISSTIMEOUT parameter
 - SETSMS command 751
 - DLF (data lookaside facility)
 - changing 559
 - defined 897
 - displaying 560
 - modifying 560
 - stopping address space 902
 - DLF (data lookaside facility) address space
 - stopping 902
 - DLF (data lookaside facility) data object
 - starting 897
 - DLOG (JES3 system log) 150
 - domain description table
 - changing 648, 656
 - DS command 239
 - DSNAME parameter
 - in PROGxx parmlib member 730
 - SETSMS command 756
 - dump
 - clearing 513
 - data set
 - adding 507, 509
 - clearing 507
 - deleting 513, 516
 - disable automatic allocation 512
 - enable automatic allocation 512
 - name-pattern 516
 - mode and option 179
 - option
 - specifying 489
 - resources
 - adding 509
 - deleting 513, 514
 - DUMP command 487
 - example 502
 - option
 - replying 600
 - specifying 600
 - summary table 154
 - syntax
 - complete 488
 - dump options list
 - for SYSABEND dump type 179
 - for SYSMDUMP dump type 179
 - for SYSUDUMP dump type 179
 - DUMPCF, SETXCF 781
 - DUMPDS command
 - summary table 154
 - dynamic device allocation 30
 - dynamic exits
 - display 412
 - update 723, 728
 - dynamic I/O configuration 91
 - dynamic LPA
 - managing 732
 - Dynamic LPA module information
 - display 416
 - dynamic parmlib concatenation
 - dynamic Changing
 - dynamic changing 685
 - dynamically activating maintenance
 - z/OS Unix System Services 576
- ## E
- E command 603
 - enable status
 - meaning 956
 - data set 960
 - DFSMSStvs instance 960
 - enablement policy
 - changing 620
 - display 409
 - ENQMAXA example
 - SETGRS 662
 - ENQMAXU example
 - SETGRS 662
 - ENTER action
 - perform 107
 - enter command
 - using keyboard 107

entry area
 blank out 114
 change information 113
 character insertion 114
 description 104
 error correction 113
 ERROMSG parameter in SETALLOC 643
 error
 CPU 57
 storage 60
 error code 7
 error event
 trap 812
 error message
 response 116
 error recovery 29
 in SMF 26
 switch data set 26
 error response
 blank screen 115
 console error condition 115
 error message 115
 system error 115
 ETR (External Time Reference)
 machine check 58
 eventual action
 message
 deleting 219, 220
 eventual action message
 description 140
 example of command
 CONFIG 212, 215, 216
 CONTROL D command 112
 CONTROL E command 112
 DISPLAY CONSOLES 118
 DISPLAY PFK 110
 DISPLAY T 115
 SEND command 153
 EXCEPTION|E on DISPLAY
 command 382
 extended highlight capability
 description 103
 external writer
 data set selection
 specifying criteria 583
 MODIFY command
 data set selection 583
 starting 898

F
 F command 532
 FAILJOB parameter in SETALLOC 643
 fetch
 SLIP trap 823
 FILE|F on DISPLAY command 382
 flagged
 message
 deleting 223
 FORCE command 23, 517
 caution 517
 example 27, 520
 summary table 154
 syntax
 complete 518
 using 517

FORCE operand of CONFIG command
 cautions about using 33, 209
 FORCE operand of VARY command
 cautions about using 33
 cautions about using FORCE with
 OFFLINE 945
 full-capability console
 console 137
 defined 137
 full-capability mode
 cursor on console 103
 display screen for, illustration 104
 keyboard on console 103
 operation on display console 106

G

G command 907
 general trace service 27
 GETMAIN/FREEMAIN/STORAGE
 tracing
 SET command 625
 global resource serialization
 removing a system from
 complex 946
 VARY GRS command 946
 global resource serialization (GRS)
 resource name list
 changing 620
 GRNAME parameter in APPCPMxx 652
 GRS (global resource serialization)
 resource name list
 selecting 625
 GRSQ example
 SETGRS 662
 GTF (generalized trace facility) 27
 starting 888

H

HALT command 55, 521
 complete syntax 521
 summary table 154
 hard error
 CPU 58
 storage 61
 hard interruption
 machine check
 controlling recording 527
 monitoring 527
 hardcopy medium
 changing status 935
 controlling in CONSOLxx 122
 device, bypassing 119
 displaying information 151
 message 238
 hardcopy message set
 minimum routing codes for 937
 selecting a command 149
 selecting messages 148
 hardcopy processing
 controlling 935
 defaults used for 123
 varying 935
 hardware
 CPU error 57

hardware (*continued*)
 problem
 recovery 55
 recovery 56
 hardware configuration definition (HCD)
 defining a device 119
 hardware console
 definition 2
 to process MVS message traffic 119
 hardware event data collection
 start, configure, and stop 561
 Hardware Instrumentation Services (HIS)
 start, configure, and stop 561
 hardware malfunction 32
 hardware unit
 deselecting 91
 logical reconfiguration 92
 HCD (hardware configuration definition)
 device definition 101
 high speed buffer
 error 62
 highlighting of message 378
 displaying options in effect 145
 HIS MAP format 977
 HMCS 2
 HMCS (HMC multiple console support)
 consoles at IPL 3
 hot I/O
 recovery 68
 hot I/O detection 32
 HYPERWRITE
 See IBM zHyperWrite data replication

I

I command 909
 I/O configuration
 loading 6
 I/O control command 124
 I/O device
 error 66
 hung
 recovery 69
 place online or offline 941
 I/O interrupt
 hot I/O 68
 missing 66
 IBM Health Checker for z/OS 532
 IBM zHyperWrite data replication
 displaying status of 337
 ICKDSF (Device Support Facilities) 75
 ICRF (Integrated Cryptographic Feature)
 CPU with ICRF
 bringing online 94
 reconfiguring 93
 taking offline 94
 removing last ICRF 94
 ICSF (Integrated Cryptographic Service
 Facility)
 Display ICSF 326
 ICSF operator commands
 SETICSF 673
 IEA101A message 7
 IEA116A message 602
 IEA347A message 7
 IEA886A message 598
 IEA888A message 599

IEA903A message 599
 IEACMDxx parmlib member 804
 IEASLPxx parmlib member 804
 IEASYSxx member of SYS1.PARMLIB 7
 IEAVMXIT installation exit
 description 144
 displaying status 145
 status
 activating 227, 233
 changing 227, 233
 displaying 227, 233
 IECIOSxx member
 Parmlib
 I/O device time interval 66
 IEE094D message 600
 IEE100E message 210
 IEE131D message 210, 211
 IEE360I message 27
 IEE507D message 210, 211
 IEE508E message 211
 IEE980I message 27
 IEF225D message 23
 IEF238D message 33
 IEFAUTOS structure
 on coupling facility 28
 IEFBR14_DELMIGDS parameter in
 SETALLOC 644
 IFASMFDP dump program 26
 IGNORE statement in SETAUTOR 654
 immediate action
 message
 deleting 219
 level 238
 routing 238
 immediate action message
 deleting 220
 IMSI 5
 inactive console
 characteristic 115
 response 115
 indirect address 805
 indirect addressing
 DATA parameter 807
 LIST parameter 808
 RANGE parameter 808
 REFAFTER parameter 807
 REFBEFOR parameter 807
 SUMLIST parameter 808
 TRDATA parameter 808
 indirection indicator in indirect
 addressing 806
 INFO command authority 125
 informational
 message
 level 238
 routing 238
 informational command 124
 informational message
 description 140
 initialization message suppression
 indicator (IMSI) 5
 initialization of system software 7
 inline commands 39
 installation exit routine
 description of use in processing a
 message 144

instruction fetch
 SLIP trap 823
 instruction line
 description 104
 Integrated Cryptographic Feature (ICRF)
 bringing online 204
 taking offline 204
 intensity
 description 103
 interception
 of system event 803
 interruption
 machine check
 controlling recording 527
 monitoring 527
 INTERVAL parameter
 SETSMS command 751
 IO command authority 125
 IOACTION command 522
 summary table 154
 IOS,MIH command options and functions
 ASM 341
 IPL (initial program loader) 7
 procedure 7
 program 7
 IQP PCIe-related parameters
 displaying 344
 IRA200I message 591
 IRA201I message 592
 ISG334I 661
 IXL126I message 211
 IXL127I message 211

J

JES event trace facilities 26
 JES2
 message routing code 139
 procedure for starting 10
 JES3
 message routing code 139
 procedure for starting 10
 using MCS console 102
 job
 cancelling 23
 controlling 22
 displaying active 24
 passing information 23, 532
 restart 23
 start 23
 stop 23

K

K command 217
 keyboard
 navigation 983
 PF keys 983
 shortcut keys 983
 keyboard action 107

L

L command 524
 L= operand
 L= description 105

LIBRARY command 523
 summary table 154
 library lookaside
 displaying information 355
 library lookaside (LLA)
 defined 892
 starting LLA address space 892
 LIMITS|L on DISPLAY command 383
 LIMMSG parameter in BPXPRMxx 712
 link pack area expansion 24
 LLA (library lookaside)
 directory
 modifying 573
 stopping address space 904
 LLA (LNKLST lookaside)
 LNKLST directory
 modifying 228
 LLA address space
 starting 892
 stopping 904
 LNKLST concatenation
 display 415
 LNKLST directory
 modifying 228
 LNKLST set
 activating 731
 locating a routine 731
 load
 alternate nucleus 6
 I/O configuration 6
 IML (initial microprogram) 3
 parameter field 6
 process 7
 load function 6
 LOAD parameter 7
 locked keyboard
 response 116
 LOG command 150, 524
 complete syntax 524
 example 524
 summary table 154
 LOG parameter
 VARY SMS command 961
 logger 356
 logical reconfiguration
 hardware unit 92
 LOGOFF command 524
 complete syntax 524
 example 525
 summary table 154
 LOGON command 9
 complete syntax 525
 LOGON panel 525
 summary table 154
 logrec
 action for a SLIP trap 812
 recording by SLIP trap 833
 loop
 disabled 20
 lowercase character
 use 153
 LU (logical unit)
 base LU 650
 NOSCHED LU 272
 system base LU 650
 LUADD statement in APPCPMxx 648
 LUDEL command in APPCPMxx 653

M

- M command 589
- machine check
 - accompanying data 56
 - controlling status
 - monitoring 531
 - recording 531
 - CPU
 - hard error 58
 - soft error 57
 - terminating error 58
 - degradation interruption
 - controlling recording 527
 - displaying status
 - monitoring 532
 - recording 532
 - ETR (External Time Reference) 58
 - hard interruption
 - controlling recording 527, 529
 - monitoring 527, 529
 - interruption
 - controlling recording 527, 531
 - monitoring 527, 531
 - monitoring status
 - controlling recording 529
 - system recovery
 - controlling recording 527
- master catalog
 - specifying an alternate 7
- MASTER command authority 125
- master trace 27, 912
- match
 - for SLIP trap 812
- MAXCFFEATURELEVEL parameter
 - SETSMS command 749
- MAXNWAIT parameter in SETALLOC 641, 642
- MCS 2
- MCS (multiple console support)
 - consoles at IPL 3
- MCS (multiple console support) console
 - assigning 124
 - use 102
- MCS console
 - at IPL 3
 - attribute definition 102
 - defining in CONSOLxx member of SYS1.PARMLIB 102
 - subsystems' use 102
- MEASURE parameter in SETALLOC 636
- MEMDSENQMGMT parameter in SETALLOC 647
- MEMLIMIT on SETOMVS command 716
- message
 - automatic deletion
 - assigning 233
 - controlling format 141
 - deleting 219
 - SYS1.BROADCAST notice section 620
 - error response 115, 116
 - eventual action
 - deleting 220
 - flagged
 - deleting 223
 - message (*continued*)
 - format 106
 - MPF-processed
 - controlling 620
 - MPF-suppressed 620
 - number
 - controlling 221
 - deleting 222
 - operator-to-operator 615
 - processed by an installation exit 144
 - processed by IEAVMXIT 144, 227
 - processed by message processing facility (MPF) 142
 - queue
 - deleting 232
 - roll rate
 - setting 233
 - routing
 - broadcast 238
 - critical action 238
 - critical eventual action 238
 - descriptor code 238
 - immediate action 238
 - informational 238
 - message level 238
 - system failure 238
 - write to operator 238
 - SYS1.BROADCAST
 - saving 618
 - terminal user 617
 - time-sharing user 616
- message area
 - description 104
- message buffer shortage 118
- message deletion
 - automatic mode
 - assigning 233
 - defining 233
 - conversational mode 233
 - nonconversational mode 233
 - roll mode
 - assigning 233
 - defining 233
 - roll-deletable mode
 - assigning 233
 - defining 233
 - specification
 - defining 233
 - displaying 233
 - verifying 233
- message display
 - changing
 - color 628
 - highlighting 628
 - intensity 628
 - color
 - changing 628
 - control
 - MPFLSTxx member 628
 - foreign messages
 - handling 628
 - handling
 - foreign messages 628
 - verbose message production 628
 - highlighting
 - changing 628
- message flood automation
 - changing 628
- message format
 - changing 141
 - controlling 106, 141
- message identifier 106
- message level
 - assigning 238
 - assigning to a console 140
 - console
 - assigning 238
 - displaying message levels not assigned to any console 141
- message number
 - deleting 222
- message presentation
 - controlled by MPFLSTxx member 142
 - displaying options in effect 145
- message processing facility (MPF) 378
 - changing 628
 - controlling message presentation 142
 - description 142
 - displaying status 145
 - ending message suppression 628
- message queue
 - deleting 232
- message roll rate
 - setting 233
- message routing code 139
- message stream console
 - defined 136
- message stream mode
 - deleting messages from a console 136
 - display screen for, illustration 104
- message traffic
 - lack 115
- MIH
 - MIH time options and functions 337
- MIH (missing interruption handler)
 - time interval
 - dynamic changing 674
- missing I/O interrupt
 - recovery 66
- missing interruption handler (MIH)
 - time interval
 - changing 620
- MMS (MVS message service)
 - allocated resource
 - freeing 628
 - processing
 - ending 628
- MN command 587
- MODE command
 - example 530, 532
 - machine check
 - interruption 527
 - machine check interruption
 - controlling recording 531
 - summary table 154
- modify
 - SLIP trap 879
- MODIFY (F) JES3 Commands 586
- MODIFY command 22, 532
 - BPXOINIT 548

MODIFY command (*continued*)
 catalog address space
 information 549
 service 549
 CEA diagnosis information 550, 551, 554
 CEA environment 552
 CEA mode of operation 554
 changing resource states 582
 Communicating with System REXX 540
 complete syntax 540
 DLF
 changing 559
 DLF parmlib member
 replacing 560
 DLF status
 displaying 560
 example 228, 536, 582, 586
 external writer
 causing pause 585
 specifying data set selection 583
 for hardware event data collection 561
 fork() service
 restart 543, 575
 shut down 543, 575
 jobname,APPL 538
 LLA directory
 replacing 573
 OAM
 managing 574
 OMVS 576
 pass information
 z/OS UNIX System Services
 application 538
 passing a MODIFY command string to PFS through a LFS 577
 passing information to a job 23
 passing information to a job or started task 532
 replacing the current sysplex root file system 578
 stopping a PFS through an LFS interface 577
 stopping a TFS (temporary file system) running in a colony address space 579
 summary table 154
 TSO/VTAM time sharing
 modifying 539
 VLF parmlib member
 replacing 579
 z/OS UNIX initiators
 shut down 543, 575
 z/OS Unix System Services 576
 z/OS UNIX threads
 terminate 543
 z/OS UNIX Threads
 terminate 575
 MODIFY console command 538
 MONITOR command 587
 complete syntax 588
 example 588
 scope in a sysplex 587
 summary table 154
 to track terminal user 22

MONITOR command (*continued*)
 tracking a job 11
 monitoring facility
 recovery
 channel subsystem 66
 MOUNT attribute 30
 MOUNT command 30, 31
 complete syntax 589
 example 590
 scope in a sysplex 589
 summary table 154
 MOUNT command> 589
 mount tape drive
 with a partitionable processor 209
 move
 online or offline
 central storage sections 202
 channel path 202, 210
 processor 202
 MPFLSTxx member of
 SYS1.PARMLIB 144
 multiple-console
 configuration 102
 support
 for MCS console 102
 multiprocessor
 non-partitionable
 RSU parameter 97
 RSU parameter
 recommended value 97
 terminating error
 CPU 59
 MVS message service (MMS)
 changing 628
 parameter
 changing 620
 SET command 628
 starting 628
 stopping 628
N
 NAME parameter
 in PROGxx parmlib member 729
 NAME parameter in SETALLOC 638
 NAME|N on DISPLAY command 382
 navigation
 keyboard 983
 NIP (nucleus initialization program)
 completion 118
 NIP console 7
 definition 2
 no-match
 for SLIP trap 812
 NODUMP dump mode 180
 nonconversational mode
 enter command with selector
 pen 113
 entering command assigned to
 PFK 111
 message deletion 233
 cancelling 234
 PFK 230
 PFK (program function key) 145, 146
 NOSCHED parameter in
 APPCPMxx 650
 Notices 987

NQN/NONQN parameter in
 APPCPMxx 652
 nucleus
 alternate
 loading 6
 identifier 6
 primary 6
 standard 6
O
 OAM (object access method)
 managing 574
 starting 893
 starting OAM 893
 starting OAM address space 893
 OAM (Object Access Method)
 stopping address space 905
 OAM address space
 stopping 905
 OFF statement in SETAUTOR 654
 offline
 varying console 119
 offline device 101
 OLTEP (online test executive program) 30
 online device 101
 operations log
 purpose 150
 operator 9
 operator information area
 description 104
 operator load function 6
 operator-to-operator
 communication 615
 message 615
 OPERLOG (operations log) 150
 options for CHNGDUMP command 183
 OPTIONS|O on DISPLAY
 command 383
 out of line display area
 specification
 altering 219
 changing 219
 displaying 219
 output-only mode
 defined 136
 OVER dump mode 180
 OWNER|O on DISPLAY command 382
P
 P command 899
 PA command 591
 page data set
 adding 591
 deleting 593
 draining 593
 replacing 593
 PAGEADD command 591
 complete syntax 592
 example 593
 summary table 154
 PAGEDEL command 593
 auxiliary storage
 deleting 593

PAGEDEL command (*continued*)
 auxiliary storage (*continued*)
 draining 593
 replacing 593
 complete syntax 594
 example 595
 summary table 154

PAGNUM system parameter 592

parallel access volume
 boxed alias of a parallel access volume 33

parameter
 job entry subsystem 2
 on SLIP command 813

parmlib
 ADYSETxx member 625
 APPC/MVS member
 changing 620
 ASCH member
 changing 620
 AUTOR member
 changing 620
 CEAPRM member
 changing 620
 CEEPRM member
 changing 620
 CNGRP member
 changing 620
 CONSOLxx member
 AMRF parameter 224
 AREA parameter 219
 CON parameter 233
 CONSOLE statement MONITOR parameter 587
 DEL parameter 233
 INIT statement MONITOR parameter 587
 LEVEL parameter 238
 LOGLIM parameter 224
 MFORM parameter 233
 MLIM parameter 225
 PFK parameter 629
 RLIM parameter 225
 RNUM parameter 233
 RTME parameter 233
 SEG parameter 233
 UEXIT parameter 227
 USE parameter 237
 DIAGxx member
 selecting through DIAG=xx 625

GRSRNLxx member
 selecting GRS resource name list 625

IEAOPTxx member 628

IECIOSxx member 674

IGDSMSxx member
 selecting through SMS=xx 631

MMSLSTxx member
 selecting through MMS=xx 628

MSGFLDxx member 628

PFKTABxx member
 changing 629

PROGxx member 720
 selecting through PROG=xx 629

SMFPRMxx member 630, 740

Parmlib IECIOSxx member
 I/O device time interval 66

path
 varying online or offline 948

PD command 593

PER (program event recording) event trap 812

PER trap
 dynamic PER traps 819
 monitor with checkpoint/restart 819
 performance considerations 813
 PER interrupt frequency 815
 PRCNTLIM 814
 scope 814
 special parameters 815

PFK (program function key)
 assigning 232
 command
 changing 230, 232
 defining 230, 232
 conversational mode 230
 defining a command 145, 146
 definition error 109
 display command defined for 110
 display line on console 104
 display on 3277-2 display station 112
 displaying number
 3277-2 display station 221
 in conversational mode 145, 146
 initial definition 109
 keyboard 103
 nonconversational mode 230
 system installation definition 109
 table
 assigning 232
 defining 230
 use to enter command 109

PFK (program function key) parameter 148

PFK (program function key) table
 defining 147
 definition 145, 148
 description 147
 PFK (program function key) table 148

PFK display line
 example 104

PFK table
 display definition 110

PFKTABxx member of SYS1.PARMLIB
 changing 148
 description 147
 example 110
 PFK (program function key) parameter 147

PFS (physical file system)
 passing a MODIFY string through a LFS 577
 stopping a PFS through an LFS interface 577

physical reconfiguration
 hardware unit 92

physically partitioned mode
 RSU parameter
 recommended value 97

PID on DISPLAY command 382

PIPES on DISPLAY command 382

place
 channel path online or offline 208

place (*continued*)
 core online or offline 204
 CPU online or offline 203
 storage online or offline 205, 206

pointer in indirect addressing 806

POLICY parameter in SETALLOC 639, 640, 641, 644

POLICYNW parameter in SETALLOC 641, 642

PPT (program properties table)
 effects of the SET SCH command 630
 modifying 630

previous command
 retrieve 107

PRIM_ORG parameter in SETALLOC 637

primary nucleus 6

PRIMARY parameter in SETALLOC 636

primary SMF data set 26

print the system log 150

procedure
 started task 25

process resource / system manager (PR/SM)
 SETXCF command 788
 XCF PR/SM policy 788

product enablement policy
 changing 620, 629
 display 409

program function keyboard
 description 103

PRSMPOLICY option
 SETXCF command 788

PSTIMER parameter in APPCPMxx 651

PSW (program status word) 7, 20

Q

quiesce
 global resource serialization system 948
 system 55

QUIESCE command 20, 55, 595
 complete syntax 595
 summary table 154

quiesce status
 meaning 956
 data set 960
 DFSMSStvs instance 960

R

R command 596

RACF (Resource Access Control Facility)
 summary of the MVS command profile 127

REALSTORAGE parameter in CUNUNIxx 775

reconfiguration
 central processor 93
 central storage 94, 98
 channel path 98
 coupling facility 100
 failing device
 recovery 69

- reconfiguration (*continued*)
 - hardware unit
 - adding 91
 - logical 92
 - physical 92
 - removing 91
 - I/O device 99
 - ICRF (Integrated Cryptographic Feature) 93
 - processor type 92
- reconfigure
 - channel path 208
 - CPU 203
 - DDR (dynamic device reconfiguration) 54
 - I/O device 941
 - I/O path 948
 - storage 205, 206
- record
 - system event 27
- recovery
 - action 90
 - error 29
 - from inactive console condition 115
 - hardware 56
 - hot I/O 32
 - operating system 56
- Recovery
 - I/O
 - hung 69
- REDIRECTED_TAPE parameter in SETALLOC 638
- refreshing storage limit information 630
- REFRPORT option
 - display 417
- registered product
 - display 409
- remove
 - channel path 209, 210
 - last path to allocated, TP, in-use, or reserved device 209, 210
 - last path to allocated, TP, in-use, reserved device, or coupling facility 210
 - last path to coupling facility 209
 - tape or DASD volume 920
- replacing the current sysplex root file system
 - z/OS Unix System Services 578
- REPLY command 596
 - complete syntax 597
 - dump option
 - specifying 489
 - example 598
 - scope in a sysplex 597
 - short form 597
 - specifying system symbols 596
 - summary table 154
 - to invoke automatic restart 23
- requirements
 - SETSMS parameter 741
- reserve a volume 31
- reset
 - dump options to initial value 188
 - dump type to ADD 188
 - system dump options list 180
- RESET command (*continued*)
 - changing service class 604
 - forcing hung console offline 603
 - quiesce problem job or address space 604
 - resume quiesced job or address space 604
 - scope in a sysplex 603
 - summary table 154
- RESET on DISPLAY command 384
- RESET parameter
 - SET command 630
- resource allocation 29
- resource states
 - changing with MODIFY command 582
- resources
 - dump
 - adding 509
 - deleting 513, 514
- response
 - blank screen 116
 - console message backup 116
 - error message 116
 - hardware error 115
 - inactive console condition 115
 - locked keyboard 116
 - WTO buffer shortage 116
 - WTOR buffer shortage 119
- restart
 - automatic 23
 - deck 24
 - deferred 24
 - global resource serialization ring 947
 - job 23
 - SMF (system management facilities) 26
 - system 20
 - using 20
- RESTART key 20
- restore
 - screen after hardware error 116
- restrictions
 - Define PC command 607
 - DFSMStvs, VARY SMS command 959
 - DISPLAY SMS command LISTDRI keyword 437
 - GRSRNL= parameter 626
- retained action
 - message
 - deleting 219
- retained immediate
 - message
 - deleting 219
- retention facility
 - action message
 - activating 224
 - cancelling 224
 - changing 224
 - deactivating 224
 - deleting 220
 - displaying status 224
- retrieve previous command 107
- RLSABOVETHEBARMAXPOOLSIZE parameter
 - SETSMS command 750
- RLSE parameter in SETALLOC 638
- RLSFIXEDPOOLSIZE parameter
 - SETSMS command 751
- RLSINIT parameter
 - SETSMS command 750
- RMAX value
 - effect on short form of REPLY command 597
- roll mode
 - message deletion
 - assigning 233
 - defining 233
- roll-deletable mode
 - message deletion
 - assigning 233
 - defining 233
- roll-deletable mode of message deletion
 - on message stream console 136
- ROUND parameter in SETALLOC 637
- ROUTE command
 - complete syntax 606, 610
 - example 611
 - specifying system symbols 609
 - summary table 154
 - system-to-system
 - directing 606
- routing
 - message 139
 - by routing code 139, 926
- routing code
 - assigning to a console 139, 140, 926
 - description 139
 - displaying routing codes not assigned to any console 141
 - for hardcopy message set 937
- routing codes 286
 - listing 139
- RRS (resource recovery services)
 - starting 893
- RSU parameter
 - example 95
 - recommended value 97

S

- S command 882
- SCDS parameter
 - SETSMS command 745
- SCHED parameter in APPCPMxx 650
- SCHEDxx parmlib member 913
- scratch volume 31
- screen
 - erasing 222
- screen area
 - L= operand 105
 - on console of different operating mode 103
- screen character
 - description 105
- SDSN_WAIT statement in SETALLOC 639
- SDUMP dump type 179
- SE command 614
- secondary console
 - placing online or offline 938
- SECONDARY parameter in SETALLOC 636

- secondary SMF data set 26
- selector pen
 - defining a command 145
 - description 103
 - enter command 112
 - enter command in conversational mode 113
 - enter command in nonconversational mode 113
 - use 107
- send
 - message to console 926
- SEND command
 - example 153, 615, 619, 620
 - for time-sharing communication 22
 - operator-to-operator communication 615
 - message 615
 - scope in a sysplex 614
 - summary table 154
 - terminal user
 - communication 617
 - message 617
 - time-sharing user
 - communication 616
 - message 616
- SEND command> 614
- sending comments to IBM xvii
- SER on DISPLAY command 384
- service class 603
- service processor
 - damage
 - recovery 60
 - permanent failure 60
 - temporary failure 60
- set
 - dump mode and option 190
- SET command 620
 - complete syntax 623
 - DIAG parameter 625
 - example 142, 146, 632
 - GRSRNL parameter 625
 - IQP parameter 627
 - IXGCNF parameter 627
 - MEMLIMIT operand 716
 - MMS parameter 628
 - PROG parameter 629
 - relationship to CONSOLE statement
 - in CONSOLxx 121
 - RESET parameter 630
 - scope in a sysplex 622
 - SMS parameter 631
 - summary table 154
- SET GTZ command
 - summary table 154
- SET SMFLIM command
 - description 630
- set time and date 20
- SETALLOC command
 - complete syntax 634
- SETAPPC command 648
 - complete syntax 648
- SETAUTOR command
 - complete syntax 654
- SETCEE command
 - complete syntax 655
 - example 656
- SETCON command 656
 - complete syntax 656
 - scope in a sysplex 656
 - summary table 154
- SETETR command
 - complete syntax 657
 - enabling 657
 - example 658
 - PORT=n 658
 - summary table 154
- SETGRS
 - ENQMAXA 662
 - ENQMAXU 662
 - GRSQ 662
- SETGRS command
 - CNS example 661
 - complete syntax 658
 - example 661
 - MODE=STAR 658
 - summary table 154
- SETGTZ command
 - complete syntax 663
 - summary table 154
- SETHS command 672
 - summary table 154
- SETICSF command 673
- SETIOS command
 - complete syntax 674
 - example 683
 - summary table 154
- SETLOAD command
 - complete syntax 685
 - example 687
 - summary table 154
- SETLOGR command
 - complete syntax 687
 - example 689, 693, 694, 695, 699, 700, 702
 - summary table 154
- SETLOGRC command
 - changing the recording medium 703
 - summary table 154
- SETMF command
 - complete syntax 705
 - summary table 154
- SETOMVS command 707
 - syntax 708
- SETPROG command
 - summary table 154
 - syntax 720
- SETPROG EXIT command
 - example 723, 727
- SETPROG LNKLST command
 - example 732
- SETRRS ARCHIVE LOGGING command
 - complete syntax 737
- SETRRS CANCEL command
 - complete syntax 738
 - example 738
- SETRRS command
 - summary table 154
- SETRRS SHUTDOWN command
 - complete syntax 739
 - example 739
- SETRSS command
 - syntax 736
- SETSMF command
 - complete syntax 740
 - example 741
 - summary table 154
- SETSMS command
 - ACDS parameter 744
 - AKP parameter 744
 - BMFTIME parameter 752
 - BreakPointValue parameter 745
 - CA_RECLAIM parameter 745
 - CACHETIME parameter 752
 - comparison with SET SMS= 743
 - complete syntax 741
 - DINTERVAL parameter 751
 - DSSTIMEOUT parameter 751
 - INTERVAL parameter 751
 - MAXCFFEATURELEVEL parameter 749
 - parameter
 - incorrect combination 741
 - SCDS parameter 745
 - scope in a sysplex 744
 - summary table 154
- SETSSI command
 - ACTIVATE parameter 761
 - ADD parameter 760
 - CONSNAM parameter 762
 - DEACTIVATE parameter 761
 - DELETE parameter 761
 - INITPARM parameter 762
 - INITRTN parameter 762
 - SUBNAME parameter 761
 - summary table 154
 - syntax 760
- SETUNI command
 - summary table 154
 - syntax 763
- SETXCF command
 - controlling XCF 776
 - PRSMPOLICY option 788
 - scope in a sysplex 776
 - summary table 154
 - syntax 776
 - XCF PR/SM policy 788
- SETXCF DUMPCF 781
- shared device
 - operator action 73
 - recovery 73
- SHCDS parameter
 - DISPLAY SMS command 440
- shortcut keys 983
- shorthand for base/displacement in SLIP command 807
- shutdownTimeout configuration property 539
- SIDEINFO statement in APPCPMxx 653
- single-image mode
 - RSU parameter
 - recommended value 97
- SIZE parameter in SETALLOC 639
- SL command 803
- SLIP command 803
 - complete syntax 803
 - error event SLIP trap 822
 - IF SBT PER trap 823
 - indirect addressing 805
 - non-PER trap 822

- SLIP command (*continued*)
 - parameter relationship 813
 - SA PER trap 824
 - SAS PER trap 824
 - set effective PER trap 813
 - SET example 875
 - summary table 154
 - syntax for a PER trap 823
 - ZAD PER trap 825
- SLIP trap
 - instruction fetch 823
 - SAS PER 824
 - storage alteration 824
 - storage alteration by STURA 824
 - successful branch 823
 - zero address detection 825
- SLIP zero address detection (ZAD) 820
- SMF (system management facilities) 428
- SMF (system management facility)
 - option
 - changing 601
 - replying 601
- SMFLIMxx parmlib member
 - displaying storage limit information 429
 - refreshing storage limit information 630
- SMS (storage management subsystem)
 - ACDS
 - replacing 741
 - active configuration
 - saving 741
 - BMF record 752
 - cache control unit 752
 - CF processing 951
 - changing status of storage group or volume 951, 956
 - Display PDSE monitor state 956
 - Modifying processing of PDSE monitor 955
 - new configuration
 - activating 741
 - PDSE subsystem 955
 - placing a system-managed tape
 - library online or offline 955
 - Releasing PDSE latches 955
 - restarting 631
 - starting 631
 - synchronization interval
 - changing 741
 - trace option 753
 - updating volume statistics in the SMS configuration 958
 - varying an optical drive online or offline 954
 - varying an optical library online or offline 954
- SMS (Storage Management Subsystem)
 - changing status of DFSMStvs 959
- SMS parameter
 - DISPLAY SMS command 434
- SMVSAM SPHERE parameter
 - VARY SMS command 962
- soft error
 - CPU 57
 - storage 60
- SOM
 - START 895
- SPACE statement in SETALLOC 636
- SPEC_MNT statement in SETALLOC 640
- special screen character
 - description 105
- SRM (system resource manager)
 - parameter
 - changing 620
- SSI parameter
 - DISPLAY SSI command 452
- standard nucleus 6
- start
 - Advanced Program-to-Program Communication/MVS (APPC/MVS) 886
 - ASCH (APPC/MVS transaction scheduler) 887
 - BCPII 891
 - DLF (data lookaside facility) 897
 - external writer 898
 - GTF (generalized trace facility) 888
 - job 882
 - LLA address space 892
 - OAM (object access method) 893
 - RRS 893
 - starting 886, 887
 - starting APPC/MVS address space 886
 - starting APPC/MVS transaction scheduler 887
 - terminal control address space (TCAS) 895
 - TSO/Virtual Telecommunications Access Method (TSO/VTAM) 895
 - VLF (virtual lookaside facility) 897
- START CEA
 - example 888
- START command 22, 23, 27, 881, 882
 - example 882, 890, 895, 898
 - starting IBM Generic Tracker for z/OS 890
 - starting IBM Health Checker for z/OS 892
 - Starting the CEA Address Space 887
 - Starting the HIS address space 890, 903
 - summary table 154
- START RRS command
 - complete syntax 893
 - example 894
- started task
 - coding 25
 - controlling 25
 - modifying 25
 - passing information 23, 532
 - starting 25
 - starting from console 882
- started tasks
 - displaying status 353, 354
- STARThisproc
 - example 891, 903
- static system symbol table
 - dynamic Changing
 - dynamic changing 685
- status display
 - controlled by CONFIG
 - command 202
 - controlled by DISPLAY command 11
 - controlling 136
 - halting 221
 - printing
 - halting 221
 - updating 221
- status display console
 - defined 136
- status display mode
 - display screen for, illustration 104
 - setting up a console 136
- STATUS parameter
 - DISPLAY SMS command 440
- STEPNAME parameter
 - SETSMS command 756
- stop
 - BCPII 903
 - I/O on a channel path quickly with FORCE operand of CONFIG 209
 - monitoring of terminal use 22
 - OAM address space 905
 - system 55
 - TFS (temporary file system) running in colony address space 905
 - VLF (virtual lookaside facility) 906
- STOP command 22, 23, 27, 899
 - complete syntax 902
 - example 901
 - stopping IBM Health Checker for z/OS 904
 - stopping the generalized tracking facility 903
 - summary table 154
- stop routine 23
- STOPMN command 906
 - complete syntax 906
 - example 907
 - scope in a sysplex 906
 - stopping monitoring of terminal use 22
 - summary table 154
- STOPTR command
 - summary table 154
- storage
 - central
 - reconfiguration 94
 - error 60
 - hard 61
 - soft 60
 - placing online or offline 205, 206
 - reconfiguring 205, 206
- storage group
 - varying status 957
- Storage Management Subsystem (SMS)
 - displaying information 432
- subchannel
 - recovery 65
- subsystem cache 592
- successful branch
 - SLIP trap 823
- summary of changes
 - as updated March 2014 xxiii
 - Summary of changes xxiv
 - summary of system command 154

SUMMARY|S on DISPLAY
 command 381

SUPPRESS_DRMSGS parameter
 SETSMS command 751

SUPPRESS_SMSMSG parameter
 SETSMS command 751

SWAP command 54, 907
 example 908
 summary table 154

SWAP operator command
 failing device
 recovery 69

swapping device of unlike density 55

SWITCH
 varying online or offline 969

SWITCH command 26, 909
 complete syntax 909
 summary table 154

symbolic group name 31

symbolic links
 in a sysplex 720

symbols
 in commands 16

syntax conventions
 how to read 167

syntax diagram
 MODIFY 538

SYS command authority 125

SYS1.BROADCAST 615
 contents 22
 message
 saving 618
 notice section
 deleting message 620
 listing 619

SYS1.BROADCAST data set
 managing with the SEND operator
 command 614

SYS1.DUMPxx 507

SYS1.NUCLEUS 7

SYSABEND dump type 179

SYSLOG (system log) 118, 150

SYSMDUMP dump type 179

sysplex
 BPXPRMxx VERSION statement 720
 scope
 CHNGDUMP command 180
 CONTROL command 218
 definition 12
 DISPLAY command 263
 MONITOR command 587
 MOUNT command 589
 REPLY command 597
 RESET command 603
 SEND command 614
 SET command 622
 SETCON command 656
 SETSMS command 744
 SETXCF command 776
 STOPMN command 906
 summary of commands 13
 UNLOAD command 920
 VARY command 922

SETOMVS AUTOMOVE
 parameter 710

SETOMVS FILESYS parameter 710

sysplex (*continued*)
 SETOMVS FILESYSTEM
 parameter 710

SETOMVS FROMSYS parameter 710

SETOMVS MOUNTPOINT
 parameter 710

SETOMVS SYSNAME parameter 719

sysplex failure management
 DISPLAY XCF command 479
 switching couple data containing
 sysplex failure management
 information 779

sysplex scope
 CHNGDUMP command 180
 CONTROL command 218
 definition 12
 DISPLAY command 263
 MONITOR command 587
 MOUNT command 589
 REPLY command 597
 RESET command 603
 SEND command 614
 SET command 622
 SETCON command 656
 SETSMS command 744
 SETXCF command 776
 STOPMN command 906
 summary of commands 13
 UNLOAD command 920
 VARY command 922

system
 control command 124
 controlling 10
 dump options list 179
 error condition 115
 information recording
 controlling 25
 IODF (I/O definition file) 5
 monitoring 29
 operator frame 20
 record activity 148
 recovery
 controlling recording 531
 machine check interruption 531
 recovery processing 119
 residence volume 7, 55
 response, lack 115
 restart 20
 stop 55
 trace 27

system command group 124
 assigning 927, 933

system console
 definition 2

system control frame 3

system failure
 message
 level 238
 routing 238

system information request
 replying 597
 responding 597

system log
 control 148
 displaying information 141
 printing 976
 purpose 150

system log (*continued*)
 queuing 976
 starting 976
 stopping 976

system logger
 DISPLAY XCF command 479
 displaying information 356
 must be active for START RRS
 command 893
 switching couple data containing
 system logger information 779

system management facilities (SMF)
 description 26

system message
 controlling 139

system parameter 20
 entering 602
 replying 602
 specifying 602

system parameter change 20

system parameters 7

system recovery
 WTOR message
 replying 598

system request
 WTOR message
 replying 598

System Security WTORs
 replying 598

SYSTEM statement in SETALLOC 644

system symbols
 in commands 16

system task
 starting from console 882

system trace 911

system-initiated DDR 908
 switching a data set 909

system-to-system
 ROUTE command
 directing 606

SYSUDUMP dump type 179

T

T command 620

tape
 blank 31
 label 31
 label verification 590
 unlabeled 31

tape device
 define automatically switchable 940
 in a sysplex 28

tape drive
 mounting with a partitionable
 processor 209

TAPELIB_PREF parameter in
 SETALLOC 644

tapemark 31

TCAS (terminal control address
 space) 539

TEMPDSFORMAT parameter in
 SETALLOC 645

terminal control address space (TCAS)
 start 895

terminal user
 communication 617

terminal user (*continued*)
 message 617

terminate
 job 174
 MOUNT command 174
 time-sharing user 174
 z/OS UNIX process 174

terminating error
 CPU 58
 multiprocessor 59

TFS (temporary file system)
 stopping TFS running in colony
 address space 579, 905

time
 setting 598

time interval
 IBM-supplied default value
 changing 66

time zone constant 630

time-sharing user
 communication 616
 message 616

TIOT statement in SETALLOC 639

TOD (time-of-day) clock
 setting 8, 598

TPDATA parameter in APPCPMxx 651

TPLEVEL parameter in APPCPMxx 651

trace
 action for a SLIP trap 812
 component 27
 master 27
 SMS trace option 753
 system 27

TRACE command 27, 910
 complete syntax 910
 example 916
 summary table 154

trace table 27

TRACKDIRLOAD option
 display 417
 setting 736

trademarks 989

TRANVSAM parameter
 VARY SMS command 960

TRANVSAM PEERRECOVERY parameter
 VARY SMS command 962

trap
 of system event 803

TSO/E (Time Sharing
 Option/Extension) 22
 controlling 22

TSO/Virtual Telecommunications Access
 Method (TSO/VTAM)
 start 895

TSO/VTAM
 time sharing
 modifying 539

TSO/VTAM (Time Sharing
 Option/Virtual Telecommunications
 Access Method)
 modifying 22

TYPE|T on DISPLAY command 383

U

U command 920

U on DISPLAY command 381

unconditional reserve
 recovery 73

uniprocessor
 RSU parameter
 recommended value 97

UNIT statement in SETALLOC 638

UNITAFF parameter in SETALLOC 638

unlabeled tape 31

unload
 tape or DASD volume 920

UNLOAD command 30, 31, 920
 complete syntax 920
 scope in a sysplex 920
 summary table 154

uppercase character
 use 153

USE attribute 30

user interface
 ISPF 983
 TSO/E 983

USERVAR parameter in APPCPMxx 652

V

V command 921

value compare in SLIP
 definition 845

vary
 console 926
 console offline 119
 devices defined as 3270 model X 119
 devices or a path to devices 939
 global resource serialization
 system 946
 I/O device 941
 I/O path online or offline 948
 secondary console 938
 SMS (DFSMStvs) 959
 SMS (storage group or volume) 951,
 956, 958
 tape device as automatically
 switchable 940

VARY CN command
 description 926

VARY command 33, 921
 complete syntax 976

CONSOLE
 example 140
 example 932, 937, 939, 951, 972, 973

HARDCPY
 example 149, 150

limitations with extended MCS
 console 922

reconfiguration 91

relationship to HARDCOPY statement
 in CONSOLxx 122

scope in a sysplex 922

SMS (storage management
 subsystem) 951, 956, 958

SMS (storage management subsystem)
 Display PDSE monitor state 956

SMS (storage management subsystem)
 Modifying processing of PDSE
 monitor 955

SMS (storage management subsystem)
 PDSE subsystem 955

VARY command (*continued*)
 SMS (storage management subsystem)
 Releasing PDSE latches 955
 SMS (storage management subsystem)
 storage group or volume 954
 SMS placing a system-managed tape
 library online or offline 955
 summary table 154
 SWITCH 969
 VARY CN,AUTOACT= 925

VARY CONSOLE command
 description 932

VARY SMS command
 CICSVR 968
 CICSVR,RCDS 968
 DFSMStvs 959
 LOG parameter 961
 SMVSAM SPHERE parameter 962
 TRANVSAM parameter 960
 TRANVSAM PEERRECOVERY
 parameter 962

VATLSTxx parmlib member 30

VERIFY_UNCAT parameter in
 SETALLOC 645

VERIFY_VOL statement in
 SETALLOC 644

virtual lookaside facility (VLF)
 starting virtual lookaside facility
 (VLF) 897

Virtual Telecommunications Access
 Method (VTAM) 532
 TCAS
 modifying 539

VIRTUAL=REAL (V=R) 24

VLF (virtual lookaside facility)
 defined 897
 modifying 579
 starting 897
 stopping 906
 stopping VLF (virtual lookaside
 facility) 906

VOLSELMSG parameter
 SETSMS command 754

volume
 mounting 30, 589
 varying volume status 957

VOLUME_ENQ statement in
 SETALLOC 639

VOLUME_MNT statement in
 SETALLOC 640

VSERVER|V on DISPLAY
 command 383

W

W command 976

wait state
 not valid 20
 restartable 20, 32

WAITALLOC parameter in
 SETALLOC 639

warning line
 description 104

wildcard
 * (asterisk)
 specified on identifier of system
 command 534

- wildcard (*continued*)
 - using in operator commands 19
- WLM (workload management)
 - DISPLAY XCF command 479
 - switching couple data containing
 - WLM information 779
- WRITELOG command 150, 976
 - complete syntax 976
 - example 976
 - summary table 154
 - to force printing of SYSLOG 150
- WTL (write to log)
 - buffer 224
 - SYSLOG buffer 224
- WTL buffer
 - number allowed
 - changing 224
- WTL macro 150
- WTL SYSLOG buffer
 - number allowed
 - changing 224
 - displaying 224
- WTO (write to operator)
 - buffer
 - shortage 232
 - message
 - level 238
 - routing 238
 - message buffer 225
- WTO (write to operator) buffer 116
- WTO (write-to-operator) buffer
 - shortage 116
- WTO installation exit
 - IEAVMXIT
 - changing 227
 - displaying status 227
- WTO message
 - buffer limit 116
 - controlled by installation exit
 - IEAVMXIT 144
- WTO message buffer
 - number allowed
 - changing 225
 - displaying 225
- WTOR (write to operator with reply)
 - buffer 225
- WTOR (write to operator with reply)
 - buffer
 - shortage 116
- WTOR message
 - buffer limit 116
- WTOR message buffer
 - number allowed
 - changing 225
 - displaying 225

X

- XCF (cross-system coupling facility)
 - switching couple data set containing
 - XCF information 779
- XCF PR/SM policy
 - SETXCF command 788

Z

- Z command 521
- z/OS UNIX System Services
 - dynamically activating
 - maintenance 576
 - switching couple data containing
 - z/OS UNIX System Services
 - information 779
- ZAD 820
- zero address detection 820



Product Number: 5650-ZOS

Printed in USA

SA38-0666-07

